

# WALL TRANSMITTER

## OPERATION AND INSTALLATION INSTRUCTIONS

### IMPORTANT

YOU MUST SET CEILING FAN MANUAL SWITCH TO HIGH SPEED AND THE LIGHT KIT TO THE ON POSITION BEFORE INSTALLING THE REMOTE CONTROL.

### IMPORTANT POINTS TO REMEMBER:

1. Read and save these instructions.
2. Please note that all fixed wiring appliances should be installed by a qualified electrician.
3. The supply to the remote control receiver should be connected through a mains switch, i.e. existing wall switch.
4. Disconnect from power supply at wall switch before working on remote control receiver or ceiling fan.
5. Install receiver into the ceiling fan canopy of the fan to ensure proper protection.
6. This unit is to be used for the control of ceiling fan and in an AC110/120V 60Hz power supply only.
7. The receiver is acceptable for installation in damp and wet rated fans, but cannot be submerged in water. The wall transmitter is only to be installed indoors.
8. Do not pull on or cut leads shorter.
9. Do not drop or bump the unit.
10. PLEASE NOTE: The battery will weaken with age and should be replaced before leaking takes place as this will damage the transmitter. Dispose of used battery properly, keep the battery out of reach of children.
11. CAUTION: To reduce the risk of fire or injury, do not use this product in conjunction with any variable (rheostat) wall control.

### INSTALLATION INSTRUCTIONS

CAUTION: INCORRECT WIRE CONNECTION WILL DAMAGE THIS RECEIVER.

1. Ceiling fan must be set at HIGH speed before installation.
2. Once the connection has been made, the receiver inserts into the drop rod hanging bracket. The canopy comes up to cover the receiver and bracket.

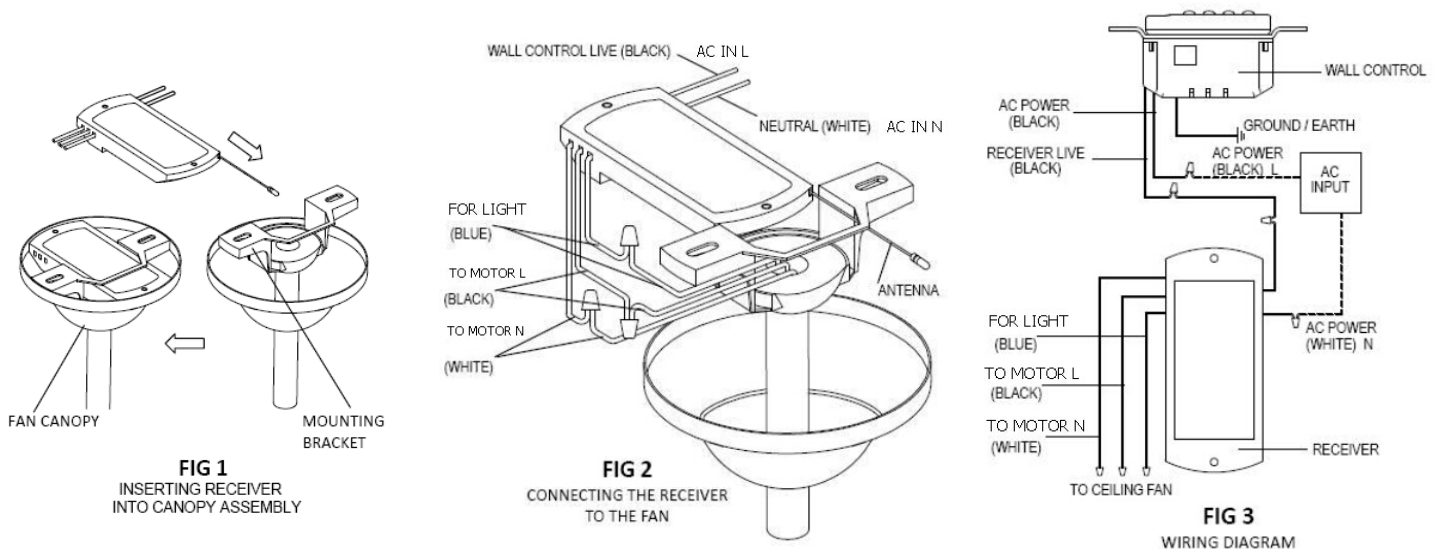

AC POWER ON/OFF SWITCH(  ): Before installing wall control, slide to “OFF” position. After installation is complete, slide to “ON” position to begin operation.

### Installing Wall Control (TRANSMITTER):

Remove wall plate, disconnect and remove the toggle switch from wall junction box. Using the wire connectors, make the electrical connections to the wall control (transmitter) unit. Carefully push all connected wires inside wall switch box. Secure wall control unit with 2 screws previously removed. Face plate will snap onto the transmitter.

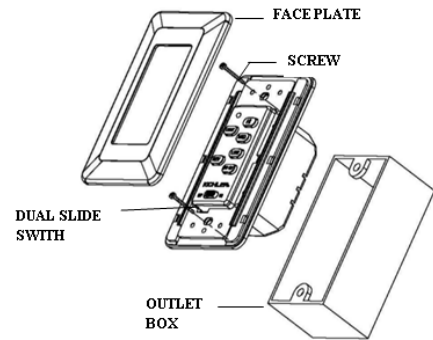

### ACTIVATING THE LEARNING PROCESS

Note: The Wall Transmitter will need to be programmed first before the hand held remote.

1. After installation is complete, AC power is turned on and  SWITCH is at ON position within 30 seconds, press and hold the **LEARN** button for 3 seconds. Fan will turn on at medium speed and light (if installed) will turn on. This confirms that the SMART SYNC setting is active and ok. (FIG. 4)
2. If user cannot finish the setting within the 30 seconds time frame, the main power must be turned off and re-started again. This will reset the unit. Repeat step 1 until the LEARNING feature is activated as indicated.

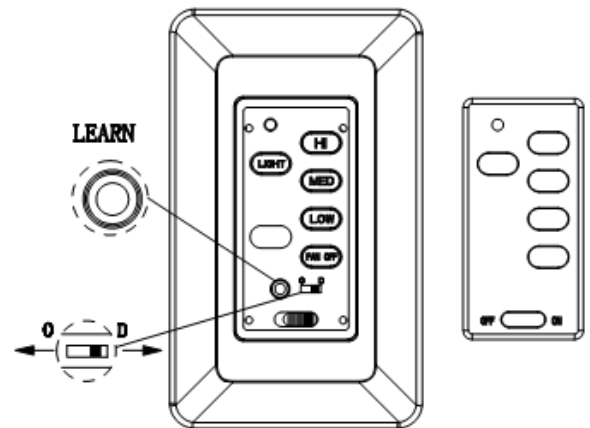

FIG. 4

### LIGHT FUNCTION SELECT SWITCH

1. If the ceiling fan has fluorescent lighting, please slide the “light function select switch” to “O” position. If the ceiling fan has incandescent or halogen lighting, please slide the “light function select switch” to “D” position. (FIG. 4)
2. Light load: 190W (Max.) If overloaded, the receiver will cut off light power automatically. Please change the light load.

### WALL TRANSMITTER OPERATION (FIG. 5)

- FAN OFF :Turn off the ceiling fan.
  - HI : Turn on the fan at high speed.
  - MED : Turn on the fan at medium speed.
  - LOW: Turn on the fan at low speed.
  - LIGHT: ON/OFF-Turn the light on or off.
  - DIMMER-Press and hold to dim or brighten light to the desired level and release.
- (Incandescent or halogen only and light function select switch Or on “D” position.)

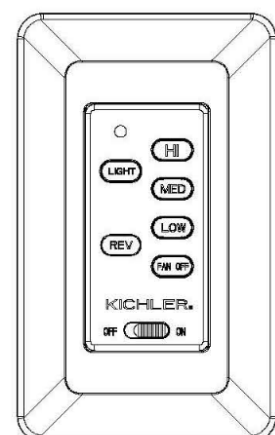

FIG. 5

REV: Press this button for forward/reverse airflow of ceiling fan.

## Installing Wall Bracket ( HANDSET TRANSMITTER):

The wall control can be used together with handset control,

You could install the bracket as the FIG.6 shows.

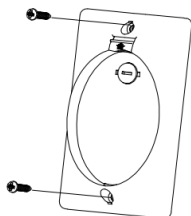

FIG. 6

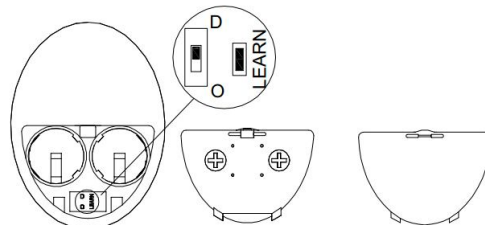

FIG. 7

## HANDSET TRANSMITTER OPERATION (FIG. 7)

Activating the Learning process: Turn on the receiver power, press and hold the LEARN key (on the back of the transmitter) for 1~3S. Refer to FIG. 7

Fan will turn on at medium speed and light (if installed) will turn on. This confirms that the SMART SYNC setting is active and ok.

Transmitter use 2 pcs CR2032 3V batteries.

## LIGHT FUNCTION SELECT SWITCH

If the ceiling fan has fluorescent lighting, please slide the "light function select switch" to "O" position. If the ceiling fan has incandescent or halogen lighting, please slide the "light function select switch" to "D" position. (FIG. 7)

Please note that the setting on wall transmitter and handset transmitter must the same.

 : Turn off the ceiling fan.

 : Press this button for forward/reverse airflow of ceiling fan.

 : Turn on the fan at high speed.

 : Turn on the fan at medium speed.

 : Turn on the fan at low speed.

 : Turn the light off.

 : Turn the light on.

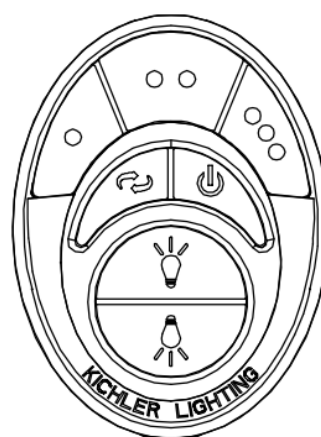

TR250B

DIMMER-Press and hold to dim or brighten light to the desired level and release. (Incandescent or halogen only and light function select switch on "D" position.)

**To assure continued FCC compliance:**

**FEDERAL COMMUNICATIONS COMMISSION INTERFERENCE STATEMENT**

This equipment has been tested and found to comply with the limits for a Class B digital device, pursuant to Part 15 of the FCC Rules. These limits are designed to provide reasonable protection against harmful interference in a residential installation. This equipment generates, uses and can radiate radio frequency energy and, if not installed and used in accordance with the instructions, may cause harmful interference to radio communications. However, there is no guarantee that interference will not occur in a particular installation. If this equipment does cause harmful interference to radio or television reception, which can be determined by turning the equipment off and on, the user is encouraged to try to correct the interference by one or more of the following measures:

--Reorient or relocate the receiving antenna. --Increase the separation between the equipment and receiver.  
--Connect the equipment into an outlet on a circuit different from that to which the receiver is connected. --Consult the dealer or an experienced radio/TV technician for help.

**CAUTION:**

**To assure continued FCC compliance:**

Any changes or modifications not expressly approved by the grantee of this device could void the user's authority to operate the equipment.

**FCC ID : KUJCE10505**

This device complies with Part 15 of the FCC Rules. Operation is subject to the following two conditions: (1) This device may not cause harmful interference, and (2) this device must accept any interference received, including interference that may cause undesired operation.