

Model # JY1126+TR205E (with light function)

DC POWER CEILING FAN REMOTE CONTROL MANUAL

□ INSTALLATION INSTRUCTIONS

NOTE: This unit is to be used for the control of DC power ceiling fan and in an AC120V 60Hz power supply only. Output Power: 40W (Max.) for motor and 190W (Max.) for light.

Important: Using a full range dimmer switch (not included) to control fan speed will damage the fan. To reduce the risk of fire or electrical shock, do not use a full range dimmer switch to control fan speed.

1. Switch power off at fuse box or circuit breaker before you begin installing the fan.
2. Make wiring connections as indicated Fig. 1.
3. Launch distance for remote control: about 10m.
4. Open the remote battery cover and install DC3V, CR2032, 2pcs Lithium batteries. (Fig. 2)
5. CODE SWITCH: Codes are set by pushing dip switches up or down. It is imperative that the code used for both transmitter and receiver is exactly the same; otherwise remote controller will not work. Please note the code switch will enable you to operate a second remote controller independently. For example, if you have two ceiling fans with 2 remote control units, set 2 different codes for each set of transmitter/receivers. This means you can operate each ceiling fan independently. Your remote control is ready for use after battery installation.

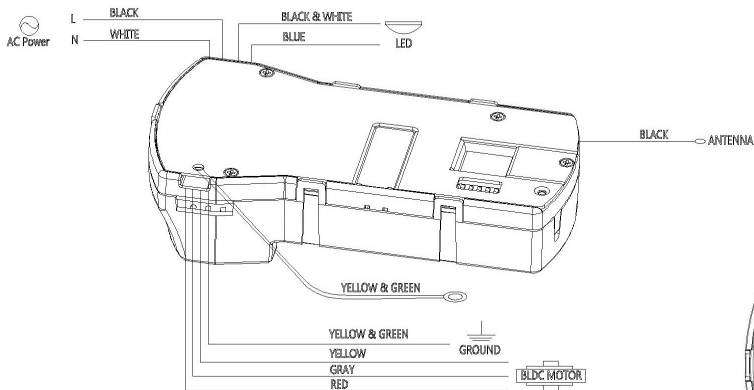

Fig. 1

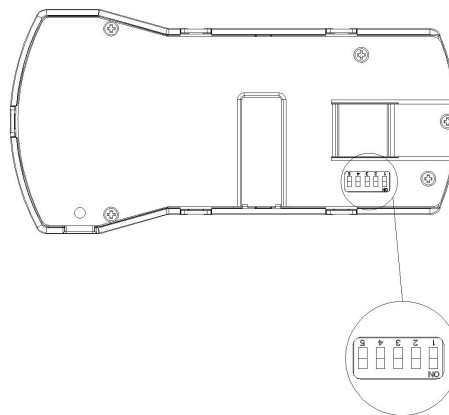

Fig. 3

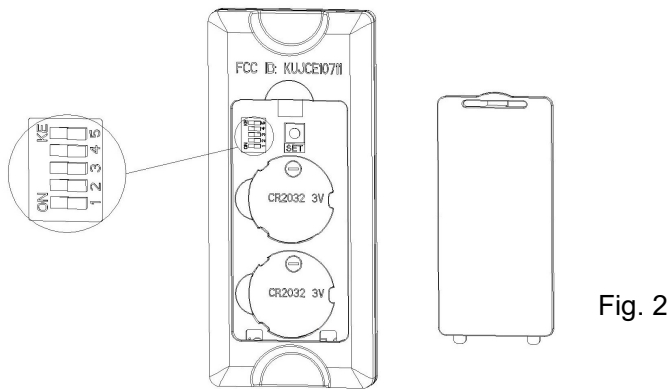





Fig. 2

□ FUNCTIONS OF REMOTE CONTROL: (Fig. 4)

 Indicator LED light: fan speed or light dimmer indicator

 button: Tap once turn off the fan. Press and hold this button for 5 seconds to turn on or turn off the buzzer.

Fan speed:

 Turn on the fan and turn speed up.

 Turn on the fan and turn speed down.

 Light button: Turn on or off the light.

 Increase light output level.

 Decrease light output level.

(Tungsten only and light function select switch on dimmer position.)

Sleep Timer:





Fig. 4

TR205E

 : The fan and light will turn off after 1 hour automatically.

 : The fan and light will turn off after 3 hours automatically.

 : The fan and light will turn off after 6 hours automatically.

 : Tap this button, the light will blink twice that mean the function setting completed, the fan will turn off and the light will randomly turn on and off while you are away, press any buttons cancel the function.

 Natural breeze: Fan speed will modulate to simulate a natural breeze.

 : Tap once, the light will blink once that mean the function setting completed and fan and light will turn off after 1 minute automatically. Press any buttons cancel the function.

 Reverse button:

 Summer: The fan runs counterclockwise. Airflow will provide a downward cooling breeze.

 Winter: The fan runs clockwise. Airflow will force warm air downward without a noticeable breeze.

This unit finished learning process inside manufactory, if replace transmitter or receiver, user need to redo learning process before using this unit”.

INSTALLING WALL PLATE

Attach wall plate using the two provided screws. (Fig. 5)

LEARNING PROCESS

1. This unit finished learning process inside manufactory, if replace receiver, user need to redo learning process before using this unit.
2. Install the battery 3V in transmitter.
3. After installing the unit and power on and press learn key 1~3seconds, lights will be flashing twice and turn off, which indicate that learning process finished. Learning effect distance is same with remote's.
Please note that must press the “” within 30seconds after power on.

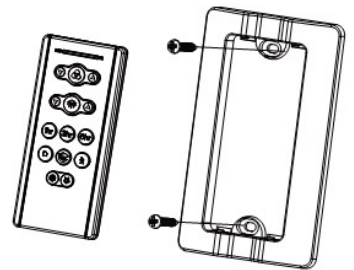

Fig. 5

Please note that the transmitter can learn in multiple receiver, when doing learning process please make sure not learn in other receiver. Suggest to separate power switches of fans in 2 meter range.

To assure continued FCC compliance:

FEDERAL COMMUNICATIONS COMMISSION INTERFERENCE STATEMENT

This equipment has been tested and found to comply with the limits for a Class B digital device, pursuant to Part 15 of the FCC Rules. These limits are designed to provide reasonable protection against harmful interference in a residential installation. This equipment generates uses and can radiate radio frequency energy and, if not installed and used in accordance with the instructions, may cause harmful interference to radio communications. However, there is no guarantee that interference will not occur in a particular installation. If this equipment does cause harmful interference to radio or television reception, which can be determined by turning the equipment off and on, the user is encouraged to try to correct the interference by one or more of the following measures:

- Reorient or relocate the receiving antenna.
- Increase the separation between the equipment and receiver.
- Connect the equipment into an outlet on a circuit different from that to which the receiver is connected.
- Consult the dealer or an experienced radio/TV technician for help.

CAUTION:

Any changes or modifications not expressly approved by the grantee of this device could void the user's authority to operate the equipment.

FCC ID: KUJCE10711

This device complies with Part 15 of the FCC Rules. Operation is subject to the following two conditions: (1) This device may not cause harmful interference, and (2) this device must accept any interference received, including interference that may cause undesired operation.