

CipherLab User Guide

1564A Barcode Scanner

Setup barcodes included.

Version 1.08



Copyright © 2011~2014 CIPHERLAB CO., LTD.
All rights reserved

The software contains proprietary information of CIPHERLAB CO., LTD.; it is provided under a license agreement containing restrictions on use and disclosure and is also protected by copyright law. Reverse engineering of the software is prohibited.

Due to continued product development this information may change without notice. The information and intellectual property contained herein is confidential between CIPHERLAB and the client and remains the exclusive property of CIPHERLAB CO., LTD. If you find any problems in the documentation, please report them to us in writing. CIPHERLAB does not warrant that this document is error-free.

No part of this publication may be reproduced, stored in a retrieval system, or transmitted in any form or by any means, electronic, mechanical, photocopying, recording or otherwise without the prior written permission of CIPHERLAB CO., LTD.

For product consultancy and technical support, please contact your local sales representative. Also, you may visit our web site for more information.

The CipherLab logo is a registered trademark of CIPHERLAB CO., LTD.

All brand, product and service, and trademark names are the property of their registered owners.

The editorial use of these names is for identification as well as to the benefit of the owners, with no intention of infringement.

CIPHERLAB CO., LTD.

Website: <http://www.cipherlab.com>

IMPORTANT NOTICES

FOR USA

This equipment has been tested and found to comply with the limits for a **Class B** digital device, pursuant to Part 15 of the FCC Rules. These limits are designed to provide reasonable protection against harmful interference in a residential installation. This equipment generates, uses and can radiate radio frequency energy and, if not installed and used in accordance with the instructions, may cause harmful interference to radio communications. However, there is no guarantee that interference will not occur in a particular installation. If this equipment does cause harmful interference to radio or television reception, which can be determined by turning the equipment off and on, the user is encouraged to try to correct the interference by one or more of the following measures:

- ▶ Reorient or relocate the receiving antenna.
- ▶ Increase the separation between the equipment and receiver.
- ▶ Connect the equipment into an outlet on a circuit different from that to which the receiver is connected.
- ▶ Consult the dealer or an experienced radio/TV technician for help.

This device complies with FCC radiation exposure limits set forth for an uncontrolled environment. This device complies with Part 15 of the FCC Rules. Operation is subject to the following two conditions: (1) This device may not cause harmful interference, and (2) this device must accept any interference received, including interference that may cause undesired operation.

Any changes or modifications not expressly approved by the party responsible for compliance could void the user's authority to operate the equipment.

FOR CANADA

This device complies with Industry Canada licence-exempt RSS standard(s). Operation is subject to the following two conditions: (1) this device may not cause interference, and (2) this device must accept any interference, including interference that may cause undesired operation of the device.

Le présent appareil est conforme aux CNR d'Industrie Canada applicables aux appareils radio exempts de licence. L'exploitation est autorisée aux deux conditions suivantes : (1) l'appareil ne doit pas produire de brouillage, et (2) l'utilisateur de l'appareil doit accepter tout brouillage radioélectrique subi, même si le brouillage est susceptible d'en compromettre le fonctionnement.

The device meets the exemption from the routine evaluation limits in section 2.5 of RSS 102 and compliance with RSS-102 RF exposure, users can obtain Canadian information on RF exposure and compliance.

Le dispositif rencontre l'exemption des limites courantes d'évaluation dans la section 2.5 de RSS 102 et la conformité à l'exposition de RSS-102 rf, utilisateurs peut obtenir l'information canadienne sur l'exposition et la conformité de rf.

FOR HAND-HELD PRODUCT WITH RF FUNCTIONS

The 1564A unit (FCC ID: Q3N-1564A) complies with FCC radiation exposure limits set forth for uncontrolled environment and meets the FCC radio frequency (RF) Exposure Guidelines in Supplement C to OET65. The unit has very low level of RF energy that it is deemed to comply without testing of specific absorption ratio (SAR).

The 3656 unit (FCC ID: Q3N-3656) complies with FCC radiation exposure limits set forth for an uncontrolled environment. This equipment should be installed and operated with minimum distance 20 cm between the radiator & your body. It only operated in hand-held used. If you only transfer data to the host wirelessly, please keep the minimum distance 20 cm between machine & your body.

FOR PRODUCT WITH LASER

CAUTION



This laser component emits FDA / IEC Class 2 laser light at the exit port. Do not stare into beam.

SAFETY PRECAUTIONS

RISK OF EXPLOSION IF BATTERY IS REPLACED BY AN INCORRECT TYPE. DISPOSE OF USED BATTERIES ACCORDING TO THE INSTRUCTIONS.

- ▶ The use of any batteries or charging devices, which are not originally sold or manufactured by CipherLab, will void your warranty and may cause damage to human body or the product itself.
- ▶ DO NOT disassemble, incinerate or short circuit the battery.
- ▶ DO NOT expose the scanner or the battery to any flammable sources.
- ▶ For green-environment issue, it's important that batteries should be recycled in a proper way.
- ▶ Under no circumstances, internal components are self-serviceable.
- ▶ The charging device uses an AC power adaptor. A socket outlet shall be installed near the equipment and shall be easily accessible. Make sure there is stable power supply for the scanner or its peripherals to operate properly.

CARE & MAINTENANCE

- ▶ Use a clean cloth to wipe dust off the scanning window and the body of the scanner as well as the charging device. DO NOT use/mix any bleach or cleaner.
- ▶ If you want to put away the scanner for a period of time, download the collected data to a host computer when in the memory mode, and then take out the battery. Store the scanner and battery separately.
- ▶ When the scanner resumes its work, make sure the battery is fully charged before use.
- ▶ If you shall find the scanner malfunctioning, write down the specific scenario and consult your local sales representative.

RELEASE NOTES

Version	Date	Notes
---------	------	-------

- | | | |
|------|---------------|--|
| 1.08 | Jun. 18, 2014 | <ul style="list-style-type: none"> ▶ New: 1.15 – Illumination Brightness setup barcode added ▶ New: 1.16 – Serial Number Stamp setup barcode added ▶ New: 1.16.1 – separator between S/N and data ▶ New: 2.1.11 – BT HID Slave/Master Switching ▶ New: 2.1.12 – BT HID Auto-Reconnection ▶ New: 3.2.2 – changing device name barcode added ▶ New: 4.11.3 – GS1 Formatting, Application ID Mark ▶ Modified: 4.13.2 – add GS1 formatting (Omnidirectional) barcodes ▶ Modified: 4.13.3 – add GS1 formatting (Expanded) barcodes ▶ Modified: 4.13.4 – add GS1 formatting (Limited) barcodes ▶ New: 4.13.6 – Field Separator ▶ New: 4.13.7 – Application ID Mark ▶ New: 4.15.1 – Transmit Check Digit for EAN-8 ▶ New: 4.16.3 – Transmit Check Digit for EAN-13 ▶ Modified: 4.21.1 – add GS1 formatting (Composite CC-A/B) barcodes ▶ Modified: 4.21.2 – add GS1 formatting (Composite CC-C) barcodes ▶ New: 4.21.6 – Field Separator ▶ New: 4.21.7 – Application ID Mark ▶ Modified: Appendix II – #@BEEP,xx, #@RLED,xx, #@GLED,xx commands added |
| 1.07 | Mar. 04, 2013 | <ul style="list-style-type: none"> ▶ New: Quick Start – Create 2D One-Scan Barcode ▶ New: 1.14 Mobile Phone/Display Mode ▶ New: 2.1.9 BT HID – Transmit Speed setup barcodes ▶ New: 2.1.10 Simple Pairing for iPhone/iPad ▶ New: 2.3.1 Activate Bluetooth SPP Master Mode – 2D barcode for connecting to a target device added ▶ New: 3.1.1 Connect to 3656 – 2D barcode for connecting to 3656 added ▶ New: 3.2.2 Configure Related Settings – SSP setup barcodes ▶ New: 5.8 AIM Code ID |
| 1.06 | Jan. 02, 2013 | <ul style="list-style-type: none"> ▶ Modified: Symbologies Supported – Code 128 - GS1-128 (EAN-128): default value to Enabled ▶ New: 1.6.7 Presentation Mode – Low Light Enhancement setup barcodes ▶ Modified: 2.1.7/2.4.5/2.6.6 Special Keyboard Feature description ▶ Modified: 4.11 GS1-128 - default value to Enable ▶ Modified: Appendix II - #@RDSN command added |
| 1.05 | Jun. 19, 2012 | <ul style="list-style-type: none"> ▶ New: 4.18.1 UPC-A Convert to EAN-13 ▶ New: 1.2.3 Free Memory ▶ New: 2.1.1/2.4.1/2.6.1 PCAT (Swiss German) and PCAT (Danish) ▶ New: 2.1.7/2.4.5/2.6.6 Special Keyboard Feature ▶ New: Appendix V Family Name/First Name/ Middle Name Truncation and Check the File Type of ANSI |

1.04	Apr. 12, 2012	<ul style="list-style-type: none"> ▶ New: Quick Start Read a Setup Barcode List Current Settings - "List Page 22" added to deliver settings of Driver License parsing ▶ New: Appendix V: Reading Driver Licenses
1.03	Aug. 31, 2011	<ul style="list-style-type: none"> ▶ Deleted: "Continuous Mode" and "Alternate Mode" are removed from the manual. The original sections 1.6.1 "Continuous Mode" and 1.6.6 "Alternate Mode" are deleted. ▶ New: "Picklist Mode" is added for section 1.13. ▶ New: "Auto Power Off Ignoring Scan Mode" is added. Sections involved are: <ul style="list-style-type: none"> ▶ Renamed section 1.1.1 "Turn on/off the Scanner" ▶ Modified section: 1.1.2 "Power Economy". ▶ Adjusted new section: 1.1.3 "Power Economy vs. WPAN Connection" ▶ New: Kanji Transmission is added for the output interfaces of Bluetooth HID, Keyboard Wedge via 3656 and USB HID via 3656 under sections 2.1, 2.1.3, 2.4, 2.4.2, 2.6, 2.6.2.
1.02	Jul. 13, 2011	<ul style="list-style-type: none"> ▶ Modified: Introduction, Product Highlights — note
1.01	Jun. 17, 2011	<ul style="list-style-type: none"> ▶ Modified: 3656+USB+Adaptor issue ▶ Modified: 1.8 Delay between Re-read — add Presentation mode ▶ Modified: 2.1 BT HID — add Inter-Character Delay ▶ Modified: 2.1.1 Activate BT HID & Select Keyboard Type — add #77 PCAT (Hungarian) ▶ Modified: 2.4.1 Activate Keyboard Wedge & Select Keyboard Type — add #31 PCAT (Hungarian) ▶ Modified: 2.6 USB HID via 3656 — add Inter-Character Delay ▶ Modified: 2.6.1 Activate USB HID & Select Keyboard Type — add #77 PCAT (Hungarian)
1.00	Mar. 01, 2011	Initial release

CONTENTS

- IMPORTANT NOTICES** - 2 -
 - For USA - 3 -
 - For Canada - 3 -
 - For Hand-held Product with RF Functions - 4 -
 - For Product with Laser - 4 -
 - Safety Precautions - 4 -
 - Care & Maintenance - 4 -
- RELEASE NOTES** - 5 -
- INTRODUCTION** 1
 - Getting Familiarized with 1564A and 3656 2
 - Installing the Battery to 1564A 2
 - Setting up 3656 3
 - Charging the Battery via 3656 5
 - Charging the Battery via Charger 6
 - Inside the Package 7
 - Product Highlights 7
 - Symbologies Supported 8
- QUICK START** 11
 - Enter Configuration Mode 13
 - Exit Configuration Mode 13
 - Default Settings 14
 - Save User Settings as Defaults 14
 - Restore User Defaults 14
 - Restore System Defaults 14
 - Read a Setup Barcode 15
 - Configure Parameters 15
 - List the Current Settings 19
 - Create One-Scan Setup Barcodes 21
 - 1D One-Scan Barcode 21
 - 2D One-Scan Barcode 22
- UNDERSTANDING THE BARCODE SCANNER** 23
 - 1.1 Battery 23
 - 1.1.1 Turn on/off the Scanner 23
 - 1.1.2 Power Economy 24
 - 1.1.3 Power Economy vs. WPAN Connection 26
 - 1.2 Memory 28
 - 1.2.1 Transmit Buffer 28
 - 1.2.2 Memory Mode 29
 - 1.2.3 Free Memory 30

1.3 LED Indicator	31
1.3.1 Good Read LED	32
1.3.2 Good Read LED Duration	32
1.4 Beeper	33
1.4.1 Beeper Volume	34
1.4.2 Good Read Beep	35
1.4.3 Low Battery Alarm	36
1.5 Send "NR" to Host	37
1.6 Scan Modes	38
1.6.1 Test Mode	39
1.6.2 Laser Mode	39
1.6.3 Auto Off Mode	39
1.6.4 Auto Power Off Mode	40
1.6.5 Aiming Mode	41
1.6.6 Multi-Barcode Mode	41
1.6.7 Presentation Mode	42
1.7 Scanning Timeout	43
1.8 Delay between Re-read	44
1.9 Read Redundancy (1D)	45
1.10 Addon Security for UPC/EAN Barcodes	46
1.11 Auto-Sense Mode	47
1.12 Negative Barcodes	48
1.13 Picklist Mode	49
1.14 Mobile Phone/Display Mode	50
1.15 Illumination Brightness	50
1.16 Serial Number Stamp	51
1.16.1 Separator between Serial Number Stamp and Data	51
SELECTING OUTPUT INTERFACE	53
2.1 BT HID	54
2.1.1 Activate BT HID & Select Keyboard Type	55
2.1.2 Reset Connection	56
2.1.3 Keyboard Settings	57
2.1.4 Inter-Character Delay	63
2.1.5 Inter-Function Delay	63
2.1.6 HID Character Transmit Mode	64
2.1.7 Special Keyboard Feature	64
2.1.8 Keypad Support for iPhone/iPad	64
2.1.9 Transmit Speed	65
2.1.10 Simple Pairing for iPhone/iPad	65
2.1.11 BT HID Slave/Master Switching	65
2.1.12 BT HID Auto-Reconnection	66
2.2 BT SPP Slave	66
2.2.1 Activate BT SPP Slave Mode	66
2.2.2 Inter-Function Delay	66
2.2.3 ACK/NAK Timeout	67
2.3 BT SPP Master	68

2.3.1 Activate BT SPP Master Mode	68
2.3.2 Inter-Function Delay.....	70
2.3.3 ACK/NAK Timeout	71
2.3.4 Switch between Master/Slave Mode	71
2.4 Keyboard Wedge via 3656	72
2.4.1 Activate Keyboard Wedge & Select Keyboard Type	73
2.4.2 Keyboard Settings.....	74
2.4.3 Inter-Character Delay	81
2.4.4 Inter-Function Delay.....	82
2.4.5 Special Keyboard Feature	82
2.5 RS-232 via 3656	83
2.5.1 Activate RS-232 Interface	83
2.5.2 Baud Rate	83
2.5.3 Data Bits.....	84
2.5.4 Parity	84
2.5.5 Stop Bit	85
2.5.6 Flow Control	85
2.5.7 Inter-Character Delay	86
2.5.8 Inter-Function Delay.....	86
2.5.9 ACK/NAK Timeout	87
2.6 USB HID via 3656	88
2.6.1 Activate USB HID & Select Keyboard Type.....	89
2.6.2 Keyboard Settings.....	90
2.6.3 Inter-Character Delay	96
2.6.4 Inter-Function Delay.....	96
2.6.5 HID Character Transmit Mode.....	97
2.6.6 Special Keyboard Feature	97
2.7 USB Virtual COM via 3656.....	98
2.7.1 Activate USB Virtual COM.....	98
2.7.2 Inter-Function Delay.....	98
2.7.3 ACK/NAK Timeout	99
SETTING UP A WPAN CONNECTION	101
3.1 Connecting via 3656	102
3.1.1 Connect to 3656.....	102
3.1.2 Change Interface.....	104
3.2 Connecting via <i>Bluetooth</i> [®] Dongle	105
3.2.1 Change Interface.....	105
3.2.2 Configure Related Settings	106
3.2.3 Connect to Dongle	110
CHANGING SYMBOLOGY SETTINGS	119
4.1 Codabar.....	120
4.1.1 Start/Stop Transmission	120
4.1.2 CLSI Conversion	120
4.1.3 Code Length Qualification.....	121
4.2 Code 25 - Industrial 25	122
4.2.1 Code Length Qualification.....	123
4.3 Code 25 - Interleaved 25.....	124
4.3.1 Verify Check Digit.....	124

4.3.2 Transmit Check Digit	124
4.3.3 Convert to EAN-13	125
4.3.4 Code Length Qualification	126
4.4 Code 25 - Matrix 25	127
4.4.1 Verify Check Digit	127
4.4.2 Transmit Check Digit	127
4.4.3 Code Length Qualification	128
4.5 Code 25 - Chinese 25	129
4.6 Italian Pharmacode (Code 32)	130
4.7 Code 39	131
4.7.1 Verify Check Digit	131
4.7.2 Transmit Check Digit	131
4.7.3 Standard/Full ASCII Code 39	132
4.7.4 Code Length Qualification	133
4.8 Trioptic Code 39	134
4.9 Code 93	135
4.9.1 Code Length Qualification	136
4.10 Code 128	137
4.11 GS1-128 (EAN-128)	138
4.11.1 Transmit Code ID	138
4.11.2 Field Separator (GS Character)	138
4.11.3 GS1 Formatting	139
4.12 ISBT 128	140
4.12.1 ISBT Concatenation	140
4.12.2 ISBT Concatenation Redundancy	141
4.13 GS1 DataBar (RSS Family)	142
4.13.1 Select Code ID	142
4.13.2 GS1 DataBar Omnidirectional (RSS-14)	143
4.13.3 GS1 DataBar Expanded (RSS Expanded)	144
4.13.4 GS1 DataBar Limited (RSS Limited)	145
4.13.5 Convert to UPC/EAN	146
4.13.6 Field Separator (GS Character)	146
4.13.7 Application ID Mark	147
4.14 MSI	148
4.14.1 Verify Check Digit	148
4.14.2 Transmit Check Digit	148
4.14.3 Code Length Qualification	149
4.15 EAN-8	150
4.15.1 Transmit Check Digit	150
4.16 EAN-13	151
4.16.1 Convert to ISBN	152
4.16.2 Convert to ISSN	152
4.16.3 Transmit Check Digit	152
4.17 UCC Coupon Extended Code	153
4.18 UPC-A	154
4.18.1 Convert to EAN-13	155
4.18.2 Transmit System Number	155

4.18.3 Transmit Check Digit	155
4.19 UPC-E	156
4.19.1 Select System Number	157
4.19.2 Convert to UPC-A	157
4.19.3 Transmit System Number	158
4.19.4 Transmit Check Digit	158
4.20 Code 11	159
4.20.1 Verify Check Digit	159
4.20.2 Transmit Check Digit	159
4.20.3 Code Length Qualification	160
4.21 Composite Code	161
4.21.1 Composite CC-A/B	161
4.21.2 Composite CC-C	161
4.21.3 Composite TLC-39	162
4.21.4 UPC Composite Mode	162
4.21.5 GS1-128 Emulation Mode for UCC/EAN Composite Codes	163
4.21.6 Field Separator (GS Character)	163
4.21.7 Application ID Mark	164
4.22 US Postal Code	165
4.22.1 US Postnet	165
4.22.2 US Planet	165
4.22.3 Transmit Check Digit	165
4.23 UK Postal Code	166
4.23.1 UK Postal	166
4.23.2 Transmit Check Digit	166
4.24 More Postal Code	167
4.24.1 Japan Postal	167
4.24.2 Australian Postal	167
4.24.3 Dutch Postal	167
4.24.4 USPS 4CB/One Code/Intelligent Mail	167
4.24.5 UPU FICS Postal	168
4.25 2D Symbolologies	169
4.25.1 PDF417	169
4.25.2 MicroPDF417	169
4.25.3 Data Matrix	170
4.25.4 Maxicode	171
4.25.5 QR Code	171
4.25.6 MicroQR	171
4.25.7 Aztec	171
4.26 Macro PDF	172
4.26.1 Transmit/Decode Mode	172
4.26.2 Escape Characters	173
4.26.3 Transmit Control Header	173
DEFINING OUTPUT FORMAT	175
5.1 Letter Case	175
5.2 Character Substitution	176
5.2.1 Select a Set for Character Substitution	177
5.2.2 Symbolologies for Character Substitution (All 3 Sets)	178

5.3 Prefix/Suffix Code	188
5.4 Code ID	189
5.4.1 Select Pre-defined Code ID	189
5.4.2 Change Code ID	192
5.4.3 Clear Code ID Settings	195
5.5 Length Code	196
5.6 Multi-Barcode Editor	204
5.6.1 Edit a Concatenation of Barcodes	205
5.6.2 Activate the Concatenation of Barcodes	206
5.7 Removal of Special Character	207
5.8 AIM Code ID	208
APPLYING FORMATS FOR DATA EDITING	209
6.1 Activating Editing Formats	210
6.1.1 Activate Editing Formats	210
6.1.2 Exclusive Data Editing	211
6.2 How to Configure Editing Formats	212
6.2.1 Select Format to Configure	213
6.2.2 Restore Default Format	214
6.3 Configuring Format – Define Data Criteria	215
6.3.1 Applicable Code Type	215
6.3.2 Data Length	225
6.3.3 Matching String & Location	226
6.4 Configuring Format – Define Data Field	227
6.4.1 Start Position	227
6.4.2 Field Adjustment	227
6.4.3 Total Number of Fields	228
6.4.4 Field Settings	229
6.4.5 Pause Field Setting	235
6.5 Configuring Format – Define Transmission Sequence	236
6.6 Programming Examples	238
6.6.1 Example I	238
6.6.2 Example II	239
SPECIFICATIONS	241
FIRMWARE UPGRADE	245
How to Upgrade 1564A Firmware	245
Using 3656	245
Using <i>Bluetooth</i> [®] Dongle	248
How to Upgrade 3656 Firmware	250
Upgrading 3656 CPU Firmware	250
Upgrading 3656 USB Bridge Firmware	252
HOST SERIAL COMMANDS	255
1564A Serial Commands	255
Example	257
3656 Setup Barcodes & Serial Commands	259

3656 Serial Command and Equivalent Setup Barcodes	260
Example	262
KEYBOARD WEDGE TABLE	263
Key Type & Status	265
Key Type.....	265
Key Status	265
Example	266
NUMERAL SYSTEMS.....	267
Decimal System	267
Hexadecimal System	268
ASCII Table.....	269
Entering PIN Code for Authentication	270
Use Preset PIN	270
Disable Authentication or Use Random PIN	271
READING DRIVER LICENSES	273
License Parsing Setup	273
File Type.....	273
Output Sequence Setup.....	274
Separators and Fields	280
Edit Separators	281
Edit Fields	282

INTRODUCTION

CipherLab's 1560 Series Barcode Scanners are specifically designed to answer your mobile demands. The versatile scanners are designed to help accelerate productivity while lowering the total cost of ownership. Intensive data collection jobs are made easier with fast, accurate barcode scanning in various working environments, especially in small businesses. Integrating short-distance wireless technology to small-form-factor scanners, the 1560 Series Barcode Scanners are ideal for carrying around, and thus give workers tether-free mobility anytime anywhere and get job done more efficiently. This line of scanners deliver data over a wireless personal network at a range of up to 90 meters and a prolonged battery life to keep business running. A new ordering option is provided for adapting a 2D scan engine to read both 1D and 2D barcodes.

Owing to the slim, ergonomic design, extremely low power consumption, and powerful decoding capability, the 1560 Series Barcode Scanners are the best choice for the following applications –

- ▶ Receiving in Retail
- ▶ Product labeling & Tracking
- ▶ Shelf Product Replenishment
- ▶ Mobile Point of Sale (POS)
- ▶ Mobile Inventory Management
- ▶ Order Picking & Staging
- ▶ Work-In-Process Tracking
- ▶ Material Flow Control
- ▶ Transportation & Distribution
- ▶ Warehousing
- ▶ Asset Management

This manual contains information on operating the scanner and using its features. We recommend that you keep one copy of the manual at hand for quick reference or maintenance purposes. To avoid any improper disposal or operation, please read the manual thoroughly before use.

Thank you for choosing CipherLab products!



GETTING FAMILIARIZED WITH 1564A AND 3656

INSTALLING THE BATTERY TO 1564A

When you first receive the package, the rechargeable battery is stored separately from the scanner. Insert the battery into the scanner first so that it can be charged when sitting in the 3656 stand.

Note: Any improper handling may reduce the battery life.

- 1) Hold the scanner still and insert the battery into the battery compartment at the bottom of the scanner.
- 2) Slide the battery latch to lock the battery in the compartment.
- 3) Hold down the trigger about 2 seconds to turn on the scanner.
- 4) The scanner will respond with a long beep and its LED will come on-off shortly.

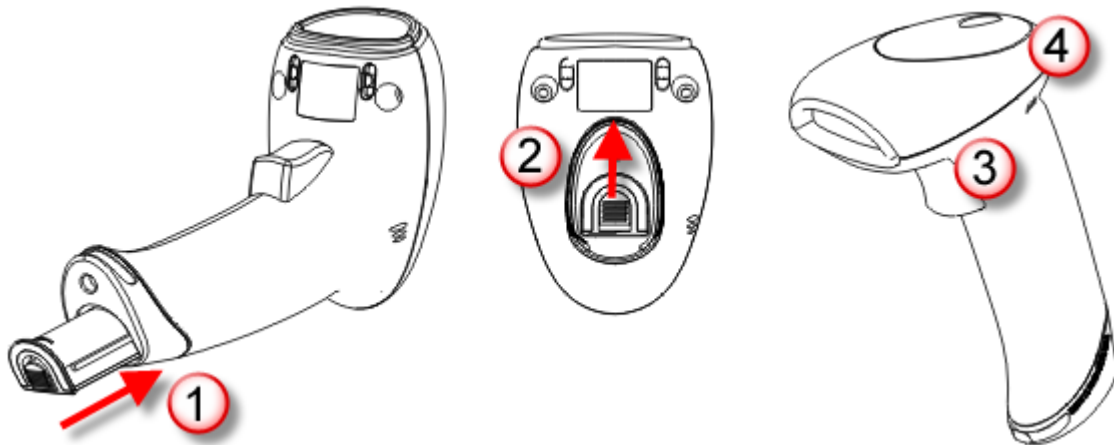

Note: (1) To turn off the scanner, remove the battery. Refer to settings of "Auto Power Off".

(2) For shipping and storage purposes, save the scanner and the battery separately. This will keep the battery in good condition for future use.

(3) When the battery charge becomes low, you will find the scanner cannot emit scan beam and its power-on beep sounds differently.



SETTING UP 3656

Capable of charging 1564A, the 3656 stand is specifically designed for the scanner to communicate with a host computer wirelessly. The connection between the scanners and 3656 is made easy and reliable. Refer to [3.1.1 Connect to 3656](#).

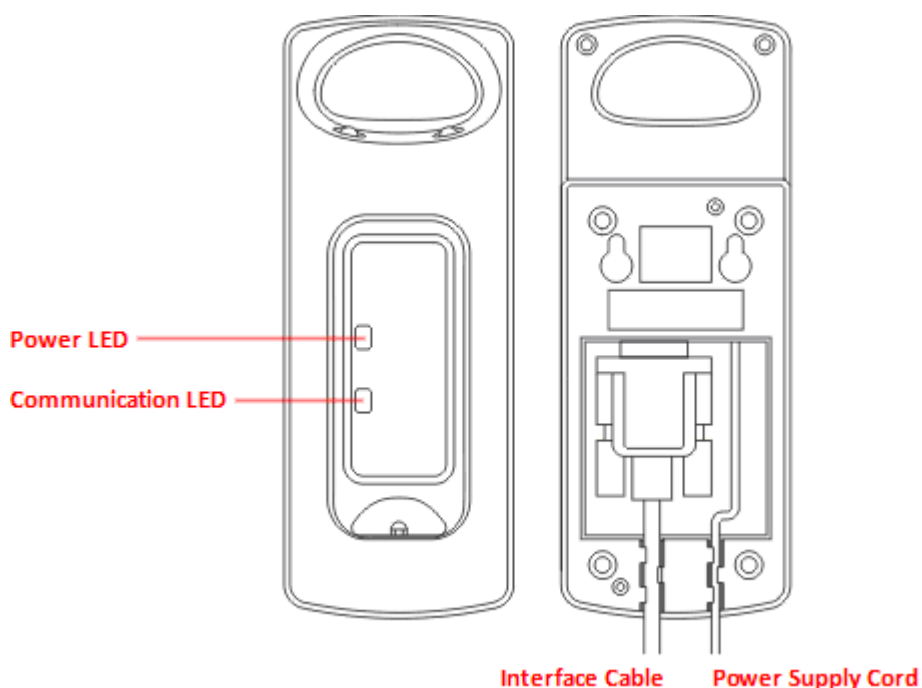

Two LED indicators are provided for power and communications status.

Power LED		Meaning
Red, solid	---	Power ON
---	---	Power OFF
Communication LED		Meaning
---	Blue, solid	Initialize
Red, solid	---	Failed to establish a USB connection
Red, solid	Blue, flashing	Serial command mode with USB Virtual COM or RS-232: wait 3 seconds for starting a serial command
Red, flashing	Blue, flashing	Serial command mode with USB HID: wait 3 seconds for pressing [Num Lock] or [Caps Lock] 5 times via keyboard
---	Blue, flashing	Wait for connection request from the scanner (Slow flash at 0.5 Hz)



---	Blue, flashing	Connected with the scanner (Fast flash at 1 Hz)
Red, solid	Blue, flashing	Failed to send data to host via USB Virtual COM (Fast flash at 1 Hz)
Red, flashing	---	Enter Download Mode



CHARGING THE BATTERY VIA 3656

The battery may not be charged to full for shipment. When you first receive the package, you will need to charge the battery to full before using the scanner. When using the RS-232 cable, it takes approximately 5 hours to charge the battery to full (from the power adaptor).

Note: Battery charging stops when the temperature drops below 0°C or exceeds 40°C. It is recommended to charge the battery at room temperature (18°C to 25°C) for optimal performance.

- 1) Install the battery to the scanner.
- 2) Seat the scanner in the 3656 stand.
- 3) Connect the 3656 stand to your computer or notebook via the USB or RS-232 cable.
- 4) Connect the power supply cord from 3656 to a proper power outlet.

Warning: RS-232/USB interface both require connecting the power supply cord. When the stand is solely on USB power, the current may be insufficient for it to function normally. You must connect the power supply cord.

- 5) The LED for power indication on 3656 will become solid red.
- 6) The scanner LED will be flashing red during charging.
 - ▶ When the charging is done, the LED will turn off.
 - ▶ When charging error occurs, the LED will turn solid red.
- 7) The LED for communications on 3656 will first become solid blue while initializing. Refer to the table above for details on different stage of communications.

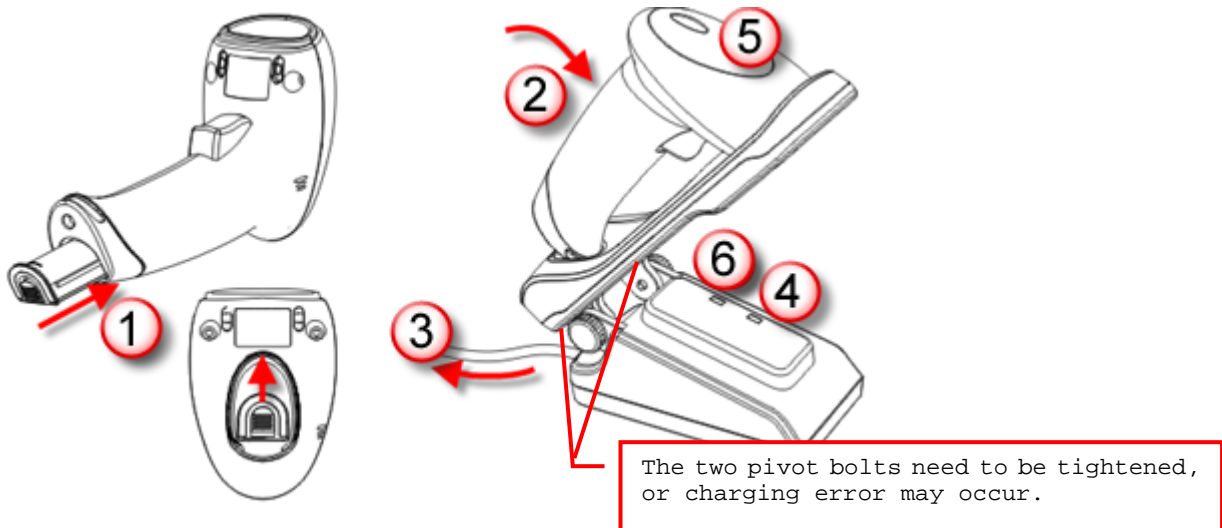

Warning: If the two pivot bolts are not tightened properly, charging error may occur.



CHARGING THE BATTERY VIA CHARGER

The battery charger is provided for charging the battery only. You may purchase the charger separately. It takes approximately 3 hours to charge the battery to full.

Note: Battery charging stops when the temperature drops below 0°C or exceeds 40°C. It is recommended to charge the battery at room temperature (18°C to 25°C) for optimal performance.

- 1) Insert the battery.
- 2) Lock the battery.
- 3) Connect the power supply cord to the charger.
- 4) Connect the other end of the power cord to a suitable power outlet.

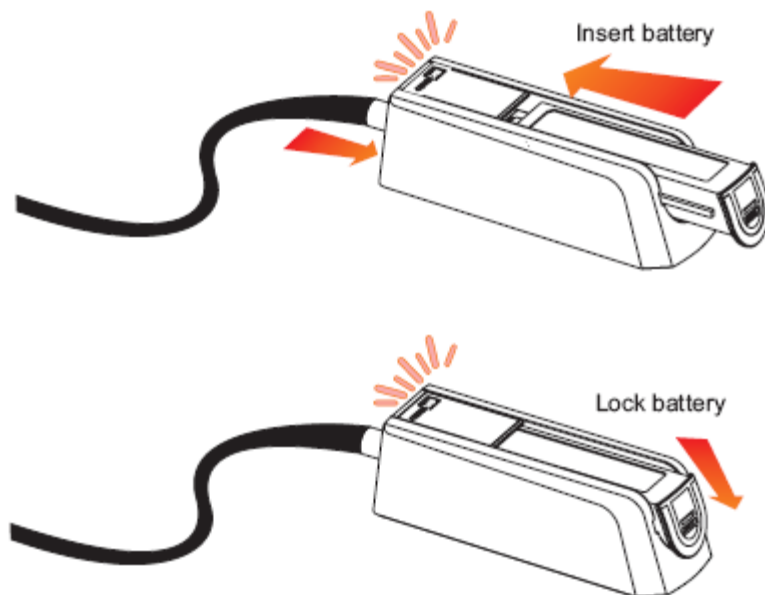

Status LED		Meaning
Red, solid	---	Charger power ON (LED on for 0.5 second)
Red, solid	---	Charging battery
---	Green, solid	Charging done
Red, solid	Green, solid	Pre-charging when battery voltage under 3V (Typical)
---	---	Power or battery not ready



INSIDE THE PACKAGE

The items included in the package may be different, depending on your order. Save the box and packaging material for future use in case you need to store or ship the scanner.

- ▶ Barcode Scanner: 1564A
- ▶ BT Base (3656)
- ▶ Rechargeable Li-ion battery
- ▶ Product CD

Note: The CD-ROM includes this manual and Windows-based *ScanMaster* software for configuration, as well as the USB Virtual COM driver.

PRODUCT HIGHLIGHTS

- ▶ Small-form-factor and built tough to survive drop test
- ▶ Extremely low power consumption
- ▶ Firmware upgradeable
- ▶ Supports most popular barcode symbologies, including GS1-128 (EAN-128), GS1 DataBar (RSS), etc.
- ▶ Supports negative barcodes
- ▶ Supports a variety of 2D symbologies
- ▶ Supports different scan modes, including Aiming Mode and Multi-Barcode Mode^{Note}
- ▶ User feedback via LED indicator and beeper
- ▶ Beeping tone and duration programmable for Good Read
- ▶ 4 MB flash memory for Memory Mode operation, storing up to 246,723 scans based on EAN-13 barcodes
- ▶ Provides up to 10 KB SRAM for reserve buffer while getting out of range over a wireless personal area network (WPAN), storing up to 640 scans based on EAN-13 barcodes
- ▶ Capable of transmitting scanned data, emulating a serial cable (BT SPP) or as keyboard input (BT HID), to a notebook computer or PDA with *Bluetooth*[®] wireless technology
- ▶ Programmable parameters include data output format, editing format, symbologies, etc.

Note: In any scan mode other than Multi-Barcode Mode, a barcode acceptable to 1564A can only contain data of 7 KB at most.



SYMBOLOLOGIES SUPPORTED

Most of the popular barcode symbologies are supported, as listed below. Each can be individually enabled or disabled. The scanner will automatically discriminate and recognize all the symbologies that are enabled. Refer to [Chapter 3 Changing Symbology Settings](#) for details of each symbology.

Symbologies Supported: Enable/Disable		Default	
Codabar		Enabled	
Code 93		Enabled	
MSI			Disabled
Code 128	Code 128	Enabled	
	GS1-128 (EAN-128)	Enabled	
	ISBT 128	Enabled	
Code 2 of 5	Industrial 25	Enabled	
	Interleaved 25	Enabled	
	Matrix 25		Disabled
	Chinese 25		Disabled
Code 3 of 9	Code 39	Enabled	
	Italian Pharmacode		Disabled
	Trioptic Code 39		Disabled
EAN/UPC	EAN-8	Enabled	
	EAN-8 Addon 2		Disabled
	EAN-8 Addon 5		Disabled
	EAN-13	Enabled	
	EAN-13 & UPC-A Addon 2		Disabled
	EAN-13 & UPC-A Addon 5		Disabled
	ISBN		Disabled
	UPC-E0	Enabled	
	UPC-E1		Disabled
	UPC-E Addon 2		Disabled
	UPC-E Addon 5		Disabled
	UPC-A	Enabled	
GS1 DataBar (RSS)	GS1 DataBar Omnidirectional (RSS-14)		Disabled
	GS1 DataBar Truncated		Disabled
	GS1 DataBar Stacked		Disabled
	GS1 DataBar Stacked Omnidirectional		Disabled



	GS1 DataBar Limited (RSS Limited)		Disabled
	GS1 DataBar Expanded (RSS Expanded)		Disabled
	GS1 DataBar Expanded Stacked		Disabled
Code 11			Disabled
Composite Code	Composite CC-A/B		Disabled
	Composite CC-C		Disabled
	Composite TLC-39		Disabled
Postal Code	US Postnet	Enabled	
	US Planet	Enabled	
	UK Postal	Enabled	
	Japan Postal	Enabled	
	Australian Postal	Enabled	
	Dutch Postal	Enabled	
	USPS 4CB/One Code/Intelligent Mail		Disabled
	UPU FICS Postal		Disabled
2D Symbologies	PDF417	Enabled	
	MicroPDF417		Disabled
	Data Matrix	Enabled	
	Maxicode	Enabled	
	QR Code	Enabled	
	MicroQR	Enabled	
	Aztec	Enabled	





QUICK START

The configuration of the scanner can be done by reading the setup barcodes contained in this manual or via the *ScanMaster* software.

This section describes the procedure of configuring the scanner by reading the setup barcodes and provides some examples for demonstration.

Configuration Mode

1. Hold down the trigger about 2 seconds to turn on the scanner. It will respond with a long beep and its LED will come on-off shortly.
2. Have the scanner read the "Enter Setup" barcode. It will respond with six beeps and its LED indicator will become flashing red after reading the barcode.
3. Have the scanner read more setup barcodes... Most of the setup barcodes are normal. The scanner will respond with two beeps (low-high tone). For special setup barcodes, it requires reading more than one setup barcode to complete the setting.
4. Have the scanner read the "Update" or "Abort" barcode. It will respond with six beeps and its LED indicator will become flashing red after reading the barcode.
5. The scanner will restart automatically upon reading the "Update" or "Abort" barcode. It will respond with a long beep and its LED will come on-off shortly.



Note: Refer to [Appendix II Host Serial Commands](#) for how to configure the 3656 stand by having the scanner read 3656-related setup barcodes or using serial commands.



Working Mode

Upon powering up, the scanner will try to establish a connection with 3656 or a computer with *Bluetooth*[®] wireless technology. Refer to [Chapter 3 – Setting up a WPAN Connection](#) for details. The connection between the scanners and 3656 is made easy and reliable.



Note: If RS-232, USB Virtual COM or BT SPP is selected for output interface, the host can directly send serial commands to configure the scanner. For example, run HyperTerminal.exe and type the 6-digit command located under each setup barcode. Refer to [Appendix II Host Serial Commands](#).



ENTER CONFIGURATION MODE

For the scanner to enter the configuration mode, you must have it read the "Enter Setup" barcode, which can be located at the bottom of almost every even page of this manual.

- ▶ The scanner will respond with six beeps and its LED indicator will become flashing red after reading the barcode.

Enter Setup



For configuring scanner parameters, see "Read a Setup Barcode" below.

EXIT CONFIGURATION MODE

For the scanner to save settings and exit the configuration mode, you must have it read the "Update" barcode, which can be located at the bottom of almost every odd page of this manual. If you want to exit the configuration mode without saving any changes, have the scanner read the "Abort" barcode instead.

- ▶ Just like reading the "Enter Setup" barcode, the scanner will respond with six beeps and its LED indicator will become flashing red after reading the barcode. Wait for a few seconds for the scanner to restart itself.

Update



109999

Abort



109998



Update

DEFAULT SETTINGS

SAVE USER SETTINGS AS DEFAULTS

For the scanner to keep the customized settings as user defaults, you must have it read the “Save as User Defaults” barcode. This is a normal setup barcode, and the scanner will respond with two beeps (low-high tone).

- ▶ After reading the “Update” barcode, the current settings will be saved as user defaults.

Save as User
Defaults



RESTORE USER DEFAULTS

For the scanner to restore the user defaults, which you have saved earlier, you must have it read the “Restore User Defaults” barcode. This is a normal setup barcode, and the scanner will respond with two beeps (low-high tone).

- ▶ After reading the “Update” barcode, all the parameters of the scanner will return to their customized values.

Restore User
Defaults



RESTORE SYSTEM DEFAULTS

For the scanner to restore the factory defaults, you must have it read the “Restore System Defaults” barcode. This is a normal setup barcode, and the scanner will respond with two beeps (low-high tone). For 3656 to restore factory defaults, refer to [3656 Setup Barcodes & Serial Commands](#).

- ▶ After reading the “Update” barcode, all the parameters of the scanner will return to their default values. The current connection record will be cleared as well.

Restore System
Defaults



Note: The system default value (if there is) for each setting is indicated by an asterisk “*”.



READ A SETUP BARCODE

CONFIGURE PARAMETERS

For most of the scanner parameters, only one read is required to set them to new values. The scanner will respond with two beeps (low-high tone) when each parameter is set successfully.



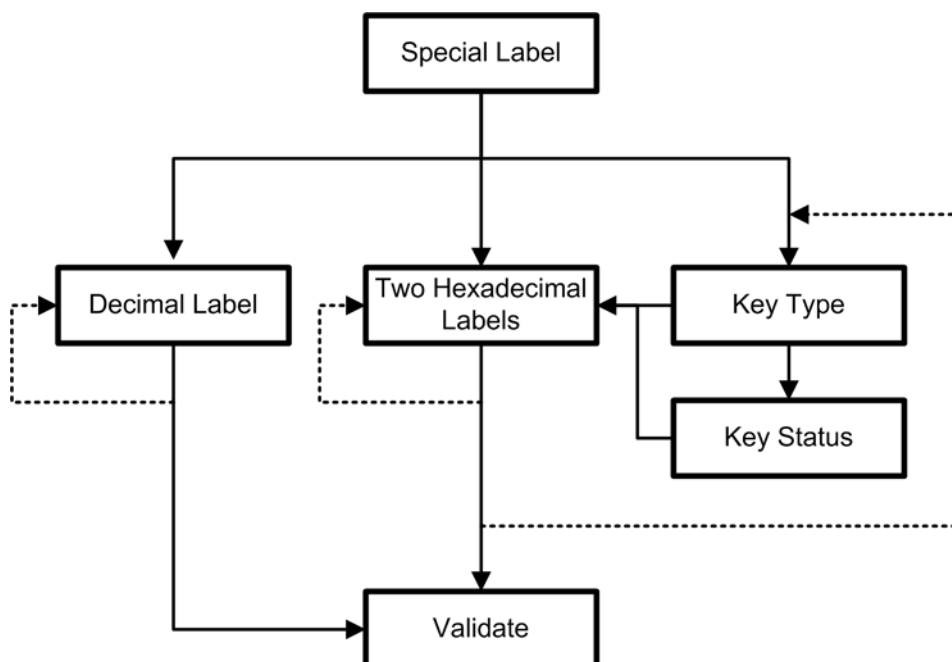

But for a number of special parameters, multiple reads are required to complete the setting. In this case, the scanner will respond with a short beep to indicate it needs to read more setup barcodes. These special parameters may require reading one or more setup barcodes, such as

- ▶ Numeric barcodes, say, for keyboard type, inter-character delay, length qualification
- ▶ Hexadecimal barcodes, say, for character strings as prefix, suffix, etc.
- ▶ When “BT HID”, “USB HID” or “Keyboard Wedge” is configured for interface, Key Type and Key Status will then become applicable. You may decide whether or not to change key status when “Normal Key” is selected for Key Type.

To complete the configuration of these special parameters, it requires reading the “Validate” barcode, and the scanner will respond with two beeps (low-high tone) to indicate the input values are validated.











The example below shows how to save your settings as “User Default” so that you may restore user defaults at a later time:

Steps	Action	User Feedback if Successful
1	Power on the scanner...	The scanner will respond with a long beep (high tone) and its LED indicator will become solid red and go off quickly.
2	Enter the Configuration Mode... <div style="text-align: center;"> <p>Enter Setup</p>  </div>	The scanner will respond with six beeps (high-low tone repeats three times), and its LED indicator will be flashing red.
3	Read a Setup barcode... For example, <div style="text-align: center;"> <p>*Enable Industrial 25</p>  <p>100307</p> <p>Save as User Default</p>  <p>103986</p> </div>	The scanner will respond with two beeps (low-high tone) if reading a normal setup barcode.
4	Exit the Configuration Mode... <div style="display: flex; justify-content: space-around; align-items: center;"> <div style="text-align: center;"> <p>Update</p>  <p>103999</p> </div> <div>OR</div> <div style="text-align: center;"> <p>Abort</p>  <p>103998</p> </div> </div>	Same as for <i>Enter the Configuration Mode</i> .
5	The scanner will automatically restart itself...	Same as for <i>Power on the scanner</i> .
*	When any configuration error occurs...	The scanner will respond with one long beep (low tone).









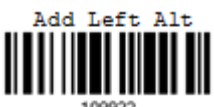

The example below shows how to set numeric parameters:

Steps	Action	User Feedback if Successful
1	Power on the scanner...	The scanner will respond with a long beep (high tone) and its LED indicator will become solid red and go off quickly.
2	Enter the Configuration Mode... <div style="text-align: center;"> <p>Enter Setup</p>  </div>	The scanner will respond with six beeps (high-low tone repeats three times), and its LED indicator will become flashing red.
3	Read a Setup barcode... For example,	The scanner will respond with two beeps (low-high tone) if reading a normal setup barcode.
	<div style="border: 1px solid red; padding: 2px; display: inline-block; margin-right: 10px;">Normal setup barcode</div> <div style="margin-left: 10px;"> <p>*Enable Interleaved 25</p>  <p>100309</p> </div>	
	<div style="border: 1px solid red; padding: 2px; display: inline-block; margin-right: 10px;">Normal setup barcode</div> <div style="margin-left: 10px;"> <p>Enable Fixed Length(s) ...</p>  <p>100604</p> </div>	
	<div style="border: 1px solid red; padding: 2px; display: inline-block; margin-right: 10px;">Special setup barcode</div> <div style="margin-left: 10px;"> <p>Max. Length (*126) Or Fixed Length 1</p>  <p>100606</p> </div>	The scanner will respond with one short beep if reading a special setup barcode such as "Max. Length", indicating the setup requires reading more barcodes.
	<div style="border: 1px solid red; padding: 2px; display: inline-block; margin-right: 10px;">Decimal barcodes</div> <div style="margin-left: 10px;"> <p>1</p>  <p>109901</p> <p>5</p>  <p>109905</p> <p>Validate</p>  <p>109994</p> </div>	<p>Read the "Decimal Value" barcode(s).</p> <ul style="list-style-type: none"> ▶ Refer to Appendix IV "Decimal System"
4	Exit the Configuration Mode... <div style="text-align: center;"> <p>Update Abort</p>  <p>109999</p> <p>OR</p>  <p>109998</p> </div>	Same as for <i>Enter the Configuration Mode</i> .
5	The scanner will automatically restart itself...	Same as for <i>Power on the scanner</i> .



The example below shows how to set string parameters:

Steps	Action	User Feedback if Successful
1	Power on the scanner...	The scanner will respond with a long beep (high tone) and its LED indicator will become solid red and go off quickly.
2	Enter the Configuration Mode... 	The scanner will respond with six beeps (high-low tone repeats three times), and its LED indicator will become flashing red.
3	Read a Setup barcode... For example,	The scanner will respond with one short beep if reading a special setup barcode such as "Prefix Code", indicating the setup requires reading more barcodes.
	<div style="border: 1px solid red; padding: 2px; display: inline-block; margin-bottom: 10px;">Special setup barcodes</div>   	<p>When "BT HID", "USB HID" or "Keyboard Wedge" is configured for interface, Key Type and Key Status will then become applicable. You may decide whether or not to change key status when "Normal Key" is selected for Key Type.</p> <p>▶ Refer to Appendix III</p>
	<div style="border: 1px solid red; padding: 2px; display: inline-block; margin-bottom: 10px;">Hexadecimal barcodes</div>   	<p>Read the "Hexadecimal Value" barcodes for the desired character string. For example, read "2" and "B" for the scanner to prefix the character "+".</p> <p>▶ Refer to Appendix IV "Hexadecimal System"</p>
4	Exit the Configuration Mode...  OR 	Same as for <i>Enter the Configuration Mode</i> .
5	The scanner will automatically restart itself...	Same as for <i>Power on the scanner</i> .



LIST THE CURRENT SETTINGS

The current settings of all scanner parameters can be sent to the host computer for user inspection. The listing includes pages as shown below. You can select the page of interest by having the scanner read the "List Page x" barcode. The scanner will respond with two beeps (low-high tone) and send the selected page to the host immediately.

List settings regarding Firmware Version, Serial Number, Interface, Buzzer, and Other Scanner Parameters

List Page 1



List settings regarding Prefix, Suffix, and Length Code Setting (1/2)

List Page 2



List settings regarding Prefix, Suffix, and Length Code Setting (2/2)

List Page 3



List settings regarding Code ID

List Page 4



List settings regarding: Readable Symbologies (1/2)

List Page 5



List settings regarding: Readable Symbologies (2/2)

List Page 6



List settings regarding Symbology Parameters (1/3)

List Page 7



List settings regarding Symbology Parameters (2/3)

List Page 8



List settings regarding Symbology Parameters (3/3)

List Page 9



Reserved

List Page 10



List settings regarding Editing Format 1
(1/2)

List Page 11



109937

List settings regarding Editing Format 1
(2/2)

List Page 12



109938

List settings regarding Editing Format 2
(1/2)

List Page 13



109939

List settings regarding Editing Format 2
(2/2)

List Page 14



109940

List settings regarding Editing Format 3
(1/2)

List Page 15



109941

List settings regarding Editing Format 3
(2/2)

List Page 16



109942

List settings regarding Editing Format 4
(1/2)

List Page 17



109943

List settings regarding Editing Format 4
(2/2)

List Page 18



109944

List settings regarding Editing Format 5
(1/2)

List Page 19



109945

List settings regarding Editing Format 5
(2/2)

List Page 20



109946

Lists settings of Driver License parsing

List Page 22



109948



CREATE ONE-SCAN SETUP BARCODES

The fact is most of the scanner parameters require only one read for setting new values. To facilitate configuring the scanner, you may create One-Scan setup barcodes for use.

1D ONE-SCAN BARCODE

The requirements of a One-Scan setup barcode are:

- ▶ a prefix of the "#@" characters
- ▶ the six digits of command parameters
- ▶ a suffix of the "#" character

1) For example, the scanner needs reading three setup barcodes for the command parameter "109952" to take effect:

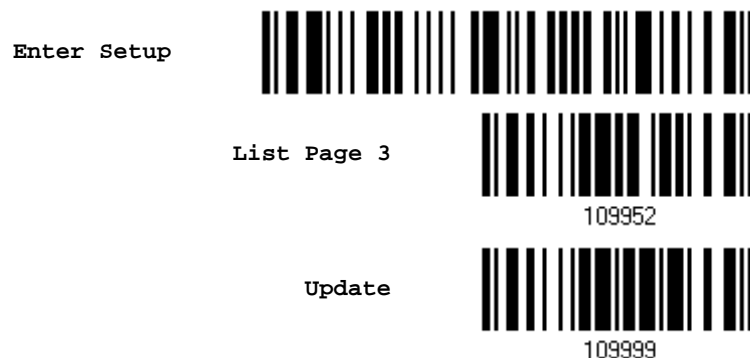

2) Now, it requires only one read:



Note: The scanner will restart automatically upon reading the One-Scan setup barcode for (1) changing the interface or (2) setting memory mode, enable or disable. It will respond with a long beep and its LED will come on-off shortly.



2D ONE-SCAN BARCODE

Users can also scan a single 2D barcode combining with a series of serial commands to configure the scanner. For example, if you want to change the suffix character to '#', you will need to input the serial commands in sequence as follows (underlining the digits is to make them more readable):

#@CipherLab101231109902109903109994

2D One-Scan Setup Barcode for configuring suffix



Command	Purpose
#@CipherLab	Enter Setup
101231	▶ Configure suffix
109902	Give the first hexadecimal digit of 0x23
109903	▶ Give the second hexadecimal digit of 0x23 for taking '#' as the suffix
109994	Validate the settings



Chapter 1

UNDERSTANDING THE BARCODE SCANNER

This chapter explains the features and usage of the barcode scanner.

IN THIS CHAPTER

1.1 Battery.....	23
1.2 Memory.....	28
1.3 LED Indicator	31
1.4 Beeper	33
1.5 Send "NR" to Host	37
1.6 Scan Modes	38
1.7 Scanning Timeout	43
1.8 Delay between Re-read.....	44
1.9 Read Redundancy (1D).....	45
1.10 Addon Security for UPC/EAN Barcodes	46
1.11 Auto-Sense Mode.....	47
1.12 Negative Barcodes	48
1.13 Picklist Mode	49
1.14 Mobile Phone/Display Mode	50
1.15 Illumination Brightness	50
1.16 Serial Number Stamp	51

1.1 BATTERY

The scanner is powered by a rechargeable 3.7 V/800 mAh Li-ion battery, and it takes approximately 5 hours to charge the battery to full (from the power adaptor). However, the charging time may vary by working condition. For intensive data collection, you may need a spare battery for uninterrupted operation.

Note: The scanner supports power economy. Refer to settings of "Power Economy", "Sniff Mode", as well as "Low Battery Alarm".

1.1.1 TURN ON/OFF THE SCANNER

Turn on the scanner...

After installing the battery, pull down the trigger for about 2 seconds. The scanner will respond with a long beep (high tone), then the LED will become solid red and go off quickly.

Turn off the scanner...

Remove the battery directly or let it turn off automatically in specific circumstances.



1.1.2 POWER ECONOMY

The scanner features “Power-Saving”, “Auto Power Off” and “Auto Power Off Ignoring Scan Mode” giving consideration to the power issue that is generally critical for Bluetooth-enabled devices. By the scanner’s support of power economy, its power consumption may progress by the following transition:

- 1) running at full CPU speed at power-on
- 2) shifting to low CPU speed (Power-Saving)
- 3) finally shutting down automatically (Auto Power Off)

In the following content of this section, you will be guided through the configurations for the scanner’s power economy.

1.1.2.1 POWER-SAVING

For the scanner to save power, you need to appoint the timing for the scanner to shift to power-saving mode. Make the configuration that best suits your application while noting the following points:

- ▶ Power-Saving: 1~254 minutes configurable. 0= Disable.

By default, the scanner stands by at full-speed for 2 minutes after power-on and before entering low-speed mode. If Power-Saving isn’t desired, set it to 0 to disable it. Read the setup barcode in the following to achieve the setup.

Note: Power-Saving setting won’t take effect when the WPAN connection is established successfully whether via BT HID or SPP.

Power-Saving after
0~254 min. (*2)



- 1) Read the barcode above to enable the scanner to enter low-speed “Power-Saving”.
- 2) Assign the time for the scanner to enter low-speed mode by reading the “Decimal Value” barcode on page 267. For example, read “5” for the scanner to enter low-speed mode after idleness of 5 minutes.
- 3) Read the “Validate” barcode on the same page to complete this setting.



Note: Power-Saving won't take effect when one of the following conditions is met:

- (1) the scanner has already established a BT HID/SPP connection,
- (2) the scanner is in the configuration mode,
- (3) the scan mode is set to Test Mode,
- (4) the setting value of Power-Saving is greater than that of Auto Power Off.

1.1.2.2 AUTO POWER OFF

For the scanner to save power, further to setting up "Power-Saving" mode, you may also need to enable "Auto Power Off", which deals with a time for the scanner to automatically power off after power-on. Make the configuration that best suits your application while noting the following points:

- ▶ Auto Power Off: 1~254 minutes configurable. 0= Disable.
 1. By default, the scanner automatically shuts down 10 minutes after power-on.
 2. If Auto Power Off isn't desired, set the parameter to 0 to disable it.
 3. When the scan mode is set to Test Mode, you need to enable "Auto Power Off Ignoring Scan Mode" in addition to enabling "Auto Power Off". See the following section [1.1.2.3 Auto Power Off Ignoring Scan Mode](#).

Note: When the scanner is set to any scan mode other than Test Mode, you can ignore "Auto Power Off Ignoring Scan Mode".

Auto Power Off after
0~254 min. (*10)



- 1) Read the barcode above to enable the scanner to automatically turn off at a specified time after power-on.
- 2) Assign the auto power off time by reading the "[Decimal Value](#)" barcode on page 267. For example, read "1" and "5" for the scanner to automatically turn off after idleness of 15 minutes.
- 3) Read the "Validate" barcode on the same page to complete this setting.

Note: "Auto Power Off" will not take effect when the scanner is in the configuration mode.

1.1.2.3 AUTO POWER OFF IGNORING SCAN MODE

- ▶ This mode is intended only for Test Mode. To force a scanner that is set to Test Mode to automatically power off to save power, you need the following settings:
 1. Enable "Auto Power Off" and set a time for the scanner to automatically power off after power-on. See the foregoing section [1.1.2.2 Auto Power Off](#)
 2. Enable "Auto Power Off Ignoring Scan Mode" by reading the barcode below:



Update



Read the barcode above to enable/disable automatic power-off for Test Mode.

Note: "Auto Power Off Ignoring Scan Mode" only features enabling and disabling. It doesn't feature the setting of auto power-off time. Such setting should be configured in the preceding setup of "Auto Power Off".

1.1.3 POWER ECONOMY VS. WPAN CONNECTION

Before the scanner can communicate with the host computer, Bluetooth connection (or WPAN connection) needs to be established. The scanner's power economy always accommodates itself to the establishment of the WPAN connection.

The following describes how the scanner carries out power economy before and after the establishment of the WPAN connection:

Before establishing a WPAN connection successfully...

1. The scanner stays active for a specified period of time (2 minutes by default) for the following scenarios. The CPU runs at full speed, and the LED blinks blue (On/Off ratio 0.5 s: 0.5 s).
 - (a) waiting for a connection request from the host (BT SPP Slave Mode)
 - (b) trying to connect to the host (BT HID or BT SPP Master Mode)
 - (c) trying to connect to 3656
2. If the scanner fails to connect within 2 minutes, it becomes inactive to save power for the remaining period of time (the specified "Auto Power Off" value minus 2 minutes). The CPU starts to run at low speed, and the LED begins to blink red (On/Off ratio 0.3 s: 2.5 s).

Pull the trigger to wake up the scanner when it becomes inactive, and the scanner will become active again.
3. If it fails to connect again and again, and finally stays inactive until the specified Auto Power Off time elapses, the scanner will automatically turn off in order to conserve battery power.

Pull down the trigger for about 2 seconds to turn it on again.

Note: For scenarios (a) and (b) in step 1, you may need to search for the scanner again on your computer.

After establishing a WPAN connection successfully...

1. Once a WPAN connection is established successfully, the scanner will stay active for a specified
-



period of time (2 minutes by default) for data transmission. The CPU runs at full speed, and the LED blinks blue (On/Off ratio 0.02 s: 3 s).

2. If the scanner stays idle for 2 minutes (default), it will then turn inactive to save power for the remaining period of time (the specified "Auto Power Off" value minus 2 minutes). The CPU runs at low speed, and the LED is blinking red (On/Off ratio 0.3 s: 2.5 s).

Pull the trigger to wake up the scanner when it becomes inactive, then the scanner will stay active again.

- ▶ For BT HID or SPP, the scanner automatically shuts down after the configured "Auto Power Off" time without the transition from full CPU speed to low CPU speed. However, when connecting with 3656, the scanner will go through the transition in order to save power.

3. If the scanner first becomes idle and finally stays inactive until the specified Auto Power Off time is up, the scanner will automatically turn off in order to conserve battery power. You will hear three short beeps, tone descending from high to low.

Pull down the trigger for about 2 seconds to turn it on again.

- ▶ For BT HID, the scanner resumes the connection with the host upon powering on again, as long as the host application is running. You will hear three short beeps, tone ascending from low to high upon the resumption. If the scanner fails to resume the connection, it will try every 5 seconds to re-connect to the host unless you have the scanner read the "Reset Connection" barcode.
- ▶ For BT SPP Slave Mode, the scanner waits for the host to re-connect.
- ▶ For BT SPP Master Mode, the scanner resumes the connection with the host upon powering on again as long as the host application is running. You will hear three short beeps, tone ascending from low to high upon resumption. If the scanner fails to resume the connection, it will try every 5 seconds to re-connect to the host unless you have the scanner read the "Reset Connection" or "Restore System Defaults" barcode.
- ▶ With the use of 3656, the scanner tries to re-connect 3656 unless you turn off the scanner.



1.2 MEMORY

The collected data can be sent back to a host computer one by one via the WPAN connection or stored in flash memory when the scanner is set to Memory mode.

1.2.1 TRANSMIT BUFFER

By default, transmit buffer is enabled and for use when the scanner is out of range. Upon reading a barcode successfully within range, the scanner responds with one short beep (high tone) and its LED indicator becomes solid green and goes off quickly. However, the host computer may not receive the data immediately if getting out of range. With the 10 KB transmit buffer, the scanner can ignore the transmission status and keep on reading barcodes until the buffer is full.

When transmit buffer is enabled...

If the scanner is out of range, it will respond with two short beeps, high-low tone, upon reading a barcode successfully.

When transmit buffer is full, the scanner will respond with one long beep (low tone) and its LED indicator will become solid red and go off quickly. You are advised to get back to range.

When transmit buffer is disabled...

If the scanner is out of range, it will respond with one long beep (low tone) and its LED indicator will become solid red and go off quickly. You are advised to get back to range.

***Enable**



Disable



Note: The 10 KB transmit buffer on the scanner can hold as many as 640 scans based on EAN-13 barcodes. Data will be cleared out once the scanner is turned off or running out of battery power!



1.2.2 MEMORY MODE

The scanner keeps 4 MB flash memory for memory mode operation. When the scanner is in memory mode, it means any real-time connection established with host is disabled.



Warning: No real-time connection is allowed unless the memory mode is disabled.

Memory Data Delay

You may set a delay between each data record while transmitting data back to the host.





Send Data

The 4 MB flash memory on the scanner can store up to 246,723 scans based on EAN-13 barcodes. When it is used up, the scanner will respond with two short beeps (high-low tone) as a warning.

You are advised to send data to the host immediately by having the scanner read the "Send Data" barcode below. It will resume the previous WPAN connection with host temporarily.



Clear Data & Confirm

Even though data has been sent back to the host, the flash memory is still occupied unless you erase the memory by having the scanner read two barcodes – "Clear Data" and "Confirm".

1. Read the "Clear Data" barcode to clear the flash memory.
2. Read the "Confirm" barcode to confirm the action.



1.2.3 FREE MEMORY

You can scan the barcode below to show the available capacity of the flash memory in percentage terms.



1.3 LED INDICATOR

The triple-color LED on top of the scanner is used to provide user feedback. For example, the LED becomes solid red and goes off quickly upon powering on or running out of transmit buffer. You may tell the difference by the beeps – you will hear a long beep of high tone when powering on the scanner, and a long beep of low tone when the transmit buffer becomes full.

Scanner LED			Meaning
Red, flashing	---	---	<ul style="list-style-type: none"> ▶ Charging (On/Off ratio 0.5 s: 0.5 s) ▶ Configuration Mode (On/Off ratio 0.5 s: 0.5 s)
Red, solid	---	---	Charging error
Red, flashing	---	---	Flashing red (On/Off ratio 0.3 s: 2.5 s) indicates the scanner is inactive and its CPU running at low speed to save power — <ul style="list-style-type: none"> ▶ No WPAN connection is established after waiting for two minutes
Red, on-off	---	---	<ul style="list-style-type: none"> ▶ Power on, with one long beep (high tone, LED on for 1 second) ▶ Data saved to buffer when transmit buffer is enabled and the scanner is out of range, with two short beeps (high-low tone) ▶ Transmit buffer full, with one long beep (low tone) ▶ Transmit buffer disabled, with one long beep (low tone) ▶ Memory full in memory mode, with two short beeps (high-low tone)
---	---	Green, on-off	Good Read, with one short beep (high tone) and beeper pitch and duration programmable
---	Blue, flashing	---	First, flashing blue (On/Off ratio 0.5 s: 0.5 s) for two minutes indicates the scanner is waiting for connection, and goes off if no connection is established, then flashing red (On/Off ratio 0.3 s: 2.5 s) indicates the scanner is inactive. It is ready for connection only while the LED is flashing blue — <ul style="list-style-type: none"> ▶ SPP Slave: waiting host to connect ▶ HID or SPP Master: trying to connect to host ▶ Using 3656: trying to connect to 3656
---	Blue, flashing	---	Flashing blue (On/Off ratio 0.1 s: 0.1 s) indicates the scanner receives a PIN code request from host (flashing more quickly than waiting connection).
---	Blue, flashing	---	Flashing blue (On/Off ratio 0.02 s: 3 s) indicates the scanner has established a WPAN connection successfully.
---	Blue, flashing	Green, flashing	Flashing blue and green (On/Off ratio 0.1 s: 0.1 s) indicates an error occurs while entering the PIN code. Press the trigger to get ready for re-connecting.



1.3.1 GOOD READ LED

*Enable
Good Read LED



Disable
Good Read LED



1.3.2 GOOD READ LED DURATION

By default, the Good Read LED stays on for 40 milliseconds. Specify a value, ranging from 1 to 254 in units of 10 milliseconds.

Good Read LED
Time-out after
0.01~2.54 sec.
(*40 ms)



- 1) Read the barcode above to specify the time interval before the Good Read LED goes off.
- 2) Read the "Decimal Value" barcode on page 267. For example, read "1" and "5" for the LED to go off after 150 milliseconds.
- 3) Read the "Validate" barcode on the same page to complete this setting.



1.4 BEEPER

The scanner has a buzzer to provide user feedback in various operating conditions.

Beeping	Meaning
One long beep, high tone	Power on, with red LED on (1 second) and off quickly
One short beep, high tone ▶ Programmable, default to 4 KHz	Good Read, with green LED on-off quickly
Six short beeps ▶ High-low tone repeats three times	<ul style="list-style-type: none"> ▶ Enter Configuration Mode, with red LED flashing ▶ Exit Configuration Mode
Two short beeps, low-high tone	Setup barcode read successfully
One short beep, high tone	<ul style="list-style-type: none"> ▶ More setup barcode required ▶ Input PIN code ▶ Clear PIN code
One short beep, low tone	More barcodes required to complete the "output sequence" requirements of Multi-Barcode Editor, with green LED on-off quickly (Upon completion, same as Good Read.)
One long beep, low tone	<ul style="list-style-type: none"> ▶ Transmit buffer full, with red LED on-off quickly ▶ Transmit buffer disabled, with red LED on-off quickly ▶ Configuration error (Wrong barcode...) ▶ PIN code input error ▶ Reject random PIN request ▶ Fail to send data in memory mode
Two short beeps, high-low tone	<ul style="list-style-type: none"> ▶ Data saved to buffer when transmit buffer is enabled and the scanner is out of range, with red LED on-off quickly ▶ Memory Mode – Memory full, with red LED on-off quickly
Two short beeps, high tone	Low Battery Alarm
Two long beeps, high-low tone	Multi-Barcode Mode – Buffer full
Three short beeps, tone ascending from low to high	<ul style="list-style-type: none"> ▶ WPAN connection established, with blue LED flashing ▶ WPAN connection resumed, with blue LED flashing
Three short beeps, tone ascending from high to low	WPAN connection out of range or suspended



1.4.1 BEEPER VOLUME

Mute



101009

Minimum Volume



101010

Medium Volume



101011

*Maximum Volume



101012



1.4.2 GOOD READ BEEP

Frequency



Duration

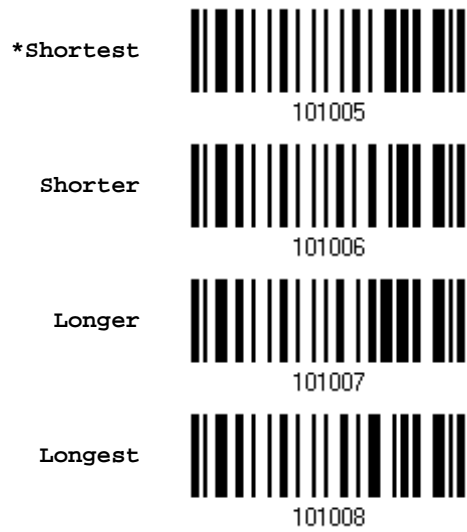

1.4.3 LOW BATTERY ALARM

By default, it will activate the beeper to give a warning when the battery charge gets low. In order to prevent data loss, you are advised to replace the battery immediately when you hear two short beeps (high tone).

No Alarm



101017

*Low Battery Alarm



101018



1.5 SEND "NR" TO HOST

This feature only works when Keyboard Wedge or RS-232 is selected for output interface. You may have the scanner send the "NR" string to the host to notify the No Read event.

Enable



100267

*Disable



100266



Update

1.6 SCAN MODES

Different scan modes are supported – select the scan mode that best suits the requirements of a specific application. Refer to the comparison table below.

- ▶ A barcode acceptable to 1564A can only contain data of 7 KB at most.

Scan Mode	Start to Scan				Stop Scanning			
	Always	Press trigger once	Hold trigger	Press trigger twice	Release trigger	Press trigger once	Barcode being read	Timeout
Test mode	✓							
Laser mode			✓		✓		✓	✓
Auto Off mode		✓					✓	✓
Auto Power Off mode		✓						✓
Aiming mode				✓			✓	✓
Multi-Barcode mode			✓		✓			
Presentation mode	✓							

Note: By default, the scan mode is set to Laser mode.



1.6.1 TEST MODE

The scanner is always scanning.

- ▶ Capable of decoding the same barcode repeatedly without removing it, for testing purpose.

Test Mode



1.6.2 LASER MODE

The scanner will start scanning once the trigger is held down.

- ▶ The scanning won't stop until (1) a barcode is decoded, (2) the pre-set timeout expires, or (3) you release the trigger.

Note: Refer to "Scanning Timeout".

*Laser Mode



1.6.3 AUTO OFF MODE

The scanner will start scanning once the trigger is pressed.

- ▶ The scanning won't stop until (1) a barcode is decoded, and (2) the pre-set timeout expires.

Note: Refer to "Scanning Timeout".

Auto Off Mode



1.6.4 AUTO POWER OFF MODE

The scanner will start scanning once the trigger is pressed.

- ▶ The scanning won't stop until the pre-set timeout expires, and, the pre-set timeout period re-counts after each successful decoding.

Note: Refer to "Delay between Re-read" and "Scanning Timeout".

Auto Power Off Mode



100202



1.6.5 AIMING MODE

The scanner will aim at a barcode once the trigger is pressed, and start scanning when the trigger is pressed again within one second.

- ▶ The scanning won't stop until (1) a barcode is decoded, and (2) the pre-set timeout expires.

Aiming Mode



100208

Aiming Timeout

You can limit the aiming time interval (1~15). By default, the scanner time-out is set to 1 second.

Aiming Time-out
after 1~15 sec.
(*1)



100226

1. Read the barcode above to specify the time interval before aiming ends. (It is set to 1 by default.)
2. Read the "Decimal Value" barcode on page 267. For example, read "1" and "0" for the scanner to automatically shut down after idleness of 10 seconds.
3. Read the "Validate" barcode on the same page to complete this setting.

1.6.6 MULTI-BARCODE MODE

The scanner will be scanning as long as the trigger is held down, capable of decoding one single barcode, as well as multiple unique barcodes one at a time. While decoding a bunch of unique barcodes, if a barcode is decoded twice, its subsequent decoding will be ignored and the scanner is expecting another unique barcode.

For 1564A to decode multiple unique barcodes, the maximum output data length of all the barcodes is 10 KB after configuration. When the output length exceeds 10 KB, Multi-Barcode Mode will not take effect.

- ▶ The scanning won't stop until you release the trigger.

Multi-Barcode Mode



100209

Note: (1) A barcode is considered unique when its Code Type or data is different from others.

(2) Multi-Barcode Mode has nothing to do with the [Multi-Barcode Editor](#).



1.6.7 PRESENTATION MODE

The scanner will be expecting barcodes. Whenever a barcode is brought within range, the scanner will be able to decode it. It is suggested to seat it in the Auto-Sense Stand for hands-free operation.

Presentation Mode



Low Light Enhancement

Enabling Low Light Enhancement will cause the illumination to remain on at a low power in low lighting conditions.

Enable



*Disable



1.7 SCANNING TIMEOUT

Specify the scanning time interval (1~254 sec.; 0= Disable) when the scan mode is set to any of the following –

- ▶ Laser mode
- ▶ Auto Off mode
- ▶ Auto Power Off mode
- ▶ Aiming mode

Scanner Time-out
after 0~254 sec.
(*10)



- 1) Read the barcode above to specify the time interval before the scan engine times out.
- 2) Read the "Decimal Value" barcode on page 267. For example, read "1" and "5" for the scanner to automatically shut down after being idle for 15 seconds.
- 3) Read the "Validate" barcode on the same page to complete this setting.



1.8 DELAY BETWEEN RE-READ

This is also referred to as the “Blocking Time”, which is used to prevent the scanner from accidentally reading the same barcode twice when the scan mode is set to any of the following –

- ▶ Auto Power Off mode
- ▶ Presentation mode



1.9 READ REDUNDANCY (1D)

Select the level of reading security. For example,

- ▶ If "No Redundancy" is selected, one successful decoding will make the reading valid and induce the "READER Event".
- ▶ If "Two Times" is selected, it will take a total of three consecutive successful decoding of the same barcode to make the reading valid. The higher the reading security is (that is, the more redundancy the user selects), the slower the reading speed gets.

It is obvious that the more redundancy you select, the higher the reading security is, and thus, the slower the reading speed becomes. You will have to compromise between reading security and decoding speed.

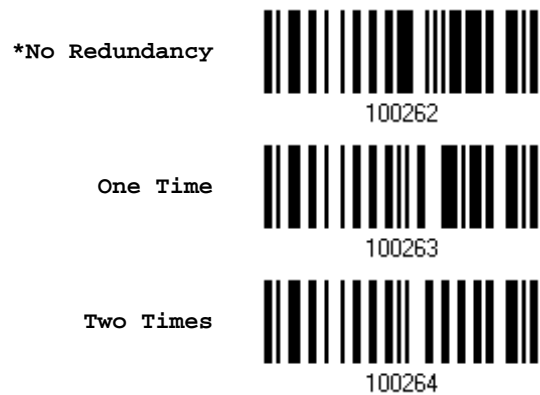

1.10 ADDON SECURITY FOR UPC/EAN BARCODES

The scanner is capable of decoding a mix of UPC/EAN barcodes with and without addons. The read redundancy (2~30 times) allows changing the number of times to decode a UPC/EAN barcode before transmission. The more redundancy you select, the higher the reading security is, and thus, the slower the reading speed becomes. You will have to compromise between reading security and decoding speed.

Note: UPC/EAN Addon 2 and Addon 5 must be enabled individually for this setting to take effect.

Addon Security Level
(*2~30)



- 1) Read the barcode above to specify the read redundancy for UPC/EAN barcodes. (It is set to 2 by default.)
- 2) Read the "Decimal Value" barcode on page 267. For example, read "1" and "2" for the scanner to re-read the barcode for 12 times.
- 3) Read the "Validate" barcode on the same page to complete this setting.



1.11 AUTO-SENSE MODE

This mode is only available when you want to seat the scanner in the Auto-Sense stand. When you enable this mode, it will force the scanner to apply Laser mode as the scan mode. However, it works slightly differently from the original Laser mode. Now the scanner will be expecting barcodes as long as it is seated in the Auto-Sense stand, as shown below. Whenever a barcode is brought within range, the scanner will be able to decode it.

Refer to [1.6.7 Presentation Mode](#).

Note: To stop this mode, you may remove the scanner from the stand or have the scanner read the “Disable (Auto-Sense)” barcode below. It will return to Laser mode. If Laser mode is not desired, proceed to select a scan mode best suits your application.

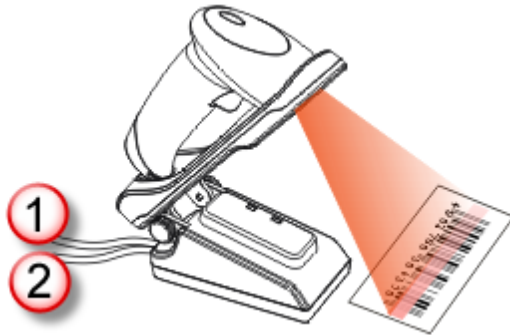

Note: For Auto-Sense mode to work, you must connect both the power supply cord and the interface cable to the Auto-Sense stand. USB power is insufficient.

Enable



*Disable



1.12 NEGATIVE BARCODES

Normally, barcodes are printed with the color of the bars darker than that of the spaces. But for negative barcodes, they are printed in the opposite sense just like negative films. The spaces of negative barcodes are printed with a color darker than that of the bars. You can configure the scanner to be able to read negative barcodes in the following symbologies:

- ▶ All 1D symbologies
- ▶ Data Matrix
- ▶ QR Code
- ▶ Aztec

Enable



100225

*Disable



100224



1.13 PICKLIST MODE

Picklist Mode enables the decoder to decode only the barcodes aligned at the center under the laser aiming pattern.

Enable



*Disable



1.14 MOBILE PHONE/DISPLAY MODE

By default this mode is disabled. There is a big improvement in reading barcodes displayed on mobile phones and electronic displays when this mode is enabled.

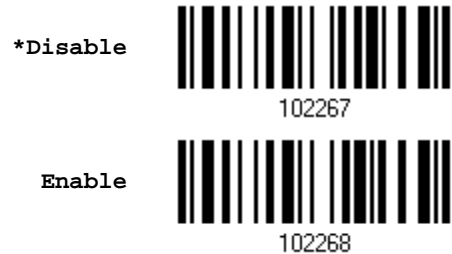

1.15 ILLUMINATION BRIGHTNESS

Users can adjust the illumination brightness of the LED light source. Specify a value ranging from 1 to 10 to set the brightness level which is set to 10 by default meaning 100% illuminated.



- 1) Read the barcode above to commence the adjustment.
- 2) Read the "Decimal Value" barcode on page 267 for the desired illumination brightness level.
- 3) Read the "Validate" barcode on the same page to complete the setting.



1.16 SERIAL NUMBER STAMP

Decide whether to add the device serial number in front of the data transmitted.

Add serial number in
front of data



101365

*Disable



101364

1.16.1 SEPARATOR BETWEEN SERIAL NUMBER STAMP AND DATA

Scan the barcode below to specify the separator character between device serial number and the accompanying data. By default, the separator is a comma symbol.

Specify the
separator character



101380

- 1) Read the barcode above to specify a separator character.
- 2) Read the "Hexadecimal Value" barcode on page 268 for the desired character.
- 3) Read the "Validate" barcode to complete this setting.



SELECTING OUTPUT INTERFACE

In order to establish a proper connection between your computer and the scanner, we suggest that you follow these instructions –

- 1) Install the battery and hold down the trigger for about 2 seconds to turn on the scanner.
- 2) Have the scanner read the “Enter Setup” barcode to enter the configuration mode.
- 3) Have the scanner read the associated barcodes to activate the desired interface. See the following sections for output interfaces supported.
- 4) Have the scanner read the barcodes for related settings.
- 5) Have the scanner read the “Update” barcode to exit the configuration mode.
- 6) Turn on your computer or laptop and establish a WPAN connection with the scanner.

Refer to Chapter 3 – Setting up a WPAN Connection.

Note: By default, the output interface is set to “BT HID”.

IN THIS CHAPTER

2.1 BT HID	54
2.2 BT SPP Slave.....	65
2.3 BT SPP Master	68
2.4 Keyboard Wedge via 3656	72
2.5 RS-232 via 3656.....	83
2.6 USB HID via 3656	88
2.7 USB Virtual COM via 3656	98



2.1 BT HID

For BT HID, refer to [Chapter 3 – Setting up a WPAN Connection](#) for related connection settings. Run any text editor on your computer, and the scanned data will be transmitted to the computer.

HID Settings	Defaults
Keyboard Type	PCAT (US)
Alphabets Layout	Normal
Digits Layout	Normal
Capital Lock Type	Normal
Capital Lock State	Off
Alphabets Transmission	Case-sensitive
Digits Transmission	Alphanumeric keypad
Kanji Transmission	Disable
Inter-Character Delay	0 (ms)
Inter-Function Delay	0 (ms)



2.1.1 ACTIVATE BT HID & SELECT KEYBOARD TYPE

When BT HID interface is activated, you will have to select a keyboard type to complete this setting. By default, BT HID is activated on the scanner, and the keyboard type is set to PCAT (US).

Activate BT HID &
Select Keyboard
Type...



- 1) Read the barcode above to activate BT HID and select a keyboard type.
- 2) Read the “Decimal Value” barcode on page 267. Refer to the table below for the number of desired keyboard type.
- 3) Read the “Validate” barcode on the same page to complete this setting.

BT HID

By default, the keyboard type is set to PCAT (US). The following keyboard types are supported —

No.	Keyboard Type	No.	Keyboard Type
64	PCAT (US)	72	PCAT (Spanish)
65	PCAT (French)	73	PCAT (Portuguese)
66	PCAT (German)	74	PS55 A01-2 (Japanese)
67	PCAT (Italy)	75	User-defined table
68	PCAT (Swedish)	76	PCAT (Turkish)
69	PCAT (Norwegian)	77	PCAT (Hungarian)
70	PCAT (UK)	78	PCAT (Swiss German)
71	PCAT (Belgium)	79	PCAT (Danish)



2.1.2 RESET CONNECTION

For BT HID, you can only have the scanner connected to one computer at a time. If you want to connect the scanner to another host, you must have it read the “Reset Connection” barcode so that the current connection record will be cleared. Then, the scanner will restart itself automatically. Go through the whole process in [3.2.3 Connect to Dongle](#) to establish a new connection.

Reset Connection



109919

Note: The “Restore System Defaults” barcode will have the current connection record cleared as well.



2.1.3 KEYBOARD SETTINGS

- ▶ Alphabets Layout
- ▶ Digits Layout
- ▶ Capital Lock Type
- ▶ Capital Lock Setting
- ▶ Alphabets Transmission
- ▶ Digits Transmission
- ▶ Kanji Transmission

Note: BT HID does not support these functions on PDAs – (1) Capital Lock Setting: Auto Detection (2) Digits Transmission: Numeric Key

Alphabets Layout

By default, the alphabets layout is set to normal mode, also known as the standard English layout. Select French or German keyboard layout if necessary. The scanner will make adjustments when sending the "A", "Q", "W", "Z", "Y", and "M" characters according to this setting.

*Normal



100060

AZERTY



100061

QWERTZ



100062

Note: This setting only works when the keyboard type selected is US keyboard, such as PCAT (US). The Alphabets Layout and Digits Layout setting must match your keyboard.



US Keyboard Style - Normal

QWERTY layout, which is normally used in western countries.

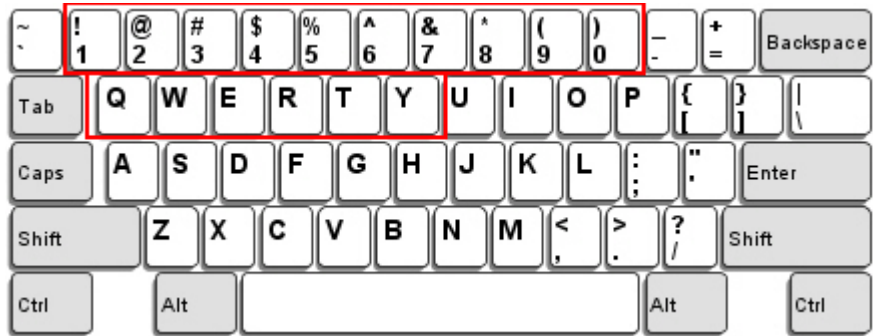

- ▶ Select "Lower Row" for the "Digits Layout" setting for the upper row is for special characters.

French Keyboard Style - AZERTY

French layout; see below for French Keyboard Style.

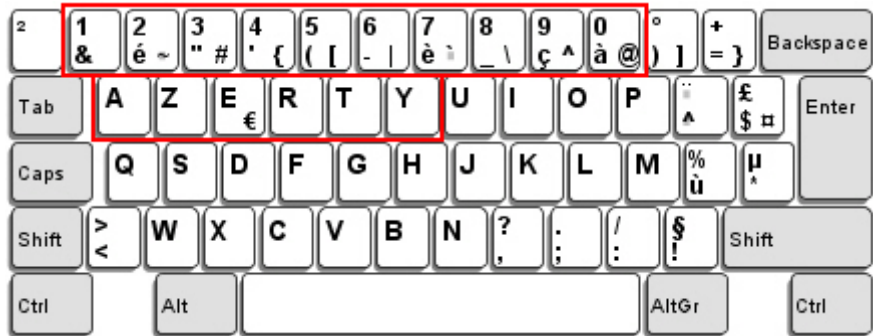

- ▶ Select "Upper Row" for the "Digits Layout" setting for the lower row is for special characters.

German Keyboard Layout - QWERTZ

German layout; see below for German Keyboard Style.



- ▶ Select "Lower Row" for the "Digits Layout" setting for the upper row is for special characters.



Digits Layout

Select a proper layout that matches the alphabets layout. The scanner will make adjustments according to this setting.

Options	Description
Normal	Depends on the [Shift] key or [Shift Lock] setting
Lower Row	For QWERTY or QWERTZ keyboard
Upper Row	For AZERTY keyboard

*Normal



100046

Upper Row



100049

Lower Row



100048

Note: This setting is to be used with the Character Substitution setting when support to certain keyboard types (languages) is unavailable but required.



Capital Lock Type & Setting

In order to send the alphabets with correct case, the scanner needs to know the status of Caps Lock on the keyboard. Incorrect settings may result in reversed case of the alphabets being transmitted.

Cap Lock Type	Description
Normal	Normal type
Capital Lock	When enabled, the keys of alphabetic characters will be interpreted as capital letters. However, this does not affect the number or punctuation keys.
Shift Lock	When enabled, the keys of alphabetic characters will be interpreted as capital letters. In addition, this affects the number or punctuation keys.



Capital Lock State	Description
Capital Lock OFF	Assuming that the status of Caps Lock on the keyboard is OFF, transmitted characters are exactly the same as in the barcode (when "case-sensitive" is selected for Alphabets Transmission).
Capital Lock ON	Assuming that the status of Caps Lock on the keyboard is ON, transmitted characters are exactly the same as in the barcode (when "case-sensitive" is selected for Alphabets Transmission). ▶ Refer to the Capital Lock Type above.
Auto Detection	The scanner will automatically detect the status of Caps Lock on the keyboard before data is transmitted; transmitted characters are exactly the same as in the barcode (when "case-sensitive" is selected for Alphabets Transmission). ▶ This setting is not supported on PDAs.



*Capital Lock OFF



Alphabets Transmission

By default, the alphabets transmission is case-sensitive, meaning that the alphabets will be transmitted according to their original case, the status of Caps Lock on the keyboard, as well as the Capital Lock setting. Select [Ignore Case] to have alphabets transmitted according to the status of Caps Lock on the keyboard only.

Ignore Case



*Case-sensitive



1. Letter Case for Output Format

Refer to 5.1 Letter Case.

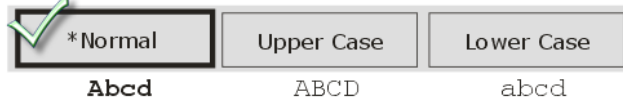

2. Alphabets Transmission for Keyboard Wedge & Bluetooth HID



3a. Check Caps Lock on the keyboard

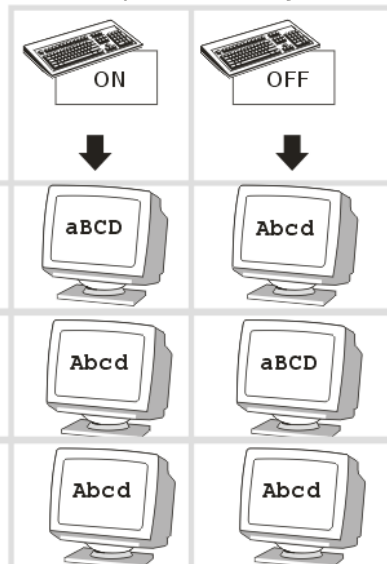

3b. Check Caps Lock on the keyboard

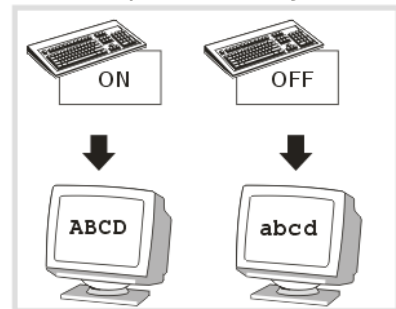

4. Check Capital Lock setting

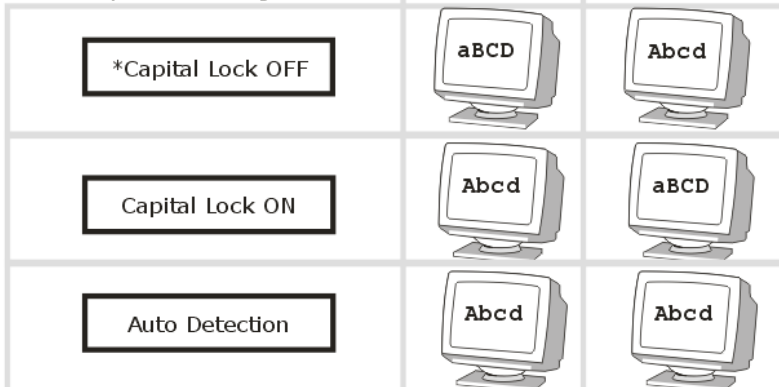

Digits Transmission

By default, the alphanumeric keypad is used for transmitting digits. Select "Numeric Keypad" if you wish to use the keys on the numeric keypad.

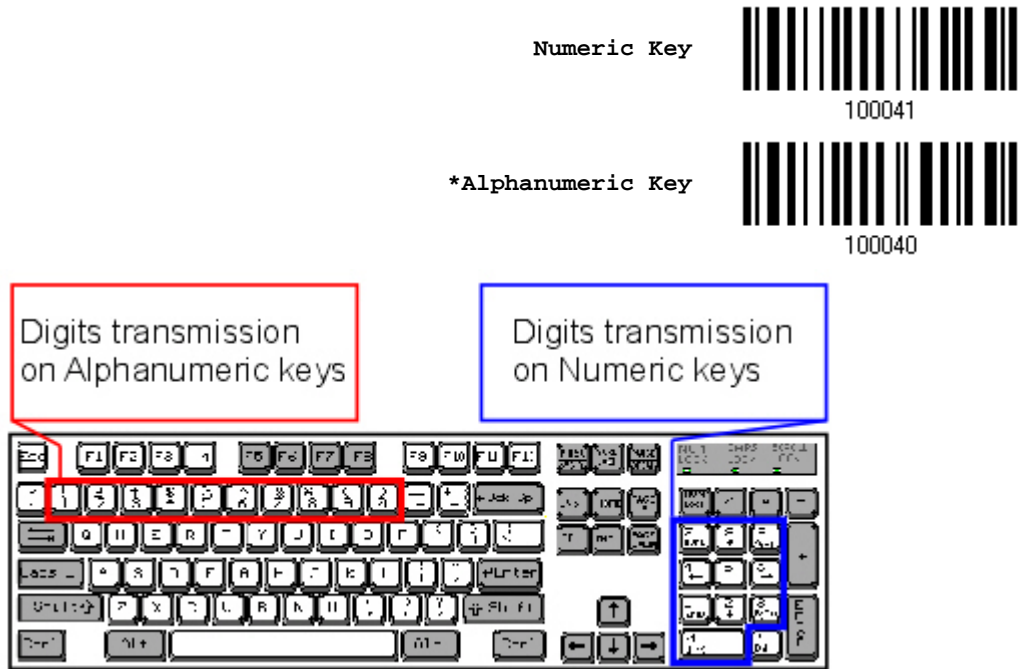

Note: If you select "Numeric Keypad", the Num Lock status of the physical keyboard should be "ON". This setting is not supported on PDAs.

Kanji Transmission

Kanji Transmission is supported by the scanner when either Bluetooth HID, Keyboard Wedge via 3656 or USB HID via 3656 is selected for the output interface. By Kanji Transmission, when the host computer is running on Japanese Windows O.S., the scanner is able to transmit Japanese characters including the Chinese characters used in modern Japanese writing system.

Kanji Transmission is disabled by default. Enable/disable scanner's Kanji Transmission by reading the following barcodes:



2.1.4 INTER-CHARACTER DELAY

By default, the inter-character delay is set to zero. Specify a value, ranging from 0 to 254 in units of millisecond, to match the computer response time of the keyboard interface. Such delay time is inserted between every character being transmitted. The longer the delay time is, the slower the transmission speed will be.

Inter-Character
Delay... (*0~254)



- 1) Read the barcode above to specify the inter-character delay.
- 2) Read the "Decimal Value" barcode on page 267 for the desired inter-character delay (millisecond).
- 3) Read the "Validate" barcode on the same page to complete this setting.

2.1.5 INTER-FUNCTION DELAY

By default, the inter-function delay is set to zero. Specify a value, ranging from 0 to 254 in units of millisecond, to match the computer response time of the keyboard interface. Such delay time is inserted between every function code (0x01 ~ 0x1F) being transmitted. The longer the delay time is, the slower the transmission speed will be.

Inter-Function
Delay... (*0~254)



- 1) Read the barcode above to specify the inter-function delay.
- 2) Read the "Decimal Value" barcode on page 267 for the desired inter-function delay (millisecond).
- 3) Read the "Validate" barcode on the same page to complete this setting.



2.1.6 HID CHARACTER TRANSMIT MODE

By default, HID interface sends data to the host in batch. You may have the scanner read the "By Character" barcode to process data one character at a time.

*Batch Processing



By Character



Note: "By Character" transmit mode is required when working with iPhone or iPad.

2.1.7 SPECIAL KEYBOARD FEATURE

By default, this interface employs special function codes (0x01 ~ 0x1F) defined in the Keyboard Wedge Table. However, users may want to get rid of these special codes within the barcodes to avoid data error. You can decide whether to apply the special keyboard feature. For further details please refer to [Keyboard Wedge Table](#).

*Apply



Bypass



2.1.8 KEYPAD SUPPORT FOR IPHONE/IPAD

When the scanner has been successfully connected to iPhone or iPad for data collection, the onscreen keypad of iPhone or iPad will disappear.

Have the scanner read the following barcode to show or hide the keypad if necessary.

Show or Hide Keypad



Note: This function only works for
(1) iPhone 4 and 3GS version 4.1 or later, and (2) iPad version 4.2 or later.

2.1.9 TRANSMIT SPEED

By default, the BT HID transmit speed is set to normal. Users can have the scanner work in quicker transmit speed by reading the Fast barcode.



2.1.10 SIMPLE PAIRING FOR IPHONE/IPAD

The window requiring pairing passcode is always pop-up when you are using a *Bluetooth*® connection to an iPhone or iPad. To connect to iOS-based devices more quickly, scan the barcode below to enable *Bluetooth*® simple pairing so that the passcode-required window will not show up when establishing a connection. By default, this function is set to Disable.



Note: Simple pairing only supports to the device with *Bluetooth*® v2.1 or later.

2.1.11 BT HID SLAVE/MASTER SWITCHING

By default, the BT HID role is set to slave. Users can have the scanner switch between slave and master by reading the barcodes below.



2.1.12 BT HID AUTO-RECONNECTION

Users can decide whether to have the scanner automatically reconnect to a paired device after disconnection, and the occasion for reconnecting.

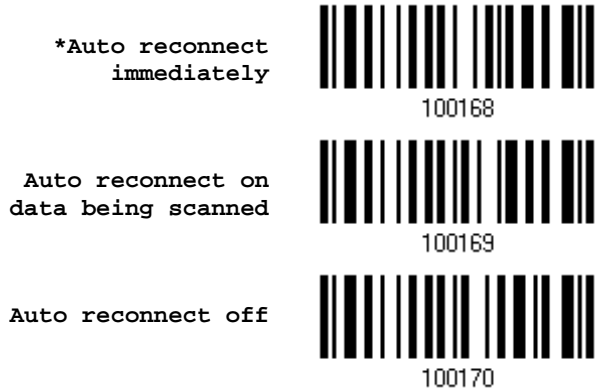

2.2 BT SPP SLAVE

For BT SPP Slave, refer to Chapter 3 – Setting up a WPAN Connection for related connection settings.

2.2.1 ACTIVATE BT SPP SLAVE MODE

Scan this barcode to have the scanner get into SPP Slave Mode.



2.2.2 INTER-FUNCTION DELAY

By default, the inter-function delay is set to zero. Specify a value, ranging from 0 to 254 in units of millisecond, to match the computer response time of the keyboard interface. Such delay time is inserted between every function code (0x01 ~ 0x1F) being transmitted. The longer the delay time is, the slower the transmission speed will be.

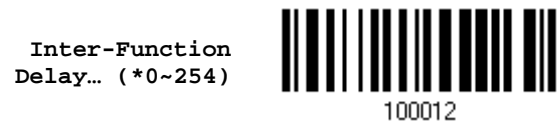

- 1) Read the barcode above to specify the inter-function delay.



- 2) Read the “Decimal Value” barcode on page 267 for the desired inter-function delay (millisecond).
- 3) Read the “Validate” barcode on the same page to complete this setting.

2.2.3 ACK/NAK TIMEOUT

By default, the scanner sends data to the host without waiting for an ACK/NAK response before sending more data. Specify a value, ranging from 1 to 99 in units of 0.1 second. If no response within the specified period of time, the scanner will attempt to send the same data two more times. If all three attempts fail without any notification, data loss will occur.

ACK/NAK Time-out
after ... (*0~99)



- 1) Read the barcode above to specify the time interval for the scanner to send data and wait for a response from the host.
- 2) Read the “Decimal Value” barcode on page 267. For example, read “1” and “0” for the scanner to automatically shut down after being idle for 1 second.
- 3) Read the “Validate” barcode on the same page to complete this setting.

ACK/NAK Error Beep

Enable Error Beep



*Disable Error Beep



Note: We suggest enabling the error beep so that you will be notified of such data loss and have the scanner re-read data.



2.3 BT SPP MASTER

As a SPP master device, the scanner will be able to resume connection with the host upon powering on again, as long as the host application is running. If the scanner fails to resume connection, it will try every 5 seconds to re-connect to the host unless you have the scanner read the "Reset Connection" or "Restore System Defaults" barcode.

For BT SPP Master, refer [3.2.2 Configure Related Settings](#) for related connection settings.

Note: In SPP Master Mode, if it fails to re-connect within the specified period of time (2 minutes by default), the scanner will become inactive to save power. Once the re-connection is established successfully, the scanner will not go through transition from full CPU speed to low CPU speed even though it is idle during the specified time interval for Auto Power Off. It will automatically turn off when the time is up. Refer to [1.1.3 Power Economy vs. WPAN Connection](#).

2.3.1 ACTIVATE BT SPP MASTER MODE

This is SPP Master Mode.

Activate BT SPP,
Master Mode



100007

How to connect with the target device?

Produce two setup barcodes for the target SPP slave device, just like what we do for 3656.

- ▶ "Set Connection"
- ▶ "MAC ID"

Note: The "MAC ID" barcode must have a prefix of two characters, either "0x" or "OX", followed by the real MAC address of the target device.

Usage:

1. Read the "Activate BT SPP, Master Mode" barcode above and barcodes for connection settings, such as authentication and preset PIN. Skip this step if no connection settings are desired.
2. Read the "Set Connection" and "MAC ID" barcodes. The scanner will respond with one beep upon reading each of the barcodes.

Set Connection



88686471166254

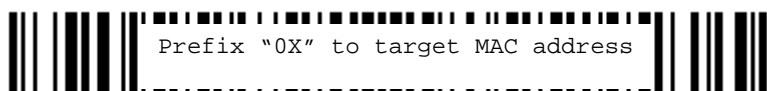

Prefix "OX" to target MAC address

OX00D0176F0030



Note: Read the "Set Connection" barcode first, and then the "MAC ID" barcode within 10 seconds.

Instead of producing the "MAC ID" barcode, you may have the scanner read the setup barcodes for entering the MAC address.

- ▶ Have the scanner read the "Abort" barcode to cancel the operation at any time while reading setup barcodes for the MAC address. If the MAC address has not been completed yet, having the scanner read the "Validate" barcode can cancel the operation as well.

Enter MAC ID in
Hexadecimal...



Usage:

1. Read the barcode above.
2. Read the "Hexadecimal Value" barcode on page 268 for the desired MAC address.
3. Read the "Validate" barcode on the same page to complete this setting.

Exit SPP Master Mode

To stop such re-connection, have the scanner read "Reset Connection" or "Restore System Defaults" barcode so that the current connection record (= MAC ID) will be cleared. Then, the scanner will restart itself automatically. Go through the whole process in [3.2.3 Connect to Dongle](#) to establish a new WPAN connection.

Reset Connection



Users can also scan a single 2D barcode that combines the "Set Connection" and "MAC ID" setup barcodes to connect with the target device. The example below is a 2D barcode containing codes '#@CipherLab', '88686471166254' (Set Connection), '0x' (Prefix to the target MAC ID), and '00D0176F0030' (MAC ID of the target device). Underlining the digits is to make them more readable.

#@CipherLab886864711662540X00D0176F0030

2D One-Scan Setup Barcode for connecting with a target device



Command	Purpose
#@CipherLab	Enter Setup
88686471166254	▶ Set connection



0x	Prefix to the target MAC ID
00d0176f0030	▶ MAC address ID of the target device

2.3.2 INTER-FUNCTION DELAY

By default, the inter-function delay is set to zero. Specify a value, ranging from 0 to 254 in units of millisecond, to match the computer response time of the keyboard interface. Such delay time is inserted between every function code (0x01 ~ 0x1F) being transmitted. The longer the delay time is, the slower the transmission speed will be.

Inter-Function
Delay... (*0~254)



- 1) Read the barcode above to specify the inter-function delay.
- 2) Read the "Decimal Value" barcode on page 267 for the desired inter-function delay (millisecond).
- 3) Read the "Validate" barcode on the same page to complete this setting.



2.3.3 ACK/NAK TIMEOUT

By default, the scanner sends data to the host without waiting for an ACK/NAK response before sending more data. Specify a value, ranging from 1 to 99 in units of 0.1 second. If no response within the specified period of time, the scanner will attempt to send the same data two more times. If all three attempts fail without any notification, data loss will occur.

ACK/NAK Time-out
after ... (*0~99)



100013

- 1) Read the barcode above to specify the time interval for the scanner to send data and wait for a response from the host.
- 2) Read the "Decimal Value" barcode on page 267. For example, read "1" and "0" for the scanner to automatically shut down after being idle for 1 second.
- 3) Read the "Validate" barcode on the same page to complete this setting.

ACK/NAK Error Beep

Enable Error Beep



100015

*Disable Error Beep



100014

Note: We suggest enabling the error beep so that you will be notified of such data loss and have the scanner re-read data.

2.3.4 SWITCH BETWEEN MASTER/SLAVE MODE

After the scanner has established a connection as a SPP slave device, you may have it read the "Activate BT SPP, Master Mode" setup barcode to switch to SPP Master Mode. This will result in easy and reliable re-connection, just like connecting with 3656.



2.4 KEYBOARD WEDGE VIA 3656

The Y cable allows you to connect the scanner via 3656 to the keyboard input port of PC and you may join the keyboard as well. The scanned data will be transmitted to the host keyboard port as if it is manually entered via the keyboard. For example, run a text editor on your computer to receive the data.

Keyboard Wedge Settings	Defaults
Keyboard Type	PCAT (US)
Alphabets Layout	Normal
Digits Layout	Normal
Capital Lock Type	Normal
Capital Lock State	Off
Alphabets Transmission	Case-sensitive
Digits Transmission	Alphanumeric keypad
Kanji Transmission	Disable
Alternate Composing	No
Laptop Support	Disable
Inter-Character Delay	0 (ms)
Inter-Function Delay	0 (ms)



2.4.1 ACTIVATE KEYBOARD WEDGE & SELECT KEYBOARD TYPE

When Keyboard Wedge interface is activated, you will have to select a keyboard type to complete this setting.

Activate 3656
Keyboard Wedge &
Select Keyboard
Type...



- 1) Read this barcode above to activate Keyboard Wedge and select a keyboard type.
- 2) Read the “Decimal Value” barcode on page 267. Refer to the table below for the number of desired keyboard type.
- 3) Read the “Validate” barcode on the same page to complete this setting.

Keyboard Wedge via 3656

By default, the keyboard type is set to PCAT (US). The following keyboard types are supported when using 3656 with the keyboard wedge cable provided —

No.	Keyboard Type	No.	Keyboard Type
1	PCAT (US)	18	PS55 001-3
2	PCAT (French)	19	PS55 001-8A
3	PCAT (German)	20	PS55 002-1, 003-1
4	PCAT (Italian)	21	PS55 002-81, 003-81
5	PCAT (Swedish)	22	PS55 002-2, 003-2
6	PCAT (Norwegian)	23	PS55 002-82, 003-82
7	PCAT (UK)	24	PS55 002-3, 003-3
8	PCAT (Belgium)	25	PS55 002-8A, 003-8A
9	PCAT (Spanish)	26	IBM 3477 Type 4 (Japanese)
10	PCAT (Portuguese)	27	PS2-30
11	PS55 A01-1	28	IBM 34XX/319X, Memorex Telex 122 Keys
12	PS55 A01-2 (Japanese)	29	User-defined table
13	PS55 A01-3	30	PCAT (Turkish)
14	PS55 001-1	31	PCAT (Hungarian)
15	PS55 001-81	32	PCAT (Swiss German)
16	PS55 001-2	33	PCAT (Danish)
17	PS55 001-82		



2.4.2 KEYBOARD SETTINGS

- ▶ Alphabets Layout
- ▶ Digits Layout
- ▶ Capital Lock Type
- ▶ Capital Lock Setting
- ▶ Alphabets Transmission
- ▶ Digits Transmission
- ▶ Kanji Transmission
- ▶ Alternate Composing
- ▶ Laptop Support

Alphabets Layout

By default, the alphabets layout is set to normal mode, also known as the standard English layout. Select French or German keyboard layout if necessary. The scanner will make adjustments when sending the "A", "Q", "W", "Z", "Y", and "M" characters according to this setting.



Note: This setting only works when the keyboard type selected is US keyboard, such as PCAT (US). The Alphabets Layout and Digits Layout setting must match your keyboard.



US Keyboard Style - Normal

QWERTY layout, which is normally used in western countries.

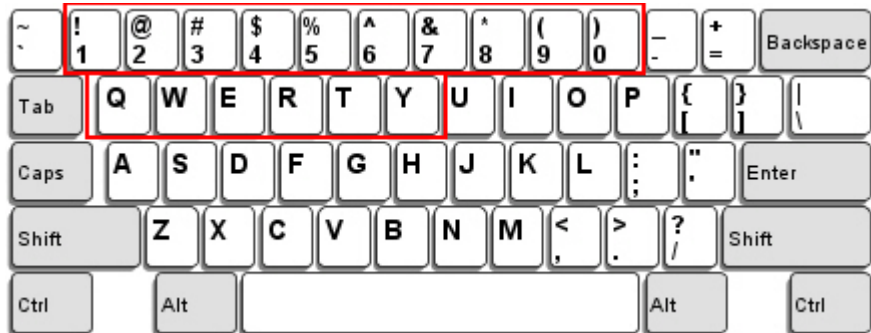

- ▶ Select "Lower Row" for the "Digits Layout" setting for the upper row is for special characters.

French Keyboard Style - AZERTY

French layout; see below for French Keyboard Style.

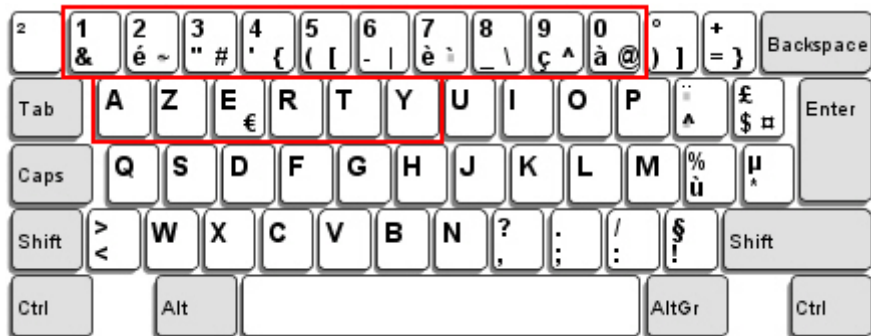

- ▶ Select "Upper Row" for the "Digits Layout" setting for the lower row is for special characters.

German Keyboard Layout - QWERTZ

German layout; see below for German Keyboard Style.

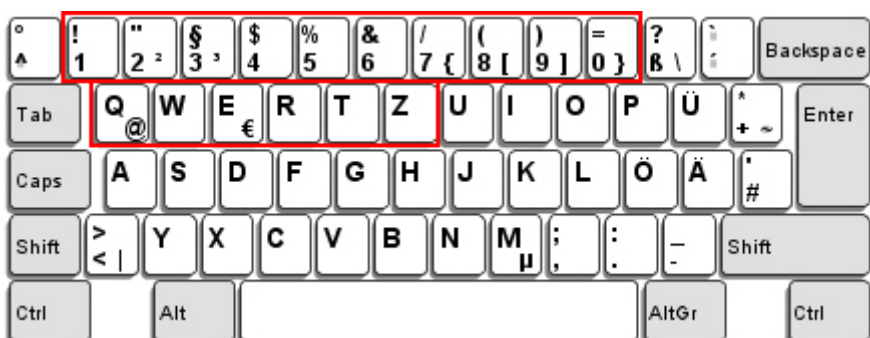

- ▶ Select "Lower Row" for the "Digits Layout" setting for the upper row is for special characters.



Digits Layout

Select a proper layout that matches the alphabets layout. The scanner will make adjustments according to this setting.

Options	Description
Normal	Depends on the [Shift] key or [Shift Lock] setting
Lower Row	For QWERTY or QWERTZ keyboard
Upper Row	For AZERTY keyboard

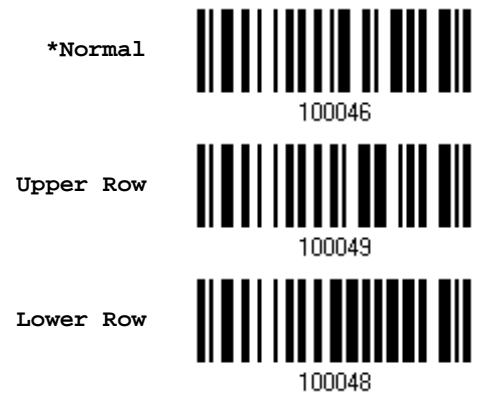

Note: This setting is meant to be used with the Alphabets Layout; and perhaps with the Character Substitution setting when support to certain keyboard types (languages) is unavailable but required.



Capital Lock Type & Setting

In order to send the alphabets with correct case, the scanner needs to know the status of Caps Lock on the keyboard. Incorrect settings may result in reversed case of the alphabets being transmitted.

Cap Lock Type	Description
Normal	Normal type
Capital Lock	When enabled, the keys of alphabetic characters will be interpreted as capital letters. However, this does not affect the number or punctuation keys.
Shift Lock	When enabled, the keys of alphabetic characters will be interpreted as capital letters. In addition, this affects the number or punctuation keys.

***Normal** 
 100042

Shift Lock 
 100045

Capital Lock 
 100044

Capital Lock State	Description
Capital Lock OFF	Assuming that the status of Caps Lock on the keyboard is OFF, transmitted characters are exactly the same as in the barcode (when "case-sensitive" is selected for Alphabets Transmission).
Capital Lock ON	Assuming that the status of Caps Lock on the keyboard is ON, transmitted characters are exactly the same as in the barcode (when "case-sensitive" is selected for Alphabets Transmission). ▶ Refer to the Capital Lock Type above.
Auto Detection	The scanner will automatically detect the status of Caps Lock on the keyboard before data is transmitted; transmitted characters are exactly the same as in the barcode (when "case-sensitive" is selected for Alphabets Transmission).

Auto Detect 
 100054

Capital Lock ON 
 100053



*Capital Lock OFF



100052



Enter Setup

Alphabets Transmission

By default, the alphabets transmission is case-sensitive, meaning that the alphabets will be transmitted according to their original case, the status of Caps Lock on the keyboard, as well as the Capital Lock setting. Select [Ignore Case] to have alphabets transmitted according to the status of Caps Lock on the keyboard only.

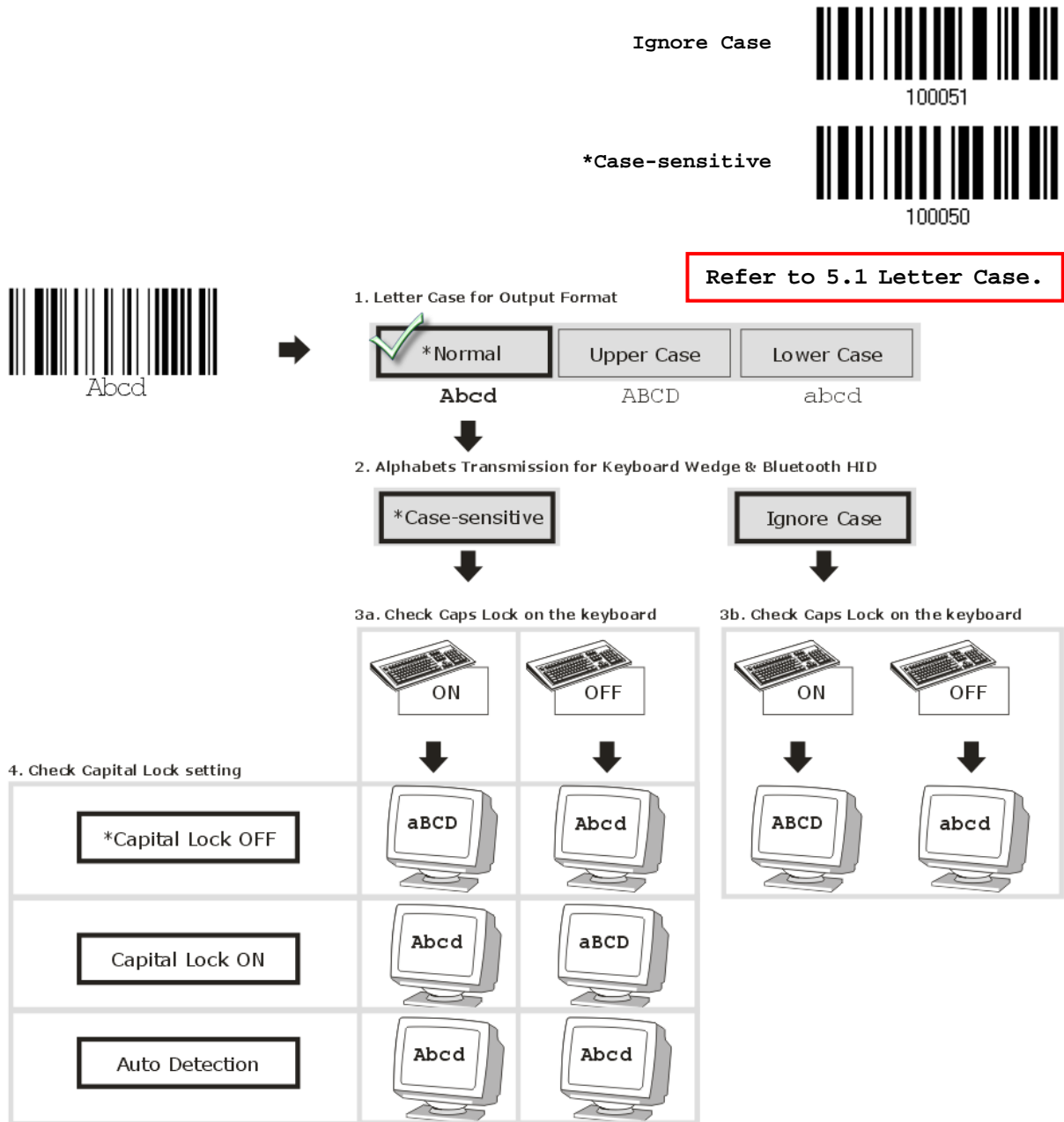

Digits Transmission

By default, the alphanumeric keypad is used for transmitting digits. Select "Numeric Keypad" if you wish to use the keys on the numeric keypad.

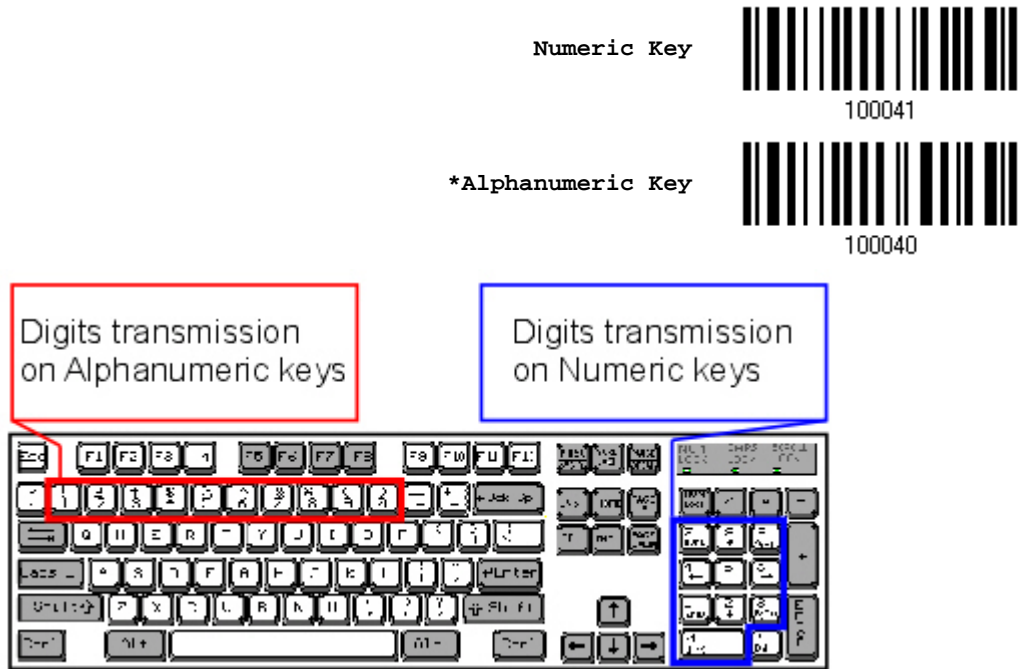

Note: If you select "Numeric Keypad", the Num Lock status of the physical keyboard should be "ON".

Kanji Transmission

Kanji Transmission is supported by the scanner when either Bluetooth HID, Keyboard Wedge via 3656 or USB HID via 3656 is selected for the output interface. By Kanji Transmission, when the host computer is running on Japanese Windows O.S., the scanner is able to transmit Japanese characters including the Chinese characters used in modern Japanese writing system.

Kanji Transmission is disabled by default. Enable/disable scanner's Kanji Transmission by reading the following barcodes:



ALT Composing

By default, Alternate key composing is disabled. Select [Yes] to allow emulating Alternate key code of a specific keyboard character. For example, [Alt] + [O65] will be sent to host for the character "A" regardless the keyboard type you are using.



Laptop Support

By default, laptop support is disabled. It is suggested to enable this feature if you connect the wedge cable to a laptop without an external keyboard being inter-connected.

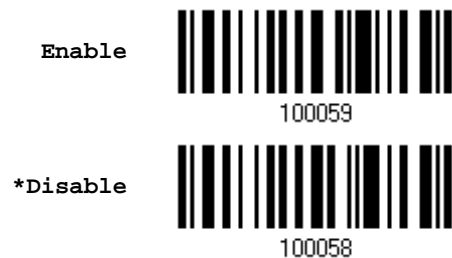

2.4.3 INTER-CHARACTER DELAY

By default, the inter-character delay is set to zero. Specify a value, ranging from 0 to 254 in units of millisecond, to match the computer response time of the keyboard interface. Such delay time is inserted between every character being transmitted. The longer the delay time is, the slower the transmission speed will be.

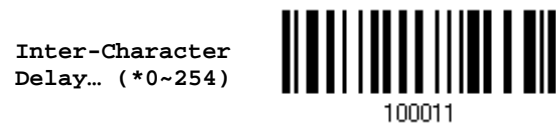

- 1) Read the barcode above to specify the inter-character delay.
- 2) Read the "Decimal Value" barcode on page 267 for the desired inter-character delay (millisecond).
- 3) Read the "Validate" barcode on the same page to complete this setting.



2.4.4 INTER-FUNCTION DELAY

By default, the inter-function delay is set to zero. Specify a value, ranging from 0 to 254 in units of millisecond, to match the computer response time of the keyboard interface. Such delay time is inserted between every function code (0x01 ~ 0x1F) being transmitted. The longer the delay time is, the slower the transmission speed will be.

Inter-Function
Delay... (*0~254)



- 1) Read the barcode above to specify the inter-function delay.
- 2) Read the "Decimal Value" barcode on page 267 for the desired inter-function delay (millisecond).
- 3) Read the "Validate" barcode on the same page to complete this setting.

2.4.5 SPECIAL KEYBOARD FEATURE

By default, this interface employs special function codes (0x01 ~ 0x1F) defined in the Keyboard Wedge Table. However, users may want to get rid of these special codes within the barcodes to avoid data error. You can decide whether to apply the special keyboard feature. For further details please refer to Keyboard Wedge Table.

*Apply



Bypass



2.5 RS-232 VIA 3656

Use the RS-232 cable to connect the scanner via 3656 to the serial port of PC, and connect the power supply cord. The associated RS-232 parameters must match those configured on the computer. You may run HyperTerminal.exe on your computer, and the scanned data will be transmitted to the computer.

RS-232 Settings	Defaults
Baud Rate, Data Bit, Parity, Stop Bit	115200 bps, 8 bits, No parity, 1 stop bit
Flow Control	None
Inter-Character Delay	0 (ms)
Inter-Function Delay	0 (ms)
ACK/NAK Timeout	0
ACK/NAK Beep	Disable

2.5.1 ACTIVATE RS-232 INTERFACE

Activate 3656
RS-232 Interface



2.5.2 BAUD RATE

*115200 bps



57600 bps



38400 bps



19200 bps



9600 bps



4800 bps	 100100
2400 bps	 100085
1200 bps	 100086
600 bps	 100087

2.5.3 DATA BITS

*8 bits	 100093
7 bits	 100092

2.5.4 PARITY

*No parity	 100088
Even	 100090
Odd	 100091



2.5.5 STOP BIT

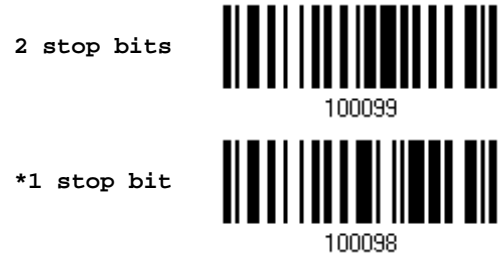

2.5.6 FLOW CONTROL

By default, there is no flow control in use. Select the flow control (handshake) method.

Options	Description
No	No flow control
Scanner Ready	The scanner will activate the RTS signal upon powering on. After each good read, the scanner will then wait for the CTS signal to become active. Data will not be sent until the CTS signal becomes active.
Data Ready	The RTS signal will be activated after each good read. The scanner will then wait for the CTS signal to become active. Data will not be sent until the CTS signal becomes active.
Inverted Data Ready	It works the same as the Data Ready flow control except that the RTS signal level is inverted.



2.5.7 INTER-CHARACTER DELAY

By default, the inter-character delay is zero. Specify a value, ranging from 0 to 254 in units of millisecond, to match the computer response time. Such delay time is inserted between every character being transmitted. The longer the delay time is, the slower the transmission speed will be.

Inter-Character
Delay... (*0~254)



- 1) Read the barcode above to specify the inter-character delay.
- 2) Read the "Decimal Value" barcode on page 267 for the desired inter-character delay (millisecond).
- 3) Read the "Validate" barcode on the same page to complete this setting.

2.5.8 INTER-FUNCTION DELAY

By default, the inter-function delay is set to zero. Specify a value, ranging from 0 to 254 in units of millisecond, to match the computer response time of the keyboard interface. Such delay time is inserted between every function code (0x01 ~ 0x1F) being transmitted. The longer the delay time is, the slower the transmission speed will be.

Inter-Function
Delay... (*0~254)



- 1) Read this barcode above to specify the inter-function delay.
- 2) Read the "Decimal Value" barcode on page 267 for the desired inter-function delay (millisecond).
- 3) Read the "Validate" barcode on the same page to complete this setting.



2.5.9 ACK/NAK TIMEOUT

By default, the scanner sends data to the host without waiting for an ACK/NAK response before sending more data. Specify a value, ranging from 1 to 99 in units of 0.1 second. If no response within the specified period of time, the scanner will attempt to send the same data two more times. If all three attempts fail without any notification, data loss will occur.

ACK/NAK Time-out
after ... (*0~99)



100013

- 1) Read the barcode above to specify the time interval for the scanner to send data and wait for a response from the host.
- 2) Read the "Decimal Value" barcode on page 267. For example, read "1" and "0" for the scanner to automatically shut down after being idle for 1 second.
- 3) Read the "Validate" barcode on the same page to complete this setting.

ACK/NAK Error Beep

Enable Error Beep



100015

*Disable Error Beep



100014

Note: We suggest enabling the error beep so that you will be notified of such data loss and have the scanner re-read data.



2.6 USB HID VIA 3656

For USB HID, use the USB cable to connect the scanner via 3656 to the USB port of PC and connect the power supply cord. Run any text editor on your computer, and the scanned data will be transmitted to the computer.

Warning: When the 3656 stand is solely on USB power, the provided current may be insufficient for it to function normally. You must connect the power supply cord.

HID Settings	Defaults
Keyboard Type	PCAT (US)
Digits Layout	Normal
Capital Lock Type	Normal
Capital Lock State	Off
Alphabets Transmission	Case-sensitive
Digits Transmission	Alphanumeric keypad
Kanji Transmission	Disable
Inter-Character Delay	0 (ms)
Inter-Function Delay	0 (ms)



2.6.1 ACTIVATE USB HID & SELECT KEYBOARD TYPE

When USB HID interface is activated, you will have to select a keyboard type to complete this setting.

Activate
3656 USB HID & Select
Keyboard Type...



- 1) Read the barcode above to activate USB HID and select a keyboard type.
- 2) Read the “Decimal Value” barcode on page 267. Refer to the table below for the number of desired keyboard type.
- 3) Read the “Validate” barcode on the same page to complete this setting.

USB HID

By default, the keyboard type is set to PCAT (US). The following keyboard types are supported —

No.	Keyboard Type	No.	Keyboard Type
64	PCAT (US)	72	PCAT (Spanish)
65	PCAT (French)	73	PCAT (Portuguese)
66	PCAT (German)	74	PS55 A01-2 (Japanese)
67	PCAT (Italy)	75	User-defined table
68	PCAT (Swedish)	76	PCAT (Turkish)
69	PCAT (Norwegian)	77	PCAT (Hungarian)
70	PCAT (UK)	78	PCAT (Swiss German)
71	PCAT (Belgium)	79	PCAT (Danish)



2.6.2 KEYBOARD SETTINGS

- ▶ Alphabets Layout
- ▶ Digits Layout
- ▶ Capital Lock Type
- ▶ Capital Lock Setting
- ▶ Alphabets Transmission
- ▶ Digits Transmission
- ▶ Kanji Transmission

Alphabets Layout

By default, the alphabets layout is set to normal mode, also known as the standard English layout. Select French or German keyboard layout if necessary. The scanner will make adjustments when sending the "A", "Q", "W", "Z", "Y", and "M" characters according to this setting.



Note: This setting only works when the keyboard type selected is US keyboard, such as PCAT (US). The Alphabets Layout and Digits Layout setting must match your keyboard.



US Keyboard Style - Normal

QWERTY layout, which is normally used in western countries.

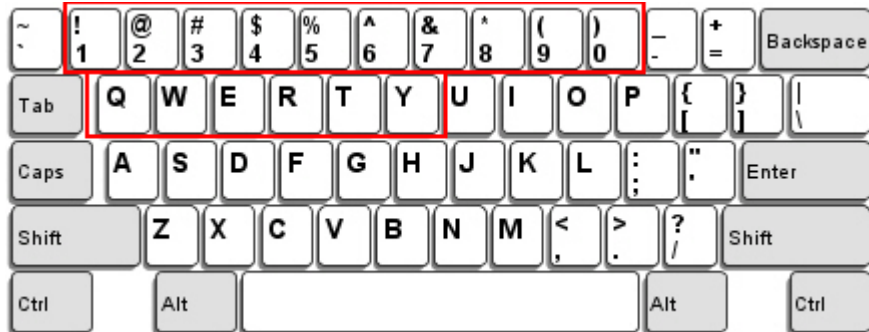

- ▶ Select "Lower Row" for the "Digits Layout" setting for the upper row is for special characters.

French Keyboard Style - AZERTY

French layout; see below for French Keyboard Style.

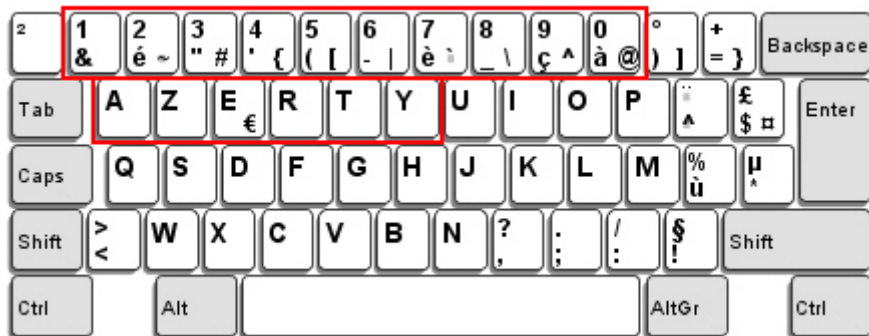

- ▶ Select "Upper Row" for the "Digits Layout" setting for the lower row is for special characters.

German Keyboard Layout - QWERTZ

German layout; see below for German Keyboard Style.

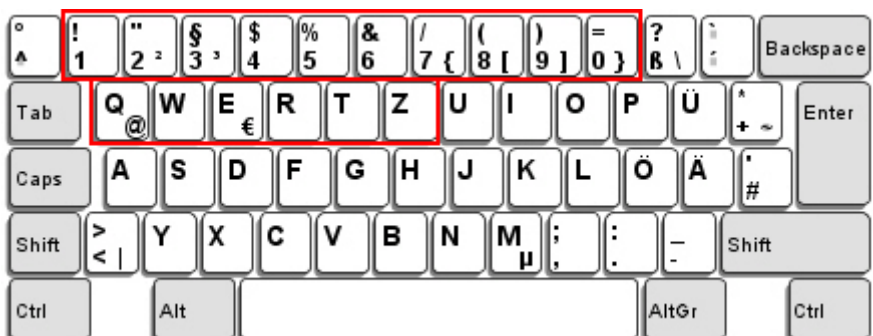

- ▶ Select "Lower Row" for the "Digits Layout" setting for the upper row is for special characters.



Digits Layout

Select a proper layout that matches the alphabets layout. The scanner will make adjustments according to this setting.

Options	Description
Normal	Depends on the [Shift] key or [Shift Lock] setting
Lower Row	For QWERTY or QWERTZ keyboard
Upper Row	For AZERTY keyboard

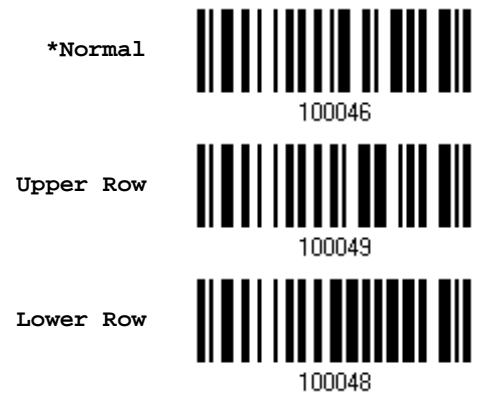

Note: This setting is to be used with the Character Substitution setting when support to certain keyboard types (languages) is unavailable but required.



Capital Lock Type & Setting

In order to send the alphabets with correct case, the scanner needs to know the status of Caps Lock on the keyboard. Incorrect settings may result in reversed case of the alphabets being transmitted.

Cap Lock Type	Description
Normal	Normal type
Capital Lock	When enabled, the keys of alphabetic characters will be interpreted as capital letters. However, this does not affect the number or punctuation keys.
Shift Lock	When enabled, the keys of alphabetic characters will be interpreted as capital letters. In addition, this affects the number or punctuation keys.



Capital Lock State	Description
Capital Lock OFF	Assuming that the status of Caps Lock on the keyboard is OFF, transmitted characters are exactly the same as in the barcode (when "case-sensitive" is selected for Alphabets Transmission).
Capital Lock ON	Assuming that the status of Caps Lock on the keyboard is ON, transmitted characters are exactly the same as in the barcode (when "case-sensitive" is selected for Alphabets Transmission). ▶ Refer to the Capital Lock Type above.
Auto Detection	The scanner will automatically detect the status of Caps Lock on the keyboard before data is transmitted; transmitted characters are exactly the same as in the barcode (when "case-sensitive" is selected for Alphabets Transmission).

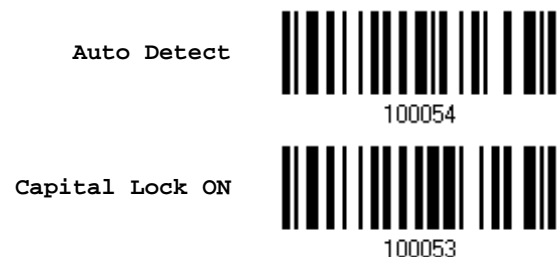

*Capital Lock OFF



Alphabets Transmission

By default, the alphabets transmission is case-sensitive, meaning that the alphabets will be transmitted according to their original case, the status of Caps Lock on the keyboard, as well as the Capital Lock setting. Select [Ignore Case] to have alphabets transmitted according to the status of Caps Lock on the keyboard only.

Ignore Case



*Case-sensitive



1. Letter Case for Output Format

Refer to 5.1 Letter Case.



2. Alphabets Transmission for Keyboard Wedge & Bluetooth HID



3a. Check Caps Lock on the keyboard

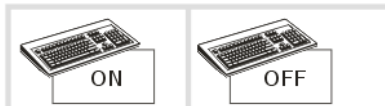

3b. Check Caps Lock on the keyboard

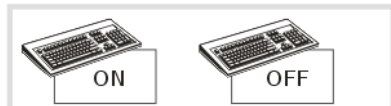

4. Check Capital Lock setting

*Capital Lock OFF		
Capital Lock ON		
Auto Detection		



Digits Transmission

By default, the alphanumeric keypad is used for transmitting digits. Select "Numeric Keypad" if you wish to use the keys on the numeric keypad.

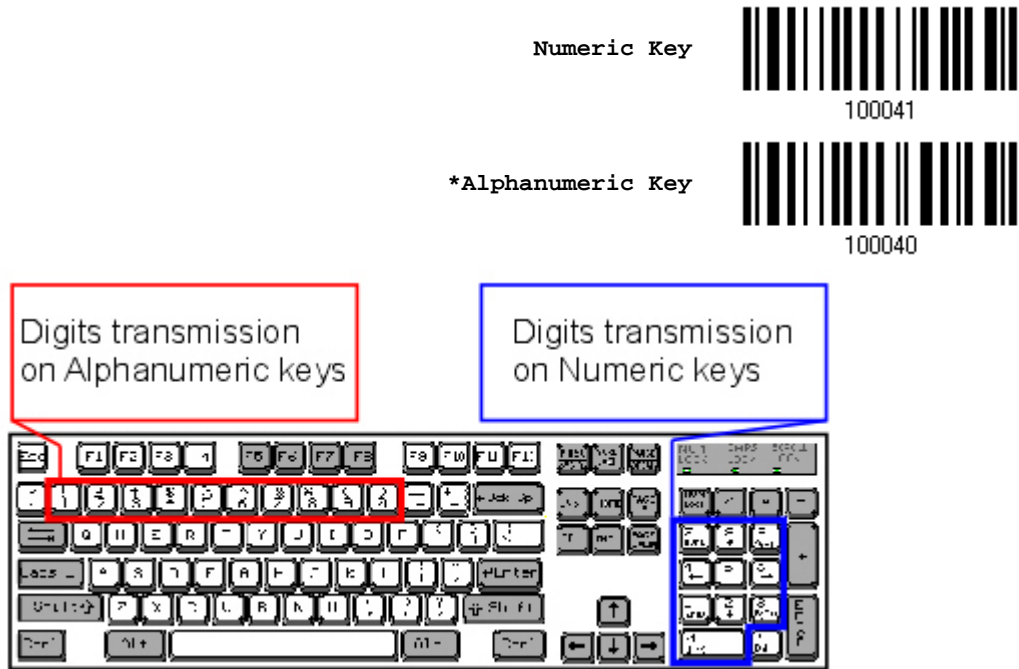

Note: If you select "Numeric Keypad", the Num Lock status of the physical keyboard should be "ON".

Kanji Transmission

Kanji Transmission is supported by the scanner when either Bluetooth HID, Keyboard Wedge via 3656 or USB HID via 3656 is selected for the output interface. By Kanji Transmission, when the host computer is running on Japanese Windows O.S., the scanner is able to transmit Japanese characters including the Chinese characters used in modern Japanese writing system.

Kanji Transmission is disabled by default. Enable/disable scanner's Kanji Transmission by reading the following barcodes:



2.6.3 INTER-CHARACTER DELAY

By default, the inter-character delay is set to zero. Specify a value, ranging from 0 to 254 in units of millisecond, to match the computer response time of the keyboard interface. Such delay time is inserted between every character being transmitted. The longer the delay time is, the slower the transmission speed will be.

Inter-Character
Delay... (*0~254)



- 1) Read the barcode above to specify the inter-character delay.
- 2) Read the "Decimal Value" barcode on page 267 for the desired inter-character delay (millisecond).
- 3) Read the "Validate" barcode on the same page to complete this setting.

2.6.4 INTER-FUNCTION DELAY

By default, the inter-function delay is set to zero. Specify a value, ranging from 0 to 254 in units of millisecond, to match the computer response time of the keyboard interface. Such delay time is inserted between every function code (0x01 ~ 0x1F) being transmitted. The longer the delay time is, the slower the transmission speed will be.

Inter-Function
Delay... (*0~254)



- 1) Read the barcode above to specify the inter-function delay.
- 2) Read the "Decimal Value" barcode on page 267 for the desired inter-function delay (millisecond).
- 3) Read the "Validate" barcode on the same page to complete this setting.



2.6.5 HID CHARACTER TRANSMIT MODE

By default, HID interface sends data to the host in batch. You may have the scanner read the "By Character" barcode to process data one character at a time.

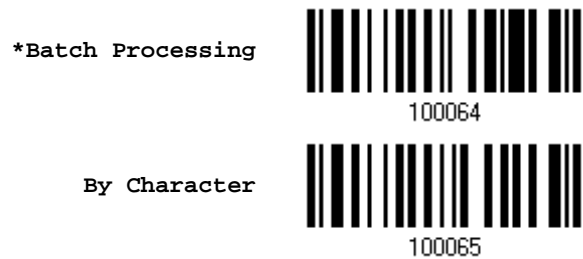

2.6.6 SPECIAL KEYBOARD FEATURE

By default, this interface employs special function codes (0x01 ~ 0x1F) defined in the Keyboard Wedge Table. However, users may want to get rid of these special codes within the barcodes to avoid data error. You can decide whether to apply the special keyboard feature. For further details please refer to [Keyboard Wedge Table](#).



2.7 USB VIRTUAL COM VIA 3656

Use the USB cable to connect the scanner via 3656 to the USB port of PC and connect the power supply cord. You may run HyperTerminal.exe on your computer, and the scanned data will be transmitted to the computer.

Warning: When the 3656 stand is solely on USB power, the current may be insufficient for it to function normally. You must connect the power supply cord.

Note: If you are using USB Virtual COM for the first time, you must install its driver from the CD-ROM. Driver version 5.3 or later is required. Please remove older versions!

2.7.1 ACTIVATE USB VIRTUAL COM

Activate 3656
USB Virtual COM



2.7.2 INTER-FUNCTION DELAY

By default, the inter-function delay is set to zero. Specify a value, ranging from 0 to 254 in units of millisecond, to match the computer response time of the keyboard interface. Such delay time is inserted between every function code (0x01 ~ 0x1F) being transmitted. The longer the delay time is, the slower the transmission speed will be.

Inter-Function
Delay... (*0~254)



- 1) Read the barcode above to specify the inter-function delay.
- 2) Read the "Decimal Value" barcode on page 267 for the desired inter-function delay (millisecond).
- 3) Read the "Validate" barcode on the same page to complete this setting.



2.7.3 ACK/NAK TIMEOUT

By default, the scanner sends data to the host without waiting for an ACK/NAK response before sending more data. Specify a value, ranging from 1 to 99 in units of 0.1 second. If no response within the specified period of time, the scanner will attempt to send the same data two more times. If all three attempts fail without any notification, data loss will occur.

ACK/NAK Time-out
after ... (*0~99)



100013

- 1) Read the barcode above to specify the time interval for the scanner to send data and wait for a response from the host.
- 2) Read the "Decimal Value" barcode on page 267. For example, read "1" and "0" for the scanner to automatically shut down after being idle for 1 second.
- 3) Read the "Validate" barcode on the same page to complete this setting.

ACK/NAK Error Beep

Enable Error Beep



100015

*Disable Error Beep



100014

Note: We suggest enabling the error beep so that you will be notified of such data loss and have the scanner re-read data.





Chapter 3

SETTING UP A WPAN CONNECTION

The 1564A scanner can be configured to send data to a host computer wirelessly via the 3656 stand, or to a notebook computer or PDA with *Bluetooth*[®] wireless technology. Upon powering up, the scanner will be ready for establishing a WPAN connection.

To establish a connection via 3656 after reading "Set Connection" and "Serial No." labels ...



Interface Option	Reference
Keyboard Wedge	2.4 Keyboard Wedge via 3656
RS-232	2.5 RS-232 via 3656
USB HID	2.6 USB HID via 3656
USB Virtual COM	2.7 USB Virtual COM via 3656

To establish a connection via *Bluetooth*[®] dongle after pairing...



Interface Option	Reference
BT HID	2.1 BT HID
BT SPP	2.2 BT SPP Slave , 2.3 BT SPP Master

IN THIS CHAPTER

3.1 Connecting via 3656	102
3.2 Connecting via <i>Bluetooth</i> [®] Dongle	105



3.1 CONNECTING VIA 3656

By default, the interface of 3656 is set to “USB HID”. Use the interface cable to connect the scanner via 3656 to PC. You can have up to seven scanners connected to one computer at the same time.

Note: If you are using USB Virtual COM for the first time, you must install its driver from the CD-ROM. Driver version 5.3 or later is required. Please remove older versions!

3.1.1 CONNECT TO 3656

You can connect any scanner to 3656 by having the scanner read the two labels at the back of 3656. The scanner will respond with one beep upon reading each of the labels.

- ▶ “Set Connection” label
- ▶ “Serial Number” label

After reading these labels, the scanner will stay active for a specified period of time (2 minutes by default) trying to connect to the 3656 stand while its LED is flashing blue (On/Off ratio 0.5 s: 0.5 s). Once connected, the scanner will respond with three beeps (tone ascending from low to high), and the LED becomes flashing blue (On/Off ratio 0.02 s: 3 s). When getting out of range, the scanner will respond with three short beeps (tone descending from high to low).

Read the “Set Connection” label first, and then the “Serial Number” label. If the “Set Connection” label on 3656 is illegible, try this one —

Set Connection



88686471166254

Note: The 3656 settings will overwrite the interface-related settings on the scanners that are currently connected to 3656.

Users can also scan a single 2D barcode that combines the “Set Connection” and “Serial Number” setup barcodes to connect to 3656. The example below is a 2D barcode containing codes ‘#@CipherLab’, ‘88686471166254’ (Set Connection) and ‘BN1008213’ (Serial Number of 3656). Underlining the digits is to make them more readable.

#@CipherLab88686471166254BN1008213



2D One-Scan Setup Barcode for connecting to 3656



Command	Purpose
#@CipherLab	Enter setup
88686471166254	Set connection
BN1008213	Serial number of 3656



3.1.2 CHANGE INTERFACE

If you want to change the interface cable of 3656, use one of the scanners to configure the interface-related settings and it will pass the new settings to 3656, which will then initialize and pass the settings to any other connected scanners.

- 1) Have the scanner read the "Set Connection" and "Serial Number" labels at the back of 3656.
- 2) Within two minutes, connect the interface cable between 3656 and your computer. For USB Virtual COM, you may need to install its driver first!
- 3) The scanners will connect to your computer via 3656.
- 4) Have one scanner read the "Enter Setup" barcode to enter the configuration mode.
- 5) Have the scanner read the desired interface barcode and configure its related settings –
 - ▶ "Activate Keyboard Wedge & Select Keyboard Type"
 - ▶ "Activate RS-232"
 - ▶ "Activate USB HID & Select Keyboard Type"
 - ▶ "Activate USB Virtual COM"
- 6) Have the scanner read the "Update" barcode to exit the configuration mode.
- 7) After the scanner resumes connection with 3656, it will pass the interface-related settings to 3656.
- 8) Upon receipt of the new settings, 3656 will initialize itself.
- 9) Updated with new settings, 3656 will pass the settings to other connected scanners.

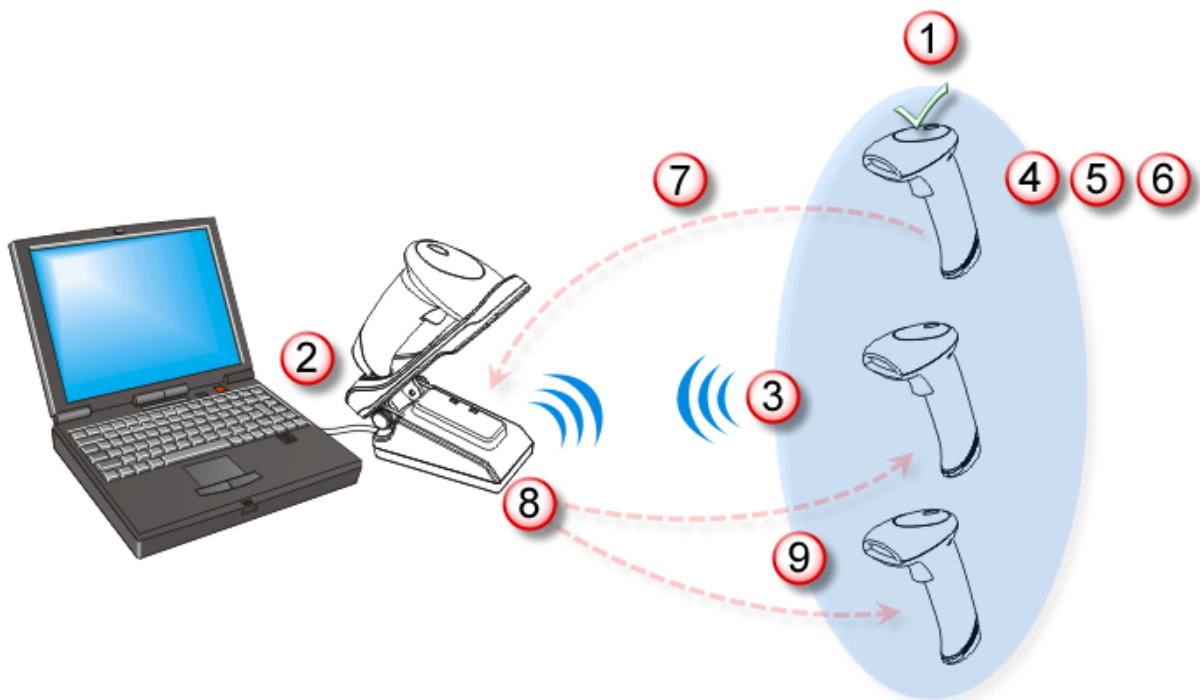

3.2 CONNECTING VIA *BLUETOOTH*[®] DONGLE

3.2.1 CHANGE INTERFACE

Below is the procedure to configure the scanner before establishing a WPAN connection via *Bluetooth*[®] dongle.

- 1) Have the scanner read the "Enter Setup" barcode to enter the configuration mode.
- 2) Have the scanner read the desired interface barcode –
 - ▶ "Activate BT HID & Select Keyboard Type"
 - ▶ "Activate BT SPP Slave Mode"
 - ▶ "Activate BT SPP Master Mode"
- 3) Have the scanner read the barcodes related to WPAN settings, such as Device Name Broadcasting, Authentication & PIN Code, etc.
- 4) Have the scanner read the "Update" barcode to exit the configuration mode.
- 5) The scanner will stay active for a specified period of time (2 minutes by default) waiting for a connection request from the host (SPP Slave Mode) or trying to connect to the host (HID or SPP Master Mode). Its CPU is running at full speed, and the LED is flashing blue (On/Off ratio 0.5 s: 0.5 s).

Once connected, when getting out of range, the scanner will respond with three short beeps (tone descending from high to low).



3.2.2 CONFIGURE RELATED SETTINGS

Sniff Mode (Power-saving)

By default, this feature is enabled, meaning the scanner will listen to the wireless network at a reduced rate.

***Enable**



Disable



Note: When connecting more than two scanners to a notebook computer or PDA with *Bluetooth*[®] wireless technology, we suggest that you disable the power-saving setting for a more reliable connection.

Device Name Broadcasting

The scanner can be configured to hide itself from other devices equipped with *Bluetooth*[®] wireless technology. Simply disable the device name broadcasting setting so that it won't be discovered by any other computer or PDA. However, broadcasting must be enabled for establishing an initial connection with the scanner. For example, you can disable device name broadcasting after successfully connecting the scanner to WorkStation1. Such connection will be maintained automatically unless the scanner is removed from the paired device list (called unpairing) by WorkStation1 or any changes made to authentication and the PIN code. If you want WorkStation2 to connect to the scanner, you will have to enable device name broadcasting first.

***Enable**



Disable



Note: By default, device name broadcasting is enabled (which is required for initial connection).

Changing Device Name

By default, the device name (local hostname) combines the model name with serial number (for example, 1564ABH3000001). Users are allowed to configure the device name with length up to 13 bytes.

**Change Bluetooth
Local Hostname**



- 1) Read the barcode above to configure the device name.
- 2) Read the "Hexadecimal Value" barcode on page 268 for the desired character string.
- 3) Read the "Validate" barcode to complete this setting.



Authentication

When any changes are made to authentication and PIN code on the scanner side, you will have to remove the scanner from the paired device list (called unpairing) and go through the whole process to re-establish the connection.

The scanner allows up to 16 characters for a PIN code and provides two options for authentication:

Enable Authentication with Preset PIN

Have the scanner read the "Use preset PIN" barcode, and change the preset PIN if necessary. This means you will have to enter exactly the same string for your computer or PDA to connect to the scanner. If the PIN or passkey is incorrect, any connection attempt will be turned down by the scanner. See step 8 in [3.2.3 Connect to Dongle](#).

1. Read the "Use preset PIN" barcode to enable authentication with a preset PIN.



2. Read one of the barcodes to specify the PIN code, in decimal or hexadecimal.

By default, the PIN code is set to "0000". Maximum 16 characters are allowed.



3. Read the "[Decimal Value](#)" barcode on page 267 or the "[Hexadecimal Value](#)" barcode on page 268 for the desired digits or character string.

Read the "Clear PIN Code" barcode first if you need to re-input the PIN code.



4. Read the "Validate" barcode to complete this setting.

Enable Authentication with Random PIN or No Authentication

By default, it is set to "No PIN or use random PIN", which depends on the setting of the target device. (No PIN = No authentication.)



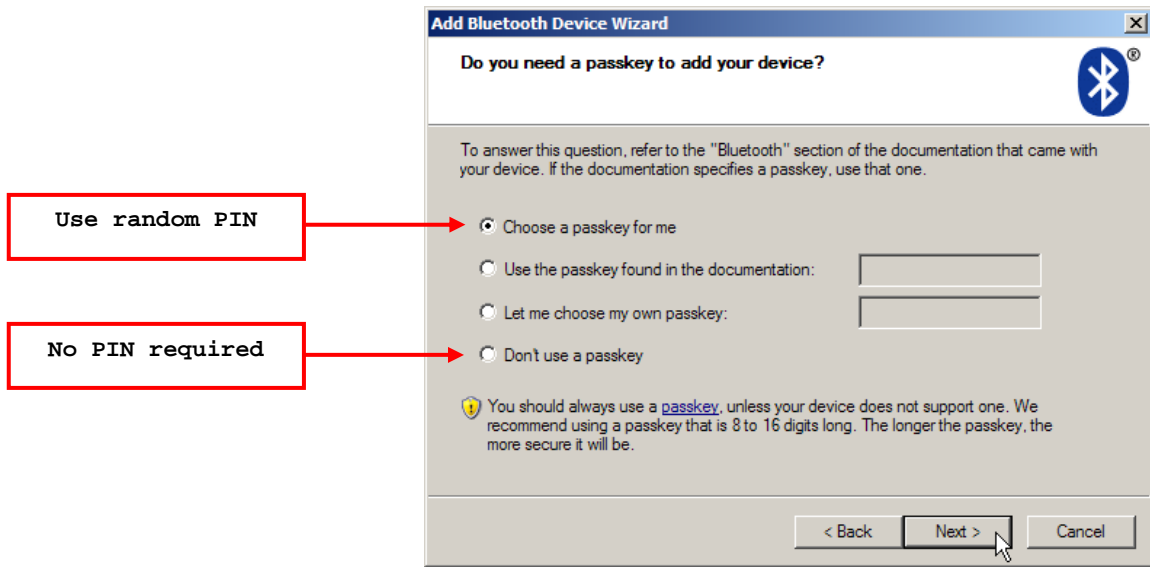

Note: When using BT HID, some device driver may not support pre-defined PIN code for authentication. In this case, make sure you have the scanner set to “No PIN or use random PIN” before pairing. While pairing, the host PIN code will be displayed on the computer screen. Have the scanner read the setup barcode “Enter PIN Code in Decimal” or “Enter PIN Code in Hexadecimal” to input the matching PIN code. Refer to [Disable Authentication or Use Random PIN](#).

Secure Simple Pairing (SSP)

Secure Simple Pairing (SSP), introduced in *Bluetooth*[®] Core Specification 2.1 + EDR, is a new feature designed to ease the pairing process while keeping up the communication security level. This function is disabled by default.

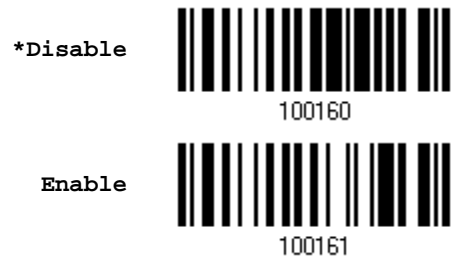

3.2.3 CONNECT TO DONGLE

The procedure goes through associating devices for establishing a WPAN connection, which is pretty much the same except for the software you are using. If your computer is running Microsoft® Windows® XP Service Pack 3 (SP3) or Windows Vista® Service Pack 1 (SP1), you can use the software support that Windows® includes, or you can use the driver that the device manufacturer provides. Now, let's try using the software support that Windows® XP Service Pack 2 includes.

BT HID Procedure

By default, BT HID is activated on the scanner, and the keyboard type is set to PCAT (US). When BT HID is re-activated, you will have to select a keyboard type to complete this setting.

The procedure is the same as for BT SPP. Refer to steps 1~11 below.

BT SPP Procedure

1. Turn on the *Bluetooth*® function on your computer, running Windows XP SP2.
2. Double-click the *Bluetooth*® icon from the lower right of the taskbar.  Alternatively, you may go to **Control Panel > Bluetooth Devices**.
3. Click [Add] to search devices nearby.



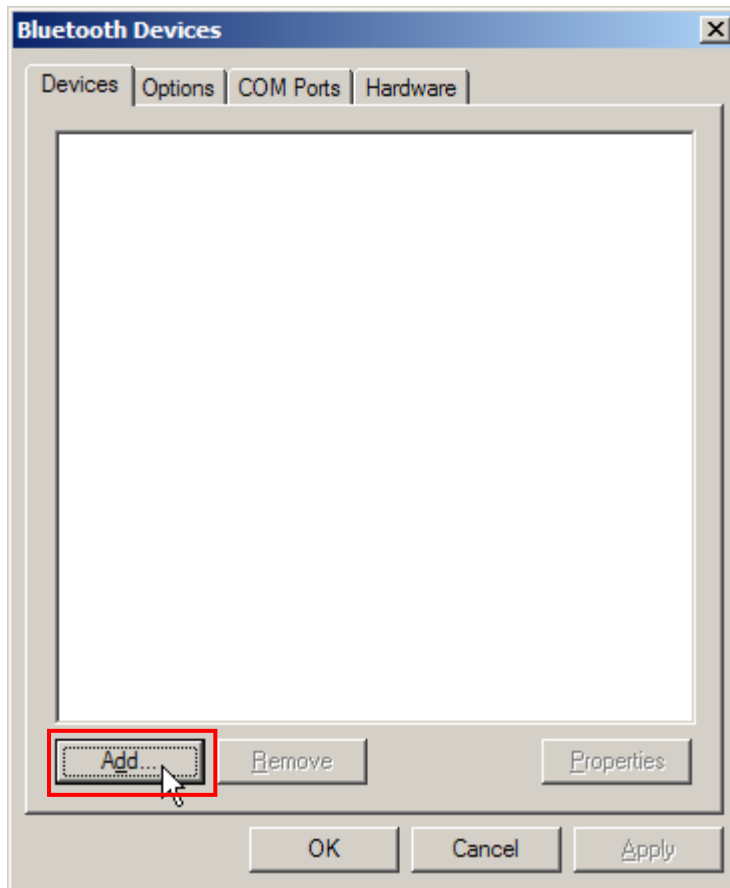

4. Turn on the scanner with correct WPAN settings, such as select BT SPP or BT HID, broadcasting enabled, authentication enabled, and PIN code specified, etc. Select the check box of [My device is set up and ready to be found] on your computer.
5. Click [Next].





6. Wait for a few seconds for the Wizard to search available devices nearby.

The scanner will appear with its “serial number” as the device name. You may double-check the “Serial Number” label on the scanner to ensure connecting with the correct scanner. Select the target scanner. If the target scanner does not appear on the list, click [Search Again] to refresh the list. The scanner might enter Suspend Mode now, and you can press the trigger to have it active again (=discoverable). It will then stay active for a specified period of time (2 minutes by default) and wait for PC to establish a connection.



7. Click [Next].

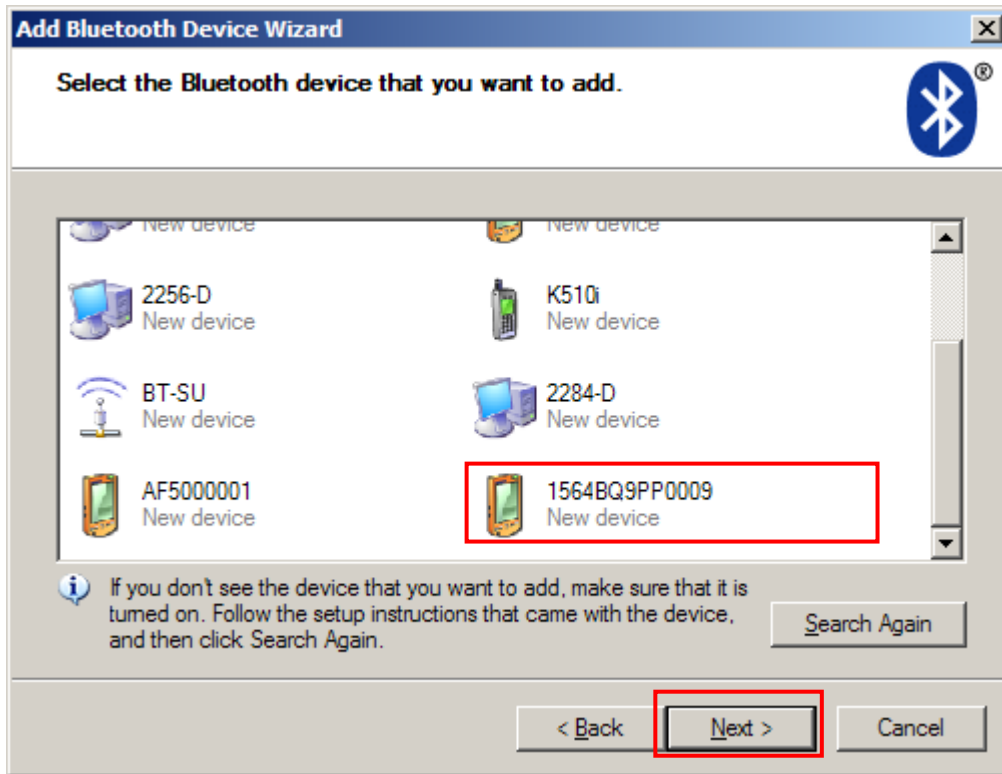

8. Enter the passkey for authentication, which must be exactly the same as configured for the scanner.



9. Click [Next]. Wait for a few seconds for Windows to exchange passkeys.

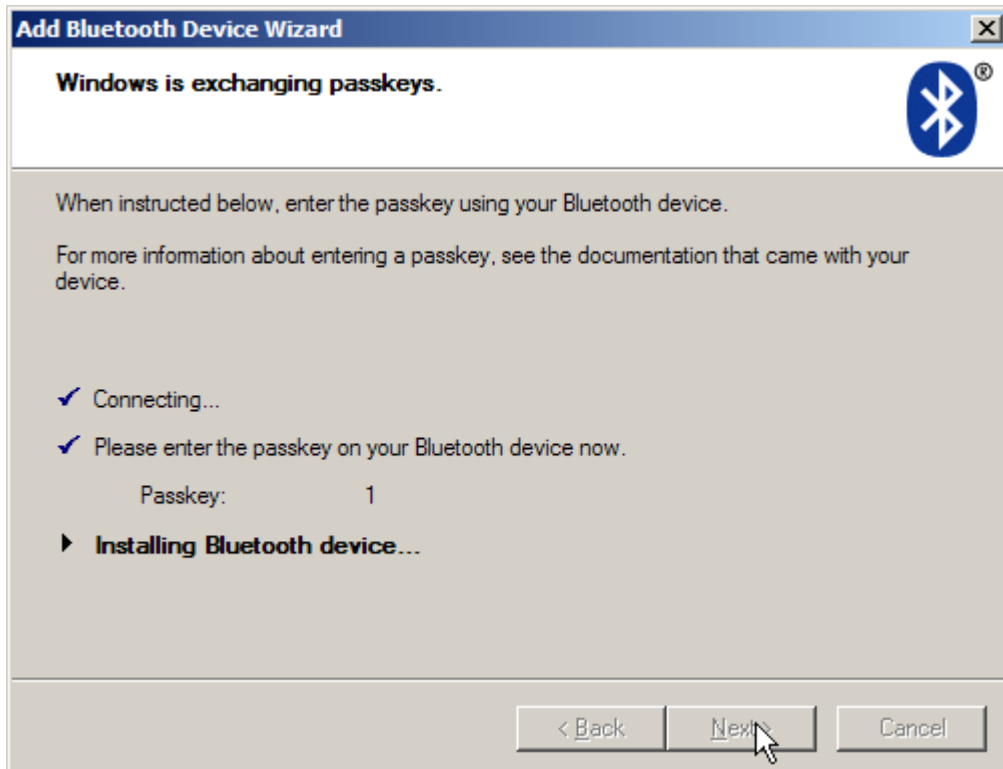
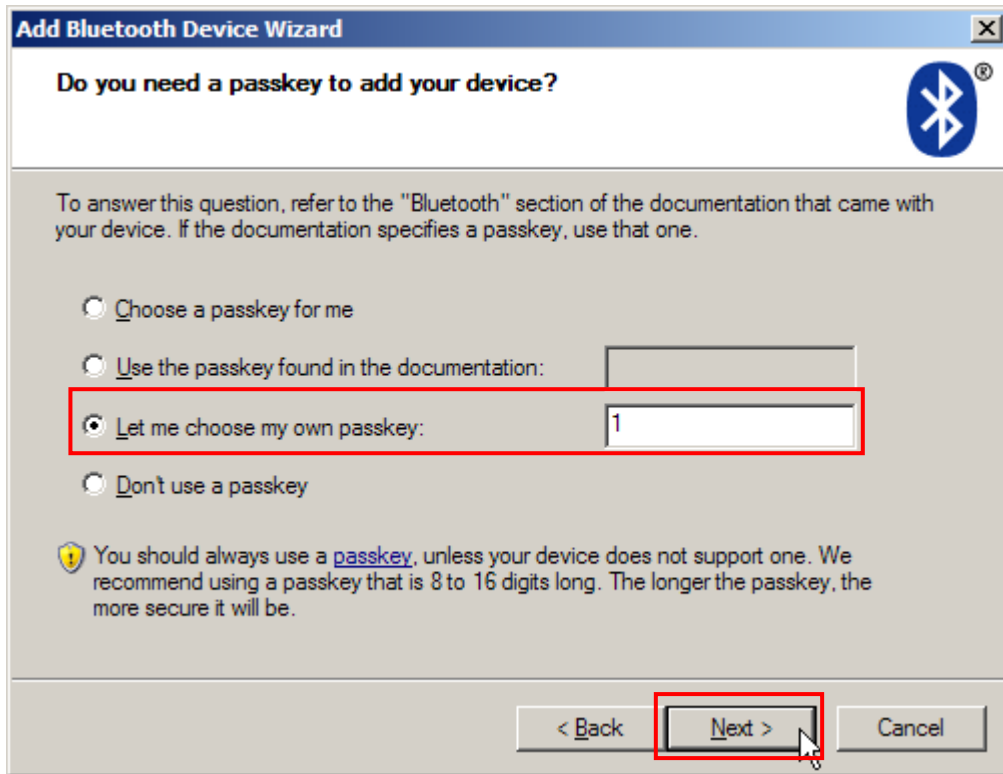

Note: When Bluetooth security is enabled without providing a pre-set PIN code, dynamic input of PIN code is supported.

10. Click [Finish].

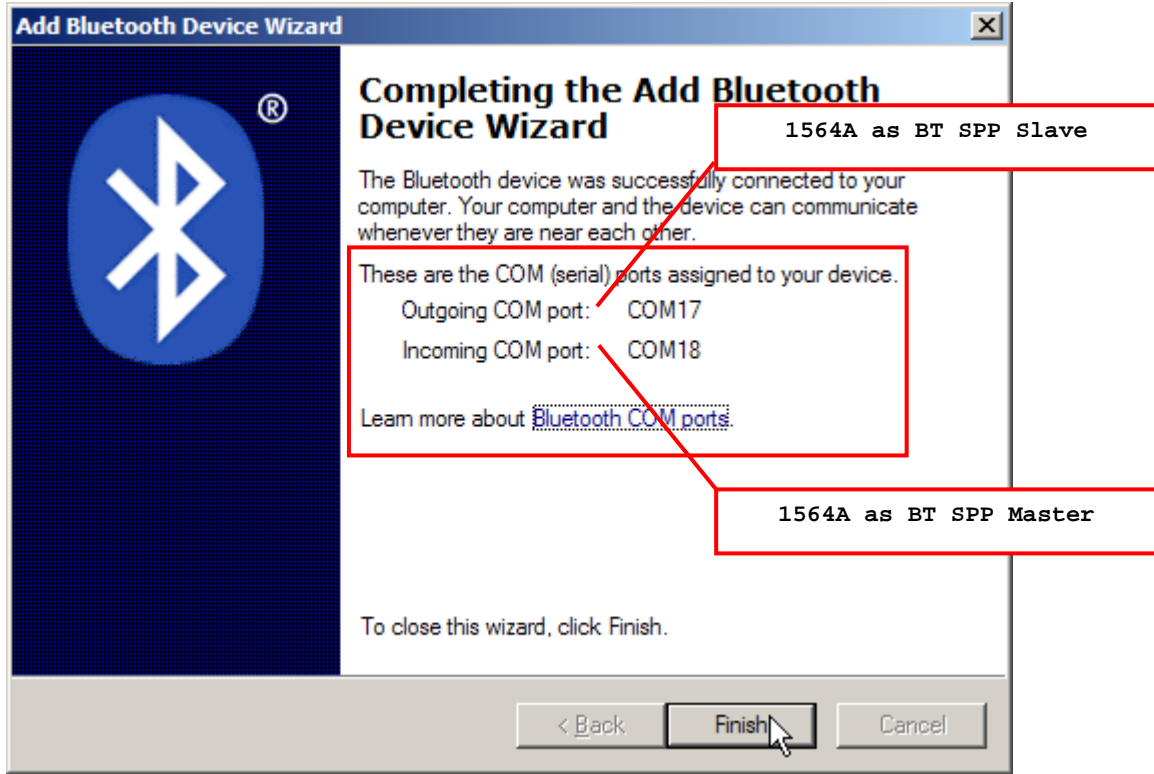

11. Now the target scanner will be listed as shown below.

You can have up to seven scanners connected to one computer at the same time.

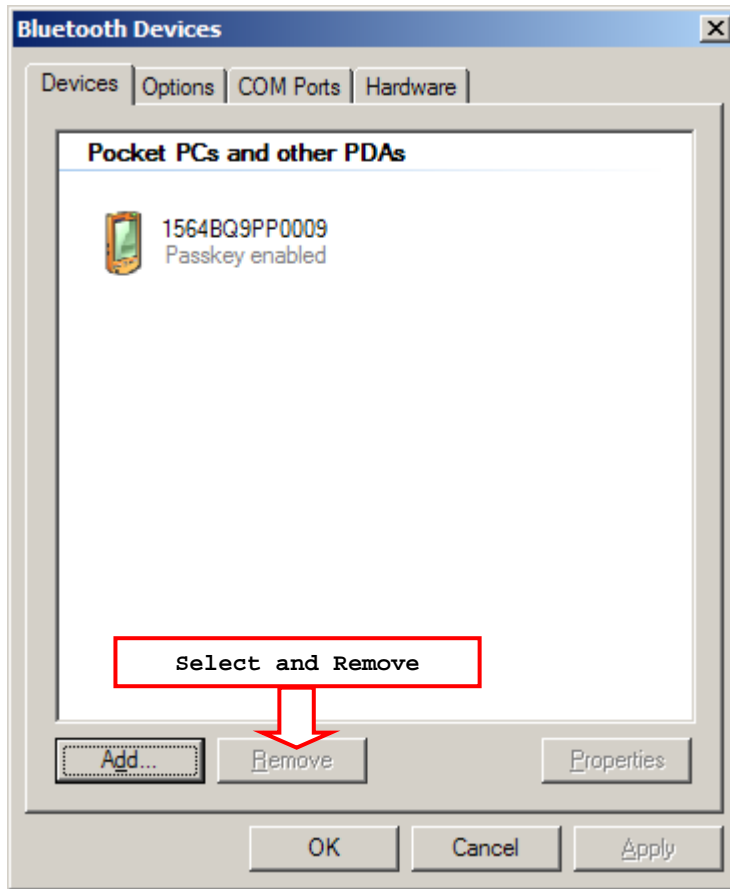

Note: When any changes are made to authentication and PIN code on the scanner side, or you want to change to use BT HID, it is suggested that you remove the scanner from the paired device list (called unpairing) and go through the whole process to re-establish the connection.

12. Run the desired application on your computer, such as HyperTerminal.exe if using BT SPP or Notepad.exe if using BT HID.

The status of the scanner listed on the device list will be updated to "Connected", indicating the WPAN connection is established successfully via the outgoing COM port if using BT SPP.

Note: Even though the scanner is connected to the host with authentication disabled (= no PIN code required), the host may still request a PIN code while the application is opening COM port. Dynamic input of PIN code is supported so that you may input a matching PIN code on the scanner. Refer to [Disable Authentication or Use Random PIN](#).



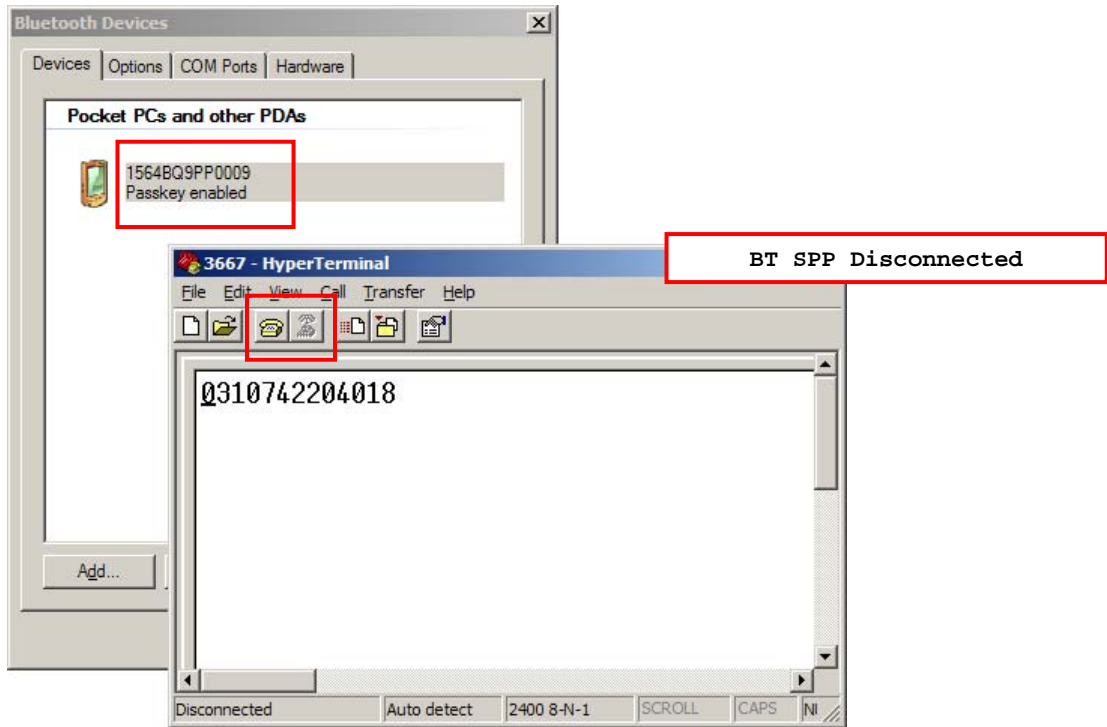
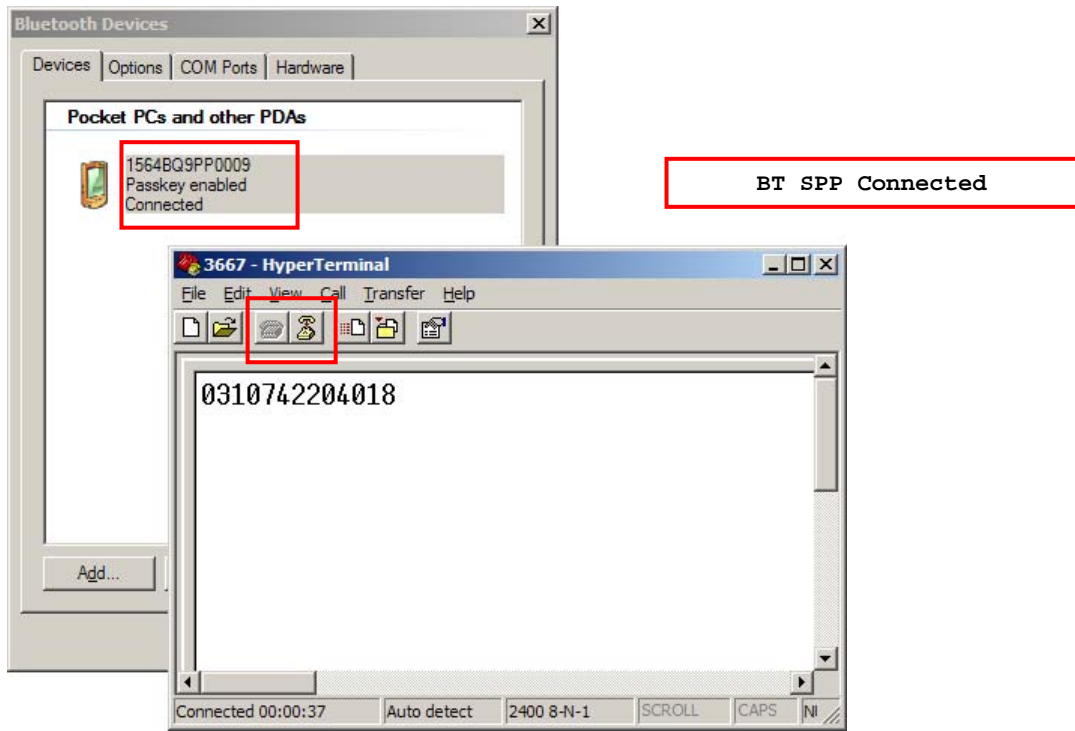



CHANGING SYMBOLOGY SETTINGS

In this chapter, a brief on the symbology settings is provided for your reference.

IN THIS CHAPTER

4.1 Codabar	120
4.2 Code 25 – Industrial 25	122
4.3 Code 25 – Interleaved 25.....	124
4.4 Code 25 – Matrix 25.....	127
4.5 Code 25 – Chinese 25	129
4.6 Italian Pharmacode (Code 32)	130
4.7 Code 39	131
4.8 Trioptic Code 39	134
4.9 Code 93	135
4.10 Code 128.....	137
4.11 GS1-128 (EAN-128)	138
4.12 ISBT 128	140
4.13 GS1 DataBar (RSS Family)	142
4.14 MSI.....	148
4.15 EAN-8	150
4.16 EAN-13.....	151
4.17 UCC Coupon Extended Code	153
4.18 UPC-A	154
4.19 UPC-E	156
4.20 Code 11.....	159
4.21 Composite Code.....	161
4.22 US Postal Code	165
4.23 UK Postal Code	166
4.24 More Postal Code	167
4.25 2D Symbologies.....	169
4.26 Macro PDF	172



4.1 CODABAR

***Enable**



100313

Disable



100312

4.1.1 START/STOP TRANSMISSION

Decide whether to include the start/stop characters in the data being transmitted.

**Transmit Start/Stop
Characters**



100441

***Do Not Transmit**



100440

4.1.2 CLSI CONVERSION

When enabled, the CLSI editing strips the start/stop characters and inserts a space after the first, fifth, and tenth characters of a 14-character Codabar barcode.

Apply CLSI Editing



100443

***Do Not Apply**



100442

Note: The 14-character barcode length does not include start/stop characters.



4.1.3 CODE LENGTH QUALIFICATION

To prevent the "short scan" error, define the "Length Qualification" settings to ensure that the correct barcode is read by qualifying the allowable code length.

- ▶ If "Max/Min Length" is selected, the maximum length and the minimum length must be specified. It only accepts those barcodes with lengths that fall between max/min lengths specified.
- ▶ If "Fixed Length" is selected, up to 2 fixed lengths can be specified.

Note: The specified length(s) must include the check digit(s) the barcode contains.

- 1) Read the barcode to enable either Max. /Min. Length qualification or Fixed Length(s) qualification.

***Enable Max./Min.
Length (1~55)...**



**Enable Fixed
Length(s)...**



- 2) Read the barcode for Max. Length or Fixed Length 1, and follow steps 3~4.
Repeat steps 2~4 for Min. Length or Fixed Length 2.

**Max. Length (*55) or
Fixed Length 1**



**Min. Length (*4) or
Fixed Length 2**



- 3) Read the "Decimal Value" barcode on page 267 for the desired length.
- 4) Read the "Validate" barcode on the same page to complete this setting.



4.2 CODE 25 - INDUSTRIAL 25

***Enable**



100307

Disable



100306



4.2.1 CODE LENGTH QUALIFICATION

To prevent the "short scan" error, define the "Length Qualification" settings to ensure that the correct barcode is read by qualifying the allowable code length.

- ▶ If "Max/Min Length" is selected, the maximum length and the minimum length must be specified. It only accepts those barcodes with lengths that fall between max/min lengths specified.
- ▶ If "Fixed Length" is selected, up to 2 fixed lengths can be specified.

Note: The specified length(s) must include the check digit(s) the barcode contains.

- 1) Read the barcode to enable either Max. /Min. Length qualification or Fixed Length(s) qualification.

*Enable Max./Min.
Length (1~55)...



100601

Enable Fixed
Length(s)...



100600

- 2) Read the barcode for Max. Length or Fixed Length 1, and follow steps 3~4.
Repeat steps 2~4 for Min. Length or Fixed Length 2.

Max. Length (*55) or
Fixed Length 1



100602

Min. Length (*4) or
Fixed Length 2



100603

- 3) Read the "Decimal Value" barcode on page 267 for the desired length.
- 4) Read the "Validate" barcode on the same page to complete this setting.



4.3 CODE 25 - INTERLEAVED 25

***Enable**



100309

Disable



100308

4.3.1 VERIFY CHECK DIGIT

Decide whether to verify the check digit. When desired, select one of the algorithms, USS or OPCC. If incorrect, the barcode will not be accepted.

***Do Not Verify**



102122

USS Check Digit



102123

OPCC Check Digit



102124

4.3.2 TRANSMIT CHECK DIGIT

Decide whether to include the check digit in the data being transmitted.

***Transmit
Interleaved 25
Check Digit**



100431

Do Not Transmit



100430



4.3.3 CONVERT TO EAN-13

Decide whether to convert a 14-character barcode into EAN-13 if the following requirements are met:

- ▶ The barcode must have a leading 0 and a valid EAN-13 check digit.
- ▶ "Verify Check Digit" must be disabled.

Convert to EAN-13



102101

*Do Not Convert



102100



4.3.4 CODE LENGTH QUALIFICATION

To prevent the "short scan" error, define the "Length Qualification" settings to ensure that the correct barcode is read by qualifying the allowable code length.

- ▶ If "Max/Min Length" is selected, the maximum length and the minimum length must be specified. It only accepts those barcodes with lengths that fall between max/min lengths specified.
- ▶ If "Fixed Length" is selected, up to 2 fixed lengths can be specified.

Note: The specified length(s) must include the check digit(s) the barcode contains.

- 1) Read the barcode to enable either Max. /Min. Length qualification or Fixed Length(s) qualification.

***Enable Max./Min.
Length (1~55)...**



100605

**Enable Fixed
Length(s)...**



100604

- 2) Read the barcode for Max. Length or Fixed Length 1, and follow steps 3~4.
Repeat steps 2~4 for Min. Length or Fixed Length 2.

**Max. Length (*55) or
Fixed Length 1**



100606

**Min. Length (*4) or
Fixed Length 2**



100607

- 3) Read the "Decimal Value" barcode on page 267 for the desired length.
- 4) Read the "Validate" barcode on the same page to complete this setting.



4.4 CODE 25 - MATRIX 25

Enable



100311

*Disable



100310

4.4.1 VERIFY CHECK DIGIT

Decide whether to verify the check digit. If incorrect, the barcode will not be accepted.

Verify Matrix 25
Check Digit



100433

*Do Not Verify



100432

4.4.2 TRANSMIT CHECK DIGIT

Decide whether to include the check digit in the data being transmitted.

*Transmit Matrix 25
Check Digit



100435

Do Not Transmit



100434



4.4.3 CODE LENGTH QUALIFICATION

To prevent the "short scan" error, define the "Length Qualification" settings to ensure that the correct barcode is read by qualifying the allowable code length.

- ▶ If "Max/Min Length" is selected, the maximum length and the minimum length must be specified. It only accepts those barcodes with lengths that fall between max/min lengths specified.
- ▶ If "Fixed Length" is selected, up to 2 fixed lengths can be specified.

Note: The specified length(s) must include the check digit(s) the barcode contains.

- 1) Read the barcode to enable either Max. /Min. Length qualification or Fixed Length(s) qualification.

***Enable Max./Min.
Length (1~55)...**



100609

**Enable Fixed
Length(s)...**



100608

- 2) Read the barcode for Max. Length or Fixed Length 1, and follow steps 3~4.
Repeat steps 2~4 for Min. Length or Fixed Length 2.

**Max. Length (*55) or
Fixed Length 1**



100610

**Min. Length (*4) or
Fixed Length 2**



100611

- 3) Read the "Decimal Value" barcode on page 267 for the desired length.
- 4) Read the "Validate" barcode on the same page to complete this setting.



4.5 CODE 25 - CHINESE 25

Enable



102015

*Disable



102014



4.6 ITALIAN PHARMACODE (CODE 32)

Enable



100303

*Disable



100302

Note: Code 39 must be enabled first.



4.7 CODE 39

***Enable**



100301

Disable



100300

4.7.1 VERIFY CHECK DIGIT

Decide whether to verify the check digit. If incorrect, the barcode will not be accepted.

**Verify Code 39
Check Digit**



100405

***Do Not Verify**



100404

4.7.2 TRANSMIT CHECK DIGIT

Decide whether to include the check digit in the data being transmitted.

***Transmit Code 39
Check Digit**



100407

Do Not Transmit



100406



Update

4.7.3 STANDARD/FULL ASCII CODE 39

Decide whether to support Code 39 Full ASCII that includes all the alphanumeric and special characters.

Code 39 Full ASCII



*Standard Code 39



Note: Trioptic Code 39 and Code 39 Full ASCII cannot be enabled at the same time.



4.7.4 CODE LENGTH QUALIFICATION

To prevent the "short scan" error, define the "Length Qualification" settings to ensure that the correct barcode is read by qualifying the allowable code length.

- ▶ If "Max/Min Length" is selected, the maximum length and the minimum length must be specified. It only accepts those barcodes with lengths that fall between max/min lengths specified.
- ▶ If "Fixed Length" is selected, up to 2 fixed lengths can be specified.

Note: The specified length(s) must include the check digit(s) the barcode contains.

- 1) Read the barcode to enable either Max. /Min. Length qualification or Fixed Length(s) qualification.

***Enable Max./Min.
Length (1~55)...**



102218

**Enable Fixed
Length(s)...**



102217

- 2) Read the barcode for Max. Length or Fixed Length 1, and follow steps 3~4.
Repeat steps 2~4 for Min. Length or Fixed Length 2.

**Max. Length (*55) or
Fixed Length 1**



102219

**Min. Length (*4) or
Fixed Length 2**



102220

- 3) Read the "Decimal Value" barcode on page 267 for the desired length.
- 4) Read the "Validate" barcode on the same page to complete this setting.



4.8 TRIOPTIC CODE 39

Decide whether to decode Trioptic Code 39.

- ▶ Trioptic Code 39 is a variant of Code 39 used in the marking of computer tap cartridges. It always contains six characters.



Note: Trioptic Code 39 and Code 39 Full ASCII cannot be enabled at the same time.



4.9 CODE 93

***Enable**



100315

Disable



100314



Update

4.9.1 CODE LENGTH QUALIFICATION

To prevent the "short scan" error, define the "Length Qualification" settings to ensure that the correct barcode is read by qualifying the allowable code length.

- ▶ If "Max/Min Length" is selected, the maximum length and the minimum length must be specified. It only accepts those barcodes with lengths that fall between max/min lengths specified.
- ▶ If "Fixed Length" is selected, up to 2 fixed lengths can be specified.

Note: The specified length(s) must include the check digit(s) the barcode contains.

- 1) Read the barcode to enable either Max. /Min. Length qualification or Fixed Length(s) qualification.

***Enable Max./Min.
Length (1~55)...**



102226

**Enable Fixed
Length(s)...**



102225

- 2) Read the barcode for Max. Length or Fixed Length 1, and follow steps 3~4.
Repeat steps 2~4 for Min. Length or Fixed Length 2.

**Max. Length (*55) or
Fixed Length 1**



102227

**Min. Length (*4) or
Fixed Length 2**



102228

- 3) Read the "Decimal Value" barcode on page 267 for the desired length.
- 4) Read the "Validate" barcode on the same page to complete this setting.



4.10 CODE 128

***Enable**



100317

Disable



100316



Update

4.11 GS1-128 (EAN-128)

***Enable**



100319

Disable



100318

Note: GS1-128 barcodes can be decoded only when this setting is enabled.

4.11.1 TRANSMIT CODE ID

Decide whether to include the Code ID (“1c1”) in the data being transmitted.

**Transmit GS1-128
Code ID**



100519

***Do Not Transmit**



100518

4.11.2 FIELD SEPARATOR (GS CHARACTER)

Decide whether to apply a field separator (to convert the FNC1 control character to human readable character).

**Enable Field
Separator...**



100616

- 1) Read the barcode above to enable field separator.
- 2) Read the “[Hexadecimal Value](#)” barcode on page 268 for the desired character string.
- 3) Read the “Validate” barcode to complete this setting.

Note: GS1-128 barcodes start with the FNC1 control character to distinguish themselves from other uses of Code 128. FNC1 is also used to separate data fields in the GS1-128 barcodes.



4.11.3 GS1 FORMATTING

Decide whether to enable GS1 formatting for GS1-128. When enabled, code ID transmitting will be disabled; however, the field separator and application ID mark characters will be automatically added to the output data.

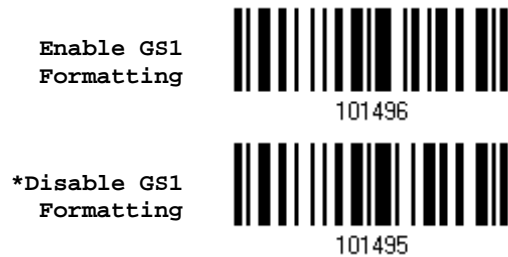

You may want to add an application ID mark (1 character long) to the left (AIMark1) or right (AIMark2) of an application ID (AI) for the purpose of labeling it when formatting the GS1 data.



- 1) Read the barcode above to add a mark to the left (AIMark1)/right (AIMark2) of an application ID.
- 2) Read the "[Hexadecimal Value](#)" barcode on page 268 for the desired character. Read '00' if you want to remove the AI mark.
- 3) Read the "Validate" barcode to complete this setting.



4.12 ISBT 128

***Enable**



100355

Disable



100354

4.12.1 ISBT CONCATENATION

Decide whether to decode and concatenate pairs of ISBT barcodes.

▶ **Disable ISBT Concatenation**

It will not concatenate pairs of ISBT barcodes it encounters.

▶ **Enable ISBT Concatenation**

There must be two ISBT barcodes in order for the scanner to decode and perform concatenation. It does not decode single ISBT barcodes.

▶ **Auto-discriminate ISBT Concatenation**

It decodes and concatenates pairs of ISBT barcodes immediately. If only a single ISBT barcode is present, the scanner must decode 10 times before transmitting its data to confirm that there is no additional ISBT barcode.

Disable



102237

Enable



102238

***Auto-discriminate**



102239



4.12.2 ISBT CONCATENATION REDUNDANCY

Specify the concatenation redundancy (2~20 times) when ISBT concatenation is enabled.

ISBT Concatenation
Redundancy 2~20
(*10)



- 1) Read the barcode above to specify the concatenation redundancy.
- 2) Read the "Decimal Value" barcode on page 267 for the desired redundancy.
- 3) Read the "Validate" barcode on the same page to complete this setting.



4.13 GS1 DATABAR (RSS FAMILY)

It is categorized into three groups:

Group I – GS1 DataBar Omnidirectional (RSS-14)

This group consists of the following:

- ▶ GS1 DataBar Omnidirectional
- ▶ GS1 DataBar Truncated
- ▶ GS1 DataBar Stacked
- ▶ GS1 DataBar Stacked Omnidirectional

Group II – GS1 DataBar Expanded (RSS Expanded)

This group consists of the following:

- ▶ GS1 DataBar Expanded
- ▶ GS1 DataBar Expanded Stacked

Group III – GS1 DataBar Limited (RSS Limited)

This group consists of the following:

- ▶ GS1 DataBar Limited

4.13.1 SELECT CODE ID

Select a desired Code ID to use:

- ▶ "1e0" (GS1 DataBar Code ID)
- ▶ "1c1" (GS1-128 Code ID)

Use "1c1"



100517

*Use "1e0"



100516



4.13.2 GS1 DATABAR OMNIDIRECTIONAL (RSS-14)

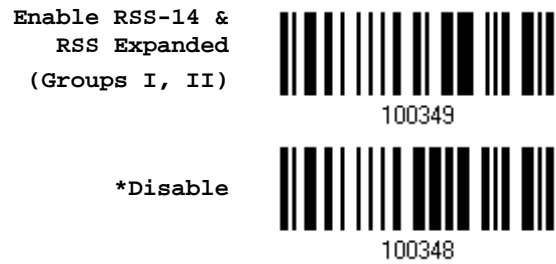

When GS1 formatting for GS1 DataBar Omnidirectional is enabled, code ID transmitting will be disabled; however, application ID transmitting will be enabled automatically.

The settings below apply to Group I symbologies only:

- ▶ GS1 DataBar Omnidirectional
- ▶ GS1 DataBar Truncated
- ▶ GS1 DataBar Stacked
- ▶ GS1 DataBar Stacked Omnidirectional

Transmit Code ID

Decide whether to include the Code ID in the data being transmitted.

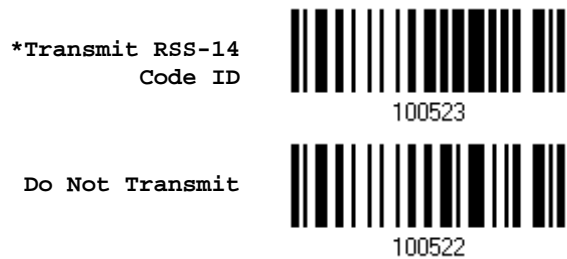

Transmit Application ID

Decide whether to include the Application ID ("01") in the data being transmitted.

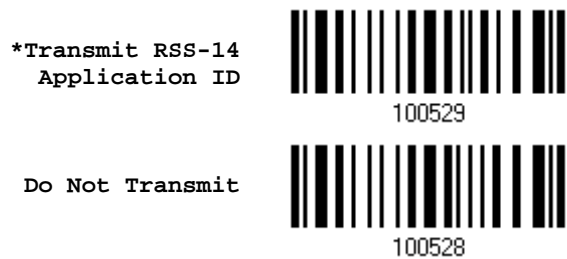

GS1 Formatting for GS1 DataBar Omnidirectional

Decide whether to enable GS1 formatting for GS1 DataBar Omnidirectional. When enabled, the field separator and application ID mark characters will be automatically added to the output data.



Enable GS1
Formatting



101486

*Disable GS1
Formatting



101485

4.13.3 GS1 DATABAR EXPANDED (RSS EXPANDED)

Enable RSS-14 &
RSS Expanded
(Groups I, II)



100349

*Disable



100348

When GS1 formatting for GS1 DataBar Expanded is enabled, code ID transmitting will be disabled.

The settings below apply to Group II symbologies only:

- ▶ GS1 DataBar Expanded
- ▶ GS1 DataBar Expanded Stacked

Transmit Code ID

Decide whether to include the Code ID in the data being transmitted.

*Transmit
RSS Expanded Code ID



100527

Do Not Transmit



100526

GS1 Formatting for GS1 DataBar Expanded

Decide whether to enable GS1 formatting for GS1 DataBar Expanded. When enabled, the field separator and application ID mark characters will be automatically added to the output data.

Enable GS1
Formatting



101490



***Disable GS1 Formatting**



101489

4.13.4 GS1 DATABAR LIMITED (RSS LIMITED)

Enable RSS Limited (Group III)



100351

***Disable**



100350

When GS1 formatting for GS1 DataBar Limited is enabled, code ID transmitting will be disabled; however, application ID transmitting will be enabled automatically.

Transmit Code ID

Decide whether to include the Code ID in the data being transmitted.

***Transmit RSS Limited Code ID**



100525

Do Not Transmit



100524

Transmit Application ID

Decide whether to include the Application ID ("01") in the data being transmitted.

***Transmit RSS Limited Application ID**



100531

Do Not Transmit



100530

GS1 Formatting for GS1 DataBar Limited

Decide whether to enable GS1 formatting for GS1 DataBar Limited. When enabled, the field separator and application ID mark characters will be automatically added to the output data.

Enable GS1 Formatting



101488



*Disable GS1
Formatting



101487

4.13.5 CONVERT TO UPC/EAN

This only applies to GS1 DataBar Omnidirectional and GS1 DataBar Limited barcodes not decoded as part of a Composite barcode.

- ▶ Convert to EAN-13: It will strip the leading "010" from barcodes.
"01" is the Application ID and must be followed by a single zero (the first digit encoded).
- ▶ Convert to UPC-A: It will strip the leading "0100" from barcodes.
"01" is the Application ID and must be followed by two or more zeros (but not six zeros).

Convert to UPC/EAN



102103

*Do Not Convert



102102

4.13.6 FIELD SEPARATOR (GS CHARACTER)

Decide whether to apply a field separator (to convert the GS control character to human readable character). The field separator is automatically added to the data when GS1 formatting is enabled.

Specify Field
Separator...



100616

- 1) Read the barcode above to specify field separator.
- 2) Read the "Hexadecimal Value" barcode on page 268 for the desired character string.
- 3) Read the "Validate" barcode to complete this setting.



4.13.7 APPLICATION ID MARK

You may want to add an application ID mark (1 character long) to the left (AIMark1) or right (AIMark2) of an application ID (AI) for the purpose of labeling it when formatting the GS1 data.

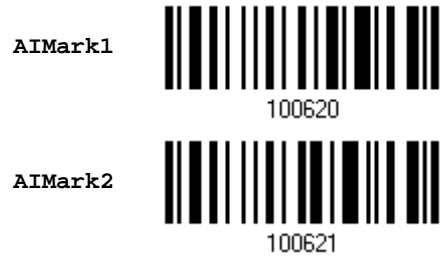

- 1) Read the barcode above to add a mark to the left (AIMark1)/right (AIMark2) of an application ID.
- 2) Read the "Hexadecimal Value" barcode on page 268 for the desired character. Read '00' if you want to remove the AI mark.
- 3) Read the "Validate" barcode to complete this setting.



4.14 MSI

Enable



100345

*Disable



100344

4.14.1 VERIFY CHECK DIGIT

Select one of the three calculations to verify check digit(s) when decoding barcodes. If incorrect, the barcode will not be accepted.

*Single Modulo 10



100448

Double Modulo 10



100449

Modulo 10 & 11



100450

4.14.2 TRANSMIT CHECK DIGIT

Decide whether to include the check digit(s) in the data being transmitted.

*Last Digit Not Transmitted



100452

Both Digits Transmitted



100453

Both Digits Not Transmitted



100454



4.14.3 CODE LENGTH QUALIFICATION

To prevent the "short scan" error, define the "Length Qualification" settings to ensure that the correct barcode is read by qualifying the allowable code length.

- ▶ If "Max/Min Length" is selected, the maximum length and the minimum length must be specified. It only accepts those barcodes with lengths that fall between max/min lengths specified.
- ▶ If "Fixed Length" is selected, up to 2 fixed lengths can be specified.

Note: The specified length(s) must include the check digit(s) the barcode contains.

- 1) Read the barcode to enable either Max. /Min. Length qualification or Fixed Length(s) qualification.

***Enable Max./Min.
Length (1~55)...**



100613

**Enable Fixed
Length(s)...**



100612

- 2) Read the barcode for Max. Length or Fixed Length 1, and follow steps 3~4.
Repeat steps 2~4 for Min. Length or Fixed Length 2.

**Max. Length (*55) or
Fixed Length 1**



100614

**Min. Length (*4) or
Fixed Length 2**



100615

- 3) Read the "Decimal Value" barcode on page 267 for the desired length.
- 4) Read the "Validate" barcode on the same page to complete this setting.



4.15 EAN-8

EAN-8

*Enable EAN-8
(No Addon)



Disable



EAN-8 Addon 2

Enable EAN-8 Addon 2



*Disable



EAN-8 Addon 5

Enable EAN-8 Addon 5



*Disable



4.15.1 TRANSMIT CHECK DIGIT

Decide whether to include the check digit in the data being transmitted.

*Transmit EAN-8
Check Digit



Do Not Transmit



4.16 EAN-13

EAN-13

***Enable EAN-13
(No Addon)**



Disable



EAN-13 Addon 2

Enable EAN-13 Addon 2



***Disable**



EAN-13 Addon 5

Enable EAN-13 Addon 5



***Disable**



4.16.1 CONVERT TO ISBN

Decide whether to convert the EAN-13 barcode, starting with 978 and 979, to ISBN.

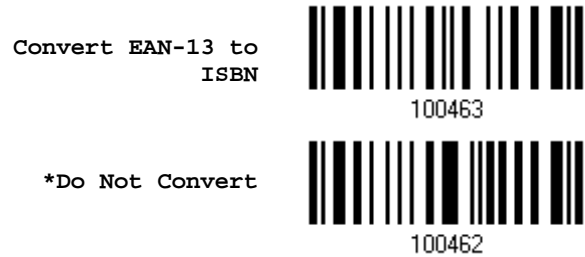

4.16.2 CONVERT TO ISSN

Decide whether to convert the EAN-13 barcode, starting with 977 to ISSN.

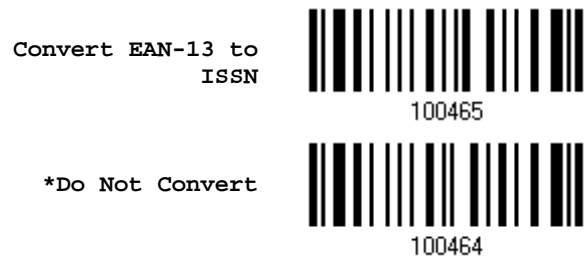

4.16.3 TRANSMIT CHECK DIGIT

Decide whether to include the check digit in the data being transmitted.

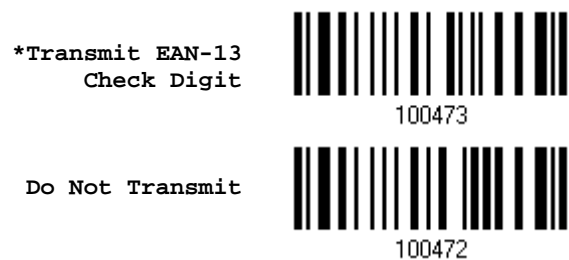

4.17 UCC COUPON EXTENDED CODE

Decide whether to decode the following barcodes as Coupon Code.

- ▶ UPC-A barcodes starting with digit "5"
- ▶ EAN-13 barcodes starting with digits "99"
- ▶ UPC-A/EAN-128 Coupon Codes

Enable



102003

*Disable



102002

Note: Depending on your requirements, UPC-A, EAN-13 and EAN-128 must be enabled first!



4.18 UPC-A

UPC-A

***Enable UPC-A
(No Addon)**



100339

Disable



100338

UPC-A Addon 2

Enable UPC-A Addon 2



100341

***Disable**



100340

UPC-A Addon 5

Enable UPC-A Addon 5



100343

***Disable**



100342



4.18.1 CONVERT TO EAN-13

Decide whether to expand the read UPC-A barcode, as well as its addons, into EAN-13.

- ▶ After conversion, the data follows EAN-13 format and is affected by EAN-13 programming selections (e.g. Check Digit).

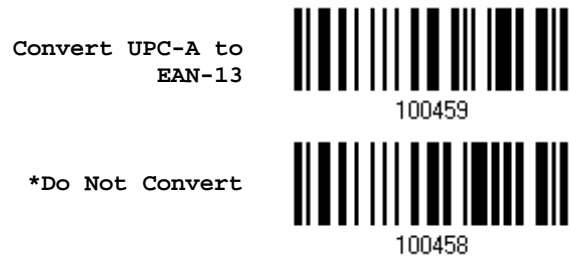

4.18.2 TRANSMIT SYSTEM NUMBER

Decide whether to include the system number in the data being transmitted.

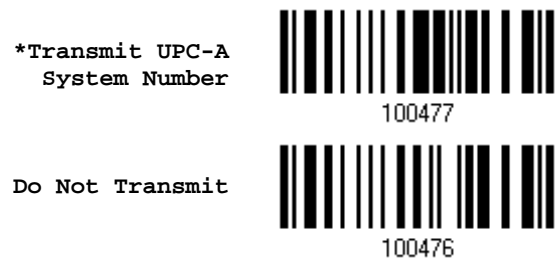

4.18.3 TRANSMIT CHECK DIGIT

Decide whether to include the check digit in the data being transmitted.

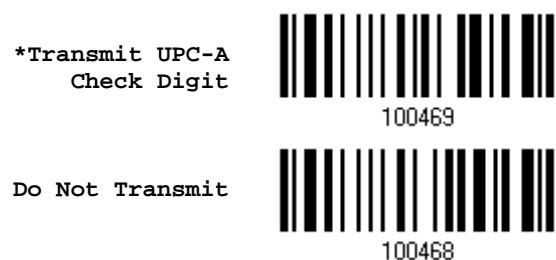

4.19 UPC-E

UPC-E

***Enable UPC-E
(No Addon)**



Disable



UPC-E Addon 2

Enable UPC-E Addon 2



***Disable**



UPC-E Addon 5

Enable UPC-E Addon 5



***Disable**



4.19.1 SELECT SYSTEM NUMBER

Decide whether to decode the ordinary UPC-E barcodes only or both UPC-E0 and UPC-E1 barcodes.

- ▶ System number 0 enabled for decoding UPC-E0 barcodes.
- ▶ System number 1 enabled for decoding UPC-E1 barcodes.

System Number 0 & 1



100479

*System Number 0 Only



100478

Warning: Because of the way system number 1 is encoded, if both system numbers are enabled, the user might suffer from short scanning UPC-A or EAN-13 barcodes into UPC-E1 barcodes.

4.19.2 CONVERT TO UPC-A

Decide whether to expand the read UPC-E barcode, as well as its addons, into UPC-A.

- ▶ After conversion, the data follows UPC-A format and is affected by UPC-A programming selections (e.g. System Number, Check Digit).

Convert UPC-E to
UPC-A



100457

*Do Not Convert



100456



4.19.3 TRANSMIT SYSTEM NUMBER

Decide whether to include the system number in the data being transmitted.

Transmit UPC-E
System Number



100475

*Do Not Transmit



100474

4.19.4 TRANSMIT CHECK DIGIT

Decide whether to include the check digit in the data being transmitted.

*Transmit UPC-E
Check Digit



100467

Do Not Transmit



100466



4.20 CODE 11

Enable



102007

*Disable



102006

4.20.1 VERIFY CHECK DIGIT

Decide whether to verify the check digit(s). If incorrect, the barcode will not be accepted.

Verify One
Check Digit



102244

Verify Two
Check Digit



102245

*Do Not Verify



102243

4.20.2 TRANSMIT CHECK DIGIT

Decide whether to include the check digit(s) in the data being transmitted.

Transmit Code 11
Check Digit



102107

*Do Not Transmit



102106

Note: "Verify Check Digit" must be enabled first.



4.20.3 CODE LENGTH QUALIFICATION

To prevent the "short scan" error, define the "Length Qualification" settings to ensure that the correct barcode is read by qualifying the allowable code length.

- ▶ If "Max/Min Length" is selected, the maximum length and the minimum length must be specified. It only accepts those barcodes with lengths that fall between max/min lengths specified.
- ▶ If "Fixed Length" is selected, up to 2 fixed lengths can be specified.

Note: The specified length(s) must include the check digit(s) the barcode contains.

- 1) Read the barcode to enable either Max. /Min. Length qualification or Fixed Length(s) qualification.

***Enable Max./Min.
Length (1~55)...**



102234

**Enable Fixed
Length(s)...**



102233

- 2) Read the barcode for Max. Length or Fixed Length 1, and follow steps 3~4.
Repeat steps 2~4 for Min. Length or Fixed Length 2.

**Max. Length (*55) or
Fixed Length 1**



102235

**Min. Length (*4) or
Fixed Length 2**



102236

- 3) Read the "Decimal Value" barcode on page 267 for the desired length.
- 4) Read the "Validate" barcode on the same page to complete this setting.



4.21 COMPOSITE CODE

4.21.1 COMPOSITE CC-A/B

Decide whether to enable Composite CC-A/B

Enable Composite
CC-A/B



102009

*Disable



102008

Decide whether to enable GS1 formatting for Composite CC-A/B. When enabled, the field separator and application ID mark will be automatically added to the output data

Enable GS1
Formatting



101492

*Disable GS1
Formatting



101491

4.21.2 COMPOSITE CC-C

Decide whether to enable Composite CC-C.

Enable Composite
CC-C



102011

*Disable



102010

Decide whether to enable GS1 formatting for Composite CC-C. When enabled, the field separator and application ID mark will be automatically added to the output data.

Enable GS1
Formatting



101494

* Disable GS1
Formatting



101493



4.21.3 COMPOSITE TLC-39

Enable Composite
TLC-39



*Disable



4.21.4 UPC COMPOSITE MODE

UPC barcodes can be “linked” with a 2D barcode during transmission as if they were one barcode.

▶ **UPC Never Linked**

Transmit UPC barcodes regardless of whether a 2D barcode is detected.

▶ **UPC Always Linked**

Transmit UPC barcodes and the 2D portion. If the 2D portion is not detected, the UPC barcode will not be transmitted.

Note: CC-A/B or CC-C must be enabled!

▶ **Auto-discriminate UPC Composites**

Transmit UPC barcodes as well as the 2D portion if present.

UPC Never Linked



*UPC Always Linked



Auto-discriminate



4.21.5 GS1-128 EMULATION MODE FOR UCC/EAN COMPOSITE CODES

Decide whether to transmit UCC/EAN Composite Code data as if it was encoded in GS1-128 barcodes.

Enable GS1-128
Emulation Mode



102105

*Disable



102104

4.21.6 FIELD SEPARATOR (GS CHARACTER)

Decide whether to apply a field separator (to convert the GS control character to human readable character). The field separator is automatically added to the data when GS1 formatting is enabled.

Specify Field
Separator...



100616

- 1) Read the barcode above to specify field separator.
- 2) Read the "Hexadecimal Value" barcode on page 268 for the desired character string.
- 3) Read the "Validate" barcode to complete this setting.



4.21.7 APPLICATION ID MARK

You may want to add an application ID mark (1 character long) to the left (AIMark1) or right (AIMark2) of an application ID (AI) for the purpose of labeling it when formatting the GS1 data. The application ID mark is automatically added to the data when GS1 formatting is enabled.



- 1) Read the barcode above to add a mark to the left (AIMark1)/right (AIMark2) of an application ID.
- 2) Read the “[Hexadecimal System](#)” barcode on page 268 for the desired character. Read '00' if you want to remove the AI mark.
- 3) Read the “Validate” barcode to complete this setting.



4.22 US POSTAL CODE

4.22.1 US POSTNET

*Enable US Postnet



Disable



4.22.2 US PLANET

*Enable US Planet



Disable



4.22.3 TRANSMIT CHECK DIGIT

Decide whether to include the check digit in the data being transmitted.

*Transmit US Postal
Check Digit



Do Not Transmit



4.23 UK POSTAL CODE

4.23.1 UK POSTAL

*Enable UK Postal



102021

Disable



102020

4.23.2 TRANSMIT CHECK DIGIT

Decide whether to include the check digit in the data being transmitted.

*Transmit UK Postal
Check Digit



102109

Do Not Transmit



102108



4.24 MORE POSTAL CODE

4.24.1 JAPAN POSTAL

***Enable Japan Postal**



Disable



4.24.2 AUSTRALIAN POSTAL

***Enable Australian Postal**



Disable



4.24.3 DUTCH POSTAL

***Enable Dutch Postal**



Disable



4.24.4 USPS 4CB/ONE CODE/INTELLIGENT MAIL

**Enable USPS 4CB/
One Code/
Intelligent Mail**



***Disable**



4.24.5 UPU FICS POSTAL

Enable UPU FICS
Postal



102031

*Disable



102030



4.25 2D SYMBOLOGIES

4.25.1 PDF417

***Enable PDF417**



102033

Disable



102032

4.25.2 MicroPDF417

Enable MicroPDF417



102035

***Disable**



102034



4.25.3 DATA MATRIX

***Enable Data Matrix**



Disable



Data Matrix Mirror

Decide whether to decode mirror image Data Matrix barcodes.

- ▶ Never — do not decode Data Matrix barcodes that are mirror images.
- ▶ Always — decode only Data matrix barcodes that are mirror images.
- ▶ Auto — decode both mirrored and unmirrored Data Matrix barcodes.

***Never**



Always



Auto



4.25.4 MAXICODE

***Enable Maxicode**



Disable



4.25.5 QR CODE

***Enable QR Code**



Disable



4.25.6 MicroQR

***Enable MicroQR**



Disable



4.25.7 AZTEC

***Enable Aztec**



Disable



4.26 MACRO PDF

Macro PDF is a special feature for concatenating multiple PDF barcodes into one file, known as Macro PDF417 or Macro MicroPDF417.

Note: When printing barcodes, keep each Macro PDF sequence separate, as each has a unique identifier. Do not mix barcodes from several Macro PDF sequences, even if they encode the same data. When you scan Macro PDF sequences, scan the entire Macro PDF sequence without interruption!

4.26.1 TRANSMIT/DECODE MODE

Decide how to handle Macro PDF decoding.

▶ Buffer All Symbols / Transmit Macro PDF When Complete

Transmit all decoded data from an entire Macro PDF sequence only when the entire sequence is scanned and decoded. If the decoded data exceeds the limit of 50 symbols, no transmission because the entire sequence was not scanned!

▶ Transmit Any Symbol in Set / No Particular Order

Transmit data from each Macro PDF symbol as decoded, regardless of the sequence.

▶ Passthrough All Symbols

Transmit and decode all Macro PDF symbols and perform no processing. In this mode, the host is responsible for detecting and parsing the Macro PDF sequences.

Buffer All Symbols /
Transmit When Complete



Transmit Any Symbol in Set /
No Particular Order



*Passthrough All Symbols



4.26.2 ESCAPE CHARACTERS

When enabled, it uses the backslash "\" as an Escape character for systems that can process transmissions containing special data sequences. It will format special data according to the Global Label Identifier (GLI) protocol, which only affects the data portion of a Macro PDF symbol transmission. The Control Header, if enabled, is always sent with GLI formatting.



4.26.3 TRANSMIT CONTROL HEADER

The control header contains the segment index and file ID. For example, the field may be "\92800000\725\120\343". The five digits after the \928 are the segment index (or block index), and \725\120\343 is the file ID.

- ▶ Enable this when selecting "Transmit Any Symbol in Set/ No Particular Order".
- ▶ Disable this when selecting "Buffer All Symbols/Transmit Macro PDF When Complete".
- ▶ This option has no effect when selecting "Passthrough All Symbols".





DEFINING OUTPUT FORMAT

You may configure in which format the collected data will be output to the host computer. Barcode read by the scanner will be processed in the following sequence –

- 1) Perform character substitution on the data scanned.
- 2) Add Code ID and Length Code to the front of the data: [Code ID][Length Code][Data]
- 3) Process the whole data in step 2 with user formats. Data is now divided into fields by user specified rules. Refer to [Chapter 6 Applying Formats for Data Editing](#).
- 4) Add Prefix Code and Suffix Code before transmission: [Prefix Code][Processed Data][Suffix Code]

IN THIS CHAPTER

5.1 Letter Case	175
5.2 Character Substitution	176
5.3 Prefix/Suffix Code	188
5.4 Code ID	189
5.5 Length Code	196
5.6 Multi-Barcode Editor	204
5.7 Removal of Special Character	207
5.8 AIM Code ID	208

5.1 LETTER CASE

By default, the alphabets transmission is case-sensitive, meaning that the alphabets will be transmitted according to their original case. Ignoring the original letter case, select [Upper Case] to output data in upper case only; otherwise, select [Lower Case] to output data in lower case only.

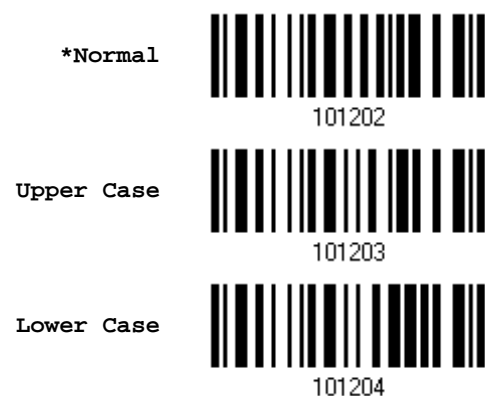

5.2 CHARACTER SUBSTITUTION

Character substitution is performed on every occurrence of the first character specified. If only one character is specified, every occurrence of that character in the barcode will be taken away.

- ▶ The first character will be replaced by the second character(s).
- ▶ Up to three sets of character substitution can be configured.
- ▶ If "BT HID", "USB HID" or "Keyboard Wedge" is configured for interface, Key Type and Key Status will then become applicable. You may decide whether or not to apply Key Status when "Normal Key" is selected for Key Type.

Key Type		Key Status
Scan Code	Only 1 scan code value is allowed. Refer to 5.2.1 Select a Set for Character Substitution.	N/A
Normal Key	Up to 3 character strings are allowed.	<ul style="list-style-type: none"> ▶ Add Shift ▶ Add Left Ctrl ▶ Add Left Alt ▶ Add Right Ctrl ▶ Add Right Alt Refer to Keyboard Wedge Table.

Note: The character substitution is performed only on the barcode itself and before the processing of editing formats. It is not applicable to the Prefix/Suffix Code, Code ID, Length Code, or any Additional Field.



5.2.1 SELECT A SET FOR CHARACTER SUBSTITUTION

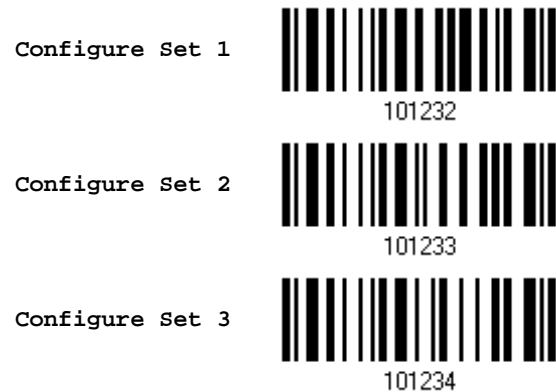

- 1) Read the barcode above to enable character substitution by set.

For example, have the scanner read the "Set 1" barcode to configure the first set of character substitution. The scanner will respond with one short beep, high tone, to indicate more setup barcodes are required.

- 2) Read the "Hexadecimal Value" barcode on page 268 for the desired character substitution. For example:

KEY TYPE = NORMAL

- ▶ Read "3", "0", "2", and "D" to replace the character "0" with a dash "-".
- ▶ Read "3", "0", "2", "D", "3", and "0" to replace the character "0" with a dash "-0".

KEY TYPE = SCAN CODE

If you want to replace the character "0" with "a" (= "1C" on the scan code table):

1. Read "3" and "0".
2. Read the "Scan Code" barcode.
3. Read "1" and "C".

KEY TYPE = NORMAL + KEY STATUS = SHIFT

If you want to replace the character "0" with "!" (= "Shift" + "1" on keyboard):

1. Read "3" and "0".
2. Read the "Add Shift" barcode.
3. Read "3" and "1".

- 3) Read the "Validate" barcode to complete this setting. (The defined set or sets will be applied to all symbologies by default.)



5.2.2 SYMBOLOGIES FOR CHARACTER SUBSTITUTION (ALL 3 SETS)

By default character substitution will be performed on all symbologies. If the character substitution is not desired with one or more symbologies, read the “Do Not Apply” barcode for each undesired symbologies and all the three sets will be ignored for them.

Character Substitution for Codabar

*Apply



101253

Do Not Apply



101252

Character Substitution for Code 39

*Apply



101241

Do Not Apply



101240

Character Substitution for Trioptic Code 39

*Apply



102607

Do Not Apply



102606

Character Substitution for Code 93

*Apply



101255

Do Not Apply



101254



Character Substitution for Code 128

*Apply	 101257
Do Not Apply	 101256



Character Substitution for GS1-128

*Apply	 101259
Do Not Apply	 101258

Character Substitution for ISBT 128

*Apply	 101293
Do Not Apply	 101292

Character Substitution for EAN-8 (No Addon)

*Apply	 101267
Do Not Apply	 101266

Character Substitution for EAN-8 Addon 2

*Apply	 101269
---------------	---



Do Not Apply



101268

Character Substitution for EAN-8 Addon 5

*Apply



101271

Do Not Apply



101270

Character Substitution for EAN-13 (No Addon)

*Apply



101273

Do Not Apply



101272

Character Substitution for EAN-13 Addon 2

*Apply



101275

Do Not Apply



101274

Character Substitution for EAN-13 Addon 5

*Apply



101277

Do Not Apply



101276

Character Substitution for Italian Pharmacode

*Apply



101243



Do Not Apply 
101242

Character Substitution for Industrial 25

*Apply 
101247

Do Not Apply 
101246

Character Substitution for Interleaved 25

*Apply 
101249

Do Not Apply 
101248

Character Substitution for Matrix 25

*Apply 
101251

Do Not Apply 
101250

Character Substitution for Chinese 25

*Apply 
102617

Do Not Apply 
102616

Character Substitution for MSI

*Apply 
101285



Do Not Apply



101284

Character Substitution for GS1 DataBar

*Apply



101291

Do Not Apply



101290

Character Substitution for UPC-A (No Addon)

*Apply



101279

Do Not Apply



101278

Character Substitution for UPC-A Addon 2

*Apply



101281

Do Not Apply



101280

Character Substitution for UPC-A Addon 5

*Apply



101283

Do Not Apply



101282

Character Substitution for UPC-E (No Addon)

*Apply



101261



Do Not Apply 
101260

Character Substitution for UPC-E Addon 2

*Apply 
101263

Do Not Apply 
101262

Character Substitution for UPC-E Addon 5

*Apply 
101265

Do Not Apply 
101264

Character Substitution for UCC Coupon Extended Code

*Apply 
102605

Do Not Apply 
102604

Character Substitution for Code 11

*Apply 
102609

Do Not Apply 
102608

Character Substitution for Composite CC-A/B

*Apply 
102611



Do Not Apply



102610

Character Substitution for Composite CC-C

*Apply



102613

Do Not Apply



102612

Character Substitution for Composite TLC-39

*Apply



102615

Do Not Apply



102614

Character Substitution for US Postnet

*Apply



102619

Do Not Apply



102618

Character Substitution for US Planet

*Apply



102621

Do Not Apply



102620

Character Substitution for UK Postal

*Apply



102623



Do Not Apply



102622

Character Substitution for Japan Postal

*Apply



102625

Do Not Apply



102624

Character Substitution for Australian Postal

*Apply



102627

Do Not Apply



102626

Character Substitution for Dutch Postal

*Apply



102629

Do Not Apply



102628

Character Substitution for USPS 4CB/One Code/Intelligent Mail

*Apply



102631

Do Not Apply



102630

Character Substitution for UPU FICS Postal

*Apply



102633



Do Not Apply



102632

Character Substitution for PDF417

*Apply



102635

Do Not Apply



102634

Character Substitution for MicroPDF417

*Apply



102637

Do Not Apply



102636

Character Substitution for Data Matrix

*Apply



102639

Do Not Apply



102638

Character Substitution for Maxicode

*Apply



102641

Do Not Apply



102640

Character Substitution for QR Code

*Apply



102643



Do Not Apply



102642

Character Substitution for MicroQR

*Apply



102645

Do Not Apply



102644

Character Substitution for Aztec

*Apply



102647

Do Not Apply



102646



5.3 PREFIX/SUFFIX CODE

By default, there is no prefix code, and [ENTER] or [CR] (Carriage Return) is configured to be suffix code. Up to 8 characters can be configured, for example, "Barcode_", and you will have the string appear in front of the barcode read, like this – "Barcode_1234567890".

- ▶ If "BT HID", "USB HID" or "Keyboard Wedge" is configured for interface, Key Type and Key Status will then become applicable. You may decide whether or not to apply Key Status when "Normal Key" is selected for Key Type.

Key Type		Key Status
Scan Code	Up to 4 scan code values are allowed.	N/A
Normal Key	Up to 8 character strings are allowed.	<ul style="list-style-type: none"> ▶ Add Shift ▶ Add Left Ctrl ▶ Add Left Alt ▶ Add Right Ctrl ▶ Add Right Alt Refer to Keyboard Wedge Table.

Configure Prefix



101230

Configure Suffix



101231

- 1) Read the barcode above to apply prefix code or suffix code separately, and follow steps 2~3. (Max. 8 characters each)
- 2) Read the "Hexadecimal Value" barcode on page 268 for the desired character string. For example, read "2" and "B" for the scanner to prefix or suffix the character [+].
- 3) Read the "Validate" barcode to complete this setting.



5.4 CODE ID

Up to two characters for Code ID can be configured for each symbology. To make the Code ID configuration easier, the scanner provides five pre-defined Code ID sets that you can select one and make necessary changes on it.

- ▶ If "BT HID", "USB HID" or "Keyboard Wedge" is configured for interface, Key Type and Key Status will then become applicable. You may decide whether or not to apply Key Status when "Normal Key" is selected for Key Type.

Key Type		Key Status
Scan Code	Only 1 scan code value is allowed.	N/A
Normal Key	Up to 2 character strings are allowed.	<ul style="list-style-type: none"> ▶ Add Shift ▶ Add Left Ctrl ▶ Add Left Alt ▶ Add Right Ctrl ▶ Add Right Alt Refer to Keyboard Wedge Table.

Note: "]C1" is the Code ID of GS1-128 (EAN-128) barcodes; "]e0" is the default Code ID of GS1 DataBar (RSS) barcodes.

5.4.1 SELECT PRE-DEFINED CODE ID

Apply Code ID Set 1	 109961
Apply Code ID Set 2	 109962
Apply Code ID Set 3	 109963
Apply Code ID Set 4	 109964
Apply Code ID Set 5	 109965



Code ID options	Set 1	Set 2	Set 3	Set 4	Set 5
Code 39	A	C	Y	M	A
Trioptic Code 39	A	C	Y	M	X
Italian Pharmacode	A	C	Y	M	A
Industrial 25	C	H	H	H	S
Interleaved 25	D	I	Z	I	S
Matrix 25	E	G	G	G	S
Chinese 25	Q	M	P	S	X
Codabar	F	N	X	N	F
Code 93	I	L	L	L	G
Code 128	H	K	K	K	C
ISBT 128	H	K	K	K	C
UPC-E	S	E	C	E	E
EAN-8	P	B	B	FF	E
EAN-13	M	A	A	F	E
UPC-A	J	A	A	A	E
MSI	V	V	D	P	M
UCC Coupon Code	G	F	I	C	C
Code 11	K	J	J	D	H
Composite CC-A/B	L	X	M	J	La
Composite CC-C	N	Y	N	O	Lc
Composite TLC-39	O	Z	O	R	L2
US Postnet	h	a	s	i	X
US Planet	i	b	t	j	X
UK Postal	j	c	u	k	X
Japan Postal	k	d	v	l	X
Australian Postal	l	e	w	m	X
Dutch Postal	m	f	x	n	X
USPS 4 CB / One Code / Intelligent Mail	n	g	y	o	X
UPU FICS Postal	o	h	z	p	X
PDF417	a	O	W	T	L
MicroPDF417	b	P	V	U	L
Data Matrix	c	Q	U	V	d
Maxicode	d	R	T	W	U
QR Code	e	S	S	X	Q



MicroQR	f	T	R	Y	Q
Aztec	g	U	Q	Z	z
IATA	z	z	r	h	S
Macro PDF417	p	i	a	q	L
Macro MicroPDF417	q	j	b	r	L















5.4.2 CHANGE CODE ID

- 1) Read the barcode below to change code ID of a specific symbology.
- 2) Read the “Hexadecimal Value” barcode on page 268 for the desired character string. For example, read “4” and “4” for applying the character [D] for Code ID.
- 3) Read the “Validate” barcode to complete this setting.

Configure Code ID for Codabar	 101456
Configure Code ID for Code 39	 101450
Configure Code ID for Trioptic Code 39	 102566
Configure Code ID for Code 93	 101457
Configure Code ID for Code 128	 101458
Configure Code ID for ISBT 128	 101466
Configure Code ID for EAN-8	 101460
Configure Code ID for EAN-13	 101461
Configure Code ID for Italian Pharmacode	 101451
Configure Code ID for Industrial 25	 101453



Configure Code ID for Interleaved 25	 101454
Configure Code ID for Matrix 25	 101455
Configure Code ID for Chinese 25	 102571
Configure Code ID for MSI	 101463
Configure Code ID for UPC-A	 101462
Configure Code ID for UPC-E	 101459
Configure Code ID for UCC Coupon Code	 102565
Configure Code ID for Code 11	 102567
Configure Code ID for Composite CC-A/B	 102568
Configure Code ID for Composite CC-C	 102569
Configure Code ID for Composite TLC-39	 102570
Configure Code ID for US Postnet	 102572



Configure Code ID for
US Planet



102573

Configure Code ID for
UK Postal



102574

Configure Code ID for
Japan Postal



102575

Configure Code ID for
Australian Postal



102576

Configure Code ID for
Dutch Postal



102577

Configure Code ID for
USPS 4CB / One Code /
Intelligent Mail



102578

Configure Code ID for
UPU FICS Postal



102579

Configure Code ID for
PDF417



102580

Configure Code ID for
MicroPDF417



102581

Configure Code ID for
Data Matrix



102582

Configure Code ID for
Maxicode







102583

Configure Code ID for
QR Code



102584

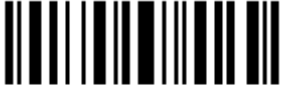

Configure Code ID for MicroQR	 102585
Configure Code ID for Aztec	 102586
Configure Code ID for IATA	 102587
Configure Code ID for Macro PDF417	 102588
Configure Code ID for Macro MicroPDF417	 102589

5.4.3 CLEAR CODE ID SETTINGS

Clear All Code ID Settings	 109960
-------------------------------	---

5.5 LENGTH CODE

A 4-digit code representing the length of barcode data (character count) can be inserted in front of data being transmitted. Such "Length" code can be individually enabled or disabled for each symbology.

Length Code for Codabar

Apply



101413

*Do Not Apply



101412

Length Code for Code 39

Apply



101401

*Do Not Apply



101400

Length Code for Trioptic Code 39

Apply



102505

*Do Not Apply



102504

Length Code for Code 93

Apply



101415

*Do Not Apply



101414



Length Code for Code 128

Apply	
	101417
*Do Not Apply	
	101416

Length Code for GS1-128 & GS1 DataBar

Apply	
	101419
*Do Not Apply	
	101418

Length Code for ISBT 128

Apply	
	101435
*Do Not Apply	
	101434

Length Code for EAN-8

Apply	
	101423
*Do Not Apply	
	101422

Length Code for EAN-13

Apply	
	101425
*Do Not Apply	
	101424



Length Code for Italian Pharmacode

Apply



101403

*Do Not Apply



101402

Length Code for Industrial 25

Apply



101407

*Do Not Apply



101406

Length Code for Interleaved 25

Apply



101409

*Do Not Apply



101408

Length Code for Matrix 25

Apply



101411

*Do Not Apply



101410

Length Code for Chinese 25

Apply



102515

*Do Not Apply



102514



Length Code for MSI

Apply



101429

*Do Not Apply



101428

Length Code for UPC-A

Apply



101427

*Do Not Apply



101426

Length Code for UPC-E

Apply



101421

*Do Not Apply



101420

Length Code for UCC Coupon Extended Code

Apply



102503

*Do Not Apply



102502

Length Code for Code 11

Apply



102507

*Do Not Apply



102506



Length Code for Composite CC-A/B

Apply



102509

*Do Not Apply



102508

Length Code for Composite CC-C

Apply



102511

*Do Not Apply



102510

Length Code for Composite TLC-39

Apply



102513

*Do Not Apply



102512

Length Code for US Postnet

Apply



102517

*Do Not Apply



102516

Length Code for US Planet

Apply



102519

*Do Not Apply



102518



Length Code for UK Postal

Apply



102521

*Do Not Apply



102520

Length Code for Japan Postal

Apply



102523

*Do Not Apply



102522

Length Code for Australian Postal

Apply



102525

*Do Not Apply



102524

Length Code for Dutch Postal

Apply



102527

*Do Not Apply



102526

Length Code for USPS 4CB/One Code/Intelligent Mail

Apply



102529

*Do Not Apply



102528



Length Code for UPU FICS Postal

Apply



102531

*Do Not Apply



102530

Length Code for PDF417

Apply



102533

*Do Not Apply



102532

Length Code for MicroPDF417

Apply



102535

*Do Not Apply



102534

Length Code for Data Matrix

Apply



102537

*Do Not Apply



102536

Length Code for Maxicode

Apply



102539

*Do Not Apply



102538



Length Code for QR Code

Apply



102541

*Do Not Apply



102540

Length Code for MicroQR

Apply



102543

*Do Not Apply



102542

Length Code for Aztec

Apply



102545

*Do Not Apply



102544



5.6 MULTI-BARCODE EDITOR

The Multi-Barcode Editor allows you to decide the output sequence of a concatenation of barcodes. Up to five barcodes can be specified. When you enable this mode, it will force the scanner to apply Laser mode as the scan mode. For 1564A to concatenate barcodes, the maximum output data length of all the barcodes is 10 KB after configuration. When the data length exceeds 10 KB, the concatenation will not take effect.

Note: The Multi-Barcode Editor has nothing to do with Multi-Barcode Mode.

The barcodes that are found meeting the specified criteria below will be arranged in the desired sequence.

- ▶ Code Type
- ▶ 4-digit barcode length, excluding prefix, suffix, length code, etc.
- ▶ Matching the first character of barcode data

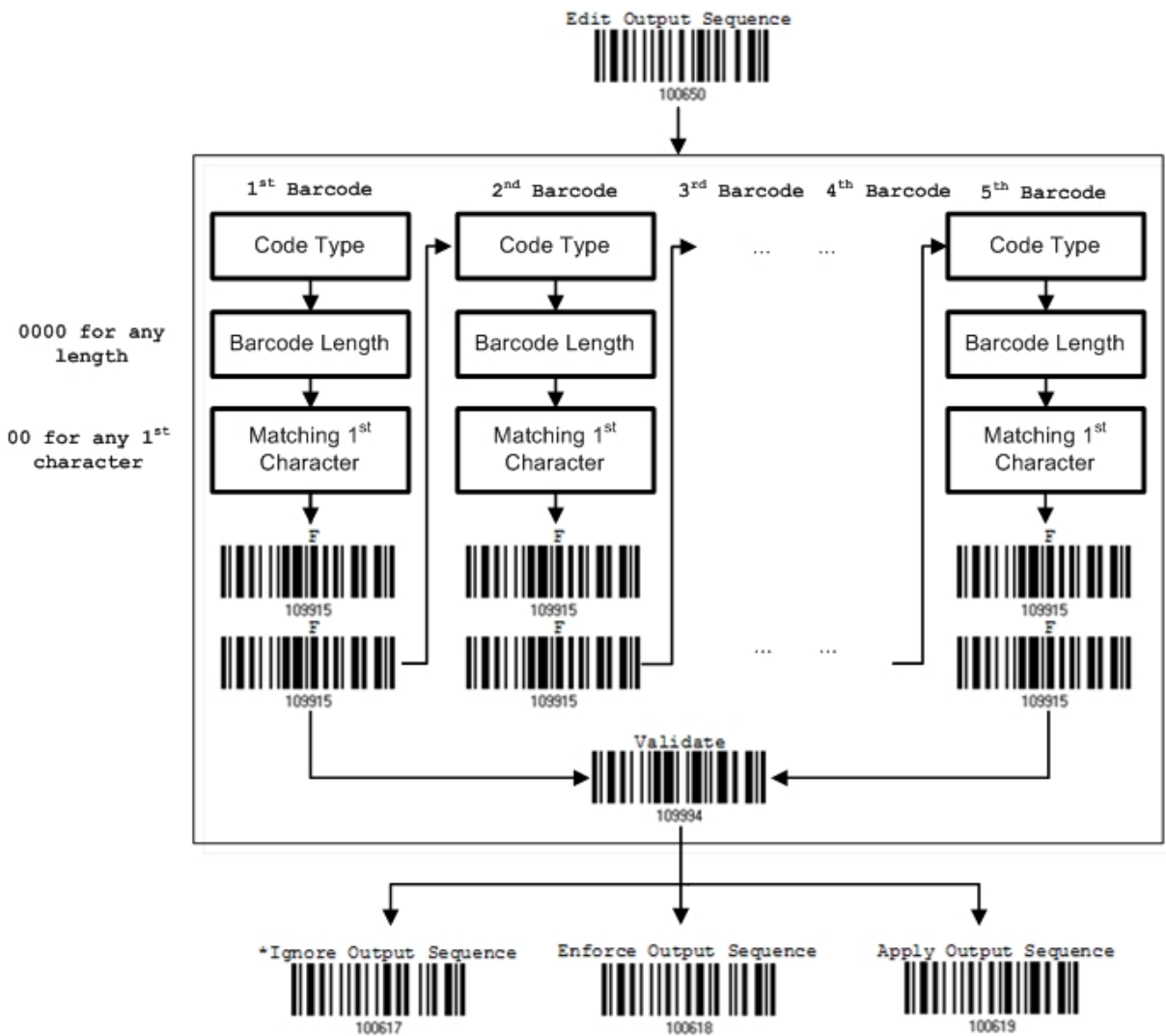

5.6.1 EDIT A CONCATENATION OF BARCODES

Edit Output Sequence



- 1) Read the barcode above to start editing a concatenation of barcodes.
- 2) Code Type setting – read the “Hexadecimal Value” barcode on page 268 for Code Type of the (first) barcode. For example, read “4” and “1” for Code 39.

Code Type	Symbology	Code Type	Symbology
40 (@)	ISBT 128		
41 (A)	Code 39		
42 (B)	Italian Pharmacode		
43 (C)	N/A		
44 (D)	Industrial 25	64 (d)	TLC-39 (TCIF Linked Code 39)
45 (E)	Interleaved 25	65 (e)	Trioptic Code 39
46 (F)	Matrix 25		
47 (G)	Codabar (NW7)	67 (g)	Code 11
48 (H)	Code 93		
49 (I)	Code 128		
4A (J)	UPC-E0 / UPC-E1	6A (j)	Composite CC-C
4B (K)	UPC-E with Addon 2	6B (k)	PDF417
4C (L)	UPC-E with Addon 5	6C (l)	MicroPDF417
4D (M)	EAN-8	6D (m)	Data Matrix
4E (N)	EAN-8 with Addon 2	6E (n)	Maxicode
4F (O)	EAN-8 with Addon 5	6F (o)	QR Code
50 (P)	EAN-13	70 (p)	US Postnet
51 (Q)	EAN-13 with Addon 2	71 (q)	US Planet
52 (R)	EAN-13 with Addon 5	72 (r)	UK Postal
53 (S)	MSI	73 (s)	Japan Postal
54 (T)	N/A	74 (t)	Australian Postal
55 (U)	GS1-128 (EAN-128)	75 (u)	Dutch Postal
56 (V)	UPC-A	76 (v)	Composite CC-A/B
57 (W)	UPC-A with Addon 2	77 (w)	Macro PDF417
58 (X)	UPC-A with Addon 5	78 (x)	Macro MicroPDF417



		79 (y)	Chinese 25
5A (Z)	N/A	7A (z)	Aztec
5B ([)	GS1 DataBar (RSS)	7B ({)	Micro QR
		7C ()	USPS 4CB / One Code / Intelligent Mail
		7D (})	UPU FICS Postal
		7E (~)	UCC Coupon Extended Code

- Barcode Length setting – read the “Decimal Value” barcode on page 267 for the 4-digit length of the (first) barcode. For example, read “0065” for barcode length of 65 characters or read “0000” for any length.

Note: If not reading 0000 for any length, the 4-digit length must exclude prefix, suffix (0x0d by default), length code, etc.

- Matching Character setting – read the “Hexadecimal Value” barcode on page 268 for the 1st character that must be found matching in the (first) barcode. For example, read “4” and “1” for matching character “A” as the first character in the barcode or read “00” for any character.
- Read twice the “F” barcode on page 268 (“FF”) to complete the setting of each barcode.
- Read the “Validate” barcode to end the editing of the barcode set.

5.6.2 ACTIVATE THE CONCATENATION OF BARCODES

By default, the output sequence editing of the concatenation of barcodes is not applied.

When “Enforce Output Sequence” is enabled, all barcodes read by the scanner must meet with the criteria for the concatenation. If data is found excluded from all output sequence sets (= not meeting with the criteria), the scanner will not accept the reading, and therefore, data will not be transmitted.

When “Apply Output Sequence” is enabled, only barcodes found meeting with the criteria are counted for the concatenation. Those found not meeting with the criteria are processed normally and individually.

Note: When it requires reading more barcodes to complete the “output sequence” requirements, the scanner will respond with one short beep (low tone). After reading an acceptable barcode, its LED indicator will become solid green and go off quickly (= Good Read).
Upon completion of reading acceptable barcodes, the scanner will respond with one short beep (high tone) and its LED indicator will become solid green and go off quickly (= Good Read).



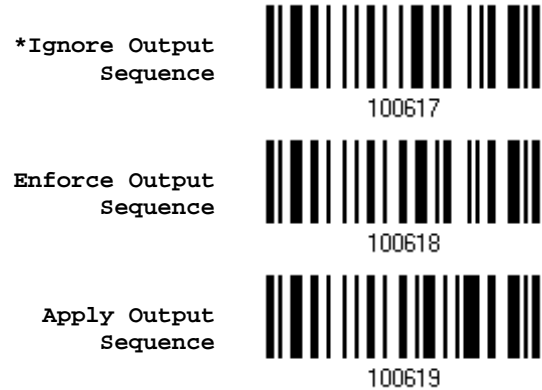

Warning: When you disable the Multi-Barcode Editor later, the scan mode remains unchanged. If Laser mode is not desired, proceed to select a scan mode best suits your application.

5.7 REMOVAL OF SPECIAL CHARACTER

You can only specify 1 character, but it will remove every matching character encountered from the starting position of barcode data until a different character is met. For example, if it is configured to remove the character "0" (hex value is "30"), one or more zeros will be stripped off the barcode data "012345" and "00012345". However, for barcode data "010333", only the first zero will be stripped off.



- 1) Read the barcode above to remove the specified character.
- 2) Read the "Hexadecimal Value" barcode on page 268 for the desired character string. For example, read "3" and "0" for the scanner to remove the character "0".
- 3) Read the "Validate" barcode to complete this setting.



5.8 AIM CODE ID

You can add an AIM (Automatic Identification and Mobility) code ID in front of the barcode that shares the common purpose of identifying, tracking, recording, storing, and communicating essential business, personal, or product data. Enabling this function can have the scanner be capable of fast and accurate data collection and search.

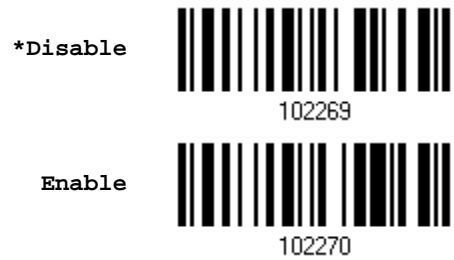

Chapter 6

APPLYING FORMATS FOR DATA EDITING

The scanner allows advanced data editing by applying user-configured editing formats. The whole processed data can be divided into fields by user-specified rules. These fields together with the user-configurable additional fields comprise the data actually sent to the host computer.

With the editing format applied, the maximum output data length of a barcode is 7 KB after configuration. If the data length exceeds 7 KB, editing format will not take effect.

[PrefixCode]	[Code ID]	[LengthCode]	[Data]	[SuffixCode]	Additional Field(s)
None by default	None by default	None by default	Barcode itself	0x0d by default	

IN THIS CHAPTER

6.1 Activating Editing Formats.....	210
6.2 How to Configure Editing Formats	212
6.3 Configuring Format — Define Data Criteria	215
6.4 Configuring Format — Define Data Field	227
6.5 Configuring Format — Define Transmission Sequence	235
6.6 Programming Examples	238



6.1 ACTIVATING EDITING FORMATS

6.1.1 ACTIVATE EDITING FORMATS

If you have already configured any editing format before, you may directly apply the editing format. If not, you must start with configuring an editing format first, and then, activate the editing format when it is desired in use.

Editing Format 1

Enable



101301

*Disable



101300

Editing Format 2

Enable



101303

*Disable



101302

Editing Format 3

Enable



101305

*Disable



101304

Editing Format 4

Enable



101307





Editing Format 5



6.1.2 EXCLUSIVE DATA EDITING

By default, only barcodes found meeting with the criteria are processed by the editing formats. Those found not meeting with the criteria are processed normally.

When "Exclusive Data Editing" is enabled, all barcodes read by the scanner must be processed by the editing formats. If data is found excluded from all enabled editing formats (= not meeting with the specified criteria), the scanner will not accept the reading, and therefore, data will not be transmitted.



6.2 HOW TO CONFIGURE EDITING FORMATS

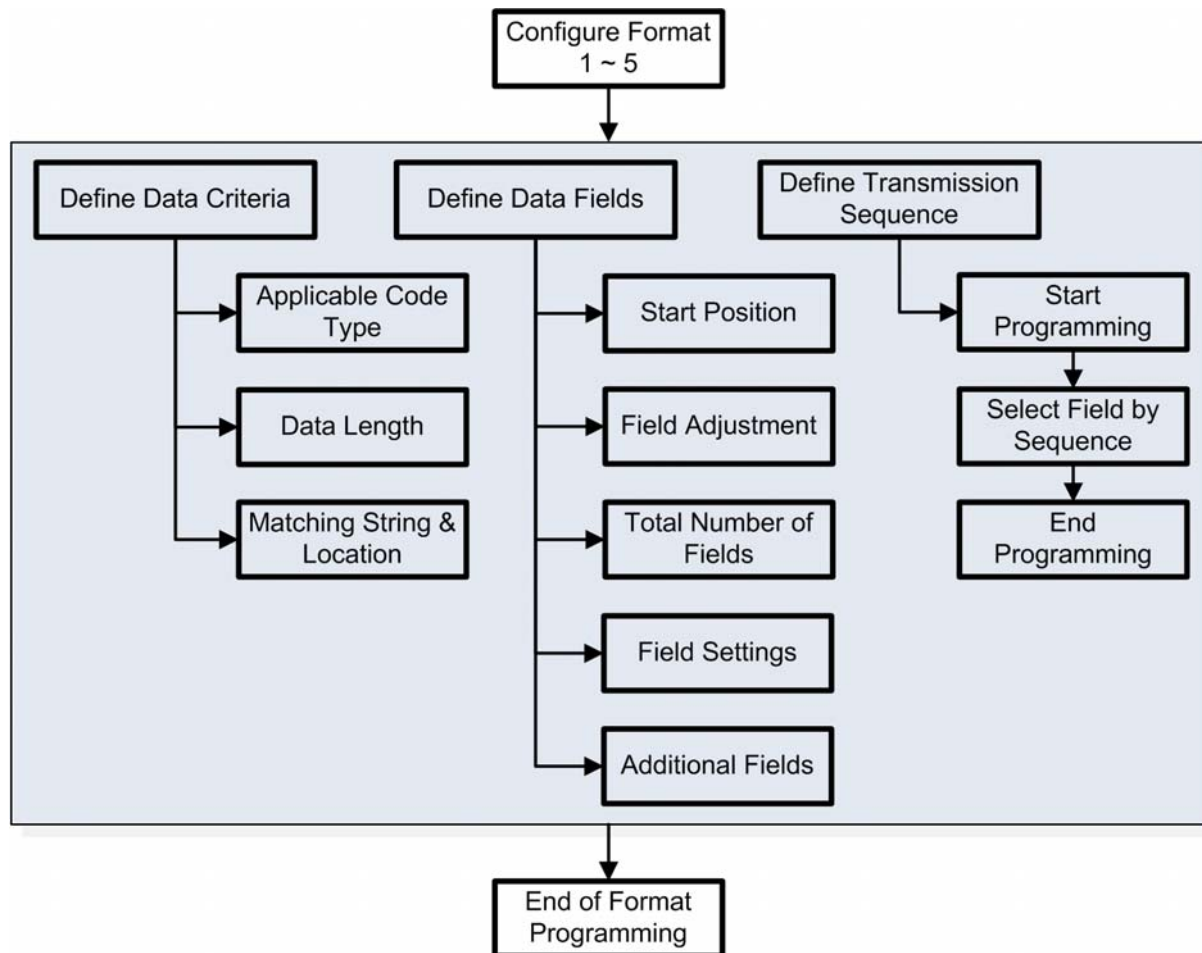

6.2.1 SELECT FORMAT TO CONFIGURE

Start Programming Format

Select one editing format (Format 1~5) and the parameters pertaining to the editing format can then be configured – applicable code type, data length, matching string & location, start position, field adjustment, total number of fields, field settings (field-dividing rule), additional fields, and field transmission sequence.

- ▶ Up to five different formats can be specified.

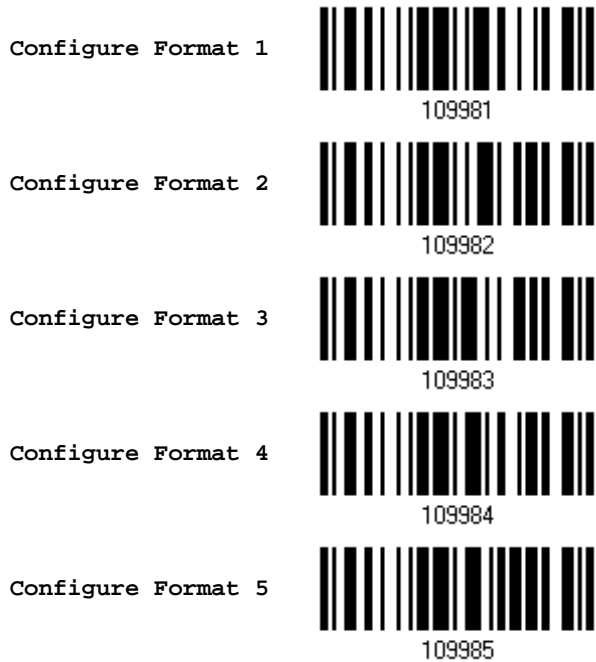

Note: Before you complete the programming of an editing format, if you have the scanner read any barcode for parameters other than those pertaining to the editing format, it will automatically abort the programming process.

End Programming Format

After having configured all the desired parameters, you must have the scanner read the “End Programming Format” barcode, which can be located at the bottom of every even page in this chapter.



6.2.2 RESTORE DEFAULT FORMAT

You may select an existing editing format and have the defaults restored. The default settings of an editing format are listed below.

Editing format	Defaults
Applicable Code Type	All
Data Length	0 (No qualification)
Matching String	Disable
Matching String Location	None
Start Position	From head
Field Adjustment	No adjustment
Total Number of Fields	1
Field Setting – field-dividing rule	Not configured
Additional Fields	None
Field Transmission Sequence	F1

Restore Default
Format



6.3 CONFIGURING FORMAT – DEFINE DATA CRITERIA

Three applicable conditions can be configured to check whether the data read by the scanner can be processed by the particular editing format.

Note: Data editing cannot be performed unless the three conditions are all met.

6.3.1 APPLICABLE CODE TYPE

By default, barcodes of all the supported symbologies will be processed by any editing format, if having been configured and enabled. For quick configuration, you may first clear all, and then select the desired symbologies.

Note: You must have at least one symbology selected.

*Apply to All



Clear All



Editing Format for Codabar

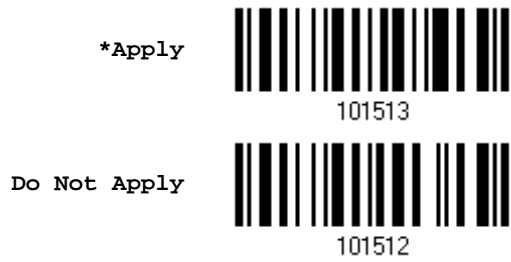

Editing Format for Code 39

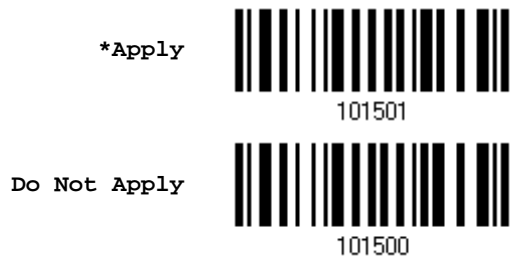

Editing Format for Trioptic Code 39



Editing Format for Code 93

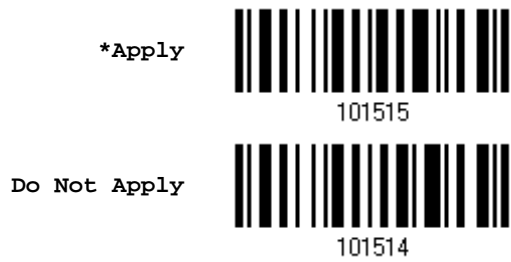

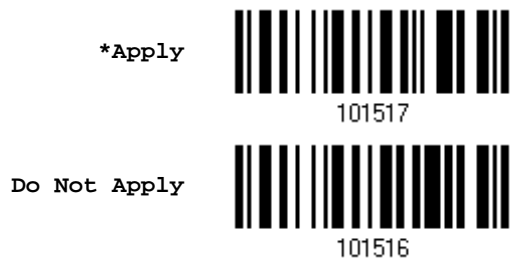

Editing Format for Code 128





Editing Format for GS1-128 & GS1 DataBar

*Apply	 101519
Do Not Apply	 101518



Editing Format for ISBT 128

*Apply	 101553
Do Not Apply	 101552



Editing Format for EAN-8

*Apply	 101527
Do Not Apply	 101526

Editing Format for EAN-8 Addon 2

*Apply	 101529
Do Not Apply	 101528

Editing Format for EAN-8 Addon 5

*Apply	 101531
Do Not Apply	 101530



Editing Format for EAN-13



Editing Format for EAN-13 Addon 2

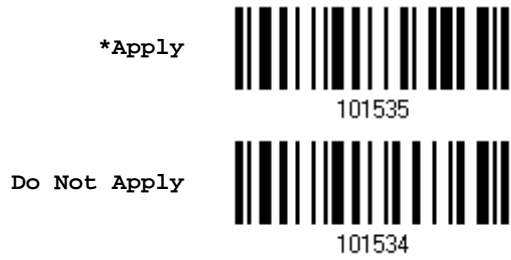

Editing Format for EAN-13 Addon 5



Editing Format for Italian Pharmacode

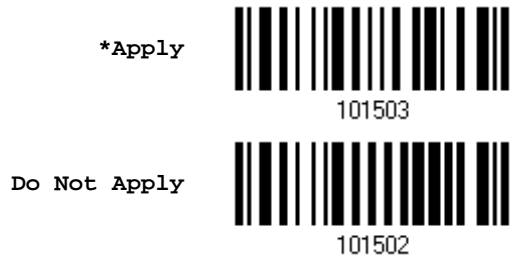

Editing Format for Industrial 25

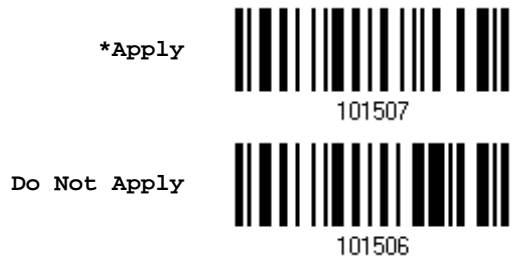

Editing Format for Interleaved 25



Editing Format for Matrix 25



Editing Format for Chinese 25



Editing Format for MSI



Editing Format for UPC-A

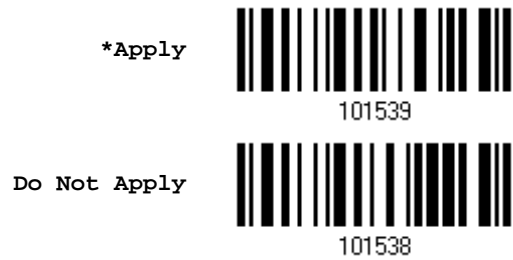

Editing Format for UPC-A Addon 2

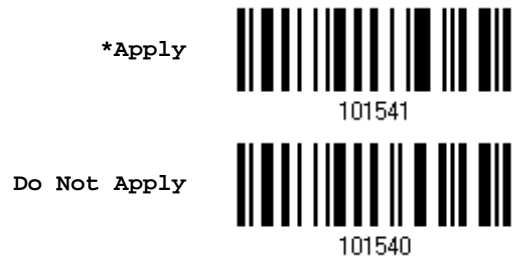

Editing Format for UPC-A Addon 5

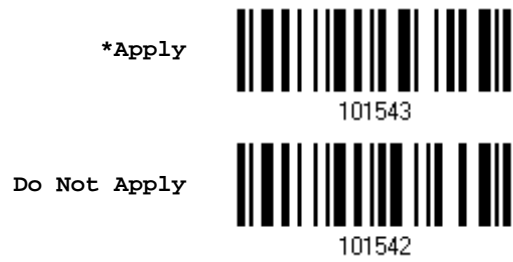

Editing Format for UPC-E

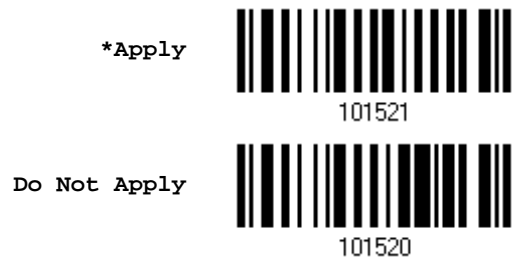

Editing Format for UPC-E Addon 2

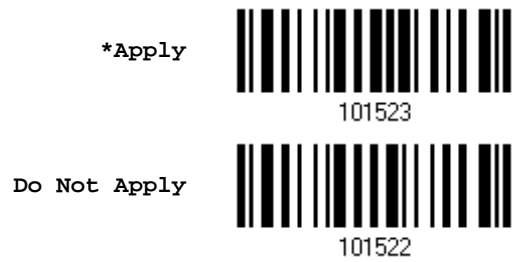

Editing Format for UPC-E Addon 5



Editing Format for UCC Coupon Extended Code

*Apply	 101623
Do Not Apply	 101622

Editing Format for Code 11

*Apply	 101627
Do Not Apply	 101626



Editing Format for Composite CC-A/B

*Apply	 101629
Do Not Apply	 101628

Editing Format for Composite CC-C

*Apply	 101631
Do Not Apply	 101630

Editing Format for Composite TLC-39

*Apply	 101633
Do Not Apply	 101632



Editing Format for US Postnet

***Apply**



101637

Do Not Apply



101636

Editing Format for US Planet

***Apply**



101639

Do Not Apply



101638

Editing Format for UK Postal

***Apply**



101641

Do Not Apply



101640

Editing Format for Japan Postal

***Apply**



101643

Do Not Apply



101642

Editing Format for Australian Postal

***Apply**



101645

Do Not Apply



101644



Editing Format for Dutch Postal

*Apply	 101647
Do Not Apply	 101646

Editing Format for USPS 4CB/One Code/Intelligent Mail

*Apply	 101649
Do Not Apply	 101648

Editing Format for UPU FICS Postal

*Apply	 101651
Do Not Apply	 101650

Editing Format for PDF417

*Apply	 101653
Do Not Apply	 101652

Editing Format for MicroPDF417

*Apply	 101655
Do Not Apply	 101654



Editing Format for Data Matrix



Editing Format for Maxicode



Editing Format for QR Code



Editing Format for MicroQR

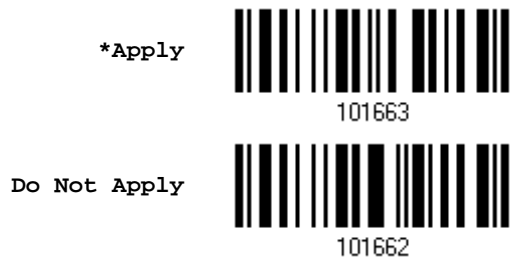

Editing Format for Aztec



6.3.2 DATA LENGTH

The length must include prefix, suffix (0x0d by default), length code, etc. By default, barcodes of any length (character count) are eligible for data editing.

- ▶ Specify a value.
 - ▶ When zero is given to both, the scanner will not perform the length qualification.
- 1) Read the barcode below to specify Max. Length or Min. Length separately, and follow steps 2~3.



- 2) Read the “Decimal Value” barcode on page 267 for the desired length.
- 3) Read the “Validate” barcode on the same page to complete this setting.



6.3.3 MATCHING STRING & LOCATION

By default, no matching string is specified, and therefore, it is disabled. You may enable this feature by specifying a matching string; up to four characters are allowed.

- ▶ When the Matching String Location is zero, the scanner will only check for the existence of the matching string in the barcode data.
- ▶ Specify a value to indicate where the matching string starts in the barcode data.

1) Read the barcode to specify a matching string.

Matching String...



2) Read the "Hexadecimal Value" barcode on page 268 for the desired character string.

3) Read the "Validate" barcode to complete this setting.

4) Read the barcode to specify the location of the matching string.

Location of Matching
String...



5) Read the "Decimal Value" barcode on page 267 for the desired location.

6) Read the "Validate" barcode on the same page to complete this setting.



6.4 CONFIGURING FORMAT – DEFINE DATA FIELD

6.4.1 START POSITION

Data can be divided into fields in one of the following direction –

- ▶ from head (F1) to tail (F5)
- ▶ from tail (F1) to head (F5)

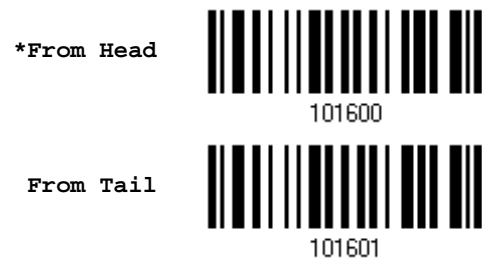

6.4.2 FIELD ADJUSTMENT

You may apply equal length to all fields, if necessary. If data is found longer than specified, it will be truncated automatically. When data is found shorter, it will add "Space" (0x20) to field.

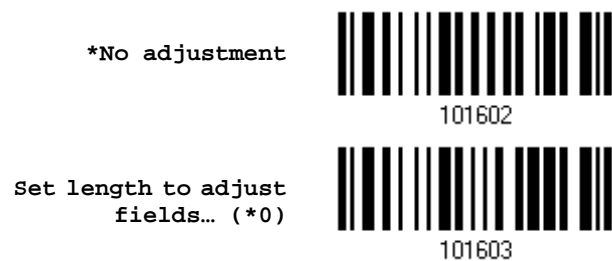

- 1) Read the barcode above to adjust field by length.
- 2) Read the "Decimal Value" barcode on page 267 for the desired field length.
- 3) Read the "Validate" barcode on the same page to complete this setting.



6.4.3 TOTAL NUMBER OF FIELDS

Data can be divided into at most 6 fields; each of them is numbered from F1 to F6 accordingly. However, only F1~F5 can be configured.

- ▶ The total number of fields must be specified correctly. If three fields are configured for the editing format, the data characters after F3 will be assigned to F4 automatically. This feature is quite useful especially when data of variable lengths is processed by editing formats.

*One Field	 101590
Two Fields	 101591
Three Fields	 101592
Four Fields	 101593
Five Fields	 101594
Six Fields	 101595

Note: The number of configurable fields is always one less than the total number of fields specified. The extra data characters beyond the last field configured will be automatically assigned to the next field.



6.4.4 FIELD SETTINGS

Data eligible for editing formats is divided into fields by user-specified rules – either using the field terminating string or specified field length.

By Terminating String

Specify the field terminating string. Up to two characters are allowed. The scanner will search for the occurrence of this particular string in the data.

- ▶ By default, this string will be included in the field. You may discard it.

By Length

Alternatively, you may simply specify the field length. The scanner will assign the next specified number of characters into the field.

Field 1 Setting

1. Read the barcode below to divide field 1 by a specified terminating string.

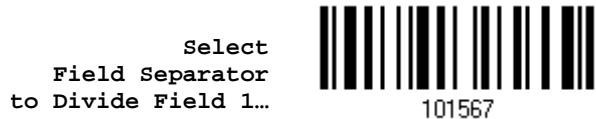

2. Read the “Hexadecimal Value” barcode on page 268 for the desired character string.
3. Read the “Validate” barcode to complete this setting.
4. Read the “Discard Separator” barcode if the field separator is not desired in the field.



If not dividing the field by a specific separator, you may divide it by a specified length.

1. Read the barcode below to divide field 1 by length.



2. Read the "Decimal Value" barcode on page 267 for the desired field length.
3. Read the "Validate" barcode on the same page to complete this setting.

Field 2 Setting

1. Read the barcode below to divide field 2 by a specified terminating string.

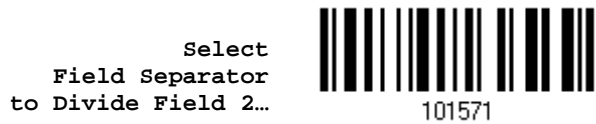

2. Read the "Hexadecimal Value" barcode on page 268 for the desired character string.
3. Read the "Validate" barcode to complete this setting.
4. Read the "Discard Separator" barcode if the field separator is not desired in the field.



If not dividing the field by a specific separator, you may divide it by a specified length.

1. Read the barcode below to divide field 2 by length.



2. Read the "Decimal Value" barcode on page 267 for the desired field length.
3. Read the "Validate" barcode on the same page to complete this setting.



Field 3 Setting

1. Read the barcode below to divide field 3 by a specified terminating string.

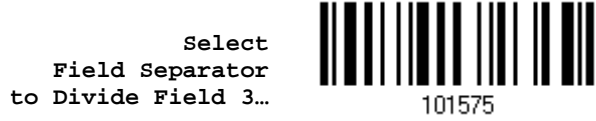

2. Read the "Hexadecimal Value" barcode on page 268 for the desired character string.
3. Read the "Validate" barcode to complete this setting.
4. Read the "Discard Separator" barcode if the field separator is not desired in the field.



If not dividing the field by a specific separator, you may divide it by a specified length.

1. Read the barcode below to divide field 3 by length.

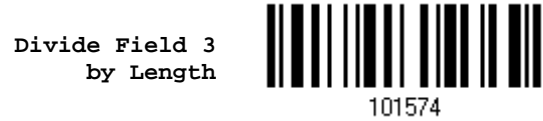

2. Read the "Decimal Value" barcode on page 267 for the desired field length.
3. Read the "Validate" barcode on the same page to complete this setting.



Field 4 Setting

1. Read the barcode below to divide field 4 by a specified terminating string.



2. Read the "Hexadecimal Value" barcode on page 268 for the desired character string.
3. Read the "Validate" barcode to complete this setting.
4. Read the "Discard Separator" barcode if the field separator is not desired in the field.



If not dividing the field by a specific separator, you may divide it by a specified length.

1. Read the barcode below to divide field 4 by length.

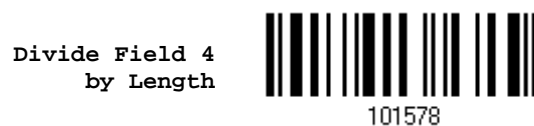

2. Read the "Decimal Value" barcode on page 267 for the desired field length.
3. Read the "Validate" barcode on the same page to complete this setting.



Field 5 Setting

1. Read the barcode below to divide field 5 by a specified terminating string.

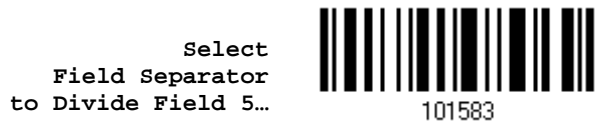

2. Read the "Hexadecimal Value" barcode on page 268 for the desired character string.
3. Read the "Validate" barcode to complete this setting.
4. Read the "Discard Separator" barcode if the field separator is not desired in the field.



If not dividing the field by a specific separator, you may divide it by a specified length.

1. Read the barcode below to divide field 5 by length.



2. Read the "Decimal Value" barcode on page 267 for the desired field length.
3. Read the "Validate" barcode on the same page to complete this setting.



Additional Fields

Up to five additional fields can be created for each editing format; each of them is numbered from AF1 to AF5 accordingly.

- ▶ If "BT HID", "USB HID" or "Keyboard Wedge" is configured for interface, Key Type and Key Status will then become applicable. You may decide whether or not to apply Key Status when "Normal Key" is selected for Key Type.

Key Type		Key Status
Scan Code	Up to 2 scan code values are allowed.	N/A
Normal Key	Up to 4 character strings are allowed.	<ul style="list-style-type: none"> ▶ Add Shift ▶ Add Left Ctrl ▶ Add Left Alt ▶ Add Right Ctrl ▶ Add Right Alt Refer to Keyboard Wedge Table.

1. Read the barcode below to specify an additional field, one at a time.

Additional Field 1...



Additional Field 2...



Additional Field 3...



Additional Field 4...



Additional Field 5...



2. Read the "Hexadecimal Value" barcode on page 268 for the desired additional field.
3. Read the "Validate" barcode to complete this setting.



6.4.5 PAUSE FIELD SETTING

Pause Field Time

You can limit the pause time interval (1~16). By default, it is set to 1 second.

Pause Field Time
1~16 sec.
(*1)



1. Read the barcode above to specify the time interval for the Pause Field. (It is set to 1 by default.)
2. Read the "Decimal Value" barcode on page 267. For example, read "1" and "0" for setting the Pause Field Time to 10 seconds.
3. Read the "Validate" barcode on the same page to complete this setting.



6.5 CONFIGURING FORMAT – DEFINE TRANSMISSION SEQUENCE

After configuring the data fields and additional fields, you must now program the transmission sequence of these fields that comprise the final data. This field transmission sequence can be assigned in any desired order and fields can be assigned multiple times as well.

Note: Up to twelve fields can be assigned.

- 1) Read the “Start” barcode to begin with programming the field transmission sequence.

Start Programming..



101589

- 2) Program the transmission sequence by reading the desired fields as well as additional fields.

Field 1



109901

Field 2



109902

Field 3



109903

Field 4



109904

Field 5



109905

Field 6



109906

Additional Field 1



109907

Additional Field 2



109908



Additional Field 3



109909

Additional Field 4



109910

Additional Field 5



109911

Pause Field



109912

Null Character Field



109913

3) Read the "End" barcode to complete this setting.

End Programming..



109994



6.6 PROGRAMMING EXAMPLES

6.6.1 EXAMPLE I

Extract data from the 10th character to the 19th character...

The editing format should be configured as follows:

1. Read the "Enter Setup" barcode to enter the Configuration Mode.
2. Read the "Configure Format 1" barcode.
3. Read the "Clear All" and "Code 128" barcodes for applicable code type.
4. Read the "Three Fields" barcode.
5. Read the "Divide Field 1 by Length" barcode, and set length to 9.
Field 1 data starts from the 1st character to the 9th character.
6. Read the "Divide Field 2 by Length" barcode, and set length to 10.
Field 2 data starts from the 10th character to the 19th character.
7. Read the "Start (Programming)" barcode to program the transmission sequence.
8. Read the "Field 2" barcode.
9. Read the "End" barcode to complete the transmission sequence setting.
10. Read the "End Programming Format" barcode to complete the setting of Editing Format 1.
11. Read the "Enable Format 1" barcode to apply Editing Format 1 to Code 128.
12. Read the "Update" barcode to exit the Configuration Mode.



6.6.2 EXAMPLE II

Extract the date code, item number, and quantity information from barcodes.

Data in a barcode is encoded like this:

- ▶ From the 1st character to the 6th character is the date code.
- ▶ From the 7th character to the dash '-' character is the item number.
- ▶ After the dash '-' character is the quantity information.

Data will be transmitted like this:

- ▶ The item number goes first, then a TAB character, followed by the date code, then another TAB character, and finally the quantity information.

The editing format should be configured as follows:

1. Read the "Enter Setup" barcode to enter the Configuration Mode.
2. Read the "Configure Format 2" barcode.
3. Read the "Three Fields" barcode.
4. Read the "Divide Field 1 by Length" barcode, and set length to 6.
Field 1 data starts from the 1st character to the 6th character.
5. Read the "Select Field Separator to Divide Field 2" barcode, and use a dash '-' character.
Field 2 data starts from the 7th character until the dash '-' character is met.
6. Read the "Additional Field 1" barcode, and use a tab character for the field.
7. Read the "Start (Programming)" barcode to program the transmission sequence.
8. Read the "Field 2", "Additional Field 1", "Field 1", "Additional Field 1", "Field 3" barcodes.
9. Read the "End" barcode to complete the transmission sequence (F2 A1 F1 A1 F3) setting.
10. Read the "End Programming Format" barcode to complete the setting of Editing Format 1.
11. Read the "Enable Format 2" barcode to apply Editing Format 2 to all code types.
12. Read the "Update" barcode to exit the Configuration Mode.





SPECIFICATIONS

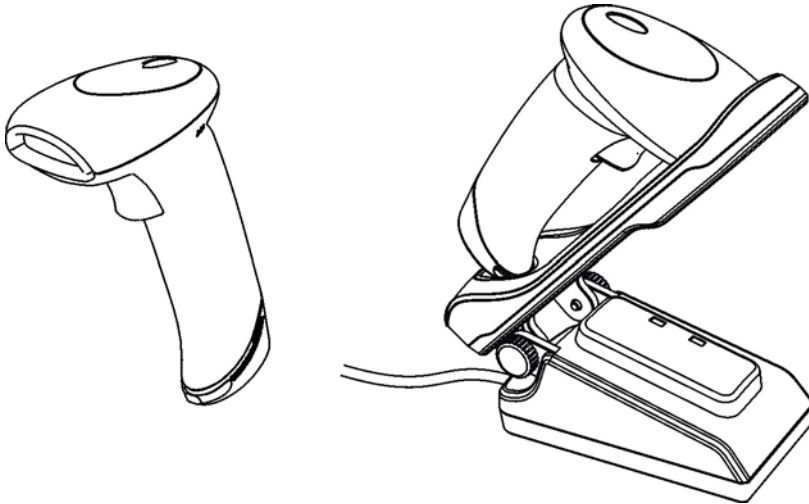

Optical Characteristics	1564A
Scan Engine	2D Imager
Light Source	Visible red LED
RF Characteristics	
WPAN Module	Wireless PAN BT Class 2 compliance
Coverage (line-of-sight)	90 meters with 3656
Interface Supported	<ul style="list-style-type: none"> ▶ Serial Port Profile (BT SPP) ▶ Human Interface Device Profile (BT HID) ▶ 3656
Physical Characteristics	
Memory	<ul style="list-style-type: none"> ▶ 10 KB for transmit buffer ▶ 4 MB flash for memory mode
Switch	Tactile switch
Indication	Triple-color LED (Red/Green/Blue) and beeper
Weight	Approx. 185 g



Electrical Characteristics		
Battery	Rechargeable Li-ion battery – 3.7 V, 800 mAh	
Power Adaptor		
Input	AC 100~240 V, 50/60 Hz	
Output	DC 5V, 2A (3656) DC 5V, 0.5A (Battery Charger)	
Operating Temperature	0 °C to 40 °C	
Environmental Characteristics		
Temperature	Operating	0 °C to 50 °C
	Storage	-20 °C to 60 °C
Humidity (Non-condensing)	Operating	10% to 90%
	Storage	5% to 95%
Resistance		
Impact Resistance	1.2 m, 5 drops per 6 sides	
Splash / Dust Resistance	IP 30	
Electrostatic Discharge	± 15 kV air discharge, ± 8 kV contact discharge	
Programming Support		
Configuration	Setup barcodes or host serial commands.	
Software	Windows®-based ScanMaster	
Firmware upgradeable	Download firmware updates via the download utility.	
Accessories (√ means “supported”)		
Rechargeable Li-ion Battery	√	
Battery Charger	√	
3656 Stand	√	
USB Cable	√	
RS-232 Cable	√	
Keyboard Wedge Cable	√	

Note: The 3656 stand is not only capable of charging the 1564A scanner, but specifically designed for the scanner to communicate with a host computer wirelessly.



错误！使用“开始”选项卡将 Heading 1 应用于要在此处显示的文字。



FIRMWARE UPGRADE

You can only upgrade firmware of one scanner at a time. For example, you must turn off each of the rest 1564A scanners when there is more than one scanner connected to your computer.

Note: In case it fails downloading due to low battery, make sure the target scanner is loaded with good battery and the battery charge is enough.

HOW TO UPGRADE 1564A FIRMWARE

USING 3656

- 1) Connect the interface cable, RS-232 or USB, between 3656 and your computer. For USB Virtual COM, you may need to install its driver first!
- 2) Connect the power supply cord from 3656 to a proper power outlet.
- 3) Refer to 3.1.1 Connect to 3656 for the target scanner to connect to 3656.

Read the "Set Connection" label first, and then the "Serial Number" label. Both labels can be located at the back of 3656.

- 4) Read the following barcodes in sequence to configure the scanner to use RS-232 as download interface.



Or, read the following barcodes in sequence to configure the scanner to use USB Virtual COM as download interface.



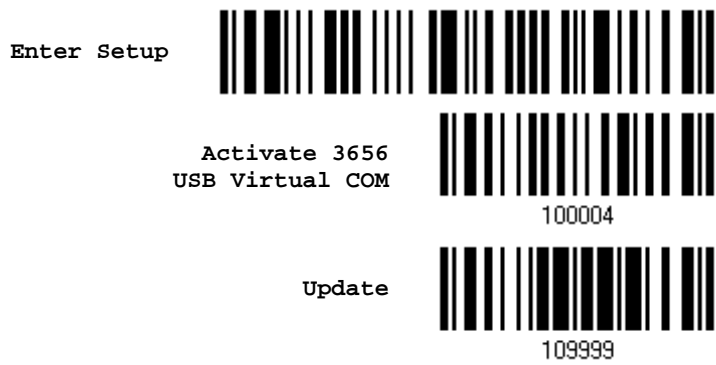

5) Read the following barcodes in sequence for the scanner to enter the download mode. The scanner will respond with beeps to indicate it is ready for downloading.



6) Run the download utility "ProgLoad.exe" on your computer.

Kernel Program	User Program
K1564A_V*.shx	STD1564A_V*.shx

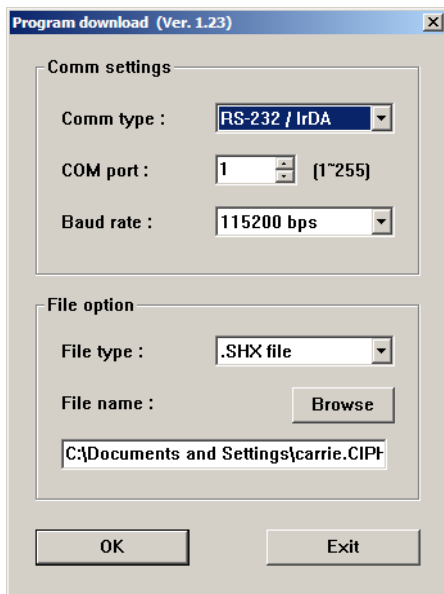

- ▶ For the communication settings, select "RS-232" and the correct COM port for RS-232 or USB Virtual COM interface.
- ▶ For RS-232, select 115200 bps for baud rate; for USB Virtual COM, ignore the baud rate setting.
- ▶ For the file option, click [Browse] to select the target file for firmware update.
- ▶ Click [OK].

7) After upgrading kernel, you will need to manually restart the scanner.

After upgrading the user program, the scanner will automatically restart itself once the download is completed successfully.



Note: The output interface remains unchanged as specified in step 3 (= RS-232 or USB Virtual COM). For RS-232, the baud rate setting is still 115200 bps!



USING *BLUETOOTH*[®] DONGLE

- 1) Refer to [3.2.3 Connect to Dongle](#) for the target scanner to accept the connection request from your computer.
- 2) Read the following barcodes in sequence to configure the scanner to use BT SPP as download interface.

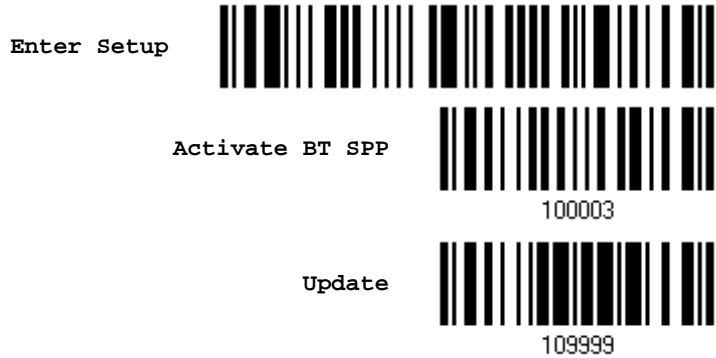

- 3) Read the following barcodes in sequence for the scanner to enter the download mode. The scanner will respond with beeps to indicate it is ready for downloading.



- 4) Run the download utility "ProgLoad.exe" on your computer.

Kernel Program	User Program
K1564A_V*.shx	STD1564A_V*.shx



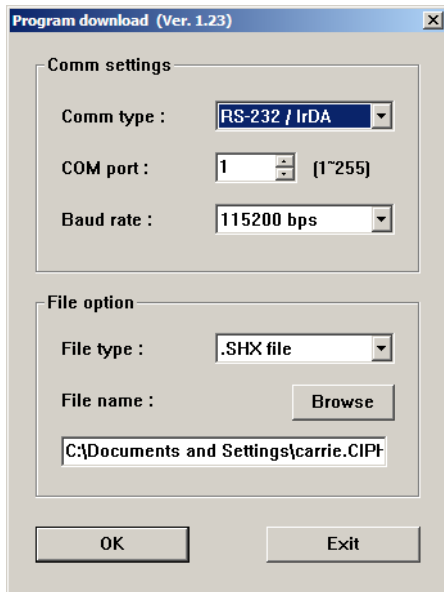

- ▶ For the communication settings, select "RS-232" and the correct COM port for BT SPP interface.
- ▶ Ignore the baud rate setting.
- ▶ For the file option, click [Browse] to select the target file for firmware update.
- ▶ Click [OK].

5) After upgrading kernel, you will need to manually restart the scanner.

After upgrading the user program, the scanner will automatically restart itself once the download is completed successfully.

Note: The output interface remains unchanged as specified in step 2 (= BT SPP).



HOW TO UPGRADE 3656 FIRMWARE

UPGRADING 3656 CPU FIRMWARE

- 1) Connect the interface cable, RS-232 or USB, between 3656 and your computer. For USB Virtual COM, you may need to install its driver first!
- 2) Connect the power supply cord from 3656 to a proper power outlet.
- 3) Refer to 3.1.1 Connect to 3656 for the target scanner to connect to 3656.

Read the "Set Connection" label first, and then the "Serial Number" label. Both labels can be located at the back of 3656.

- 4) Read the following barcodes in sequence to configure the scanner to use RS-232 as download interface.

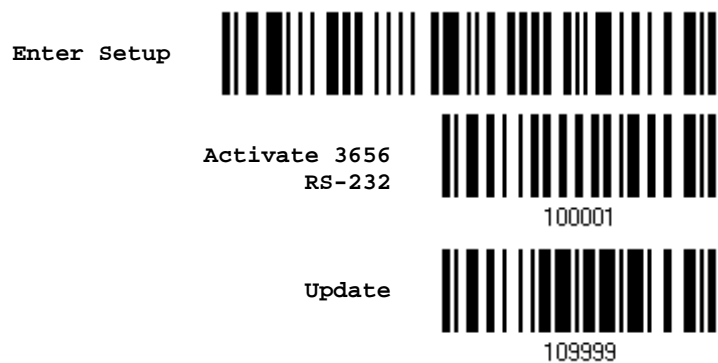

Or, read the following barcodes in sequence to configure the scanner to use USB Virtual COM as download interface.

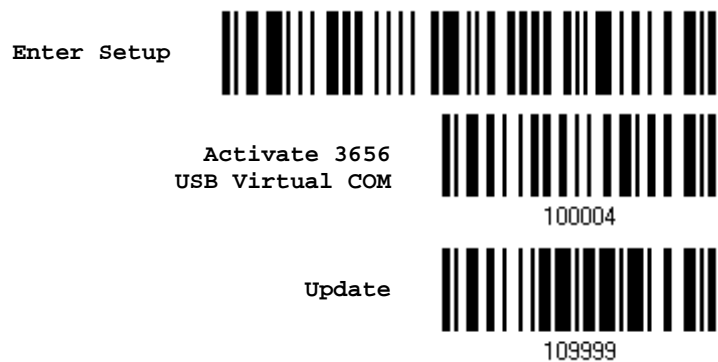

- 5) Read the following barcodes in sequence for 3656 to enter the download mode. The Communication LED on 3656 will be flashing red to indicate it is ready for downloading.



Enter Setup



Download 3656
CPU Firmware



Download

6) Run the download utility "ProgLoad.exe" on your computer.

Kernel Program	User Program
K3656_V*.shx	STD3656_V*.shx

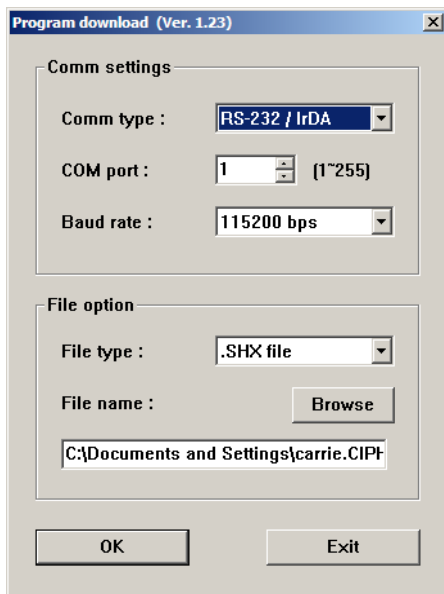

- ▶ For the communication settings, select "RS-232" and the correct COM port for RS-232 or USB Virtual COM interface.
- ▶ For RS-232, select 115200 bps for baud rate; for USB Virtual COM, ignore the baud rate setting.
- ▶ For the file option, click [Browse] to select the target file for firmware update.
- ▶ Click [OK].

7) The 3656 will automatically restart itself when upgrading firmware is completed successfully.

8) Read the "Update" barcode for the scanner to resume its operation (exit the configuration mode).

Update



109999



UPGRADING 3656 USB BRIDGE FIRMWARE

- 1) Connect the USB cable between 3656 and your computer. For USB Virtual COM, you may need to install its driver first!
- 2) Connect the power supply cord from 3656 to a proper power outlet.
- 3) Refer to 3.1.1 Connect to 3656 for the target scanner to connect to 3656.
Read the "Set Connection" label first, and then the "Serial Number" label. Both labels can be located at the back of 3656.
- 4) Read the following barcodes in sequence to configure the scanner to use USB Virtual COM as download interface.

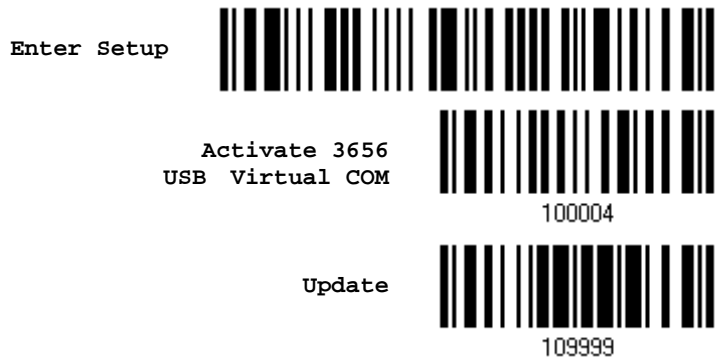

Note: You can download USB Bridge firmware via USB Virtual COM only!

- 5) Read the following barcodes in sequence for 3656 to enter the download mode. The Communication LED on 3656 will be flashing red to indicate it is ready for downloading.



- 6) Run the download utility "ProgLoad.exe" on your computer.

Kernel Program	User Program
K3656Bridge_V*.shx	STD3656Bridge_V*.shx



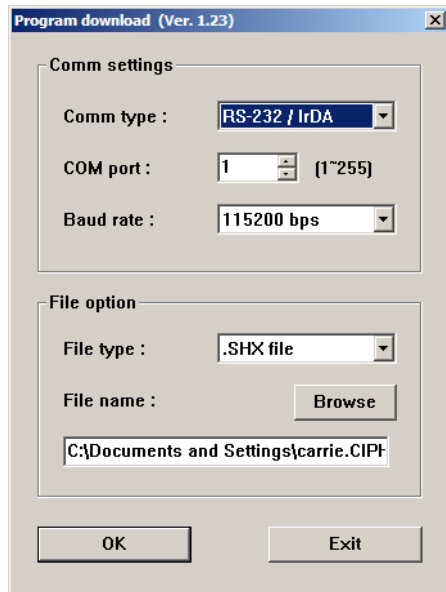

- ▶ For the communication settings, select "RS-232" and the correct COM port for USB Virtual COM interface.
- ▶ Ignore the baud rate setting.
- ▶ For the file option, click [Browse] to select the target file for firmware update.
- ▶ Click [OK].

- 7) The 3656 will automatically restart itself when upgrading firmware is completed successfully.
- 8) Read the "Update" barcode for the scanner to resume its operation (exit the configuration mode).





HOST SERIAL COMMANDS

1564A SERIAL COMMANDS

D

Purpose To disable the scanner.
Remarks "D"

E

Purpose To enable the scanner.
Remarks "E"

#@ nnnnnn <CR>

Purpose To configure the scanner.
Remarks nnnnnn – the six digits of command parameters.
For example, "109952" is to list the current Code ID settings.

List Page 3

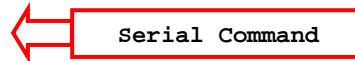

"0x23" + "0x40" + "0x31" + "0x30" + "0x39" + "0x39" + "0x35" + "0x32" + "0x0d"

Note: After configuring the scanner, you may send the serial command "#@109999" to save the settings.

#@ - - - <CR>

Purpose To halt the scanner.
Remarks "0x23" + "0x40" + "0x2d" + "0x2d" + "0x2d" + "0x2d" + "0x0d"

#@ <CR>

Purpose To resume operation.
Remarks "0x23" + "0x40" + "0x2e" + "0x2e" + "0x2e" + "0x2e" + "0x0d"

#@////<CR>

Purpose To respond with a beep.
Remarks "0x23" + "0x40" + "0x2f" + "0x2f" + "0x2f" + "0x2f" + "0x0d"



#@TRIGOFF<CR>

Purpose	To disable the software trigger
Remarks	"0x23" + "0x40" + "0x54" + "0x52" + "0x49" + "0x47" + "0x4f" + "0x46" + "0x46" + "0x0d"

#@TRIGON<CR>

Purpose	To enable the software trigger
Remarks	"0x23" + "0x40" + "0x54" + "0x52" + "0x49" + "0x47" + "0x4f" + "0x4e" + "0x0d"

#@RDSN<CR>

Purpose	Read serial number
Remarks	"0x23" + "0x40" + "0x52" + "0x44" + "0x53" + "0x4E" + "0x0D"

#@BEEP, nn<CR>

Purpose	Have the scanner beep as many times as you specified ranging from 00 to 99 times (00 is to stop the work). The length of beep time is based on the duration of Good Read Beep setting and the constant interval between two beeps is 100ms.
Remarks	nn – the two digits of command parameters For example, '#@BEEP,09' is to have the scanner beep for 9 times. "0x23" + "0x40" + "0x42" + "0x45" + "0x45" + "0x50" + "0x2c" + "0x30" + "0x39" + "0x0d"

#@RLED, nn<CR>

Purpose	Have the scanner's red LED indicator blink as many times as you specified ranging from 00 to 99 (00 is to stop the work). The length of blinking time is based on the Good Read LED Duration setting and the constant interval between two flashes is 200ms.
Remarks	nn –the two digits of command parameters For example, '#@RLED,09' is to have the scanner blink for 9 times. "0x23" + "0x40" + "0x52" + "0x4c" + "0x45" + "0x44" + "0x2c" + "0x30" + "0x39" + "0x0d"

#@GLED, nn<CR>

Purpose	Have the scanner's green LED indicator blink as many times as you specified ranging from 00 to 99 (00 is to stop the work). The length of blinking time is based on the Good Read LED Duration setting and the constant interval between two flashes is 200ms.
Remarks	nn – the two digits of command parameters



For example, '#@GLED,09' is to have the scanner blink for 9 times.

```
"0x23" + "0x40" + "0x47" + "0x4c" + "0x45" + "0x44" + "0x2c" + "0x30"
+ "0x39" + "0x0d"
```

EXAMPLE

You may run HyperTerminal.exe on the host computer to send serial commands to the 1564A scanner via RS-232, USB Virtual COM or BT SPP.

- ▶ For the scanner to stop immediately –
D
- ▶ For the scanner to resume working –
E
- ▶ For the scanner to change the beeper to medium volume and beep –
#@101011<CR>
#@////<CR>
- ▶ For the scanner to change the beeper to minimal volume and beep –
#@101010<CR>
#@////<CR>
- ▶ For the scanner to change the beeper frequency to 8 kHz (for Good Read Beep only) and beep –
#@101001<CR>
#@////<CR>
- ▶ For the scanner to change the beeper length to longest (for Good Read Beep only) and beep –
#@101008<CR>
#@////<CR>
- ▶ For the scanner to save the settings, send the serial command "#@109999" –
#@101011<CR>
#@109999<CR>
- ▶ For the scanner to read the serial number and beep –
#@RDSN<CR>
#@////<CR>
- ▶ For the scanner to beep for nine times –
#@BEEP,09<CR>
- ▶ For the scanner's LED indicator to blink in red for nine times –
#@RLED,09<CR>
- ▶ For the scanner's LED indicator to blink in green for nine times –
#@GLED,09<CR>



Note: (1) For RS-232 or USB Virtual COM, you can only configure the first scanner that connects to 3656. To identify the scanner, you may send the serial command to have it respond with a beep.
(2) For BT SPP, you can configure up to seven scanners at the same time.



3656 SETUP BARCODES & SERIAL COMMANDS

Normally, you can configure the 3656 stand by having a connected scanner read 3656-related setup barcodes.

- 1) Connect the interface cable, RS-232, Keyboard Wedge or USB, between 3656 and your computer.
- 2) For USB Virtual COM, you may need to install its driver first!
- 3) Connect the power supply cord from 3656 to a proper power outlet.

Read the "Set Connection" label first, and then the "Serial Number" label. Both labels can be located at the back of 3656.

- 4) Refer to [3.1.1 Connect to 3656](#) for the target scanner to connect to 3656.
- 5) Read the following barcodes in sequence to configure 3656.

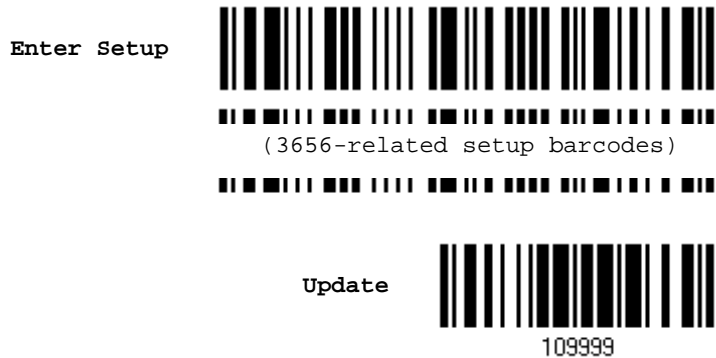

For 3656-related setup barcodes, refer to the Serial Command table below. Note that for the "Version" and "GetID" barcodes, you must run HyperTerminal.exe or any text editor to receive the information.

- ▶ If the output interface is RS-232 or USB Virtual COM, run HyperTerminal.exe on your computer to receive the information.
- ▶ If the output interface is Keyboard Wedge or USB HID, run any text editor to receive the information.



3656 SERIAL COMMAND AND EQUIVALENT SETUP BARCODES

Config<CR>

Purpose To configure 3656.

Here is the setup barcode for this serial command:



Remarks A list of the current settings will be displayed. Run HyperTerminal.exe on your computer and change the settings one by one.

DefaultSetting<CR>

Purpose To restore the default settings.

Here is the setup barcode for this serial command:



SingleConnection<CR>

Purpose To allow only one scanner connecting to 3656.

Here is the setup barcode for this serial command:



MultiConnection<CR>

Purpose To allow up to seven scanners connecting to 3656.

Here is the setup barcode for this serial command:



UseOnePortforAll<CR>

Purpose To use one Virtual COM port for all whenever connecting 3656 to PC via USB. This setting requires you to connect one 3656 at a time, and will facilitate configuring a great amount of 3656 via the same Virtual COM port (for administrators' or factory use).

Here is the setup barcode for this serial command:



UseVariablePort<CR>

Purpose To use variable Virtual COM port when connecting more than one 3656 to PC via USB.

Here is the setup barcode for this serial command:



Version<CR>

Purpose To get the firmware versions (CPU+USB Bridge).

Here is the setup barcode for this serial command:



GetID<CR>

Purpose To get MAC ID.

Here is the setup barcode for this serial command:



Download<CR>

Purpose To download CPU firmware to 3656 via RS-232 or USB.

Here is the setup barcode for this serial command:



LoadBridge<CR>

Purpose To download USB Bridge firmware to 3656 via USB only.

Here is the setup barcode for this serial command:



EXAMPLE

Without using the scanner to read the above setup barcodes for configuring the 3656 stand, you may run HyperTerminal.exe on the host computer to send serial commands to 3656 via RS-232 or USB.

- 1) Connect the interface cable, RS-232 or USB, between 3656 and your computer.

For USB Virtual COM, you may need to install its driver first!

- 2) Connect the power supply cord from 3656 to a proper power outlet.

The Communication LED will indicate when 3656 can accept serial commands after initializing. Refer to the table below.

- ▶ If the output interface is USB Virtual COM or RS-232, run HyperTerminal.exe on your computer. While the Communication LED on 3656 is purple (red with flashing blue), type the serial command within three seconds.
- ▶ If the output interface is USB HID, press the "Num Lock" or "Caps Lock" key on your keyboard 5 times within 3 seconds while the Communication LED on 3656 is flashing red and blue. This will change the interface from USB HID to USB Virtual COM and the Communication LED will become purple (red with flashing blue). Then, run HyperTerminal.exe on your computer. While the Communication LED on 3656 is purple (red with flashing blue), type the serial command within three seconds. After configuring via serial commands, the interface will be reset to USB HID after re-connecting the power supply cord.

Communication LED		Meaning
---	Blue, solid	Initialize
Red, solid	Blue, flashing	Serial command mode with USB Virtual COM or RS-232: wait 3 seconds for starting a serial command
Red, flashing	Blue, flashing	Serial command mode with USB HID changed to USB Virtual COM first: wait 3 seconds for pressing [Num Lock] or [Caps Lock] 5 times via keyboard



Appendix III

KEYBOARD WEDGE TABLE

The table below features special keyboard wedge codes applied to the scanner by default. If you have determined to bypass this special keyboard, please refer to the table on the next page.

"Apply" Special Keyboard									
	0	1	2	3	4	5	6	7	8
0		F2	SP	0	@	P	`	p	⓪
1	INS	F3	!	1	A	Q	a	q	①
2	DLT	F4	"	2	B	R	b	r	②
3	Home	F5	#	3	C	S	c	s	③
4	End	F6	\$	4	D	T	d	t	④
5	Up	F7	%	5	E	U	e	u	⑤
6	Down	F8	&	6	F	V	f	v	⑥
7	Left	F9	'	7	G	W	g	w	⑦
8	BS	F10	(8	H	X	h	x	⑧
9	HT	F11)	9	I	Y	i	y	⑨
A	LF	F12	*	:	J	Z	j	z	
B	Right	ESC	+	;	K	[k	{	
C	PgUp	Exec	,	<	L	\	l		
D	CR	CR*	-	=	M]	m	}	
E	PgDn		.	>	N	^	n	~	
F	F1		/	?	O	_	o	Dly	ENTER*

Note: (1) ①~⑨: Digits of numeric keypad.
 (2) CR*/ENTER*: ENTER key on the numeric keypad.



"Bypass" Special Keyboard									
	0	1	2	3	4	5	6	7	8
0			SP	0	@	P	`	p	
1			!	1	A	Q	a	q	
2			"	2	B	R	b	r	
3			#	3	C	S	c	s	
4			\$	4	D	T	d	t	
5			%	5	E	U	e	u	
6			&	6	F	V	f	v	
7			'	7	G	W	g	w	
8	BS		(8	H	X	h	x	
9	HT)	9	I	Y	i	y	
A	LF		*	:	J	Z	j	z	
B		ESC	+	;	K	[k	{	
C			,	<	L	\	l		
D	CR		-	=	M]	m	}	
E			.	>	N	^	n	~	
F			/	?	O	_	o	Dly	



KEY TYPE & STATUS

KEY TYPE

If "BT HID", "USB HID" or "Keyboard Wedge" is configured for interface, Key Type and Key Status will then become applicable.

*Normal



109926

Scan Code



109936

KEY STATUS

Decide whether or not to change key status when "Normal Key" is selected for Key Type.

Add Shift



109930

Add Left Ctrl



109931

Add Right Ctrl



109933

Add Left Alt



109932

Add Right Alt



109934



EXAMPLE

KEY TYPE = NORMAL

For example, if you want to program the character "!" as the prefix code:

1. Read the "Configure Prefix" barcode.
2. Read the "Hexadecimal Value" barcode on page 268 for "2" and "1".
3. Read the "Validate" barcode to complete this setting.

KEY TYPE = SCAN CODE

For example, if you want to program the character "a" (= "1C" on the scan code table) as the prefix code:

1. Read the "Configure Prefix" barcode.
2. Read the "Scan Code" barcode.
3. Read the "Hexadecimal Value" barcode on page 268 for "1" and "C".
4. Read the "Validate" barcode to complete this setting.

KEY TYPE = NORMAL + KEY STATUS = SHIFT

For example, if you want to program the character "!" (= "Shift" + "1" on keyboard) as the prefix code:

1. Read the "Configure Prefix" barcode.
2. Read the "Add Shift" barcode.
3. Read the "Hexadecimal Value" barcode on page 268 for "3" and "1".
4. Read the "Validate" barcode to complete this setting.

KEY TYPE = NORMAL + KEY STATUS = CTRL

For example, if you want to program "Ctrl+A" and "Ctrl+\$" as the prefix code:

1. Read the "Configure Prefix" barcode.
2. Read the "Add Left Ctrl" barcode.
3. Read the "Hexadecimal Value" barcode on page 268 for "4", "1" (= "A").
4. Read the "Add Left Ctrl" barcode.
5. Read the "Hexadecimal Value" barcode on page 268 for "2", "4" (= "\$").
6. Read the "Validate" barcode to complete this setting.



NUMERAL SYSTEMS

DECIMAL SYSTEM

Decimal



Validate the Values



Validate

Update



Abort



HEXADECIMAL SYSTEM

Hexadecimal



Validate the Values



Validate

ASCII TABLE

	0	1	2	3	4	5	6	7	
0		DLE	SP	0	@	P	`	p	
1	SOH	DC1	!	1	A	Q	a	q	
2	STX	DC2	"	2	B	R	b	r	
3	ETX	DC3	#	3	C	S	c	s	
4	EOT	DC4	\$	4	D	T	d	t	
5	ENQ	NAK	%	5	E	U	e	u	
6	ACK	SYN	&	6	F	V	f	v	
7	BEL	ETB	'	7	G	W	g	w	
8	BS	CAN	(8	H	X	h	x	
9	HT	EM)	9	I	Y	i	y	
A	LF	SUB	*	:	J	Z	j	z	
B	VT	ESC	+	;	K	[k	{	
C	FF	FS	,	<	L	\	l		
D	CR	GS	-	=	M]	m	}	
E	SO	RS	.	>	N	^	n	~	
F	SI	US	/	?	O	_	o	DEL	

Update



Abort



ENTERING PIN CODE FOR AUTHENTICATION

USE PRESET PIN

- 1) In the configuration mode, read the barcode below to use a preset PIN for authentication.

Use Preset PIN



100155

- 2) Read one of the barcodes to specify the PIN code, in decimal or hexadecimal.
By default, the PIN code is set to "0000". Maximum 16 characters are allowed.

Enter PIN in
Hexadecimal...



100150

Enter PIN in
Decimal...



100151

- 3) Read the "Decimal Value" barcode on page 267 or the "Hexadecimal Value" barcode on page 268 for the desired digits or character string.

Read the "Clear PIN Code" barcode first if you need to re-input the PIN code.

Clear PIN Code



109973

- 4) Read the "Validate" barcode to complete this setting.



DISABLE AUTHENTICATION OR USE RANDOM PIN

In the configuration mode, read the barcode below to disable authentication (= No PIN) or use a random PIN for authentication.

*No PIN or
use random PIN



Note: When using BT HID, some device driver may not support pre-defined PIN code for authentication. In this case, make sure you have the scanner set to “No PIN or use random PIN” before pairing. While pairing, the host PIN code will be displayed on the computer screen.

Use Random PIN

When the target device is set to use a random PIN for authentication, wait until the random PIN is displayed on the target device while pairing, and then input the matching PIN code on the scanner.

Note: Follow the steps below to enter the matching PIN on the scanner. There is no need to enter the configuration mode!

1. Read one of the barcodes to specify the PIN code, in decimal or hexadecimal.

Enter PIN in
Hexadecimal...



Enter PIN in
Decimal...



2. Read the “[Decimal Value](#)” barcode on page 267 or the “[Hexadecimal Value](#)” barcode on page 268 for the desired digits or character string.

Read the “Clear PIN Code” barcode first if you need to re-input the PIN.

Clear PIN Code



3. Read the “Validate” barcode to complete this setting.

Reject Random PIN Request

When the random PIN is displayed on the target device while pairing, you can reject the PIN request by having the scanner read the “Validate” barcode.

Update



Abort





Appendix V

READING DRIVER LICENSES

1564A is capable of reading 2D driver's licenses and other American Association of Motor Vehicle Administrators (AAMVA) compliant ID cards. For compliant 2D licensed card scanning, it decodes the information embedded in the ID cards to a formatted data. This appendix provides the setup barcodes required while ScanMaster utility provides GUI setup that is organized and easy-to-use.

Note: The configured settings are saved in flash memory for access once a driver's license is read.

LICENSE PARSING SETUP

*License Parse Disable



License Parse Enable



Parse Field Clear



FILE TYPE

You can check the file type of ANSI by scanning the barcode as below.

*Enable



Disable



Update











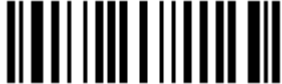

Abort











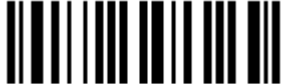



OUTPUT SEQUENCE SETUP

1564A supports arranging the sequences of license embedded data via separators and fields. In order to present data in a consistent format, some barcodes (ex. First Name, Middle Name/Initial, Last Name, Name suffix, Name Prefix, Birth Date and so on) will return data based on the calculated actual data contained in the ID barcode.

Full Name	
	103011
Last Name	
	103012
First Name	
	103013
Middle Name/Initial	
	103014
Name Suffix	
	103015
Name Prefix	
	103016
Mailing Address Line1	
	103017
Mailing Address Line2	
	103018
Mailing Address City	
	103019
Mailing Address State	
	103020



Mailing Address Postal Code	 103021
Home Address Line1	 103022
Home Address Line2	 103023
Home Address City	 103024
Home Address State	 103025
Home Address Postal Code	 103026
License ID Number	 103027
License Class	 103028
License Restrictions	 103029
License Endorsements	 103030
Height (Feet and/or Inches)	 103031
Height (Centimeters)	 103032

Update





Abort



Weight (Pounds)	 103033
Weight (Kilograms)	 103034
Eye Color	 103035
Hair Color	 103036
License Expiration Date	 103037
Birth Date	 103038
Gender	 103039
License Issue Date	 103040
Issue Timestamp	 103041
Number of Duplicates	 103042
Medical Codes	 103043
Organ Donor	 103044















Nonresident	 103045
Customer ID	 103046
Social Security Number	 103047
AKA Birth Date	 103048
AKA Social Security Name	 103049
AKA Full Name	 103050
AKA Last Name	 103051
AKA First Name	 103052
AKA Middle Name/Initial	 103053
AKA Name Suffix	 103054
AKA Name Prefix	 103055
Weight Range	 103056

Update



Abort



Document Discriminator	 103057
Country	 103058
Federal Commission Codes	 103059
Place of Birth	 103060
Audit Information	 103061
Inventory Control	 103062
Race/Ethnicity	 103063
Std Vehicle Class	 103064
Std Restrictions	 103065
Std Endorsements	 103066
Class Description	 103067
Endorsement Description	 103068



Restrictions
Description



103069

Permit Class



103070

Permit Expiration
Date



103071

Permit ID Number



103072

Permit Issue Date



103073

Permit Restrictions



103074

Permit endorsements



103075

Issuer ID Number



103076

Family Name
Truncation



103077

First Name
Truncation



103078

Middle Name
Truncation



103079

Update













Abort



SEPARATORS AND FIELDS

Define the separators that separate fields during the transmission sequence of data scanning. In addition to the built-in data elements, you can also specify up to 5 Additional Fields with 4 bytes characters. Program the transmission sequence by reading the desired fields as additional fields.

Note: Up to 5 separators can be assigned.

Separator 1 (1 byte) *"Space"	
	103128
Separator 2 (1 byte) *"Enter"	
	103129
Separator 3 (1 byte) *","	
	103130
Separator 4 (1 byte) *"."	
	103131
Separator 5 (1 byte) *"_"	
	103132
Additional Field 1 (4 bytes)	
	103133
Additional Field 2 (4 bytes)	
	103134
Additional Field 3 (4 bytes)	
	103135
Additional Field 4 (4 bytes)	
	103136
Additional Field 5 (4 bytes)	
	103137



EDIT SEPARATORS

All the driver license fields can be split with a pre-selected separator, for example, "-" as First Name-Last Name or ":" as First Name:Last Name.

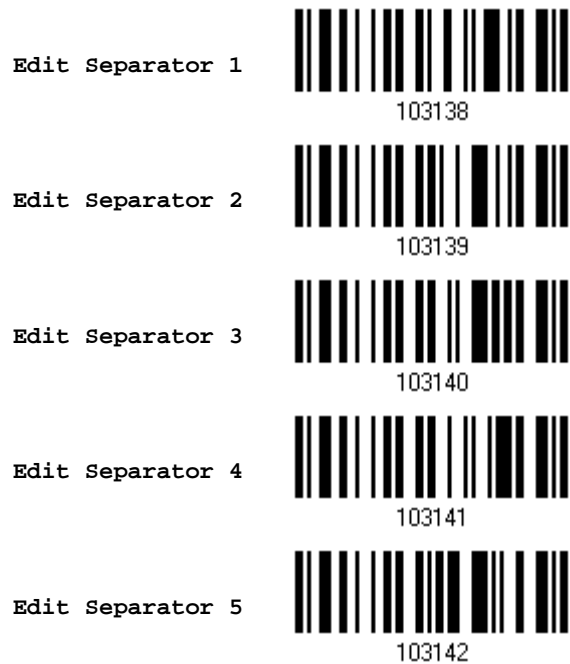

- 1) Read the barcode above to apply separator to driver license information separately, and follow steps 2~3.
- 2) Read the "Hexadecimal Value" barcode for the desired character string. For example, read "3" and "A" for the separator to split the data with character [:].
- 3) Read the "Validate" barcode on the same page to complete this setting.

Update



Abort



EDIT FIELDS

Up to five additional fields can be created for each editing format; each of them is numbered from Additional 1 to Additional 5 accordingly.

- ▶ If “Bluetooth® HID” or “USB HID” is configured for interface, Key Type and Key Status will then become applicable. You may decide whether or not to apply Key Status when “Normal Key” is selected for Key Type.

Key Type		Key Status
Scan Code	Up to 2 scan code values are allowed.	N/A
Normal Key	Up to 4 character strings are allowed.	<ul style="list-style-type: none"> ▶ Add Shift ▶ Add Left Ctrl ▶ Add Left Alt ▶ Add Right Ctrl ▶ Add Right Alt Refer to Keyboard Wedge Table.

Edit Additional Field 1



103143

Edit Additional Field 2



103144

Edit Additional Field 3



103145

Edit Additional Field 4



103146

Edit Additional Field 5



103147

- 1) Read the barcode above to specify an additional field, one at a time.
- 2) Read the “Hexadecimal Value” barcode for the desired additional field.
- 3) Read the “Validate” barcode on the same page to complete this setting.

