Reference Manual



8500

Version 0.69



Copyright Notice

Copyright © 2005 Syntech Information Company Limited.

All rights reserved

The software contains proprietary information of Syntech Information Company; it is provided under a license agreement containing restrictions on use and disclosure and is also protected by copyright law. Reverse engineering of the software is prohibited.

Due to continued product development this information may change without notice. The information and intellectual property contained herein is confidential between Syntech Information and the client and remains the exclusive property of Syntech Information. If you find any problems in the documentation, please report them to us in writing. Syntech Information does not warrant that this document is error-free.

No part of this publication may be reproduced, stored in a retrieval system, or transmitted in any form or by any means, electronic, mechanical, photocopying, recording or otherwise without the prior written permission of Syntech Information.

For product consultancy and technical support, please contact your local sales representative. Also, you may visit our web site for more information.

The CipherLab logo is a registered trademark of Syntech Information Co., Ltd.

Syntech Information Co., Ltd.
Website: <http://www.cipherlab.com>

FCC & Canada Regulations:

● This device complies with part 15 of the FCC Rules. Operation is subject to the following two conditions: (1) This device may not cause harmful interference, and (2) this device must accept any interference received, including interference that may cause undesired operation.

● This device has been tested and found to comply with the limits for a Class B digital device, pursuant to Part 15 of the FCC Rules. These limits are designed to provide reasonable protection against harmful interference in a residential installation. This equipment generates, uses and can radiated radio frequency energy and, if not installed and used in accordance with the instructions, may cause harmful interference to radio communications. However, there is no guarantee that interference will not occur in a particular installation. If this equipment does cause harmful interference to radio or television reception, which can be determined by turning the equipment off and on, the user is encouraged to try to correct the interference by one or more of the following measures:

-Reorient or relocate the receiving antenna.

-Increase the separation between the equipment and receiver.

-Connect the equipment into an outlet on a circuit different from that to which the receiver is connected.

-Consult the dealer or an experienced radio/TV technician for help.

Changes or modifications not expressly approved by the party responsible for compliance could void the user's authority to operate the equipment.

● This device complies with FCC radiation exposure limits set forth for an uncontrolled environment. In order to avoid the possibility of exceeding the FCC radio frequency exposure limits, human proximity to the antenna shall not be less than 20cm (8 inches) during normal operation.

● This device can not be worn on the body and at least keep it 20 cm away from body parts other than hand, wrists, feet and ankles.

Care & Maintenance

This section is specifically prepared for those who are in charge of taking care of the terminal, such as a terminal operator or maintenance engineer.

Here are some tips on how to take care and maintain the terminal.

Taking care of the terminal

- Always keep electric equipments, such as the terminal, away from any flammable sources.
- Always make sure there is stable power supply for the terminal or its peripherals to operate properly.
- This terminal is intended for industrial use. Although the terminal is rated IP 64, it may do damage to the terminal when being exposed to extreme temperatures or soaked wet.
- When the body of the terminal gets dirty, use a clean and wet cloth to wipe off the dust. DO NOT use/mix any bleach or cleaner. Always keep the LCD dry.
- For a liquid crystal display (LCD) or touch screen, DO NOT use any pointed or sharp object to move against the surface. Use a clean, non-abrasive, lint-free cloth to wipe dust off the screen.

Maintaining the terminal

- If you want to put away the terminal for a period of time, download the collected data to a host first, and then take out the battery pack. Store the terminal and battery pack separately.
- When the terminal resumes its work, the main and backup batteries will take a certain time to become fully charged.
- If you shall find the terminal malfunctioning, refer to the Troubleshooting section for self help first.
- If the problem persists, write down the specific scenario and consult your local sales representative.
- Under no circumstances, internal components are self-serviceable.

Getting Started

Below illustrates how to have the terminal ready to work. This scenario makes use of a cradle, which may be replaced by a gang charger and other interface to PC.

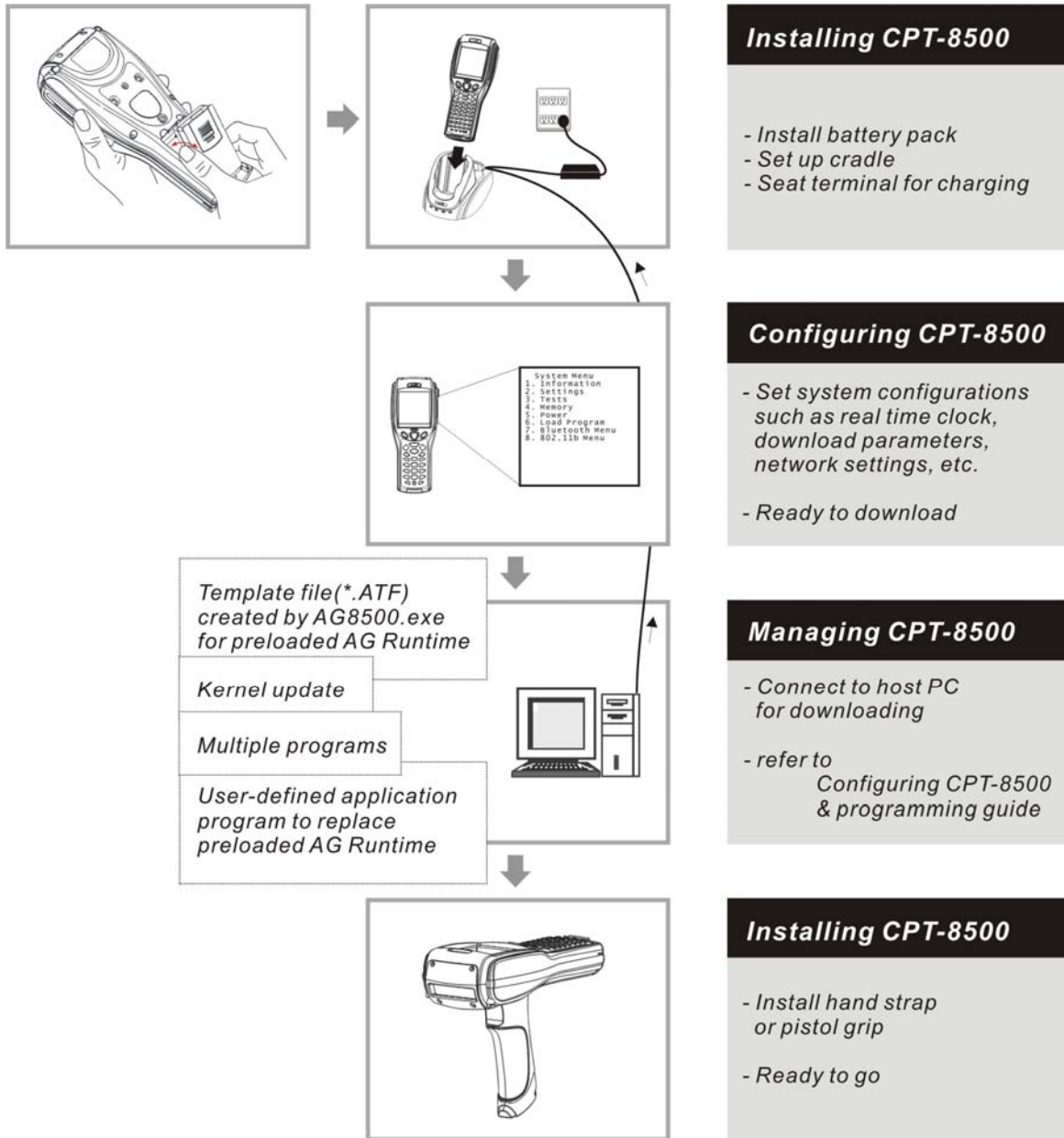

Figure 1: Have CPT-8500 ready

Contents

Copyright Notice	II
-------------------------	-----------

FCC Regulations	III
------------------------	------------

Compliance with Standards	III
----------------------------------	------------

Care & Maintenance	IV
-------------------------------	-----------

Getting Started	V
------------------------	----------

Preface	1
----------------	----------

Typographical Conventions	2
Revision History	2

CHAPTER 1: Introducing CPT-8500	3
--	----------

1.1 Product Highlights	3
1.2 Nomenclature	4
1.2.1 CPT-8500	4
1.2.2 Accessories & Peripherals	5
1.2.3 Dimensions	6
1.3 Features	7
1.3.1 Power	7
1.3.2 CPU	8
1.3.3 Memory & Calendar	8
1.3.4 Keyboard	9
1.3.5 LCD	12
1.3.6 Status LED	13
1.3.7 Buzzer	13
1.3.8 Vibrator	13
1.3.9 Readers	14
1.3.10 Wireless Support	15
1.3.11 Resistance	20
1.3.12 Terminal Emulation	20
1.3.13 Programming Support	20

1.4 Unpacking the package 21
1.5 Options 21

CHAPTER 2: Installing CPT-8500 **22**

2.1 Battery Pack 23
2.2 Hand Strap 24
2.3 Pistol Grip 25
2.4 Cradle, serial or modem 26
 2.4.1 Cradle Options 28
 2.4.2 Status Indicators 29
 2.4.3 DIP Switch 30
2.5 Charging 31
 2.5.1 Cradle 31
 2.5.2 Gang Charger 31
2.6 Communications 31
 2.6.1 Wired 32
 2.6.2 Wireless 33

CHAPTER 3: Software Architecture **34**

3.1 Program Module 35
3.2 System & Kernel Modules 36

CHAPTER 4: Configuring CPT-8500 **37**

4.1 System Menu 38
 4.1.1 Information 39
 4.1.2 Settings 40
 4.1.3 Tests 45
 4.1.4 Memory 47
 4.1.5 Power 48
 4.1.6 Load Program 49
 4.1.7 Bluetooth Menu 50
 4.1.8 IEEE 802.11b Menu 62
4.2 Program Manager 70
 4.2.1 Download 71
 4.2.2 Activate 73
 4.2.3 Upload 74
4.3 Kernel Menu 75
 4.3.1 Kernel Information 76
 4.3.2 Load Program 77
 4.3.3 Kernel Update 77
 4.3.4 Test & Calibrate 78
 4.3.5 Bluetooth Menu 79

CHAPTER 5: Managing CPT-8500 **80**

- 5.1 For proprietary applications80
- 5.2 For custom applications80

Specifications **81**

Troubleshooting **83**

Appendix I - Download Utilities **86**

- ProgLoad, all-in-one interface87
- IRLoad, Cradle-IR interface89
- Download, RS-232 or IrDA interface90
- TcpLoad, IP interface91

Index **92**

Table of Figures

Figure 1: Have CPT-8500 ready	V
Figure 2: Nomenclature (front & back)	4
Figure 3: Nomenclature of accessories	5
Figure 4: Dimensions	6
Figure 5: 24-key layout	10
Figure 6: 44-key layout	11
Figure 7: Coverage of wireless technologies	15
Figure 8: Installing battery pack	24
Figure 9: Installing hand strap	25
Figure 10: Installing pistol grip	26
Figure 11: Setting up cradle	27
Figure 12: Cradle LEDs	29
Figure 13: Cradle - DIP switch	30
Figure 14: Flow chart of cradle communications	32
Figure 15: Software Architecture	34
Figure 16: Downloading through Program Manager	72
Figure 17: Downloading in Kernel mode	87
Figure 18: Downloading in Program Manager mode	87

Preface

The CPT-8500 Industrial Portable Data Terminal is a robust, versatile, high performance terminal. It is specifically designed for all-day, everyday use as well as for data-intensive applications in harsh environments.

This line of product comes with built-in Bluetooth wireless technology and allows for optional 802.11b and/or GSM/GPRS modules, enabling all the time, anywhere applications and seamless real time sharing of performance. The terminal is bundled with powerful and rich features to ensure success in timely processing of information, even in rigorous industrial environments, and thus, makes an ideal choice for a wireless solution in either increasing business flexibility or answering the demanding needs of heavy-duty terminals. Being programmable, this handy terminal can run custom applications or terminal emulation applications.

This manual serves to guide you through how to install, configure, and operate the terminal. The Care & Maintenance section is specifically prepared for those who are in charge of taking care of the terminal.

We recommend you to keep one copy of the manual at hand for quick reference or maintenance purposes. To avoid any improper disposal or operation, please read the manual thoroughly before use.

Thank you for choosing the CipherLab products!

In This Chapter

Typographical Conventions.....	2
Revision History	2

Typographical Conventions

Before you start using this manual, it is important to understand the terms and typographical conventions used in the documentation.

The following kinds of formatting in the text identify special information.

Formatting convention	Type of Information
Triangular Bullet (➤)	Highlight features or subjects that stand out from the text.
Special Bold	Items you must select, such as menu options, command buttons, or items in a list.
<i>Emphasis</i>	Use to emphasize the importance of a point or for variable expressions such as parameters.
CAPITALS	Names of keys on the keyboard. for example, SHIFT, CTRL, or ALT.
KEY+KEY	Key combinations for which the user must press and hold down one key and then press another, for example, CTRL+P, or ALT+F4.

Revision History

Version	Release Date	Notes
0.69	July 28, 2005	Draft for internal reference

CHAPTER 1

Introducing CPT-8500

This chapter mainly explains the hardware parts and features of the CPT-8500 terminal.

In This Chapter

1.1 Product Highlights.....	3
1.2 Nomenclature.....	4
1.3 Features.....	7
1.4 Unpacking the package.....	21
1.5 Options.....	21

1.1 Product Highlights

- Ergonomic design - ruggedized yet streamlined, with hand strap for secure hold.
- Built tough to survive harsh environments - splash, dust & drop resistant.
- Upgradeable memory - optional memory card provides up to 8 MB for data and program storage.
- Dual mode support - One scan engine (integrated barcode scanner/imager) plus one RFID reader.
- Total wireless solution - connectivity includes IrDA, Bluetooth, 802.11b and GSM/GPRS.
- Large graphic monochrome LCD touch screen supports double-byte characters, user fonts, and bitmap graphics. The touch screen featuring signature capture is activated with its stylus or a finger. Software programmable.
- Programmable feedback includes buzzer, status light and vibrator.
- Quick link to any backend database through VT100/200 and IBM 5250 emulation.
- Proprietary programming tool - Windows-based application generator (AG) for easy customization of preloaded AG application.
- Programming support includes BASIC & C compilers.

1.2 Nomenclature

1.2.1 CPT-8500

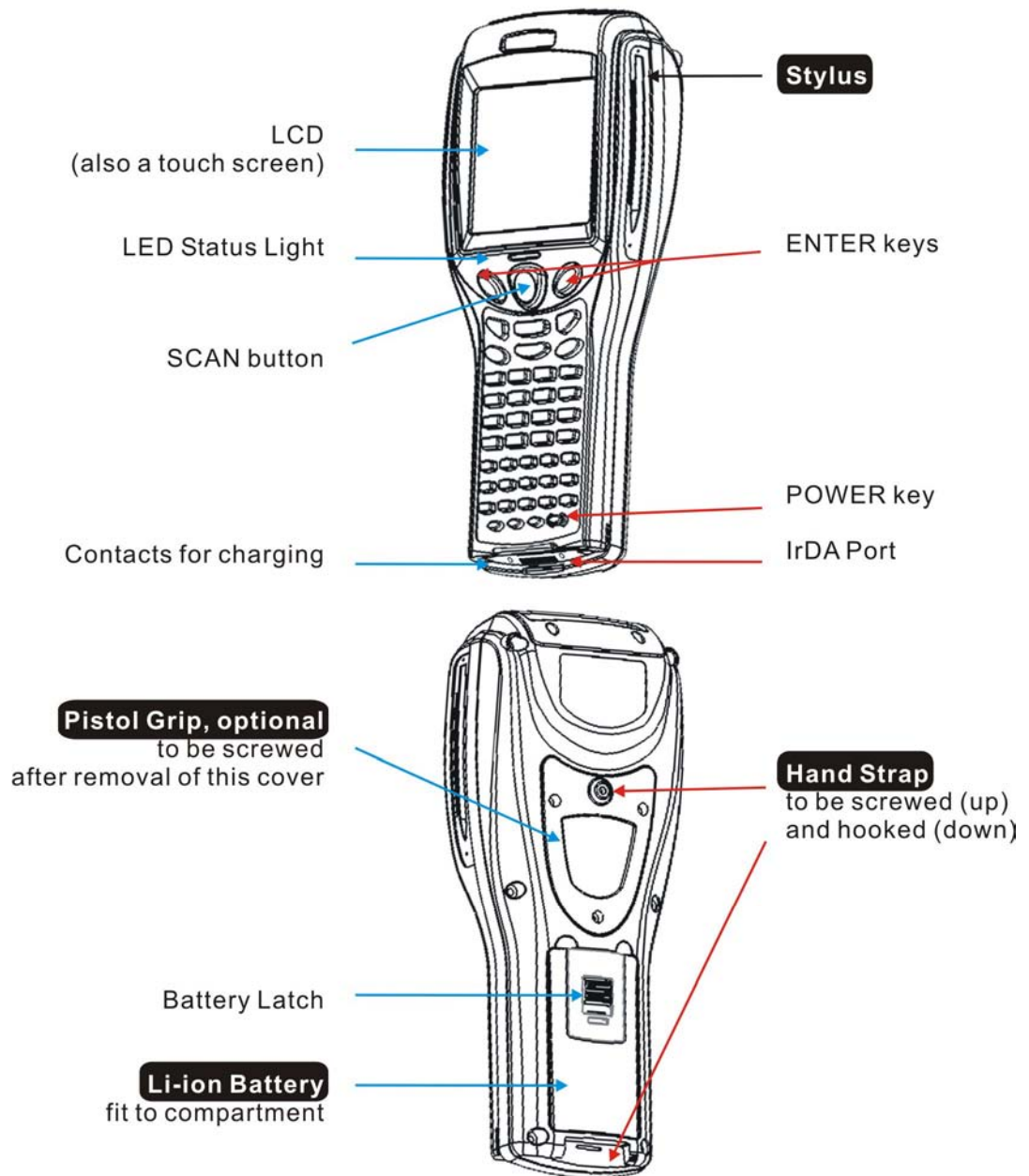

Figure 2: Nomenclature (front & back)

1.2.2 Accessories & Peripherals

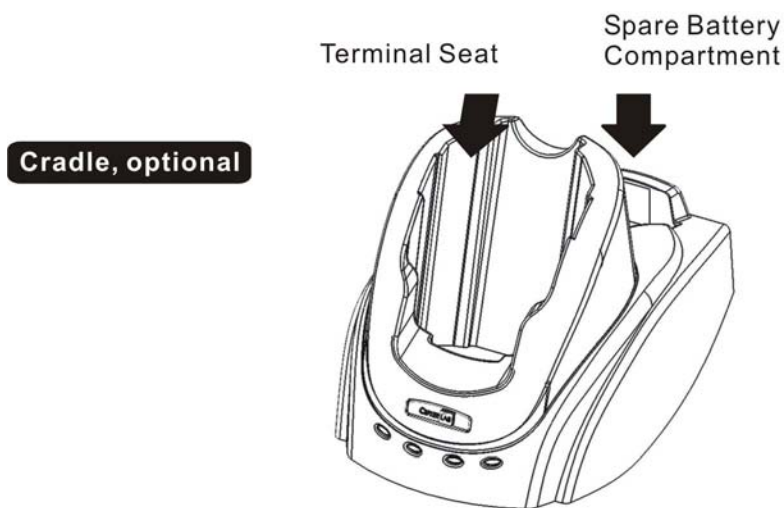
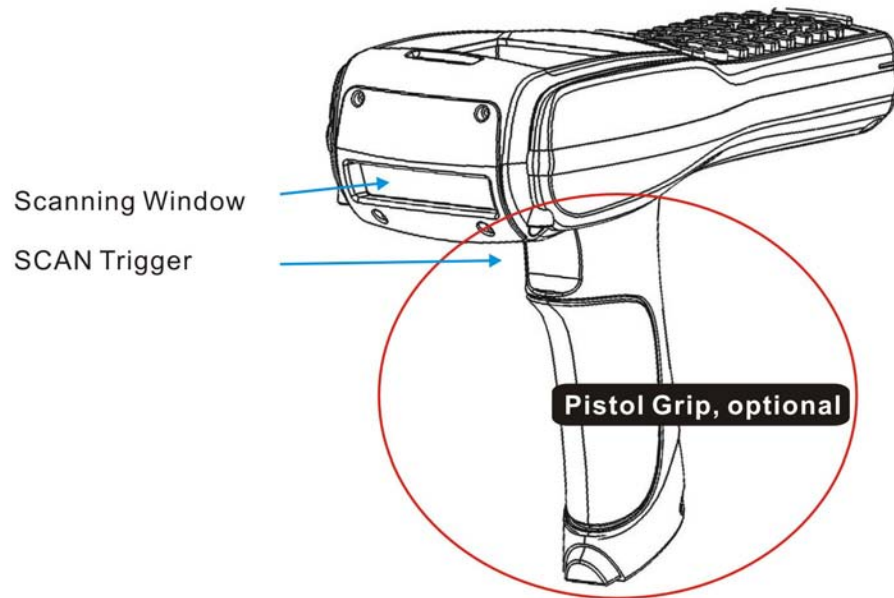

Figure 3: Nomenclature of accessories

1.2.3 Dimensions

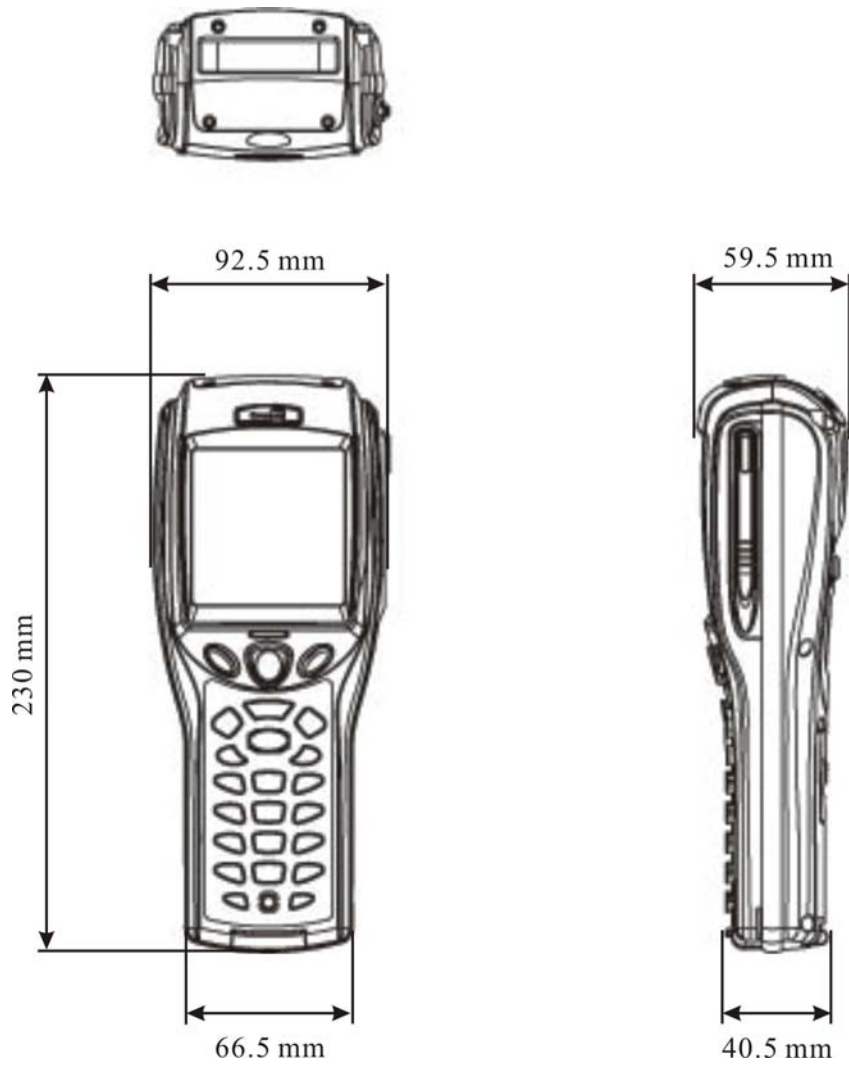

Figure 4: Dimensions

1.3 Features

1.3.1 Power

➤ Main Battery

The CPT-8500 is powered by a rechargeable 3.7 V/4000 mAh Li-ion battery pack, and it takes approximately four hours to fully charge it. During normal operation, the terminal can work for up to 500 hours.

For power saving purpose, always turn off the backlight while working in a well-lit area. When the backlight is on for extended periods of time, the main battery will become low sooner than expected.

The smart battery icon on the LCD screen shows the status of power consumption. There are two ways to monitor a low battery charge or discharged battery from the screen.

- Examine the level of the 4-bar battery icon
- Monitor voltage level (see [4.1.5 Power](#))

➤ Backup Battery

In addition, one 3.0 V/7 mAh rechargeable Lithium button cell on the main board retains data in SRAM and maintains the running of the real-time clock and calendar. It takes at least twenty-four hours to fully charge the backup battery.

For a fully charged backup battery, it can last for at least one week. However, it is not necessary to fully charge the backup battery for the terminal to work.

- Monitor voltage level (see [4.1.5 Power](#))

➤ Initial Charging

The main battery must be fully charged before using the terminal for the first time. Because the internal backup battery is constantly charged from the main battery, the initial charging requires installing the battery pack to the terminal and then seating the terminal in the cradle for charging. This will have main/backup batteries charged at the same time.

Note: For initial charging, we recommend that you install the main battery to the terminal and seat the terminal in the cradle to charge the main/backup batteries at the same time. It requires approximately 4 hours fully charging the main battery.

➤ **Caution of Low Battery Charge**

The battery pack is the only power source for the terminal to work. It also charges the backup battery on the main board so that the data stored in SRAM can be retained properly. Therefore, when the main battery charge goes low, replace the battery pack with a charged one or charge it as soon as possible. Always save data before it is too late.

Warning! Data loss may occur with SRAM during low battery condition. Always save data before running out of power or keep a fresh battery for replacement.

1.3.2 CPU

A 32-bit low power CMOS CPU is utilized.

1.3.3 Memory & Calendar

The CPT-8500 is a real-time data collection model, that is, the collected data will be sent back to a host computer immediately during normal operation.

An optional memory card upgrades memory to 4 or 8 megabytes. With upgradeable memory, the terminal can further accommodate one or more application programs.

Note: When in use, the memory card will override the internal SRAM.

Program Memory

- ✓ 2 megabytes flash memory for core, OS, application programs, fonts, etc.

Data Memory

- ✓ 2 megabytes SRAM with contents backup by a 7 mAh rechargeable Lithium button cell.

Calendar

- ✓ A calendar chip is equipped for accurate time/date logging.
- ✓ Non-stop operation is also provided through the same Li button cell for SRAM contents backup.

➤ Caution of Data Loss

When the main battery is removed or drained, the backup battery on the main board is to retain the contents of SRAM and maintain the running of the calendar for at least one week, on condition that the backup battery has already been fully charged.

If the terminal is to be put away for a couple of days, you should be aware that data loss occurs when both the main and backup batteries discharge completely. Therefore, it is necessary to save data in a host computer before putting away the terminal.

Note: Being fully charged, the backup battery can last at least 1 week.

1.3.4 Keyboard

The terminal is equipped with a keypad of either 24 keys or 44 keys, which has programmable LED backlight, for system setup, user entry and so on.

Silicon rubber has been chosen for their durability and prompt feedback. The key click can be configured through the System Menu.

Note: Functionality of keys is application-dependent.

➤ Screen Icons

The following icons appear on the screen when a certain mode is activated, that is, holding down the specific key is unnecessary. Simply press another key or red-coded function key ([F1] ~ [F12]) to produce a result.

24-key

- A / a: Press [Alpha] to enter the alphabetic mode, capital or small letters.
- F: Press [FN] to enter the function mode (user definable).

44-key

- ↑: Press [Shift] to enter the special function mode (user definable).
- F: Press [RED] to enter the function mode (user definable).
- A: Press [Alt] to enter the special function mode (user definable).

24-key layout

The layout of the 24-key keypad is similar to that of a telephone, which consists of an alphanumeric keypad, numbers and assorted characters.

This keypad is set to numeric mode by default. For alpha mode, simply press [ALPHA] to toggle between alpha and numeric modes.

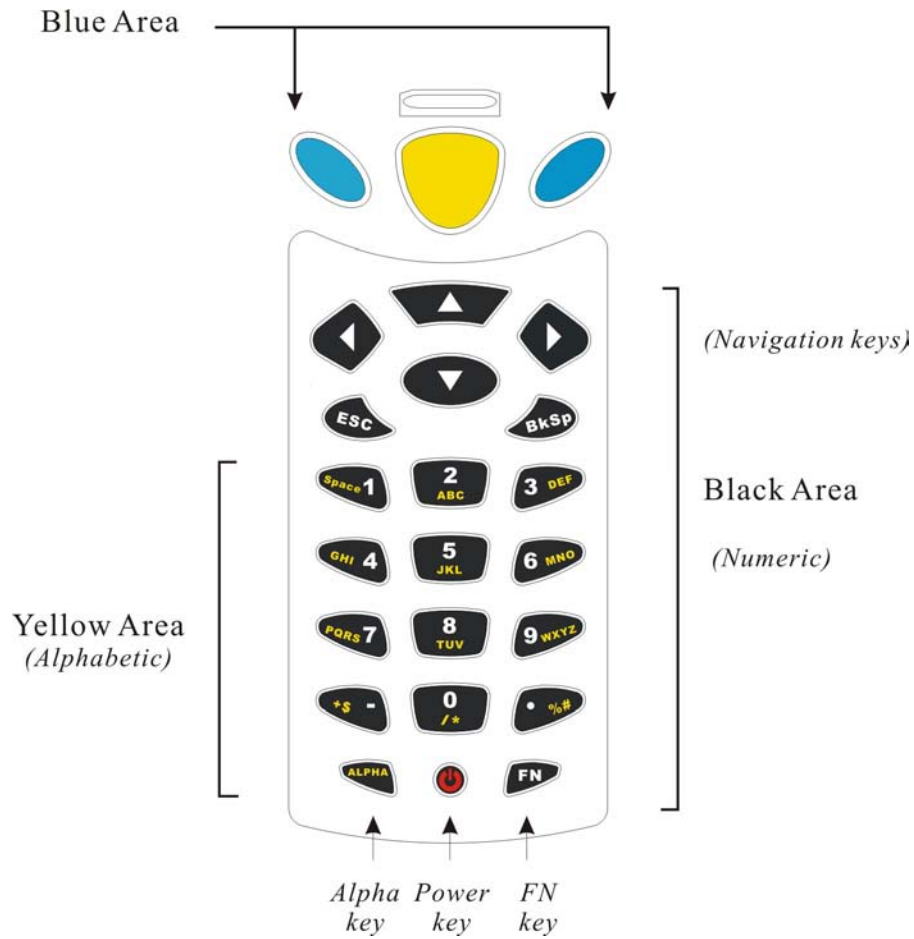

Figure 5: 24-key layout

44-key layout

The layout of the 44-key keypad includes numeric, alphabetic, assorted characters, function and modifier keys.

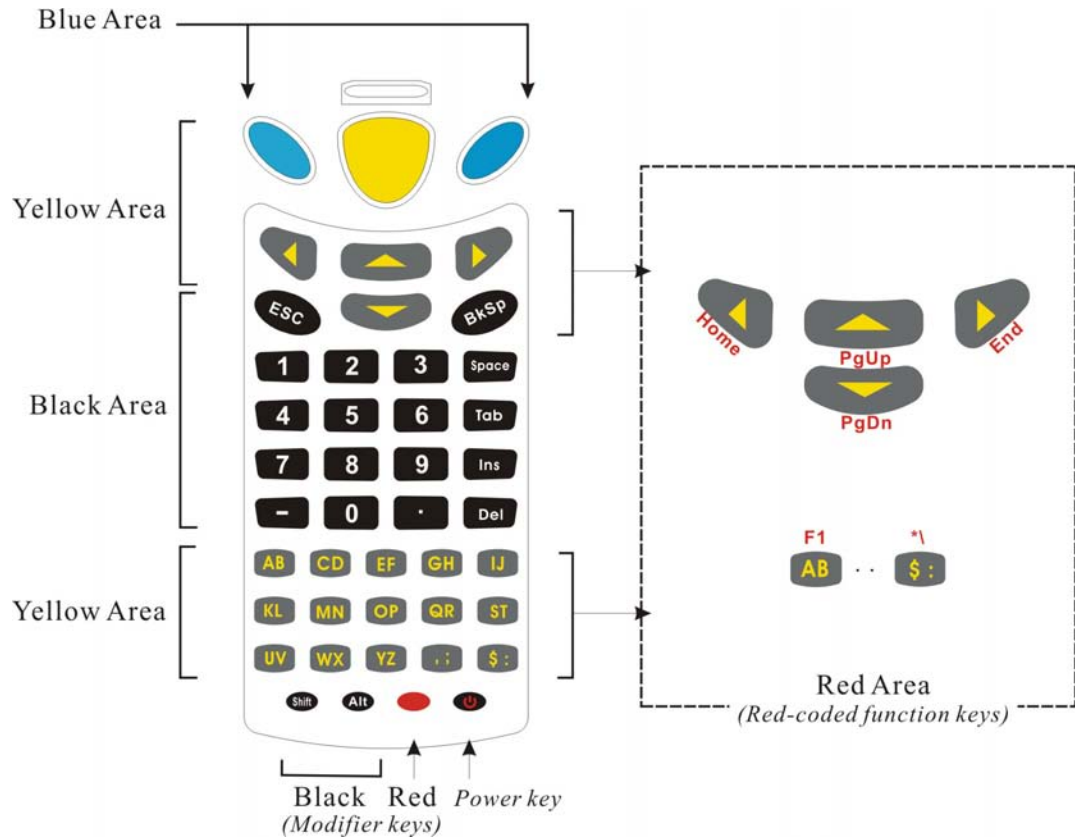

Figure 6: 44-key layout

For the 44-key keypad, these keys can be categorized into the following groups by color:

Blue Area:

- ✓ Two [Enter] keys: user-friendly and convenient for either right-handed or left-handed operator to perform general function of a [Enter] key.
- ✓ It can be used together with [RED] modifier key: [Enter] + [RED] = alternately turn ON/OFF the backlight of LCD and keyboard.

Black Area:

- ✓ Power key
- ✓ Numeric keys
- ✓ Modifier keys: [Shift] or [Alt] that modifies its next key. The functionality depends on software application.
- ✓ Others like [Backspace], [ESC], [Space], [Tab], [Insert], [Delete], [-], [.]

Yellow Area:

- ✓ [Scan] button
- ✓ Navigation keys for moving the cursor up, down, left, right.
- ✓ Alphabetic keys
- ✓ Others like punctuation keys for comma & semi-colon, dollar & colon.

Red Area:

- ✓ [RED] modifier key: the solid red key next to the Power key
- ✓ [RED] followed by one red-coded key: The [RED] modifier key modifies (activates) the second key. Its functionality is determined by the red-coded key, which is specified by red letters under the navigation keys or on top of alpha keys and some punctuation keys.

1.3.5 LCD

The terminal comes with a 3" FSTN graphic LCD, 160 by 160 pixels resolutions, which can be configured to display text or graphics, such as specific font and company logo, to meet varying application needs.

English Font:

Small fonts (6×8 pixels) 21 by 8 lines

Large fonts (8×16 pixels) 16 by 4 lines

Chinese Font:

(16×16 pixels) 8 by 4 lines

Other language fonts, company logo...

Programmable

➤ **Backlight Setting**

The LED backlight of screen and keyboard helps ease reading under dim environments. It can be alternately toggled ON and OFF by simultaneously pressing the following keys:

- 24-key: [Enter] + [FN]
- 44-key: [Enter] + [RED]

➤ **Touch Screen & Signature Capture**

This LCD is also a touch screen, which enables the use of a stylus for handwriting. It also features signature capture that can save signature as confirmation of receipt when delivering goods to door.

The screen can be calibrated by tool provided in the System Menu.

Warning! DO NOT use any pointed or sharp objects to move against the surface of the screen.

1.3.6 Status LED

The dual-color LED on top of the [Scan] button is to provide information on status of scanning. It is programmable for diagnostics and application dependant.

- Red LED - Error
- Green LED - Good Read

1.3.7 Buzzer

The buzzer, a low power transducer type, can be programmed for status feedback. Its pitch and duration are software programmable.

1.3.8 Vibrator

Like a modern mobile phone, the terminal is integrated with a vibrator. It is software programmable and especially useful when working in a noisy environment.

1.3.9 Readers

A wide variety of readers is available for delivering flexibility to meet different requirements.

Note: All specifications are subject to change without prior notice.
--

Long Range Imager

Resolution:	0.125 mm ~ 1.00 mm
Depth of field:	2 ~ 20 cm
Width of field:	45 mm ~ 124 mm
Scan rate:	100 scans/sec
Ambient Light Rejection:	1200 lux (Direct Sun-light) 2500 lux (Fluorescent Light)

Laser Scanner

Light source:	Visible laser diode operating at 670 ± 15 nm
Depth of field:	5 ~ 95 cm, depends on barcode resolution
Scan angle:	42° nominal
Scan rate:	36 ± 3 scans/sec
Minimum print contrast:	20% absolute dark/light reflectance at 670 nm

2D Scanner

???	???
-----	-----

RFID Reader

13.56 MHz, Philips Mifare:	From contact to 6 cm
----------------------------	----------------------

➤ **Dual Mode Support**

The terminal allows one integrated scan engine, plus the RFID reader.

1.3.10 Wireless Support

The CPT-8500 terminal supports state-of-the-art wireless technologies so that it is able to send/receive data in real time in an efficient way.

- WPAN: IrDA, Standard infrared (IR) technology for data exchange, embedded
- WPAN: Bluetooth technology for cable replacement & data exchange, embedded
- WLAN: IEEE 80.211b for wireless networking, optional module
- WWAN: GSM/GPRS for short message service, optional module

Generally, the coverage of each technology can be viewed as follows.

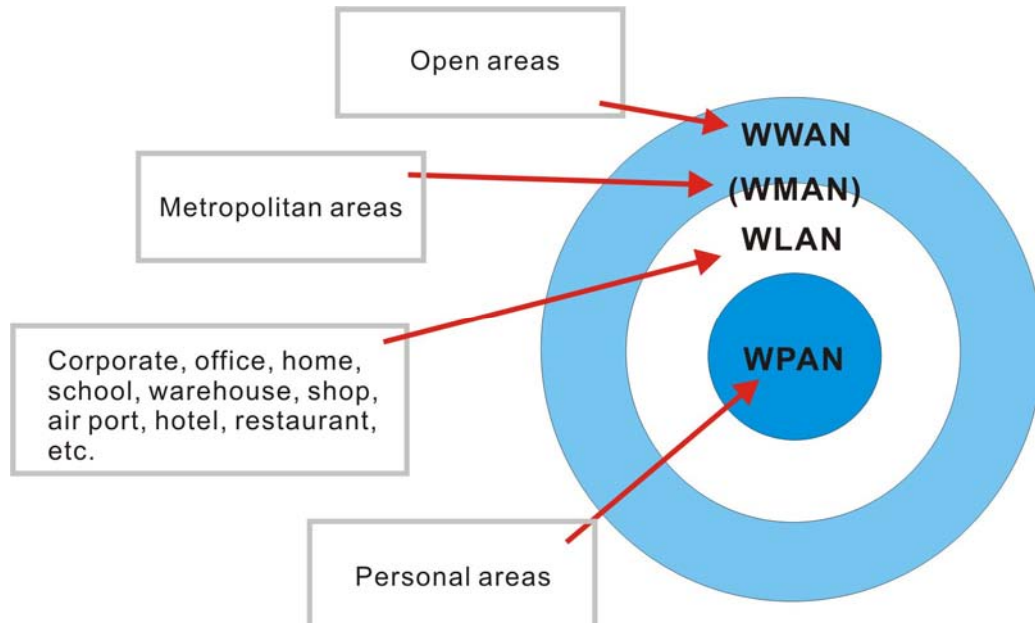

Figure 7: Coverage of wireless technologies

Standard IrDA Port

The terminal has an integrated IrDA port at the bottom, which can directly establish connection with an IrDA device for printing or data exchange. Simply have the IrDA port of the terminal toward the IrDA port of the target device.

- IrDA specifications define communications (transmit/receive data) between two IrDA enabled devices within a very short range, line-of-sight.

IrDA Specification

Infra red:	Optical
Data rate:	Up to 115200 bps
Coverage:	From contact to at least 30 cm, line-of-sight
Connected devices:	Peer-to-Peer
Standard:	Version 1.0

Note: All specifications are subject to change without prior notice.
--

Bluetooth Class 2

With built-in Bluetooth technology, the terminal can directly communicate with any Bluetooth enabled device, not necessarily line-of-sight.

- Bluetooth is an industrial standard for Wireless Personal Area Networking (WPAN), which enables wireless communications within a short range.
- Serial Port Profile (SPP) is for ad-hoc networking, without going through any access point.
- Personal Area Networking Profile (PAN) makes use of Bluetooth Network Encapsulation Protocol (BNEP) for IP networking over Bluetooth. Access points required.
- Dial-Up Networking Profile (DUN) makes use of a Bluetooth modem or mobile phone as a wireless modem.

Bluetooth Specification

Frequency Range:	2.4 ~ 2.5 GHz
Modulation:	FHSS with GFSK
Profiles:	SPP, PAN, DUN
Maximum Output Power:	10 mW
Data rate:	721 kbps
Coverage:	50 meters line-of-sight
Connected devices:	SPP mode - either Master or Slave Server-to-Client (access point required)
Standard:	Version 1.2

Note: All specifications are subject to change without prior notice.

IEEE 802.11b

When the 802.11b module is installed, the terminal can easily connect to legacy networks through access points (APs). Roaming among different networks is possible.

- IEEE 802.11b is an industrial standard for Wireless Local Area Networking (WLAN), which enables wireless communications over a long distance.
- The speed of connection between two wireless devices will vary with range and signal quality. To maintain a reliable connection, the 802.11b system automatically fallback from 11 Mbps to 5.5, 2 or 1 Mbps as range increases or signal quality decreases.
- An 802.11b network can operate in the following two modes:

Infrastructure mode - Wireless devices can communicate with each other or can communicate with wired networks through APs.

Ad-hoc mode - Wireless devices or stations can communicate directly to each other, without the use of APs.

802.11b Specification

Card type:	CF Type I
Frequency Range:	2.4 ~ 2.5 GHz
Modulation:	DSSS with DBPSK (1 Mbps), DQPSK (2 Mbps), CCK
Protocols:	IP/TCP/UDP
Maximum Output Power:	100 mW
Data rate:	11, 5.5, 2, 1 Mbps auto-fallback
Coverage:	250 meters line-of-sight
Connected devices:	Peer-to-Peer (no access point) Server-to-Client (access point required)
Standard:	IEEE 802.11b, interoperable with Wi-Fi devices

Note: All specifications are subject to change without prior notice.
--

GSM/GPRS

When the GSM/GPRS module is installed, the terminal is capable of data communications over free air, on the road.

- GSM and GPRS are industrial standards for Wireless Wide Area Networking (WWAN), which enables wireless communications over free air.
- “GSM” is an abbreviation of Global System for Mobile Communications.
- “GPRS” is an abbreviation of General Packet Radio Service.
- GPRS, a packet-switched technology based on GSM (circuit-switched), allowing information to be transmitted or received more quickly, immediately and efficiently across the mobile network. GPRS Class B mobile devices can be attached to both GSM and GPRS services, using one service at a time.

GSM/GPRS Specification

Card type:	CF Type I
Tri band data radio:	EGSM 900, DCS 1800 and PCS 1900 (MHz)
Data rate:	8 ~ 12 kbps Send; 32 ~ 40 kbps Receive
GPRS Class:	Class B
Multi-slot Class:	Class 8 (4 Rx/ 1 Tx/ 5 Sum)
Standard:	GSM & GPRS

This spec. may differ due to the change of supplier.

Note: All specifications are subject to change without prior notice.

1.3.11 Resistance

➤ Shock

The terminal is designed for harsh industrial environments, and is proved to survive drop test by the following criteria:

- Surface type: Concrete
- Distance to surface: 2 meters
- Drop times: multiple

➤ Splash & Dust

The Ingress Protection (IP) rating is often used to indicate the protection afforded by enclosures of an electronic device, and an IP number specifies the protection level. The first number (0~6) refers to the protection against solid objects and the second (0~8) against liquids. The higher the number is, the better the protection afforded.

For industrial environments, it can be very damp and dusty. Thus, the terminal is sealed against moisture and dust to industry standard IP64.

- 6 = Totally protected against dust
- 4 = Protection against water sprayed from all directions. That is, limited ingress is permitted.

1.3.12 Terminal Emulation

The terminal supports the following terminal emulation to access any backend database.

- VT 100/200
- IBM 5250

1.3.13 Programming Support

For easy development of applications, the terminal ships with development tool package. It includes a Windows-based application generator (AG) and relevant utilities.

For development of complex custom applications, proprietary BASIC or C compiler is available through licensing agreement, as well as libraries.

1.4 Unpacking the package

The following items are included in the package. Save the box and packaging material for future use when you need to store or ship the terminal.

- Terminal: CPT-8500
- One rechargeable Li-ion battery pack
- Stylus
- Hand Strap
- Software CD & Reference Manual (for authorized distributors only)

Note: For battery charging, you'll need to purchase a charging cradle or gang charger.

1.5 Options

There are a number of optional accessories to enhance the total performance of the terminal. For installation details, please refer to relevant sections.

Warning! The use of any batteries or charging devices, which are not originally sold/manufactured by Syntech for its CipherLab product lines, will void your warranty and may cause damage to human body or the product itself.

Accessories	Features...
Memory Card	4 or 8 MB SRAM for data memory. It will override the onboard SRAM.
Reader	One scan engine (long range imager, laser scanner or 2D scanner And/or the RFID reader
802.11b Module	IEEE 802.11b compliant for WLAN (Wireless Local Area Networking)
GSM/GPRS	Tri band for WWAN (Wireless Wide Area Networking)
Spare Battery Pack	Rechargeable Li battery for non-stop operation
Pistol Grip, Detachable	Facilitating scanning with one hand
Charging Communication Cradle	Charging of the terminal and one spare battery at the same time while transmitting/receiving data.
4-bay Gang Charger	Charging up to four batteries at the same time.

CHAPTER 2

Installing CPT-8500

The terminal is designed for portable use, and it almost requires no installation except installing the battery pack and necessary auxiliary parts.

Warning! The use of any batteries or charging devices, which are not originally sold/manufactured by Syntech for its CipherLab product lines, will void your warranty and may cause damage to human body or the product itself.

Here are some tips and suggestions that ensure safe and comfortable experience with the terminal.

➤ **Battery Pack**

- Spare battery pack is convenient and necessary when on the road.
- Be cautious of low battery conditions.
- Turn off the backlight in a bright work area to save power.
- Always use proprietary CipherLab batteries for safety concern.
- Do not expose the battery to temperature in excess of 140°F (60°C).
- Do not disassemble, incinerate or short circuit the battery pack.

➤ **Hand Strap**

- The hand strap is ideal for one-handed operation, which requires safe and convenient hold of the portable terminal.
- Always make sure the hand strap is well hooked and screwed to the back of the terminal.

➤ **Pistol Grip**

- This contoured pistol grip enables intuitive trigger-and-scan operation, which is very helpful in scan intensive applications.

➤ **Cradle**

- Capable of charging and communications at the same time.
- One terminal seat for terminal with battery pack installed.
- One spare battery compartment for a spare battery pack.

➤ **Charging**

- Make use of a serial cradle (RS-232).
- Make use of a modem cradle.
- Make use of a gang charger (charging up to four battery packs at the same time).
-

➤ **Communications**

- Wireless - make use of wireless technologies, embedded or added by module.
- Wired - make use of a cradle.

In This Chapter

2.1 Battery Pack.....	23
2.2 Hand Strap.....	24
2.3 Pistol Grip.....	25
2.4 Cradle, serial or modem.....	26
2.5 Charging	31
2.6 Communications.....	31

2.1 Battery Pack

- 1 Place the terminal face down on a flat and clean surface.
- 2 Slide the battery pack into the battery compartment at a proper angle (30°~45°) so that the tabs on the bottom of the battery are hooked in the grooves of the compartment. Make sure that the battery is snugly fit into the compartment.
- 3 Hold the terminal still and slide the battery latch to lock the battery in the compartment.

Note: For a new battery, make sure it is fully charged before use.

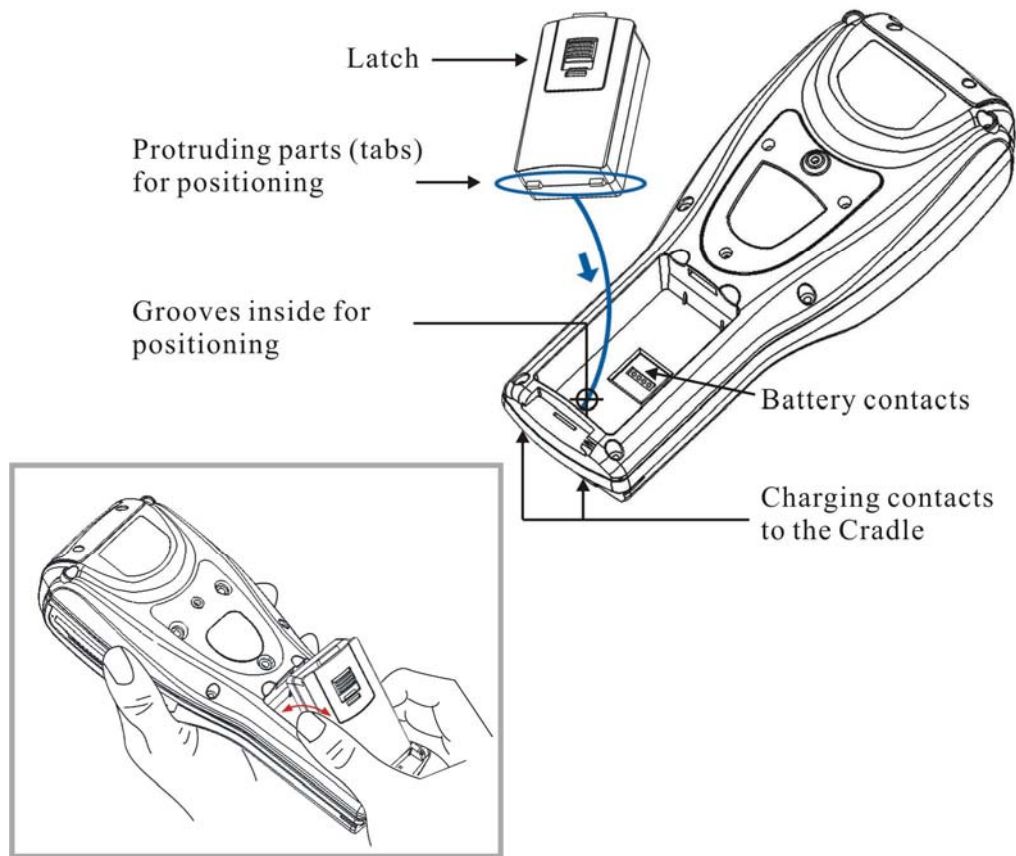

Figure 8: Installing battery pack

2.2 Hand Strap

When a hand strap is necessary, install it to the terminal by following the steps:

- 1 Place the terminal face down on a flat and clean surface.
- 2 Screw one end of the hand strap to the shield-like cover on the back of the terminal.
- 3 Insert and hook the other end of the hand strap to the bottom of the terminal.
- 4 Make sure the hand strap is securely attached to the terminal.
- 5 Adjust the length of the hand strap to suit your handbreadth.

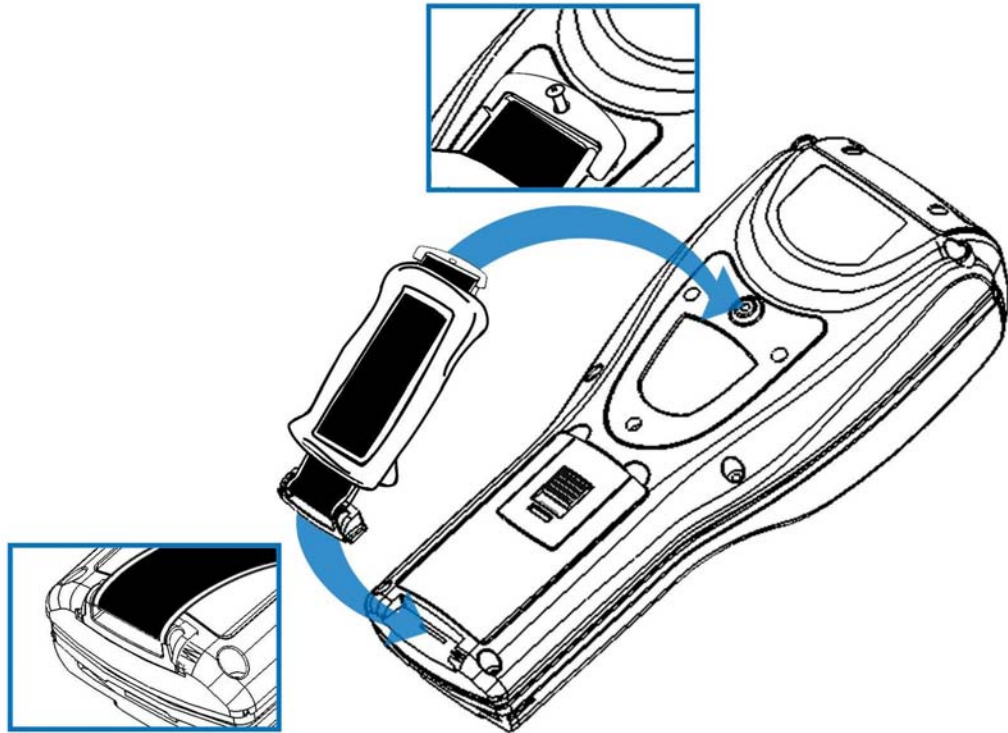

Figure 9: Installing hand strap

2.3 Pistol Grip

When a pistol grip is necessary, install it to the terminal by following the steps:

- 1 Place the terminal face down on a flat and clean surface.
- 2 Remove the shield-like cover on the back of the terminal by unscrewing.
If there is a hand strap installed, remove it first. Keep the cover and screws for future use when the pistol grip is not desired.
- 3 Connect the power connector from the pistol grip to the receptacle on the terminal.
- 4 Screw the pistol grip to the shield-like cover.
- 5 Make sure all screws are tightened up but not over-tightened to damage the threads.
- 6 Turn ON the terminal and test the trigger.

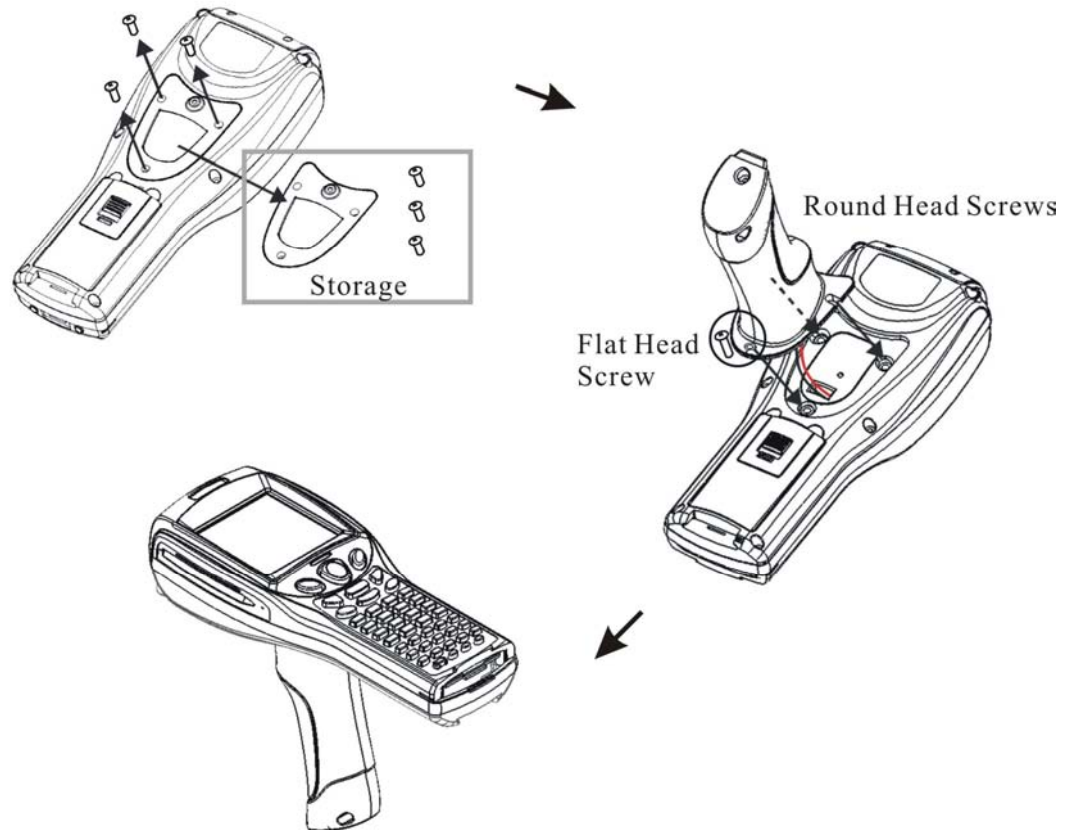

Figure 10: Installing pistol grip

2.4 Cradle, serial or modem

For charging and communications at the same time, a cradle is necessary.

- 1 Place the cradle in a flat and clean surface.
- 2 Connect the line of the power adaptor to the power jack on the back of the cradle.
- 3 Connect the power adaptor to a suitable power outlet.
- 4 The cradle is ready for charging.
- 5 If data communications are desired at the same time, connection must be established as well. This depends on the cradle type.

For example, below illustrates an RS-232 cable connected between a computer and the cradle. The interface between the terminal and the cradle is serial IR that can run data in a higher speed than IrDA.

Note: Make sure the connection is made secured.

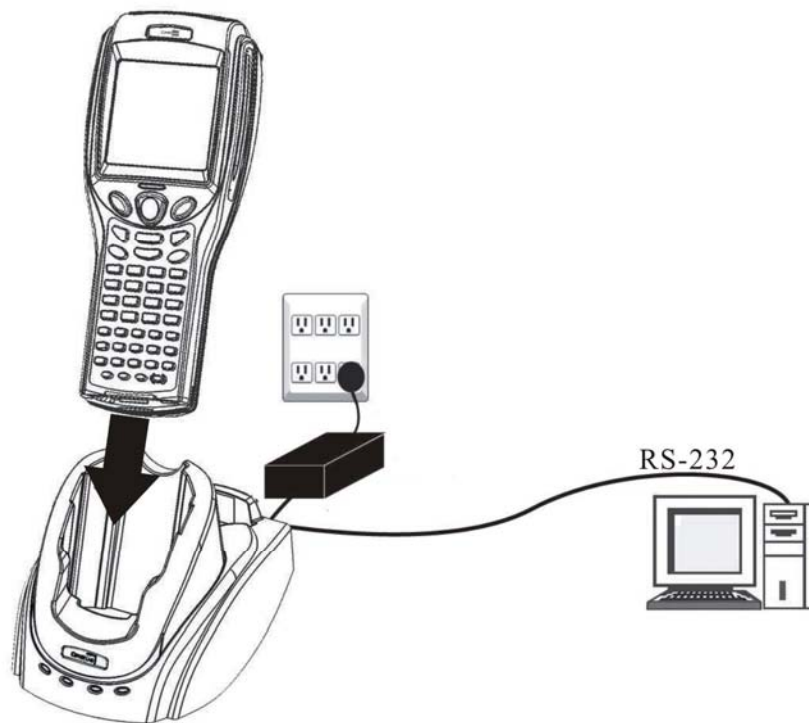

Figure 11: Setting up cradle

2.4.1 Cradle Options

The choice of cradle can be very flexible. Choose a suitable type that best meets your needs.

Note: The cradle is designed for communications and charging at the same time.
--

	Type (by communication Interface)	Package Contents
Charging & Communications Cradle	Serial Cradle (RS-232 only)	Cradle Power adaptor Spare battery pack RS-232 cable
	Modem Cradle (RS-232 + 56kbps Modem)	Cradle Power adaptor Spare battery pack RS-232 cable Phone cable
Optional Accessory	RS-232 to USB adaptor (converter)	

2.4.2 Status Indicators

- **Charging Status**
 - For main battery, view the screen of the CPT-8500.
 - For spare battery, see cradle LEDs.
- **Communications & Port Status**
 - See cradle LEDs: RX, TX and Power.

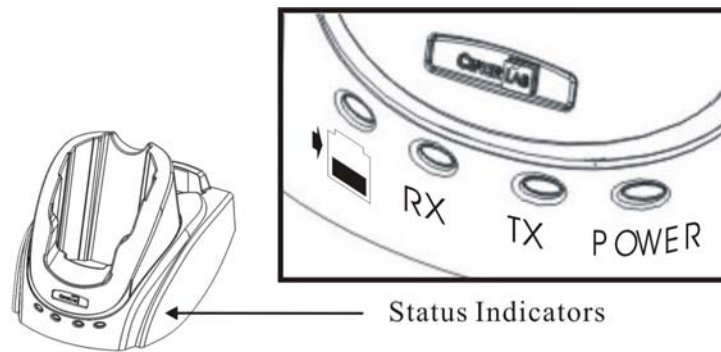



Figure 12: Cradle LEDs

Charging Spare Battery		Red LED: Charging Green LED: Charging completed Flashing (Red/Green): Error occurs
Receiving Data	RX	Red LED: Receiving data from a host
Transmitting Data	TX	Red LED: Transmitting data to a host
Power	Power	Red LED: RX/TX via modem port Green LED: RX/TX via RS-232 port

Warning! Charging error may occur due to a power failure or defected battery contacts.

2.4.3 DIP Switch

The modem cradle (left) integrates a modem to the original serial cradle (right). Through toggling the DIP switch, the modem cradle can make use of the modem or RS-232 port for flexibility in connection.

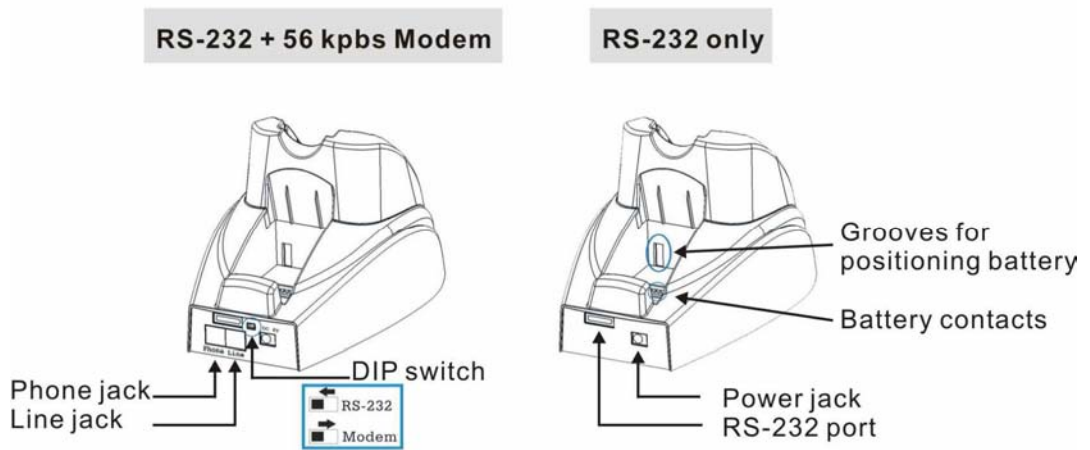



Figure 13: Cradle - DIP switch

➤ Modem connection

- Activate the modem by sliding the dip switch to right:  Modem

➤ RS-232 connection

- Activate the RS-232 port by sliding the dip switch to left:  RS-232

2.5 Charging

2.5.1 Cradle

After being set up, the cradle is ready for charging the terminal (loaded with main battery) and one spare battery pack.

Seat the terminal and/or the spare battery pack then.

2.5.2 Gang Charger

If you have purchased the 4-bay gang charger, you can charge up to four batteries at the same time. This is particularly convenient for a non-stop operation or locations where a proper power supply is unavailable.

Note: The battery is fully charged after approximate 4 hours.

2.6 Communications

For the CPT-8500, it is capable of sending or receiving data in a number of different ways.

2.6.1 Wired

The terminal is capable of wired communications via:

- Serial cradle
- Modem cradle

See the following flow chart for instructions on the procedure.

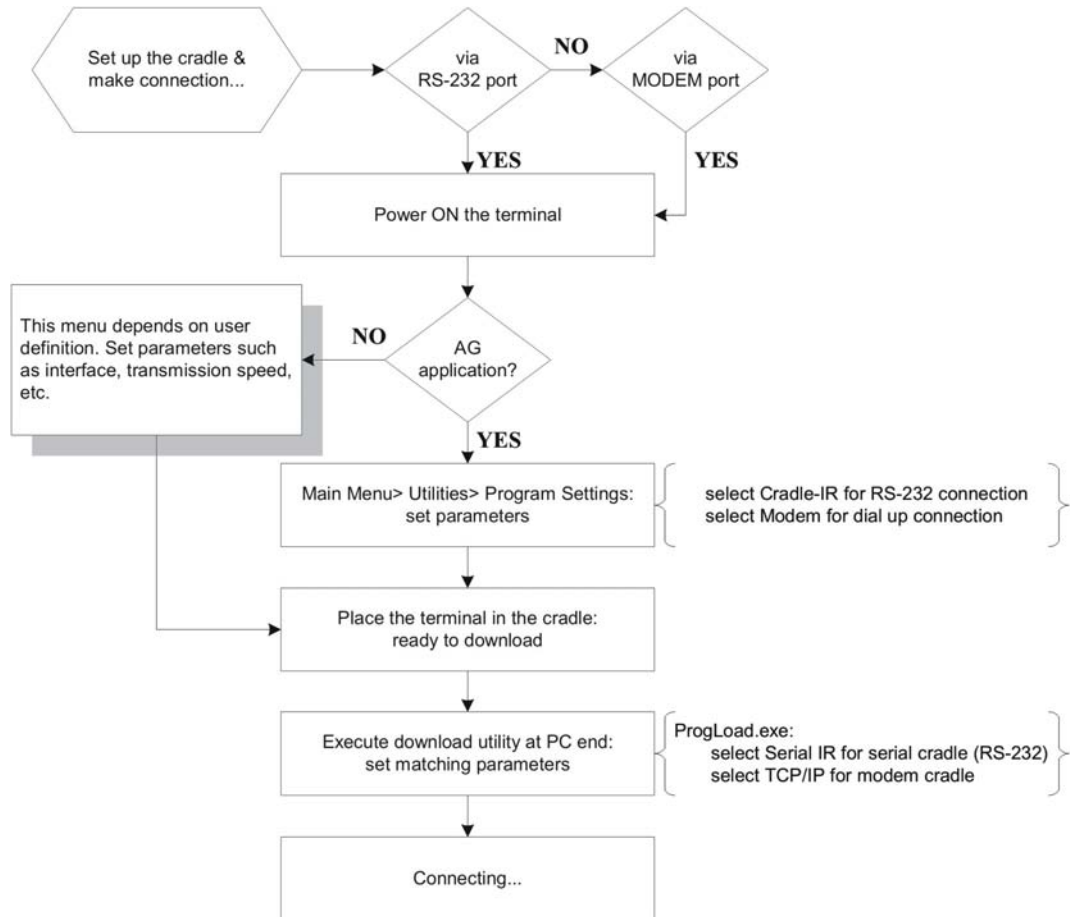

Figure 14: Flow chart of cradle communications

➤ **Serial Cradle (RS-232)**

When the cradle is set up,

- 1 Connect one end of a RS-232 cable to the RS-232 port on the back of the cradle.
- 2 Connect the other end of the cable to the RS-232 port of a host computer.
- 3 See the flow chart for the rest steps.

➤ **Modem Cradle**

When the cradle is set up,

- 1 For communications via an internal modem, slide the DIP switch on the back of the cradle to right.
- 2 Connect the telephone line to the [Line] jack on the back of the cradle.
- 3 You may connect the cradle to a telephone through the [Phone] jack.
- 4 See the flow chart for the rest steps.

2.6.2 Wireless

The terminal is capable of wireless communications via the following technologies:

- IrDA
- Bluetooth
- IEEE 802.11b
- GSM/GPRS

Refer to [1.3.10 Wireless Support](#) for more details.

CHAPTER 3

Software Architecture

The software inside the terminal mainly consists of three modules: Kernel, System, and Program.

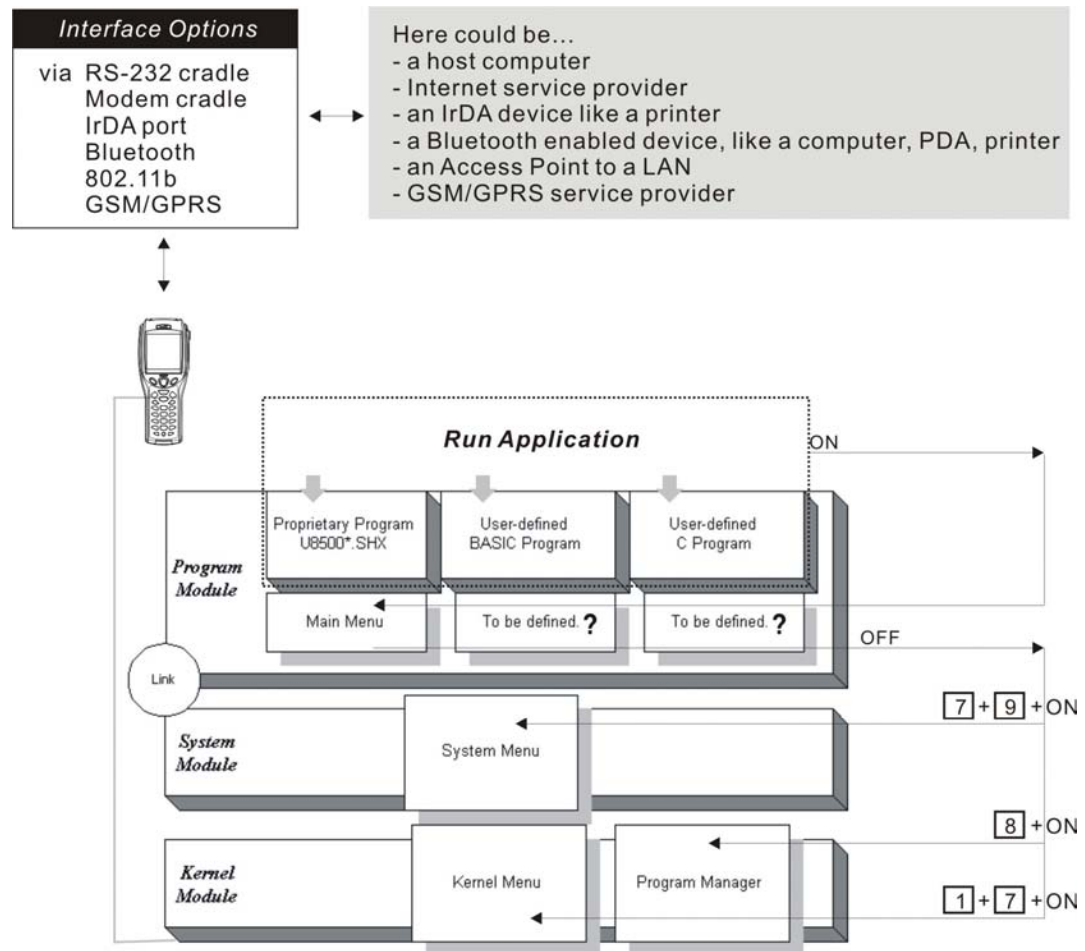

Figure 15: Software Architecture

In This Chapter

3.1 Program Module.....	35
3.2 System & Kernel Modules.....	36

3.1 Program Module

➤ Preloaded Application

The terminal is preloaded with a proprietary application program, that is, the AG Runtime (U8500*.SHX). After being physically set up and configured properly through the proprietary Application Generator (AG8500m.exe), the terminal is ready to collect data.

The main menu is generated by the AG Runtime, U8500*.SHX.

➤ Alternative

In addition to the proprietary application development tool, the Application Generator, you may develop your own application program through BASIC or C compiler, in order to best meet your system requirements.

Proprietary Application Program

- ✓ The terminal is preloaded with U8500*.SHX, which is for use with the matching application development tool at PC end, AG8500m.exe.
- ✓ The Application Generator (AG) software package includes this application development tool and several associated utilities to make it versatile in use.

Alternatives:

- ✓ Aided by programming support, user-defined application programs can be developed to satisfy specific needs, such as being integrated into an existing system.

3.2 System & Kernel Modules

For system configurations and managing multiple programs, each terminal comes with the System Menu, Kernel Menu, and Program Manager.

➤ **System Menu**

This is generated by the System module. You may configure parameters, test components, download or update the active application program (the one with the Program module), and download one custom font file.

➤ **Kernel Menu**

This is generated by the Kernel module. Generally, you may update the core program (Kernel Update), download or update the active application program (the one with the Program module), download one custom font file, and configure Bluetooth settings.

➤ **Program Manager**

This is also generated by the Kernel module. The Program Manager is bundled with the Kernel Menu. You may download as many as seven application programs, as well as one custom font file.

CHAPTER 4

Configuring CPT-8500

This section mainly describes the alternatives to configure the CPT-8500 terminal, including hardware configuration and downloading application programs.

In This Chapter

4.1 System Menu	38
4.2 Program Manager	70
4.3 Kernel Menu	75

4.1 System Menu

The System Menu is generated by a powerful utility, which offers an interface for engineers (programmers or system integrator) to view system information, change the configuration parameters, download programs and run diagnostics.

This menu is designed for engineering tests and maintenance ONLY. For this reason, the System Menu provides password protection to prevent unauthorized users from accidentally changing system settings.

Warning! The System Menu is NOT for the use of any end users. The system password helps ensure system safety and integrity.

How to access the System Menu?

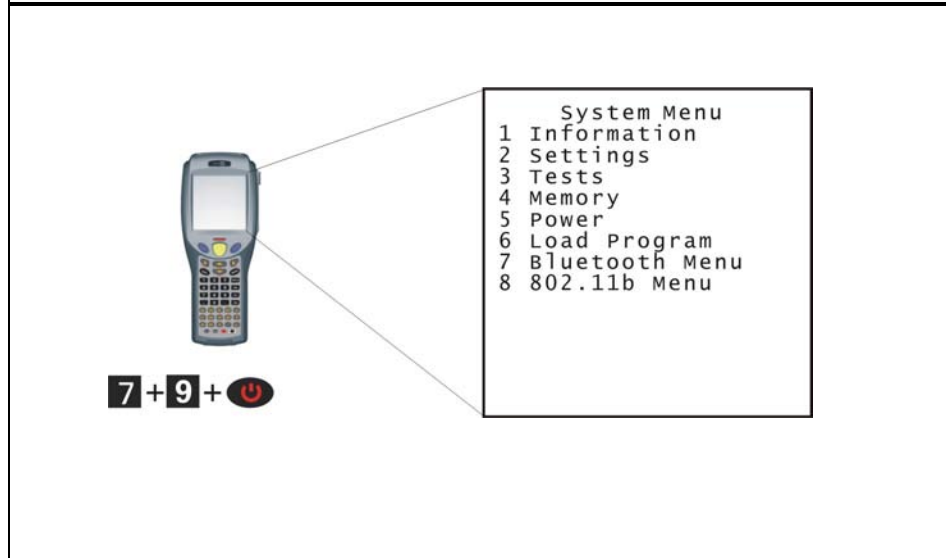

4.1.1 Information

The information provided here helps diagnose the system.

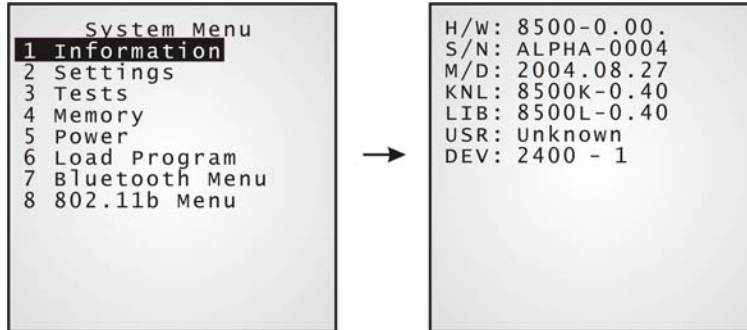

- H/W: Hardware version (PCB)
- S/N: Serial number of the terminal
- M/D: Manufacturing date
- KNL: Kernel version
- LIB (BSC): C library or BASIC run-time version
- USR: Application program version
- DEV: Code for optional hardware configurations, i.e. 2400-1

<u>2</u>	<u>4</u>	<u>0</u>	<u>0</u>	<u>- 1</u>
<i>Type of Reader</i>	<i>Type of Wireless Module</i>	<i>RFID Module</i>	<i>Reserved</i>	<i>Keyboard layout</i>
0= none	0= none	0= none		0= 24-key
1= CCD	3= GSM (+ Bluetooth)	1= RFID		1= 44-key
2= Laser	4= 802.11b (+ Bluetooth)			
3= 2D	5= Bluetooth only			
	7= GSM + 802.11b (+ Bluetooth)			

4.1.2 Settings

Here provides options to change the default settings.



System Settings	Default Values
Clock	blank
Backlight Period	20 seconds
Auto Off	10 minutes
Power On Options	Program Resume
Key Click	Tone 2
System Password	Open access
Font	System font

➤ Settings > Clock

Set date and time for Real Time Clock. Enter two digits for the year, i.e. 04 for 2004.

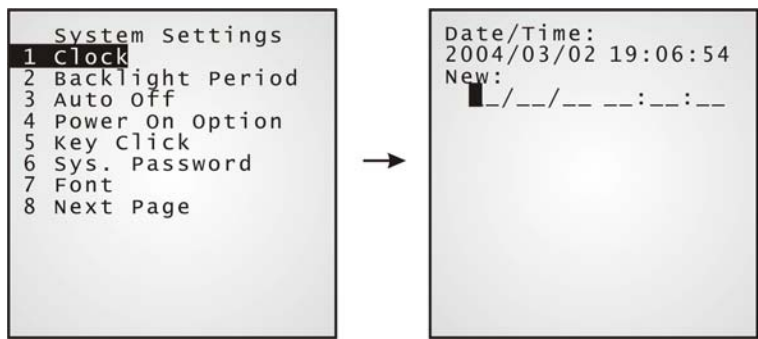

➤ Settings > Backlight Period

Set the backlight duration for the keypad and LCD. Enter a value between 0 and 9999.

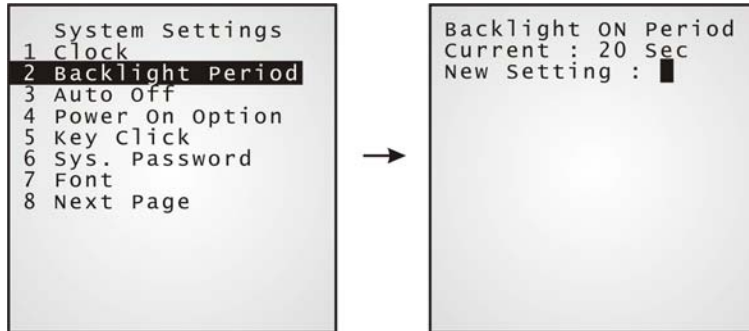

➤ Settings > Auto Off

Set time threshold for the terminal to automatically power off when no operation is taking place during that specific period. Enter a value between 0 and 999.

Note: To disable this function, enter 0.

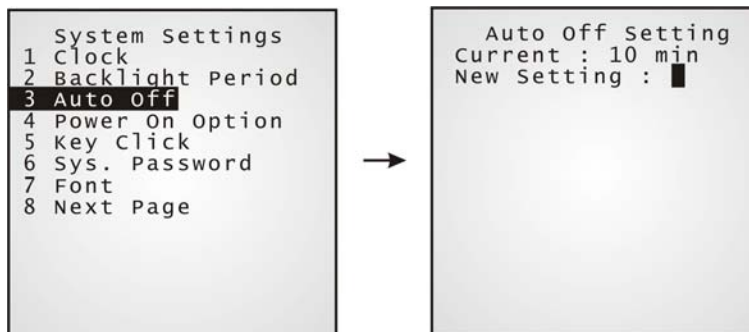

➤ Settings > Power On Options

Set the startup screen right after powering on:

- [0] Program Resume: Start from the last session of program before shutdown.
- [1] Program Restart: Fresh start from the first session of the program.

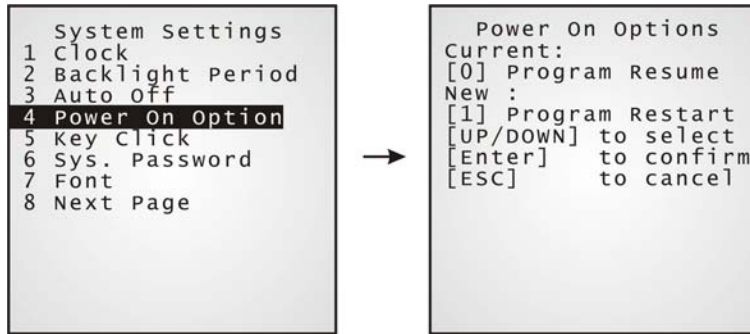

➤ Settings > Key Click

There is audible feedback for pressing a key on the keypad. The current value is highlighted. Select a tone for the buzzer or mute it.

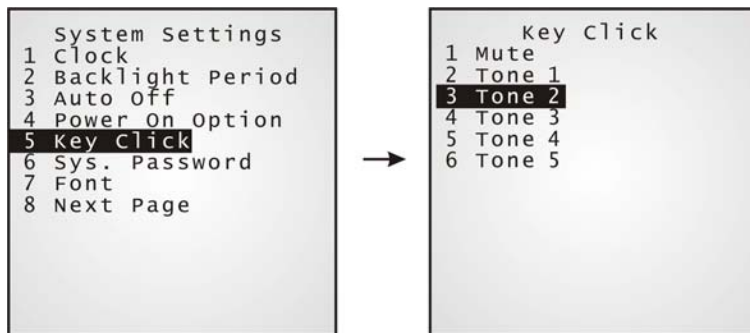

➤ Settings > System Password

Set a password to control user access to the System Menu. The password consists of eight characters at most.

Note: To disable a previous password, enter blank on the following screens.



➤ Settings > Font

Current font information can be viewed here.

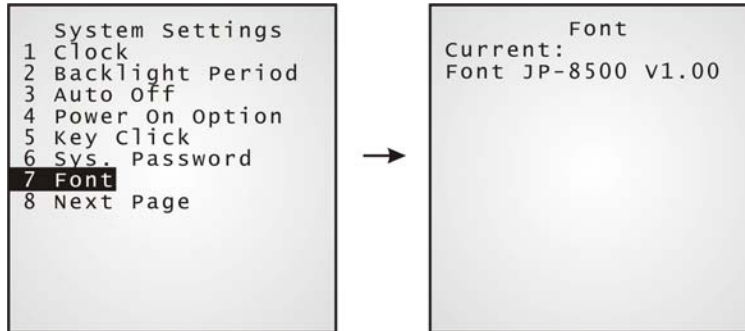

- Default: System font
- Custom font file, if there is one

The font settings here can be changed if a "multi-language" font file has been downloaded. (Press [Up] or [Down] to move the cursor up or down through the menu of options.)

➤ Settings > Screen Calibration

The cross mark will appear on the four corners of the screen for alignment. Use the tip of the stylus to tap at the center of the cross mark firmly and accurately.

Warning: DO NOT use any pointed or sharp object to move against the screen.



➤ **Settings > Reset to Default**

Reset all settings to the default values. The following dialog box prompts for confirmation.



4.1.3 Tests

Here provides functional tests for key parts.



➤ Tests > Reader

Test the reading performance of the scanner, with laser or image scanning engine. Press [SCAN] to start.

To stop and exit the test, press any key.

The following barcodes are enabled by default:

Code 39	EAN8
Industrial 25	EAN8 with ADDON 2
Interleave 25	EAN8 with ADDON 5
Codabar	EAN13
Code 93	EAN13 with ADDON 2
Code 128	EAN13 with ADDON 5
UPCE	...
UPCE with ADDON 2	Other barcodes must be enabled
UPCE with ADDON 5	through programming.

➤ **Tests > Buzzer**

Test the buzzer with different frequency/duration combinations. Press [Enter] to start. Press any key to stop and exit the test.

➤ **Tests > LCD & LED**

Test the LCD display and LED indicator. Press [Enter] to start. Press any key to stop and exit the test.

➤ **Tests > Keyboard**

Test the rubber keys. Press any key and its corresponding character will be shown on the screen. Press [ESC] to stop and exit the test.

➤ **Tests > Memory**

Test the data memory (SRAM), and the results will be shown on the screen. Press any key to exit.

Warning! The contents of the data memory (SRAM) will be wiped out after test.
--

➤ **Tests > Touch Screen**

Test signature capture by using the stylus for handwriting. Press [Enter] to start. Press [ESC] to stop and exit the test.

➤ **Tests > RFID**

Test the reading performance of the RFID reader when a proximity card is present. Press [ESC] to stop and exit the test.

➤ **Tests > Vibrator**

Test the vibrator. Press [ESC] to stop and exit the test.

➤ **Tests > IR Echo Test**

The echo test is to verify connectivity between the terminal and the cradle (serial IR). Run the echo test at baud rate 38400. Press [ESC] to stop and exit the test.

4.1.4 Memory

Here provides information and initialization function of the memory.



➤ Memory > Size information

- Base RAM (SRAM for data memory)
- Memory Card (SRAM for data memory)
- Flash (for program memory)

Note: If memory card is present, it will replace Base RAM in use.

➤ Memory > Initialize

Initialize the data memory, Base RAM or Memory Card.

Warning! The contents of the data memory (SRAM) will be wiped out after memory initialization.

4.1.5 Power

Here shows current voltage consumption.

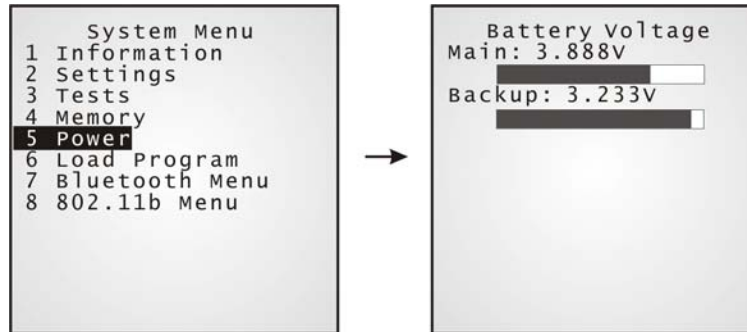

- **Main:** This refers to the main battery.
It shows dynamic status of the battery pack, as the main power source.
- **Backup:** This refers to the backup battery.
It shows dynamic status of the button cell, which is used to retain data in SRAM.

4.1.6 Load Program

Download program or font file to the active memory bank.

- New application program
- Program update
- Font file, i.e. multi-language font

➤ Results

- Success: the new program or font file will be activated right after downloading.
- Failure: the terminal will resume to the current application program or system font.



Interface

Cradle-IR The communication parameters at PC end should be set accordingly.

IrDA Point to the target IrDA device.

Bluetooth Approach to the target Bluetooth enabled device.

4.1.7 Bluetooth Menu

This submenu is for the built-in Bluetooth technology to work with other Bluetooth enabled devices. Parameters must be configured correctly.

Bluetooth Menu:	Settings:	Default Values
Connect Setting	<i>Local Name</i>	blank
	<i>Remote Name</i>	blank
	<i>Broadcast Me</i>	Enable
	<i>Power Saving</i>	Enable
Security	<i>Authentication</i>	Disable
	<i>PIN Code</i>	blank
Network Setting	<i>DHCP</i>	Enable
	<i>SubNet Mask</i>	255.255.128.0
	<i>Local IP Address</i>	0.0.0.0
	<i>Default Gateway</i>	0.0.0.0
	<i>DNS Server</i>	0.0.0.0
	<i>Domain Name</i>	blank

➤ Bluetooth Menu > Information

Information of network configuration can be viewed here.



- **LIB (BSC):** C library or BASIC run-time version
- **MAC:** MAC ID of the Bluetooth module
- **IAM:** A name given to the terminal for identification.
- **CTY:** “Normal” means frequency range is 2.4 ~ 2.5 GHz.
There are bandwidth limitations for 2.4 GHz ISM band in some countries. For example, only 23 RF channels defined instead of 79 RF channels in Japan, Spain and France.
- **DHCP:** DHCP being enabled or disabled.
- **IP:** IP address of the terminal
- **Mask:** Subnet Mask
- **Gate:** Default Gateway

➤ Bluetooth Menu > Connect Setting

A basic Bluetooth system can be configured as (1) point to point and (2) point to multi-point (Piconet; up to seven slaves can be connected to a master).

Set the following parameters.



- Local Name: Enter a name for identifying the terminal.
- Remote Name: Enter a name for making specific connection.
The remote name must be one of those in the Freq. Dev. List. Otherwise, the terminal will fail to make connection with any device. DO NOT specify any remote name when roaming is required.
- Broadcast Me: Options - Enable or Disable
For initial connection, broadcasting must be enabled. For security reason, simply disable it to hide the terminal from other Bluetooth devices.
- Power Saving: Options - Enable or Disable
This refers to the low power consumption mode. Only the Sniff mode is supported.

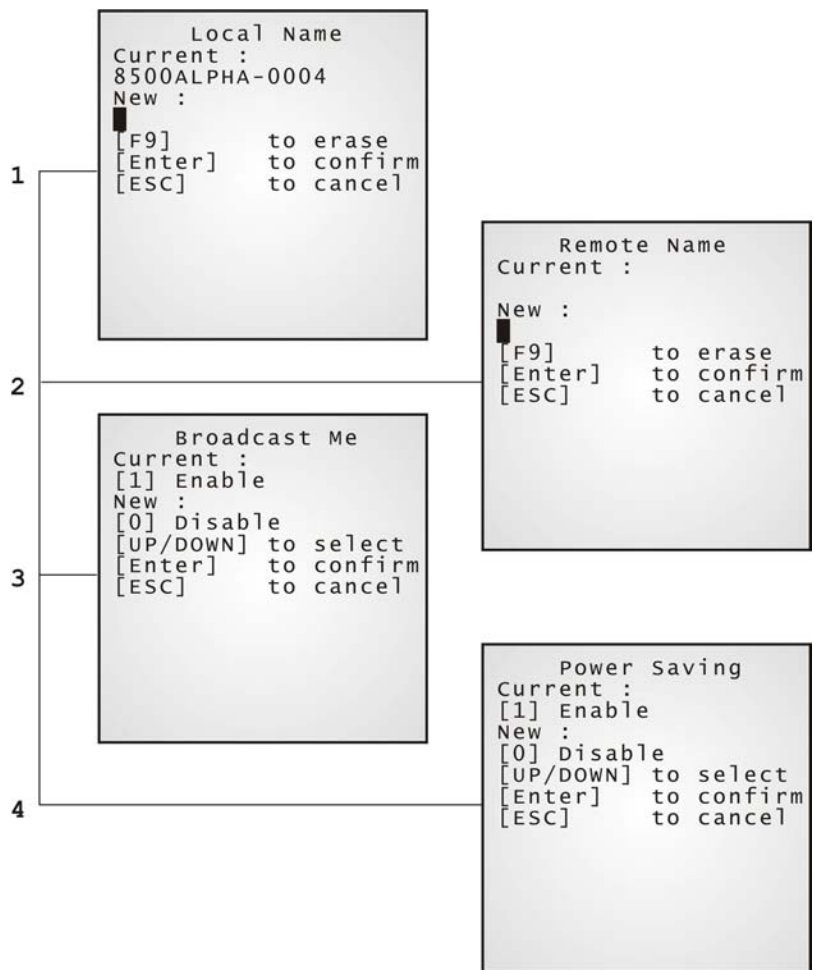

➤ **Bluetooth Menu > Security**

Set up or modify security parameters:

- Authentication: Options - Enable or Disable
- PIN Code: Define the encryption key values. Up to 13 characters, using ASCII code.

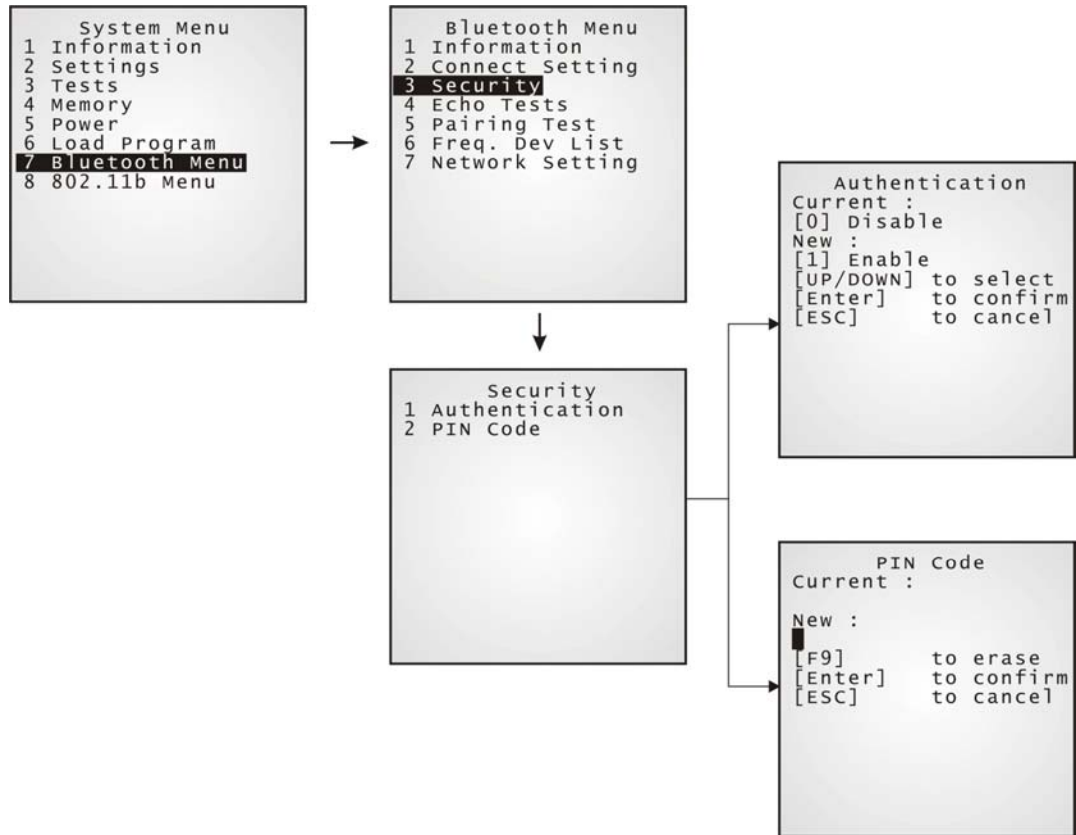

➤ Bluetooth Menu > Echo Tests

Echo tests are used for verifying connectivity to make sure the terminal is within coverage. Press [ESC] to stop and exit the test.

For PAN mode, it helps estimate the number of APs and terminals, and determine the topology of deploying APs.

- “SPP”: Serial Port Profile - for ad hoc networking, without going through any access point.
- “Dial Out”: For Dial-Up Networking Profile, also known as DUN. It makes use of a Bluetooth modem or mobile phone as a wireless modem.
- “PAN(BNEP)”: Personal Area Networking Profile - uses Bluetooth Network Encapsulation Protocol for IP networking over Bluetooth.



Note: You also need a test utility on PC to test the networking.

- SPP Master: Set the terminal as a master device.
It is to be followed by an attempt to make connection.
- SPP Slave: Set the terminal as a slave device.
It is to be followed by an attempt to make connection.

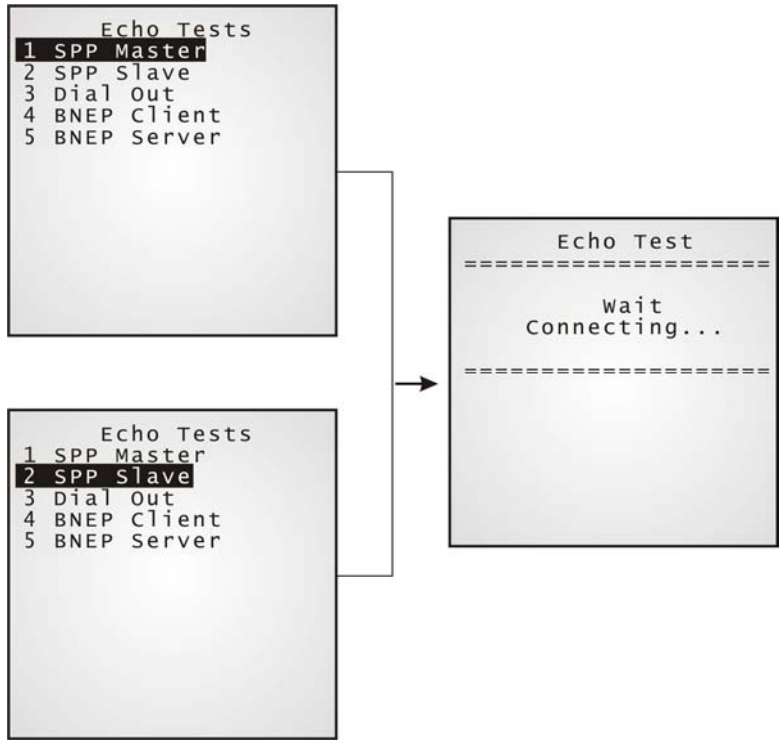

- Dial Out Set the terminal as a modem.
It is to be followed by an attempt to make connection with the target device. The target device may be a mobile phone or Bluetooth modem.

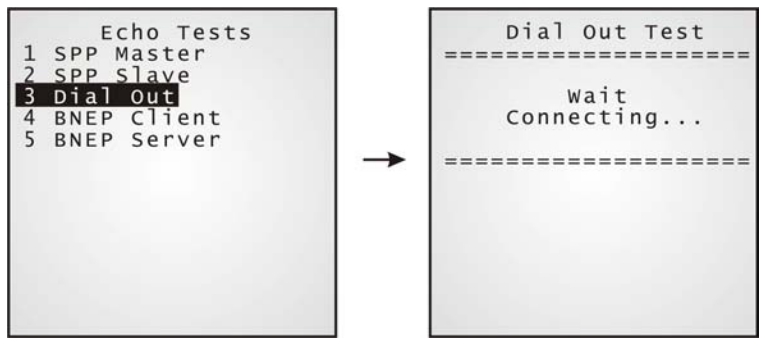

- PAN(BNEP)
Client:

Set the terminal as a client.

Enter the IP address of a server that connection is desired.

It is to be followed by an attempt to make connection with APs.

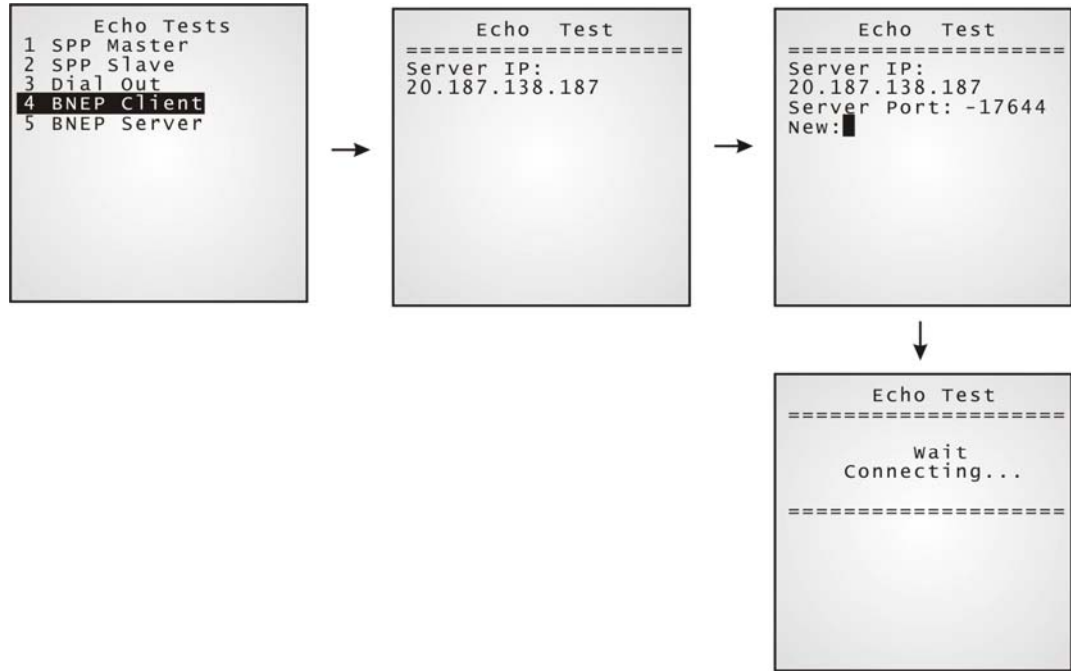

- PAN(BNEP)
Server:

Set the terminal as a server.

It is to be followed by an attempt to make connection with APs.

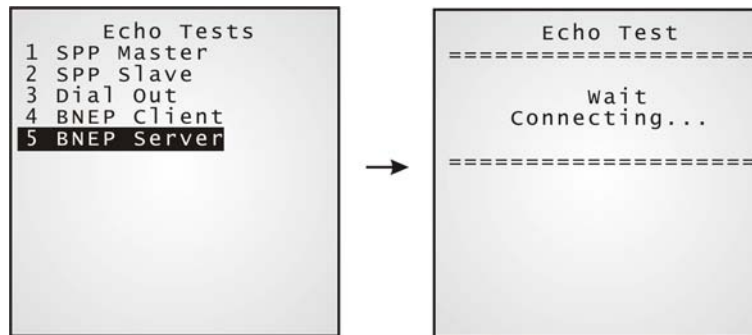

➤ **Bluetooth Menu > Pairing Test**

Pairing is for the creation and exchange of a link key between two devices. The devices use the link key for future authentication when exchanging information.

After inquiry, there will be a “Target Machine” menu for selecting mode:

- Serial Port (SPP)
- Access Point (PAN)
- Dial Up Network (DUN)

Press [ESC] to stop and exit the test.

Note: For initial setting of Bluetooth system, pairing must be carried out before the Echo tests.



➤ **Bluetooth Menu > Freq. Dev. List**

After successful pairing test, it will generate a list of device/s that the terminal has been connected to lately. During roaming or making new connection, the terminal will automatically connect to the listed device/s.

Note: To un-pair any device, simply delete the device from this list.

- SPP mode (Serial Port Profile): Only one device listed for quick connection.
- DUN mode (Dial-Up Networking): Only one device listed for quick connection.
- AP mode (PAN - IP Networking): Up to eight APs listed for roaming purpose.



➤ Bluetooth Menu > Network Setting

Set network parameters:



- DHCP: Options - Enable or Disable
- SubNet Mask: Enter a new Mask IP, if necessary.
- Local IP Address: Enter a new address for the terminal, if necessary.
- Default Gateway: Enter a new address for the default Gateway, if necessary.
- DNS Server: Enter a new address for the DNS server, if necessary.
- Domain Name: The domain name of the host is shown here.

Note: All of the setting could be obtained form DHCP server if DHCP is activated.

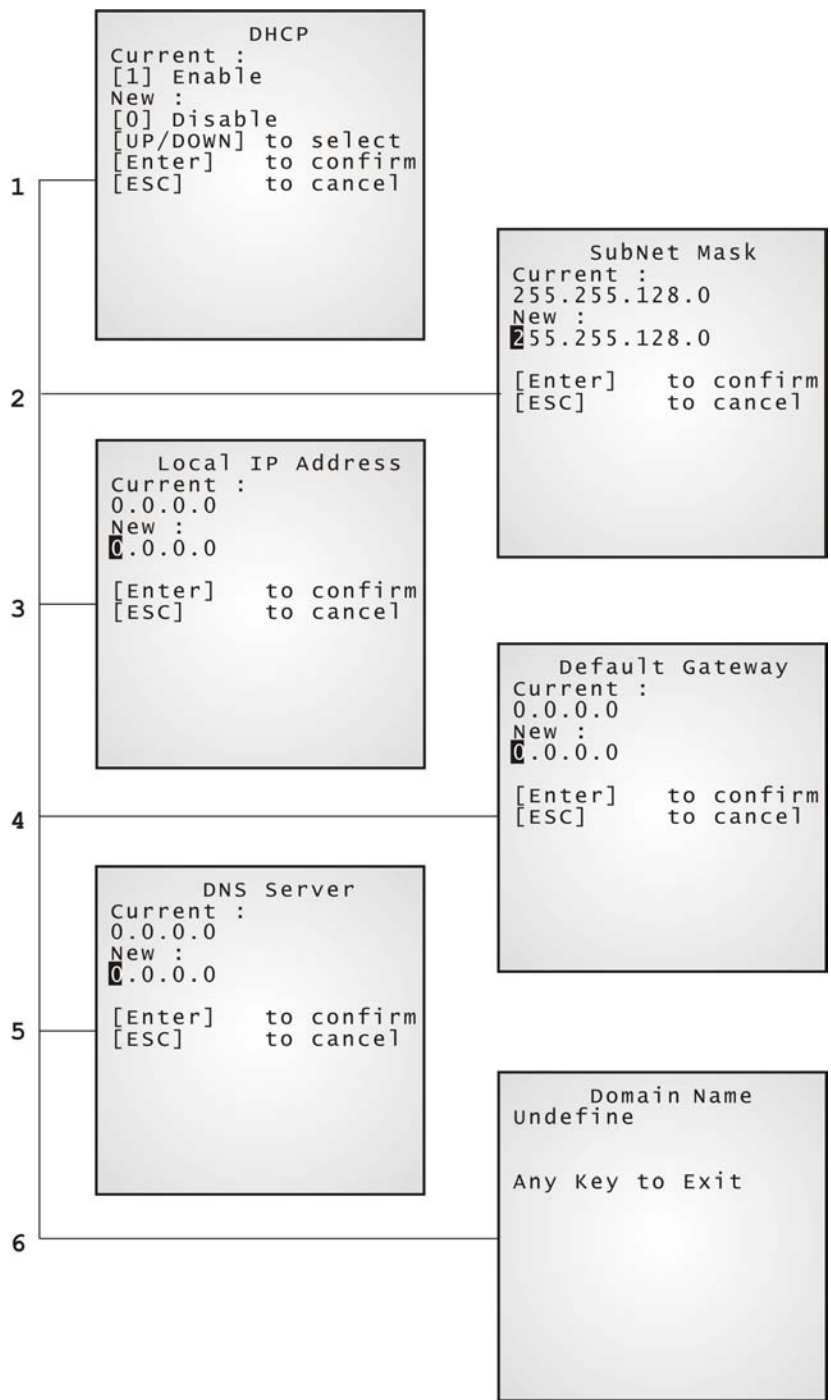

4.1.8 IEEE 802.11b Menu

This submenu is for IEEE 802.11b wireless networking. Parameters must be configured correctly.

Note: This menu is available only when the 802.11b module is installed.

802.11b Menu:	Settings:	Default Values
Network Setting	<i>DHCP</i>	Enable
	<i>SubNet Mask</i>	255.255.128.0
	<i>Local IP Address</i>	0.0.0.0
	<i>Default Gateway</i>	0.0.0.0
	<i>DNS Server</i>	0.0.0.0
	<i>Domain Name</i>	blank
WLAN Setting	<i>Local Name</i>	blank
	<i>Domain Name</i>	blank
	<i>SS ID</i>	blank
	<i>System Scale</i>	Medium
	<i>Power Saving</i>	Enable
Security	<i>Preamble</i>	Long
	<i>Authentication</i>	Open System
	<i>WEP Menu</i>	Disable
	<i>EAP Menu</i>	Disable

➤ 802.11b Menu > Information

Information of network configuration can be viewed here.



- MAC: MAC ID of the 802.11b module
- DHCP: DHCP being enabled or disabled
- IP: IP address of the terminal
- Mask: Subnet Mask
- Gate: Default Gateway

➤ 802.11b Menu > Network Setting

Set general network parameters.



- DHCP: Options - Enable or Disable
- SubNet Mask: Enter a new Mask IP, if necessary.
- Local IP Address: Enter a new address for the terminal, if necessary.
- Default Gateway: Enter a new address for the default Gateway, if necessary.
- DNS Server: Enter a new address for the DNS server, if necessary.
- Domain Name: The domain name of the host is shown here.

Note: All of the setting could be obtained form DHCP server if DHCP is activated.

➤ 802.11b Menu > WLAN Setting

802.11b system can operate in two modes (1) Ad-hoc mode: peer-to-peer, and (2) Infrastructure mode: point to multi-point through access points.

Set the following parameters.



- Local Name: Enter a name for identifying the terminal.
- Domain Name: The domain name of the host is shown here.
- SS ID: This refers to Service Set ID or Identifier.
The terminal can ONLY communicate with access points that have the same SS ID
- System Scale: This refers to Access Point Density.
Options - [1] Low [2] Medium [3] High
The value you set must match that set for the access point.
- Power Saving: This refers to the low power consumption mode.
Options - Enable or Disable
The value you set must match that set for the access point.
- Preamble: Options - [1] Long [2] Short [3] Both
The value you set must match that set for the access point.

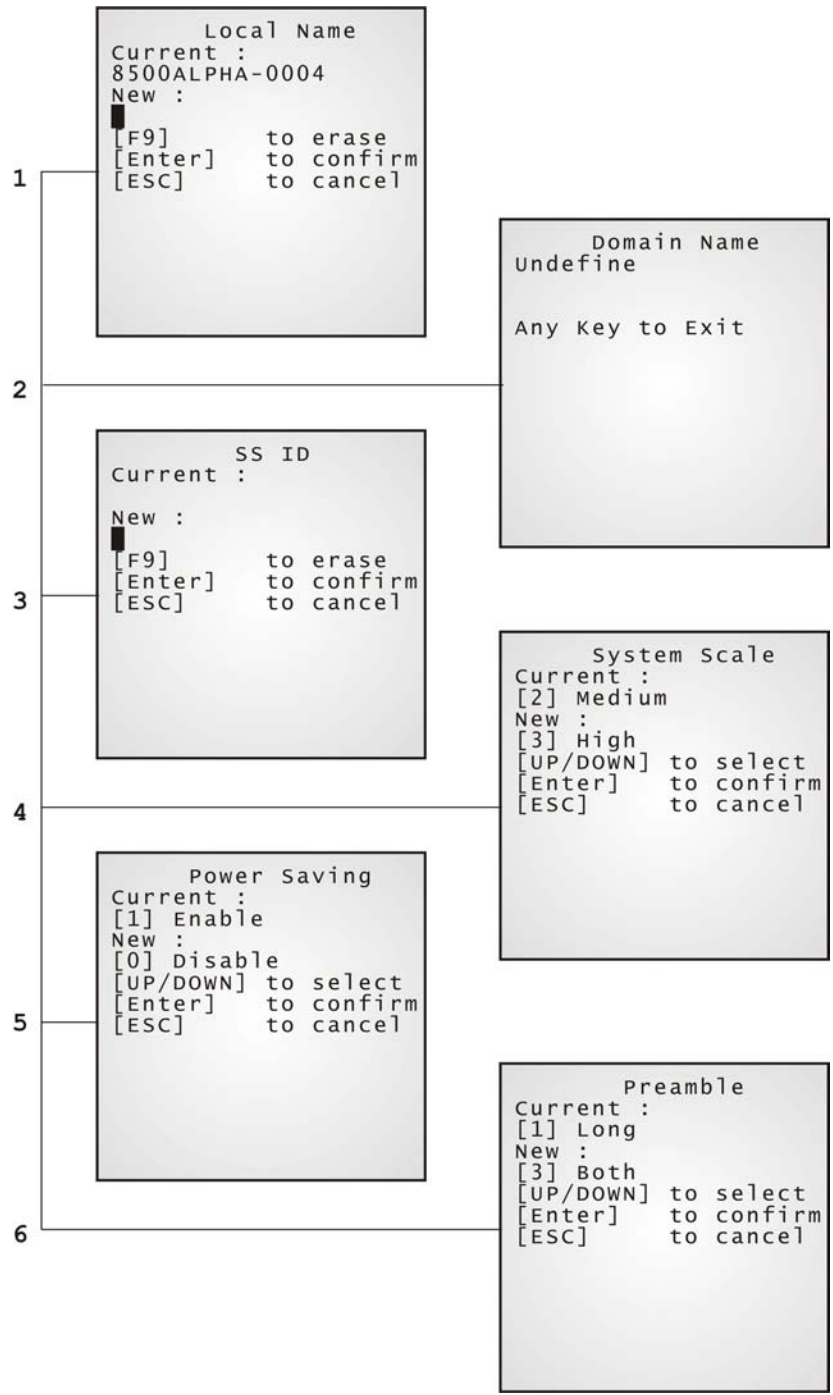

➤ **802.11b Menu > Security**

Set up or modify security parameters:



Authentication

- [1] Open System: Default authentication type
- [0] Share Key: This requires implementing WEP key.

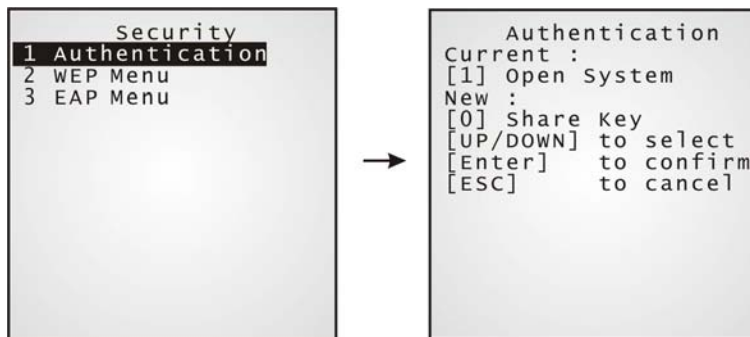

WEP Menu

- WEP Setting: Enable or Disable (for Share Key, it must be enabled.)
- WEP Key Length: 64 or 128 bits
- Default Key: WEP KEY1
- WEP Key: Enter settings for WEP KEY (1, 2, 3 or 4)

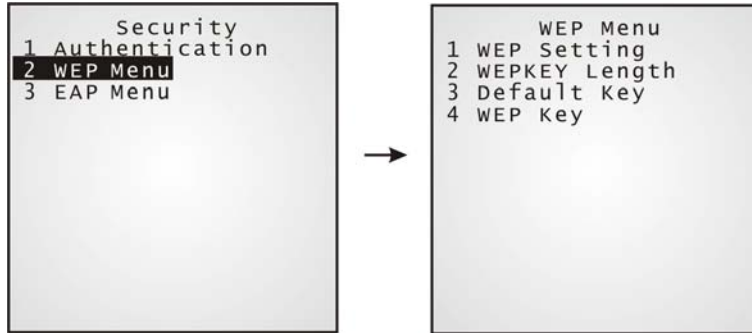

EAP Menu

- EAP Setting: Enable or Disable
- EAP ID: Enter a user name, up to 32 characters
- EAP Password: Enter a password, up to 32 characters

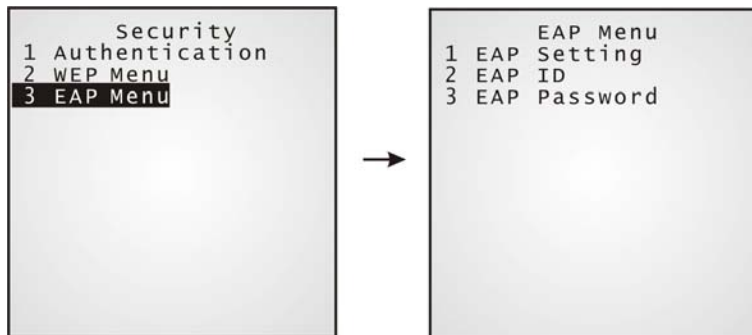

➤ **802.11b Menu > Echo Tests**

Echo tests are used for verifying connectivity to make sure the terminal is within coverage.



▪ **Client Mode:**

Set the terminal as a client.

Enter the IP address of a server that connection is desired.

It is followed by an attempt to make connection with APs.

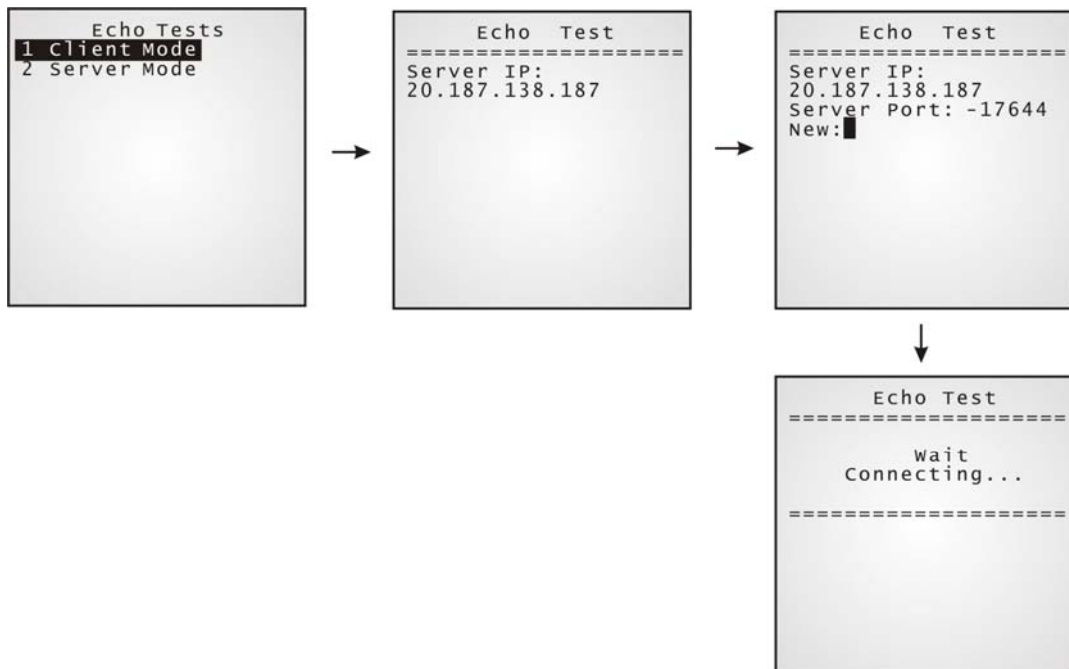

- Server Mode:

Set the terminal as a server.

It is followed by an attempt to make connection with APs.

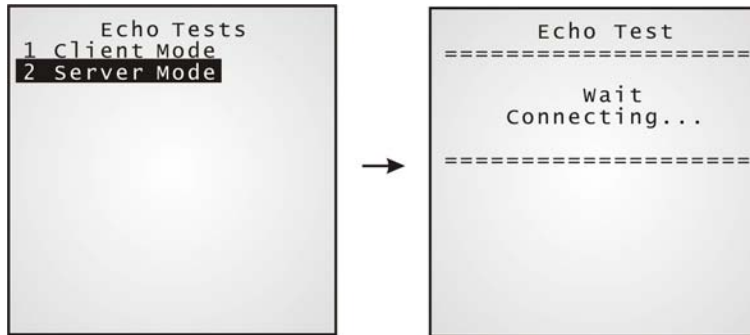

4.2 Program Manager

The CPT-8500 terminal supports multiple applications and languages. In the menu of Program Manager, it can download up to seven programs and one of them is made active.

Warning! The Program Manager menu is NOT for the use of any end users.

How to access the Program Manager?

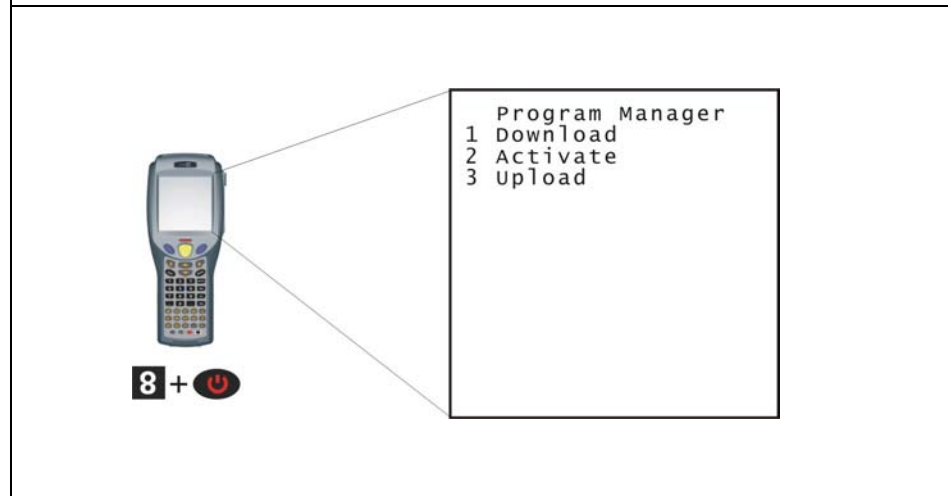

4.2.1 Download

Multiple application programs can be downloaded through a variety of interfaces. Here brings a full list of programs that are currently stored on the terminal with size information (program name of 12 characters; size in kilo bytes).

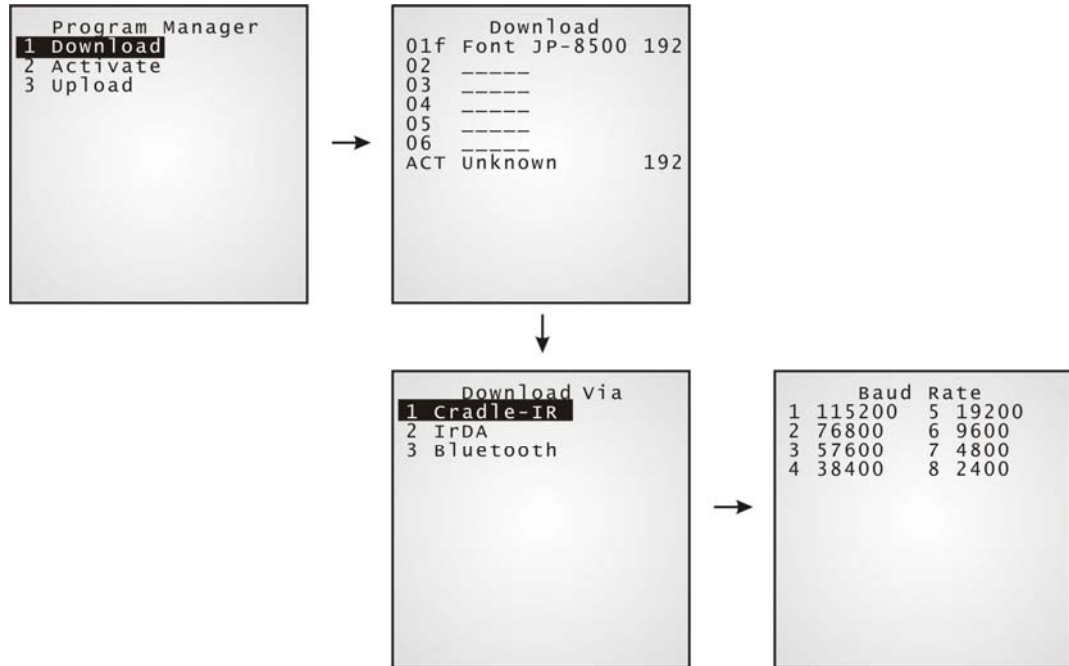

A suffix letter after the memory bank (01~06) indicates the file type of program.

- “b” for BASIC program
- “c” for C program
- “f” for font file

The terminal can store up to seven application programs (including the one in the active memory bank) and one font file (may not be shown in this list).

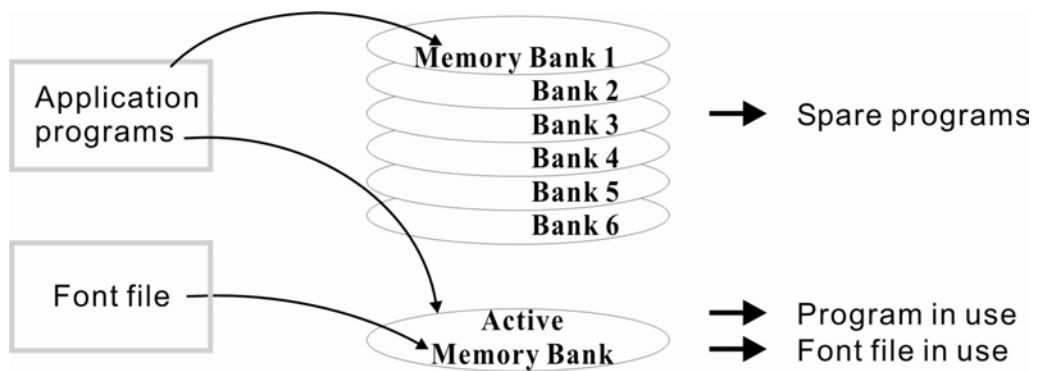

Figure 16: Downloading through Program Manager

➤ Memory Bank 01 ~ 06

Only application program can be downloaded to these banks.

Empty bank:

1. Select an empty bank by pressing the corresponding number and then [Enter].
2. Select baud rate for downloading.
3. Connect cable and wait connecting...
4. To abort the action, press [ESC]. Then press [ESC] again to return to the menu.

Occupied bank:

If no available banks, you'll have to replace one program with the new one.

1. Select a program that you want to delete by pressing the corresponding number and then [Enter].
2. The program information is displayed on the screen. Press [Alpha] to enter the capital mode. Then press [C].
3. Select baud rate for downloading.
4. Connect cable and wait connecting...
5. To abort the action, press [ESC]. Then press [ESC] again to return to the menu. From the menu, you'll find the program is deleted but no new program is present.

If you simply want to delete a program, press [D] in step 2.

Note: [C], [D] are NOT case sensitive.

➤ Active Memory Bank

Only the application program and font file that need to be activated immediately can be downloaded to the active bank. The new font file may not be shown in the program list if application programs take all banks, but you can view font information in the System Menu.

Active bank:

1. Select the active program (may be an empty bank) by pressing the corresponding number (that is 7) and then [Enter].
2. Connect cable and wait connecting...
3. If the downloaded program is an application, it will replace the active program and come into effect immediately. If it is a font file, then the current active program is still in use.

Note: No font file will replace the active application program.

4.2.2 Activate

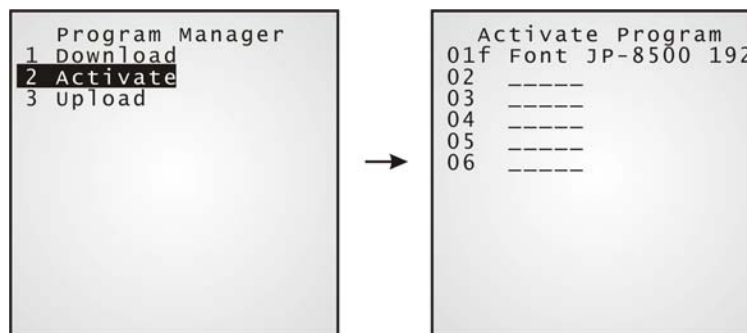

The list shows the entire spare programs stored in the terminal. From the list, you can select from 01 to 06 and activate one of them.

➤ Activate an application program

The selected program will be copied to the active memory bank and replace the current one.

When <New Program Start> screen prompts “Press [ESC] to clear file”, it means the file system in the SRAM will be cleared out by pressing [ESC]. Then there will be no data (transactions, settings, etc.) stored in the terminal when the new program comes into effect. To keep the data, simply press any other key.

➤ Activate a font file

The selected font file will be copied to the active memory bank and replace the current font or system font. However, the active application program will remain intact.

4.2.3 Upload

You may duplicate any program or all in the terminal to a host computer or another terminal.

➤ One Program

The procedures are similar to those for loading programs.

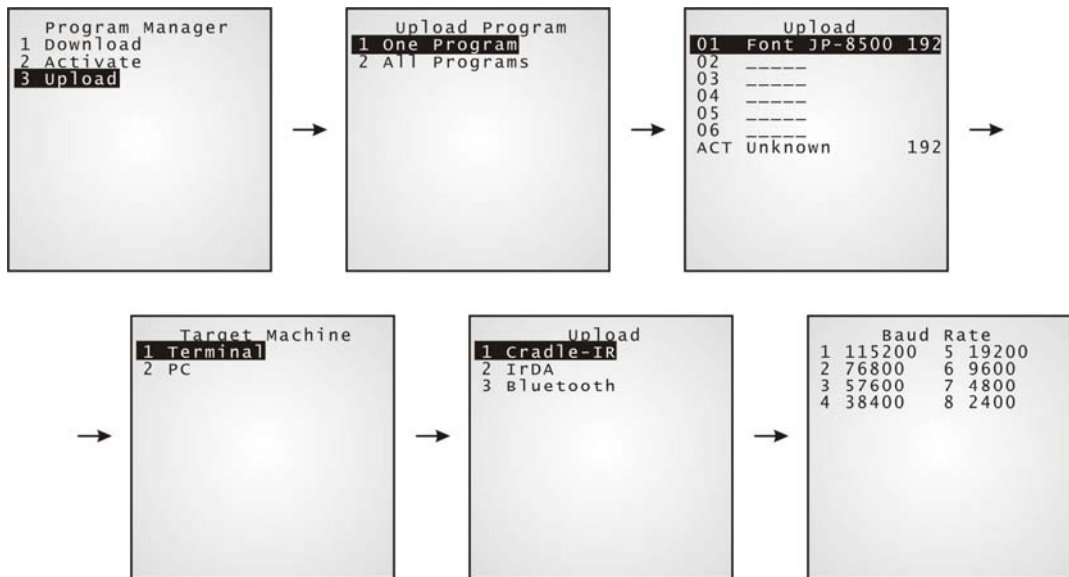

➤ All Programs

The procedures are similar to those for loading programs.

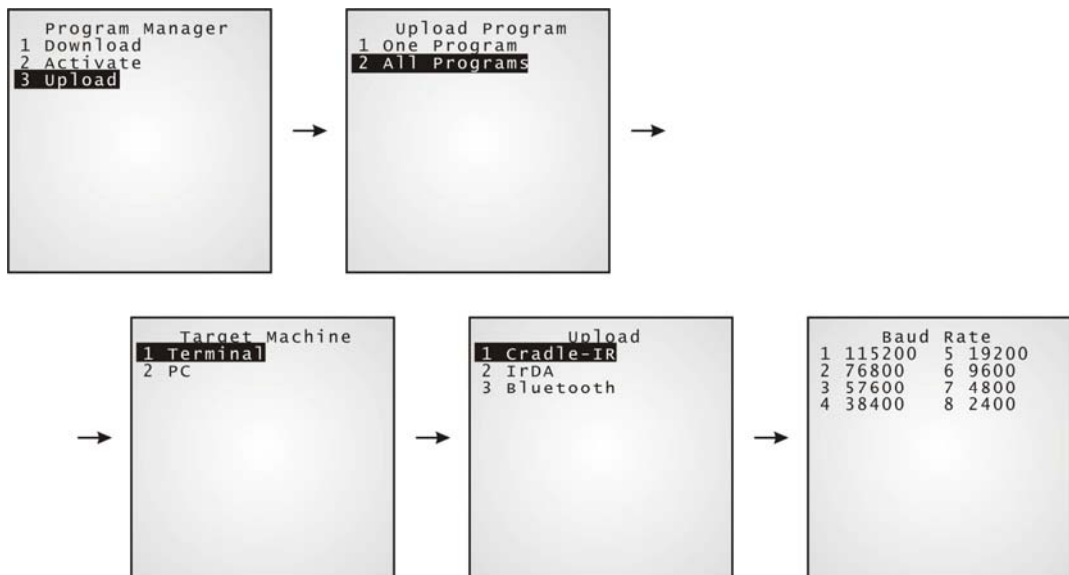

4.3 Kernel Menu

The Kernel Menu resides in the innermost core of the system. It has the highest security and is always protected by the system. When the application program is corrupted and the System Menu fails, the Kernel Menu provides an access to fix the system.

Warning! The Kernel Menu is NOT for the use of any end users.

How to access the Kernel Menu?

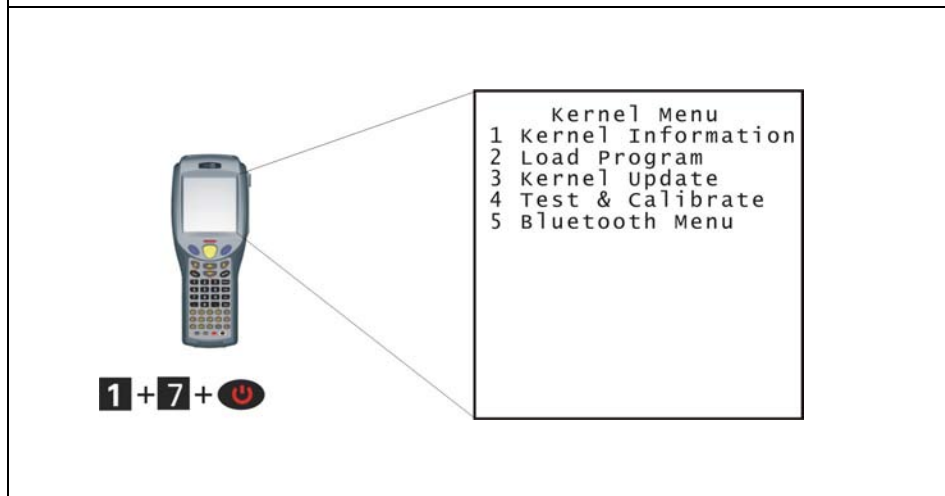

4.3.1 Kernel Information

The information provided here helps diagnose the system.

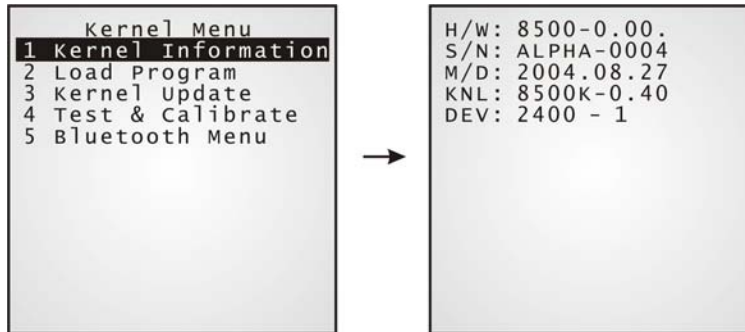

- H/W: Hardware version (PCB)
- S/N: Serial number of the terminal
- M/D: Manufacturing date
- KNL: Kernel version
- DEV: Code for optional hardware configurations, i.e. 2400-1

2	4	0	0	- 1
<i>Type of Reader</i>	<i>Type of Wireless Module</i>	<i>RFID Module</i>	<i>Reserved</i>	<i>Keyboard layout</i>
0= none	0= none	0= none		0= 24-key
1= CCD	3= GSM (+ Bluetooth)	1= RFID		1= 44-key
2= Laser	4= 802.11b (+ Bluetooth)			
3= 2D	5= Bluetooth only			
	7= GSM + 802.11b (+ Bluetooth)			

4.3.2 Load Program

Download program or font file to the active memory bank.

- New application program
- Program update
- Font file, i.e. multi-language font

➤ Results

- Success: the new program or font file will be activated right after downloading.
- Failure: the terminal will resume to the current application program or system font.



Interface

Cradle-IR The communication parameters at PC end should be set accordingly.

IrDA Point to the target IrDA device.

Bluetooth Approach to the target Bluetooth enabled device.

4.3.3 Kernel Update



The Kernel might be changed for improving performance or other reasons, and, an update is necessary.

The procedure is the same as that for downloading program.

4.3.4 Test & Calibrate



These tools are provided for manufacturing use. No user definition is allowed.

- Burn-In Test
- Calibrate RTC
- Base RAM Test
- Memory Card Test
- IR Test
- Bluetooth Test
- CF (CompactFlash) Test
- Scanner Test
- LCDTest
- 2D Test

Warning! This is NOT for the use of any end users.

4.3.5 Bluetooth Menu

This submenu is the same as that under the System Menu except there is no Network Setting here.

Moreover, the echo test for Bluetooth in Kernel mode is available for SPP (Serial Port Profile) only.

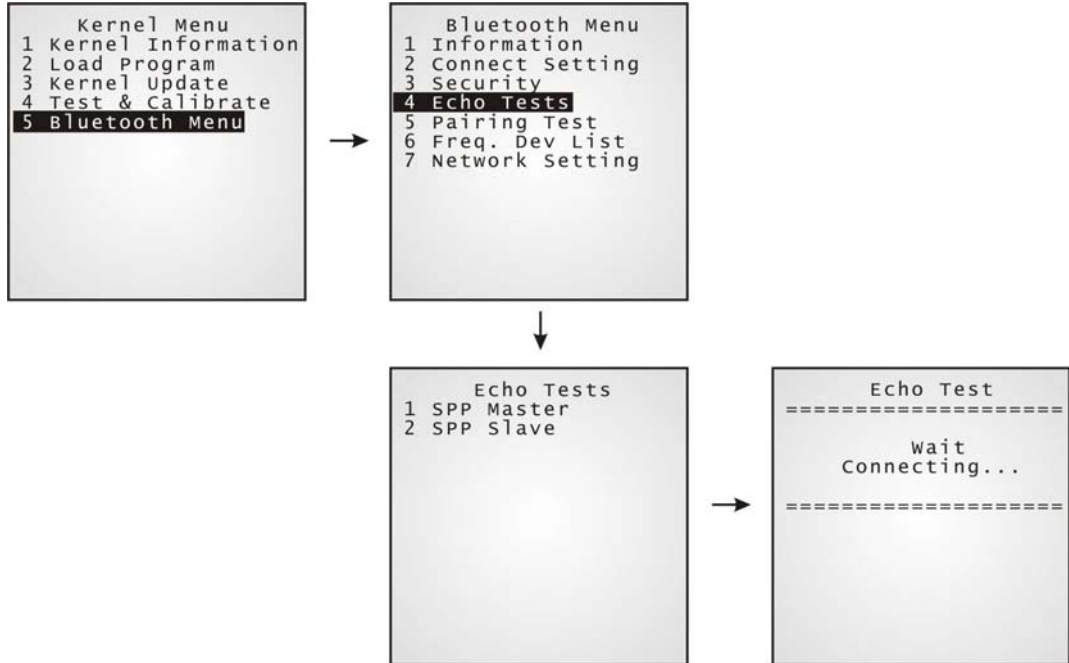

CHAPTER 5

Managing CPT-8500

Depending on the application program downloaded to the terminal, managing the CPT-8500 terminal at PC end can be very flexible and simple.

Note: For details, please see relevant documents such as Programming Guide.

In This Chapter

5.1 For proprietary applications.....	80
5.2 For custom applications.....	80

5.1 For proprietary applications

For the preloaded application program (U8500*.SHX), we provide a PC development tool, the Application Generator (AG8500*.exe), for creating application templates from PC end in a time-saving way.

5.2 For custom applications

For user-defined application programs, software is to be developed by your own system programmers.

➤ **Programming Support**

For development of custom application software, proprietary BASIC or C compiler is available through licensing agreement, as well as libraries.

Specifications

Power	
<i>Main battery:</i>	Rechargeable 3.7 V, 4000 mAh Li-ion battery pack
<i>Backup battery:</i>	Rechargeable 3.0 V, 7 mAh Lithium button cell
<i>Working time:</i>	500 hours
CPU	
<i>32-bit CPU:</i>	Toshiba CMOS type; 40 MHz
Memory	
<i>Flash:</i>	2 MB program memory
<i>SRAM:</i>	Standard 2 MB on-board data memory Memory card (optional)
Programming Support	
<i>Proprietary Development Tool:</i>	Windows-based application generator (AG)
<i>Compilers:</i>	BASIC, C
<i>Emulation</i>	VT 100/200, IBM 5250
Environment	
<i>Humidity:</i>	Operating: 5% to 90% non-condensing Storage: 5% to 95% non-condensing
<i>Temperature:</i>	Operating: -20 to 60 °C Storage: -30 to 70 °C
<i>Shock Resistance:</i>	2 m multiple drops onto concrete
<i>Splash/Dust Resistance:</i>	IP 64
EMC Certified	
<i>FCC</i>	Class A
<i>CE</i>	Class A
<i>C-Tick</i>	Class A
Enclosure	
<i>Material:</i>	Rubber & ABS plastic

<i>Dimensions:</i>	228 mm (L) x 89.5 mm (W) x 59.5 mm (H)
<i>Weight:</i>	Approx. 450 g Approx. 550 g (One battery pack included)
Input Devices	
<i>Reader:</i>	One scan engine (long range imager/laser scanner/2D scanner) and/or the RFID reader
<i>Keyboard:</i>	24-key or 44-key layout Rubber keys, LED backlit, programmable
Display	
<i>Graphic LCD:</i>	160 x 160 pixels, 3" FSTN, LED backlit, programmable 19 lines by 26 characters for small fonts 9 lines by 20 characters for large fonts Touch screen control & signature capture
Indicators	
<i>LED:</i>	One dual-color LED, programmable
<i>Buzzer:</i>	Low power transducer type, 1 KHz to 4 KHz, programmable
<i>Vibrator:</i>	9000 ± 2000 RPM, Max. 50 dB, programmable
Interfaces	
<i>Standard IrDA:</i>	Peer-to-Peer connection through IrDA ports
<i>Bluetooth:</i>	Built-in WPAN networking, class 2
<i>IEEE 802.11b:</i>	WLAN networking (optional)
<i>GSM/GPRS</i>	WWAN networking (optional)

Note: All specifications are subject to change without prior notice.

Troubleshooting

The terminal does not power on when POWER key being pressed...
<ul style="list-style-type: none"> ✓ Make sure the battery pack is installed properly. ✓ Re-charge the battery inside the terminal and monitor the charging status. (see 4.1.5) ✓ If the battery is faulty, replace it with a fresh and fully charged battery then. ✓ Only use the original battery or charging device for the CipherLab product line. The use of wrong battery or charging device could result in damage to human body or the product itself, and will void your warranty.
Charging error...
<ul style="list-style-type: none"> ✓ Make sure the power cord is well connected between the cradle/charger and an outlet. ✓ Check if the battery contacts of the battery itself and the battery compartment are clean. ✓ Try to re-charge the battery and monitor the charging status. ✓ Only use the original battery or charging device for the CipherLab product line. The use of wrong battery or charging device could result in damage to human body or the product itself, and will void your warranty.
The keyboard input seems not working properly...
<ul style="list-style-type: none"> ✓ Perform the keyboard test. (see 4.1.3) ✓ If the problem persists, slide the battery latch to reload the battery pack. Then perform the test again.
The reader does not scan...
<i>Low battery -</i>
<ul style="list-style-type: none"> ✓ Check if the battery icon on the screen indicates a low battery status. If so, replace it with a fresh battery then. ✓ If the problem persists, check if the battery pack is well seated inside the terminal.
<i>Regarding the reader -</i>
<ul style="list-style-type: none"> ✓ Perform the reader test to see if the reader is working. (see 4.1.3) ✓ If the problem persists, slide the battery latch to reload the battery pack. Then perform the test again.

The reader does not decode after scanning...
<i>Unreadable barcode -</i>
✓ Check if the barcode is defaced. A defaced barcode may not be readable.
<i>Un-programmed to read -</i>
✓ Check if the scanner is programmed to read the symbologies (types of barcode) that you are trying to read.
✓ Try scanning a test barcode of the symbology you are trying to read.
<i>Dirty scan window-</i>
✓ Check if the barcode is defaced. A defaced barcode may not be readable.
<i>Out of scanning range -</i>
✓ Try adjusting the scanning distance from the scanner to the barcode.
The terminal cannot transmit/receive data to/from a host computer or other devices...
<i>Over IrDA port -</i>
✓ Make sure the terminal's infrared port is pointed directly to the infrared port of another IrDA device. The distance between the terminal and a target device is within proper range, and no obstacles in between. Try to establish connection again.
<i>Via Bluetooth -</i>
✓ Make sure the distance between the terminal and a target device is within proper range. Try to establish connection again.
✓ Check if the relevant settings are correct. (see 4.1.7)
✓ Check if the connection is working properly. (see 4.1.7)
<i>Over RS-232 port via Cradle -</i>
✓ Check if the RS-232 connection is correct and secured.
✓ Make sure the serial port parameters on the host are configured to match the serial parameters on the terminal. Try to establish connection again.
✓ Make sure the terminal is well seated inside the cradle. DO NOT remove the terminal or disconnect the cradle before communications are done.
✓ If the problem persists, run the IR Echo Test to check the IR interface between the terminal and the cradle. (see 4.1.3)

<i>Over MODEM port via Cradle -</i>
<ul style="list-style-type: none"> ✓ Check if the modem connection is correct and secured. ✓ Make sure the modem parameters are configured to match the parameters on the terminal. Try to establish connection again. ✓ Make sure the terminal is well seated inside the cradle. DO NOT remove the terminal or disconnect the cradle before communications are done. ✓ If the problem persists, run the IR Echo Test to check the IR interface between the terminal and the cradle. (see 4.1.3)
About abnormal response...
<i>The LED or LCD seem not working properly -</i>
<ul style="list-style-type: none"> ✓ Perform the LCD & LED test. (see 4.1.3) ✓ If the problem persists, reload the battery pack and perform the test again.
<i>The buzzer seems not working properly -</i>
<ul style="list-style-type: none"> ✓ Perform the buzzer test. (see 4.1.3) ✓ If the problem persists, reload the battery pack and perform the test again.
<i>The terminal seems not working properly -</i>
<ul style="list-style-type: none"> ✓ First upload all data to a computer, and then perform the memory test. (see 4.1.3) ✓ If the problem persists, reload the battery pack and perform the test again.
<i>The touch screen seems not working properly -</i>
<ul style="list-style-type: none"> ✓ Perform the touch screen test. (see 4.1.3) ✓ If the problem persists, reload the battery pack and perform the test again.
<i>The vibrator seems not working properly -</i>
<ul style="list-style-type: none"> ✓ Perform the vibrator test. (see 4.1.3) ✓ If the problem persists, reload the battery pack and perform the test again.

Appendix I - Download Utilities

These utilities are for downloading any user program (*.shx or *.syn) to the terminal.

- *.SHX: Any C program, such as AG runtime, Basic runtime or font file.
- *.SYN: Any Basic program based on Basic runtime installed first.

Currently, the ProgLoad.exe has replaced several previously released utilities.

ProgLoad.exe

has replaced the following utilities:

Download.exe

IRLoad.exe

SynLoad.exe

TcpLoad.exe

TcpSynLoad.exe

File type:

*.SHX

*.SHX

*.SYN

*.SHX

*.SYN

Note: Both TcpLoad.exe and TcpSynLoad.exe are not for portable terminals. They are for the use of stationary terminals.

➤ Downloading in System mode

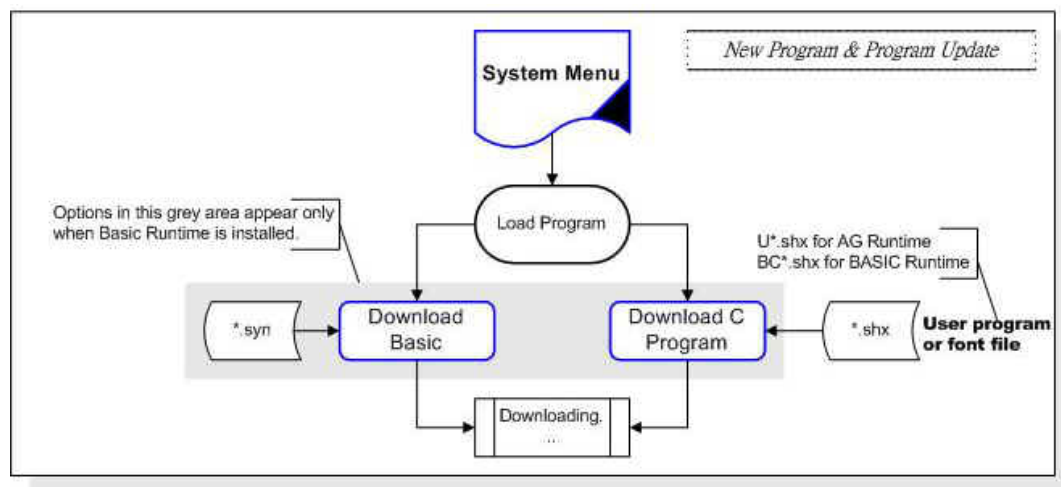

➤ **Downloading in Kernel mode**

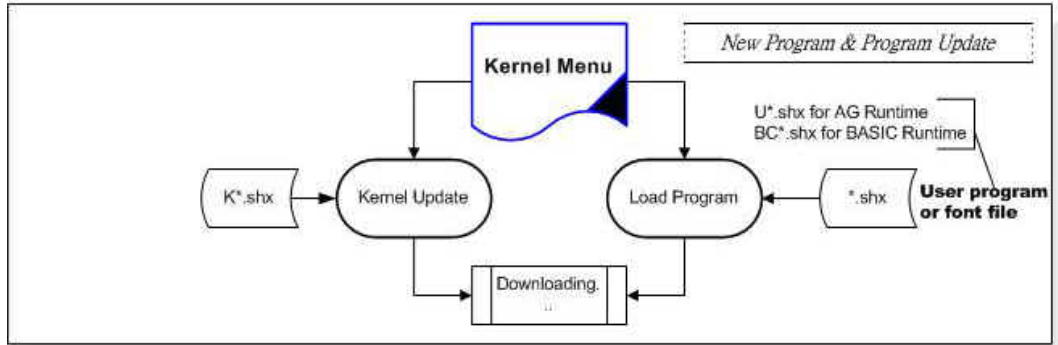

Figure 17: Downloading in Kernel mode

➤ **Downloading in Program Manager mode**

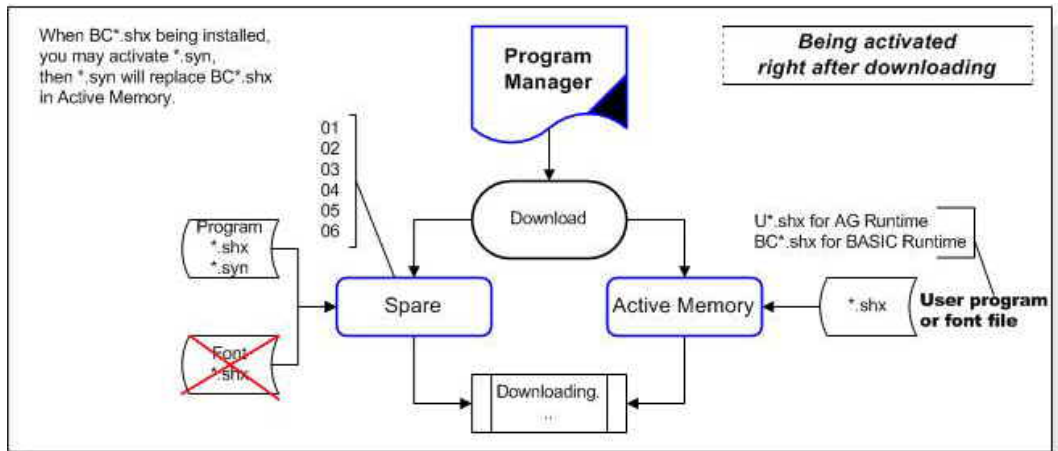

Figure 18: Downloading in Program Manager mode

ProgLoad, all-in-one interface

- File name: ProgLoad.exe
- It supports all file types and communications interfaces.

Communications Interface:

RS-232 / IrDA	Connection via direct RS-232 cable or IrDA port
Serial IR	Connection via serial cradle

TCP/IP Connection via networks

File Type:

- *.SHX Any C program, such as AG runtime, Basic runtime or font file
- *.SYN Any Basic program based on Basic runtime installed first

➤ **Selection Menu**

Step 1: Execute program. The following menu pops up.

Step 2: Select interface, file and COM port properties from the menu.

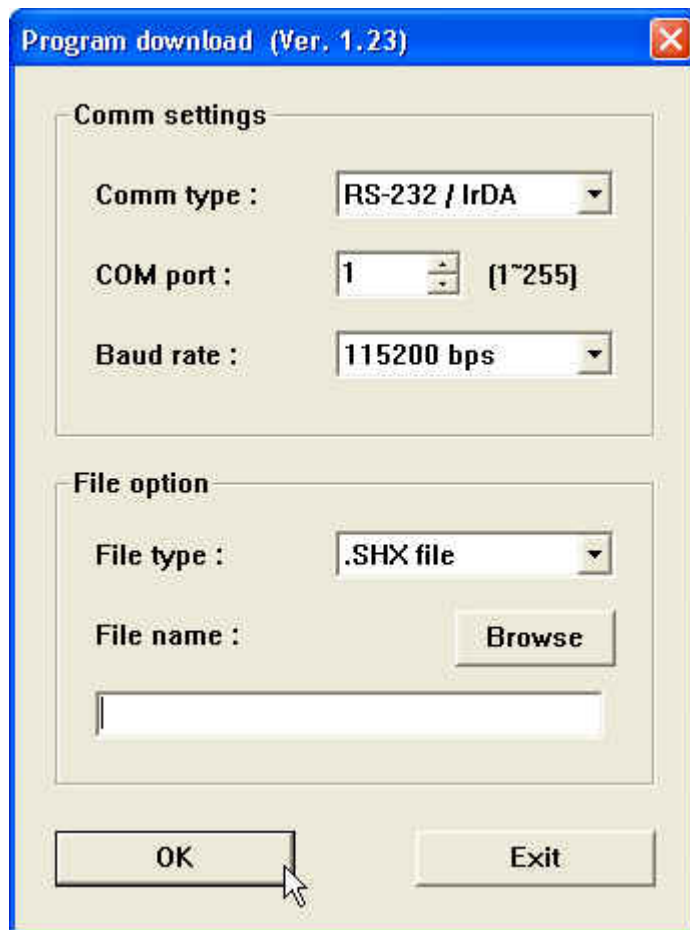

IRLoad, Cradle-IR interface

- File name: IRLoad.exe
- It supports command line arguments.

➤ Selection Menu

Step 1: Execute program.

Step 2: Choose file.

Step 3: Set the following COM port properties.

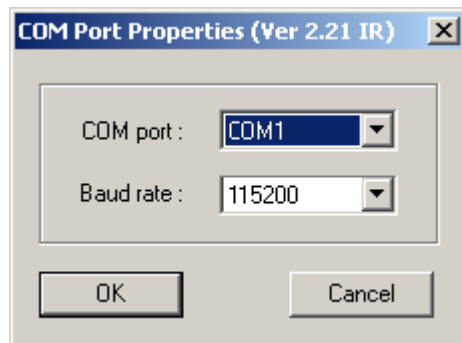

➤ Command Line

IRLOAD U8300-114.SHX,2,1//COM2,115200 bps

If command line arguments are not given, the user can select appropriate parameters from the pop-up dialog box.

IRLOAD [filename],[COM port],[Baud rate]

File name:	The file name of the program that is to be downloaded.		
COM port:	1 ~ 8		Default: 1
Baud rate:	1 ~ 5	1 for 115200 bps	Default: 1
		2 for 57600 bps	
		3 for 38400 bps	
		4 for 19200 bps	
		5 for 9600 bps	

Download, RS-232 or IrDA interface

- File name: Download.exe
- It supports command line arguments.

➤ Selection Menu

Step 1: Execute program.

Step 2: Choose file.

Step 3: Set the following COM port properties.

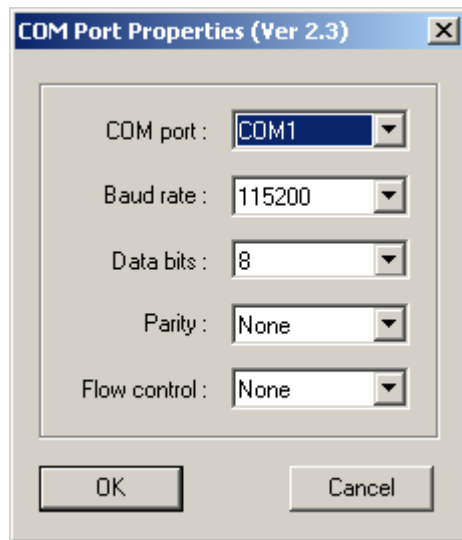

TcpLoad, IP interface

- File name: TcpLoad.exe

➤ **Selection Menu**

Step 1: Execute program.

Step 2: Choose file.

Step 3: Set target IP address as follows.

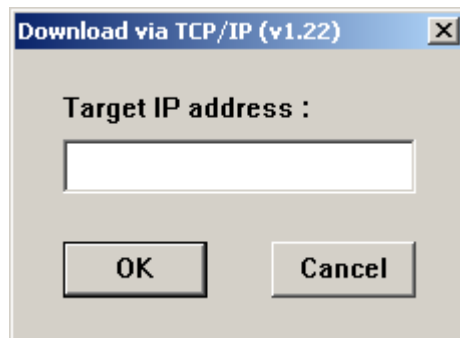

Index

A

Access Point • 17, 18, 59
Activate • 73
Ad-hoc • 17, 18, 64
AG Runtime • 35
Application Generator (AG) • 35, 80
Authentication • 54, 66
Auto Off • 41

B

Backlight • 13, 41
Battery • 22, 23
 Backup • 7
 Low • 8
 Main • 7
Bluetooth • 15, 17, 33
 Menu • 50, 79
BNEP • 17, 55, 57
Broadcast • 52
BSC • 39, 51
Buzzer • 13, 46

C

Calendar • 8
Calibrate • 78
Calibration • 43
Charging • 23, 31
 Initial • 7
 Status • 29
Client Mode • 57, 68
Communications • 23, 31
 Status • 29
 Wired • 32
 Wireless • 33
CPU • 8
Cradle • 22, 26, 28, 31, 33
CTY • 51

D

Data Loss • 9
DEV • 39, 76
Development Tools • 20, 80

DHCP • 51, 60, 63
Dial Out • 55, 56
DIP Switch • 30, 33
DNS • 60, 63
Domain • 60, 63, 64
Download • 49, 71, 77, 86
Dual Mode • 14
DUN • 17, 55, 56, 58, 59

E

EAP • 67
Echo • 55, 68, 79
 IR • 46

F

Font • 12, 43, 49, 71, 77
Frequent Device List • 59
FSTN • 12

G

Gang Charger • 31
Gateway • 51, 60, 63
GSM/GPRS • 15, 19, 33

H

Hand Strap • 22, 24

I

IAM • 51
IEEE 802.11b • 15, 18, 33
 Menu • 62
Infrastructure • 18, 64
Ingress Protection (IP) • 20
IrDA • 15, 16, 33

K

Kernel Menu • 36, 75
Keyboard • 9, 46
 Key Click • 42
 Layout • 10, 11
KNL • 39, 76

L

LCD • 12, 46
LED • 13, 46
LIB • 39, 51
Local IP • 51, 60, 63
Local Name • 52, 64

M

MAC • 51, 63
Master Mode • 56
Memory • 8, 46, 47
Module
 Kernel • 36
 Program • 35
 System • 36

P

Pairing • 58
PAN • 17, 55, 57, 58, 59
Piconet • 52
PIN • 54
Pistol Grip • 22, 25
Power • 7, 48
Power On • 41
Power Saving • 52, 64
Preamble • 64
Program Manager Menu • 36, 70

R

Reader • 45
 2D Scanner • 14
 Laser Scanner • 14
 Long Range Imager • 14
 RFID Reader • 14
Real Time Clock (RTC) • 7, 40
Remote Name • 52
Reset • 44
Resistance
 Shock • 20
 Splash & Dust • 20
RFID • 14, 46

S

Screen Icons • 9
Server Mode • 57, 69
Signature Capture • 13
Slave Mode • 56
SPP • 17, 55, 56, 58, 59, 79
SS ID • 64

Subnet Mask • 51, 60, 63
System Menu • 36, 38
System Password • 42
System Scale • 64

T

Terminal Emulation • 20
Tests • 45, 46, 55, 68, 78
Touch Screen • 13, 43, 46

U

Update • 49, 77
Upload • 74
USR • 39

V

Vibrator • 13, 46

W

WEP • 67
Wireless • 15
WLAN • 18, 64
WPAN • 17
WWAN • 19