

UHF Narrow band radio data module **CDP-TX/RX-02E-R 457 MHz**



Operation Guide

Version 1.1 (May.2008)

CIRCUIT DESIGN, INC.,

7557-1 Hotaka, Azumino-city
Nagano 399-8303 JAPAN
Tel: + +81-(0)263-82-1024
Fax: + +81-(0)263-82-1016

e-mail: info@circuitdesign.jp
<http://www.cdt21.com>

CONTENTS

FEATURES & APPLICATIONS	3
GENERAL DESCRIPTION.....	3
SPECIFICATIONS	4
PIN DESCRIPTION.....	7
CHANNEL AND FREQUENCY SETTING.....	9
POWER SETTING	9
ANTENNAS.....	10
BLOCK DIAGRAM	11
DIMENSIONS	13
TEST DATA	15
REGULATORY COMPLIANCE INFORMATION	16
CAUTION & WARNINGS	17
REVISION HISTORY	18
APPLICATION NOTE	19

GENERAL DESCRIPTION & FEATURES

Features

- FCC Part 90.217 (transmitter) and Part 15 compliant (receiver)
- 1 mW / 10 mW selectable
- Frequency selection free in 32 channels for 457 MHz
- High sensitivity receiver
- FM narrow band modulation

Applications

- Mobile / Handheld Portable device defined by FCC
- Factory automation M2M
- Remote control
- Security systems
- Alarms
- Telemetry systems

General description

The CDP-TX-02E-R and CDP-RX-02E-R are a RoHS compliant FCC approved embedded industrial narrowband FM radio transmitter and receiver.

They are suitable for various application fields such as wireless data communication, telemetry or wireless security systems. They are easy to use and integrate into application systems.

Both CDP-TX-02E-R and CDP-RX-02E-R are equipped with a frequency synthesizer system with micro controller. Available frequency ranges are from 457.5 MHz to 457.8875 MHz (32 channels: 16 ch x 2 groups). The compact size, low operating voltage and frequency selectability of the CDP-TX/RX-02E-R make it ideal for various applications where its interference rejection and practical distance range is far better than similar RF modules based on wide band SAW-resonator frequency generators.

SPECIFICATIONS

General specification

- * The MIN/TYP/MAX values for the RF output power and BER are specified in the range of operating temperature.
- * All values in the specification column are measured and specified with 50 ohm terminal and at 25 °C +/- 10 °C unless otherwise noted.

Item	Unit	Specification	Remarks	MIN	TYP	MAX
Reference		FCC Part 90.217 (TX) FCC Part 15 (RX)				
Communication method		One-way				
Operating frequency range	MHz	457.6 MHz band	Within SAW filter band	457.5		458.5
Operation temperature range	°C	-20 to 60	No dew condensation	-20		60
Storage temperature range	°C	-30 to 70	No dew condensation	-30		70
Aging rate	ppm	+/- 1 / year	TX freq., RX Lo freq.	-1		1
Initial frequency tolerance *	ppm	+/- 2	TX freq., RX Lo freq.	-2		2
Dimensions (TX-02E)	mm	26 x 36 x 10	Not including protrusion			
Weight (TX-02E)	g	14			14	
Dimensions (RX-02E)	mm	30 x 50 x 9	Not including protrusion			
Weight (RX-02E)	g	20			20	

* Initial frequency tolerance is frequency drift at delivery within 1 year after the final adjustment

Electrical specification

Common to TX/RX

Item	Unit	Specification	Remarks	MIN	TYP	MAX
Oscillation type		PLL controlled VCO				
Frequency stability	ppm	+/- 4 (-20 to 60°C)	Reference temp.=25°C	-4		4
Channel span	kHz	25			25	
Number of channel	ch		(Max 16ch x 2) selectable			
Default channel setting	ch					
Data rate	bps	2400 (1.2 kHz)	DO / DI			2400
Max. pulse width	ms	20	DO / DI			20
Min. pulse width	µs	410	DO / DI	410		
Data polarity		Positive	DI Vs Do			
Lo level for channel select	V	GND		0		0.4
Hi level for channel select	V	2.7 or open		2.5		3.0
PLL reference frequency	MHz	21.25 (TCXO)			21.25	
PLL response	ms	30	from PLL setting to LD out		30	100
Antenna impedance	Ω	50 (Nominal)			50	
Operating voltage	V	3 - 12		3		12
TX consumption current	mA	43 @ 10mW	Vcc=3.0V		43	48
TX consumption current	mA	33 @ 1mW	Vcc=3.0V		33	38
RX consumption current	mA	30	Vcc=3.0V		30	35

Transmitter

Item		Specification	Remarks	MIN	TYP	MAX
RF output power (10 mW)	mW	10	at 457.6 MHz	7	10	13
RF output power (10 mW)	mW	Over all frequency range and operating temp. range		4		16
RF output power (1 mW)	mW			0.3	1	2.6
Deviation	kHz	± 2.1	PN9 2400bps / LPF=20k	± 1.6	± 2.1	± 2.6
DI input level for Lo	V	L=GND		0		0.4
DI input level for Hi	V	Hi=3V		3		5.5
TX carrier start up	ms	50	From power on to f ± 1.5ppm		50	100
TX carrier start up at ch change	ms	35	Shift 25kHz to f ± 1.5ppm		35	85
Residual FM noise	kHz	0.17	DI=L, LPF=20k		0.17	0.4
Spurious emission	dBc	30 (50 ohm contact)	* up to 4 th harmonics	30	40	
Adjacent CH power	dBc	40	PN9 2400 bps	40		

Receiver

Item		Specification	Remarks	MIN	TYP	MAX
Receiver type		Double superheterodyne				
1st IF frequency	MHz	21.7			21.7	
2nd IF frequency	kHz	450			450	
Max. input level	dBm	10				10
BER (0 error / 2556 bits)	dBm	-116	PN9 2400bps	-106	-116	
BER (1% error)	dBm	-120	PN9 2400bps		-120	
Sensitivity 12dB / SINAD	dBm	-120	fm1k / dev 2.0k CCITT		-120	
Spurious response rejections	dB	70 (1st Mix)	Two signal method, 1% error		70	
	dB	55 (2nd Mix)			55	
Adjacent CH selectivity	dB	60 dB (±25k)			60	
Blocking	dB	84 dB (+/- 1MHz)			84	
Intermodulation	dB	50 dB (f-200k+f-100k)			50	
DO output level for Hi	V	Hi = Vcc		Z = 100 kohm or more	Vcc x0.8	
DO output level for Lo	V	Lo = GND	Z = 100 kohm or more	0		0.7
RSSI rising time	ms	30 (from PLL setup)	CH shift of 25kHz		30	60
Time until valid Data-out	ms	50 (from PLL setup)	CH shift of 25kHz		50	100
RSSI rising time	ms	50 (from PLL setup)	When power ON		50	100
Time until valid Data-out	ms	70 (from PLL setup)	When power ON		70	140
Spurious radiation (1st Lo)	dBm	-57 (50 ohm contact)	* Up to 4 th harmonics		-60	-57
RSSI	mV	235 (457.6 MHz)	with -110 dBm	195	235	275
	mV	230 (457.6MHz)	with -116 dBm	155	195	235

Notes about the specification values

BER: RF level where no error per 2556 bits is confirmed with the signal of PN9 and 2400 bps.

BER (1% error): RF level where 1% error per 2556 bits is confirmed with the signal of PN9 and 2400 bps.

Spurious response, CH selectivity: Jamming signal used in the measurement is unmodulated.

Intermodulation: Ratio between the receiver input level with BER 1% and the signal level (PN9 2400 bps) added at the points of "Receiving frequency -200 kHz" + "Receiving frequency -100 kHz" with which BER 1% is achieved.

Time until valid Data-out: Valid DO is determined at the point where Bit Error Rate meter starts detecting the signal of 2400 bps, 1010 repeated signal.

Conditions: All specifications are specified based on the data measured in a shield room using the PLL setting controller board prepared by Circuit Design.

Measurement equipment SG = ANRITSU communication analyzer MT2605
Spectrum analyzer = ANRITSU MS2663G / BER measure = ANRITSU MP1201G

NOTICE

- * Communication range depends on the operation environment and ambient surrounding.
- * For improvement, specifications are subject to change without prior notice.
- * Antenna connection of receiver CDP-RX-02E-R is designed as pin connection. Sensitivity, spurious emission and unwanted radiation levels may vary with the pattern used between the RF pin and the coaxial connection. Please make sure to verify those parameters before use.
- * The feet of the shield case should be soldered to the wide GND pattern to avoid any change in characteristics.

PIN DESCRIPTION

CDP-TX-02E-R

Pin name	I/O	Description	Equivalent circuit
ANT	O	RF output terminal Antenna impedance nominal 50 Ω	
GND	I	The ground for the power supply. Connect it to the ground plane as well as to the bottom part of the case. The ground plane has an impact on the range and the stability of operation.	
VCC	I	The power supply terminal. The supply voltage is DC 3.0 to 12 V. Power supply noise and ripple have an impact on performance, so eliminate them as far as possible with filters and capacitors.	
DATAIN	I	Digital data input terminal Interface voltage: H = 3 to 5.5V L = GND	

CDP-RX-02E-R

Pin name	I/O	Description	Equivalent circuit
ANT	O	RF input terminal Antenna impedance nominal 50 Ω	
GND	I	The ground for the power supply. Connect it to the ground plane as well as to the bottom part of the case. The ground plane has an impact on the range and the stability of operation.	
VCC	I	The power supply terminal. The supply voltage is DC 3.0 to 12 V. Power supply noise and ripple have an impact on performance, so eliminate them as far as possible with filters and capacitors.	
RSSI	O	The receive level output of the receiver. The strength of the RF level (electric field intensity) is output as a direct-current voltage.	
DATA	I	Digital data output terminal Interface voltage: H = Vcc L = GND	
AF	O	The demodulated output of the receiver. The DC offset is about 1 V. Refer to the specifications for the amplitude level.	

CHANNEL AND FREQUENCY SETTINGS

By use of a chip mounted 4-bit switch or pins and a jumper on the PCB, you can select easily between the 32 channels. The 32 channels are divided into 2 groups: Group A and Group B. Each group of channels can be selected by soldering the jumper ON or OFF. When the jumper (JP2) is ON, Group A is selected. When the jumper is OFF, Group B is selected. There are 16 channels in each group and they can easily be selected using the 4-bit switch. Before shipment all the modules are set to Group A channel 5. (457.6 MHz)

Channel Table

Ch	Freq. (MHz)	4-bit Switch *				Jumper	Ch	Freq. (MHz)	4-bit Switch *				Jumper
		1	2	3	4				1	2	3	4	
A1	457.5000	ON	ON	ON	ON	ON	B1	457.5125	ON	ON	ON	ON	OFF
A2	457.5250	OFF	ON	ON	ON	ON	B2	457.5375	OFF	ON	ON	ON	OFF
A3	457.5500	ON	OFF	ON	ON	ON	B3	457.5625	ON	OFF	ON	ON	OFF
A4	457.5750	OFF	OFF	ON	ON	ON	B4	457.5875	OFF	OFF	ON	ON	OFF
A5	457.6000	ON	ON	OFF	ON	ON	B5	457.6125	ON	ON	OFF	ON	OFF
A6	457.6250	OFF	ON	OFF	ON	ON	B6	457.6375	OFF	ON	OFF	ON	OFF
A7	457.6500	ON	OFF	OFF	ON	ON	B7	457.6625	ON	OFF	OFF	ON	OFF
A8	457.6750	OFF	OFF	OFF	ON	ON	B8	457.6875	OFF	OFF	OFF	ON	OFF
A9	457.7000	ON	ON	ON	OFF	ON	B9	457.7125	ON	ON	ON	OFF	OFF
A10	457.7250	OFF	ON	ON	OFF	ON	B10	457.7375	OFF	ON	ON	OFF	OFF
A11	457.7500	ON	OFF	ON	OFF	ON	B11	457.7625	ON	OFF	ON	OFF	OFF
A12	457.7750	OFF	OFF	ON	OFF	ON	B12	457.7875	OFF	OFF	ON	OFF	OFF
A13	457.8000	ON	ON	OFF	OFF	ON	B13	457.8125	ON	ON	OFF	OFF	OFF
A14	457.8250	OFF	ON	OFF	OFF	ON	B14	457.8375	OFF	ON	OFF	OFF	OFF
A15	457.8500	ON	OFF	OFF	OFF	ON	B15	457.8625	ON	OFF	OFF	OFF	OFF
A16	457.8750	OFF	OFF	OFF	OFF	ON	B16	457.8875	OFF	OFF	OFF	OFF	OFF

* A5: Default setting

4 bit switch: ON = L (GND) OFF = H (Open)

JP2: Frequency Group Setting (Switch: ON = "L" / OFF = "H")

Group A: Jumper ON Group B: Jumper OFF (Default)

(Example) Set to channel B10 (457.7375 MHz)

Group B: JP2: Jumper OFF Dip Switch: OFF, ON, ON, OFF (ON: Short to GND)

Position of the JP1, JP2 and DIP SW

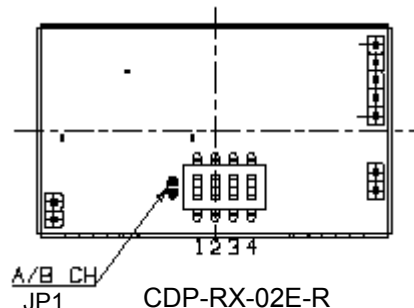
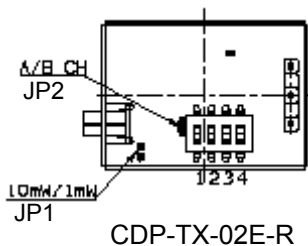

POWER SETTING

CDP-TX-02E-R can be set to either 10 mW or 1 mW by a jumper on the PCB.

JP1: Power Setting (Switch: ON = "L" / OFF = "H")

10 mW: Jumper ON (Default) 1 mW: Jumper OFF

ANTENNAS

The most important factors for safe data transmission are a good antenna and RF grounding, both for the transmitter and the receiver. Without an antenna it is impossible to transmit data over a long distance.

The standard antenna is a Lambda/4 wire protected by a plastic cover.

The receiver has a simple antenna input pin. Any suitable UHF antenna can be connected to it.

The easiest way to connect an antenna to the CDP-RX-02E-R is to solder a 17 cm wire directly to the antenna input. A 50 Ohm coaxial cable can be used to extend the distance between the antenna and the receiver. The shielding of the antenna wire should be soldered to the case near the antenna input of the CDP-RX-02E-R.

It is possible, but not recommended to connect the receiver module and the antenna by a connection on the PCB. This will decrease the receiver performance in most cases.

To find the best method of installation for the transmitter and receiver, many things should be considered and tested. It is recommended that you read specialized literature on antennas and radiation characteristics to gain a better understanding of these fields. A detailed explanation cannot be given here.

Notice: For CDP-TX-02E-R, use the antenna provided. Using other antennas may invalidate compliance with the regulatory standards.

In most cases the following basic rules will help you.

- Connect an antenna with 50 Ohm impedance for 457 MHz.
- The easiest construction is a wire of approximately 17 cm.
- Place the antenna vertically, straight up or down from the transmitter and receiver module.
- Do not cover the antenna with metal parts.
- The connection of the metal surface of the transmitter and receiver case to a larger metal part (ground plane) will increase radiation and reception efficiency. These metal parts should not be placed near the antenna.
- The best range is achieved if the transmitter and receiver antenna are in direct line of sight. Any object in between the transmitter and receiver antenna, and metallic objects in particular, will decrease the range.
- The transmission is influenced by reflections of the transmitter signal on metallic surfaces. By overlaying the direct and reflected signal with a 180 degree phase shift the signal can almost fade out. These reflections and fade-outs can result in data drop-outs in mobile applications.
- The human body can have a similar effect as metal objects. Pocket transmitters should be held in your hand, held in a position away from the body and pointed in the direction of the receiver.

BLOCK DIAGRAM <CDP-TX-02E-R>

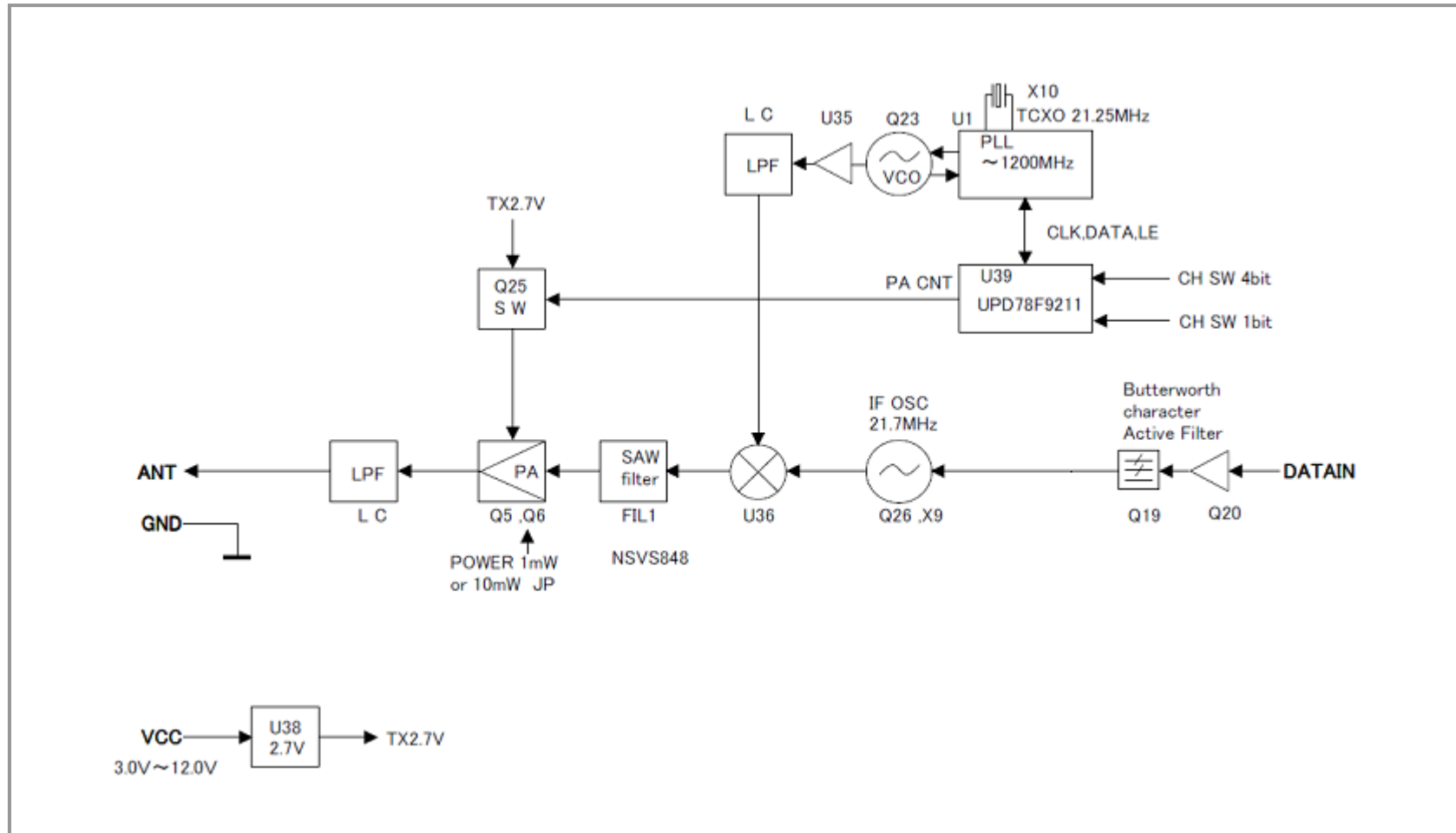

<CDP-RX-02E-R>

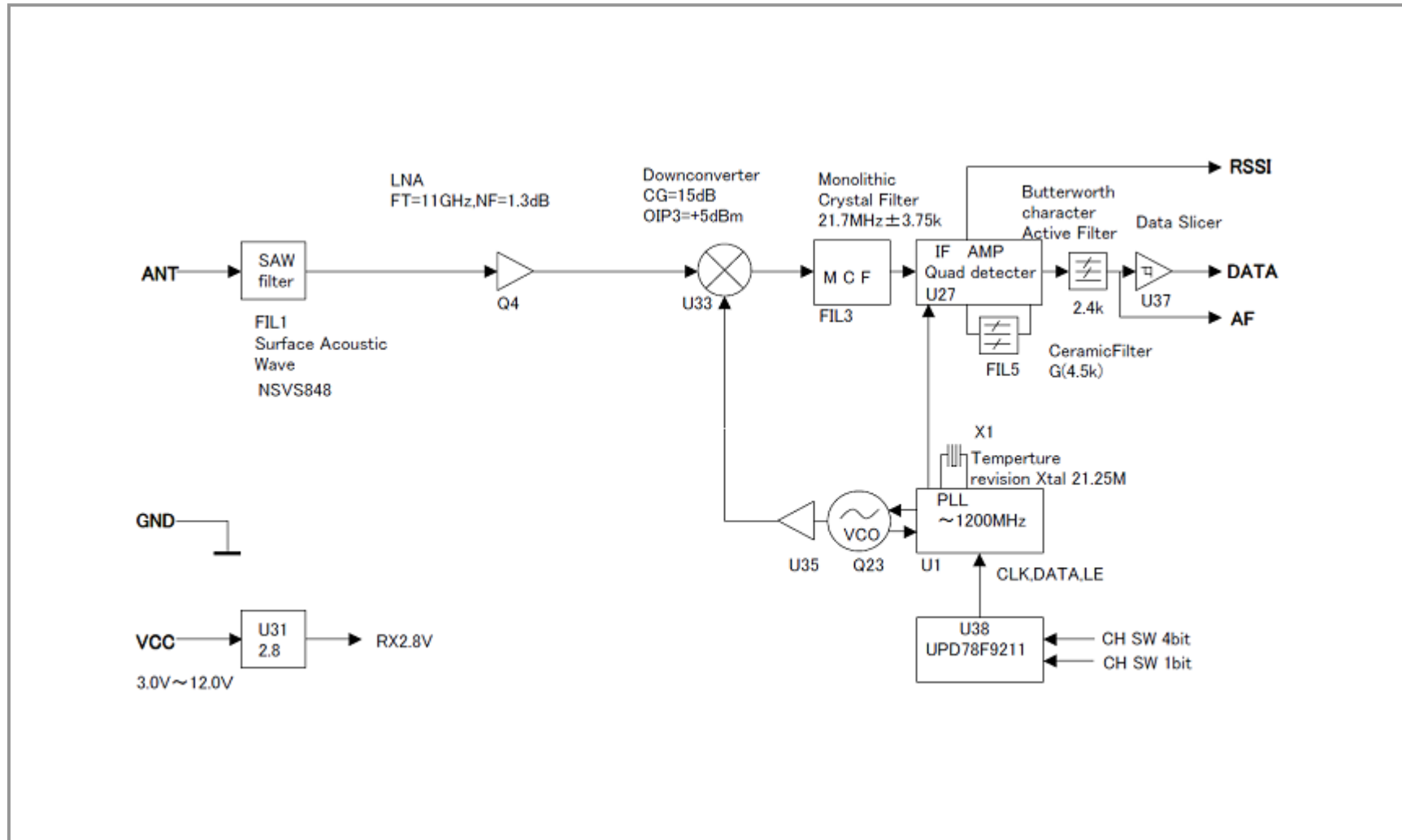

DIMENSIONS
<CDP-TX-02E-R>

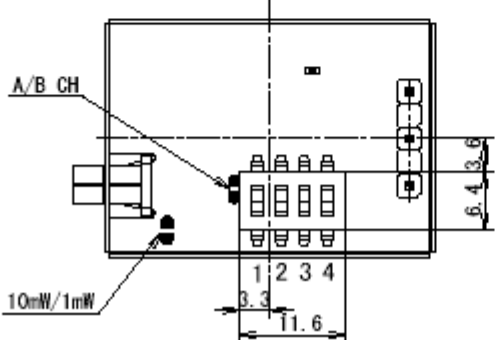
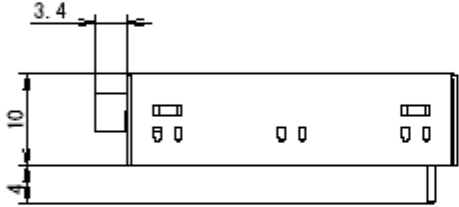
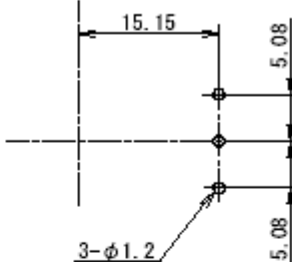
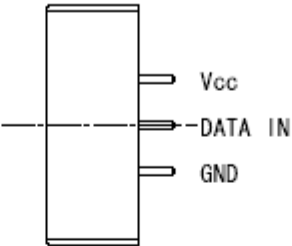
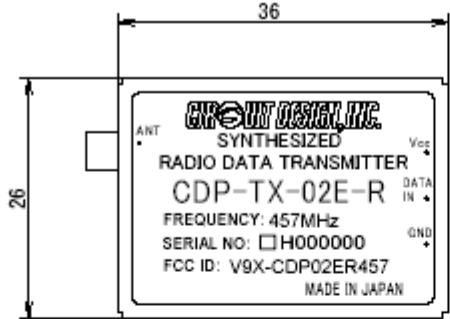
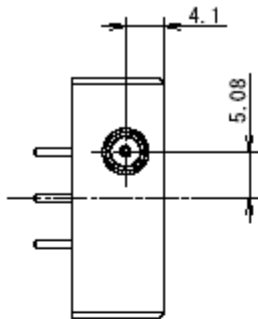

Reference hole position for PCB mounting(Top view)

<CDP-RX-02E-R>

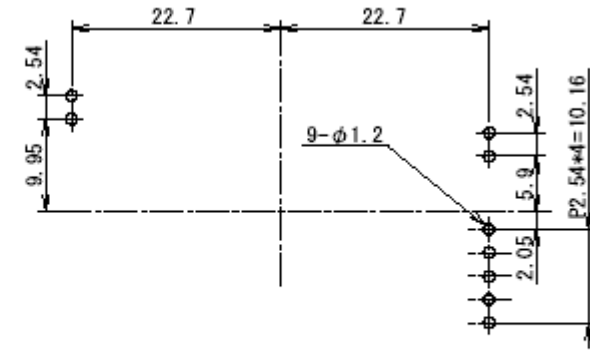
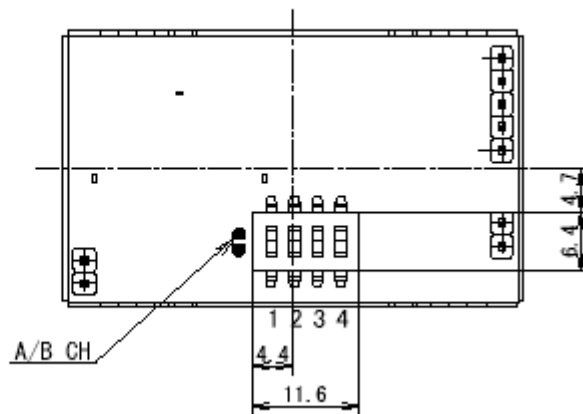
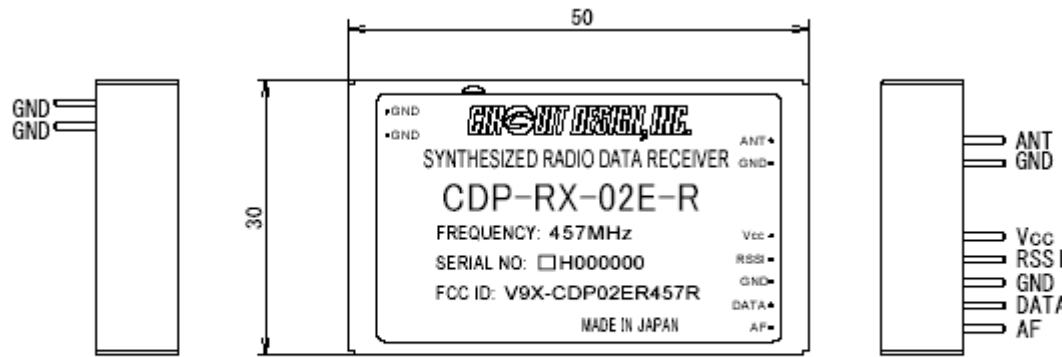

Reference hole position for PCB mounting(Top view)

TEST DATA

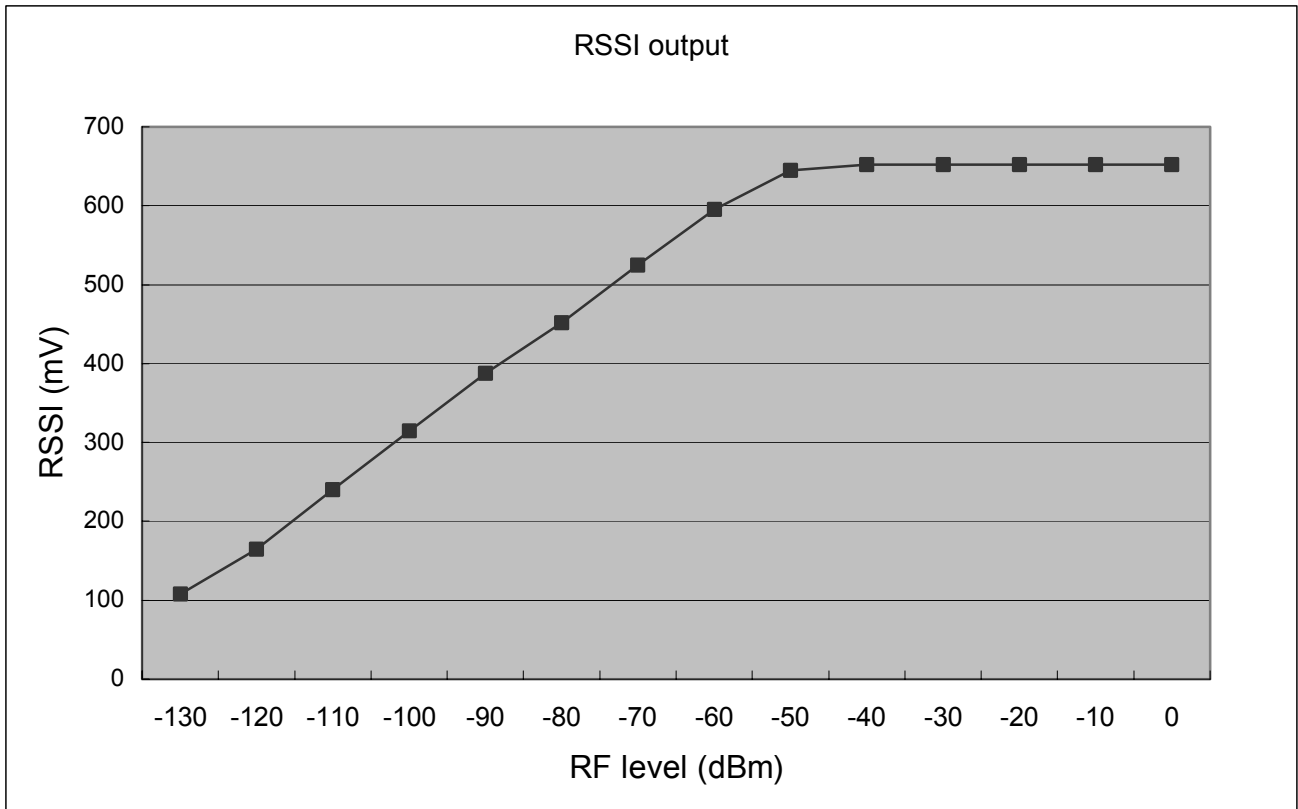

Regulatory compliance information

CDP-RX-02E-R 457 MHz

This device complies with Part 15 of the FCC Rules. Operation is subject to the following two conditions: (1) This device may not cause harmful interference, and (2) This device must accept any interference received, including interference that may cause undesired operation.

Caution:

Any changes or modifications not expressly approved by the party responsible for product compliance could void the user's authority to operate the equipment.

Caution Exposure to radio frequency radiation:

To comply with FCC RF exposure compliance requirements, a separation distance of at least 20 cm must be maintained between the antenna of this device and all persons. This device must not be co-located or operating in conjunction with any other antenna or transmitter.

Labelling:

Circuit Design transmitter module CDP-TX-02E-R 457 MHz labelled as below.

FCC ID: V9X-CDP02ER457

The proposed FCC ID label format is to be placed on the module. If FCC ID is not visible when the module is installed into the system, "Contains FCC ID: V9X-CDP02ER457" shall be placed on the outside of final host system.

Circuit Design receiver module CDP-RX-02E-R 457 MHz labelled as below.

FCC ID: V9X-CDP02ER457R

The proposed FCC ID label format is to be placed on the module. If FCC ID is not visible when the module is installed into the system, "Contains FCC ID: V9X-CDP02ER457R" shall be placed on the outside of final host system.

Cautions

- As the radio module communicates using electronic radio waves, there are cases where transmission will be temporarily cut off due to the surrounding environment and method of usage. The manufacturer is exempt from all responsibility relating to resulting harm to personnel or equipment and other secondary damage.
- Do not use the equipment within the vicinity of devices that may malfunction as a result of electronic radio waves from the radio module.
- The manufacturer is exempt from all responsibility relating to secondary damage resulting from the operation, performance and reliability of equipment connected to the radio module.
- Communication performance will be affected by the surrounding environment, so communication tests should be carried out before actual use.
- Ensure that the power supply for the radio module is within the specified rating. Short circuits and reverse connections may result in overheating and damage and must be avoided at all costs.
- Ensure that the power supply has been switched off before attempting any wiring work.
- The case is connected to the GND terminal of the internal circuit, so do not make contact between the '+' side of the power supply terminal and the case.
- When batteries are used as the power source, avoid short circuits, recharging, dismantling, and pressure. Failure to observe this caution may result in the outbreak of fire, overheating and damage to the equipment. Remove the batteries when the equipment is not to be used for a long period of time. Failure to observe this caution may result in battery leaks and damage to the equipment.
- Do not use this equipment in vehicles with the windows closed, in locations where it is subject to direct sunlight, or in locations with extremely high humidity.
- The radio module is neither waterproof nor splash proof. Ensure that it is not splashed with soot or water. Do not use the equipment if water or other foreign matter has entered the case.
- Do not drop the radio module or otherwise subject it to strong shocks.
- Do not subject the equipment to condensation (including moving it from cold locations to locations with a significant increase in temperature.)
- Do not use the equipment in locations where it is likely to be affected by acid, alkalis, organic agents or corrosive gas.
- Do not bend or break the antenna. Metallic objects placed in the vicinity of the antenna will have a great effect on communication performance. As far as possible, ensure that the equipment is placed well away from metallic objects.
- The GND for the radio module will also affect communication performance. If possible, ensure that the case GND and the circuit GND are connected to a large GND pattern.

Warnings

- Do not take a part or modify the equipment.
- Do not remove the product label (the label attached to the upper surface of the module.) Using a module from which the label has been removed is prohibited.

Circuit Design, Inc. All right reserved

No part of this document may be copied or distributed in part or in whole without the prior written consent of Circuit Design, Inc.

Customers are advised to consult with Circuit Design sales representatives before ordering.

Circuit Design, Inc. believes the furnished information is accurate and reliable. However, Circuit Design, Inc. reserves the right to make changes to this product without notice.

REVISION HISTORY

Version	Date	Description	Remark
1.1	May. 2008	CDP-TX/RX-02E-R 457MHz	The first issue

Application note (Design guide for RF transmitter and receiver)

The following problems generally apply to radio modules

Problem	Solution
Touching or moving the antenna changes its impedance, which causes variations in emission power. The variation appears as distortion in the modulating signal and causes communication errors.	Fix the position of the antenna to avoid moving it. Positioning of the antenna is an important factor in operating the radio module efficiently.
If a change in the circuit length occurs due to the on/off of switch etc. in the electronic circuit connected to the radio module in the system in which the radio module is integrated, the high frequency electric potential can vary, disturbing the modulating signal, leading to communication errors.	Add bypass capacitors of 100 to 470 pF in the immediate vicinity of the switches. Make the area beneath the radio module a ground pattern, utilizing part of the shield.
If the power line and/or the signal input line are long the printed line can be subject to high frequency noise. This noise may cause communication errors.	Block high frequency elements by adding a choke coil to each line.
Circuit Design's receivers are designed to be vibration resistant. However there is a limit to the amount of shock and vibration the module can sustain due to its construction.	In order to fix the receiver to the PCB strongly, solder the case to the PCB. When using a radio receiver where vibration is always present, use a shock absorber or fix the PCB at the vicinity of the four corners of the receiver module in addition to fixing the four corners of the PCB on which the radio module is mounted.
Circuit Design's receivers are designed for high sensitivity. They will obtain radio signals over long distances. On the other hand, the receiver is sensitive to noise from the microcomputer and surrounding digital circuits due to its high sensitivity.	Make the area beneath the radio module a ground pattern, utilizing part of the shield. Block high frequency elements by adding a choke coil to each line.

For stable operation, it is recommended to solder the shield case to PCB wide plane GND



● Soldering point

A PCB example built for CDP-TX-02E-R taking into consideration the above points is shown below.
Model No. RPB-T02N-1

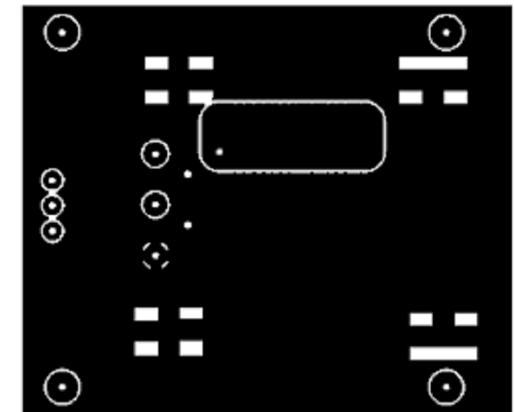
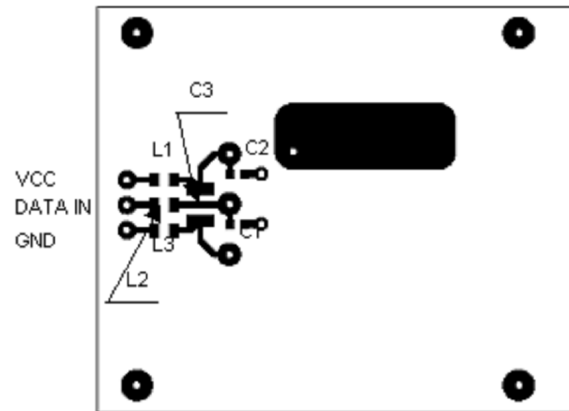
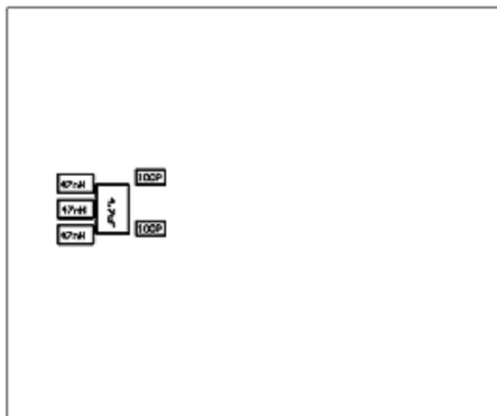
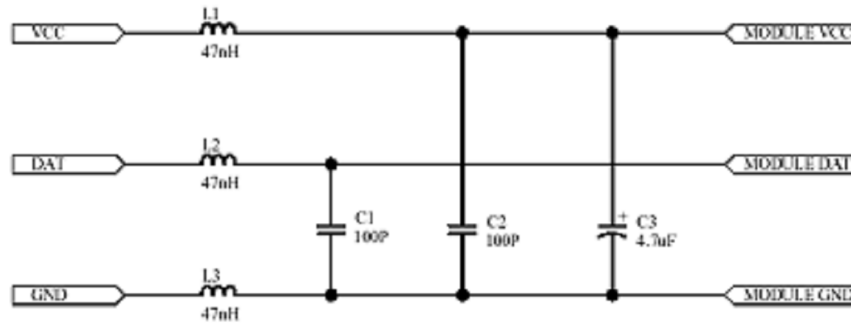

Circuit Design, Inc. All rights reserved.

No part of this document may be copied or distributed in part or in whole without the prior written consent of Circuit Design, Inc.