



USERS MANUAL

Melody Digital Audio Monitor w/ Talk-to-Baby Intercom



www.mylevana.com

Model #: LV-TW200



PRODUCT WARRANTY INFORMATION

Please visit our web site at www.myLEVANA.com for information about your product's warranty

We take quality very seriously. This is why all of our products come with a one year warranty from the original purchase date against defects in workmanship and materials. If you have warranty or support issues please contact us using any of the following methods:

Phone: 1.866.946.7828

Fax: 1.888.771.1701

Web: www.myLEVANA.com

LEVANA Canada

4080 Montrose Road
Niagara Falls, ON
Canada, L2H 1J9

LEVANA USA

60 Industrial Parkway #Z64
Cheektowaga NY 14227
USA 14305

Warranty Terms

1. LEVANA products are guaranteed for a period of one year from the date of purchase against defects in workmanship and materials. This warranty is limited to the repair, replacement or refund of the purchase price at LEVANA's option.
2. This warranty becomes void if the product shows evidence of having been misused, mishandled or tampered with contrary to the applicable instruction manual.
3. Routine cleaning, normal cosmetic and mechanical wear and tear are not covered under the terms of this warranty.
4. The warranty expressly provided for herein is the sole warranty provided in connection with the product itself and no other warranty, expressed or implied is provided. LEVANA assumes no responsibilities for any other claims not specifically mentioned in this warranty.
5. This warranty does not cover the shipping cost, insurance or any other incidental charges.
6. You **MUST** call LEVANA before sending any product back for repair. You will be sent a Return Authorization form with return instructions. When returning the product for warranty service, please pack it carefully in the original box with all supplied accessories, and enclose your original receipt or copy, and a brief explanation of the problem (include RA #).
7. This warranty is valid only in Canada and the continental U.S.
8. This warranty cannot be re-issued.



TABLE OF CONTENTS



PRODUCT WARRANTY INFORMATION	2
TABLE OF CONTENTS	3
WHAT'S INCLUDED	4
FEATURES	4
BUTTONS AND CONNECTIONS - PARENT UNIT	6
BUTTONS AND CONNECTIONS - BABY UNIT	8
GETTING STARTED	10
ATTACH POWER TO THE BABY UNIT USING THE AC ADAPTER	10
INSTALLING ALKALINE BATTERIES	10
INSTALLING THE RECHARGEABLE BATTERY IN THE PARENT UNIT	10
SWITCHING THE UNITS ON AND OFF	10
OPERATION - PARENT UNIT	11
TURNING THE NIGHT LIGHT ON AND OFF	11
LULLABY SETTINGS	11
SENSITIVITY SETTINGS	11
SOUND ALERT SETTINGS	12
SETTING THE TEMPERATURE RANGE	12
SETTING THE TEMPERATURE ALERT AND VOLUME	12
SETTING THE TEMPERATURE TYPE	13
CLOCK SETTINGS	13
SETTING THE FEED TIME	13
SETTING THE INTERVAL TIME	13
SETTING THE FEED TIME ALARM ON OR OFF	13
TALK TO BABY FUNCTION	14
LED FLASHLIGHT	14
VOLUME	14
ENERGY SAVE SWITCH	14
OPERATION - BABY UNIT	14
PARENT UNIT PAGE BUTTON	14
LULLABY SELECTION BUTTON	15
PLAYING LULLABIES	15
NIGHT LIGHT BUTTON	15
PAIRING THE DEVICES	15
TROUBLESHOOTING	16
SPECIFICATIONS	17
FCC APPROVED	18
SAFETY INSTRUCTIONS	18



WHAT'S INCLUDED



Parent Unit

- **Recharging Base**
- **2 Power Adapters**
- **User Manual**



Baby Unit

- **1 Year Warranty**
- **24/7 Lifetime Live Customer Support**

FEATURES

Superior Digital Wireless Technology

Feel free to take the monitor with you around the house and even outside! Levana's Digital Technology ensures that you will always hear clearly and signals remain strong up to 2000 feet away.

Soothe Your Child with the Talk-to-Baby Intercom

Comfort your baby from a distance using the talk-to-baby intercom function. You can hear and talk to your little one with the press of a button.

Temperature Monitoring to Ensure Safety

Did you accidentally leave the baby's room window open? Many studies indicate that your baby's room should be between 61-68° F (16-20° C). You can monitor the temperature in your baby's room and know that they are always safe and comfortable.

Comforting Lullabies

The baby unit is programmed with three well-known lullabies to help soothe your child to sleep.

Programmable Feeding Timer

Program the timer according to your baby's feeding schedule as a reminder of feeding time.



FEATURES



Soothing Night light

The baby unit has a gentle night light that glows a calming tangerine. You can turn it on manually, set it to automatic which will turn on whenever your child becomes restless and makes noise, or control it by remote control from another room.

Rechargeable Monitor for Busy Parents

Simply place the parent unit onto the charging base, and enjoy over eight hours of continuous audio. The baby unit can be powered by 3 AA batteries (not included) or the included power adapter.

Built-in LED Flashlight

Built-in LED flashlight on parent unit to help you navigate around your child's room in the dark without interrupting sleep.

Energy Saving ECO Mode

Customize your wireless range to fit your monitoring needs. Adjust to ECO mode to conserve energy or LONG mode to monitor from up to 2000 ft away!

VOX

Voice activated technology helps conserve battery life by putting the system into hibernation mode when sounds are not detected.

Out of Range Warning

An audible alert will let you know if your unit is too far from the baby's unit and connectivity has been lost.

LED Volume Levels

Monitor your baby's audible cries in silence. LEDs accurately indicate the strength of your baby's cries.

Battery Low Warnings

On screen display shows your current battery level and indicates battery low warning.

Integrated Belt Clip & Wall Mount

The integrated belt clip and wall mount on the parent unit is both durable and functional and adapts to your monitoring needs.

24/7 Lifetime Live Customer Support

Assistance is available whenever you need it. Our customer support team can be reached by phone 24/7, email or live web chat services so that you will always have access to an expert.





BUTTONS AND CONNECTIONS - PARENT UNIT

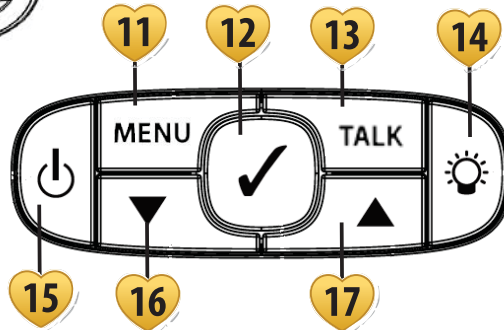
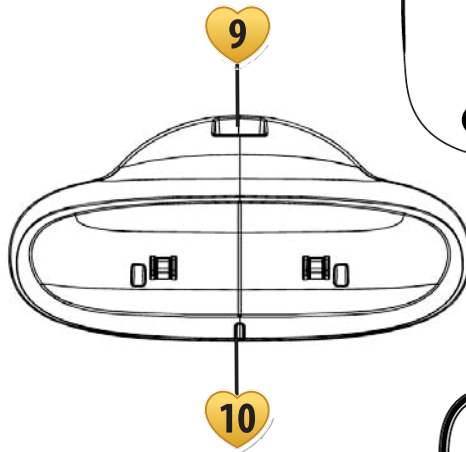
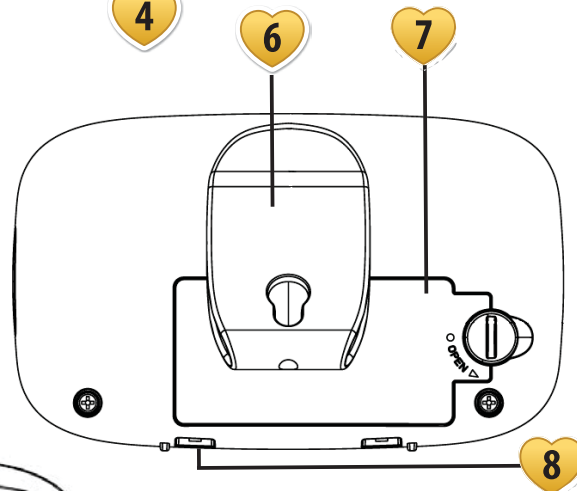
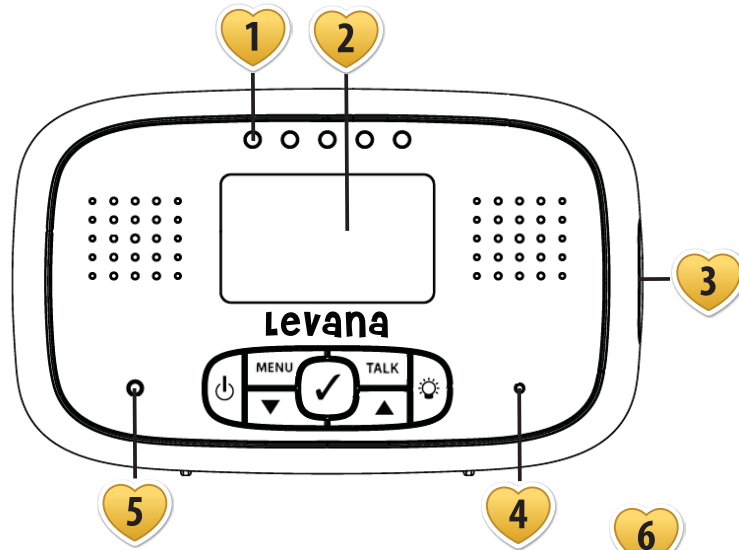



BUTTONS AND CONNECTIONS - DESCRIPTIONS



Front of Unit

1. **Volume Indication LEDs** - Indicates the level of volume being heard in baby's room
2. **LCD Screen** - Displays the temperature and current settings
3. **LED Flashlight** - A LED flashlight to help you find things in the dark
4. **Microphone** - Speak into the microphone while holding the talk back button to talk to your baby
5. **Link LED** - Solid when there is a link established with the baby unit

Back of Unit

6. **Belt Clip/Support Stand** - Twist up for belt loop, or twist down for a support stand
7. **Battery Cover** - Turn lock 90 degrees to lock or unlock the battery cover
8. **Charging Points** - Connects to charging points to recharge the battery

Charging Base

9. **AC Power Input** - Plug the AC adapter in here
10. **Charging Indicator** - Indicates that the parent unit is charging

Parent Unit Button Panel

11. **Menu Button** - Press to access parent unit menu, where you can turn ON and OFF features and adjust settings
12. **Select Button** - Press to select an option
13. **Talk Button** - Press to talk back to your baby through the baby unit's speaker
14. **Flashlight Button** - Press and hold to turn on the flashlight on the parent unit
15. **Power Button** - Press to turn unit ON or OFF
16. **Volume Down Button** - Press to decrease the volume or move to the previous menu
17. **Volume Up Button** - Press to increase the volume or move to the next menu





BUTTONS AND CONNECTIONS - BABY UNIT

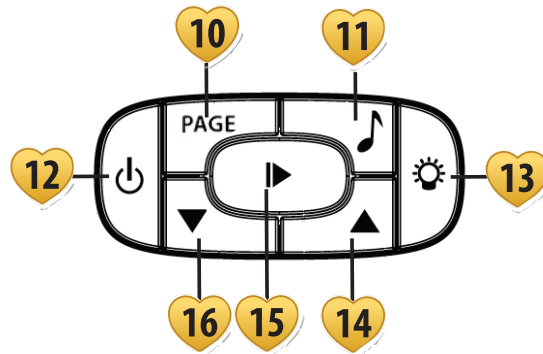
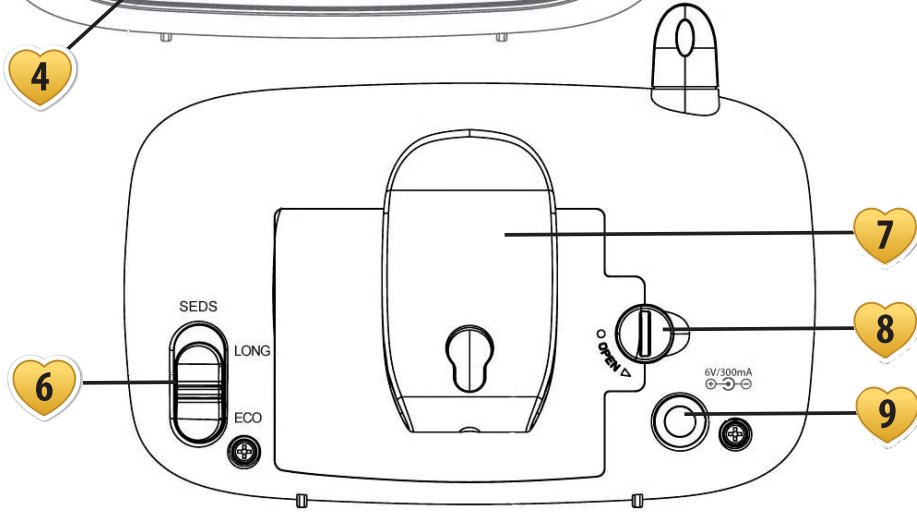
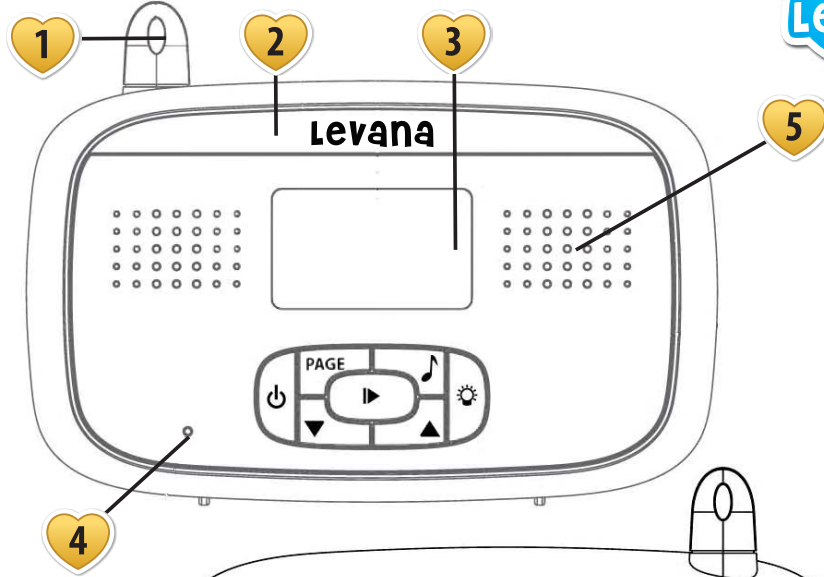



BUTTONS AND CONNECTIONS - DESCRIPTIONS



Front of Unit

- | | |
|-------------------------|--|
| 1. Antenna - | Transmits and receives signals with the parent unit |
| 2. Night Light - | Sooth baby to sleep with a calming night light |
| 3. LCD Screen - | Displays the temperature and current settings |
| 4. Microphone - | Hear every sound your baby makes with the internal microphone |
| 5. Speaker - | When you talk back to baby your voice will be projected through this speaker |

Back of Unit

- | | |
|-------------------------------------|---|
| 6. Energy Save Switch - | Reduce range when not necessary and save energy |
| 7. Belt Clip/Support Stand - | Twist up for belt loop, or twist down for a support stand |
| 8. Battery Cover - | Turn lock 90 degrees to lock or unlock the battery cover |
| 9. AC Power Input - | Plug the AC adapter in here |

Baby Unit Button Panel

- | | |
|---------------------------------------|-------------------------------------|
| 10. Page Button - | Press to call parent unit |
| 11. Lullaby button - | Press to change lullaby song |
| 12. Power Button - | Press to turn unit ON or OFF |
| 13. Night Light Button - | Press to turn night light ON or OFF |
| 14. Volume Up Button - | Press to increase volume |
| 15. Play/Stop Lullaby Button - | Press to play or stop lullabies |
| 16. Volume Down Button - | Press to decrease volume |

GETTING STARTED



Attach Power to the Baby Unit Using the AC adapter

1. Plug one end of the included power adapter into any available wall outlet.
2. Plug the small end of the power adapter into the DC jack on the back of the baby monitor.

Installing Batteries

1. Use a small flat head screwdriver to unlock the battery cover on the back of the baby unit, taking care not to screw past the 'open' point.
2. Remove the cover and install 3 AA batteries.
3. Replace the battery cover and lock the compartment.

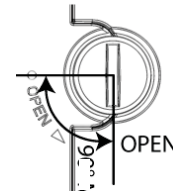

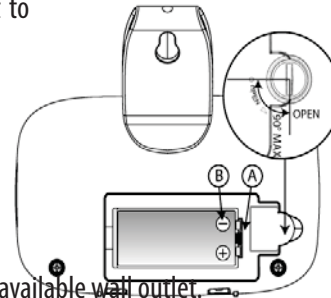

Installing the Rechargeable Battery in the Parent Unit

1. Use a small flat head screwdriver to unlock the battery cover on the back of the baby unit, taking care not to screw past the 'open' point.
2. Remove the cover and install the battery pack in the compartment, ensure it fits into the corresponding recess points. Follow the polarity instructions on the diagram to the right.
3. Replace the battery cover and lock the compartment
4. Plug one end of the included power adapter into any available wall outlet.
5. Plug the small end of the power adapter into the DC jack on the back of the recharging base, place the parent unit in the base to charge.



Switching the Units ON and OFF



1. Press the power button  on the parent unit, the LCD screen and the sound indication LED's on the front of the unit will light up during start up.
2. Press the power button  on the baby unit, the LCD screen and night light will light up during start up.
3. The parent and baby units will automatically pair. If the units do not pair automatically, see Pairing the Devices on page 15.
4. To power OFF the units, press and hold the power button  on the parent and baby units until the LCD screen goes blank.

OPERATION - PARENT UNIT



Many of the monitor features are set and personalized through the main menu of the parent unit. The select button is used to select an option or menu, the menu button is used to exit and return to the previous menu.

Turning the Night Light On and Off





1. Press the menu button **MENU**, 'night light' will be displayed. Press the select button  to enter the night light menu.
2. The menu will display your option for the night light, either to turn it On or Off, depending on its current status. Press the select button  to choose the setting.
3. Repeat steps 1 and 2 to turn the night light on or off again.







Note: You can also turn the night light on or off using the night light button  on the front of the baby unit.

Lullaby Settings

There are 3 lullabies you can play on the baby unit.

1. Press the menu button **MENU**, and then the down button  until 'Lullaby' is displayed, press the select button  to enter the menu.
2. Press the down button  to scroll through your options in the lullaby section, either play/stop the lullaby, or scroll to 'select new' and press the select button  to choose a particular lullaby. Your choices are Twinkle Twinkle Little Star, Minuet in G, Londonderry, or play all.

Sensitivity Settings

1. Press the menu button **MENU**, and then the down button  until 'Sensitivity' is displayed, press the select button  to enter the menu.
2. Here you have the option of setting the sound sensitivity of the monitor, one bar being the least sensitive and 5 bars being the most sensitive.
3. Use the down  and up  buttons to set the sensitivity and press the select button  to save your preference.



OPERATION - PARENT UNIT



Sound Alert Settings

When the volume on the parent unit is set to Off, the Sound Alert menu lets you choose to have an audible alert when noise in the baby's room becomes loud enough to reach the red LED indicators.

1. Press the menu button **MENU**, and then the down button ▼ until 'Sound Alert' is displayed, press the select button ✓ to enter the menu.
2. The menu will display your option for the sound alert, either to turn it On or Off, depending on its current status. Press select ✓ to adjust the setting.
3. To adjust the volume of the alert, press the down button ▼ until 'Volume' is displayed and press select ✓ to enter that menu.
4. Use the up ▲ and down ▼ buttons to adjust the volume, and the select button ✓ to save your settings.

Setting the Temperature Range

1. Press the menu button **MENU**, and then the down button ▼ until 'Temperature' is displayed, press the select button ✓ to enter the menu.
2. The menu will display 'Set Range', press select ✓ to enter the set range menu.
3. Enter the high temperature limit first using the up ▲ and down ▼ buttons, press select ✓ to save.
4. Next, enter the low temperature limit using the up ▲ and down ▼ buttons, press select ✓ to save and return to the Temperature Menu.

Setting the Temperature Alert and Volume

1. From the temperature menu, press the down button ▼ until 'Temp Alert' is displayed, press select ✓ to enter this menu.
2. The menu will display your option for the temperature alert, either to turn it On or Off, depending on its current status. Press select ✓ to choose the setting.
3. To adjust the volume of the alert, press the down button ▼ until 'Volume' is displayed and press select ✓ to enter that menu.
4. Use the up ▲ and down ▼ buttons to adjust the volume, and the select button ✓ to save your settings.





OPERATION - PARENT UNIT



Setting the Temperature Type

1. From the temperature menu, press the down button ▼ until 'Degree C' or 'Degree F' is displayed.
2. Depending on the monitors current status, pressing select ✓ will change the monitor to show the temperature in the format displayed.

Clock Settings

1. Press the menu button **MENU**, and then the down button ▼ until 'Clock' is displayed, press the select button ✓ to enter the menu.
2. The menu will display 'Set Time', press select ✓ to enter the proper time and date.
3. Use the up ▲ and down ▼ buttons to adjust the value, and ✓ select to save, in this order. (Year, month, day, hour, minute)
4. Press the down button ▼ until 'Hour Format' is displayed. Pressing select ✓ will change the hour format from 12 hour to 24 hour time.

Setting the Feed time

1. Press the menu button **MENU**, and then the down button ▼ until 'Feed Time' is displayed, press the select button ✓ to enter the menu.
2. The menu will display 'Set Time', press select ✓ to set the first feeding time.
3. Use the up ▲ and down ▼ buttons to set the time, hours and then minutes, press select ✓ to save your settings.

Setting the Interval Time

1. From the Feed Time menu, press the down button ▼ until 'Set Interval' is displayed, press select ✓ to enter this menu.
2. Press the down ▼ and up ▲ buttons to set the number of interval hours and minutes, and then press select ✓ to save your settings.

Setting the Feed Time Alarm On or Off

1. From the Feed Time menu, press the down button ▼ until 'Alarm' is displayed, press select ✓ to enter this menu.
2. The menu will display your option for the Interval Alarm, either to turn it On or Off, depending on its current status. Press select ✓ to adjust the setting.





OPERATION - PARENT UNIT





Talk to Baby Function

1. On the front of the parent unit, press and hold the Talk button. **TALK**
2. Speak directly into the front of the parent unit, where a microphone is located.
3. When you are finished talking, simply release the Talk button. **TALK**

LED Flashlight

1. Press and hold the flashlight button  on the front of the parent unit, the LED light on the right side of the unit will light up.
2. To turn off the LED flashlight, release the flashlight button .

Volume

1. Press the up  and down  buttons on the front of the parent unit to adjust the volume. One bar is the lowest volume setting, five bars is the highest setting.



Energy Save Switch

This monitor has two range settings, long distance and eco, which would use less battery power when longer distance transmission is not required.

1. Flip the SEDS switch on the back of the baby unit up to set the system to long distance transmission mode.
2. Flip the SEDS switch to the bottom, to ECO mode when longer distance transmission is not required, or longer battery life is needed.

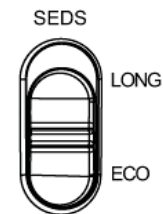

OPERATION - BABY UNIT

Parent Unit Page Button

If you cannot find the parent unit and it is still powered on, you can press the page button on the baby unit that sounds an alarm to assist you in finding it.

1. Press the Page button **PAGE** on the front of the baby unit.
2. The parent unit will sound a loud alarm.
3. Once you find the parent unit, you can turn off the alarm by pressing the Page button **PAGE** on the baby unit or any button on the parent unit.





OPERATION - BABY UNIT

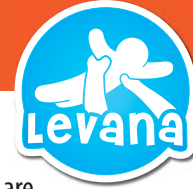



Lullaby Selection Button

You can also choose and play the lullabies from the baby unit. Your choices are Twinkle Twinkle Little Star, Minuet in G, Londonderry, or Play All.

1. Press the Lullaby button  on the front of the baby unit to select one of the three available lullabies, or the play all setting. The current setting will be displayed on the LCD screen.

Playing Lullabies

1. Press the Play/Stop Lullaby button  on the front of the baby unit to start playing the chosen lullaby.
2. Press the Play/Stop Lullaby button  once more to stop playing the lullaby.







Night Light Button

1. Press the Night Light button  on the front of the baby unit to turn on the night light, press the button once more to turn the night light off.

PAIRING THE DEVICES

Occasionally it may be necessary to pair the devices if they do not connect automatically.

To Pair the Devices:

1. Unplug power from the baby unit and remove the battery from the parent unit.
2. Press and hold the On/Off button  of the baby unit and plug the power adapter in, the baby unit will start up in pair mode. Release the On/Off button  and the night light will flash for 60 seconds.
3. Press and hold the On/Off button  of the parent unit and install the rechargeable battery, the parent unit will start up with its two red LEDs blinking. Release the On/Off button  of the parent unit.
4. Once the two units have paired the baby unit's night light and parent unit's LED lights will stop blinking. The monitors will enter normal operation.





TROUBLESHOOTING



Problem	Possible Cause
No reception or transmission on the parent unit	<ul style="list-style-type: none"> The unit has not been switched on The AC/DC adapter has not been connected The rechargeable battery pack is not installed properly Battery power is too low. Recharge the battery, put it back on the charging base The baby unit may not be transmitting The units are not paired
No reception or transmission on the baby unit	<ul style="list-style-type: none"> The unit has not been switched on The AC/DC adapter has not been connected The volume level is at the lowest setting. Adjust the volume switch The units are not paired
Feedback (screeching, static)	<ul style="list-style-type: none"> The baby unit and parent unit are too close together The volume on the parent unit is set too high
Reception Interference (static)	<ul style="list-style-type: none"> The baby unit and parent unit are too far apart The battery power is too low Other electronic devices are interfering with the signal The baby unit and parent unit are placed near too many metal objects
The rechargeable battery in the parent unit will not charge	<ul style="list-style-type: none"> The power adapters are not connected The charging contacts are dirty The parent unit is not docked properly





SPECIFICATIONS



Parent Unit Specifications

Power Input	6V ~ 300mA
Wireless Frequency	2.4 GHz Digital Wireless
Range.....	1000ft (High Power) - 500ft (Low Power)
Battery Operable.....	Yes - Rechargeable Battery Included
Battery Life	8 Hours
Recharge Time	4 Hours
Screen	1.5" Backlit LCD
Talk back	Yes
Microphone.....	Yes
VOX Activation	Yes
Lullabies.....	Yes
Languages Supported	3 - English, French, Spanish
Out of Range Warning.....	Yes
Temperature Display	°C or °F
Operating Temperature	15 °C to 35 °C (59 °F to 95 °F)
Dimensions	4.6" x 2.5" x 2.8"
Weight	0.2 lbs

Baby Unit Specifications

Power Input	6V ~ 300mA
Wireless Frequency	2.4 GHz Digital Wireless
Range.....	1000ft (High Power) - 500ft (Low Power)
Battery Operable.....	3 AA Alkaline Batteries
Battery Life	4 Hours
Screen Type	1.5" Backlit LCD
Battery Low Alert.....	Yes - Optional Audible Alert
Night Light.....	Yes
Operating Temperatures.....	15 °C to 35 °C (59 °F to 95 °F)
Dimensions	5.4" x 2.4" x 4"
Weight	0.31 lbs



FCC APPROVED

This equipment complies with FCC radiation exposure limits set forth for uncontrolled environment. Devices that allow transmissions while worn next to the body using an accessory are tested with the device and associated accessories in all applicable orientations, at the minimum separation distance, using a flat phantom, and 1 g SAR < 1.6 W/kg. This transmitter must not be co-located or operating in conjunction with any other antenna or transmitter.

Any Changes or modifications not expressly approved by the party responsible or compliance could void the user's authority to operate the equipment.

FCC Label Compliance Statement

This device complies with Part 15 of the FCC Rules. Operation is subject to the following two conditions:

- (1) This device may not cause harmful interference
- (2) This device must accept any interference received, including interference that may cause undesired operation

The manufacturer is not responsible for any radio or TV interference caused by unauthorized modifications to this equipment. Such modifications could void the user's authority to operate the equipment.

SAFETY INSTRUCTIONS

Read and Keep Instructions: All the safety and operating instructions should be read before the video baby monitor is operated.

Water and Moisture: This product is designed for indoor use only. The unit should not be exposed to rain, moisture, dripping or splashing. No objects filled with liquid should be placed on top of, or beside the product, such as a glass or vase. This item should not be used near water.

Non-Use Periods: Always unplug the AC adapters from the wall outlets during long periods of non-use.





SAFETY INSTRUCTIONS



Ventilation: This baby monitor should not be used on a bed, sofa, rug or similar surface that may block the ventilation openings, or be placed in an enclosed area, such as a bookcase or drawer that may impede air flow.

Keep Away from Sources of Heat: This unit should not be exposed to direct heat sources such as a candle, fireplace, radiator, heat register, stove or other appliance that emits heat. The unit should not be left in direct sunlight.

Power Source: This unit should only be used with the AC power adapters included in this package (rated 6V 800mA)

Damage Requiring Service: This unit should be serviced by qualified personnel only when:

- a. Objects have fallen or liquid has been spilled into the product
- b. The units have been exposed to rain
- c. The units do not appear to operate normally or exhibits a distinct change in performance
- d. The units have been dropped or the enclosure damaged

Caution: This product cannot replace responsible adult supervision of a child. You should personally check your child's activity at regular intervals.

STATEMENT ON REGULATION

These units are designed to provide reasonable protection against harmful interference in a residential installation. This equipment generates, uses and can radiate radio frequency energy and if not installed and used in accordance with the instructions, may cause harmful interference to radio communications. However, there is no guarantee that interference will not occur in a particular installation. If this equipment does cause harmful interference to radio or television reception, which can be determined by turning the equipment off and on, the user is encouraged to try to correct the interference by one or more of the following measures:

- Reorient or relocate the receiving antenna
- Increase the separation between the equipment and receiver
- Connect the equipment into an outlet on a circuit different from that to which the receiver is connected
- Consult the dealer or an experienced radio/TV technician for help

Operation with non-approved equipment or unshielded cables is likely to result in interference to radio or TV reception. The user is cautioned that changes and modifications made to the equipment without the approval of manufacturer could void the user's authority to operate this equipment.



**please visit
www.mylevana.com for...**

- ♥ **warranty information**
- ♥ **product support**
- ♥ **contact information**
- ♥ **user manual downloads**
- ♥ **and much more!**

