



***EFT DRAFT - CISCO CONFIDENTIAL***



## **Cisco Unified IP Phone User Guide for Cisco Unified Communications Manager 8.5 (SCCP and SIP)**

For Cisco Unified IP Phone 8941 and 8945

### **Americas Headquarters**

Cisco Systems, Inc.  
170 West Tasman Drive  
San Jose, CA 95134-1706  
USA  
<http://www.cisco.com>  
Tel: 408 526-4000  
800 553-NETS (6387)  
Fax: 408 527-0883



# Contents

---

## **Your Phone 1**

Cisco Unified IP Phone 8941	1
Phone Connections	1
Footstand	3
Buttons and Hardware	4
Phone Screen	7
Phone with a Single Line	7
Phone with Multiple Lines	8
Power-Save Mode	11
Handset Rest	11
Cisco Unified IP Phone 8945	12
Phone Connections	12
Bluetooth	14
Footstand	15
Buttons and Hardware	16
Phone Screen	19
Phone with a Single Line	19
Phone with Multiple Lines	20
Power-Save Mode	23
Handset Rest	23

## **Applications 25**

Phone Applications	25
Call History	25
View Call History	26
View Call Record Details	26
Filter Call History	26
Dial From Call History	27
Edit Number From Call History	27

- Clear Call History **27**
- Delete Call Record From Call History **28**

**Preferences 28**

- Ringtones **28**
- Brightness **28**
- Camera Settings **29**
- Bluetooth **30**

**Accessories 30**

- View Accessories List **30**
- View Accessory Details **30**
- Add Bluetooth Accessory **31**
- Delete Bluetooth Accessory **31**
- Connect Bluetooth Accessory **32**
- Disconnect Bluetooth Accessory **32**

**Administrator Settings 32**

**Phone Information 32**

- View Phone Information **33**

**Contacts 35**

**Phone Contacts 35**

- Corporate Directory **35**
  - Search for and Dial a Contact **35**
  - Search for and Dial a Contact While on a Call **36**

**Personal Directory 36**

- Personal Directory Options **36**
- Fast-Dial Codes with Personal Directory **38**

**Messages 41**

**Voice Messages 41**

- Personalize Your Voicemail **41**
- Check for Voice Messages **41**
- Listen to Voice Messages **42**

**Calling Features 43**

**Feature Buttons and Softkeys 43**

**Agent Greeting 44**

- Answer **44**
  - Answer Your Oldest Call First **45**
- Auto Answer **45**
  - Auto Answer with Your Headset **45**
  - Auto Answer with Your Speakerphone **45**
- Barge **45**
  - Add Yourself to a Call on a Shared Line **45**
- Call Back **45**
  - Set up a Call Back Notification **46**
- Call Forward All **46**
  - Forward Calls on Your Phone **47**
- Call Park **47**
  - Park and Retrieve a Call Using Park **48**
  - Park and Retrieve a Call Using Assisted Directed Call Park **48**
  - Park and Retrieve a Call Using Manual Directed Call Park **48**
- Call Pickup **49**
  - Answer a Call Using Pickup **50**
  - Answer a Call Using Group Pickup and a Group Pickup Number **50**
  - Answer a Call Using Group Pickup and a Phone Number **50**
  - Answer a Call Using Other Pickup **50**
- Call Waiting **51**
  - Respond to a Call Waiting Notification **51**
- Conference **51**
  - Add Another Party to Your Call to Create a Conference **51**
  - Join Calls Together in a Conference **52**
  - Swap Between Calls Before Completing a Conference **52**
  - View Conference Participants **52**
  - Remove Conference Participants **52**
- Divert **53**
  - Divert a Call **53**
- Do Not Disturb **53**
  - Turn DND On and Off **54**
- Extension Mobility **54**
  - Enable Extension Mobility **54**

- Fast Dial **54**
  - Place a Call with a Fast-Dial Button **55**
- Hold **55**
  - Hold and Resume a Call **55**
  - Swap Between Holding and Active Calls **55**
  - Put a Call on Hold by Answering a New Call **55**
  - Determine if a Shared Line is on Hold **56**
  - Remote Hold **56**
- Hold Reversion **56**
  - Respond to a Hold Reversion Notification **56**
- Hunt Groups **56**
  - Sign In and Out of a Hunt Group **57**
- Intercom **57**
  - Place a Dedicated Intercom Call **57**
  - Place a Dialable Intercom Call **57**
  - Receive an Intercom Call **58**
- Line Status **58**
  - Line Status Indicators **58**
- Malicious Call Identification **59**
  - Trace a Suspicious Call **59**
- Meet Me **59**
  - Host a Meet-Me Conference **59**
  - Join a Meet-Me Conference **60**
- Mobile Connect **60**
  - Turn On or Off Mobile Connect to All Your Remote Destinations From Your Desk Phone **60**
  - Switch an In-Progress Call on Your Desk Phone to a Mobile Phone **61**
  - Switch an In-Progress Call From a Mobile Phone to Your Desk Phone **61**
  - Hand Off an In-Progress Call From a Mobile Phone to Your Desk Phone **61**
- Mute **61**
  - Mute Your Phone **62**
  - Mute Your Video **62**
- On-hook Dialing **62**
  - Dial a Number On Hook **62**
- Plus Dialing **62**

Dialing an International Number	<b>63</b>
Privacy	<b>63</b>
Enable Privacy on a Shared Line	<b>63</b>
Quality Reporting Tool	<b>63</b>
Report Problems on Your Phone	<b>64</b>
Redial	<b>64</b>
Redial a Number	<b>64</b>
Secure and Nonsecure Indication Tone	<b>64</b>
Shared Lines	<b>65</b>
Silent Monitoring and Recording	<b>65</b>
Speed Dial	<b>65</b>
Place a Call with a Speed-Dial Button	<b>66</b>
Place a Call with a Speed-Dial Code	<b>66</b>
Use a Speed-Dial Code On Hook	<b>66</b>
Use a Speed-Dial Code Off Hook	<b>66</b>
Transfer	<b>66</b>
Transfer a Call to Another Number	<b>67</b>
Swap Between Calls Before Completing a Transfer	<b>67</b>
Web Dialer	<b>67</b>
Use Web Dialer with Cisco Directory	<b>67</b>
Use Web Dialer with Another Online Corporate Directory	<b>68</b>
Set Up, View, or Change Web Dialer Preferences	<b>68</b>
Sign Out of Web Dialer	<b>69</b>
<b>User Options</b>	<b>71</b>
User Options Web Pages	<b>71</b>
Sign In and Out of User Options Web Pages	<b>71</b>
Device	<b>72</b>
Select a Device From the User Options Web Pages	<b>72</b>
Customize Do Not Disturb Options	<b>72</b>
Line Settings	<b>73</b>
Set Up Call Forwarding Per Line	<b>73</b>
Change the Voice Message Indicator Setting Per Line	<b>73</b>
Change the Audible Voice Message Indicator Setting Per Line	<b>74</b>

- Change the Ring Settings Per Line **74**
- Change or Create a Line Text Label for Your Phone Display **74**
- Speed Dial on the Web **75**
  - Set Up Speed-Dial Buttons **75**
  - Set Up Speed-Dial Codes **75**
- Phone Services **75**
  - Subscribe to a Service **76**
  - Search for Services **76**
  - Change or End Services **76**
  - Change a Service Name **76**
  - Add a Service to an Available Programmable Feature Button **76**
- User Settings **77**
  - Change Your Browser Password **77**
  - Change Your PIN **77**
  - Change the Language for Your User Options Web Pages **77**
  - Change the Language for Your Phone Display **78**
- Directory **78**
- Personal Address Book **78**
  - Add a New PAB Entry **78**
  - Search for a PAB Entry **78**
  - Edit a Personal Directory Entry **79**
  - Delete a Personal Directory Entry **79**
  - Assign a Feature Button for Personal Address Book **79**
- Fast Dials **79**
  - Assign a Feature Button for Fast Dial **80**
  - Assign a Fast Dial Code to a PAB Entry **80**
  - Assign a Fast Dial Code to a Phone Number Without Using a PAB Entry **80**
  - Search for a Fast Dial Entry **80**
  - Edit a Fast Dial Phone Number **80**
    - Delete a PAB Entry **81**
  - Mobility Settings **81**
    - Add a New Remote Destination **81**
    - Create an Access List **82**
- Plugins **83**
  - Access Plugins **83**



**FAQs and Troubleshooting 85**

Frequently Asked Questions **85**

Troubleshooting Tips **87**

    Personal Directory **88**

    User Options **88**

**Product Safety, Security, Accessibility, and Related Information 91**

Safety and Performance Information **91**

    Power Outage **91**

    External Devices **91**

    Bluetooth Wireless Headset Performance **92**

FCC Compliance Statements **92**

    FCC Part 15.21 Statement **92**

    FCC RF Radiation Exposure Statement **92**

    FCC Receivers and Class B Digital Statement **93**

Cisco Product Security **93**

Accessibility Features **93**

Additional Information **94**

**Warranty 111**

Cisco One-Year Limited Hardware Warranty Terms **111**

**Index 1**



# Your Phone

---

This chapter describes the features of the Cisco Unified IP Phones 8941 and 8945.

## Cisco Unified IP Phone 8941

The Cisco Unified IP Phone 8941 provides these features:

- Phone connections
- Footstand
- Buttons and hardware
- Phone screen
- Power-save mode
- Handset rest

## Phone Connections

Your system administrator can help you connect your phone to the corporate IP telephony network.

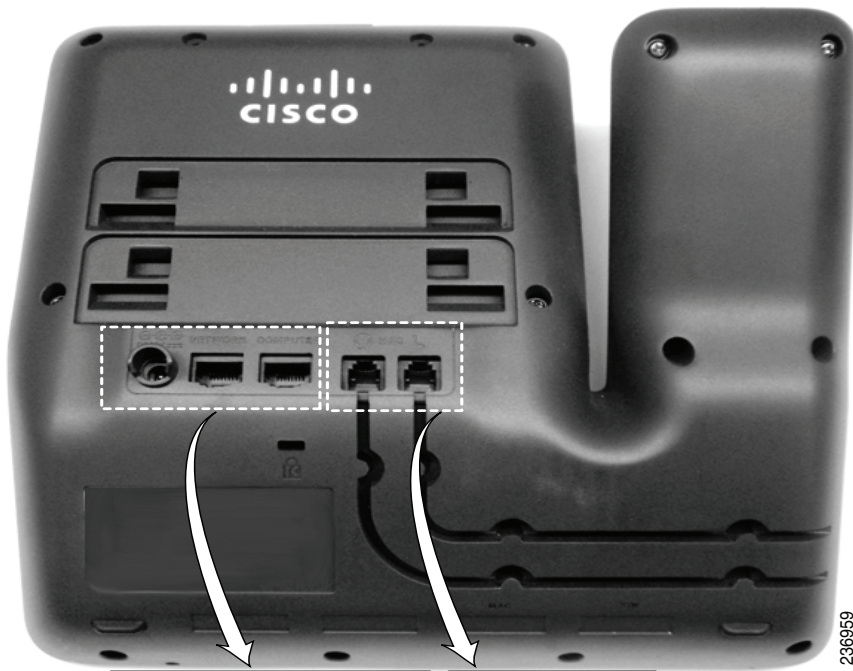

236959

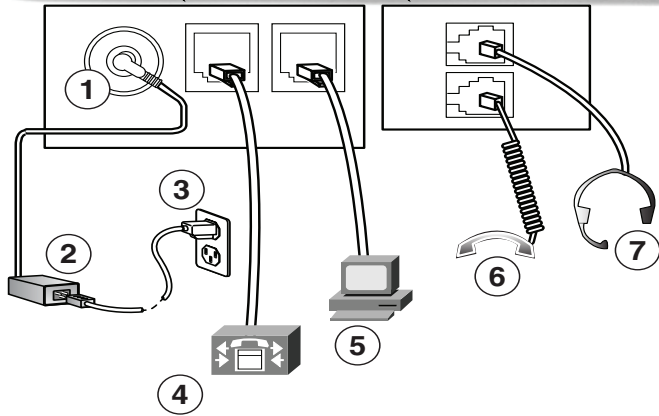

<b>1</b>	DC adapter port (DC48V)	<b>5</b>	Computer port (10/100/1000 PC) connection
<b>2</b>	AC-to-DC power supply (optional)	<b>6</b>	Handset connection
<b>3</b>	AC power wall plug (optional)	<b>7</b>	Analog headset connection (headset optional)
<b>4</b>	Network port (10/100/1000 SW) with IEEE 802.3af and 802.3at power enabled		

## Footstand

If your phone is placed on a table or desk, connect the footstand to the back of the phone.

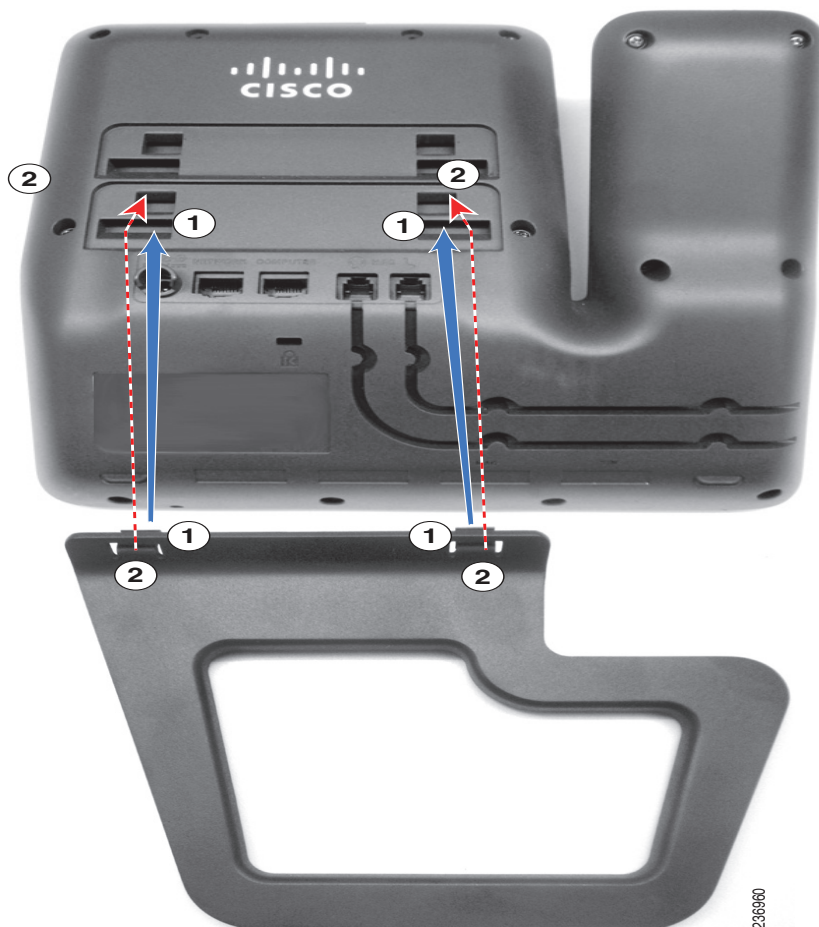

<b>1</b> Insert the curved connectors into the lower slots.	<b>2</b> Lift the footstand until the connectors snap into the upper slots.
---	---



### Note

Connecting and disconnecting the footstand may require a little more force than you expect.





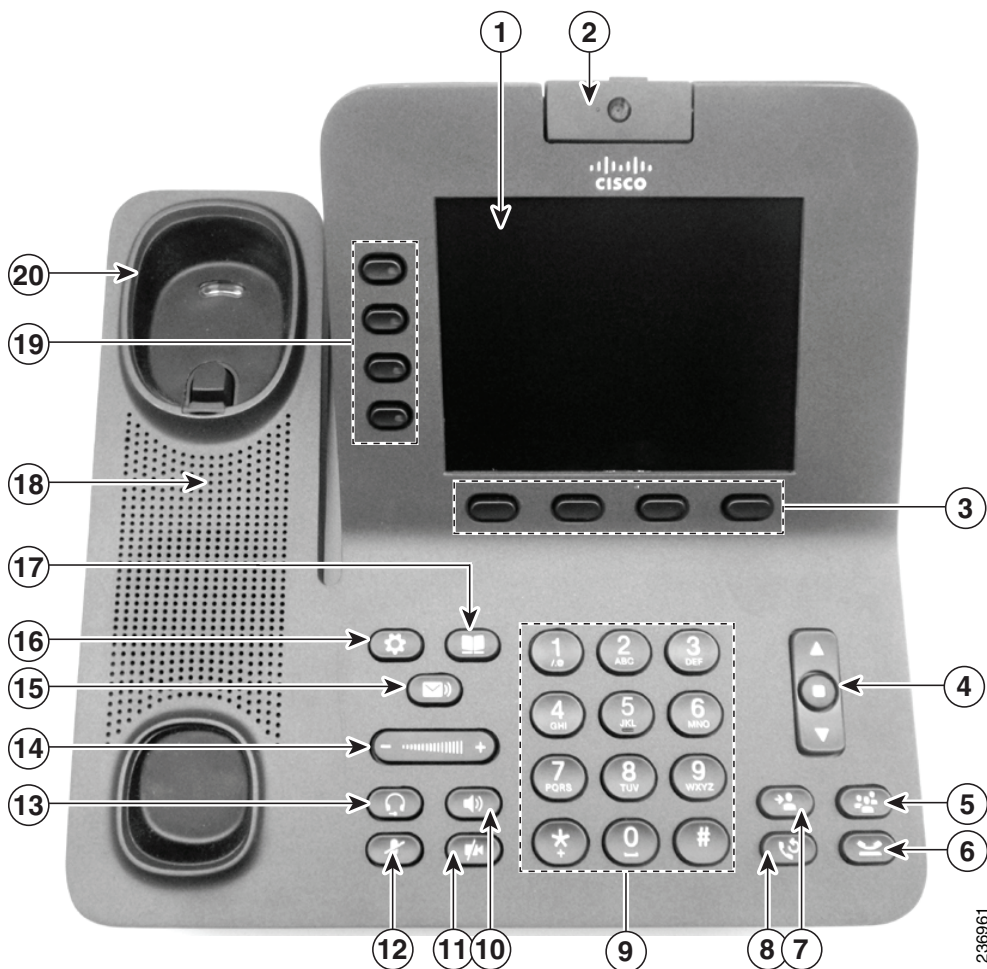





## Buttons and Hardware













Your phone provides quick access to your phone lines, features, and call sessions. The Programmable Feature buttons (left side) is used to view calls on a line or access features such as speed dial or All Calls. (These buttons are also called Line buttons.)



236961

1	Phone screen	Shows information about your phone, including directory number, call information (for example caller ID, icons for an active call or call on hold) and available softkeys.
---	--------------	--

2	Video Camera 	Connects to your Cisco Unified IP Phone and allows you to make a point-to-point video call with another Cisco Unified IP Phone.
3	Softkey buttons 	Allows you to access the softkey options (for the selected call or menu item) displayed on your phone screen.
4	Navigation pad and Select button 	<p>The two-way Navigation pad allows you to scroll through menus, highlight items, and move within a text input field.</p> <p>The Select button (center of the Navigation pad) allows you to select a highlighted item as well as wake up the phone from deep sleep mode.</p> <p>The Select button is lit (white) when the phone is in power-save mode.</p>
5	Conference button 	Creates a conference call.
6	Hold button 	Places a connected call on hold.
7	Transfer button 	Transfers a call.
8	Redial button 	Redials a call.
9	Keypad	Allows you to dial phone numbers, enter letters, and choose menu items (by entering the item number).
10	Speakerphone button 	<p>Selects the speakerphone as the default audio path and initiates a new call, picks up an incoming call, or ends a call. During a call, the button is lit green.</p> <p>The speakerphone audio path does not change until a new default audio path is selected (for example, by picking up the handset).</p> <p>If external speakers are connected, the Speakerphone button selects them as the default audio path.</p>
11	Video Mute button 	Mutes video from the phone screen during a video call.
12	Mute button 	Toggles the microphone on or off during a call. When the microphone is muted, the button is lit red.

13	Headset button 	<p>Selects the headset as the default audio path and initiates a new call, picks up an incoming call, or ends a call. During a call, the button is lit green.</p> <p>A headset icon  in the phone screen header line indicates the headset is the default audio path. This audio path does not change until a new default audio path is selected (for example, by picking up the handset).</p>
14	Volume button 	<p>Controls the handset, headset, and speakerphone volume (off hook) and the ringer volume (on hook).</p> <p>Silences the ringer on the phone if an incoming call is ringing.</p>
15	Messages button 	<p>Auto-dials your voicemail system (varies by system).</p>
16	Applications button 	<p>Opens the Applications menu. Depending on how your system administrator sets up the phone, use it to access applications such as call history, preferences, administrator settings, and phone information.</p>
17	Contacts button 	<p>Opens the Contacts menu. Depending on how your system administrator sets up the phone, use it to access personal directory or corporate directory.</p>
18	Phone Speaker 	<p>Speaker for the phone.</p>
19	Programmable feature buttons (also called Line buttons) 	<p>Each corresponds with a phone line, speed dial, and calling feature. Pressing a button for a phone line displays the active calls for that line. Color LEDs indicate the line state:</p> <ul style="list-style-type: none"> <li>• Amber —Ringing call on this line</li> <li>• Green —Active or held call on this line</li> <li>• Red —Shared line in-use remotely</li> </ul>
20	Handset rest 	<p>To rest the phone handset.</p> <p>When there is an incoming call, the LED in the handset rest flashes red. If there is a new voice message, the LED is lit red.</p>



## Phone Screen

The way that your system administrator sets up your phone determines what is displayed on your phone screen.

### Phone with a Single Line

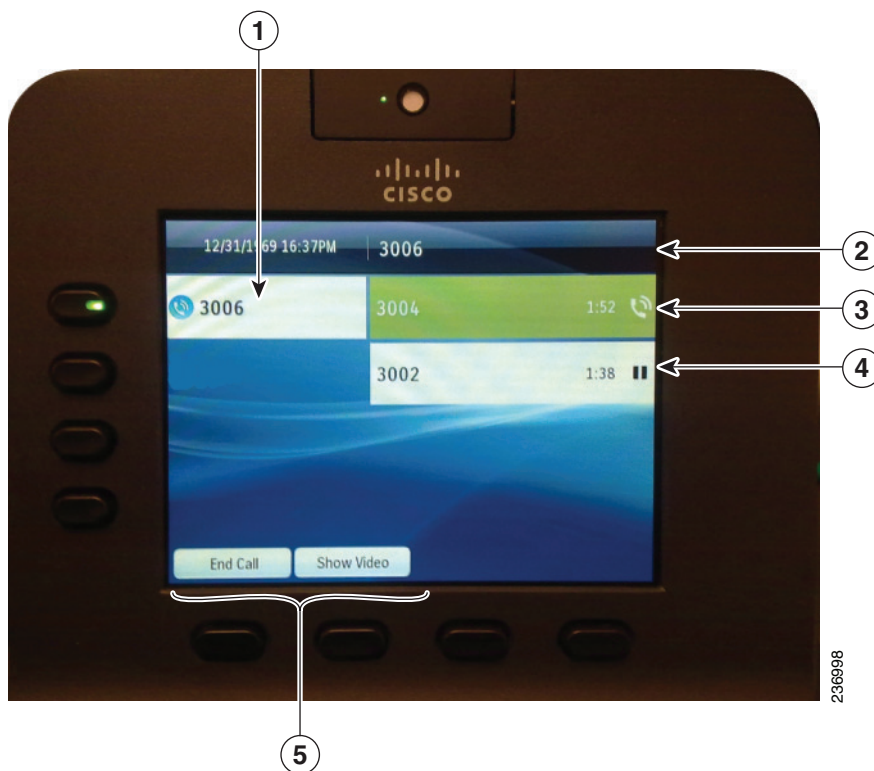

1	Line label	Displays the line phone information.
2	Header	<p>Displays the date and time, and information (such as phone number) about the selected line.</p> <p>(If you are on a call and highlight the header instead of a call, the softkeys that display are the same as those that display when the phone is idle. This is useful, for example, if you want to access the <b>Forward All</b> or <b>New Call</b> softkeys while you are on a call.)</p>

3	Session button label (for connected call)	<p>Displays information (such as phone number and duration) about a connected call on the line.</p> <p>The timer counts the call duration in minutes and seconds (MM:SS) until the call exceeds 60 minutes. Then the timer counts hours and minutes (HH:MM).</p>
4	Session button label (for held call)	<p>Displays information (such as phone number and duration) about a held call on the line.</p> <p>Pressing the corresponding session button resumes the held call.</p> <p>The timer counts the call duration in minutes and seconds (MM:SS) until the call exceeds 60 minutes. Then the timer counts hours and minutes (HH:MM).</p>
5	Softkeys	<p>Softkey options for the selected (highlighted) call only.</p> <p>If you select a different call (by pressing a feature button or the Navigation pad, or by answering a ringing call), the softkey options may change.</p>

## Phone with Multiple Lines

If you have multiple lines, it is recommended that you use the All Calls button to view all calls on all lines.

If you handle many calls at one time, it is recommended that you use the Answer button to answer the oldest incoming call without having to scroll down the call list and select the call.

For more information, see your system administrator.



236999

<b>1</b>	Primary line label	Displays information about the primary phone line. Look for the blue icon on the line label to see which line is selected. In this case, the primary line is selected, and the information displayed is for the primary line only.
<b>2</b>	Header	Displays the date and time, and information (such as phone number) about the selected line.  (If you are on a call and highlight the header instead of a call, the softkeys that display are the same as those that display when the phone is idle. This is useful, for example, if you want to access the <b>Forward All</b> or <b>New Call</b> softkeys while you are on a call.)
<b>3</b>	Session label (with Connected Call icon)	Displays information (such as call status and duration) about a connected call associated with the selected line.

<b>4</b>	Session labels (with Held Call icons)	<p>Display information (such as call status and duration) about held calls associated with the selected line.</p> <p>Calls are displayed on the right side of the phone screen from the oldest (at the top) to the newest.</p> <p>Pressing the session button next to a Held Call icon resumes the held call for that session.</p>
<b>5</b>	Softkeys	<p>Softkey options for the selected call only.</p> <p>If you select a different call (by pressing a feature button or the Navigation pad, or by answering a ringing call), the softkey options may change.</p>

## Power-Save Mode

Depending on how your system administrator sets up your phone, the phone display may go into a power-save mode (the phone screen appears blank and the Select button is lit white).

To turn on the phone display, press any button or pick up the handset.

## Handset Rest

Your system administrator may have mounted your phone on a wall. With a wall-mounted phone, you may need to adjust the handset rest to ensure that the receiver does not slip out of the cradle.

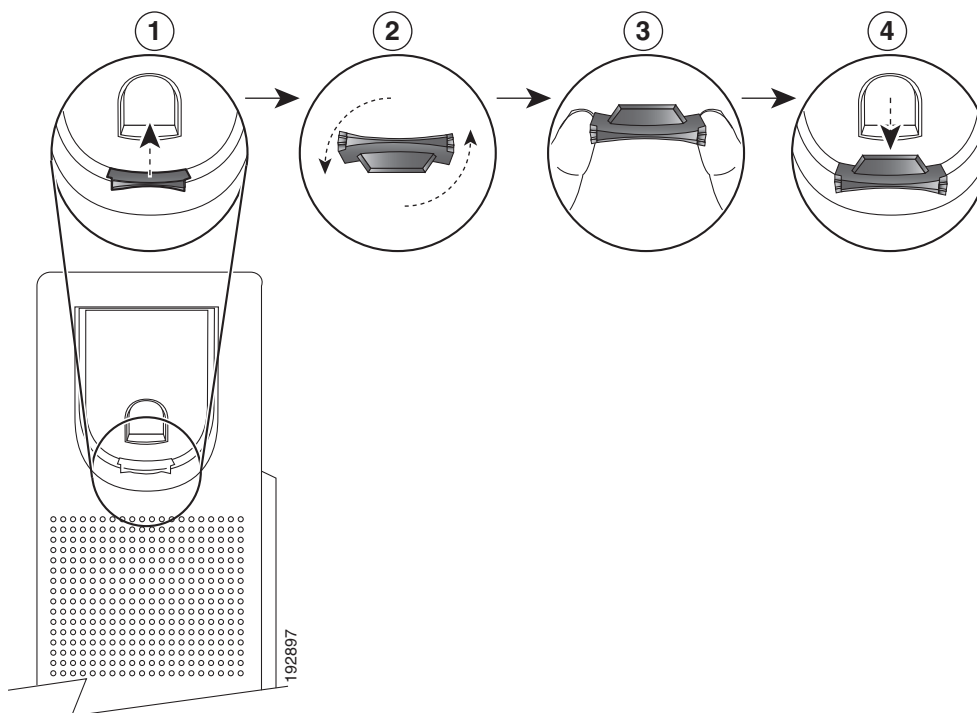

<b>1</b>	Remove the handset from the cradle and pull the plastic tab from the handset rest.
<b>2</b>	Rotate the tab 180 degrees.
<b>3</b>	Hold the tab between two fingers, with the corner notches facing you.
<b>4</b>	Line up the tab with the slot in the cradle and press the tab evenly into the slot. An extension protrudes from the top of the rotated tab. Return the handset to the handset rest.

## **Cisco Unified IP Phone 8945**

The Cisco Unified IP Phone 8945 provides these features:

- Phone connections
- Bluetooth
- Footstand
- Buttons and hardware
- Phone screen
- Power-save mode
- Handset rest

### **Phone Connections**

Your system administrator can help you connect your phone to the corporate IP telephony network.



236659

<b>1</b>	DC adapter port (DC48V)	<b>5</b>	Computer port (10/100/1000 PC) connection
<b>2</b>	AC-to-DC power supply (optional)	<b>6</b>	Handset connection
<b>3</b>	AC power wall plug (optional)	<b>7</b>	Analog headset connection (headset optional)
<b>4</b>	Network port (10/100/1000 SW) with IEEE 802.3af and 802.3at power enabled		

## **Bluetooth**

Your phone supports Bluetooth Class 2 technology when the headsets support Bluetooth. You can add and pair up to five Bluetooth headsets to your phone, but the last Bluetooth headset connected becomes the default for use with the phone.

### **Related Topics**

[Bluetooth Headsets, page 97](#)



## Footstand

If your phone is placed on a table or desk, connect the footstand to the back of the phone.

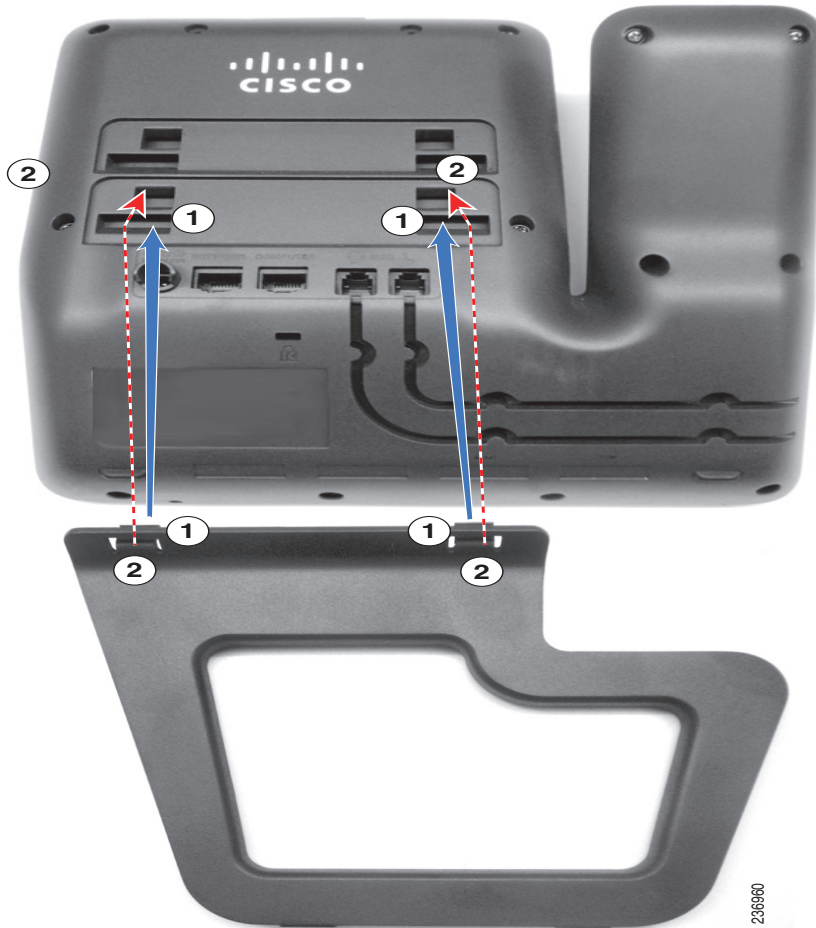

<b>1</b> Insert the curved connectors into the lower slots.	<b>2</b> Lift the footstand until the connectors snap into the upper slots.
---	---



**Note** Connecting and disconnecting the footstand may require a little more force than you expect.











## Buttons and Hardware













Your phone provides quick access to your phone lines, features, and call sessions. The Programmable Feature buttons (left side) is used to view calls on a line or access features such as speed dial or All Calls. (These buttons are also called Line buttons.)



236961

1	Phone screen	Shows information about your phone, including directory number, call information (for example caller ID, icons for an active call or call on hold) and available softkeys.
---	--------------	--

2	Video Camera 	Connects to your Cisco Unified IP Phone and allows you to make a point-to-point video call with another Cisco Unified IP Phone.
3	Softkey buttons 	Allows you to access the softkey options (for the selected call or menu item) displayed on your phone screen.
4	Navigation pad and Select button 	<p>The two-way Navigation pad allows you to scroll through menus, highlight items, and move within a text input field.</p> <p>The Select button (center of the Navigation pad) allows you to select a highlighted item as well as wake up the phone from deep sleep mode.</p> <p>The Select button is lit (white) when the phone is in power-save mode.</p>
5	Conference button 	Creates a conference call.
6	Hold button 	Places a connected call on hold.
7	Transfer button 	Transfers a call.
8	Redial button 	Redials a call.
9	Keypad	Allows you to dial phone numbers, enter letters, and choose menu items (by entering the item number).
10	Speakerphone button 	<p>Selects the speakerphone as the default audio path and initiates a new call, picks up an incoming call, or ends a call. During a call, the button is lit green.</p> <p>The speakerphone audio path does not change until a new default audio path is selected (for example, by picking up the handset).</p> <p>If external speakers are connected, the Speakerphone button selects them as the default audio path.</p>
11	Video Mute button 	Mutes video from the phone screen.
12	Mute button 	Toggles the microphone on or off during a call. When the microphone is muted, the button is lit red.

13	Headset button 	<p>Selects the headset as the default audio path and initiates a new call, picks up an incoming call, or ends a call. During a call, the button is lit green.</p> <p>A headset icon  in the phone screen header line indicates the headset is the default audio path. This audio path does not change until a new default audio path is selected (for example, by picking up the handset).</p>
14	Volume button 	<p>Controls the handset, headset, and speakerphone volume (off hook) and the ringer volume (on hook).</p> <p>Silences the ringer on the phone if an incoming call is ringing.</p>
15	Messages button 	<p>Auto-dials your voicemail system (varies by system).</p>
16	Applications button 	<p>Opens/closes the Applications menu. Depending on how your system administrator sets up the phone, use it to access applications such as call history, preferences, and phone information.</p>
17	Contacts button 	<p>Opens/closes the Contacts menu. Depending on how your system administrator sets up the phone, use it to access personal directory, corporate directory, or call history.</p>
18	Phone Speaker 	<p>Speaker for the phone.</p>
19	Programmable feature buttons (also called Line buttons) 	<p>Each corresponds with a phone line, speed dial, and calling feature. Pressing a button for a phone line displays the active calls for that line. If you have multiple lines, you may have an All Calls button that displays a consolidated list of all calls from all lines (oldest at the top). Then it is recommended that you keep your phone in the All Calls view.</p> <p>Color LEDs indicate the line state:</p> <ul style="list-style-type: none"> <li>• Amber  —Ringing call on this line</li> <li>• Green  —Active or held call on this line</li> <li>• Red  —Shared line in-use remotely</li> </ul> <p>(The positions of the session buttons and feature buttons can be reversed on phones that use a locale with a right-to-left reading orientation, such as Hebrew and Arabic.)</p>
20	Handset rest 	<p>To rest the phone handset.</p> <p>When there is an incoming call, the LED in the handset rest flashes red. If there is a new voice message, the LED is lit red.</p>

## Phone Screen

The way that your system administrator set up your phone determines what is displayed on your phone screen.

### Phone with a Single Line

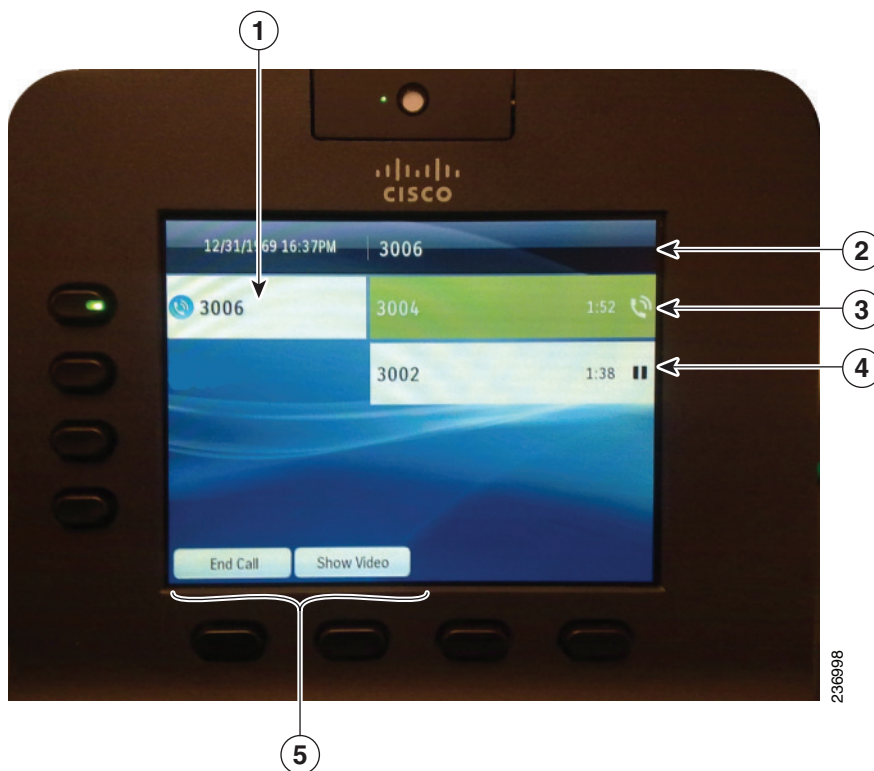

<b>1</b>	Line label	Displays the line phone information.
<b>2</b>	Header	Displays the date and time, and information (such as phone number) about the selected line.
<b>3</b>	Session button label (for connected call)	Displays information (such as phone number and duration) about a connected call on the line.  The timer counts the call duration in minutes and seconds (MM:SS) until the call exceeds 60 minutes. Then the timer counts hours and minutes (HH:MM).
<b>4</b>	Session label (for held call)	Displays information (such as phone number and duration) about a held call on the line.  Pressing the corresponding session button resumes the held call.  The timer counts the call duration in minutes and seconds (MM:SS) until the call exceeds 60 minutes. Then the timer counts hours and minutes (HH:MM).
<b>5</b>	Softkeys	Softkey options for the selected (highlighted) call only.  If you select a different call (by pressing a feature button or the Navigation pad, or by answering a ringing call), the softkey options may change.

## Phone with Multiple Lines

If you have multiple lines, it is recommended that you use the All Calls button to view all calls on all lines.

If you handle many calls at one time, it is recommended that you use the Answer button to answer the oldest incoming call without having to scroll down the call list and select the call.

For more information, see your system administrator.



1	Primary line label	Displays information about the primary phone line. Look for the blue icon on the line label to see which line is selected. In this case, the primary line is selected, and the information displayed is for the primary line only.
2	Header	Displays the date and time, and information (such as phone number) about the selected line.
3	Session label (with Connected Call icon)	Displays information (such as call status and duration) about a connected call associated with the selected line. The timer counts the call duration in minutes and seconds (MM:SS) until the call exceeds 60 minutes. Then the timer counts hours and minutes (HH:MM).

<b>4</b>	Session label (with Held Call icon)	<p>Display information (such as call status and duration) about held calls associated with the selected line.</p> <p>Calls are displayed on the right side of the phone screen from the oldest (at the top) to the newest.</p> <p>Pressing the session button next to a Held Call icon resumes the held call for that session.</p> <p>The timer counts the call duration in minutes and seconds (MM:SS) until the call exceeds 60 minutes. Then the timer counts hours and minutes (HH:MM).</p>
<b>5</b>	Softkeys	<p>Softkey options for the selected call only.</p> <p>If you select a different call (by pressing a feature button or the Navigation pad, or by answering a ringing call), the softkey options may change.</p>



## Power-Save Mode

Depending on how your system administrator set up your phone, the phone display may go into a power-save mode (the phone screen appears blank and the Select button is lit white).

To turn on the phone display, press any button or pick up the handset.

## Handset Rest

Your system administrator may have mounted your phone on a wall. With a wall-mounted phone, you may need to adjust the handset rest to ensure that the receiver does not slip out of the cradle.

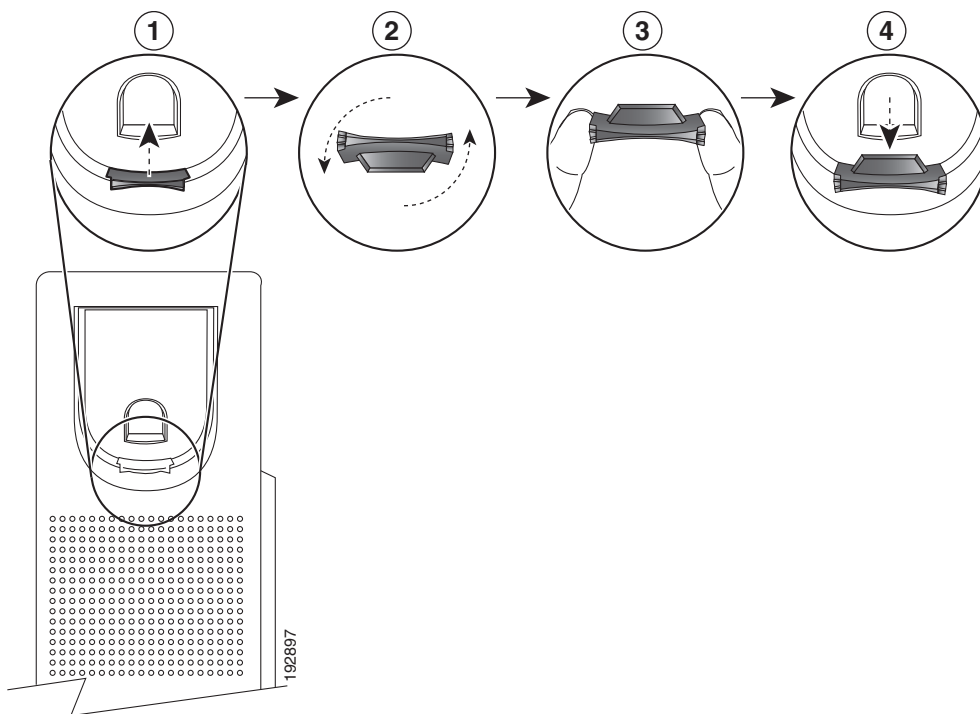

<b>1</b>	Remove the handset from the cradle and pull the plastic tab from the handset rest.
<b>2</b>	Rotate the tab 180 degrees.
<b>3</b>	Hold the tab between two fingers, with the corner notches facing you.
<b>4</b>	Line up the tab with the slot in the cradle and press the tab evenly into the slot. An extension protrudes from the top of the rotated tab. Return the handset to the handset rest.



# Applications

---

## Phone Applications

Phone applications allow you to access the following:

- Call History
- Preferences
- Accessories (For Cisco Unified IP Phone 8945 only.)
- Administrator Settings (for system administrators only).
- Phone Information

## Call History

Call History allows you to view information about the last 150 calls on your phone. Individual calls and call groups are listed chronologically from the most recent call to the oldest one. (If your phone has multiple lines, calls on all lines are added together. The oldest calls over the 150-call limit are dropped from the history.)

In the Call History screen, the line information, such as “Line: 5623,” is shown in the upper right corner to indicate the line name or number for which the call history is displayed.

For each call record or call group, an icon to the left of the caller ID shows the call type:

- Received—
- Placed—
- Missed—

If the caller ID is unavailable, “Unknown” is displayed, and the phone number is listed.

Calls for the same caller ID and phone number are grouped together only when if they occur in chronological order and do not have calls associated . For each group, the time of the latest call and the number of calls, such as “(3),” are displayed:

- Incoming (Received) and outgoing (Placed) calls are grouped together.
- Missed calls are grouped together in a separate group.

For each individual card record or call group, the phone number is listed in blue and is contact sensitive for touch dialing.



Hunt group and multiparty calls show an icon to the right of the caller ID that differentiates the call from a normal call, and these calls are not grouped even when they are next to each other in the list.

A (plus) + symbol on entries in call history, redial, or call directory indicates that your phone is set up to list international calls. For more information, see your system administrator.

## View Call History

1. Press the **Applications** button .
2. Select **Call History**. (Use the Navigation pad and Select button to scroll and select a call record or call group.)
3. Press the **Exit** softkey to return to the Applications screen.

## View Call Record Details

1. Press the **Applications** button .
2. Select **Call History**. (Use the Navigation pad and Select button to scroll and select.)
3. Select a call record or group and press the **Details** softkey (you may need to press **More** softkey first).
  - For each individual call, the Details screen displays the line information in the upper right corner, such as “Line: 5782,” and the call name, call number, alternate number (if available), call disposition (call type), call duration, and time of the call.
  - For each call group, the details shown are the same as for an individual call. The only difference is that the multiple call-related information is shown, such as call disposition (call type), call duration, and time of call, because this is a group of calls (Placed/Received or Missed). (In a group of Missed calls, individual records show no call duration.)
  - For each multiparty or hunt group call, the Details screen displays the line information in the upper right corner. For the caller ID and number listed at the top of the screen, the call name, call number, alternate number, and as applicable, the hunt group information, if available.
4. Press the return softkey  to return to the Call History screen.
5. Press the **Exit** softkey to return to the Applications screen.
6. While on a connected call, press the **Show Details** softkey to show the Call Details screen. This screen displays single call information and call duration and is updated each second.



## Filter Call History

1. Press the **Applications** button .
2. Select **Call History**. (Use the Navigation pad and Select button to scroll and select.)



The default view in Call History is for “All Calls,” which is shown at the top of the screen. The line information, such as “Line: 5623,” is shown in the upper right corner.

3. To sort calls for a specific phone line, select that phone line and view the individual calls or calls groups for that line.
4. To sort by missed calls for the selected line, press the **Missed Calls** softkey.
5. Press the **Exit** softkey to return to the Applications screen.

## Dial From Call History

1. Press the **Applications** button .
2. Select **Call History**. (Use the Navigation pad and Select button to scroll and select.)
3. From the Call History screen, select the call record that you want to dial and do one of the following:
  - Press the **Call** softkey.
  - Pick up the handset.
  - Press the **Select** button.
  - Press the **Speakerphone** button  or **Headset** button .
4. When the phone is in idle, you can press the up arrow on the Navigation pad to display the Call History screen.

## Edit Number From Call History

1. Press the **Applications** button .
2. Select **Call History**. (Use the Navigation pad and Select button to scroll and select.)
3. Highlight the call record that you want to edit.
4. Press the **EditDial** softkey. (You may need to press **More** softkey first.)
5. Press the up or down arrow on the **Navigation** bar to move the cursor to the desired location.
6. Press the  softkey to delete numbers on the left of the cursor.
7. Press the **Call** softkey to dial the new edited number.
8. Press the return softkey  to return the Call History screen.

## Clear Call History

1. Press the **Applications** button .
2. Select **Call History**. (Use the Navigation pad and Select button to scroll and select.)
3. Press the **Clear List** softkey to clear the entire call history on the phone.
4. Press the **Exit** softkey to return to Applications screen.

## Delete Call Record From Call History

1. Press the **Applications** button .
2. Select **Call History**. (Use the Navigation pad and Select button to scroll and select.)
3. Highlight the individual call record or call group that you want to delete.
4. Press the **Delete** softkey. (You may need to press **More** softkey first.)  
For a call group, pressing **Delete** deletes all calls in the group. A Delete Record alert message appears to verify that you want to delete the entire group of calls.
5. Press the **Cancel** softkey if desired.
6. Press the **Exit** softkey to return to Applications screen.

## Preferences



Preferences allows you to set user preferences for the following items:

- Ringtone
- Brightness
- Camera Settings
- Bluetooth

## Ringtones

You can choose the ringtone, per line, that your phone plays to indicate an incoming call. For information about adding custom ringtones to your phone, see your system administrator.

### Change Ringtone for a Line

1. Press the **Applications** button .
2. Select **Preferences**. (Use the Navigation pad and Select button to scroll and select.)
3. Select **Ringtone**.
4. Highlight a ringtone.
5. Press **Select** button or **Edit** softkey.
6. Press the **Play** softkey to play the sample ringtone.
7. Press the **Set** softkey to apply the ringtone.
8. Press the return softkey  to return to the Preferences screen.

## Brightness

You can adjust your phone screen brightness level.

## Adjust the Brightness

1. Press the **Applications** button .
2. Select **Preferences**. (Use the Navigation pad and Select button to scroll and select.)
3. Select **Brightness**.
  - To increase brightness, press the up arrow on the **Navigation** pad.
  - To decrease brightness, press the down arrow on the **Navigation** pad.
4. Press the **Save** softkey to set the brightness, or press the **Cancel** softkey to exit.

## Camera Settings

You can change the phone camera settings by selecting the available options - Auto Transmit Video and Brightness.

### Enable Auto Transmit Video



You can transmit the video automatically whenever a call is initiated or accepted.



---

**Note** If a video transmission is in progress, the camera LED turns green and when on video mute it turns red. The LED is turned off when the camera is not in use.

---

1. Press the **Applications** button .
2. Select **Preferences**. (Use the Navigation pad and Select button to scroll and select.)
3. Select **Camera Settings > Auto Transmit Video** option.
4. Click **Yes** to enable automatic video transmission and **No** to disable the feature.
5. Press the **Apply** softkey to apply the feature, or press the return softkey  to return to the Set-up screen.

### Adjust Brightness

You can set the brightness of the camera.



1. Press the **Applications** button .
2. Select **Preferences**. (Use the Navigation pad and Select button to scroll and select.)
3. Select **Camera Settings > Brightness** option.
4. Select **Brightness**.
  - To increase brightness, press the up arrow on the **Navigation** pad.
  - To decrease brightness, press the down arrow on the **Navigation** pad.
5. Press the **Save** softkey to set the brightness, or press the **Exit** softkey to return to the Setup screen.

## Bluetooth

If your system administrator has set up the Bluetooth feature for your phone, you can turn it on and off from your phone.



### Turn On Bluetooth

(For Cisco Unified IP Phone 8945 only.)

1. Press the **Applications** button .
2. Select **Preferences**. (Use the Navigation pad and Select button to scroll and select.)
3. Select **Bluetooth**.
4. Press the **Yes** softkey. The Bluetooth icon  appears on the phone screen header.  
To add a Bluetooth accessory from this screen, select **Bluetooth** again.

### Turn Off Bluetooth

(For Cisco Unified IP Phone 8945 only.)

1. Press the **Applications** button .
2. Select **Preferences**. (Use the Navigation pad and Select button to scroll and select.)
3. Select **Bluetooth**.
4. Press the **No** softkey.  
The Bluetooth icon  disappears from the phone screen header.

## Accessories

You can connect external hardware to your phone using either the headjack or Bluetooth. The accessory list, by default, contains an analog headset that can be set up to enable wideband.

### View Accessories List

1. Press the **Applications** button .
2. Select **Accessories**. (Use the Navigation pad and Select button to scroll and select.)  
A list of phone accessories is displayed.
3. Press the **Exit** softkey to return to the Applications screen.

### View Accessory Details

1. Press the **Applications** button .
2. Select **Accessories**. (Use the Navigation pad and Select button to scroll and select.)



A list of phone accessories is displayed.

3. Select an accessory from list and press the **Details** softkey.

The phone screen displays the details of selected accessory. The information displayed on the phone screen depends on the accessory selected. Most of the accessories provide these details:

- Device Name
- Device Type
- Configured Status

4. Press the **Setup** softkey to configure the selected accessory for your phone.
5. Press the **Exit** softkey to return to the Applications screen.

## Add Bluetooth Accessory

(For Cisco Unified IP Phone 8945 only.)

### Before You Begin

Before you add a Bluetooth accessory, it must be discoverable by the phone. Look for a flashing LED on a Bluetooth accessory as an indication that it is discoverable. For more information, see the documentation from the Bluetooth accessory manufacturer.

1. Press the **Applications** button .
2. Select **Accessories**. (Use the Navigation pad and Select button to scroll and select.)
3. Select **Add Bluetooth Accessory**.

The phone searches for discoverable accessories that are supported. When an accessory is found, it is added to the list in the Adding Bluetooth Accessory screen.

4. Select the accessory and press the **Connect** softkey.
5. The phone automatically attempts to connect the accessory using a Bluetooth device PIN of “0000.” If your accessory requires a different PIN and the Adding PIN screen appears, enter the PIN for your accessory.

When the connection is completed, the Bluetooth active icon  appears on the phone screen header and a checkmark appears next to the connected accessory.

## Delete Bluetooth Accessory

(For Cisco Unified IP Phone 8945 only.)

1. Press the **Applications** button .
2. Select **Accessories**. (Use the Navigation pad and Select button to scroll and select.)
3. Select a Bluetooth accessory and press the **Delete** softkey.

The Bluetooth accessory will be disconnected (if it was connected) and removed from the Accessories list.

## Connect Bluetooth Accessory

(For Cisco Unified IP Phone 8945 only.)

### Before You Begin

Before you can connect a Bluetooth accessory, it must be already added as an accessory to the phone.

1. Press the **Applications** button .
2. Select **Accessories**. (Use the Navigation pad and Select button to scroll and select.)
3. Select a Bluetooth accessory and press the **Connect** softkey.

When the connection is completed, the Bluetooth active icon  appears on the phone screen header and a checkmark appears next to the connected accessory.

## Disconnect Bluetooth Accessory

(For Cisco Unified IP Phone 8945 only.)

1. Press the **Applications** button .
2. Select **Accessories**. (Use the Navigation pad and Select button to scroll and select.)
3. Select a Bluetooth accessory and then press the **Disconnect** softkey.

## Administrator Settings

For information on accessing and changing the Administrator Settings, see your system administrator.

## Phone Information

Phone Information allows you to view the model information for your phone:

- Model Number
- IP Address
- Host Name
- Active Load
- Last Upgrade
- Active Server
- Stand-by Server

## View Phone Information

1. Press the **Applications** button .
2. Select **Phone Information**. (Use the Navigation pad and Select button to scroll and select.)
3. Press the **Exit** softkey to return to the Applications screen.



# Contacts

---

## Phone Contacts

The Cisco Unified IP Phone 8941 and 8945 provide you with access to corporate and personal contacts using these directories:

- Corporate Directory
- Personal Directory

You may see other directories listed in Contacts. For more information, see your system administrator.



## Corporate Directory

The corporate directory contains corporate contacts that you can access on your phone. Your system administrator sets up and maintains the directory.

You can dial calls from your corporate directory:

- When you are not on another call.
- When you are on another call.

## Search for and Dial a Contact

1. Press the **Contacts** button .
2. Select **Corporate Directory**. (Use the Navigation pad and **Select** button to scroll and select.)
3. Select one or all of these search criteria to search for a co-worker:
  - First Name
  - Last Name
4. Enter the search criteria information, press the **Submit** softkey, and select a contact.
5. To dial, perform any of these actions:
  - Press the **Dial** softkey.
  - Press the **Select** button.
  - From the keypad, press the number that is displayed in the upper right-hand corner of the contact label.
  - Press the **Speakerphone** button .

- Press the **Headset** button .
- Pick up the handset.

## **Search for and Dial a Contact While on a Call**

1. Press the **Contacts** button .
2. Select **Corporate Directory**. (Use the Navigation pad and **Select** button to scroll and select.)
3. Select one or both of these search criteria to search for a co-worker:
  - First Name
  - Last Name
4. Enter the search criteria information and press the **Search** softkey.
5. Press the **Dial** softkey. The first call gets automatically put on hold while the second call gets dialed.

## **Personal Directory**

The personal directory contains a list of your personal contacts. You can assign fast-dial codes to your personal directory entries for fast dialing.

There are two ways you can set up and maintain your personal directory:

- **Phone**—Using your phone, you can:
  - Set up and use Personal Directory
  - Assign and use fast-dial codes
- **User Options Web Pages**—Using User Options web pages, you can also set up and use your personal directory.

### **Related Topics**

[User Options, page 71](#)

## **Personal Directory Options**

From your phone, you can use personal directory options to:

- Sign in and out
- Add an entry
- Search for an entry
- Dial a number
- Delete an entry
- Edit an entry

## Sign In and Out of Personal Directory

1. Press the **Contacts** button .
2. Select **Personal Directory**. (Use the Navigation pad and **Select** button to scroll and select.)
3. Enter your user ID and PIN (provided by your system administrator) and then press the **Submit** softkey.
4. Select **Log Out**.
5. Press the **Select** softkey.
6. Press the **OK** softkey to sign out.

You are logged out automatically after a certain amount of time. This time limit can vary. For more information, see your system administrator.

## Add a Personal Directory Entry

1. Press the **Contacts** button .
2. Sign in to **Personal Directory**.
3. Select **Personal Address Book**; the Search for an entry screen displays.
4. Press the **Submit** softkey.
5. Press the **New** softkey (you may need to press the **More** softkey first).
6. Enter the nickname information (you can also enter a name).
7. Press the **Phones** softkey and enter the phone numbers.  
Include any required access codes such as a **9** or **1**.
8. Press the **Submit** softkey to add the entry to your personal directory.

## Search for an Entry in Personal Directory

1. Press the **Contacts** button .
2. Sign in to **Personal Directory**.
3. Select **Personal Address Book**.
4. Select one, all, or none of these criteria to search for an entry:
  - Last Name
  - First Name
  - Nickname
5. Enter the search criteria information and then press the **Submit** softkey. The name displays.

## **Dial a Number from Personal Directory**

1. Press the **Contacts** button .
2. Sign in to **Personal Directory**.
3. Select **Personal Address Book** and search for an entry.
4. Select the personal address book entry that you want to dial.
5. Press the **Dial** softkey.

## **Delete a Personal Directory Entry**

1. Press the **Contacts** button .
2. Sign in to **Personal Directory**.
3. Select **Personal Address Book** and search for an entry.
4. Press the **Select** softkey.
5. Press the **Edit** softkey.
6. Press the **Delete** softkey. (You may need to press the **More** softkey first.)
7. Press the **OK** softkey to confirm the deletion.

## **Edit a Personal Directory Entry**

1. Press the **Contacts** button .
2. Sign in to **Personal Directory**.
3. Select **Personal Address Book** and search for an entry.
4. Press the **Select** softkey.
5. Press the **Edit** softkey.
6. Modify the entry information.
7. Press the **Phones** softkey to modify a phone number.
8. Press the **Update** softkey.

## **Fast-Dial Codes with Personal Directory**

Using the phone, you can:

- Assign a fast-dial code to a Personal Directory entry
- Place a call using a fast-dial code
- Delete a fast-dial code



## Assign a Fast-Dial Code to a Personal Directory Entry

1. Press the **Contacts** button .
2. Sign in to **Personal Directory**. (Use the Navigation pad and **Select** button to scroll and select.)
3. Select **Personal Address Book**.
4. Enter the name information and press the **Submit** softkey.
5. Press the **Select** softkey and then press the **FastDial** softkey.
6. Select a number and press the **Select** softkey.
7. Scroll to an unassigned fast-dial index.  
(You may have to press the **Next** softkey to get to more fast-dial indexes.)
8. Press the **Select** softkey.

## Place a Call Using a Fast-Dial Code

1. Press the **Contacts** button .
2. Sign in to **Personal Directory**.
3. Select **Personal Fast Dials** and scroll to a fast-dial code.  
(You may have to press the **Next** softkey to get to more fast-dial codes.)
4. Select the fast-dial code you want to dial and press the **Dial** softkey.

## Delete a Fast-Dial Code

1. Press the **Contacts** button .
2. Sign in to **Personal Directory**.
3. Select **Personal Fast Dials** and search for a fast-dial code.
4. Select the fast-dial code that you want to delete and press the **Remove** softkey.  
(You may need to press the **More** softkey first.)
5. Select the index to delete.
6. Press the **Remove** softkey.



# Messages

---

## Voice Messages

Voice messages are stored on your voicemail system. Your company determines the voicemail system your phone uses.

You can:

- Personalize your voicemail
- Check for voice messages
- Listen to voice messages

## Personalize Your Voicemail

Press the **Messages** button , then follow the voice prompts.



## Check for Voice Messages

Check for voice messages in any of these ways:

- Look for a solid red light on your handset.  
You can set up the visual message waiting lamp using your User Options Web pages.
- Look for a Message icon  on a line label.

The red background indicates that there are new voice messages.

When you select a line with a Message icon, a Voicemail icon  displays on the right side of the phone screen.

Depending on your voicemail system, you might see a count of your new voice messages on the Message icon  and Voicemail icon .

If there are more than 99 new voice messages, the message count is replaced by a plus (+) sign.

If call forwarding is set up on a line that has new voice messages, the Call Forward icon  replaces the Message icon on the line label.

- Listen for a stutter tone (if available) from your handset, headset, or speakerphone when you place a call.

The stutter tone is line-specific. You hear it only when using the line that has new voice messages. You can set up audible message waiting tones using your User Options Web pages.

## **Related Topics**

- [Change the Audible Voice Message Indicator Setting Per Line, page 74](#)
- [Change the Voice Message Indicator Setting Per Line, page 73](#)

## **Listen to Voice Messages**

1. To listen to voice messages, do one of the following:
  - Press the **Messages** button .
  - Select a line with a Message icon  and press the Session button  next to the Voicemail icon .
2. Follow the prompts to listen to your voice messages.

After you listen to your new voice messages, the message indicators are updated on the phone screen. If there are no new voice messages, the Message icon is removed from the line label, and the Voicemail icon is removed from the right side of the phone screen.

# Calling Features

## Feature Buttons and Softkeys

Depending on how your system administrator set up your phone, some features included in this guide may not be available to you.

This table provides information about some of the features that are available on softkeys and dedicated feature buttons and some that your system administrator sets up on programmable feature buttons.

Feature Name	Dedicated Feature Button	Programmable Feature Button	Softkey
Answer		X	
Call Back		X	X
Call Forward All		X	X
Call Park		X	X
Call Park Line Status		X	
Call Pickup		X	
Call Pickup Line Status		X	
Conference	X		X (available while on a conference only)
Divert			X
Do Not Disturb		X	
Group Pickup		X	
Hold	X		
Hunt Groups		X	
Intercom		X	
Malicious Call Identification (MCID)		X	

Feature Name	Dedicated Feature Button	Programmable Feature Button	Softkey
Meet Me		X	
Mobile Connect		X	
Mute (Audio)	X		
Mute (Video)	X		
Other Pickup		X	
Privacy		X	
Quality Reporting Tool (QRT)		X	
Redial		X	
Speed Dial		X	X
Speed Dial Line Status		X	
Transfer	X		X (available during a transfer only)

## Agent Greeting

The Agent Greeting feature allows an agent to create and update a prerecorded greeting that plays at the beginning of a call, such as a customer call, before the agent begins the conversation with the caller. The agent can prerecord a single greeting or multiple ones as needed.

When a customer calls, both callers hear the prerecorded greeting. The agent can remain on mute until the greeting ends or answer the call over the greeting.

For more information, see your system administrator.

## Answer

Answer allows you to answer the oldest call that is available on all line appearances on your phone, including Hold Reversion and Park Reversion calls that are in an alerting state. Incoming calls are always given priority over Held or Park Reversion calls.

Your system administrator sets up the Answer button depending on your call-handling needs and work environment. This feature is typically set up for users who have multiple lines.

## Answer Your Oldest Call First

To answer the oldest incoming call first, press the **Answer** button.

## Auto Answer

Auto Answer prompts your phone to automatically answer incoming calls after one ring.

Your system administrator sets up Auto Answer to work with either your speakerphone or headset.

## Auto Answer with Your Headset

If Auto Answer with Headset is active and configured, the Headset button  is illuminated and headset connected, incoming call is answered with the headset. Otherwise, calls ring normally and you must manually answer them. To keep the Headset button illuminated, use buttons and softkeys (instead of the Headset button) to place and end calls. Your administrator has to set headset as the default audio path for auto answer.

## Auto Answer with Your Speakerphone

Keep the handset in the cradle and the Headset button  unlit. Otherwise, calls ring normally and you must manually answer them.

## Barge

The barge feature allows you to add yourself to non-private calls on a shared line. You can convert the call into a conference and add new participants.

## Add Yourself to a Call on a Shared Line

Press the red line button for the shared line. You are added to the call.

## Call Back

Call Back allows you to receive an audio and visual notification on your phone when a busy or unavailable party becomes available.

Call Back, which is available as a softkey, may also be available as a feature button. See your system administrator for additional information.

## Set up a Call Back Notification

1. Press the **Callback** softkey while listening to the busy tone or ring sound.  
A confirmation screen displays on the phone.
2. Press the **Exit** softkey to exit the confirmation screen, if desired.  
Your phone alerts you when the line is free.
3. Press the **Dial** softkey to place the call again, if desired.

## Call Forward All

Call Forward All allows you to forward calls from any line on your phone to another number.

You can set up Call Forward All directly on your phone for any line. To set up Call Forward All remotely, go to your User Options web pages.

There are two types of call-forwarding features that your system administrator may set up on your phone:

- Unconditional call forwarding (Call Forward All)—Applies to all calls that you receive.
- Conditional call forwarding (Call Forward No Answer, Call Forward Busy, Call Forward No Coverage)—Applies to certain calls that you receive, according to conditions, and is accessible only from your User Options web pages.

When forwarding calls from your phone:

- Enter the call forward target number exactly as you would dial it from your phone. For example, enter an access code or the area code, if necessary.
- Call forwarding is phone-line specific. If a call reaches you on a line where call forwarding is not enabled, the call will ring as usual.
- Your system administrator can set up other call-forward options that do the following:
  - Allow calls placed from the call forward target number to your phone to ring through, rather than be forwarded.
  - Prevent you from creating a call-forward loop or exceeding the maximum number of links in a call forwarding chain.

### Related Topics

[Set Up Call Forwarding Per Line, page 73](#)



## Forward Calls on Your Phone

1. On any idle line from which you want to forward your calls, press the **Forward All** softkey.
2. Enter a phone number, or select an entry from the Call History list. (Depending on how your voicemail system is set up, you may be able to press the **Messages** button  to forward all calls to voicemail.)

Visual confirmation displays for a few seconds to confirm the number to which your calls will be forwarded.

3. To verify that your calls are forwarded, look for:
  - A Forward All icon  in the line label.
  - The forwarding information in the header.
4. To cancel call forwarding, press the **Forward Off** softkey.  
To set up conditional call forwarding, go to your User Options Web pages.

## Call Park

Call Park allows you to use your phone to park (temporarily store) a call, which you can then retrieve from another phone (such as a phone at a coworker's desk or in a conference room).

There are two ways you can park a call:

- **Park**—Allows you to park an active call that you answered on your phone, and retrieve it using another phone in the Cisco Unified Communications Manager system.
- **Directed Call Park**—Allows you to park and retrieve an active call in two different ways:
  - **Assisted Directed Call Park**—Allows you to park an active call by pressing a feature button, which your system administrator sets up as a speed dial line.  
With this type of directed call, you can monitor the status of the line (in-use, idle, or Do Not Disturb) using Line Status indicators.
  - **Manual Directed Call Park**—Allows you to park an active call by transferring it to a Directed Call number, which your system administrator sets up.  
You retrieve the call at another phone by dialing a park retrieval prefix number (provided by your system administrator) and then dialing the Directed Call number you used to park the call.

Your system administrator sets up either the Directed Call Park or the Park feature on your phone, but not both.

### Related Topics

[Line Status, page 58](#)

## Park and Retrieve a Call Using Park

1. During a call, press the **Park** softkey, then hang up.

Your phone displays the number where the system parked the call. The parked call is put on hold, and you can press the **Resume** softkey to resume the call on your phone.

2. From any other Cisco Unified IP Phone in your network, enter the number where the call is parked to retrieve the call.

If you do not retrieve the call within a certain amount of time (set by your system administrator) you will receive an alert tone, at which time you can:

- Press the **Answer** softkey to answer the call on your phone.
- Retrieve the call from another phone.

If you fail to retrieve or answer the call within a specified amount of time, the call is redirected to another destination (set up by your system administrator), such as voicemail. If the call gets redirected, it can no longer be retrieved by using Call Park.

## Park and Retrieve a Call Using Assisted Directed Call Park

1. During a call, press a **Directed Call Park** button displaying an idle Line Status indicator.
2. Retrieve the call, from any other Cisco Unified IP Phone in your network as follows:
  - a. Enter the park retrieval prefix.
  - b. Dial the Directed Call number.

For example, if the park retrieval prefix is “99” and the Directed Call number is “1234,” enter 991234.

If you do not retrieve the call within a certain amount of time (set by your system administrator) you will receive an alert tone, at which time you can:

- Press the **Resume** softkey to resume the call on your phone.
- Retrieve the call from another phone.

If you fail to retrieve or resume the call within a specified amount of time, the call is directed to another destination (set up by your system administrator), such as voicemail.

## Park and Retrieve a Call Using Manual Directed Call Park

1. During a call, press the **Transfer** button .
2. Enter the Directed Call number where you will park the call.
3. Press **Transfer** again to finish parking the call, then hang up.