



Cisco 170 Series Hardware Installation Guide

For Cisco C170 Email Security Appliance, Cisco M170 Content Security Management Appliance, and Cisco S170 Web Security Appliance

Americas Headquarters

Cisco Systems, Inc.
170 West Tasman Drive
San Jose, CA 95134-1706
USA
<http://www.cisco.com>
Tel: 408 526-4000
800 553-NETS (6387)
Fax: 408 527-0883

THE SPECIFICATIONS AND INFORMATION REGARDING THE PRODUCTS IN THIS MANUAL ARE SUBJECT TO CHANGE WITHOUT NOTICE. ALL STATEMENTS, INFORMATION, AND RECOMMENDATIONS IN THIS MANUAL ARE BELIEVED TO BE ACCURATE BUT ARE PRESENTED WITHOUT WARRANTY OF ANY KIND, EXPRESS OR IMPLIED. USERS MUST TAKE FULL RESPONSIBILITY FOR THEIR APPLICATION OF ANY PRODUCTS.

THE SOFTWARE LICENSE AND LIMITED WARRANTY FOR THE ACCOMPANYING PRODUCT ARE SET FORTH IN THE INFORMATION PACKET THAT SHIPPED WITH THE PRODUCT AND ARE INCORPORATED HEREIN BY THIS REFERENCE. IF YOU ARE UNABLE TO LOCATE THE SOFTWARE LICENSE OR LIMITED WARRANTY, CONTACT YOUR CISCO REPRESENTATIVE FOR A COPY.

The following information is for FCC compliance of Class A devices: This equipment has been tested and found to comply with the limits for a Class A digital device, pursuant to part 15 of the FCC rules. These limits are designed to provide reasonable protection against harmful interference when the equipment is operated in a commercial environment. This equipment generates, uses, and can radiate radio-frequency energy and, if not installed and used in accordance with the instruction manual, may cause harmful interference to radio communications. Operation of this equipment in a residential area is likely to cause harmful interference, in which case users will be required to correct the interference at their own expense.

The following information is for FCC compliance of Class B devices: This equipment has been tested and found to comply with the limits for a Class B digital device, pursuant to part 15 of the FCC rules. These limits are designed to provide reasonable protection against harmful interference in a residential installation. This equipment generates, uses and can radiate radio frequency energy and, if not installed and used in accordance with the instructions, may cause harmful interference to radio communications. However, there is no guarantee that interference will not occur in a particular installation. If the equipment causes interference to radio or television reception, which can be determined by turning the equipment off and on, users are encouraged to try to correct the interference by using one or more of the following measures:

- Reorient or relocate the receiving antenna.
- Increase the separation between the equipment and receiver.
- Connect the equipment into an outlet on a circuit different from that to which the receiver is connected.
- Consult the dealer or an experienced radio/TV technician for help.

Modifications to this product not authorized by Cisco could void the FCC approval and negate your authority to operate the product.

The Cisco implementation of TCP header compression is an adaptation of a program developed by the University of California, Berkeley (UCB) as part of UCB's public domain version of the UNIX operating system. All rights reserved. Copyright © 1981, Regents of the University of California.

NOTWITHSTANDING ANY OTHER WARRANTY HEREIN, ALL DOCUMENT FILES AND SOFTWARE OF THESE SUPPLIERS ARE PROVIDED "AS IS" WITH ALL FAULTS. CISCO AND THE ABOVE-NAMED SUPPLIERS DISCLAIM ALL WARRANTIES, EXPRESSED OR IMPLIED, INCLUDING, WITHOUT LIMITATION, THOSE OF MERCHANTABILITY, FITNESS FOR A PARTICULAR PURPOSE AND NONINFRINGEMENT OR ARISING FROM A COURSE OF DEALING, USAGE, OR TRADE PRACTICE.

IN NO EVENT SHALL CISCO OR ITS SUPPLIERS BE LIABLE FOR ANY INDIRECT, SPECIAL, CONSEQUENTIAL, OR INCIDENTAL DAMAGES, INCLUDING, WITHOUT LIMITATION, LOST PROFITS OR LOSS OR DAMAGE TO DATA ARISING OUT OF THE USE OR INABILITY TO USE THIS MANUAL, EVEN IF CISCO OR ITS SUPPLIERS HAVE BEEN ADVISED OF THE POSSIBILITY OF SUCH DAMAGES.

Cisco and the Cisco logo are trademarks or registered trademarks of Cisco and/or its affiliates in the U.S. and other countries. To view a list of Cisco trademarks, go to this URL: www.cisco.com/go/trademarks. Third-party trademarks mentioned are the property of their respective owners. The use of the word partner does not imply a partnership relationship between Cisco and any other company. (1110R)

Any Internet Protocol (IP) addresses and phone numbers used in this document are not intended to be actual addresses and phone numbers. Any examples, command display output, network topology diagrams, and other figures included in the document are shown for illustrative purposes only. Any use of actual IP addresses or phone numbers in illustrative content is unintentional and coincidental.

Cisco 170 Series Hardware Installation Guide
© 2012 Cisco Systems, Inc. All rights reserved.



CONTENTS

Preface vii

Contents	vii
Document Objectives	vii
Audience	vii
Document Organization	viii
Document Conventions	viii
Installation Warnings	ix
Where to Find Safety and Warning Information	xiii
Related Documentation	xiii
Obtaining Documentation and Submitting a Service Request	xiii

CHAPTER 1

Cisco 170 Series Appliance 1-1

Cisco 170 Series Overview	1-1
Cisco C170 Email Security Appliance	1-2
Cisco M170 Content Security Management Appliance	1-2
Cisco S170 Web Security Appliance	1-2
Cisco 170 Series Appliance Panels	1-3
Front Panel LEDs	1-3
Rear Panel LEDs	1-5
Rear Panel Ports	1-6
Alarm LED	1-8
Management Interface	1-8
Hard Disk Drives	1-8
Hardware and Technical Specifications	1-9

CHAPTER 2

Preparing for Installation 2-1

Installation Overview	2-1
Safety Recommendations	2-2
Maintaining Safety with Electricity	2-2
Preventing Electrostatic Discharge Damage	2-3
Working in an ESD Environment	2-3
General Site Requirements	2-4
Site Environment	2-4

Preventive Site Configuration	2-4
Power Supply Considerations	2-5
Configuring Equipment Racks	2-7

CHAPTER 3

Installing and Connecting the Cisco 170 Series Appliance 3--1

Installing the Cisco 170 Series Appliance with Slide Rails	3--1
Verifying the Box Contents	3--1
Disassembling the Slide Rail	3-0
Attaching Inner Rails to the Appliance	3-1
Verifying the Rack Type	3-2
Securing Round Hole Racks	3-3
Securing Threaded Hole Racks	3-3
Attaching the Outer Slide Rail to Round and Square Hole Racks	3-4
Attaching the Outer Slide Rail to Threaded Hole Racks	3-5
Installing the Appliance	3-6
Securing the Appliance	3-7
Rack Mounting the Cisco 170 Series Appliance	3-8
Guidelines and Recommendations	3-8
Rack Mounting the Cisco C170, Cisco M170, or Cisco S170 Appliances	3-8
Connecting the Interface Cables and Verifying Connectivity	3-10

CHAPTER 4

Maintaining the Cisco 170 Series Appliance 4-1

Fixed AC Power Supply	4-1
Removing and Installing Hard Disk Drives	4-1
Maintenance Scenarios	4-2
Replacing the Hard Disk Drives	4-2
Contacting Service and Support	4-3

APPENDIX A

Identifying Cable Pinouts A-1

10/100/1000BaseT Connectors	A-1
Console Port (RJ-45)	A-2
RJ-45 to DB-9	A-3



Preface

Contents

This preface includes the following sections:

- [Document Objectives, page vii](#)
- [Audience, page vii](#)
- [Document Organization, page viii](#)
- [Document Conventions, page viii](#)
- [Installation Warnings, page ix](#)
- [Where to Find Safety and Warning Information, page xiii](#)
- [Related Documentation, page xiii](#)
- [Obtaining Documentation and Submitting a Service Request, page xiii](#)

Document Objectives

This guide describes how to install and maintain the Cisco 170 series appliance. The information in this guide applies to the following Cisco 170 series (Cisco 170 series) appliance models:

- Cisco C170 Email Security Appliance (Cisco C170)
- Cisco M170 Content Security Management Appliance (Cisco M170)
- Cisco S170 Web Security Appliance (Cisco S170)

References to “Cisco 170 series” and “appliance” applies to the listed models, unless specifically noted otherwise.

Audience

This guide is for experienced network security administrators who install, configure, and maintain Cisco content security appliances in their networks.

Document Organization

This guide includes the following sections:

Section	Title	Description
1	“Cisco 170 Series Appliance”	Describes the Cisco 170 series appliance and its specifications.
2	“Preparing for Installation”	Describes steps to follow before installing the Cisco 170 series appliance.
3	“Installing and Connecting the Cisco 170 Series Appliance”	Describes how to install the Cisco 170 series appliance in a rack and provides information about how to connect interface cables.
4	“Maintaining the Cisco 170 Series Appliance”	Describes the power supply provided with the Cisco 170 series appliance and how to remove and replace hard disk drives (HDDs).
A	“Identifying Cable Pinouts”	Describes the cable pinouts.

Document Conventions

Command descriptions use these conventions:

- Braces ({ }) indicate a required choice.
- Square brackets ([]) indicate optional elements.
- Vertical bars (|) separate alternative, mutually exclusive elements.
- **Boldface** indicates commands and keywords that are entered literally as shown.
- *Italics* indicate arguments for which you supply values.

Examples use these conventions:

- Examples depict screen displays and the command line in *screen* font.
- Information you need to enter in examples is shown in **boldface screen** font.
- Variables for which you must supply a value are shown in *italic screen* font.

Graphical user interface examples uses these conventions:

- **Boldface** indicates buttons and menu items.
- Selecting a menu item (or pane) is indicated by the following convention:
Choose **Start > Settings > Control Panel**.



Note

Means *reader take note*. Notes contain helpful suggestions or references to material not covered in the manual.

Installation Warnings

Before installing the appliance, be sure to read the *Safety and Compliance Guide for the Cisco Content Security Appliances* document at:

<http://www.cisco.com/en/US/docs/security/esa/hw/SafetyAndComplianceGuide.pdf>. This document contains important safety information. This section includes the following warnings:

- [Power Supply Disconnection Warning, page ix](#)
- [Jewelry Removal Warning, page ix](#)
- [Wrist Strap Warning, page x](#)
- [Work During Lightning Activity Warning, page x](#)
- [Work During Lightning Activity Warning, page x](#)
- [Installation Instructions Warning, page x](#)
- [Chassis Warning for Rack-Mounting and Servicing, page x](#)
- [SELV Circuit Warning, page x](#)
- [Ground Conductor Warning, page x](#)
- [Blank Faceplates and Cover Panels Warning, page xi](#)
- [Product Disposal Warning, page xi](#)
- [Short-Circuit Protection Warning, page xi](#)
- [Compliance with Local and National Electrical Codes Warning, page xi](#)
- [TN Power Warning, page xi](#)
- [TN Power Warning, page xi](#)
- [TN Power Warning, page xi](#)
- [Multiple Power Cord, page xi](#)
- [Multiple Power Cord, page xi](#)
- [Circuit Breaker \(15A\) Warning, page xi](#)
- [Grounded Equipment Warning, page xii](#)
- [Safety Cover Requirement, page xii](#)
- [Faceplates and Cover Panel Requirement, page xii](#)

Power Supply Disconnection Warning



Warning

Before working on a chassis or working near power supplies, unplug the power cord on AC units.
Statement 12

Jewelry Removal Warning



Warning

Before working on equipment that is connected to power lines, remove jewelry (including rings, necklaces, and watches). Metal objects will heat up when connected to power and ground and can cause serious burns or weld the metal object to the terminals. Statement 43

Wrist Strap Warning



Warning

During this procedure, wear grounding wrist straps to avoid ESD damage to the card. Do not directly touch the backplane with your hand or any metal tool, or you could shock yourself. Statement 94

Work During Lightning Activity Warning



Warning

Do not work on the system or connect or disconnect cables during periods of lightning activity. Statement 1001

Installation Instructions Warning



Warning

Read the installation instructions before connecting the system to the power source. Statement 1004

Chassis Warning for Rack-Mounting and Servicing



Warning

To prevent bodily injury when mounting or servicing this unit in a rack, you must take special precautions to ensure that the system remains stable. The following guidelines are provided to ensure your safety: This unit should be mounted at the bottom of the rack if it is the only unit in the rack. When mounting this unit in a partially filled rack, load the rack from the bottom to the top with the heaviest component at the bottom of the rack. If the rack is provided with stabilizing devices, install the stabilizers before mounting or servicing the unit in the rack. Statement 1006

SELV Circuit Warning



Warning

To avoid electric shock, do not connect safety extra-low voltage (SELV) circuits to telephone-network voltage (TNV) circuits. LAN ports contain SELV circuits, and WAN ports contain TNV circuits. Some LAN and WAN ports both use RJ-45 connectors. Use caution when connecting cables. Statement 1021

Ground Conductor Warning



Warning

This equipment must be grounded. Never defeat the ground conductor or operate the equipment in the absence of a suitably installed ground conductor. Contact the appropriate electrical inspection authority or an electrician if you are uncertain that suitable grounding is available. Statement 1024

Blank Faceplates and Cover Panels Warning



Blank faceplates and cover panels serve three important functions: they prevent exposure to hazardous voltages and currents inside the chassis; they contain electromagnetic interference (EMI) that might disrupt other equipment; and they direct the flow of cooling air through the chassis. **Do not operate the system unless all cards, faceplates, front covers, and rear covers are in place.** Statement 1029

Product Disposal Warning



Ultimate disposal of this product should be handled according to all national laws and regulations. Statement 1040

Short-Circuit Protection Warning



This product requires short-circuit (overcurrent) protection, to be provided as part of the building installation. Install only in accordance with national and local wiring regulations. Statement 1045

Compliance with Local and National Electrical Codes Warning



Installation of the equipment must comply with local and national electrical codes. Statement 1074

TN Power Warning



The device is designed to work with TN power systems. Statement 19

Multiple Power Cord



This unit has more than one power cord. To reduce the risk of electric shock when servicing a unit, disconnect the power cord of the power strip that the unit is plugged into. Statement 137

Circuit Breaker (15A) Warning



This product relies on the building's installation for short-circuit (overcurrent) protection. Ensure that a fuse or circuit breaker no larger than 120 VAC, 15A U.S. (240 VAC, 10A international) is used on the phase conductors (all current-carrying conductors). Statement 13

Grounded Equipment Warning



Warning

This equipment is intended to be grounded. Ensure that the host is connected to earth ground during normal use. Statement 39

Safety Cover Requirement



Warning

The safety cover is an integral part of the product. Do not operate the unit without the safety cover installed. Operating the unit without the cover in place will invalidate the safety approvals and pose a risk of fire and electrical hazards. Statement 117

Faceplates and Cover Panel Requirement



Warning

Blank faceplates and cover panels serve three important functions: they prevent exposure to hazardous voltages and currents inside the chassis; they contain electromagnetic interference (EMI) that might disrupt other equipment; and they direct the flow of cooling air through the chassis. Do not operate the system unless all cards, faceplates, front covers, and rear covers are in place. Statement 142

Where to Find Safety and Warning Information

For safety and warning information, see the *Safety and Compliance Guide for the Cisco Content Security Appliances* document at the following URL:

<http://www.cisco.com/en/US/docs/security/esa/hw/SafetyAndComplianceGuide.pdf>

This document describes the international agency compliance and safety information for the Cisco 170 series. It also includes translations of the safety warnings used in this guide.

Related Documentation

For additional documentation on the Cisco 170 series appliances, see the following:

- Cisco C170 Email Security Appliance:
http://www.cisco.com/en/US/products/ps10154/tsd_products_support_series_home.html
- Cisco M170 Content Security Management Appliance:
http://www.cisco.com/en/US/partner/products/ps10155/tsd_products_support_series_home.html
- Cisco S170 Web Security Appliance:
http://www.cisco.com/en/US/partner/products/ps10164/tsd_products_support_series_home.html

Obtaining Documentation and Submitting a Service Request

For information on obtaining documentation, submitting a service request, and gathering additional information, see the monthly *What's New in Cisco Product Documentation*, which also lists all new and revised Cisco technical documentation, at:

<http://www.cisco.com/en/US/docs/general/whatsnew/whatsnew.html>

Subscribe to the *What's New in Cisco Product Documentation* as an RSS feed and set content to be delivered directly to your desktop using a reader application. The RSS feeds are a free service. Cisco currently supports RSS Version 2.0.





CHAPTER 1

Cisco 170 Series Appliance

We recommend that you read the entire guide before beginning any of the procedures contained herein.



Warning

Only trained and qualified personnel should install, replace, or service this equipment. Statement 49



Caution

Read the safety warnings in the *Safety and Compliance Guide for the Cisco Content Security Appliances* and follow proper safety procedures when performing any tasks in this document. See: <http://www.cisco.com/en/US/docs/security/esa/hw/SafetyAndComplianceGuide.pdf>.

This chapter describes the Cisco 170 series appliance, including the front and rear panels, LEDs, rear panel ports, and the hardware and technical specifications of the product.

This chapter includes the following sections:

- [Cisco 170 Series Overview, page 1-1](#)
- [Cisco 170 Series Appliance Panels, page 1-3](#)
- [Alarm LED, page 1-8](#)
- [Management Interface, page 1-8](#)
- [Hard Disk Drives, page 1-8](#)
- [Hardware and Technical Specifications, page 1-9](#)

Cisco 170 Series Overview

The Cisco 170 series is a family of next-generation content security appliances capable of providing the following features and functionality for small businesses, branch offices, and organizations:

- Simplified and automated email security
- Web traffic and application visibility and control
- Flexible, comprehensive security control and management

Cisco C170 Email Security Appliance

Cisco C170 Email Security Appliance (Cisco C170) automatically stops spam, viruses, and other anomalies. It prevents and responds to multilevel threats and includes capabilities such as: spam and virus defense, policy enforcement, email authentication, and centralized and built-in GUI management tools. For information on Cisco C170, see:

http://www.cisco.com/en/US/products/ps10154/tsd_products_support_series_home.html

Figure 1-1 shows the Cisco C170 front panel view.

Figure 1-1 Cisco C170 Email Security Appliance



Cisco M170 Content Security Management Appliance

Cisco M170 Content Security Management Appliance (Cisco M170) is a central platform for managing all policy, integrated reporting on traffic data, and email auditing information for the Cisco 170 series appliances. For information on Cisco M170, see:

http://www.cisco.com/en/US/partner/products/ps10155/tsd_products_support_series_home.html

Figure 1-2 shows the Cisco M170 front panel view.

Figure 1-2 Cisco M170 Content Security Management Appliance



Cisco S170 Web Security Appliance

Cisco S170 Web Security Appliance (Cisco S170) is a secure web gateway that combines advanced malware protection, application visibility and control (AVC), acceptable use policy controls, insightful reporting, and secure mobility on a single platform. It is a single platform for administrators to set security policy, control applications at a granular level, and get visibility into web traffic trends at organizations and for remote and mobile users. For information on Cisco S170, see:

http://www.cisco.com/en/US/partner/products/ps10164/tsd_products_support_series_home.html

Figure 1-3 shows the Cisco S170 front panel view.

Figure 1-3 Cisco S170 Web Security Appliance



Cisco 170 Series Appliance Panels

This section describes the front and rear Cisco 170 series appliance panels. It includes the following topics:

- [Front Panel LEDs, page 1-3](#)
- [Rear Panel LEDs, page 1-5](#)
- [Rear Panel Ports, page 1-6](#)

Front Panel LEDs

This section describes the front panel LEDs for the Cisco 170 series appliance.

Figure 4 shows the front panel LEDs that are available for the Cisco C170, Cisco M170 and Cisco S170 models (graphic shows the Cisco S170 bezel).

Figure 4 Front Panel LEDs for Cisco C170, Cisco M170 and Cisco S170

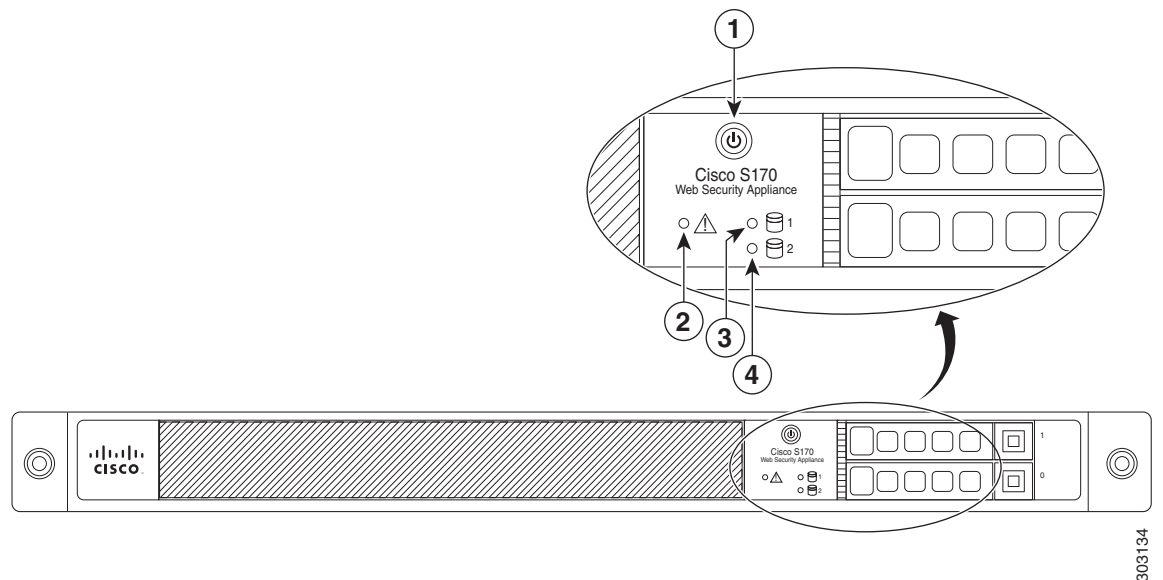

	LED	Description
1	Power button	<p>A hard switch that turns the system on and off. Once depressed, the button stays in the “on” position:</p> <ul style="list-style-type: none"> • On—The power symbol on the button illuminates. • Off—The power symbol on the button is dark.
2	Alarm	<p>Indicates system operating status:</p> <ul style="list-style-type: none"> • Off—Normal operating system function. • Solid amber—Critical Alarm indicating one or more of the following: <ul style="list-style-type: none"> – A major failure of a hardware or software component. – An over-temperature condition. – The power voltage is outside of the tolerance range. <p>See the “Alarm LED” section on page 1-8.</p>
3	HD1	<p>Indicates Hard Disk Drive 1 status:</p> <ul style="list-style-type: none"> • Flashing green—Proportioned to read/write activity. • Solid amber—Hard disk drive failure. • Flashing amber—Hard disk drive being rebuilt. • Off—No hard disk drive present.
4	HD0	<p>Indicates Hard Disk Drive 0 status:</p> <ul style="list-style-type: none"> • Flashing green—Proportioned to read/write activity. • Solid amber—Hard disk drive failure. • Flashing amber—Hard disk drive being rebuilt. • Off—No hard disk drive present.

Rear Panel LEDs

This section describes the rear panel LEDs for the Cisco 170 series appliance.

Figure 1-5 shows the rear panel LEDs that are available for the Cisco C170, Cisco M170 and Cisco S170 models (graphic shows the Cisco S170 rear panel).

Figure 1-5 Rear Panel LEDs for Cisco C170, Cisco M170 and Cisco S170

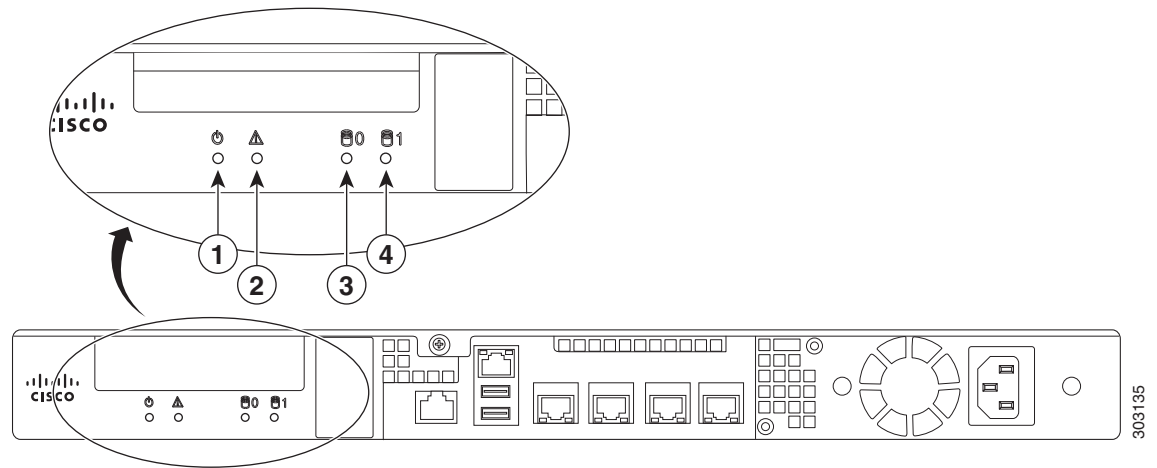

	LED	Description
1	Power	Indicates power supply status: <ul style="list-style-type: none"> • Off—Power supply off. • Solid green—Power supply on.
2	Alarm	Indicates system operating status: <ul style="list-style-type: none"> • Off—Normal operating system function. • Solid amber—Critical Alarm indicating one or more of the following: <ul style="list-style-type: none"> – A major failure of a hardware or software component. – An over-temperature condition. – The power voltage is outside of the tolerance range. See the “Alarm LED” section on page 1-8 .

	LED	Description
3	HD0	Indicates Hard Disk Drive 0 status: <ul style="list-style-type: none"> • Flashing green—Proportioned to read/write activity. • Solid amber—Hard disk drive failure. • Flashing amber—Hard disk drive being rebuilt. • Off—No hard disk drive present.
4	HD1	Indicates Hard Disk Drive 1 status: <ul style="list-style-type: none"> • Flashing green—Proportioned to read/write activity. • Solid amber—Hard disk drive failure. • Flashing amber—Hard disk drive being rebuilt. • Off—No hard disk drive present.

Rear Panel Ports

This section describes the rear panel ports on the Cisco 170 series appliance.

Figure 1-6 and Figure 1-7 show the rear panel and ports that are available on the Cisco S170 model.

Figure 1-6 Rear Panel and Ports for Cisco S170



Figure 1-7 Rear Panel Ports for Cisco S170

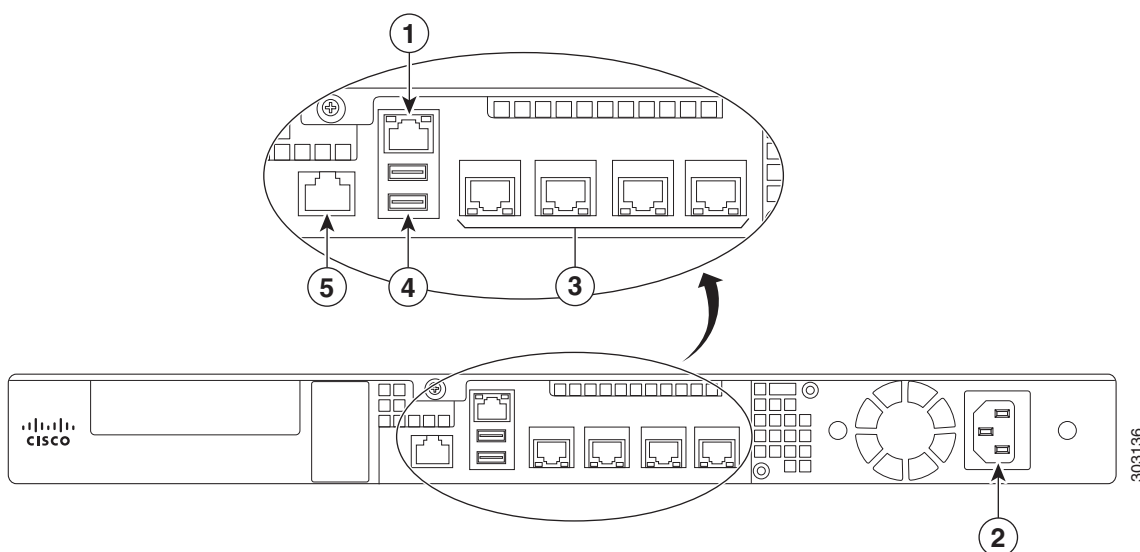

	LED	Description
1	Management interface	Indicates the Gigabit Ethernet interface that is restricted to management use only. Connect with an RJ-45 cable. See the “Management Interface” section on page 1-8.
2	Power supply	Indicates the appliance power supply.
3	RJ-45 ports	Indicates the Gigabit Ethernet customer data interfaces. The port numbers are (from left to right) P1, P2, T1 and T2.
4	USB Ports ¹	Indicates the two USB standard ports.
5	Console port	Indicates the console port that directly connects a computer to the Cisco 170 series.

1. USB ports can be used in future software releases.

Figure 1-8 and Figure 1-9 show the rear panel and ports that are available on the Cisco C170 and Cisco M170 models.

Figure 1-8 Rear Panel and Ports for Cisco C170 and Cisco M170



303155

Figure 1-9 Rear Panel Ports for Cisco C170 and Cisco M170

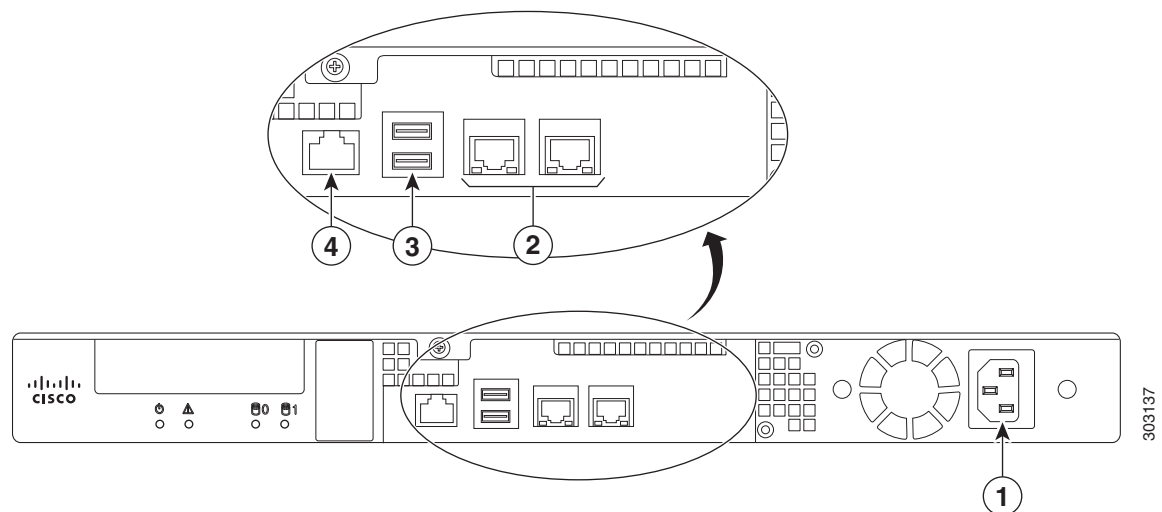

303137

	LED	Description
1	Power supply	Indicates the appliance power supply.

2	RJ-45 ports	Indicates the Gigabit Ethernet customer data interfaces. The port numbers are (from left to right) Data 1 and Data 2.
3	USB Ports ¹	Indicates the two USB standard ports.
4	Console port	Indicates the console port that directly connects a computer to the Cisco 170 series appliance.

1. USB ports can be used in future software releases.

Alarm LED

The Cisco 170 series appliance performs autonomous environment monitoring to poll all external sensors and monitor operating conditions. In the event of damage to certain internal components or surpassed temperature thresholds, the system activates an alarm LED to notify you of a critical condition. For example, the alarm LED is activated by firmware in the event of various critical over-voltage and over-temperature conditions, as well as when the Cisco 170 series appliance has missing or unrecognized internal chip components. When the alarm LED lights, contact Cisco Technical Support to find out the cause of the problem. See the “[Contacting Service and Support](#)” section on [page 4-3](#) for more information.

Management Interface

By default, the management interface is used to administer Cisco S170 and monitor Web Proxy (data) traffic. However, you can configure the management port for management use only.

You may want to do this if your organization uses a separate management network. This can increase security by ensuring no proxy traffic can reach Cisco S170 on the management interface.

When you use the management interface for management traffic only, you must configure at least one data interface for proxy traffic and define different routes for management and data traffic.

For information about configuring and using the management port to set up and manage Cisco S170, see *Cisco IronPort AsyncOS 7.5.0 User Guide for Web Security Appliances*:
http://www.cisco.com/en/US/docs/security/wsa/wsa7.5/user_guide/WSA_7.5.0_UserGuide.pdf.

Hard Disk Drives

Two hard disk drives (HDDs) in a RAID 1 configuration are pre-installed in the Cisco 170 series appliance. The HDDs are hot-swappable. For information on removing and replacing HDDs, see the “[Replacing the Hard Disk Drives](#)” section on [page 4-2](#).

Hardware and Technical Specifications

Table 1-1 contains hardware and technical specifications for the Cisco 170 series.

Table 1-1 Hardware and Technical Specifications for Cisco C170, Cisco M170 and Cisco S170

Specifications	Cisco C170	Cisco M170	Cisco S170
Physical Specifications			
Form-factor	1 RU, 14-in	1 RU, 14-in	1 RU, 14-in
Rack mountable	Yes Slide rails (standard) Brackets (spares)	Yes Slide rails (standard) Brackets (spares)	Yes Slide rails (standard) Brackets (spares)
Dimensions	1.67 x 16.9 x 15.5 in. 42.4x429x395 mm	1.67 x 16.9 x 15.5 in. 42.4x429x395 mm	1.67 x 16.9 x 15.5 in. 42.4x429x395 mm
Total Weight	26.96 lb.	26.96 lb.	26.96 lb.
Power Supply Information			
Power supply	400 watts, 100/240V	400 watts, 100/240V	400 watts, 100/240V
Redundant power supply	Not available	Not available	Not available
Processor, Memory, and Disks			
CPUs	1x2 (1 Dual Core)	1x2 (1 Dual Core)	1x2 (1 Dual Core)
Memory	4 GB	4 GB	4 GB
Disk Space and Count	250 GB, RAID 1	250 GB, RAID 1	250 GB, RAID 1
Hot Swappable Hard Disk Drives	Yes	Yes	Yes
RAID Level and Controller	RAID 1, Software	RAID 1, Software	RAID 1, Software
Interfaces			
Ethernet	2 Gigabit NICs, RJ-45	2 Gigabit NICs, RJ-45	4 Gigabit NICs, RJ-45
Speed (mbps)	10/100/1000, Auto-Negotiate	10/100/1000, Auto-Negotiate	10/100/1000, Auto-Negotiate
Duplex	Half or Full, Auto-Negotiate	Half or Full, Auto-Negotiate	Half or Full, Auto-Negotiate
Serial	1xRS-232 (RJ-45)	1xRS-232 (RJ-45)	1xRS-232 (RJ-45)
Fiber	No	No	No
USB ¹	2	2	2
Operating Conditions			
Temperature	-5°C to 45°C (23°F to 104°F)	-5°C to 45°C (23°F to 104°F)	-5°C to 45°C (23°F to 104°F)
Relative humidity	20% to 80% (noncondensing)	20% to 80% (noncondensing)	20% to 80% (noncondensing)
Altitude	3,000 ft.	3,000 ft.	3,000 ft.
Vibration	0.41Grms, at 3Hz-500Hz	0.41Grms, at 3Hz-500Hz	0.41Grms, at 3Hz-500Hz
Configuration, Logging, and Monitoring			
Web Interface	GUI-based (HTTPS)	GUI-based (HTTPS)	GUI-based (HTTPS)

Table 1-1 Hardware and Technical Specifications for Cisco C170, Cisco M170 and Cisco S170 (Continued)

Specifications	Cisco C170	Cisco M170	Cisco S170
Command Line Interface	SSH or Telnet (command based)	SSH or Telnet (command based)	SSH or Telnet (command based)
Logging	Syslog	Squid, Apache, Syslog, W3C	Squid, Apache, Syslog
Centralized Reporting	Supported	Supported	Supported
File Transfer	SCP, FTP	SCP, FTP	SCP, FTP
Configuration Files	XML-based	XML-based	XML-based
Centralized Configuration	Supported	Supported	Supported
Monitoring	SNMPv1-3, email alerts	SNMPv1-3, email alerts	SNMPv1-3, email alerts
Environmental Operating Ranges			
Total Current (A)	4.85 (max)	4.85 (max)	4.85 (max)
Input Voltage (V)	100 to 240 VAC	100 to 240 VAC	100 to 240 VAC
Operating Power (W)	400 (max)	400 (max)	400 (max)
Total Heat Dissipation (BTU/Hr)	432.6	432.6	432.6
Leakage Current (mA)	3.5	3.5	3.5
Fan Exhaust Volume (CFM)	Idle at 24°C: 12.3 Full fan speed: 34.4	Idle at 24°C: 12.3 Full fan speed: 34.4	Idle at 24°C: 12.3 Full fan speed: 34.4
Ambience Noise (bels)	Idle: 41.3 dBa Stress: 64.2 dBa max.	Idle: 41.3 dBa Stress: 64.2 dBa max.	Idle: 41.3 dBa Stress: 64.2 dBa max.
Effective MTBF (Hours)	107,356	107,356	107,356
Non-Operating Conditions			
Temperature	-25°C to 70°C (-13°F to 158°F)	-25°C to 70°C (-13°F to 158°F)	-25°C to 70°C (-13°F to 158°F)
Relative humidity	5% to 95% (noncondensing)	5% to 95% (noncondensing)	5% to 95% (noncondensing)
Altitude (m)	4,570	4,570	4,570
Vibration	1.12Grms at 3Hz-500Hz	1.12Grms at 3Hz-500Hz	1.12Grms at 3Hz-500Hz
Industry Certifications			
RoHS	Yes	Yes	Yes
Other Certifications	Safety: cULus, CB, CCC, BSMI EMC: CE, FCC, VCCI, CTICK, KC	Safety: cULus, CB, CCC, BSMI EMC: CE, FCC, VCCI, CTICK, KC	Safety: cULus, CB, CCC, BSMI EMC: CE, FCC, VCCI, CTICK, KC

1. USB ports can be used in future software releases.



CHAPTER 2

Preparing for Installation

This chapter describes the steps to follow before installing the Cisco 170 series appliance or performing hardware maintenance. It includes the following sections:

- [Installation Overview, page 2-1](#)
- [Safety Recommendations, page 2-2](#)
- [General Site Requirements, page 2-4](#)

Installation Overview

To prepare for the installation of the Cisco 170 series appliance, perform the following steps:

-
- Step 1** Review the safety precautions outlined in the *Safety and Compliance Guide for the Cisco Content Security Appliances* and follow proper safety procedures when performing any tasks in this guide. See: <http://www.cisco.com/en/US/docs/security/esa/hw/SafetyAndComplianceGuide.pdf>.
 - Step 2** Read the appropriate release notes for the Cisco C170 Email Security Appliance (Cisco C170), Cisco M170 Content Security Management Appliance (Cisco M170), and Cisco S170 Web Security Appliance (Cisco S170) appliances.
 - Step 3** Unpack the appliance and the accessory kit that accompanies it.
 - Step 4** Place the appliance on a stable work surface.
 - Step 5** Mount the appliance with the provided slide rails using the information in the “[Installing the Cisco 170 Series Appliance with Slide Rails](#)” section on page 3--1.



Note Optionally, you can also mount the appliance in a rack using the information in the “[Rack Mounting the Cisco 170 Series Appliance](#)” section on page 3-8.

- Step 6** Establish network connectivity using the information in the “[Connecting the Interface Cables and Verifying Connectivity](#)” section on page 3-10.
- Step 7** For additional information on pre-installation and post-installation tasks, see the following Hardware Quick Start Guides:
 - *Cisco C170 Email Security Appliance Quick Start Guide*:
http://www.cisco.com/en/US/docs/security/esa/hw/C170_QSG.pdf

- *Cisco M170 Content Security Management Appliance Quick Start Guide:*
http://www.cisco.com/en/US/docs/security/security_management/sma/hw/quick_start/M170_QSG.pdf
- *Cisco S170 Web Security Appliance Quick Start Guide:*
http://www.cisco.com/en/US/docs/security/wsa/hw/S170_QSG.pdf

Safety Recommendations

Use the following guidelines and the information in the following sections to help ensure your safety and protect the Cisco 170 series appliance. The list of guidelines may not address all potentially hazardous situations in your working environment, so be alert and exercise good judgement at all times.



Note

Removing and replacing the hard disk drives (HDDs) in the appliance as described in “[Removing and Installing Hard Disk Drives](#)” section on page 4-1 does not affect your Cisco warranty.

Observe the following safety guidelines:

- Keep the appliance area clear and dust-free before, during, and after installation.
- Keep tools away from walk areas in which you and others might fall over them.
- Do not wear loose clothing or jewelry, such as earrings, bracelets, or chains that could get caught in the appliance.
- Wear safety glasses if you are working under any conditions that might be hazardous to your eyes.
- Do not perform any action that creates a potential hazard to people or makes the equipment unsafe.
- Never attempt to lift an object that is too heavy for one person to handle.

This section includes the following topics:

- [Maintaining Safety with Electricity](#), page 2-2
- [Preventing Electrostatic Discharge Damage](#), page 2-3
- [Working in an ESD Environment](#), page 2-3

Maintaining Safety with Electricity



Warning

Before working on a chassis or working near power supplies, unplug the power cord on AC units.
Statement 12

Follow these guidelines when working on equipment powered by electricity:

- Locate the emergency power-off switch for the room in which you are working. If an electric accident occurs, you can quickly turn off the power.
- Do not work alone if potentially hazardous conditions exist anywhere in your work space.
- Never assume that power is disconnected from a circuit; always check the circuit.
- Look carefully for possible hazards in your work area, such as moist floors, ungrounded power extension cables, frayed power cords, and missing safety grounds.

- If an electrical accident occurs, proceed as follows:
 - Use caution; do not become a victim yourself.
 - Disconnect power from the system.
 - If possible, send another person to get medical aid. Otherwise, assess the condition of the victim, and then call for help.
 - Determine whether or not the person needs rescue breathing or external cardiac compressions; then take appropriate action.
- Use the Cisco 170 series appliance within its marked electrical ratings and product usage instructions.
- Install the Cisco 170 series appliance in compliance with local and national electrical codes as listed in the *Safety and Compliance Guide for the Cisco Content Security Appliances* document.
- The Cisco 170 series appliance is equipped with AC-input power supplies and is shipped with a 3-wire electrical cord with a grounding-type plug that fits into a grounding-type power outlet only. Do not circumvent this safety feature. Equipment grounding should comply with local and national electrical codes.

Preventing Electrostatic Discharge Damage

Electrostatic discharge (ESD) can damage equipment and impair electrical circuitry. ESD damage occurs when electronic components are improperly handled and can result in complete or intermittent failures.

- Always follow ESD-prevention procedures when removing and replacing components. Ensure that the appliance is electrically connected to an earth ground. Wear an ESD-preventive wrist strap, ensuring that it makes good skin contact. Connect the grounding clip to an unpainted surface of the appliance frame to safely ground ESD voltages. To properly guard against ESD damage and shocks, the wrist strap and cord must operate effectively. If no wrist strap is available, ground yourself by touching the metal part of the appliance.
- For safety, periodically check the resistance value of the antistatic strap, which should be between 1 and 10 megohms (Mohms).

Working in an ESD Environment

- Electrostatic discharge (ESD) can damage equipment and impair electrical circuitry. ESD damage occurs when electronic components are improperly handled and can result in complete or intermittent failures. Always follow ESD-prevention procedures when you remove and replace components. Ensure that the appliance is electrically connected to earth ground. Wear an ESD-preventive wrist strap, ensuring that it makes good skin contact. Connect the grounding clip to an unpainted surface of the appliance frame to safely ground unwanted ESD voltages. To guard against ESD damage and shocks, the wrist strap and cord must operate properly. If no wrist strap is available, ground yourself by touching the metal part of the appliance.

General Site Requirements

The topics in this section describe the requirements your site must meet for safe installation and operation of your Cisco 170 series system. Ensure that your site is properly prepared before beginning installation.

This section includes the following topics:

- [Site Environment, page 2-4](#)
- [Preventive Site Configuration, page 2-4](#)
- [Power Supply Considerations, page 2-5](#)
- [Configuring Equipment Racks, page 2-7](#)

Site Environment

Place the appliance on a desktop or mount it on a rack. The location of the appliance and the layout of the equipment rack or wiring room are extremely important for proper system operation. Placing equipment too close together with inadequate ventilation and inaccessible panels can cause system malfunctions and shutdowns. Improper placement can also make it difficult for you to access the appliance for maintenance.

For information about physical specifications, see the [“Hardware and Technical Specifications” section on page 1-9](#).

When planning the site layout and equipment locations, keep in mind the precautions described in the next section [“Preventive Site Configuration, page 2-4,”](#) to help avoid equipment failures and reduce the possibility of environmentally caused shutdowns. If you are currently experiencing shutdowns or unusually high error rates with your existing equipment, these precautions may help you isolate the cause of failures and prevent future problems.

Preventive Site Configuration

The following precautions will help plan an acceptable operating environment for the appliance and avoid environmentally caused equipment failures:

- Electrical equipment generates heat. Ambient air temperature might not be adequate to cool equipment to acceptable operating temperatures without adequate circulation. Ensure that the room in which you operate your system has adequate air circulation.
- Always follow the ESD-prevention procedures described previously to avoid damage to equipment. Damage from static discharge can cause immediate or intermittent equipment failure.
- Ensure that the appliance cover is secure. The appliance is designed to allow cooling air to flow effectively within it. An open appliance allows air leaks, which may interrupt and redirect the flow of cooling air from the internal components.

Power Supply Considerations

The Cisco 170 series hardware operates on AC power and supports the ability to restore the previous power state of the system in the event that AC power is lost. Be aware of the following when interacting with system hardware:

- The Cisco 170 series appliance requires 50 seconds from the time that AC power is applied before the power state can be updated and stored. This means that any changes to the power state within the first 50 seconds of applying AC power will not be observed if AC power is removed within that time.
- The Cisco 170 series appliance requires 10 seconds from the time it is placed into standby mode before the power state can be updated and stored. This means any changes to the power state within the first 10 seconds of entering standby mode (including the standby mode itself) will not be observed if AC power is removed within that time.

Observe the following considerations:

- Check the power at the site before installing the appliance to ensure that the power is “clean” (free of spikes and noise). Install a power conditioner, if necessary, to ensure proper voltages and power levels in the source voltage.
- Install proper grounding for the site to avoid damage from lightning and power surges.
- The Cisco 170 series appliance does not have a user-selectable operating range. Refer to the label on the appliance for the correct AC-input power requirement.
- Several styles of AC-input power supply cords are available; make sure that you have the correct style for your site.
- Install an uninterruptible power source for your site, if possible.

You also need to provide power to the switch with the appropriate AC power cord for your location. [Table 2-1](#) lists the power cords that are used with the AC power supply.

Table 2-1 AC-Input Power Cord Options







Locale	Part Number	Length	Plug Rating	Plug Type
Appliance Coupler				
300 W AC Power Supply				 120352
North America	CAB-AC (72-0259)	8.2 ft (2.5 m)	125 VAC, 10 A	 120354
Australia,	CAB-ACA (72-0746-01)	8.2 ft (2.5 m)	250 VAC, 10 A	 120356
Europe (except Italy)	CAB-ACE (72-0460)	8.2 ft (2.5 m)	250 VAC, 10 A	 120357

Table 2-1 AC-Input Power Cord Options (Continued)

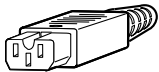
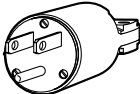
Locale	Part Number	Length	Plug Rating	Plug Type
Italy	CAB-ACI 72-0556	8.2 ft (2.5 m)	250 VAC, 10 A	 120358
Singapore United Kingdom	CAB-ACU 72-0557	8.2 ft (2.5 m)	250 VAC, 10 A	 120359
Argentina	CAB-ACR (37-0995-01)	8.2 ft (2.5 m)	250 VAC, 10 A	 120356
Switzerland	CAB-ACS (72-1483-01)	8.2 ft (2.5 m)	250 VAC, 10 A	 251247
Japan	CAB-JPN (72-1925-01)	8.2 ft (2.5 m)	250 VAC, 10 A	 251248
India	CAB-IND-10A (37-0863-01)	8.2 ft (2.5 m)	250 VAC, 10 A	 331705
South Africa	AIR-PWR-CORD-S A (37-0346-01)	8.2 ft (2.5 m)	250 VAC, 10 A	 331706

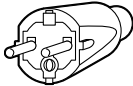
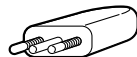
Configuring Equipment Racks

The following tips help you plan an acceptable equipment rack configuration:

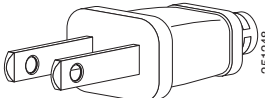
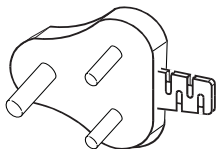
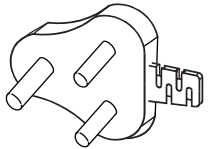
- Enclosed racks must have adequate ventilation. Ensure that the rack is not overly congested because each appliance generates heat. An enclosed rack should have louvered sides and a fan to provide cooling air.
- When mounting a appliance in an open rack, ensure that the rack frame does not block the intake or exhaust ports. If the appliance is installed on slides, check the position of the appliance when it is seated all the way into the rack.
- In an enclosed rack with a ventilation fan in the top, excessive heat generated by equipment near the bottom of the rack can be drawn upward and into the intake ports of the equipment above it in the rack. Ensure that you provide adequate ventilation for equipment at the bottom of the rack.
- Baffles can help to isolate exhaust air from intake air, which also helps to draw cooling air through the appliance. The best placement of the baffles depends on the airflow patterns in the rack. Experiment with different arrangements to position the baffles effectively.



CHAPTER 3

Installing and Connecting the Cisco 170 Series Appliance

This chapter describes how to install the Cisco 170 series (Cisco 170 series) appliance using slide rails (standard configuration) or rack-mounting it (optional configuration) and provides information on how to connect the interface cables.

It includes the following sections:

- [Installing the Cisco 170 Series Appliance with Slide Rails, page 3--1](#)
- [Rack Mounting the Cisco 170 Series Appliance, page 3-8](#)
- [Connecting the Interface Cables and Verifying Connectivity, page 3-10](#)

Installing the Cisco 170 Series Appliance with Slide Rails

To install the Cisco 170 series using slide rails, perform the steps in this section.

This section includes the following topics:

- [Verifying the Box Contents, page 3--1](#)
- [Disassembling the Slide Rail, page 3-0](#)
- [Attaching Inner Rails to the Appliance, page 3-1](#)
- [Verifying the Rack Type, page 3-2](#)
- [Securing Round Hole Racks, page 3-3](#)
- [Securing Threaded Hole Racks, page 3-3](#)
- [Attaching the Outer Slide Rail to Round and Square Hole Racks, page 3-4](#)
- [Attaching the Outer Slide Rail to Threaded Hole Racks, page 3-5](#)
- [Installing the Appliance, page 3-6](#)
- [Securing the Appliance, page 3-7](#)

Verifying the Box Contents

- Step 1** Remove the contents from the box and verify that it contains the following items for all rack types (see [Figure 3-1](#)):

- A—Slide rails (x2) (preconfigured for square hole racks)
- B— Phillips flat-head screws for Inner Slide (x2)

For round hole racks, you also need the following:

- C—Round hole inserts (x4)
- Phillips screwdriver

For threaded hole racks, you also need the following:

- D—Threaded hole brackets (x2)
- E—Threaded hole standoffs (x2)
- F—Phillips pan-head screws for threaded hole racks (x8)
- Flat-head screwdriver

Figure 3-1 Appliance Box Contents

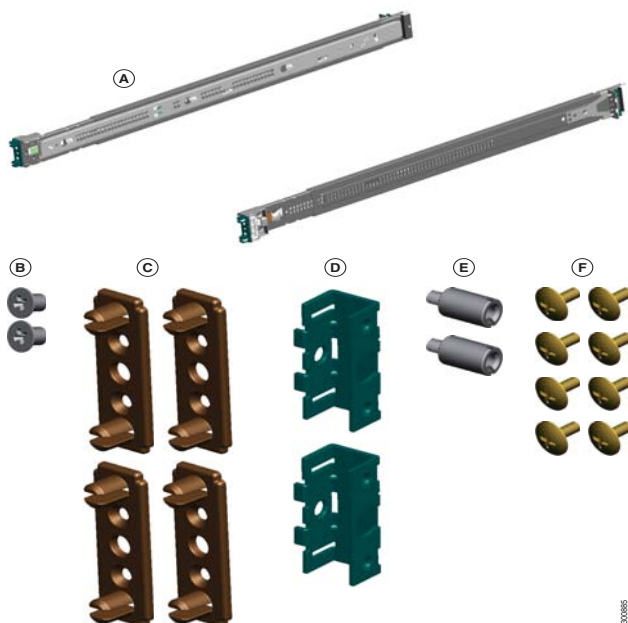

Note

By default, the slide rails are shipped with the appliance. If you have a 2-post rack, you can order rack mounts, which are available as spares for the Cisco 170 series appliance.

Disassembling the Slide Rail

- Step 1** Pull the inner slide rail from the outer slide rail.

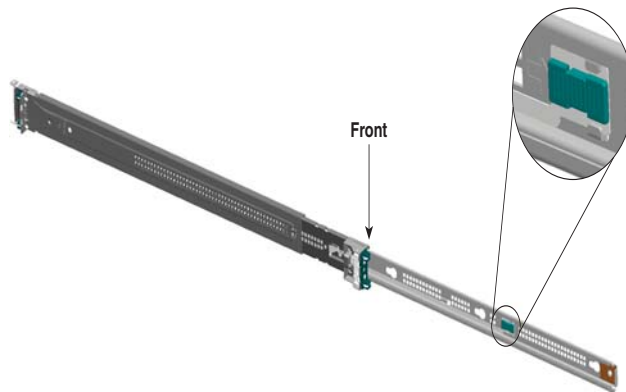

Step 2 Slide the plastic tab forward, and pull the inner slide rail to disconnect it from the outer slide rail.



Step 3 Repeat the previous steps for the other slide rail.

Attaching Inner Rails to the Appliance

Step 1 Align one of the inner slide rail key holes over the appliance shoulder screw on one side. Slide the inner slide rail forward so that the shoulder screw is securely in place.



- Step 2** Use a Phillips screwdriver to secure the inner slide rail with one Phillips flat-head screw (See B in [Figure 3-1](#)).



- Step 3** Secure the other inner slide rail to the appliance by repeating the previous steps.



Verifying the Rack Type

- Step 1** The slide rails are pre-assembled for square hole racks. Use the following steps for the different rack types:
- For square hole racks, see the [“Attaching the Outer Slide Rail to Round and Square Hole Racks”](#) section on page 3-4.
 - For round hole racks, see the [“Securing Round Hole Racks”](#) section on page 3-3.
 - For threaded hole racks, see the [“Securing Threaded Hole Racks”](#) section on page 3-3.

The following figure shows the slide rail with square hole rack inserts.



Securing Round Hole Racks

- Step 1** Using a Phillips head screwdriver, remove the square insert from the rear of the rail. Retain the two Phillips head screws.



- Step 2** Remove the square insert from the front of the rail. Retain the two Phillips head screws.



- Step 3** Align the round hole insert (see C in [Figure 3-1](#)) to the rear of the rail, and secure it with two of the saved screws.



- Step 4** Align the round hole insert (see C in [Figure 3-1](#)) to the front of the rail over the hooks, and secure it with two of the saved screws.

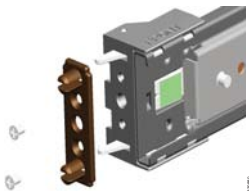

- Step 5** Proceed to the [“Attaching the Outer Slide Rail to Round and Square Hole Racks”](#) section on page 3-4.

Securing Threaded Hole Racks

- Step 1** Using a Phillips head screwdriver, remove the square hole insert from the rear of the rail.

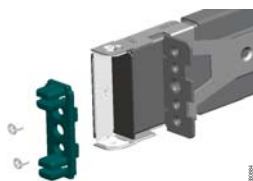

Step 2 Remove the square hole insert from the front of the rail.

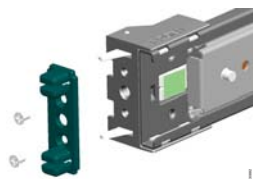

Step 3 Align the threaded hole bracket (see D in [Figure 3-1](#)) to the front of the rail over the hooks. Secure it with the threaded hole standoff (see E in [Figure 3-1](#)) using a flat-head screwdriver.



Step 4 No additional hardware is necessary for the rear adapter.

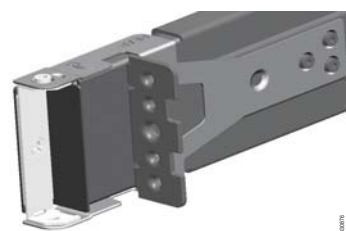

Step 5 Repeat the previous steps page for the other slide rail.

Step 6 Proceed to the [“Attaching the Outer Slide Rail to Threaded Hole Racks”](#) section on page 3-5.

Attaching the Outer Slide Rail to Round and Square Hole Racks

Step 1 Align the front of one of the outer slide rails with the rack upright, push it forward, and click it into place. Align the rear of the outer slide rail with the rack upright, pull the release tab, push the slide rail toward the rack, release the tab, and click it into place.



Note

For racks shorter than 24 inches in depth, remove the rear bracket with a Phillips head screwdriver, pull the release tab, and adjust the slide rail to the appropriate length for the rack.

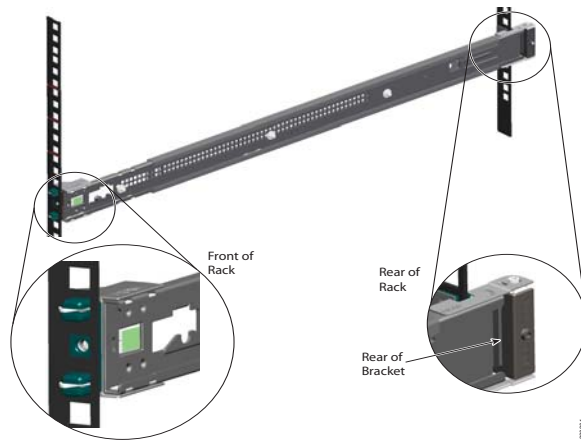

Step 2 Secure the other outer slide rail to the rack by repeating the previous steps.



Step 3 Proceed to the [“Installing the Appliance”](#) section on page 3-6.

Attaching the Outer Slide Rail to Threaded Hole Racks

Step 1 Align the slide rail to the front rack post. Secure it with two of the included Phillips pan-head screws (see F in [Figure 3-1](#)).

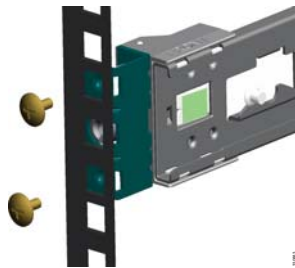

- Step 2** Align the slide rail to the rear rack post. Secure it with two of the included Phillips pan-head screws (see F in [Figure 3-1](#)).

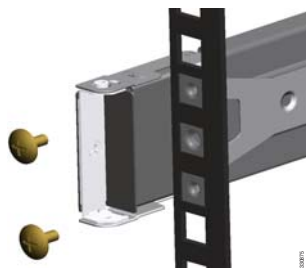

- Step 3** Align the other slide rail to the rack by repeating the previous steps.



- Step 4** Proceed to the [“Installing the Appliance”](#) section on page 3-6.
-

Installing the Appliance

- Step 1** Align the inner slide rails to the outer slide rails. Install the inner slide rails into the outer slide rails until they lock into place.

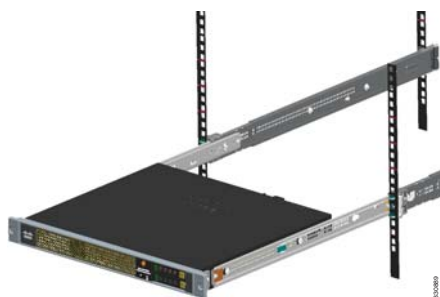

Step 2 Pull the side release tabs to unlock the inner slide rail and push the appliance assembly into the rack.

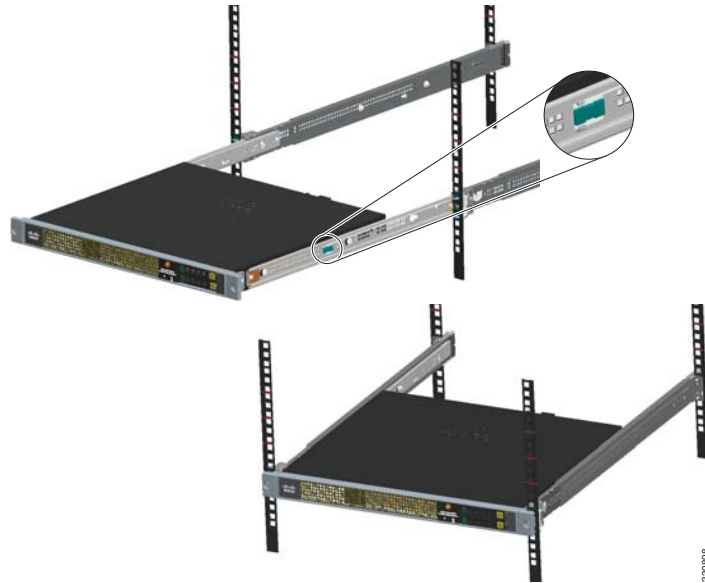

Securing the Appliance

Step 1 Secure the appliance to the rack with the front captive screws.

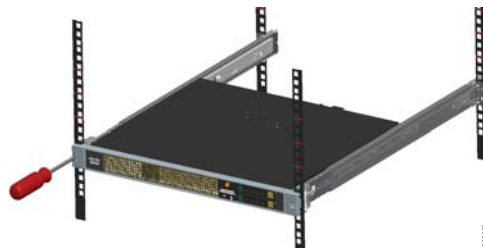

Rack Mounting the Cisco 170 Series Appliance

If you have 2-post racks, you can order the rack mount spares to rack-mount the Cisco 170 series appliance as described in this section.

This section contains the following topics:

- [Guidelines and Recommendations, page 3-8](#)
- [Rack Mounting the Cisco C170, Cisco M170, or Cisco S170 Appliances, page 3-8](#)

Guidelines and Recommendations



Warning

To prevent bodily injury when mounting or servicing this unit in a rack, you must take special precautions to ensure that the system remains stable. The following guidelines are provided to ensure your safety: This unit should be mounted at the bottom of the rack if it is the only unit in the rack. When mounting this unit in a partially filled rack, load the rack from the bottom to the top with the heaviest component at the bottom of the rack. If the rack is provided with stabilizing devices, install the stabilizers before mounting or servicing the unit in the rack. Statement 1006

The following information can help plan equipment rack installation:

- Allow clearance around the rack for maintenance.
- If the rack contains stabilizing devices, install the stabilizers prior to mounting or servicing the unit in the rack.
- When mounting a device in an enclosed rack, ensure adequate ventilation. Do not overcrowd an enclosed rack. Make sure that the rack is not congested, because each unit generates heat.
- When mounting a device in an open rack, make sure that the rack frame does not block the intake or exhaust ports.
- If the rack contains only one unit, mount the unit at the bottom of the rack.
- If the rack is partially filled, load the rack from the bottom to the top, with the heaviest component at the bottom of the rack.

Rack Mounting the Cisco C170, Cisco M170, or Cisco S170 Appliances

To install the Cisco C170, Cisco M170, or Cisco S170 appliances in a rack perform the following steps:

-
- Step 1** Remove the preinstalled die-cast brackets on either side of the appliance by removing the three screws that hold each bracket in place. See [Figure 3-2](#).

Figure 3-2 *Removing Preinstalled Die-Cast Brackets on Either Side of the Appliance*



- Step 2** Install a fixed rack-mount bracket to both sides of the appliance by aligning the screw holes on the appliance to the slots and holes on the bracket. The bracket will be set back from the front faceplate (bezel). Secure each bracket with three screws. See [Figure 3-3](#).

Figure 3-3 *Attaching the Rack-Mount Brackets*



- Step 3** Install the appliance with the front bezel facing the cold aisle so that air flows from front to back. See [Figure 3-4](#).

Figure 3-4 Attaching the C170, M170, or S170 Appliance to the Rack

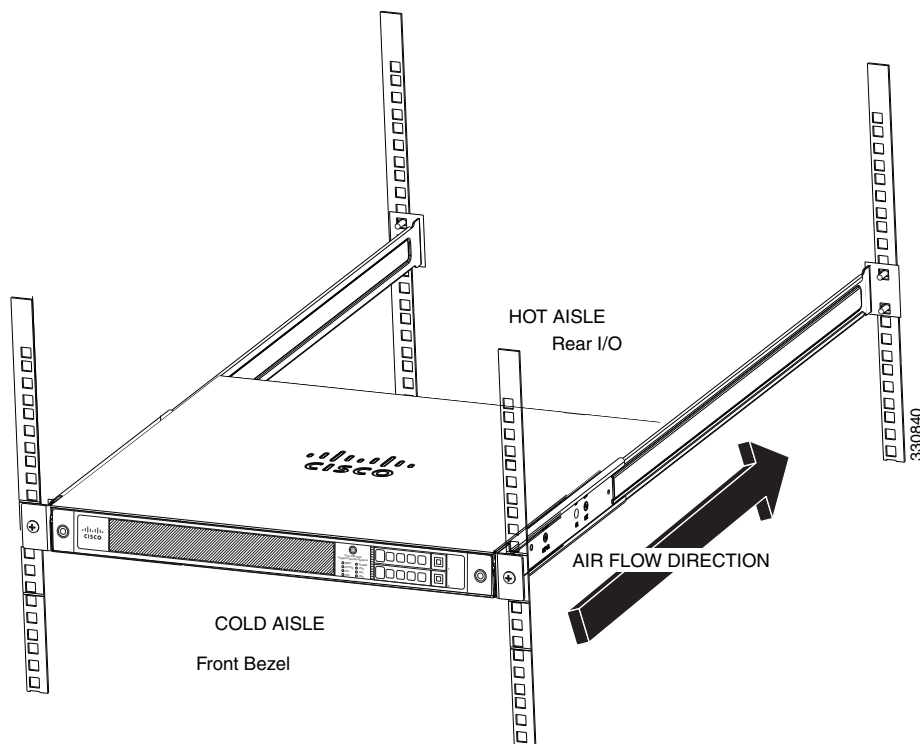

Connecting the Interface Cables and Verifying Connectivity

This section describes how to connect the cables to the Console, Auxiliary, and Management ports.



Warning

Only trained and qualified personnel should install, replace, or service this equipment. Statement 49



Caution

Read the safety warnings in the *Safety and Compliance Guide for the Cisco Content Security Appliances* and follow proper safety procedures when performing any tasks in this document. See: <http://www.cisco.com/en/US/docs/security/esa/hw/SafetyAndComplianceGuide.pdf>.

To connect cables to the ports, perform the following steps:

- Step 1** Place the appliance on a flat, stable surface, or in a rack (if you are rack-mounting it).
- Step 2** Before connecting a computer or terminal to the ports, determine the baud rate of the serial port. The baud rate must match the default baud rate (9600 baud) of the Console port of the Cisco 170 series appliance. Set up the terminal as follows: 9600 baud (default), 8 data bits, no parity, 1 stop bits, and Flow Control (FC) = Hardware.
- Step 3** Connect the cables to the ports.
 - a. Management port—for use with the Cisco S170 Web Security Appliance (Cisco S170).

For more information, see [Figure 1-7 on page 1-6](#) for an illustration of the port in the Cisco S170 model appliance.

- Connect one RJ-45 connector to the management interface port.
- Connect the other end of the Ethernet cable to the management port on your computer and make sure that your computer is configured to obtain an IP address using DHCP.

b. Console port—for use with the CLI.

- Connect the serial console cable. The console cable has a DB-9 connector on one end for the serial port on your computer and the other end is an RJ-45 connector.
- Connect the RJ-45 connector to the Console port on the Cisco 170 series appliance.
- Connect the other end of the cable, the DB-9 connector, to the console port on your computer.

c. Ethernet ports—direct connection.

- Connect the RJ-45 connector to the Ethernet port.
- Connect the other end of the Ethernet cable to your network device, such as a router, switch, or hub.

Step 4 Connect the power cord to the Cisco 170 series appliance and connect the other end to your power source.

Step 5 Power on the appliance.

Step 6 Check the Power LED on the front of the Cisco 170 series appliance. When it is solid green, the appliance is powered on.

For additional information on installation and post-installation tasks, see the following Hardware Quick Start Guides:

- *Cisco C170 Email Security Appliance Quick Start Guide:*
http://www.cisco.com/en/US/docs/security/esa/hw/C170_QSG.pdf
 - *Cisco M170 Content Security Management Appliance Quick Start Guide:*
http://www.cisco.com/en/US/docs/security/security_management/sma/hw/quick_start/M170_QSG.pdf
 - *Cisco S170 Web Security Appliance Quick Start Guide:*
http://www.cisco.com/en/US/docs/security/wsa/hw/S170_QSG.pdf
-



CHAPTER 4

Maintaining the Cisco 170 Series Appliance

This chapter provides maintenance information about the Cisco 170 series appliance, including information on how to replace the pre-installed hard disk drives (HDDs).

This chapter includes the following sections:

- [Fixed AC Power Supply, page 4-1](#)
- [Removing and Installing Hard Disk Drives, page 4-1](#)
- [Contacting Service and Support, page 4-3](#)

Fixed AC Power Supply

The Cisco 170 series appliance ships with one fixed power supply (AC) installed. You cannot add additional power supplies or remove the installed AC power supply. Removing the only power supply causes an immediate power loss.

There is not an input switch on the faceplate of the power supply. The power supply is switched from Standby to ON by way of a appliance STANDBY/ON switch.

The AC power supply provides 400 watt output power. The AC power supply operates between 85 and 264 VAC. The AC power supply consumes a maximum of 471 W of input power.



Note

If your power supply is non-operational, please contact Cisco Technical Support. See the [“Contacting Service and Support”](#) section on page 4-3 for more information.

Removing and Installing Hard Disk Drives

This section contains the following topics:

- [Maintenance Scenarios, page 4-2](#)
- [Replacing the Hard Disk Drives, page 4-2](#)

Maintenance Scenarios

Note

Make sure that you replace the Cisco 170 series HDDs with Cisco supplied HDDs that are specific to and preconfigured for the Cisco 170 series appliance. Please contact Cisco Technical Support for more information or in case of an Return Merchandise Authorization (RMA). See the “[Contacting Service and Support](#)” section on page 4-3.

You may need to install, remove, or replace a HDD in your Cisco 170 series appliance under the following conditions:

- If a single drive fails, you can replace the failed drive. You can hot-swap the failed drive.
- If both drives fail simultaneously, you need to return the entire system via an RMA.

Note

When you replace a drive, the disk indicator light is a blinking amber indicating a rebuild event. Once the rebuild is completed, the disk indicator light changes to a flashing green.

Replacing the Hard Disk Drives

The Cisco 170 series appliance has two HDDs in a RAID 1 configuration. If one of the HDDs fails, you can remove and install a new HDD.

Caution

Make sure that you replace the failed hard disk drive as soon as possible; otherwise, if the remaining hard disk drive fails, all your data is lost.

To remove and install (replace) hard disk drives in the Cisco 170 series appliance, follow these steps:

- Step 1** From the front panel of the Cisco 170 series appliance, remove the hard disk drive by pressing the button on the right side of the bay until the lever is released. Pull out the hard disk drive.

[Figure 4-1](#) shows the Cisco 170 series appliance with two HDDs.

Figure 4-1 *Removing a HDD from the Cisco 170 Series Appliance*

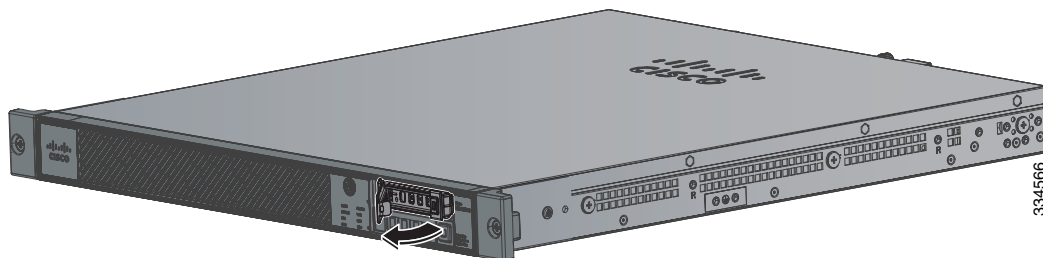

- Step 2** On the front panel of the Cisco 170 series appliance, line up the hard disk drive carrier with the hard disk drive bay and push it in until it is seated. Push the lever into place.

Figure 4-2 shows the Cisco 170 series appliance with one HDD being inserted.

Figure 4-2 *Installing a HDD in the Cisco 170 Series Appliance*

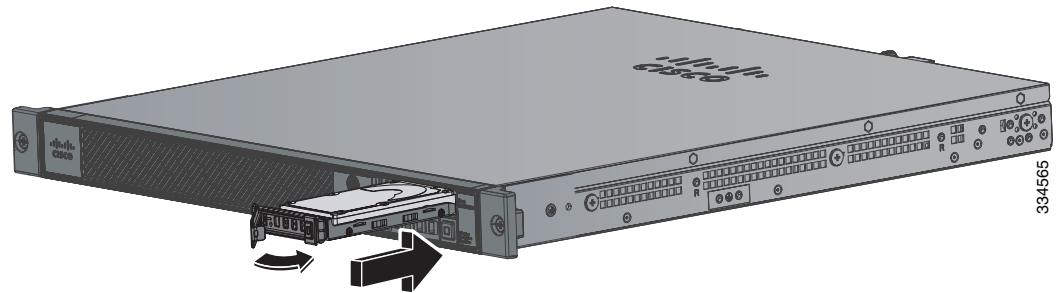

- Step 3** On the front panel of the Cisco 170 series appliance, make sure the HDD1 and HDD0 indicators are flashing green to indicate that the hard disk drives are now active.
-

Contacting Service and Support

If you experience problems with the fixed power supply, with removing and replacing the hard disk drives in the Cisco 170 series appliance, or in case of an RMA, you can request our support by phone, email, or online 24 hours a day, 7 days a week at:

http://www.cisco.com/cisco/web/support/index.html#~shp_contact

During customer support hours (24 hours per day, Monday through Friday excluding U.S. holidays), an engineer will contact you within an hour of your request.





APPENDIX **A**

Identifying Cable Pinouts

This appendix describes pinout information for the 10/100/1000BaseT ports and the RJ-45 to DB-9 ports, and the RJ-45 cables for the console port.

This chapter includes the following sections:

- [10/100/1000BaseT Connectors, page A-1](#)
- [Console Port \(RJ-45\), page A-2](#)
- [RJ-45 to DB-9, page A-3](#)

10/100/1000BaseT Connectors

The Cisco 170 series appliance supports 10/100/1000BaseT ports. You must use at least a Category 5 cable for 100/1000baseT operations, but a Category 3 cable can be used for 10BaseT operations.

The 10/100/1000BaseT ports use standard RJ-45 connectors and support MDI and MDI-X connectors. Ethernet ports normally use MDI connectors, and Ethernet ports on a hub normally use an MDI-X connector.

Use an Ethernet straight-through cable to connect an MDI to an MDI-X port. Use a cross-over cable to connect an MDI to an MDI port, or an MDI-X to an MDI-X port.

[Figure A-1](#) shows the 10BaseT, 100BaseTX, and 1000BASE-T connector (RJ-45).

Figure A-1 10/100/1000 Port Pinouts

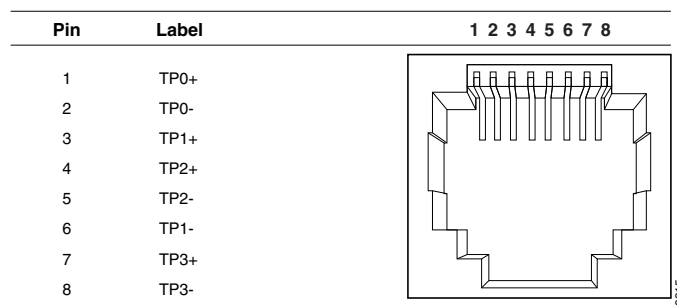

Console Port (RJ-45)

Cisco products use the following types of RJ-45 cables:

- Straight-through
- Crossover

Note

Cisco does not provide these cables, yet they are widely available from other sources.

Figure A-2 shows the RJ 45 cable.

Figure A-2 RJ-45 Cable

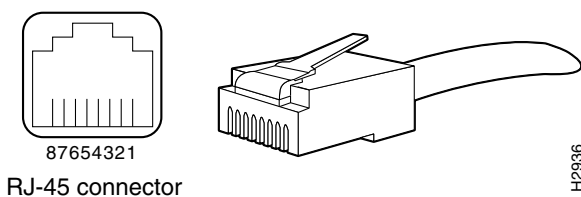

To identify the RJ-45 cable type, hold the two ends of the cable next to each other so that you can see the colored wires inside the ends, as shown in Figure A-3.

Figure A-3 RJ-45 Cable Identification

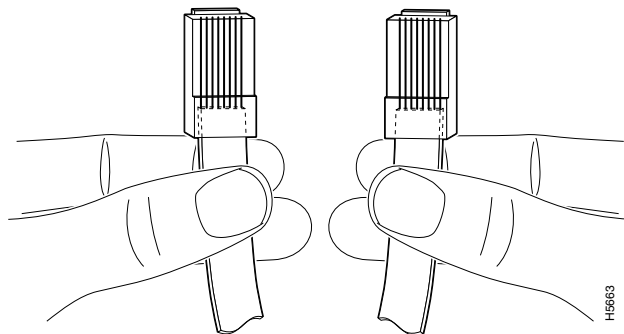

Examine the sequence of colored wires to determine the type of RJ-45 cable, as follows:

- Straight-through—The colored wires are in the same sequence at both ends of the cable.
- Crossover—The first (far left) colored wire at one end of the cable is the third colored wire at the other end of the cable.

Table A-1 lists the rolled (console) cable pinouts for RJ-45.

Table A-1 RJ-45 Rolled (Console) Cable Pinouts

Signal	Pin	Pin	Pin
-	1	8	-
-	2	7	-
-	3	6	-

Table A-1 *RJ-45 Rolled (Console) Cable Pinouts (Continued)*

Signal	Pin	Pin	Pin
-	4	5	-
-	5	4	-
-	6	3	-
-	7	2	-
-	8	1	-

RJ-45 to DB-9

[Table A-2](#) lists the cable pinouts for RJ-45 to DB-9.

Table A-2 *Cable Pinouts for RJ-45 to DB-9*

Signal	RJ-45 Pin	DB-9 Pin
RTS	1	7
DTR	2	4
TxD	3	3
GND	4	5
GND	5	5
RxD	6	2
DSR	7	6
CTS	8	8

