







16	Applications button 	Opens/closes the Applications menu. Depending on how your system administrator sets up the phone, use it to access applications such as call history, preferences, and phone information.
17	Contacts button 	Opens/closes the Contacts menu. Depending on how your system administrator sets up the phone, use it to access personal directory, corporate directory, or call history.
18	Phone display	Phone display that can be positioned to your preferred viewing angle.
19	Programmable feature buttons 	<p>Programmable feature buttons that correspond to phone lines, speed dials, and calling features.</p> <p>Pressing a button for a phone line displays the active calls for that line. If you have multiple lines, you might have an All Calls feature button that displays a consolidated list of calls from all lines.</p> <p>Color LEDs indicate the line state:</p> <ul style="list-style-type: none"> • Amber  —Ringing call on this line • Green  —Active or held call on this line • Red  —Shared line in-use remotely <p>(The position of programmable feature buttons may be reversed with that of session buttons on phones using a locale with a right-to-left reading orientation, such as Hebrew and Arabic.)</p>
20	Handset with light strip	The handset light strip lights up to indicate a ringing call (flashing red) or a new voice message (steady red).

Phone Screen

How your system administrator sets up the phone determines what is displayed on your phone screen.

Phone with Single Line

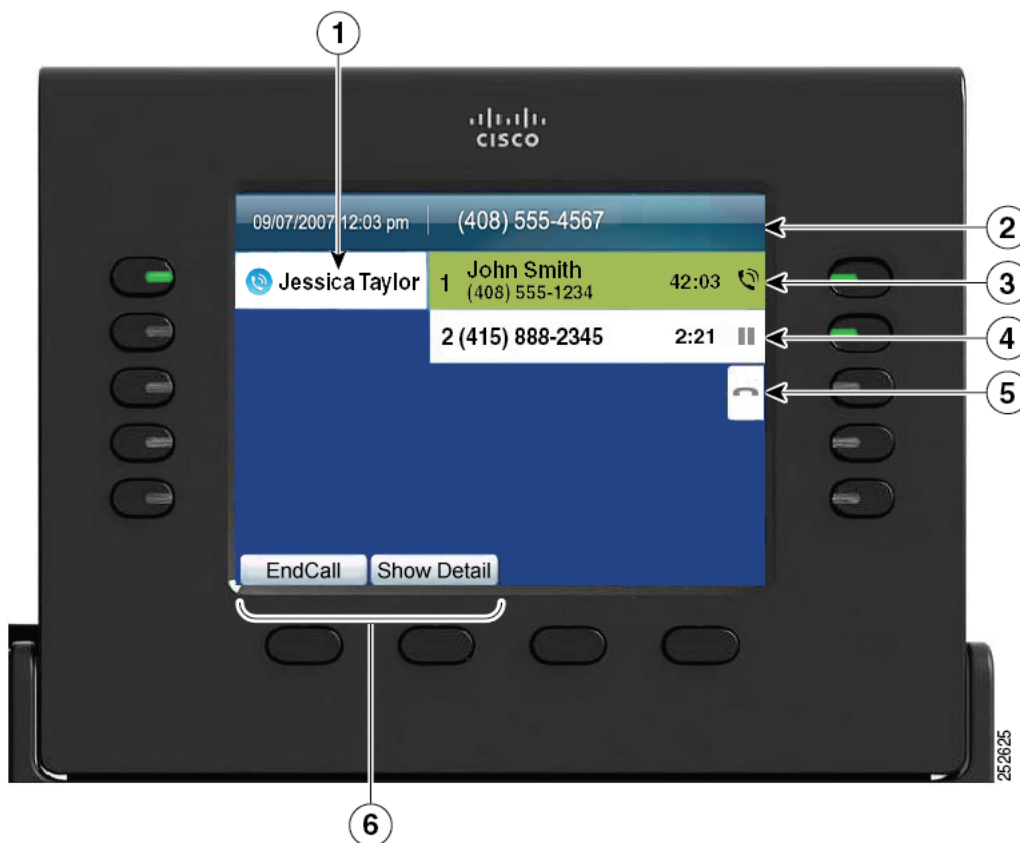

1	Line label	Displays the line phone information.
2	Header	Displays the date and time, and information (such as phone number) about the selected line.
3	Session button label (for connected call)	Displays information (such as phone number and duration) about a connected call on the line.

4	Session button label (for held call)	Displays information (such as phone number and duration) about a held call on the line. Pressing the corresponding session button resumes the held call.
5	New Call icon	Indicates you can press the corresponding session button to make a new call.
6	Softkeys	Softkey options for the selected (highlighted) call only. If you select a different call (by pressing a feature button or the Navigation pad, or by answering a ringing call), the softkey options may change.

Phone with Multiple Lines

If you have multiple lines, it is highly recommended that the All Calls feature is enabled on your phone. All Calls allows you to view all the calls on all lines at the same time. For more information, see your system administrator.

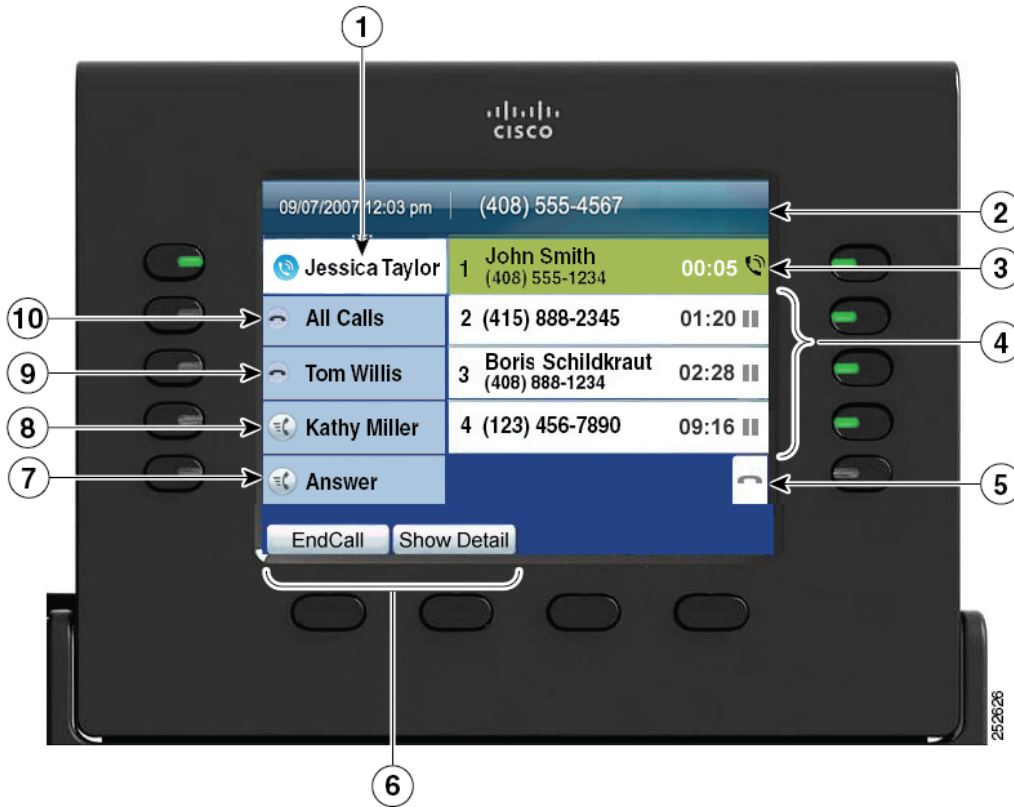

1	Primary line label	Displays the primary line phone information. In this example, the blue icon (for Connected Call) indicates this is the selected line.
2	Header	Displays the date and time, and information (such as phone number) about the selected line.
3	Session button label (for a connected call)	Displays information (such as phone number and duration) about a connected call on the line.
4	Session button labels (for held calls)	Display information (such as call status and duration) about held calls associated with the selected line. Calls are displayed on the right side of the phone screen from the oldest (at the top) to the newest. Pressing the session button next to a Held Call icon resumes the held call for that session.

5	New Call icon	Indicates you can press the corresponding session button to make a new call.
6	Softkeys	Softkey options for the selected (highlighted) call only. If you select a different call (by pressing a feature button or the Navigation pad, or by answering a ringing call), the softkey options may change.
7	Answer button label	Displays if your system administrator has assigned the Answer feature to the programmable feature button. Pressing the corresponding button answers the oldest incoming call.
8	Speed-dial button label	Displays if you assigned a speed dial to the programmable feature button.
9	Nonprimary line labels	Displays the nonprimary line phone information.
10	All Calls button label	Displays if the All Calls feature is enabled. Pressing the corresponding button displays all calls on all lines. Calls are displayed on the right side of the phone screen from the oldest (at the top) to the newest. Pressing the button once highlights (selects) the current call or first call on the list. Pressing the button twice highlights the header line, allowing you to make a new call. Using the All Calls feature is highly recommended if you have multiple lines on your phone.

Phone with Answer Button

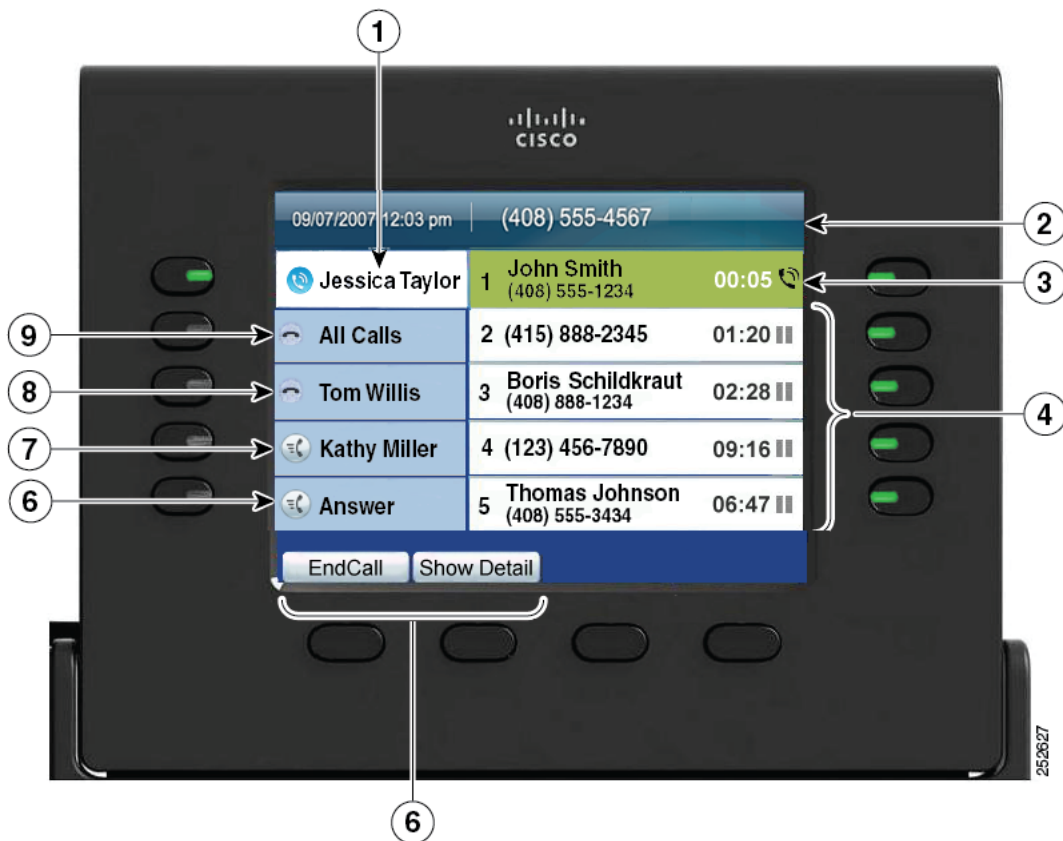





1	Primary line label	Displays the primary line phone information. In this example, the blue icon (for Connected Call) indicates this is the selected line.
2	Header	Displays the date and time, and information (such as phone number) about the selected line.
3	Session label (with Connected Call icon)	Displays information (such as call status and duration) about a connected call associated with the selected line.

4	Session button labels (with Held Call icons)	<p>Display information (such as call status and duration) about held calls associated with the selected line.</p> <p>Calls are displayed on the right side of the phone screen from the oldest (at the top) to the newest.</p> <p>Pressing the session button next to a Held Call icon resumes the held call for that session.</p>
5	Softkeys	<p>Softkey options for the selected (highlighted) call only.</p> <p>If you select a different call (by pressing a feature button or the Navigation pad, or by answering a ringing call), the softkey options may change.</p>
6	Answer button label	<p>Displays if your system administrator has assigned the Answer feature to the programmable feature button.</p> <p>Pressing the corresponding button answers the oldest incoming call.</p>
7	Speed-dial button label	<p>Displays if you assigned a speed dial to the programmable feature button.</p>
8	Nonprimary line labels	<p>Displays the nonprimary line phone information.</p>
9	All Calls button label	<p>Displays if the All Calls feature is enabled. Pressing the corresponding button displays all calls on all lines.</p> <p>Calls are displayed on the right side of the phone screen from the oldest (at the top) to the newest.</p> <p>Pressing the button once highlights (selects) the current call or first call on the list. Pressing the button twice highlights the header line, allowing you to make a new call.</p> <p>Using the All Calls feature is highly recommended if you have multiple lines on your phone.</p>

Phone Screen Navigation and Item Selection

Task	Action	Example
Scroll to highlight an item.	Press the Navigation pad.	Highlight a call from the missed call list.
Select an item by number.	Press the corresponding number on the keypad.	Press 2 to select the second item in the Applications menu.
Select an item using the Select button.	Press the Select button (at the center of the Navigation pad).	Highlight the Preferences application and press the Select button.

Task	Action	Example
<p>Navigate to a submenu. (A right arrow (>) next to the menu item indicates there is a submenu.)</p>	<p>Highlight the menu item and press the item number on the keypad.</p> <p>Or press the down arrow on the Navigation pad and then press the Select button.</p>	<p>Highlight the Network Setup menu, then press 1 to open the submenu.</p>
<p>Select a line to use a calling feature (when line is idle).</p>	<p>Press the feature (line) button.</p> <p>Indicators of your line selection include:</p> <ul style="list-style-type: none"> • The selected line is displayed on the phone screen header. • The selected line is highlighted. • Color of the icon (on the line label) changes to blue. 	<p>Press the line button, then press the Forward All softkey to forward calls on that line.</p>
<p>Select a line to use a calling feature (when line has one or more active calls).</p>	<p>Press the feature (line) button twice.</p> <p>Indicators of your line selection include:</p> <ul style="list-style-type: none"> • The selected line is displayed on the phone screen header. • The selected line is highlighted. • Color of the icon (on the line label) changes to blue. 	<p>Press the line button twice, then press the Forward All softkey to forward calls on that line.</p>

Task	Action	Example
Change the line view (while on a call).	<p>Select a different line (by pressing the line feature button or by scrolling and pressing the Select button).</p> <p>If you are on a call, changing the line view does not end the call, but it may disappear from view.</p> <p>To see your current call session again, select the line the call is on.</p>	<p>While on a call, press a different line button.</p> <p>Call session information for the newly selected line is displayed. Call session information previously displayed may disappear from view.</p>
Go back to the previous screen or menu.	Press the Back button  or the  softkey.	From the Preferences menu, press  or the  softkey.

Power-Save Mode

Depending on how your system administrator sets up the phone, your phone display might go into power-save mode (the phone screen appears blank and the Select button is lit white). To turn on the phone display, press any button or pick up the handset.

Handset Rest

Your system administrator may have mounted your phone on a wall. With a wall-mounted phone, you might need to adjust the handset rest to ensure that the receiver will not slip out of the cradle.

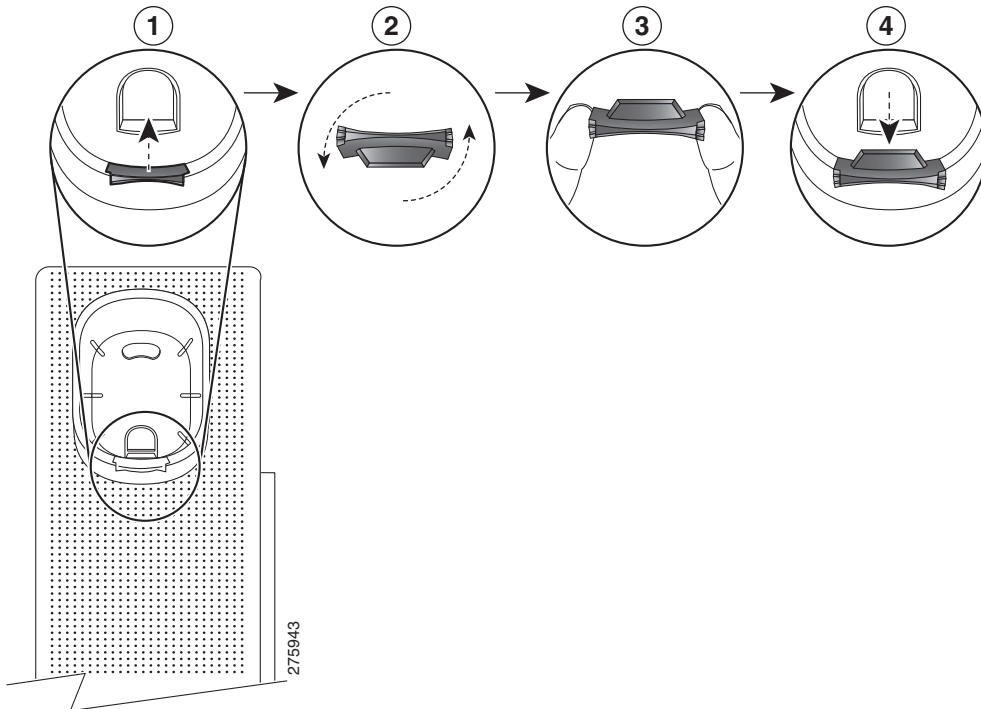

1	Remove handset from the cradle and pull the plastic tab from the handset rest.
2	Rotate the tab 180 degrees.
3	Hold the tab between two fingers, with the corner notches facing you.
4	Line up the tab with the slot in the cradle, and press the tab evenly into the slot. An extension protrudes from the top of the rotated tab. Return the handset to the handset rest.

Cisco Unified IP Phone 9951

The Cisco Unified IP Phone 9951 provides these features:

- Phone connections
- Footstand
- Phone display viewing angle
- Buttons and hardware
- Phone screen
- Power-save mode
- Handset rest

Phone Connections

For your phone to work, it must be connected to the corporate IP telephony network. Your system administrator can help you connect your phone.

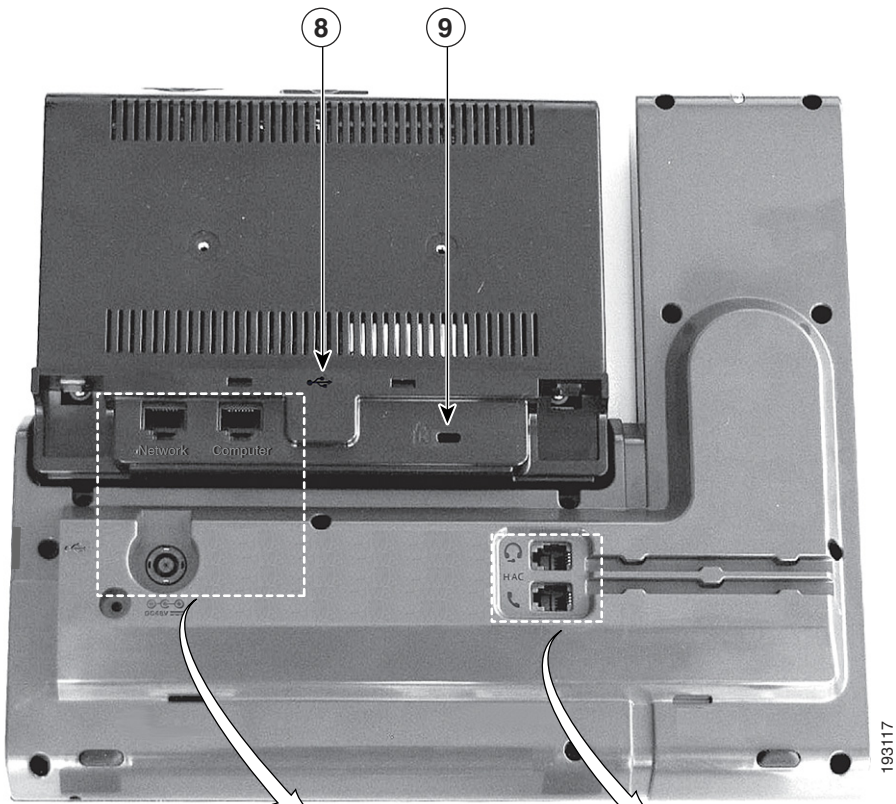

193117

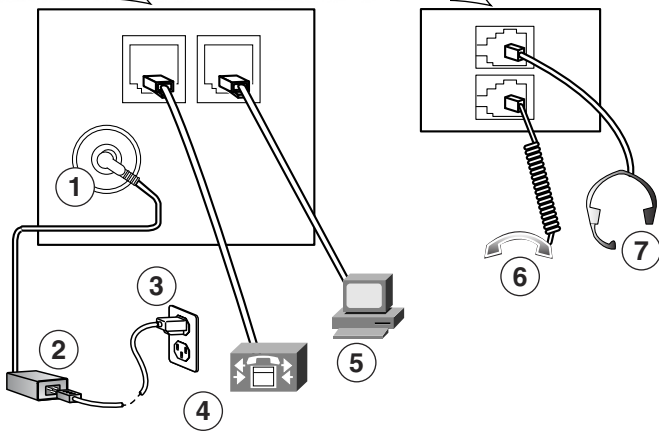

1	DC adaptor port (DC48V)	6	Handset connection
2	AC-to-DC power supply (optional)	7	Analog headset connection (optional)
3	AC power wall plug (optional)	8	USB port
4	Network port connection (10/100/1000 SW) with IEEE 802.3af power enabled	9	Anti-theft security lock connector (lock optional)
5	Computer port (10/100/1000 PC) connection		



1	USB port	3	Speaker port for output to optional external speakers
2	Cisco Unified IP Color Key Expansion Module connector	4	Microphone port for input from optional external microphone

Footstand

If your phone is placed on a table or desk, connect the footstand to the back of the phone.

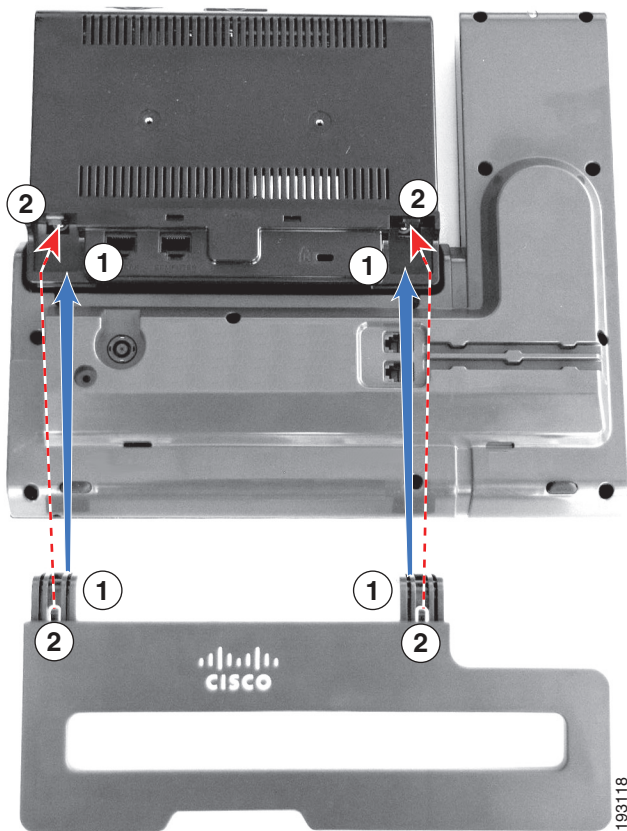

1 Insert the curved connectors into the lower slots.	2 Lift the footstand until the connectors snap into the upper slots.
-------------------------------------------------------------	-----------------------------------------------------------------------------

Phone Display Viewing Angle







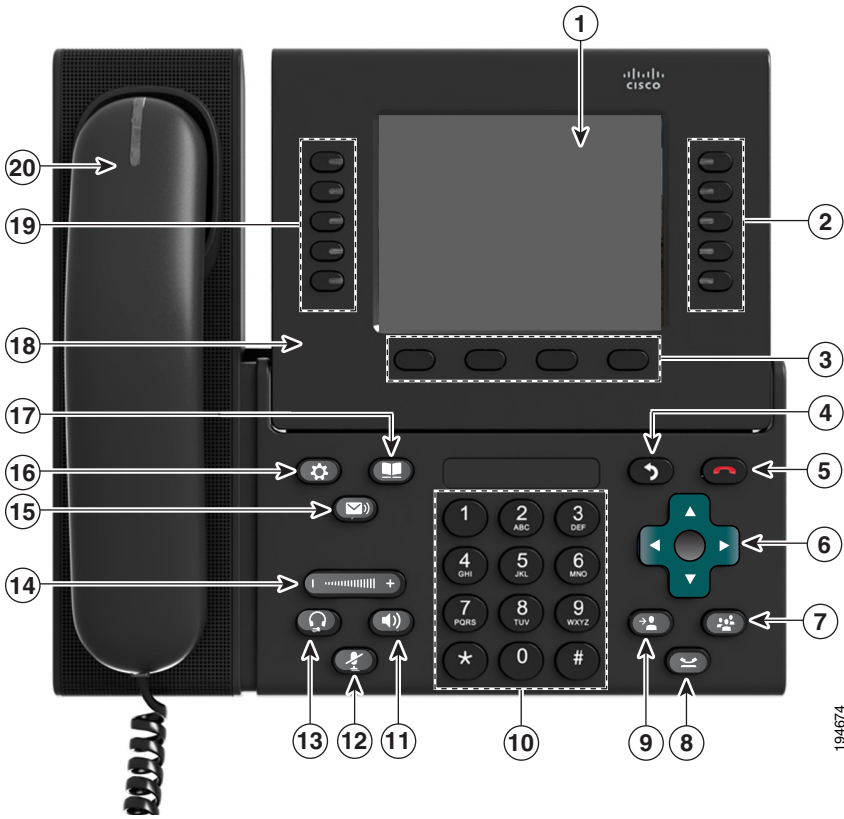

The phone display viewing angle can be adjusted according to your preference.



















Buttons and Hardware

Your phone provides quick access to your phone lines, features, and call sessions. Use the feature buttons (on the left) to view calls on a line or access features such as speed dial or All Calls. Use the call session buttons (on the right) to perform tasks such as making a call, answering a call, or resuming a held call.



1	Phone screen	Shows information about your phone, including directory number, call information (for example caller ID, icons for an active call or call on hold) and available softkeys.
2	Session buttons 	<p>Each represents a call session and takes the default action for that session. For example, pressing the session button for a ringing call answers the call, while pressing the session button for a held call resumes the call.</p> <p>Color LEDs reflect the call state. LEDs can <i>flash</i> (blink on and off rapidly), <i>pulse</i> (alternately dim and brighten), or appear <i>solid</i> (glow without interruption).</p> <ul style="list-style-type: none"> Flashing amber —Ringing call. Pressing this button answers the call. Solid green —May be a connected call or an outgoing call that is not yet connected. If the call is connected, pressing this button displays the call details or the participants of a conference call. If the call is not yet connected, pressing this button ends the call. Pulsing green —Held call. Pressing this button resumes the held call. Solid red —Shared line in-use remotely. Pressing this button allows you to barge in on the call (if Barge is enabled). Pulsing red —Shared line call put on hold remotely. Pressing this button resumes the held call. <p>Icons next to the session buttons indicate an action for that session. For example, pressing the session button with a Missed Calls icon displays your missed calls, and pressing the session button with a Voicemail icon accesses your voice messaging system.</p> <p>(The position of session buttons may be reversed with that of programmable feature buttons on phones using a locale with a right-to-left reading orientation, such as Hebrew and Arabic.)</p>
3	Softkey buttons 	Allow you to access the softkey options displayed on your phone screen.
4	Back button 	Returns to the previous screen or menu.
5	Release button 	Ends a connected call or session.

6	Navigation pad and Select button 	<p>The four-way Navigation pad allows you to scroll through menus, highlight items, and move within a text input field.</p> <p>The Select button (center of the Navigation pad) allows you to select a highlighted item.</p> <p>The Select button is lit (white) when the phone is in power-save mode.</p>
7	Conference button 	Creates a conference call.
8	Hold button 	Places a connected call on hold.
9	Transfer button 	Transfers a call.
10	Keypad	Allows you to dial phone numbers, enter letters, and choose menu items (by entering the item number).
11	Speakerphone button 	<p>Selects the speakerphone as the default audio path and initiates a new call, picks up an incoming call, or ends a call. During a call, the button is lit green.</p> <p>The speakerphone audio path does not change until a new default audio path is selected (for example, by picking up the handset).</p> <p>If external speakers are connected, the Speakerphone button selects them as the default audio path.</p>
12	Mute button 	Toggles the microphone on or off during a call. When the microphone is muted, the button is lit red.
13	Headset button 	<p>Selects the wired headset as the default audio path and initiates a new call, picks up an incoming call, or ends a call. During a call, the button is lit green.</p> <p>A headset icon  in the phone screen header line indicates the headset is the default audio path. This audio path does not change until a new default audio path is selected (for example, by picking up the handset).</p>
14	Volume button 	<p>Controls the handset, headset, and speakerphone volume (off-hook) and the ringer volume (on-hook).</p> <p>Silences the ringer on the phone if an incoming call is ringing.</p>
15	Messages button 	Auto-dials your voicemail system (varies by system).

16	Applications button 	Opens/closes the Applications menu. Depending on how your system administrator sets up the phone, use it to access applications such as call history, preferences, and phone information.
17	Contacts button 	Opens/closes the Contacts menu. Depending on how your system administrator sets up the phone, use it to access personal contacts, corporate directory, or call history.
18	Phone display	Phone display that can be positioned to your preferred viewing angle.
19	Programmable feature buttons 	<p>Programmable feature buttons that correspond to phone lines, speed dials, and calling features.</p> <p>Pressing a button for a phone line displays the active calls for that line. If you have multiple lines, you might have an All Calls feature button that displays a consolidated list of calls from all lines.</p> <p>Color LEDs indicate the line state:</p> <ul style="list-style-type: none"> • Amber  —Ringing call on this line • Green  —Active or held call on this line • Red  —Shared line in-use remotely <p>(The position of programmable feature buttons may be reversed with that of session buttons on phones using a locale with a right-to-left reading orientation, such as Hebrew and Arabic.)</p>
20	Handset with light strip	The handset light strip lights up to indicate a ringing call (flashing red) or a new voice message (steady red).

Phone Screen

How your system administrator sets up the phone determines what is displayed on your phone screen.

Phone with Single Line



1	Line label	Displays the line phone information.
2	Header	Displays the date and time, and information (such as phone number) about the selected line.
3	Session label (for connected call)	Displays information (such as phone number and duration) about a connected call on the line.

4	Session button label (for held call)	Displays information (such as phone number and duration) about a held call on the line. Pressing the corresponding session button resumes the held call.
5	New Call icon	Indicates you can press the corresponding session button to make a new call.
6	Softkeys	Softkey options for the selected (highlighted) call only. If you select a different call (by pressing a feature button or the Navigation pad, or by answering a ringing call), the softkey options may change.

Phone with Multiple Lines

If you have multiple lines, it is highly recommended that the All Calls feature is enabled on your phone. All Calls allows you to view all the calls on all lines at the same time. For more information, see your system administrator.

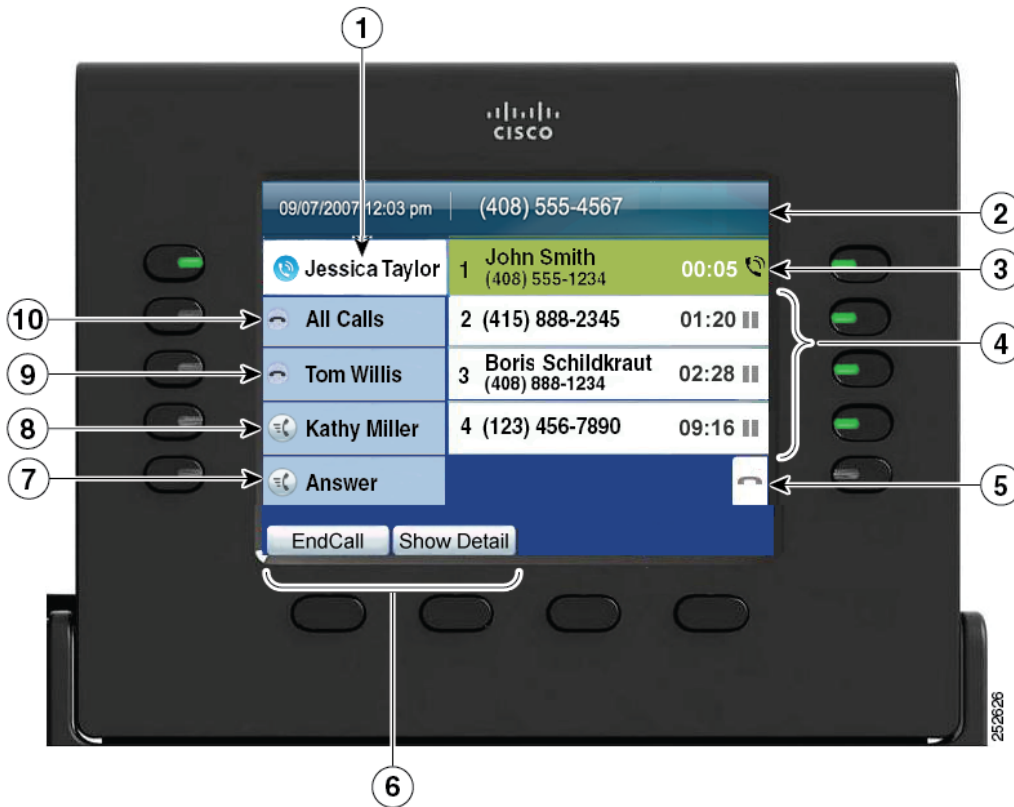

1	Primary line label	Displays the primary line phone information. In this example, the blue icon (for Connected Call) indicates this is the selected line.
2	Header	Displays the date and time, and information (such as phone number) about the selected line.
3	Session label (for a connected call)	Displays information (such as phone number and duration) about a connected call on the line.
4	Session button labels (for held calls)	Display information (such as call status and duration) about held calls associated with the selected line. Calls are displayed on the right side of the phone screen in order of the oldest (at the top) to the newest. Pressing the session button next to a Held Call icon resumes the held call for that session.

5	New Call icon	Indicates you can press the corresponding session button to make a new call.
6	Softkeys	Softkey options for the selected (highlighted) call only. If you select a different call (by pressing a feature button or the Navigation pad, or by answering a ringing call), the softkey options may change.
7	Answer button label	Displays if your system administrator has assigned the Answer feature to the programmable feature button. Pressing the corresponding button answers the oldest incoming call.
8	Speed-dial button label	Displays if you assigned a speed dial to the programmable feature button.
9	Nonprimary line labels	Displays the nonprimary line phone information.
10	All Calls button label	Displays if the All Calls feature is enabled. Pressing the corresponding button displays all calls on all lines. Calls are displayed on the right side of the phone screen from the oldest (at the top) to the newest. Pressing the button once highlights (selects) the current call or first call on the list. Pressing the button twice highlights the header line, allowing you to make a new call. Using the All Calls feature is highly recommended if you have multiple lines on your phone.

Phone with Answer Button

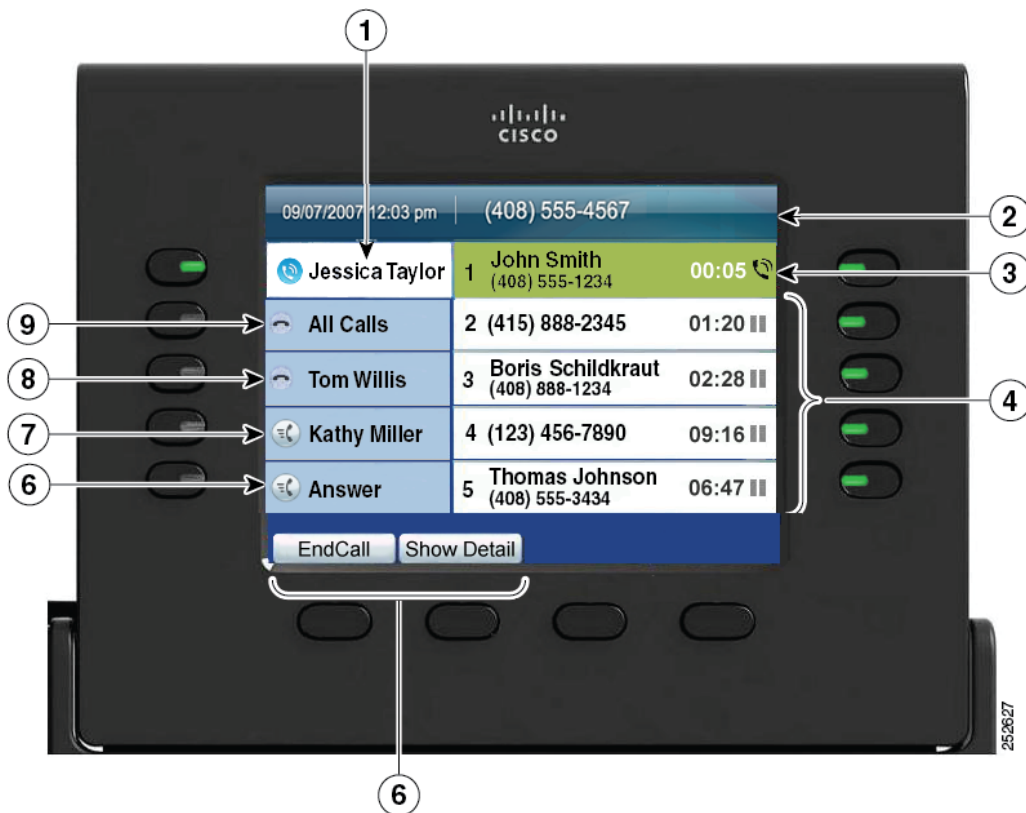





1	Primary line label	Displays the primary line phone information. In this example, the blue icon (for Connected Call) indicates this is the selected line.
2	Header	Displays the date and time, and information (such as phone number) about the selected line.
3	Session label (with Connected Call icon)	Displays information (such as call status and duration) about a connected call associated with the selected line.

4	Session button labels (with Held Call icons)	<p>Display information (such as call status and duration) about held calls associated with the selected line.</p> <p>Calls are displayed on the right side of the phone screen from the oldest (at the top) to the newest.</p> <p>Pressing the session button next to a Held Call icon resumes the held call for that session.</p>
5	Softkeys	<p>Softkey options for the selected (highlighted) call only.</p> <p>If you select a different call (by pressing a feature button or the Navigation pad, or by answering a ringing call), the softkey options may change.</p>
6	Answer button label	<p>Displays if your system administrator has assigned the Answer feature to the programmable feature button.</p> <p>Pressing the corresponding button answers the oldest incoming call.</p>
7	Speed-dial button label	<p>Displays if you assigned a speed dial to the programmable feature button.</p>
8	Nonprimary line labels	<p>Displays the nonprimary line phone information.</p>
9	All Calls button label	<p>Displays if the All Calls feature is enabled. Pressing the corresponding button displays all calls on all lines.</p> <p>Calls are displayed on the right side of the phone screen from the oldest (at the top) to the newest.</p> <p>Pressing the button once highlights (selects) the current call or first call on the list. Pressing the button twice highlights the header line, allowing you to make a new call.</p> <p>Using the All Calls feature is highly recommended if you have multiple lines on your phone.</p>

Phone Screen Navigation and Item Selection

Task	Action	Example
Scroll to highlight an item.	Press the Navigation pad.	Highlight a call from the missed call list.
Select an item by number.	Press the corresponding number on the keypad.	Press 2 to select the second item in the Applications menu.
Select an item using the Select button.	Press the Select button (at the center of the Navigation pad).	Highlight the Preferences application and press the Select button.

Task	Action	Example
<p>Navigate to a submenu. (A right arrow (>) next to the menu item indicates there is a submenu.)</p>	<p>Highlight the menu item and press the item number on the keypad.</p> <p>Or press the down arrow on the Navigation pad and then press the Select button.</p>	<p>Highlight the Network Setup menu, then press 1 to open the submenu.</p>
<p>Select a line to use a calling feature (when line is idle).</p>	<p>Press the feature (line) button.</p> <p>Indicators of your line selection include:</p> <ul style="list-style-type: none"> • The selected line is displayed on the phone screen header. • The selected line is highlighted. • Color of the icon (on the line label) changes to blue. 	<p>Press the line button, then press the Forward All softkey to forward calls on that line.</p>
<p>Select a line to use a calling feature (when line has one or more active calls).</p>	<p>Press the feature (line) button twice.</p> <p>Indicators of your line selection include:</p> <ul style="list-style-type: none"> • The selected line is displayed on the phone screen header. • The selected line is highlighted. • Color of the icon (on the line label) changes to blue. 	<p>Press the line button twice, then press the Forward All softkey to forward calls on that line.</p>

Task	Action	Example
Change the line view (while on a call).	<p>Select a different line (by pressing the line button or scrolling and pressing the Select button).</p> <p>If you are on a call, changing the line view does not end the call, but it may disappear from view.</p> <p>To see your current call session again, select the line the call is on.</p>	<p>While on a call, press a different line button.</p> <p>Call session information for the newly selected line is displayed.</p> <p>Call session information previously displayed may disappear from view.</p>
Go back to the previous screen or menu.	Press the Back button  or the  softkey.	From the Preferences menu, press  or the  softkey.

Power-Save Mode

Depending on how your system administrator sets up the phone, your phone display might go into power-save mode (the phone screen appears blank and the Select button is lit white). To turn on the phone display, press any button or pick up the handset.

Handset Rest

Your system administrator may have mounted your phone on a wall. With a wall-mounted phone, you might need to adjust the handset rest to ensure that the receiver will not slip out of the cradle.

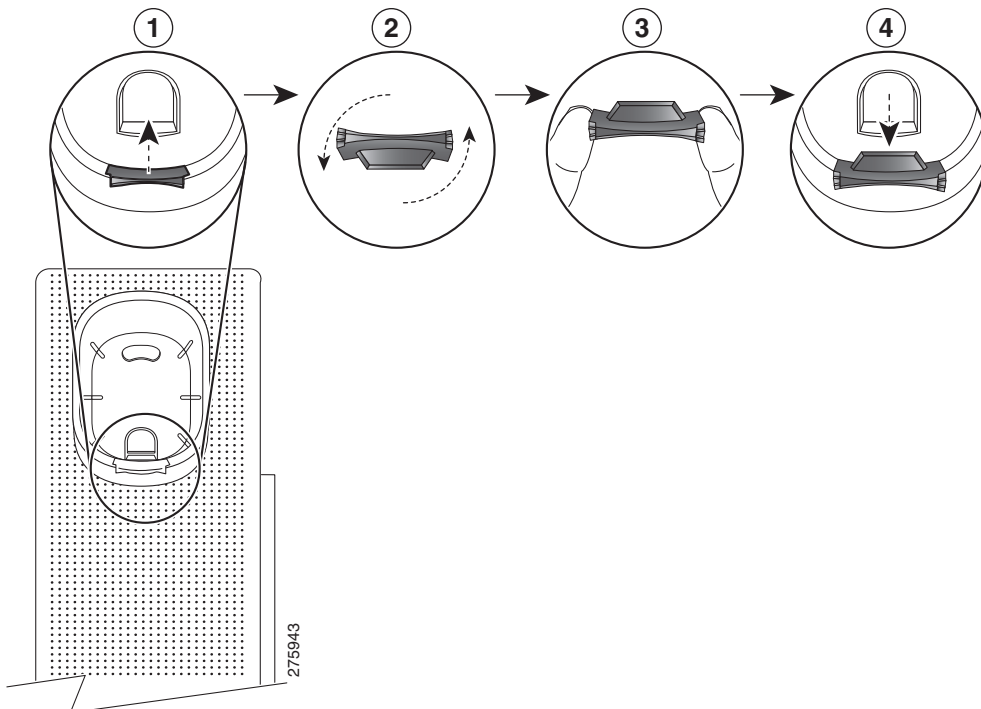

1	Remove handset from the cradle and pull the plastic tab from the handset rest.
2	Rotate the tab 180 degrees.
3	Hold the tab between two fingers, with the corner notches facing you.
4	Line up the tab with the slot in the cradle, and press the tab evenly into the slot. An extension protrudes from the top of the rotated tab. Return the handset to the handset rest.

Cisco Unified IP Phone 9971

The Cisco Unified IP Phone 9971 provides these features:

- Phone connections
- Footstand
- Phone display viewing angle
- Buttons and hardware
- Phone screen
- Power-save mode
- Phone display cleaning
- Handset rest

Phone Connections

For your phone to work, it must be connected to the corporate IP telephony network. Your system administrator can help you connect your phone.

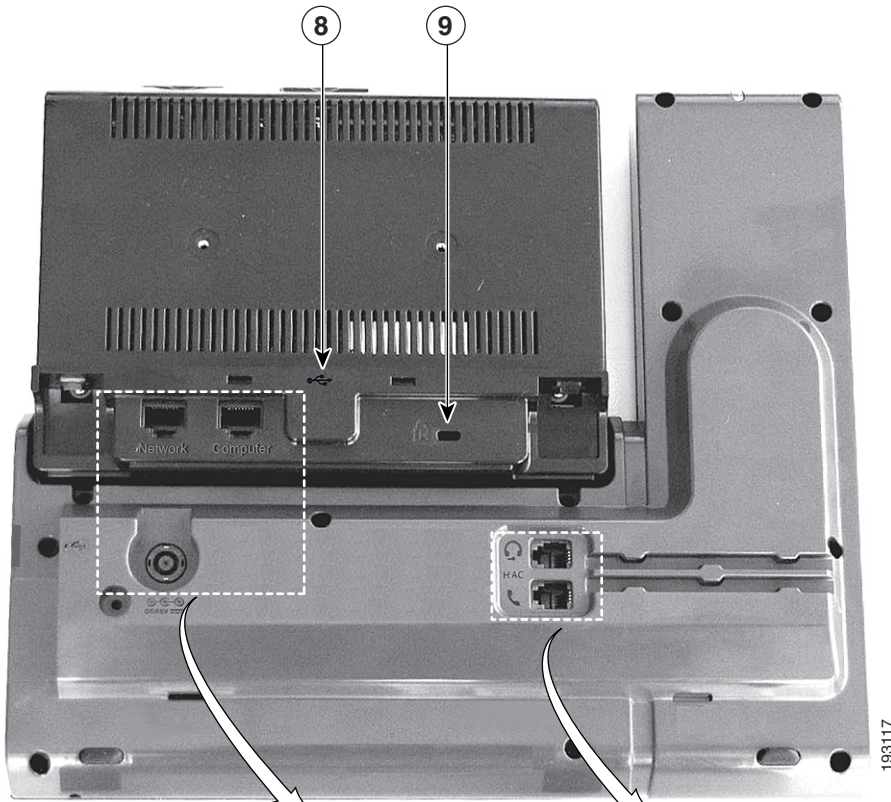

193117

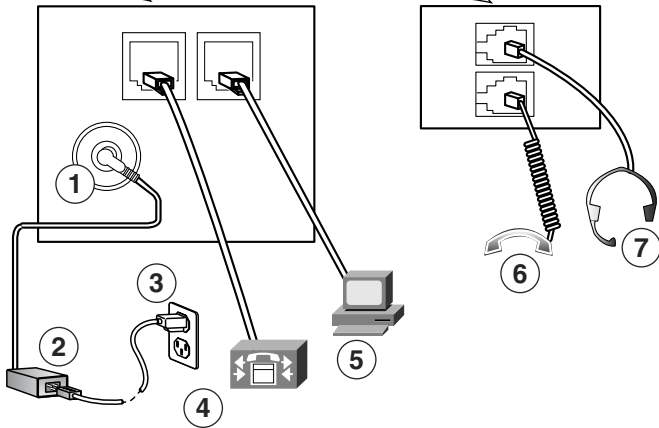

1	DC adaptor port (DC48V)	6	Handset connection
2	AC-to-DC power supply (optional for the network port connection but required for a wifi connection)	7	Analog headset connection (optional)
3	AC power wall plug (optional)	8	USB port
4	Network port connection (10/100/1000 SW) with IEEE 802.3af and IEEE 802.3at power enabled	9	Anti-theft security lock connector (lock optional)
5	Computer port (10/100/1000 PC) connection		



1	USB port	3	Speaker port for output to optional external speakers
2	Cisco Unified IP Color Key Expansion Module connector	4	Microphone port for input from optional external microphone

Wireless Connection

Your phone can be connected to a wireless network using 802.11a or 802.11b/g, but the connection must be set up by your system administrator. For more information, see your system administrator.

Footstand

If your phone is placed on a table or desk, connect the footstand to the back of the phone.

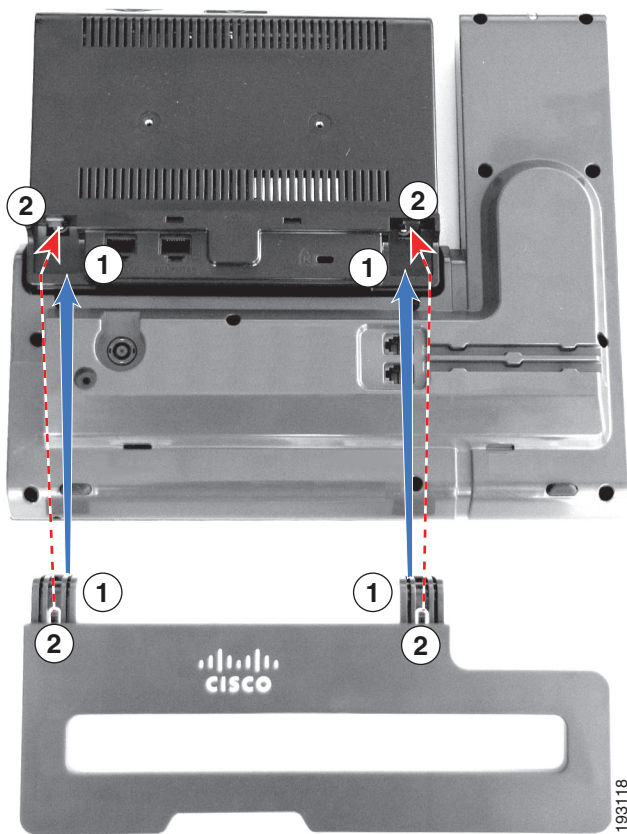

1 Insert the curved connectors into the lower slots.	2 Lift the footstand until the connectors snap into the upper slots.
-------------------------------------------------------------	-----------------------------------------------------------------------------

Phone Display Viewing Angle







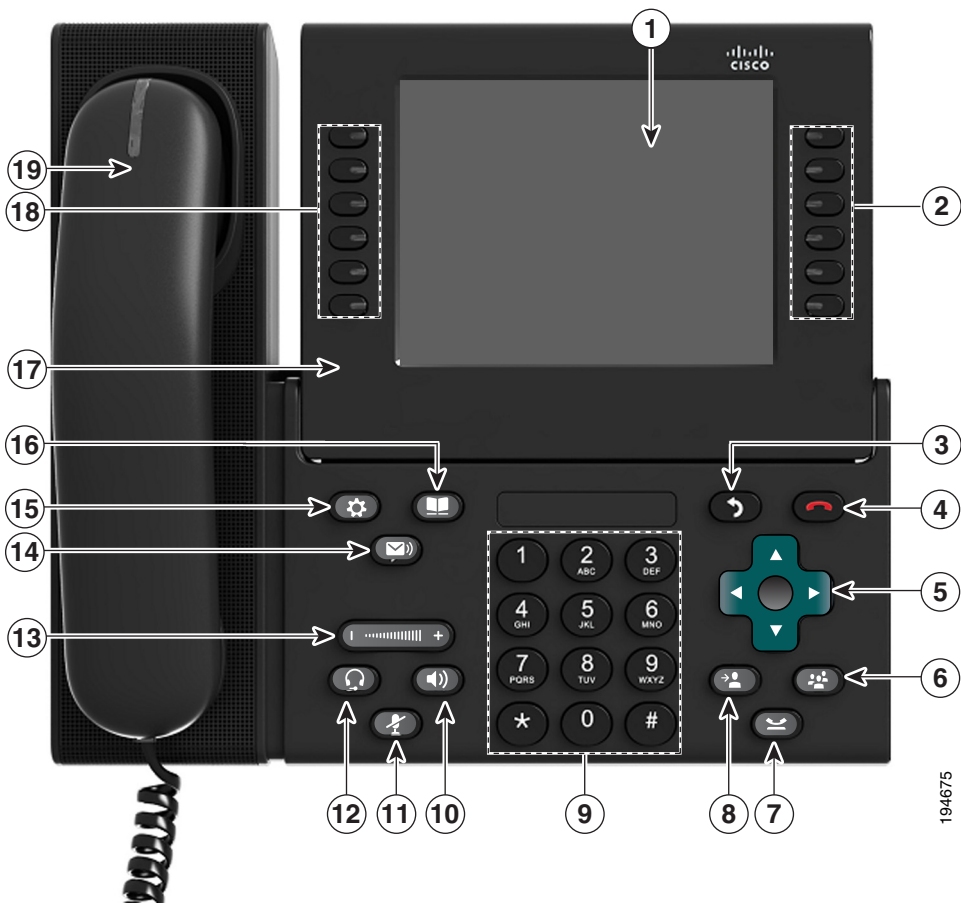

The phone display viewing angle can be adjusted according to your preference.



Buttons and Hardware

Your phone provides quick access to your phone lines, features, and call sessions. Use the feature buttons (on the left) to view calls on a line or access features such as speed dial or All Calls. Use the call session buttons (on the right) to perform tasks such as making a call, answering a call, or resuming a held call.



1	Phone screen	<p>Shows information about your phone, including directory number, call information (for example caller ID, icons for an active call or call on hold) and available softkeys.</p> <p>Phone screen items, such as menu options and softkeys, are touch-sensitive.</p>
2	<p>Session buttons</p> 	<p>Each represents a call session and takes the default action for that session. For example, pressing the session button for a ringing call answers the call, while pressing the session button for a held call resumes the call.</p> <p>Color LEDs reflect the call state. LEDs can <i>flash</i> (blink on and off rapidly), <i>pulse</i> (alternately dim and brighten), or appear <i>solid</i> (glow without interruption).</p> <ul style="list-style-type: none"> • Flashing amber —Ringing call. Pressing this button answers the call. • Solid green —May be a connected call or an outgoing call that is not yet connected. If the call is connected, pressing this button displays the call details or the participants of a conference call. If the call is not yet connected, pressing this button ends the call. • Pulsing green —Held call. Pressing this button resumes the held call. • Solid red —Shared line in-use remotely. Pressing this button allows you to barge in on the call (if Barge is enabled). • Pulsing red —Shared line call put on hold remotely. Pressing this button resumes the held call. <p>Icons next to the session buttons indicate an action for that session. For example, pressing the session button with a Missed Calls icon displays your missed calls, and pressing the session button with a Voicemail icon accesses your voice messaging system.</p> <p>(The position of session buttons may be reversed with that of programmable feature buttons on phones using a locale with a right-to-left reading orientation, such as Hebrew and Arabic.)</p>
3	<p>Back button</p> 	<p>Returns to the previous screen or menu.</p>
4	<p>Release button</p> 	<p>Ends a connected call or session.</p>