



Cisco Router Guide

For teleworkers, small offices, small to medium-sized businesses,
and enterprise branch and head offices

Cisco Integrated Services Routers: Cisco 860, 880, 890, 1800 (fixed), 1800 (modular), 1900, 2800, 2900, 3800, 3900 Series;

Cisco Aggregation Routers: Cisco 7200, 7301, 7304, ASR 1000, 7600, Catalyst 6500 Series

Summer 2010 V6

Cisco Router Guide

For Medium-sized Businesses, Enterprise Branches,
Head Offices, and the Service Provider Edge

This is your guide to Cisco® Services Aggregation Routers and Cisco Integrated Services Routers, the broadest and most versatile portfolio of products for enabling the deployment of multiple advanced services.

Cisco is the worldwide leader in networking systems for organizations of all sizes, offering solutions that fully support enterprise-wide deployment of networked business applications. A foundation of the Intelligent Information Network, Cisco routers provide high availability, comprehensive security, integrated wireless, ease of management, and advanced Quality of Service (QoS) for today's most demanding network services, including IP communications, video, customer relationship management, financial transactions, and other real-time applications.

This guide shows how Cisco Services Aggregation Routers and Cisco Integrated Services Routers enable you to meet your current and future needs with modular designs, allowing incremental migration as your business and network requirements change.

In this guide, you can see for yourself how Cisco delivers benefits beyond basic data access, providing services such as voice, security, and wireless as part of an integrated routing system that maximizes productivity and investment protection.

Cisco Router Guide

Series Overview	4
Product Transition Matrix	13

Integrated Services Routers

Cisco 860 Series	19
Cisco 880 Series	25
Cisco 890 Series	37
Cisco 1800 Series (Fixed-Configuration)	45
Cisco 1800 Series (Cisco 1841 Router Modular).....	53
Cisco 1800 Series (Cisco 1861 Router Modular).....	59
Cisco 1900 Series	67
Cisco 2800 Series	77
Cisco 2900 Series	89
Cisco 3800 Series	105
Cisco 3900 Series	117

Aggregation Routers

Cisco 7200 Series	133
Cisco 7301 Series	143
Cisco 7304 Series	153
Cisco ASR 1000 Series	161
Cisco 7600 Series	173
Cisco Catalyst 6500 Series	191

Compatibility Quick Looks

Cisco Interface Card Compatibility Quick Look	203
Cisco Advanced Integration Module Compatibility Quick Look.....	205
Cisco Port Adapter Compatibility Quick Look	209
Cisco Shared Port Adapter Compatibility Quick Look	213
Cisco USB Flash Memory Compatibility Quick Look.....	217

Series Overview

For Small- to Medium-sized Businesses, Enterprise Branches, Head Offices, and the Service Provider Edge

Cisco offers the industry's broadest and most versatile portfolio of secure, high-performance Integrated Services Routers, enabling the deployment of a wide array of services to the farthest reaches of an organization, from the home office to the small office to the large enterprise branch and head office.



Cisco 860 Series

Small Offices

- Concurrent broadband services for small offices, and remote sites
- Secure connectivity with Stateful Inspection Firewall and IP Security (IPsec) VPN support for small offices
- Security features including:
 - Stateful Inspection Firewall
 - IP Security (IPsec) VPNs (Triple Data Encryption Standard [3DES] or Advanced Encryption Standard [AES])
- 4-port 10/100 Fast Ethernet managed switch with VLAN support
- CON/AUX Port for console or external modem
- Secure 802.11g/n access point option based on IEEE802.11n draft 2.0 standard
- Easy setup, deployment, and remote management capabilities through Web-based tools and Cisco IOS® Software

Cisco 880 Series

Small Offices and Teleworker Deployments

- High performance for broadband access in small offices and small branch-office and teleworker sites
- Collaborative services with secure analog, digital voice, and data communication
- Business continuity and WAN diversity with redundant WAN links: Fast Ethernet, G.SHDSL, ADSL2/2+, VDSL2, 3G, and ISDN
- Survivable Remote Site Telephony (SRST) voice continuity for enterprise small branch-office and teleworker sites
- Enhanced security, including:
 - Firewall with advance application and control for email, Instant Messaging (IM), and HTTP traffic
 - Site-to-site remote-access and dynamic VPN services: IP Security (IPsec) VPNs (Triple Data Encryption Standard [3DES] or Advanced Encryption Standard [AES]), Dynamic Multipoint VPN (DMVPN), Group Encrypted Transport VPN with onboard acceleration, and Secure Sockets Layer (SSL) VPN
 - Intrusion prevention system (IPS): An inline, deep-packet inspection feature that effectively mitigates a wide range of network attacks
 - Content filtering: A subscription-based integrated security solution that offers category-based reputation rating; keyword blocking; and protection against adware, malware, spyware, and URL blocking
- Four-port 10/100 Fast Ethernet managed switch with VLAN support; two ports support Power over Ethernet (PoE) for powering IP phones or external access points
- Secure 802.11g/n access-point option based on draft 802.11n standard with support for autonomous or Cisco Unified WLAN architectures
- CON/AUX port for console or external modem
- One USB 1.1 port for security eToken credentials, booting from USB, and loading configuration
- Easy setup, deployment, and remote-management capabilities through web-based tools and Cisco IOS® Software

Cisco 890 Series

Enterprise Small Branch

- High performance for secure broadband and Metro Ethernet access with concurrent services for enterprise small branch offices
- Business continuity and WAN diversity with redundant WAN links: Fast Ethernet, V.92, and ISDN Basic Rate Interface (BRI)
- Integrated secure 802.11a/g/n access point (optional) based on the draft 802.11n standard; dual-band radios for mobility and support for autonomous or Cisco Unified WLAN architectures
- Enhanced security including:
 - Firewall with advance application and control for email, instant messaging (IM), and HTTP traffic
 - Site-to-site remote-access and dynamic VPN services: IP Security (IPsec) VPNs (Triple Data Encryption Standard [3DES] or Advanced Encryption Standard [AES]), Dynamic Multipoint VPN [DMVPN], Group Encrypted Transport VPN [GET VPN] with onboard acceleration, and Secure Sockets Layer [SSL] VPN
 - Intrusion prevention system (IPS): An inline, deep-packet-inspection feature that mitigates a wide range of network attacks
 - Content filtering: A subscription-based integrated security solution that offers category-based reputation rating, keyword blocking, and protection against adware, malware, spyware, and URL blocking
- An 8-port 10/100 Fast Ethernet managed switch with VLAN support and 4-port support for Power over Ethernet (PoE) (optional) to power IP phones or external access points
- Metro Ethernet features include:
 - One 1000 BASE-T Gigabit Ethernet WAN port
 - One 10/100 BASE-T Fast Ethernet WAN port
 - Intelligent hierarchical quality of service (HQoS): Supports hierarchical queuing and shaping
 - Connectivity Fault Management (CFM), based on 802.1ag
 - 802.3ah standard based Link operational administration and maintenance (OAM)
 - Ethernet Local Management Interface (E-LMI) for the Customer Edge
 - CFM Interworking and backwards compatibility
 - Performance Management based on IP service-level agreement (SLA) for Ethernet
- Dedicated console and auxiliary ports for configuration and management
- Two USB 2.0 ports for security eToken credentials, booting, and loading configuration from USB
- Easy setup, deployment, and centralized and remote-management capabilities through web-based tools and Cisco IOS® Software

Series Overview (continued)

Extend services from the WAN to the campus edge with the industry's most extensive WAN and MAN aggregation platform portfolio, which includes the Cisco 7200, 7301, 7304, and 7600 Series Routers and the Cisco Catalyst 6500 Series Switches, each providing a comprehensive set of highly secure, concurrent, and integrated services for enterprise customers.



Cisco 1800 Series (Fixed-configuration)

Small Offices and Small Enterprise Branch Offices

- Secure, concurrent services for broadband access with WAN high availability
- Manageability and reliability of Cisco IOS Software Business-class Security
- Stateful firewall with URL filtering
- VPN 3DES encryption and Advanced Encryption Standard (AES) encryption
- Dynamic Multipoint VPN (DMVPN)
- Intrusion Prevention System (IPS) Fixed Configuration
- Secure broadband access at broadband performance
- Integrated ISDN Basic Rate S/T Interface (BRI), analog modem, or Ethernet backup port for redundant WAN links and load balancing
- Secure wireless LAN option for simultaneous 802.11a and 802.11b/g with use of multiple antennas
- 8-port 10/100 managed switch with 802.1q VLAN support and optional Power over Ethernet (PoE)



Cisco 1800 Series (Modular)

Small- to Medium-sized Businesses and Small Enterprise Branch Offices

- Wire-speed performance with secure data services enabled at up to T1/E1/xDSL rates
- Increased services density for secure data services
- Support for next-generation High-speed WAN Interface Cards
- Increased flexibility through support of internal AIM slot for high-speed VPN and future applications
- Built-in dual Fast Ethernet ports
- Support for over 30 existing and new modules Secure Networking
- Hardware-based VPN acceleration on motherboard
- Antivirus defense
- Intrusion Prevention System (IPS) Support



Cisco 1900 Series Integrated Services Routers

Small Offices and Small Enterprise Branch Offices

- Embedded hardware-accelerated VPN encryption
- Secure collaborative communications with Group Encrypted Transport VPN, Dynamic Multipoint VPN, or Enhanced Easy VPN
- Integrated threat control using Cisco IOS Firewall, Cisco IOS Zone-Based Firewall, Cisco IOS IPS, and Cisco IOS Content Filtering
- Identity management that uses authentication, authorization, and accounting (AAA), and public key infrastructure
- 2 Integrated 10/100/1000 Ethernet ports
- 2 enhanced High-Speed WAN Interface Card slots that can host 2 single wide or 1 double wide and 1 single wide (e)HWIC
- Fully integrated power distribution to modules supporting 802.3af Power over Ethernet (PoE) and Cisco Enhanced PoE



Cisco 2800 Series

Small- to Medium-sized Businesses and Enterprise Branch Offices

- Wire-speed performance up to multiple T1/E1/xDSL rates
- Increased services density for security, voice, caching, video, network analysis, and L2 switching
- Support for enhanced interfaces (NME, HWIC, EVM, and PVDM2)
- Built-in dual Fast Ethernet or Gigabit Ethernet ports
- Support for over 90 existing and new modules
- Optional support for integrated Power over Ethernet (PoE)
- 2 integrated 10/100/1000 Ethernet ports
- 2 enhanced High-Speed WAN Interface Card slots that can host 2 single wide or 1 double wide and 1 single wide (e)HWIC
- 1 Internal Services Module slot
- Fully integrated power distribution to modules supporting 802.3af Power over Ethernet (PoE) and Cisco Enhanced PoE

Secure Networking

- Hardware-based VPN acceleration on motherboard
- Antivirus Defense
- Intrusion Prevention System (IPS)

IP Communications and IP

Telephony Support

- IP Communications Express (CCME/SRST/CUE)
- Enhanced Modularity (EVM and PVDM2 support) Integrated Switching
- Up to 64 powered 10/100 switch ports
- 802.3af Power over Ethernet compliance



Cisco 2900 Series Integrated Services Router

Small- to Medium-sized and Enterprise Branch Offices

- Circuit-speed WAN performance up to 75 Mbps with services
- 1-2 RU modular form factor
- 3 onboard digital signal processor (DSP) slots
- 1 internal service module slot for application services
- Fully integrated power distribution to modules supporting 802.3af Power over Ethernet (PoE) and Cisco Enhanced PoE

Secure Networking

- Onboard hardware acceleration for VPN encryption
- Secure collaborative communications with Group Encrypted Transport VPN, Dynamic Multipoint VPN, or Enhanced Easy VPN
- Integrated threat control using Cisco IOS Firewall, Cisco IOS Zone-Based Firewall, Cisco IOS IPS, and Cisco IOS Content Filtering
- Identity management using authentication, authorization, and accounting (AAA), and public key infrastructure

Voice

- High-density packet voice DSP module, optimized for voice and video support
- Standards-certified VoiceXML browser services
- Voicemail support
- Cisco Communications Manager Express and Survivable Remote Site Telephony



Cisco 3800 Series

Medium-sized to Large Businesses and Enterprise Branch Offices

- Wire-speed performance with services enabled at up to T3/E3 rates
- Increased services density for security, voice, caching, video, network analysis, and L2 switching
- Support for enhanced interfaces (NME, HWIC, EVM, and PVDM2)
- Built-in dual Gigabit Ethernet ports
- Support for over 90 existing and new modules
- Single small form pluggable Gigabit Ethernet port
- High availability and resiliency through online insertion and removal support, as well as redundant systems and optional inline power

Secure Networking

- Hardware-based VPN acceleration on motherboard
- Antivirus defense through Network Admission Control Intrusion Prevention System (IPS) IP

Communications and IP

Telephony Support

- IP Communications Express (CCME/SRST/CUE)
- Enhanced Modularity (EVM and PVDM2 support) Integrated Switching
- Up to 112 powered 10/100 switch ports
- 802.3af Power over Ethernet compliance

Series Overview (continued)

Extend services from the WAN to the campus edge with the industry's most extensive WAN and MAN aggregation platform portfolio, which includes the Cisco 7200, 7301, 7304, and 7600 Series Routers and the Cisco Catalyst 6500 Series Switches, each providing a comprehensive set of highly secure, concurrent, and integrated services for enterprise customers.



Cisco 3900 Series Integrated Services Routers

Medium-sized to Large Businesses and Enterprise Branch Offices

- Field-upgradeable motherboard, circuit-speed WAN performance up to 350 Mbps with services
- 3 RU modular form factor
- 4 Enhanced High-Speed WAN Interface Card slots
- Fully integrated power distribution to modules supporting 802.3af Power over Ethernet

Secure Networking

- Embedded hardware-accelerated VPN encryption for secure connectivity
- Integrated threat control using Cisco IOS Firewall, Cisco IOS Zone-Based Firewall, Cisco IOS IPS, and Cisco IOS Content Filtering
- Identity management using authentication, authorization, and accounting (AAA) and public key infrastructure

Unified Communications

- High-density-packet voice DSP module, optimized for voice and video support
- Standards-certified VoiceXML browser services
- Cisco Unified Border Element capabilities for up to 1000 sessions
- Cisco Unity Express voicemail support
- Support for Cisco Communications Manager Express and Survivable Remote Site Telephony



Cisco 7200 Series

Enterprise Head Offices and Service Provider Edge

Application Versatility

- Managed Network Services, WAN Aggregation, MPLS, VPN, broadband aggregation, QoS, and multiservice Business-class MPLS VPN and encrypted VPN
- Stateful inspection firewall
- VPNs: software and hardware encryption, Cisco Easy VPN, Dynamic Multipoint VPN (DMVPN) and Group Encrypted Transport VPN (GETVPN)
- Service-level validation features
- Intrusion Prevention System (IPS)

Multiservice Data/Voice

- Analog and digital voice
- Survivable Remote Site Telephony (SRST)
- Multiservice interchange (MIX)-enabled backplane for service integration Modularity
- Supports over 70 interfaces, providing a comprehensive range of connectivity options from FE to GbE, and DS0 through OC-3/STM-1
- Shared Interfaces with Cisco 7201, 7301, 7304, 7500, and 7600 routers provides ease of management and investment protection
- Built-in FE/GbE ports on the NPE-G1 and NPE-G2 processors for high-performance LAN connectivity
- Upgradable processors, including NPE-G2 with up to 2 Mpps routing performance
- High-performing, hardware-based encryption support of up to 600 Mbps with the C7200-VSA security module
- Comprehensive management services through Cisco Element Manager Framework (CEMF)

- Increased slot capacity utilizing I/O slot for modules with port adapter jacket card
- Cisco 7201 offers a very compact form factor (1 RU) with up to 2 Mpps routing performance and 4 built-in Gigabit Ethernet ports



Cisco 7301 Series

Enterprise Head Office and Service Provider Environments

Application Versatility

- Application Versatility Managed Network Services, MPLS VPN, broadband aggregation, IP-to-IP Gateway, Mesh Wireless and Public Wireless LAN Solutions, BGP Route Reflector, Large-branch-office router, Enterprise High Speed Internet Gateway, and Secure Internet gateway

Business-class Security VPN

- Stateful inspection firewall
- VPNs: software and hardware encryption, Cisco Easy VPN
- Group Encrypted Transport VPN (GETVPN)
- Service-level validation features
- Intrusion Prevention System (IPS) Multiservice data/voice
- Analog and digital voice
- Survivable Remote Site Telephony (SRST)

Modularity

- Compact, power-efficient 1 RU form factor with single port adapter slot
- Supports over 70 interfaces, providing a comprehensive range of connectivity options from FE to GbE, and DS0 through OC-3/STM-1
- Shared Interfaces with Cisco 7304, 7500, and 7600 series routers providing ease of management and investment protection
- Three onboard Gigabit Ethernet (copper or optical) or Fast Ethernet ports with Pluggable Gigabit Ethernet optics (Small Form-Factor Pluggable [SFP] optics) support
- Front-to-back airflow and single-sided management
- High-performing, hardware based encryption support with new SA-VAM2+ security module
- Comprehensive management services through Cisco Element Manager Framework (CEMF)



Cisco 7304 Series

Enterprise Head Office Environments

- High-performance connectivity up to OC-48 speeds
- Built-in GbE for high-performance LAN connectivity
- Hardware-accelerated services with Parallel Express Forwarding
- Optional redundant processor and power supplies for high availability in a single box solution
- Multiprotocol support

Business-class Security VPN

- Hardware-accelerated Access Control Lists
- Stateful inspection firewall

Modularity

- More than 20 network line cards
- Chassis supports up to 4 line cards or port adapters
- Built in GbE ports on processor
- Support for Cisco port adapters
- Manageability and reliability of Cisco IOS Software



Cisco 7600 Series

Enterprise Head Offices High-end CPE Small Service Provider POP Environments

- Ideal for Enterprise WAN aggregation or service provider environments Business-class Security VPN
- Supports Services modules such as IPsec, firewall, SSL VPN
- Intrusion Prevention System (IPS) Modularity
- Chassis supports up to 4-, 6-, 9-, and 13-slot chassis for redundant supervisors and line cards
- Supervisor engines supporting up to 15 Mpps with broad range of edge services
- Support for Shared Port Adapter (SPA) and SPA Interface Processors (SIP), which offers intelligent services. Supports up to 12 SPA bays
- Support for the Enhanced FlexWAN module, which offers Port Adapter investment protection

Series Overview (continued)



Cisco ASR 1000 Series

Cisco ASR 1000 Series Routers transform and future-proof the network edge for service providers and enterprises by offering industry-leading performance, service capabilities, reliability, and efficiencies in a compact form factor.

- For service providers, the Cisco ASR 1000 Series Routers enable more flexible, efficient, and cost-effective delivery of complex "any play" consumer and business services.
- For enterprises, the Cisco ASR 1000 Series Router transforms the WAN edge into a primary gateway for businesses where information, communication, collaboration, and commerce converge.

The Cisco ASR 1000 Series consists of four different versions, all powered by the Cisco QuantumFlow Processor (QFP):

- ASR 1002 Fixed Router
- ASR 1002 Router
- ASR 1004 Router
- ASR 1006 Router

The Cisco QFP provides a leap in performance and resiliency for route processors. The architecture and performance levels achieved by the Cisco QFP allows applications such as IPsec processing firewall, Cisco Unified Border Element (CUBE) (formerly referred to as Session Border Controller (SB/C)), and others to run natively on the ASR 1000 Series without the need for additional service blades or appliances. The Cisco QFP also provides highly advanced QoS architecture.

The Cisco ASR 1000 Series provides carrier-class reliability and high-availability through a distributed architecture that separates the data plan from control plane functions. The ASR 1006 Router can be configured with redundant Route

Processors (RP) and Embedded Services Processors (ESP) to provide hardware redundancy within the system. Systems with a single RP and ESP (ASR 1002-F, ASR 1002 and ASR 1004 Routers) can run dual instances of IOS within the Linux-based IOS XE operating system for software based redundancy.

Network interfaces on the Cisco ASR 1000 Series are provided by Cisco Shared Port Adaptors (SPAs). These are the same SPAs that are used on all other Cisco platforms. The use of SPAs on the platform gives the customer great flexibility with interface choices and reduced OPEX by not having to spare different components to support the platform.

The WebEx Node SPA, a double-height SPA, supported currently only on the ASR1002, ASR1004, and ASR1006 chassis, maximizes bandwidth efficiency and user experience for WebEx users in the Enterprise.



Cisco Catalyst® 6500 Series

Optimized for secure, converged voice, video, and data networks, the Catalyst 6500 offers industry-leading scalability (32 Gbps to 720 Gbps), operational control, and investment protection to meet the needs of head-end enterprises service aggregation, Internet access, data center interconnectivity, and service providers' POP.

Integrated Security

- Support of integrated multi-gigabit security Services Modules offering intrusion detection and prevention, firewall, scalable IPsec VPN solutions, and Secure Sockets Layer (SSL)

Modularity and Flexibility

- Modular 3-, 4-, 6-, 9-, and 13-slot chassis with support of redundant supervisors and LAN/WAN line cards
- Application intelligence support with PISA technology ensures application performance (NBAR) and security (FPM) in the LAN/WAN network
- Supports WAN interfaces from DS0 to OC-192, 10/100/1000/10GbE with the flexibility of the Shared Port Adaptor (SPA) and SPA Interface Processor (SIP)
- Support of the Enhanced FlexWAN module for investment protection

Manageability

- Subsystem ISSUs with IOS modularity; integrated TDR; Encapsulated Remote Span (ERSPAN); Embedded Event Manager (EEM); Network Analysis Module (NAM); CiscoWorks; CNA

Scalable Performance

- Up to 400 Mpps with a distributed forwarding architecture

Operational Consistency

- Addresses WAN applications and LAN/Core/Distribution/Data Center needs, reducing spares expense and enabling operational efficiencies

Validated Solutions

- LAN/ Distribution/Core/WAN/ DC applications are tested in Safe Harbor for end-to-end proven solutions

Product Transition Matrix

Cisco 850 and 860 Product Comparison

	Cisco 851, 857	Cisco 861, 867
Form Factor	Desktop	Desktop
DRAM (default)	64 MB	256 MB
DRAM (maximum)	64 MB	256 MB
Flash (default)	20 MB	128 MB
Flash (maximum)	20 MB	128 MB
Integrated LAN Switch	4-port Switch	4-port Switch
Integrated Hardware-based Encryption	Yes	Yes
Out of Band Management	External Modem	External Modem
Wireless LAN Option	Integrated 802.11b/g	Integrated 802.11b/g/n
Fast Ethernet WAN	1 Port (851)	1 Port (861)
ADSL2/2+		1 Port (867)

Cisco 870 and 880 Product Comparison

	Cisco 871, 876, 877, 878	Cisco 881, 886, 887, 887V, 888, 888E
Form Factor	Desktop	Desktop
DRAM (default)	128 MB	256 MB or 512 MB (SRST Models)
DRAM (maximum)	256 MB	768 MB
Flash (default)	24 MB	128 MB or 256 MB (SRST Models)
Flash (maximum)	52 MB	128 MB or 256 MB (SRST Models)
Integrated LAN Switch	4-port Switch	4-port Managed Switch
Integrated Hardware-based Encryption	Yes	Yes
Backup Interface	External Modem (871, 877) ISDN S/T BRI (876, 878) (Out of Band Management only on 878)	ISDN S/T BRI (886, 887, 887V, 888, 888E) 3G (all 3G Models)
Wireless LAN Option	Integrated 802.11b/g	Integrated 802.11b/g/n
Fast Ethernet WAN	1 Port (871)	1 Port (881)
ADSL/ADSL2+ over POTS	877	887
ADSL/ADSL2+ over ISDN	877	886

Transition Matrix continued

Cisco 870 and 880 Product Comparison (continued)

	Cisco 871, 876, 877, 878	Cisco 881, 886, 887, 887V, 888, 888E
G.SHDSL (ATM Mode)	878	888
G.SHDSL (EFM Mode)	No	888E
VDSL2	No	887V
FXS	No	4 Port (SRST Models)
FXO	No	1 Port (881SRST)
Voice BRI	No	1 Port (888SRST)
USB Ports for Security Tokens	2 Ports (871)	1 Port
Power over Ethernet Support	Optional	Optional

Cisco Fixed FE WAN 1800/890 Product Comparison

	Cisco 1811, 1812	Cisco 891, 892
Form Factor	Desktop	Desktop
Rack/Wall Mountable	Yes	Yes
DRAM (default)	128 MB	512 MB
DRAM (maximum)	384 MB	512 MB
Flash (default)	32 MB	256 MB
Flash (maximum)	128 MB	256 MB
Integrated LAN Switch	8-port Switch	8-port Switch
Fast Ethernet WAN	2 Ports	1 Port
Gigabit Ethernet WAN	No	1 Port
Back-up WAN	v.92 Modem (1811)/ ISDN S/T BRI (1812)	v.92 Modem (891)/ ISDN S/T BRI (892)
Wireless Option	Integrated 802.11a/b/g	Integrated 802.11a/b/g/n
USB Ports (v 2.0)	2 Ports	2 Ports
Integrated Power over Ethernet Support	Optional	Optional
Real Time Clock	Yes	Yes

Transition Matrix continued

Cisco 1721/1841 Product Comparison

	Cisco 1721	Cisco 1841
Form Factor	Desktop	Desktop (1 RU)
Chassis Type	Plastic	Metal
DRAM (default)	64 MB	128 MB
DRAM (maximum)	128 MB	384 MB
Flash (default)	32 MB	32 MB
Flash (maximum)	32 MB	Up to 128 MB
AC Power Supply	External	Internal
Onboard AIM Slot	0	1
Support for High Speed WICs (HWICs)	No	Yes
LAN Ports	1 10/100	2 10/100
Integrated Hardware-based Encryption	Optional	Yes
USB Ports (v1.1)	No	1
Console Port (Up to 115.2 Kbps)	1	1
Auxiliary Port (Up to 115.2 Kbps)	1	1

Cisco 1751/1760, 2600, and 2800 Product Comparison

	Cisco 1751, 1760	Cisco 2600	Cisco 2800
Form Factor	Desktop and 19" Rack-mount	19" Rack-mount (Up to 2 RU)	19" and 23" Rack-mount Options
DRAM (default)	128 MB	256 MB	256 MB
DRAM (maximum)	128 MB (1751) 160 MB (1760)	256 MB	1 GB
Flash (default)	32 MB	Up to 32 MB	64 MB
Flash (maximum)	64 MB (1760)	Up to 128 MB	Up to 256 MB
Onboard DSP Slot	2	0	Up to 3
Onboard AIM Slot	0	1	2
Support for High Speed WICs (HWICs)	No	No	Yes
LAN Ports	1 10/100	Up to 2 10/100	2 10/100 or 10/100/1000
Integrated Hardware-based Encryption	Optional	Optional	Yes
Integrated Inline Power/ PoE Support	No	No	Yes
USB Ports	No	No	Yes, up to 2
Console Port (Up to 115.2 Kbps)	1	1	1
Auxiliary Port (Up to 115.2 Kbps)	1	1	1

Transition Matrix continued

Notes

Cisco 3700/3800 Product Comparison

	Cisco 3700	Cisco 3800
Form Factor	19" and 23" Rack-mount (2 and 4 RU)	19" and 23" Rack-mount (2 and 4 RU)
DRAM (default)	256 MB	256 MB
DRAM (maximum)	Up to 512 MB (3745)	Up to 1 GB
Flash (default)	32 MB	64 MB
Flash (maximum)	128 MB	Up to 256 MB
Onboard DSP Slot	0	Up to 4
Onboard AIM Slot	2	2
Support for High Speed WICs (HWICs) or Enhanced Network Modules	No	Yes
LAN Ports	2 10/100	2 10/100/1000
Integrated Hardware-based Encryption	Optional	Yes
Integrated Inline Power/PoE Support	Yes (No PoE)	Yes
USB Ports (v1.1)	No	Yes, 2
Console Port (Up to 115.2 Kbps)	1	1
Auxiliary Port (Up to 115.2 Kbps)	1	1

Cisco 860 Series



The Cisco® 860 Series Integrated Services Routers combine Internet access, security, and wireless services onto a single, secure device that is simple to use and manage for small businesses. Cisco 860 Series delivers features, including firewall, IPsec VPNs, and WLANs, at broadband speeds to small offices. Easy deployment and centralized management features enable the Cisco 860 Series to be deployed by service providers in small businesses.

Benefits and Advantages

Integrated Services

Cisco 860 Series Integrated Services Routers are fixed-configuration routers that provide business solutions for secure voice and data communication to small businesses. The Cisco 860 Series offer secure broadband services over Fast Ethernet and ADSL2/2+ WAN links. 802.11n offers LAN mobility and increased productivity. Cisco 860 Series provide the performance required for concurrent services, including firewall, and encryption for VPNs; optional 802.11g/n for mobility; and quality of service (QoS) features for multiple applications. In addition, the Cisco Configuration Professional (CCP) is a Web-based configuration tool that simplifies setup and deployment. Centralized management capabilities give network managers visibility and control of the network configurations at the remote site.

Easy Setup and Deployment

The Cisco Configuration Professional (CCP) Web-based configuration tool simplifies setup and deployment, and centralized management capabilities give network managers visibility and control of router configurations at the remote site. Cisco Configuration Express Service supports factory-loaded configurations in high-volume deployments. Support for the Cisco Configuration Engine enables plug-and-play installations with centralized configuration management.

Remote Management

Cisco 860 Series routers are ideally suited for small office and remote office deployments. Out-of-band management with an external modem through the auxiliary port allows IT managers to remotely manage routers at small office sites to quickly troubleshoot any network issues. Optional integrated secure WLAN connectivity simplifies the number of devices that need to be managed at the remote site. Cisco CCP helps resellers and customers to quickly and easily deploy, configure, and monitor a Cisco access router without knowledge of the Cisco IOS Software Command-Line Interface (CLI).

Security Features

Cisco 860 Security Features

- Secure Connectivity IPsec VPN
- Hardware-accelerated DES, 3DES, AES128, AES192, AES256
- Public Key Infrastructure (PKI) support
- 5 IPsec Tunnels
- Cisco Easy VPN Client and Server
- NAT transparency

Zone-based Policy Firewall

- Stateful Inspection Routing Firewall
- Stateful Inspection Transparent Firewall
- Advanced Application Inspection and Control
- Secure HTTP (HTTPS), FTP, and Telnet Authentication Proxy

WLAN Features

WLAN Hardware

- IEEE 802.11n draft 2.0 standard based access point with 802.11 b/g compatibility
- Automatic rate selection for 802.11g/n
- Captive omnidirectional 2dBi gain omni dipole antennas
- 2x3 MIMO radio operation
- WiFi 802.11n Draft v2.0 certified

WLAN Software Features

- Autonomous Access Point
- WCS support for autonomous configurations
- Maximize throughput or maximize range option
- Software-configurable transmit power
- Radio roles include access point, root bridge, non-root bridge, and workgroup bridge
- Wireless Multi Media Certification (WMM)
- TSPEC Call Admission Control to ensure voice quality is maintained
- Unscheduled Automatic Power Save Delivery (UAPSD) to reduce latency

WLAN Security Features

- 802.11i
- WiFi Protected Access (WPA) & AES (WPA2)
- EAP Authentication: Cisco LEAP, PEAP, EAP-TLS, EAP-FAST, EAP-SIM, EAP-MD5, EAP-TTLS
- Static and dynamic Wired Equivalent Privacy (WEP)
- Temporal Key Integrity Protocol (TKIP)/SSN [Temporal Key Integrity Protocol/Simple Security Network encryption
- MAC authentication/filter
- User database for survivable local authentication using LEAP & EAP-FAST
- Configurable limit to the number of wireless clients
- Configurable RADIUS accounting for wireless clients
- PSK (Pre Shared Keys) (WPA-SOHO)

Network Example

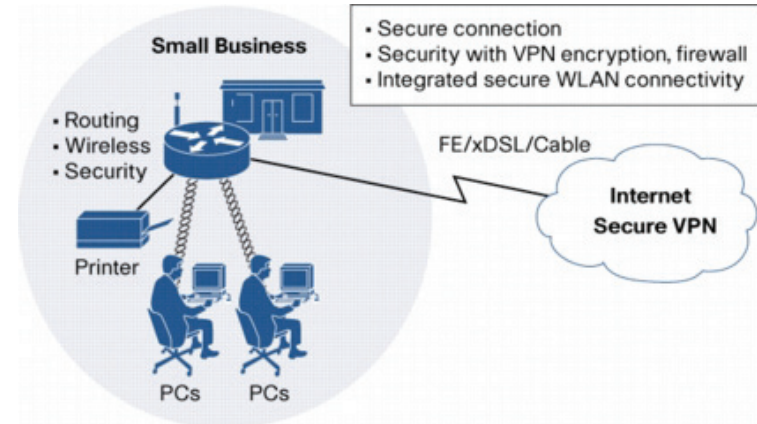

When to Deploy

Deploy the Cisco 860 Series when you need:

- Secure connectivity with stateful inspection firewall and IP Security (IPsec) VPN support for small offices
- 4-port 10/100 switch
- Secure WLAN 802.11b/g/n option with fixed captive omnidirectional 2dBi gain omni dipole antennas
- Easy setup, deployment, and remote management capabilities through Web-based tools and Cisco IOS Software

Series Distinctions

Cisco 860 Series

WAN Technologies	<ul style="list-style-type: none"> Cisco 861 – 100 MB Ethernet Cisco 867 – ADSL over analog telephone lines
LAN Switch	4-port 10/100Base-T switch with autosensing MDI/MDX (Media Device In/Media Device Crossover) for auto-crossover
Security	Stateful firewall, IPsec, and VPNs
WLAN Option	802.11b/g with fixed captive omnidirectional 2dBi gain dipole antennas

Platform Overview

Models	WAN Interface	LAN Interface	802.11b/g
Cisco 861	10/100 Mbps Fast Ethernet	4-port 10/100 Mbps Managed Switch	No
Cisco 861W	10/100 Mbps Fast Ethernet	4-port 10/100 Mbps Managed Switch	Yes
Cisco 867	ADSL	4-port 10/100 Mbps Managed Switch	No
Cisco 867W	ADSL	4-port 10/100 Mbps Managed Switch	Yes

Physical Specifications

Dimensions (H x W x D)	Nonwireless Models: 12.8 x 9.8 x 1.9 in. (325 x 249 x 48 mm) (includes rubber feet)
	12.8 x 9.8 x 1.75 in. (325 x 249 x 44 mm) (without rubber feet)
Weight	Wireless Models: 12.8 x 10.4 x 1.9 in. (325 x 264 x 48 mm) (includes rubber feet)
	12.8 x 10.4 x 1.75 in. (325 x 264 x 44 mm) (without rubber feet; excluding antennas)
	5.5 lb (2.5 kg) maximum

Power Dissipations

AC Input Voltage	100–240 VAC
Frequency	50–60 Hz
Maximum Output Power	60W
Output Voltages	12V DC

Environmental Specifications

Operating Temperature	32 to 104°F (0 to 40°C)
Non-operating Temperature	-4 to 149°F (-20 to 65°C)
Relative Humidity (non-condensing)	5 to 95%
Operating Altitude	0 to 10,000 ft. (0 to 3000m)

Regulatory Compliance

Approvals and Compliance	<ul style="list-style-type: none"> · IEC 60950-1:2005, Second Edition, with all country deviations · AS/NZS 60950-1:2003, First Edition · CAN/CSA 22.2 No. 60950-1-05, Second Edition · UL 60950-1, Second Edition, 2005 · EN55024 · Industry Canada CS-03 · TIA-968-A, Addendum 1, 2, 3, 4, 5 · EMI · VCCI Class II · IEC 1000-3-2 · California Energy Commission (CEC) Compliant · Australia and New Zealand: · Australia AS/ACIF S031: 2001 · Australia AS/ACIF S0431: 2003 · Australia AS/ACIF S0432: 2006 · New Zealand PTC220: 2003
--------------------------	---

Series Specifications

Flash Memory	128 MB
System DRAM Memory	256 MB
External Power Supply	Universal 100–240 VAC
Console Port	RJ-45
802.11b/g WLANs	Optional on both models
LEDs	PPP, VPN, ADSL, WLAN, LAN
Auxiliary Port	Virtual AUX port

Ordering Information

Product Name	Product Number	Product Description
Cisco 861	CISCO861-K9	Cisco 861 Ethernet Security Router
	CISCO861W-GN-A-K9	Cisco 861 Ethernet Security Router with 802.11n FCC Compliant
	CISCO861W-GN-E-K9	Cisco 861 Ethernet Security Router with 802.11n ETSI Compliant
	CISCO861W-GN-P-K9	Cisco 861 Ethernet Security Router with 802.11n Japan Compliant
Cisco 867	CISCO867-K9	Cisco 867 ADSL2/2+ Annex A Router
	CISCO867W-GN-A-K9	Cisco 867 ADSL2/2+ Annex A Router with 802.11n FCC Compliant
	CISCO867W-GN-E-K9	Cisco 867 ADSL2/2+ Annex A Router with 802.11n ETSI Compliant

Note: For Cisco 860 Series wireless router part numbers, the following letters are associated with specifications meeting wireless regulations in the respective regions: A = FCC Compliant, E = ETSI Compliant, P = Japan Compliant.

Cisco 880 Series



Cisco 880 Series Integrated Services Routers are fixed-configuration routers that provide collaborative business solutions for secure voice and data communication to small businesses and enterprise teleworkers. They offer concurrent broadband services over third-generation (3G), Metro Ethernet, and multiple DSL technologies to provide business continuity. Wireless 802.11n and 3G offer LAN and WAN mobility. The routers provide the performance required for concurrent services, including firewall, intrusion prevention, content filtering, and encryption for VPNs; optional 802.11g/n for mobility; and quality-of-service (QoS) features for optimizing voice and video applications. In addition, the web-based Cisco Configuration Professional configuration tool simplifies setup and deployment. Centralized management capabilities give network managers visibility and control of the network configurations at the remote site.

Benefits and Advantages

Increased Performance to Run Concurrent Services

Cisco 880 Series Router performance allows customers to take advantage of broadband network speeds while running secure, concurrent data, voice, video, and wireless services.

Advanced Security

- An integrated stateful and application inspection firewall provides network perimeter security.
- High-speed IPsec 3DES and AES encryption offers data privacy over the Internet.
- Intrusion prevention enforces security policy in a larger enterprise or service provider network.
- Content filtering offers category-based URL classification and blocking, thus providing increased productivity and better use of company resources.

Redundant WAN Links

Redundant WAN links provide business continuity and WAN diversity with multiple WAN links: Fast Ethernet, ADSL2/2+, VDSL2, G.SHDSL, 3G, and ISDN.

4-port 10/100 Mbps Managed Switch

- The Cisco 880 Series allows for connection of multiple devices in a small office, with the ability to designate a port as the network edge.
- An optional external PoE adapter powers IP phones and external access points to avoid individual power supplies or power injectors.
- VLANs allow for secure segmentation of network resources.

Optional 802.11g/n Access Point

- This broadband router offers a secure integrated access point in a single device.
- This integrated WiFi access point offers IEEE 802.11n draft 2.0 standard support for mobile access to high-bandwidth data, voice, and video applications through the use of multiple-input, multiple-output (MIMO) technology that provides increased throughput, reliability, and predictability.
- The Cisco 880 Series supports both autonomous and unified modes.

Benefits and Advantages continued

Cisco SDM and Cisco IOS Software for Remote Management

Using smart wizards and task-based tutorials, Cisco Security Device Manager (SDM) helps resellers and customers quickly and easily deploy, configure, and monitor a Cisco access router without requiring knowledge of the Cisco IOS Software Command-Line Interface (CLI). Dial backup and out-of-band management allow IT managers to remotely manage the router at small office and teleworker sites. Cisco Configuration Express Service supports factory-loaded configurations in high-volume deployments. Support for the Cisco Configuration Engine enables plug-and-play installations with centralized configuration management.

SRST (supported on SRST models)

SRST provides business continuity for voice when the WAN link fails by switching calls to the PSTN.

Cisco Configuration Professional

Cisco Configuration Professional uses smart wizards and task-based tutorials, which resellers and customers can use to quickly and easily deploy, configure, and monitor a Cisco access router without requiring knowledge of the Cisco IOS Software command-line interface (CLI).

Unified Wireless Management

- Configuration and management of access points is automated and simplified without manual intervention.
- A unified hybrid remote-edge access point (HREAP) provides the following:
 - WLAN services to remote and branch offices without deploying a wireless LAN controller at each location.
 - Central configuration and control of unified WLAN services for remote offices through a WAN link.
 - Flexibility in setting up wireless access at remote locations by specifying how traffic is to be bridged or tunneled.

Security Features

Cisco 880 Security Connectivity

- Secure Sockets Layer (SSL) VPN for secure remote access
- Hardware-accelerated DES, 3DES, AES 128, AES 192, and AES 256
- Public-key-infrastructure (PKI) support
- 20 IPsec tunnels
- Cisco Easy VPN Client and Server
- NAT transparency
- DMVPN
- Tunnel-less Group Encrypted Transport VPN (GETVPN)
- IPsec stateful failover
- VRF-aware IPsec
- IPsec over IPv6
- Adaptive control technology
- Session Initiation Protocol (SIP) application layer gateway

Zone-based Policy Firewall

- Stateful inspection transparent firewall
- Advanced application inspection and control
- HTTPS, FTP, and Telnet authentication proxy
- Dynamic and static port security
- Firewall stateful failover
- VRF-aware firewall
- Cisco Easy VPN Client and Server
- IPsec 3DES termination/initiation
- IPsec pass-through
- Point-to-Point Tunneling Protocol (PPTP) pass-through
- L2TP pass-through
- 802.1X
- Secure HTTP (HTTPS), FTP, and Telnet authentication proxies
- Dynamic Multipoint VPN (DMVPN), SSL VPN, and Group Encrypted Transport (GET VPN)

Security Features continued

Content Filtering

- Subscription-based content filtering with Trend Micro
- Support for Websense and Smartfilter
- Cisco IOS Software black and white lists

Integrated Threat Control

- IPS
- Control Plane Policing
- Flexible Packet Matching
- Network foundation protection

WLAN Features

WLAN Hardware

- IEEE 802.11n draft 2.0 standards-based access point with 802.11 b/g compatibility
- Automatic rate selection for 802.11g/n
- Captive omnidirectional 2-dBi gain dipole antennas
- 2 x 3 MIMO radio operation
- Removable antennas on Cisco 881W models
- WiFi 802.11n Draft v2.0 certified

WLAN Software Features

- Autonomous or unified access point
- Cisco WCS support for monitoring of autonomous-mode access points
- Option to maximize throughput or maximize range
- Software-configurable transmit power
- Radio roles, including access point, root bridge, nonroot bridge, and workgroup bridge
- WiFi Multimedia (WMM) certification
- Traffic specifications (TSPEC) Call Admission Control (CAC) to ensure voice quality is maintained
- Unscheduled Automatic Power Save Delivery (UAPSD) to reduce latency

WLAN Security Features

- Standard 802.11i
- WPA and AES (WPA2)
- EAP authentication: Cisco LEAP, PEAP, Extensible Authentication Protocol Transport Layer Security (EAP-TLS), Extensible Authentication Protocol-Flexible Authentication via Secure Tunneling (EAP-FAST), Extensible Authentication Protocol-Subscriber Information Module (EAP-SIM), Extensible Authentication Protocol-Message Digest Algorithm 5 (EAP-MD5), and Extensible Authentication Protocol-Tunneled TLS (EAP-TTLS)
- Static and dynamic Wired Equivalent Privacy (WEP)
- Temporal Key Integrity Protocol/Simple Security Network (TKIP/SSN) encryption

- MAC authentication and filter
- User database for survivable local authentication using LEAP and EAP-FAST
- Configurable limit to the number of wireless clients
- Configurable RADIUS accounting for wireless clients
- Pre-Shared Keys (PSKs) (WPA-small office or home office [WPA-SOHO])

Features on Cisco 880 SRST Series

- SRST 70 and later
- Up to 4 voice channels
- H.323 Versions 1, 2, 3, and 4, Media Gateway Control Protocol (MGCP) 0.1 and 1.0, Skinny Client Control Protocol (SCCP), and SIP call-control protocols
- G.711, G.729, G.729a/b, G.723.1, G.726, and G.728
- Cisco Unified Communications Manager support for analog and digital ports with Releases 6.1(3), 7.0(2), and 7.1(3)
- FXS loop-start and ground-start signaling
- FXO
- Inbound signaling (such as dual-tone multifrequency [DTMF] and multifrequency support)
- BRI QSIG
- Echo cancellation
- Silence suppression and voice activity detection (VAD)
- Comfort-noise generation
- Caller ID support
- Dial-plan mapping
- Fax and modem pass-through
- Fax Relay
- T.37 and T.38 fax protocols

Network Example

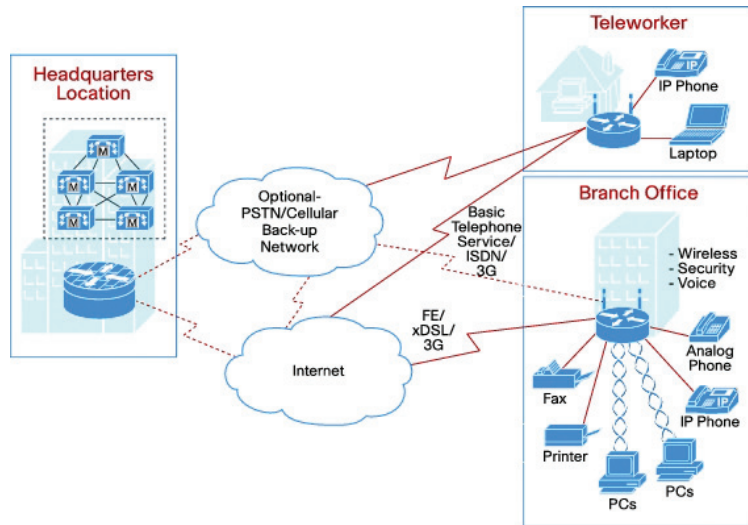

When to Deploy

Deploy the Cisco 880 Series when you need the following in a small remote office, or teleworker and small business sites:

- Secure, concurrent services for broadband connection
- High-speed VPN solution
- Advanced security with firewall, VPNs, IPS, DMVPNs, Easy VPNs, GETVPNs

- Integrated 802.11b/g/n WLAN, in autonomous or Unified Wireless modes
- Four-port 10/100 managed switch
- WAN diversity with ADSL2/2+, G.SHDSL, VDSL2, FE WAN
- WAN redundancy with 3G, or ISDN interfaces
- Unified communications

Series Distinctions

Cisco 880 Series

WAN Technologies	<ul style="list-style-type: none"> Cisco 881 – 100 MB Ethernet Cisco 886 – ADSL over ISDN (ADSL2/ADSL2+) Cisco 887 – ADSL over analog telephone lines (ADSL2/ADSL2+) Cisco 887V – VDSL2 over analog telephone lines Cisco 888 – G.SHDSL (2- and 4-wire support)
LAN Switch	Managed 4-port 10/100Base-T switch with autosensing MDI/MDX (Media Device In/Media Device Crossover) for auto-crossover
Backup Interfaces	Cisco 881G, 886G, 887G, 887VG, 888G – 3G Wireless WAN Cisco 886, 887, 887V, 888 – ISDN BRI
Unified Communications	Cisco 881SRST, 888SRST
802.11g/n	Cisco 881W, 886W, 887W, 887VW, 888W

Platform Overview

Models	WAN Interface	LAN Interfaces	802.11b/g Option	Integrated 3G	Integrated ISDN Dial Backup
Cisco 881	10/100-Mbps Fast Ethernet	4-port 10/100-Mbps managed switch	Yes (Cisco 881W)	Yes (Cisco 881G)	
Cisco 886	ADSL2/2+ over ISDN (Annex B)	4-port 10/100-Mbps managed switch	Yes (Cisco 886W)	Yes (Cisco 886G)	Yes
Cisco 887	ADSL2/2+ over POTS (Annex A)	4-port 10/100-Mbps managed switch	Yes (Cisco 887W)	Yes (Cisco 887G)	Yes
Cisco 887V	VDSL2 over POTS	4-port 10/100-Mbps managed switch	Yes (Cisco 887V)	Yes (Cisco 887VG)	Yes
Cisco 888	G.SHDSL (ATM)	4-port 10/100-Mbps managed switch	Yes (Cisco 888W)	Yes (Cisco 888G)	Yes
Cisco 888E	G.SHDSL (EFM)	4-port 10/100-Mbps managed switch	Yes (Cisco 888W)	No	Yes

Models	WAN Interface	LAN Interfaces	Voice Ports	802.11g/n Option
Cisco 881 SRST	10/100-Mbps Fast Ethernet	4-port 10/100 Mbps managed switch	4 foreign-exchange-station (FXS) ports and 1 foreign-exchange-office (FXO) port for public-switched-telephone-network (PSTN) fallback	Yes (Cisco 881 SRSTW)
Cisco 888 SRST	G.SHDSL	4-port 10/100-Mbps managed switch	4 FXS ports and 1 Basic Rate Interface (BRI) port for PSTN fallback	Yes (Cisco 888 SRSTW)

Platform Overview continued

Physical Specifications

Dimensions (H x W x D)	Nonwireless Models:
	1.9 x 12.8 x 9.8 in. (48 x 325 x 249 mm) (includes rubber feet) 1.75 x 12.8 x 9.8 in. (44 x 325 x 249 mm) (without rubber feet)
	Wireless Models:
	1.9 x 12.8 x 10.4 in. (48 x 325 x 264 mm) (includes rubber feet) 1.75 x 12.8 x 10.4 in. (44 x 325 x 264 mm) (without rubber feet; excludes antennas)
Weight	5.5 lbs. (2.5 kg) maximum

Power Dissipations

AC Input Voltage	100–240 VAC
Frequency	50–60 Hz
Maximum Output Power	60W
Output Voltages	12V DC

Environmental Specifications

Operating Temperature	32 to 104°F (0 to 40°C)
Non-operating Temperature	-4 to 149°F (-20 to 65°C)
Relative Humidity (non-condensing)	5 to 95%
Operating Altitude	0 to 10,000 ft. (0 to 3000 m)

Regulatory Compliance

Approvals and Compliance	Emissions:
	<ul style="list-style-type: none"> · 47 CFR Part 15: 2006 · CISPR22: 2005 · EN300386: V1.3.3: 2005 · EN55022: 2006 · EN61000-3-2: 2000 [Inc amd 1 and 2] · EN61000-3-3: 1995 [+ amd 1: 2001] · ICES-003 Issue 4: 2004 · KN 22: 2005 · VCCI: V-3/2006.04
	Immunity:
	<ul style="list-style-type: none"> · CISPR24: 1997 [+ amd 1 and 2] · EN300386: V1.3.3 : 2005 · EN50082-1: 1992 · EN50082-1: 1997 · EN55024: 1998 [+ amd 1 and 2] · EN61000-6-1: 2001
	The following are supported on teleworker models:
	<ul style="list-style-type: none"> · AS/NRZ 3548: 1992 Class B · CFR 47 Part 15 Class B · EN60555-2 Class B · EN55022 Class B · ICES-003, Issue 2, Class B, April 1997S

Series Specifications

Flash Memory	128 MB on Cisco 880 Series data models 256 MB on Cisco 880 Series SRST models
System DRAM Memory	256 MB on Cisco 880 Series data models 512 MB on Cisco 880 Series SRST models Expandable to 768 MB
External Power Supply	Universal 100 to 240 VAC input; 60W, 12 VDC output
Console Port	RJ-45
802.11b/g WLANs	Optional on all models
3G Specifications	<ul style="list-style-type: none"> · HSPA, UMTS, and GSM (CISCO881G-G-K9 and CISCO881G-A-K9) · 850, 1900, and 2100 MHz UMTS bands · 850 MHz GSM, GPRS, and EDGE band · 900 MHz GSM, GPRS, and EDGE band · 1800 MHz GSM, GPRS, and EDGE band · 1900 MHz GSM, GPRS, and EDGE band · EVDO Rev A/ EVDO/1xRTT (CDMA) (CISCO881G-S-K9 and CISCO8801G-V-K9) · 800 MHz: North American cellular band · 1900 MHz: North American PCS band
LEDs	PPP, VPN, DSL, WLAN, LAN
USB 1.1Ports for Advanced Security Features Such as Security Tokens	1 USB 1.1 port cannot be used for connecting external devices than specified for the Cisco 880 series
Power over Ethernet	Optional Two-port 802.3af and Cisco compliant PoE

High-Availability Features

- Virtual Router Redundancy Protocol (VRRP) (RFC 2338)
- Hot Standby Router Protocol (HSRP)
- Multigroup HSRP (MHSRP)
- Dial backup with external modem through virtual auxiliary port
- Dial backup with ISDN S/T port (DSL models only)
- 3G backup (3G models only)

Ordering Information

Product Name	Product Number	Product Description
Cisco 881	CISCO881-K9	Cisco 881 Ethernet Security Router
	CISCO881-SEC-K9	Cisco 881 Ethernet Security Router with Advanced IP Services
	CISCO881W-GN-A-K9	Cisco 881 Ethernet Security Router with 802.11n FCC Compliant
	CISCO881W-GN-E-K9	Cisco 881 Ethernet Security Router with 802.11n ETSI Compliant
	CISCO881W-GN-P-K9	Cisco 881 Ethernet Security Router with 802.11n Japan Compliant
	CISCO881G-K9	Cisco 881 Ethernet Security Router with 3G
	CISCO881GW-GN-A-K9	Cisco 881 Ethernet Security Router with 3G, 802.11n FCC Compliant
	CISCO881GW-GN-E-K9	Cisco 881 Ethernet Security Router with 3G, 802.11n ETSI Compliant
	C881SRST-K9	Cisco 881 SRST Ethernet Security Router with FXS, FXO
	C881SRSTW-GN-A-K9	Cisco 881 SRST Ethernet Security Router with FXS, FXO; 802.11n FCC Compliant
	C881SRSTW-GN-E-K9	Cisco 881 SRST Ethernet Security Router with FXS, FXO; 802.11n ETSI Compliant
Cisco 881G	CISCO881G-S-K9	Cisco 881G Ethernet Security Router with 3G Sprint
	CISCO881G-V-K9	Cisco 881G Ethernet Security Router with 3G Verizon
	CISCO881G-A-K9	Cisco 881G Ethernet Security Router with 3G GSM North America
Cisco 886	CISCO886-K9	Cisco 886 ADSL2/2+ Annex B Router
	CISCO886-SEC-K9	Cisco 886 ADSL2/2+ Annex B Security Router with Advanced IP Services
	CISCO886W-GN-E-K9	Cisco 886 ADSL2/2+ Annex B Router with 802.11n ETSI Compliant
	CISCO886G-K9	Cisco 886 ADSL2/2+ Annex B Router with 3G
CISCO886GW-GN-E-K9	Cisco 886 ADSL2/2+ Annex B Router with 3G, 802.11n ETSI Compliant	
Cisco 887	CISCO887-K9	Cisco 887 ADSL2/2+ Annex A Router
	CISCO887-SEC-K9	Cisco 887 ADSL2/2+ Annex A Security Router with Advanced IP Services
	CISCO887W-GN-A-K9	Cisco 887 ADSL2/2+ Annex A Router with 802.11n FCC Compliant

Ordering Information continued

Product Name	Product Number	Product Description
Cisco 887	CISCO887W-GN-E-K9	Cisco 887 ADSL2/2+ Annex A Router with 802.11n ETSI Compliant
	CISCO887M-K9	Cisco 887 ADSL2/2+ Annex M Router
	CISCO887MW-GN-E-K9	Cisco 887 ADSL2/2+ Annex M Router with 802.11n ETSI Compliant
	CISCO887G-K9	Cisco 887 ADSL2/2+ Annex A Router with 3G
	CISCO881G-K9	Cisco 881 Ethernet Security Router with 3G
	CISCO881GW-GN-A-K9	Cisco 881 Ethernet Security Router with 3G, 802.11n FCC Compliant
	CISCO881GW-GN-E-K9	Cisco 881 Ethernet Security Router with 3G, 802.11n ETSI Compliant
	C881SRST-K9	Cisco 881 SRST Ethernet Security Router with FXS, FXO
	C881SRSTW-GN-A-K9	Cisco 887 ADSL2/2+ Annex A Router with 3G, 802.11n FCC Compliant
	CISCO887GW-GN-E-K9	Cisco 887 ADSL2/2+ Annex A Router with 3G, 802.11n ETSI Compliant
	CISCO887V-K9	Cisco 887 VDSL2 over POTS Router
CISCO887V-SEC-K9	Cisco 887 VDSL2 over POTS Security Router with Advanced IP Services	
Cisco 887V	CISCO887VW-GNA-K9	Cisco 887V VDSL2 Router with 802.11n FCC Compliant
	CISCO887VW-GNE-K9	Cisco 887V VDSL2 Router with 802.11n ETSI Compliant
	CISCO887VG-K9	Cisco 887V VDSL2 Router with 3G
	CISCO887VGW-GNA-K9	Cisco 887V VDSL2 Router with 3G, 802.11n FCC Compliant
	CISCO887VGW-GNE-K9	Cisco 887V VDSL2 Router with 3G, 802.11n ETSI Compliant
Cisco 888	CISCO888-K9	Cisco 888 G.SHDSL Router
	CISCO888-SEC-K9	Cisco 888 G.SHDSL Security Router with Adv IP Services
	CISCO888W-GN-A-K9	Cisco 888 G.SHDSL Router with 802.11n FCC Compliant
	CISCO888W-GN-E-K9	Cisco 888 G.SHDSL Router with 802.11n ETSI Compliant
	C888SRST-K9	Cisco 888 SRST Ethernet Security Router with FXS, FXO; 802.11n ETSI Compliant
	C888SRST-K9	Cisco 888 SRST G.SHDSL Router with FXS, BRI
C888SRSTW-GN-A-K9	Cisco 888 SRST G.SHDSL Router with FXS, BRI; 802.11n FCC Compliant	
C888SRSTW-GN-E-K9	Cisco 888 SRST G.SHDSL Router with FXS, BRI; 802.11n ETSI Compliant	

Ordering Information continued

Product Name	Product Number	Product Description
Cisco 888E	CISCO888E-K9	Cisco 888E G.SHDSL Router with 802.3ah EFM Support
	CISCO888E-SEC-K9	Cisco 888E G.SHDSL Security Router with Advanced IP Services and 802.3ah EFM Support
	CISCO888EW-GN-A-	Cisco 888E G.SHDSL Router with 802.11n FCC Compliant and 802.3ah EFM Support
	CISCO888EW-GN-E-K9	Cisco 888E G.SHDSL Router with 802.11n ETSI Compliant and 802.3ah EFM Support
	CISCO888G-K9	Cisco 888E G.SHDSL Router with 3G
	CISCO888GW-G-NA-K9	Cisco 888E G.SHDSL Router with 3G, 802.11n FCC Compliant
	CISCO888GW-G-NE-K9	Cisco 888E G.SHDSL Router with 3G, 802.11n ETSI Compliant

Ordering Information continued

Part Number	Product Description
800-IL-PM=2	2 port 802.3af Capable Inline Power Module for 880 Routers
MEM8XX-256U512D	256-MB DRAM upgrade to 512 MB for Cisco 880 Series Routers MEM8XX-256U768D
MEM8XX-256U768D	512-MB DRAM Upgrade to 768 MB for Cisco 880 Series Routers
MEM8XX-512U768D	512-MB DRAM Upgrade to 768 MB for Cisco 880 Series Routers
PCEX-3G-CDMA-V	Cisco 3G EVDO Modem-Verizon Network
PCEX-3G-CDMA-S	Cisco 3G EVDO Modem-Sprint Network
PCEX-3G-CDMA	Cisco 3G EVDO Modem
PCEX-3G-HSPA-A	Cisco HSPA Modem-North America
PCEX-3G-HSPA	Cisco 3G HSPA Modem
S880DUDK9*	Cisco 880 Series IOS Universal Data
S880VUDK9*	Cisco 880 Series IOS Universal Voice
SL-880-ADSEC (default)	Cisco 880 Advanced Security Image Feature License
SL-880-AIS (upgrade option)	Cisco 880 Advanced IP Services Image Feature License
Software License for Cisco 880 SRST	
SL-SRST880-AIS (included by default)	Cisco 880 Advanced IP Services Image Feature License
SL-CNFIL-88x-1Y	One year subscription to Content Filtering for Cisco 881/888-URL/Phishing
SL-CNFIL-8xx-TRI	30 day free trial license for 88x series
FL-WEBVPN-10-K9	Feature License SSL VPN for Up to 10 Users (incremental)
C880data-universalk9-mz	Universal Image for Cisco 880 ISR Data Router Series
C880voice-universalk9-mz	Universal Image for Cisco 880 SRST Router Series
ap801-k9w7-tar	Autonomous Software Image for ap801
ap801-rcvk9w8-tar	LWAPP Recovery Image for ap801

Cisco 890 Series



Cisco 890 Series Integrated Services Routers are fixed-configuration routers that provide collaborative business solutions for secure voice and data communications to enterprise small branch offices. They are designed to deliver secure broadband, Metro Ethernet, wireless LAN (WLAN) connectivity, and business continuity. The routers also come with powerful management tools, such as the web-based Cisco Configuration Professional configuration management tool, which simplifies setup and deployment. Centralized management capabilities give network managers visibility and control of the network configurations at the remote site.

Benefits and Advantages

Increased Performance for Concurrent Services

Router performance allows customers to take advantage of broadband network speeds while running secure, concurrent data, voice, video, and wireless services.

Integrated Gigabit and Fast Ethernet WAN Ports

Integrated ports offer flexibility in Ethernet WAN access, and the additional capability to deploy redundant WAN connections for failover protections and load balancing.

Integrated 8-port 10/100 BASE-T Managed Switch

Fully managed LAN switch ports connect multiple LAN devices and reduce the need for an additional LAN switch.

Integrated WAN Backup

ISDN BRI S/T (Cisco 892) or analog modem (Cisco 891) port provides high availability by establishing a backup WAN connection if the primary connection fails.

Optional Dual-radio/Dual-band IEEE 802.11n Access Point

- The Cisco 890 Series offers a secure, integrated access point in a single device. It supports both autonomous and unified modes. It is backward-compatible with 802.11a/b/g.
- The router supports IEEE 802.11n draft 2.0 and uses multiple-input, multiple-output (MIMO) technology that provides increased throughput, reliability, and predictability.

Enhanced Security

- An integrated stateful and application inspection firewall provides network perimeter security.
- High-speed IPsec 3DES and AES encryption offers data privacy over the Internet.
- Intrusion prevention enforces security policy in a larger enterprise or service provider network.
- Content filtering offers category-based URL classification and blocking, thus providing increased productivity and better use of company resources.

Benefits and Advantages continued

Unified Wireless Management

- Configuration and management of access points is automated and simplified without manual intervention.
- A unified hybrid remote-edge access point (HREAP) provides the following:
 - WLAN services to remote and branch offices without deploying a wireless LAN controller at each location
 - Central configuration and control of unified WLAN services for remote offices through a WAN link
 - Flexibility in setting up wireless access at remote locations by specifying how traffic is to be bridged or tunneled

Cisco Configuration Professional

Cisco Configuration Professional uses smart wizards and task-based tutorials, which reseller and customers can use to quickly and easily deploy, configure, and monitor a Cisco access router without requiring knowledge of the Cisco IOS Software CLI.

Security Features

Cisco 890 Security Connectivity

- Secure Sockets Layer (SSL) VPN for secure remote access
- Hardware-accelerated DES, 3DES, AES 128, AES 192, and AES 256
- Public-key-infrastructure (PKI) support
- 20 IPsec tunnels
- Cisco Easy VPN Client and Server
- NAT transparency
- DMVPN
- Tunnel-less Group Encrypted Transport VPN (GETVPN)
- IPsec stateful failover
- VRF-aware IPsec
- IPsec over IPv6
- Adaptive control technology
- Session Initiation Protocol (SIP) application layer gateway

Zone-based Policy Firewall

- Stateful inspection transparent firewall
- Advanced application inspection and control
- HTTPS, FTP, and Telnet authentication proxy
- Dynamic and static port security
- Firewall stateful failover
- VRF-aware firewall

Content Filtering

- Subscription-based content filtering with Trend Micro
- Support for Websense and Smartfilter
- Cisco IOS Software black and white lists

Integrated Threat Control

- IPS
- Control Plane Policing
- Flexible Packet Matching
- Network foundation protection

WLAN Features

WLAN Hardware

- IEEE 802.11n draft v2.0 standards-based access point with 802.11 a/g compatibility
- Automatic rate selection for 802.11a/g/n
- Noncaptive RPTNC omnidirectional dipole antennae: 2 dBi gain @ 2.4 GHz, 5 dBi gain @ 5GHz
- 2x3 MIMO radio operation
- WiFi 802.11n Draft v2.0 certified

WLAN Software Features

- Autonomous or unified access point
- Cisco WCS support for monitoring of autonomous-mode access points
- Option to maximize throughput or maximize range
- Software-configurable transmit power
- Radio roles, including access point, root bridge, nonroot bridge, and workgroup bridge
- WiFi Multimedia (WMM) certification
- Traffic specifications (TSPEC) Call Admission Control (CAC) to ensure voice quality is maintained
- Unscheduled Automatic Power Save Delivery (U-PSD) to reduce latency

WLAN Security Features

- Standard 802.11i
- WPA and AES (WPA2)
- EAP authentication: Cisco LEAP, PEAP, Extensible Authentication Protocol Transport Layer Security (EAP-TLS), Extensible Authentication Protocol-Flexible Authentication via Secure Tunneling (EAP-FAST), Extensible Authentication Protocol-Subscriber Information Module (EAP-SIM), Extensible Authentication Protocol-Message Digest Algorithm 5 (EAP-MD5), and Extensible Authentication Protocol-Tunneled TLS (EAP-TTLS)
- Static and dynamic Wired Equivalent Privacy (WEP)
- Temporal Key Integrity Protocol/Simple Security Network (TKIP/SSN) encryption
- MAC authentication and filter
- User database for survivable local authentication using LEAP and EAP-FAST
- Configurable limit to the number of wireless clients
- Configurable RADIUS accounting for wireless clients
- Preshared keys (PSKs) (WPA-small office or home office [WPA-SOHO])

Metro Ethernet Features

- One 1000 BASE-T Gigabit Ethernet WAN port
- One 10/100 BASE-T Fast Ethernet WAN port
- Intelligent hierarchical quality of service (HQoS): Supports hierarchical queuing and shaping
- Connectivity Fault Management (CFM), based on 802.1ag
- 802.3ah standard based Link operational administration and maintenance (OAM)
- Ethernet Local Management Interface (E-LMI) for the Customer Edge
- CFM Interworking and backwards compatibility
- Performance Management based on IP service-level agreement (SLA) for Ethernet

Network Example

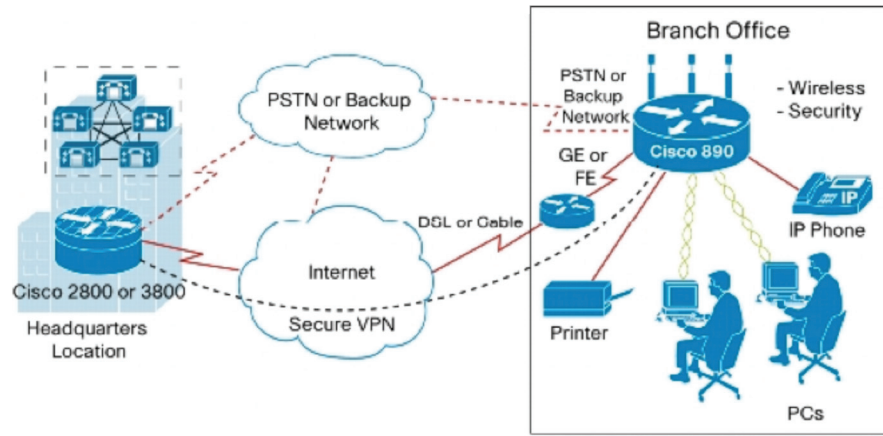

When to Deploy

Deploy the Cisco 890 Series when you need the following in a small branch office, or small business sites:

- Secure, concurrent services for broadband connection
- High-speed VPN solution

- Advanced security with firewall, VPNs, IPS, DMVPNs, Easy VPNs, GETVPNs
- Metro Ethernet service
- Integrated 802.11a/b/g/n WLAN, in autonomous or Unified Wireless modes
- Eight-port 10/100 managed switch

Platform Overview

Models	WAN Interface	LAN Interfaces	802.11a/g/n Option	Integrated USB 2.0/ AUX/ Console	Integrated Dial Backup
Cisco 891	1-port GE 1-port FE	4-port 10/100-Mbps Managed Switch	Yes	Yes/Yes/Yes	V.92 Analog Modem
Cisco 892	1-port GE 1-port FE	4-port 10/100-Mbps Managed Switch	Yes	Yes/Yes/Yes	ISDN BRI

Platform Overview continued

Physical Specifications

Dimensions (H x W x D)	Nonwireless Models:	1.9 x 12.8 x 9.8 in. (48 x 325 x 249 mm) (includes rubber feet)
		1.75 x 12.8 x 9.8 in. (44 x 325 x 249 mm) (without rubber feet)
	Wireless Models:	1.9 x 12.8 x 10.4 in. (48 x 325 x 264 mm) (includes rubber feet)
		1.75 x 12.8 x 10.4 in. (44 x 325 x 264 mm) (without rubber feet; excludes antennas)

Weight	5.5 lbs. (2.5 kg) maximum
--------	---------------------------

Power Dissipations

AC Input Voltage	100–240 VAC
Frequency	50–60 Hz
Maximum Output Power	60W
Output Voltages	12V DC

Environmental Specifications

Operating Temperature	32 to 104°F (0 to 40°C)
Non-operating Temperature	-4 to 149°F (-20 to 65°C)
Relative Humidity (non-condensing)	5 to 95%
Operating Altitude	0 to 10,000 ft. (0 to 3000 m)

Regulatory Compliance

Approvals and Compliance	Emissions:
	• 47 CFR Part 15: 2006
	• CISPR22: 2005
	• EN300386: V1.3.3: 2005
	• EN55022: 2006
	• EN61000-3-2: 2000 [Inc amd 1 & 2]
	• EN61000-3-3: 1995 [+ amd 1: 2001]
	• ICES-003 Issue 4: 2004
	• KN 22: 2005
	• VCCI: V-3/2006.04
Immunity:	
• CISPR24: 1997 [+ amd 1 & 2]	
• EN300386: V1.3.3: 2005	
• EN50082-1: 1992	
• EN50082-1: 1997	
• EN55024: 1998 [+ amd 1 & 2]	
• EN61000-6-1: 2001	

Series Specifications

Flash Memory	256 MB
System DRAM Memory	512 MB (Expandable to 768 MB)
External Power Supply	Universal 100 to 240 VAC input; 60W, 12 VDC output
Console Port	RJ-45
802.11b/g WLANs	Optional on all models
USB 2.0	<ul style="list-style-type: none"> Two USB 2.0 ports USB devices supported: <ul style="list-style-type: none"> USB eTokens USB Flash
Power over Ethernet	Optional internal adapter for inline PoE on 4 switch ports for IP phones or external wireless access points; 802.3af compliant and Cisco PoE compliant

Notes

High-Availability Features

- Virtual Router Redundancy Protocol (VRRP) (RFC 2338)
- HSRP
- MHSRP
- Dial backup with external modem through virtual auxiliary port
- Dial backup with ISDN S/T or V.92 Analog modem port

Ordering Information

Part Number	Product Description
Integrated Services Routers	
CISCO891-K9	Cisco 891 Gigabit Ethernet Security Router
CISCO891W-AGN-A-K9	Cisco 891W Gigabit Ethernet Security Router w/ 802.11n FCC Compliant
CISCO891W-AGN-N-K9	Cisco 891W Gigabit Ethernet Security Router w/ 802.11n Australia Compliant
CISCO892-K9	Cisco 892 Gigabit Ethernet Security Router
CISCO892W-AGN-E-K9	Cisco 892W Gigabit Ethernet Security Router w/ 802.11n ETSI Comp
MEM8XX-512U768D	512 MB DRAM upgrade to 768 MB for Cisco 890 Series routers
C890-universalk9-mz	Universal image for Cisco 890 Series routers
ap801-k9w7-tar	Autonomous software image for ap801
ap801-rcvk9w8-tar	Lightweight Access Point Protocol (LWAPP) recovery image for ap801
800-IL-PM-4	4-port 802.3af capable internal power module for Cisco 890 Series routers
SL-CNFIL-890-1Y	One year subscription to Content Filtering for Cisco 890 Series routers
SL-CNFIL-8xx-TRI	30-day free trial license for Cisco 890 Series routers
FL-WEBVPN-25-K9	Feature license SSL VPN for up to 25 users (incremental)

Cisco 1800 Series (Fixed-Configuration)



Cisco is redefining best-in-class enterprise and small- to medium-sized business routing with a new line of Integrated Services Routers that are optimized for the secure delivery of data services. Founded on 20 years of leadership and innovation, the Cisco 1800 Series Integrated Services Routers intelligently embed data, security, and wireless technology into a single, resilient system for fast, secure, scalable delivery of mission-critical business applications. The Cisco 1800 Series architecture has been specifically designed to meet requirements of small- to medium-sized businesses (SMBs), small enterprise branch offices, and service provider-managed services applications for delivery of concurrent services for broadband access. The integrated secure systems architecture of the Cisco 1800 Series delivers maximum business agility and investment protection.

Benefits and Advantages

Cisco 1800 Series Integrated Services Routers are the next evolution of the award-winning Cisco 1700 Series modular and fixed-configuration routers. The Cisco 1801, 1802, 1803, 1811, and 1812 Integrated Services Routers are fixed-configuration, while the Cisco 1841 Integrated Services Router is modular. The routers are designed for secure broadband, Metro Ethernet, and wireless connectivity, and provide significant performance improvements, feature capability, versatility, and additional value compared to prior generations of Cisco 1700 Series. The Cisco 1800 Series fixed-configuration routers provide:

- Secure broadband access with concurrent services for branch and small offices
- Integrated ISDN Basic Rate S/T Interface (BRI), analog modem, or Ethernet backup port for redundant WAN links and load balancing
- Secure wireless LAN option for simultaneous 802.11a and 802.11b/g with use of two dual-mode antennas
- Advanced security including: Stateful Inspection Firewall, IP Security (IPsec) VPNs (Triple Data Encryption Standard [3DES] or Advanced Encryption Standard [AES]), Intrusion Prevention System (IPS), Antivirus support through Network Admission Control (NAC) and enforcement of secure access policies

- 8-port 10/100 managed switch with 802.1q VLAN support and optional Power over Ethernet (PoE)
- Easy deployment and remote-management capabilities through Web-based tools and Cisco IOS Software

Cisco 1801, 1802, and 1803 routers provide high-speed DSL broadband access through asymmetric DSL (ADSL) over basic telephone service (Cisco 1801), ADSL over ISDN (Cisco 1802), or Symmetrical High-Data-Rate DSL (G.SHDSL) (Cisco 1803) while helping to ensure reliable networking with integrated ISDN S/T BRI backup. The Cisco 1811 and 1812 provide high-speed broadband or Ethernet access through two 10/100BASE-T Fast Ethernet WAN ports and also provide integrated WAN backup through a V.92 analog modem (Cisco 1811) or ISDN S/T BRI interface (Cisco 1812).

Benefits and Advantages continued

The Cisco 1800 Series fixed-configuration routers help enable a network infrastructure for SMBs and enterprise small branch offices, providing access to the Internet, corporate headquarters, or other remote offices, while securing and protecting critical data with integrated Cisco IOS Software security features and capabilities. They also help businesses reduce costs by enabling deployment of a single device to provide multiple services

(integrated router with redundant link, LAN switch, firewall, VPN, IPS, wireless technology, and Quality of Service [QoS]) typically performed by separate devices. Cisco IOS Software allows this flexibility, providing the industry's most robust, scalable, and feature-rich internetworking support, using the accepted standard networking software for the Internet and private WANs.

Security Features

Cisco IOS Firewall

- Stateful firewall with URL filtering
- Per-user authentication and authorization
- Real-time alerts
- Transparent firewall
- IPv6 firewall

VPN

- Advanced Encryption Standard (AES) 128, 192, and 256
- Triple Data Encryption Standard (3DES), and DES encryption
- Embedded hardware-based VPN acceleration on the motherboard
- Cisco Easy VPN remote and server support
- Dynamic Multipoint VPN (DMVPN)
- Group Encrypted Transport VPN (GET VPN)

Onboard USB Port

- USB 2.0 ports (2) (Cisco 1811 and 1812 models only)

IPS

- More than 700 IPS signatures supported in Cisco IOS Software, with the ability to load and enable selected IPS signatures

URL Filtering

- Local URL filtering in Cisco IOS Software based on external server (Websense and N2H2)
- Stateful firewall contains URL filtering

Cisco SDM

- Cisco Router and Security Device Manager (SDM)

IOS WebVPN (SSL VPN)

- Secure remote access for mobile users without installing PC client software
- Integrated into the router—no separate appliance required
- Cisco 1801 and 1812 supports up to 10 users
- Requires IOS WebVPN feature license FL-WEBVPN-10
- Requires an IOS security feature set (IOS security feature set is included in all secure router bundles)

Security Application Example

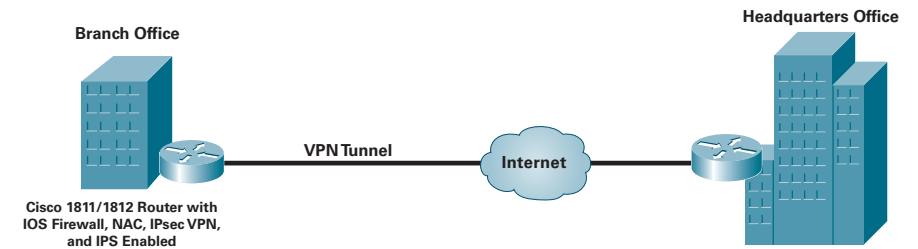

Wireless

Integrated Wireless LAN Capability

Cisco 1800 Series of fixed-configuration routers includes models with an integrated wireless access point, providing secure router and secure wireless LAN services in one device, helping businesses reduce total cost of ownership with simplified WLAN deployment and management capabilities. The integrated wireless access point supports IEEE 802.11a/b/g simultaneously to provide high-speed wireless capability and flexibility to support 2.4 GHz and 5 GHz dual-band simultaneous operation, making them ideal choices for hotspot deployments and wireless office solutions. WiFi Certified client devices including Cisco Aironet, WiFi Certified and Cisco Compatible client devices are fully supported.

The Cisco 1800 Series routers with integrated wireless access points are WiFi certified and support WPA and WPA2 providing secure mutual authentication and encryption via Cisco IOS Software features to meet the strict demands of

today's businesses. These products also provide support for multiple BSSIDs (8) and multiple wireless VLANs (16 with 8 encrypted) that can be configured to provide additional security, segmentation, and separation of user groups. When using the routers in conjunction with the Cisco Service Selection Gateway (SSG) and Subscriber Edge Services Manager (SESM), managed service providers can incorporate service-based authorization and accounting, and service and subscriber management for customizable, on-demand wireless services such as hotspots. Additional features such as Universal Client mode allow the router to wirelessly connect to an AP (such as an outdoor wireless Mesh network) and local authentication allow users to maintain wireless connectivity to the router in the event that a remote authentication server goes down. Quality of Service (QoS) via WiFi Multimedia (WMM) is also supported.

Wireless Example

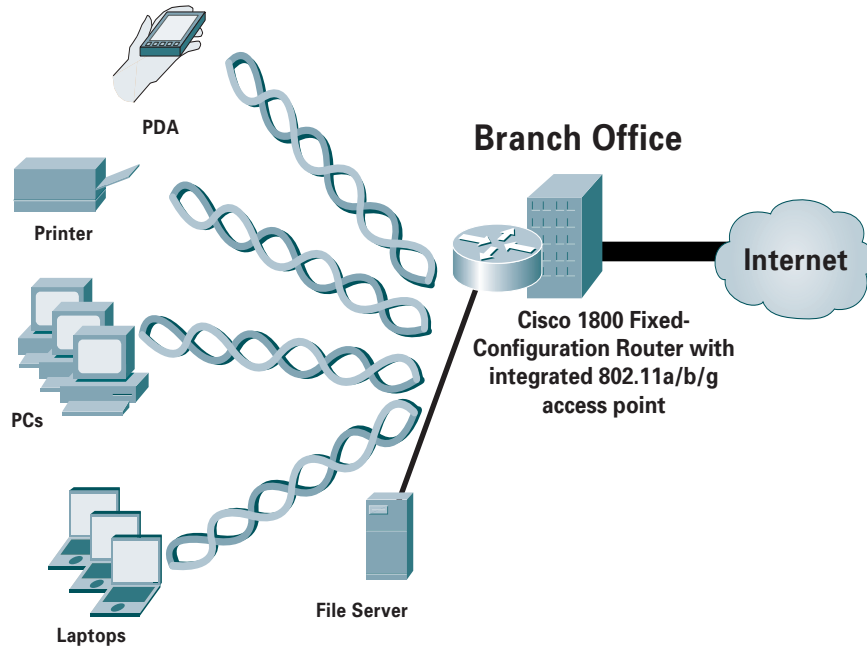

When to Deploy

Deploy the Cisco 1800 Series fixed-configuration routers when you need:

- An application-specific configured router
- Fully integrated DSL/Security/Wireless router
- To support high performance Internet access
- High availability Internet connections and load balancing
- Easy to order products
- Ability to connect several LAN devices

High-Availability Features

The Cisco IOS Software Advanced IP Services feature set offers basic and advanced routing capabilities to deliver failover protection and load balancing. These capabilities include Border Gateway Protocol (BGP), Open Shortest Path First (OSPF) Protocol, Enhanced Interior Gateway Routing Protocol (EIGRP), and Routing Information Protocol (RIP) routing protocols along with dial-on-demand routing (DDR) Reliable Static Routing Using Object Tracking. Each of the Cisco 1800 Series fixed-configuration routers is equipped with either an ISDN BRI, V.92 analog modem, or Ethernet port for secondary WAN backup connection. If the primary DSL, cable, or Ethernet-access WAN experiences a link failure or loss of connectivity, the router will detect this failure and will fail over to the secondary backup WAN. The Cisco 1800 Series fixed-configuration routers help enable customers to deliver high-performance and high-availability, mission-critical business applications.

High-Availability Features Example

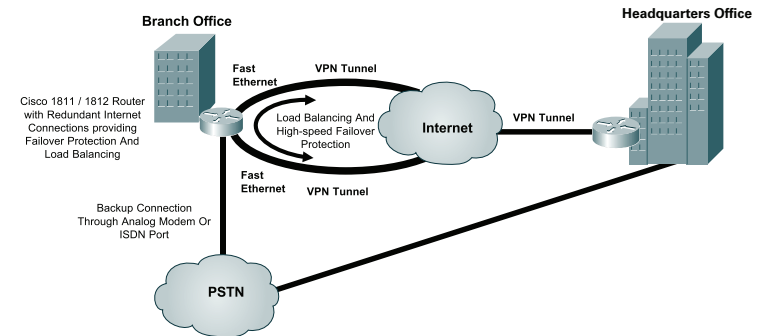

Platform Overview

Models	FE WAN Ports	Switch Ports	WAN	Wireless Option	DRAM (MB) Default Max	Compact Flash (MB) Default Max	Power Supply
Cisco 1801	1	8	ADSL	Yes	256	384	64 128 AC
Cisco 1802	1	8	ADSLoISDN	Yes	256	384	64 128 AC
Cisco 1803	1	8	G.SHDSL	Yes	256	384	64 128 AC
Cisco 1805	2	4	DOCSIS 2.0	Yes	256	384	64 128 AC
Cisco 1811	2	8	10/100 Ethernet	Yes	256	384	64 128 AC
Cisco 1812	2	8	10/100 Ethernet	Yes	256	384	64 128 AC

Series Specifications

Dimensions (H x W x D)	12.5 x 9.5 in. (34.3 x 274 cm)
Console Port	1 (up to 115.2 Kbps)
Auxiliary Port	1 (up to 115.2 Kbps)
USB Port	2 (USB 2.0) on Cisco 1811 and 1812 only. The Cisco 1801, 1802, and 1803 do not offer USB support
Wireless LAN	IEEE 802.11a,b,g (W models)
V.92 Analog Modem Port	One analog modem port on Cisco 1805 and 1811
Integrated Channel Service Unit/Data Service Unit (CSU/DSU)	No, see Cisco 1841
Voice/Data Support	Only data support
Encryption	Hardware support on motherboard (3DES and AES)
10/100 Switch Ports	8 10/100BASE-T fully managed switch ports with 802.3af PoE support 4 10/100BASE-T fully managed switch ports with 802.3af PoE support (Cisco 1805 Model only)
Integrated Modems	1 (Cisco 1805 and 1811 models only) V.92
Default 10/100 WAN Ports	1 (Cisco 1801, 1802, 1803, and 1812 models), 2 (Cisco 1805, 1811 and 1812 models)
ISDN Basic Rate Interface (BRI) Ports S/T	1 (Cisco 1801, 1802, 1803, and 1812 models only)

Ordering Information

Product Number	Product Description
CISCO1801	ADSL over POTS router with 8-port 10/100BASE-T switch, ISDN S/T backup, Cisco IOS IP broadband, 32 MB Flash, and 128 MB DRAM
CISCO1801-M	ADSL over POTS Annex M router with 8-port 10/100BASE-T switch, ISDN S/T backup, Cisco IOS IP broadband, 32 MB Flash, and 128 MB DRAM
CISCO1805-D	DOCSIS 2.0 with 4 Port FE switch, 64 MB Flash, 128 MB DRAM
CISCO 1805-D/K9	DOCSIS 2.0 with 4 Port FE switch, 64 MB Flash, 192 MB DRAM and Advanced IP Services IOS
CISCO1801/K9	ADSL over POTS router with 8-port 10/100BASE-T switch, ISDN S/T backup, Cisco IOS Advanced IP Services, 32 MB Flash, and 128 MB DRAM
CISCO1801-M/K9	ADSL over POTS Annex M router with 8-port 10/100BASE-T switch, ISDN S/T backup, Cisco IOS Advanced IP Services, 32 MB Flash, and 128 MB DRAM
CISCO1802	ADSL over POTS router with 8-port 10/100BASE-T switch, ISDN S/T backup, Cisco IOS IP broadband, 32 MB Flash, and 128 MB DRAM
CISCO1802/K9	ADSL over ISDN router with 8-port 10/100BASE-T switch, ISDN S/T backup, Cisco IOS Advanced IP Services, 32 MB Flash, and 128 MB DRAM
CISCO1803/K9	G.SHDSL router with 8-port 10/100BASE-T switch, ISDN S/T backup, Cisco IOS Advanced IP Services, 32 MB Flash, and 128 MB DRAM
CISCO1811/K9	Security router with dual 10/100 WAN ports, 8-port 10/100BASE-T switch, V.92 analog modem backup, Cisco IOS Advanced IP Services, 32 MB Flash, and 128 MB DRAM
CISCO1812/K9	Security router with dual 10/100 WAN ports, 8-port 10/100BASE-T switch, ISDN S/T backup, Cisco IOS Advanced IP Services, 32 MB Flash, and 128 MB DRAM
CISCO1801W-AG-B/K9	ADSL over POTS router with 8-port 10/100BASE-T switch, ISDN S/T backup, Cisco IOS Advanced IP Services, 32 MB Flash, and 128 MB DRAM, and integrated FCC-compliant 802.11a,b,g wireless capability
CISCO1801W-AG-C/K9	ADSL over POTS router with 8-port 10/100BASE-T switch, ISDN S/T backup, Cisco IOS Advanced IP Services, 32 MB Flash, and 128 MB DRAM, and integrated China-compliant 802.11a,b,g wireless capability
CISCO1801W-AG-N/K9	ADSL over POTS router with 8-port 10/100BASE-T switch, ISDN S/T backup, Cisco IOS Advanced IP Services, 32 MB Flash, and 128 MB DRAM, and integrated Australia/NZ compliant 802.11a,b,g wireless capability

Notes

Cisco 1800 Series (Cisco 1841 Router Modular)



Cisco is redefining best-in-class enterprise and small- to medium-sized business (SMB) routing with a line of Integrated Services Routers that are optimized for the secure, wire-speed delivery of data services. Founded on 20 years of leadership and innovation, Cisco 1800 Series Integrated Services Routers intelligently embed data and security into a single, resilient system for fast, scalable delivery of mission-critical business applications. The Cisco 1800 Series architecture has been specifically designed to meet requirements of SMBs, small enterprise branch offices, and service-provider-managed services applications for delivery of concurrent secure data services at wire-speed performance. The integrated, secure systems architecture of the Cisco 1800 Series delivers maximum business agility and investment protection.

Benefits and Advantages

Enhanced Architecture

The Cisco 1841 Integrated Services Router provides secure data connectivity at up to one T1/E1/xDSL WAN connectivity rates. It provides significant additional value compared to prior generations of Cisco 1700 Series routers by offering more than a five-fold performance increase, integrated onboard hardware-based encryption enabled by an optional Cisco IOS Software security image, and a dramatic increase in interface card slot performance and density. Support for one internal Advanced Integration Module (AIM) slot is provided for additional hardware-accelerated encryption and scalability. The modular architecture on the Cisco 1841 router also supports two high-speed WAN interface card (HWIC) slots which significantly increase data-throughput capability (up to 800 Mbps aggregate). The Cisco 1841 also offers integrated dual high-speed Ethernet LAN ports to allow LAN segmentation and to help enable connectivity speeds up to 100BASE-T Ethernet technology. Ample default memory (Flash, SDRAM) is provided to support deployment of concurrent services.

Flexibility and Investment Protection

The modular architecture of the Cisco 1841 router offers a wide variety of LAN and WAN options; interface cards and modules are field-upgradable to accommodate future technologies. The Cisco

1841 delivers investment protection with support for more than 30 modules and interface cards, including existing WICs and voice WAN interface cards (VWICs—on the Cisco 1841 router for data support only) as well as Advanced Integration Modules (AIM). This Integrated Services Router provides 2 slots that are WIC/HWIC/VWIC (data) capable and enables multiple services on an integrate-as-you-grow basis.

Market-leading Integrated Security

A primary component of the Cisco Self-defending Network, the Cisco 1841 Integrated Services Router ships with the industry's most comprehensive security services embedded within the router that can be enabled with a Cisco IOS Security Image. This provides customers with a single, resilient platform to rapidly deploy secure networks and applications. The Cisco 1800 Series was designed with integrated security to provide a tight coupling among security, routing, and other integrated services throughout the network. With a Cisco IOS Software-based VPN, firewall, and intrusion prevention system (IPS), as well as optional enhanced VPN acceleration, and Network Admission Control (NAC) support for anti-virus defense, the Cisco 1841 offers a robust and adaptable security solution for branch-office routers. Every Cisco 1800 Series router comes with the factory-installed Cisco Router and Security Device Manager (SDM). Cisco SDM is an

Benefits and Advantages continued

intuitive, Web-based device manager that offers easy router configuration and monitoring, startup wizards for quick deployment and lock-down, smart wizards to help enable security and routing features, Cisco Technical Assistance Center (TAC)-approved router configurations, and subject-related educational content.

Integrated Services

By providing integrated services, as well as great modular density and high performance, the Cisco 1841 router provides security, versatility, scalability, and flexibility for multiple applications to the small- to-medium-sized business, small

enterprise branch office, and the service provider customer edge. The Cisco 1841 router easily accommodates several network applications, such as secure branch-office data access (including NAC for antivirus defense), VPN access and firewall protection, business-class DSL, IPS support, inter-VLAN routing, and serial device concentration. The Cisco 1841 router provides customers with the industry's most flexible, secure, and adaptable infrastructure to meet both today's and tomorrow's business requirements for maximum investment protection.

Security Features

IPsec VPN

- Advanced Encryption Standard (AES) 128, 192, and 256; Triple Data Encryption Standard (3DES); and DES cryptology support
- Embedded hardware-based VPN acceleration on the motherboard
- Cisco Easy VPN remote
- Cisco Easy VPN server
- Dynamic Multipoint VPN (DMVPN)
- Virtual Tunnel Interfaces (VTI)
- 802.1x
- VPN QoS—Preclassification support
- Support for up to 800 IPsec tunnels using the AIM-VPN/SSL-1

Multiprotocol Label Switching (MPLS) VPN Support

- Support for VRF-lite and VRF aware IPsec

Cisco IOS IPS

- Inline ability to drop packet, reset connection, locally shun, or send an alarm
- Dynamically load and enable selected attack signatures in the same manner as Cisco IPS Appliances

Cisco IOS Firewall

- Feature rich, stateful firewall
- Per-user authentication and authorization
- Real-time alerts
- Transparent firewall
- IPv6 firewall
- VRF-aware firewall
- Advanced Application Inspection and Control
 - HTTP inspection engine
 - E-mail inspection engines (SMTP, ESMTP, IMAP, POP)

IOS WebVPN (SSL VPN)

- Secure remote access for mobile users without installing PC client software
- Integrated into the router—no separate appliance required
- Cisco 1841 supports up to 25 users

Security Features continued

- Requires IOS WebVPN feature license FL-WEBVPN-10 or FL-WEBVPN-25
- Requires an IOS security feature set (IOS security feature set is included in all secure router bundles)

Network Foundation Protection

- Control Plane Policing (CPP)
- AutoSecure
- Secure Shell (SSH)
- Access Control List (ACL)
- Command-Line Interface (CLI)
- Committed Access Rate (CAR)

URL Filtering

- Local URL filtering in Cisco IOS software based on external server

Onboard USB 1.1 Port

- Single onboard USB 1.1 port
- Secure token and Flash memory support

Security Solutions

- Network Admission Control (NAC)

Optional Security Modules

- VPN and Encryption Advanced Integration Modules (AIM-VPN/SSL-1)

Cisco Router and Security Device Manager (SDM)

- Ships by default

Certifications

- ICSA IPsec
- ICSA Firewall
- Common Criteria IPsec (EAL4) (in process)
- Common Criteria Firewall (EAL4+) (in process)
- FIPS 140-2, Level 2 (in process)

Security Example

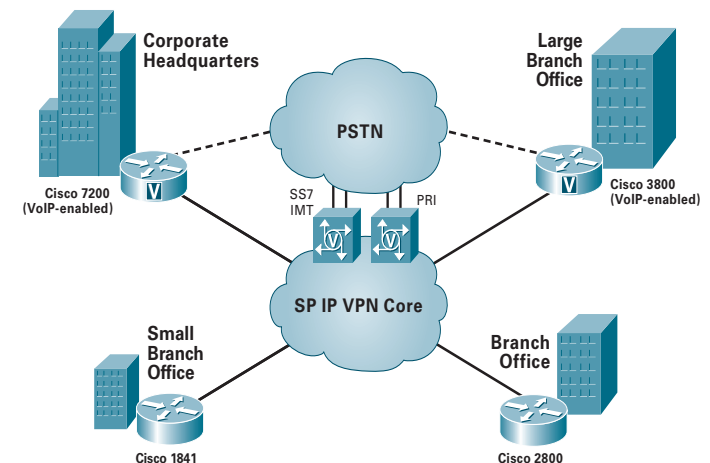

Branch office Network Admission Control (NAC) helps ensure that every endpoint complies with network security policies before being granted access, protecting the network from viruses and worms.

When to Deploy

Deploy the Cisco 1841 Router when you need:

- Performance and densities for concurrent data and security services up to one T1/E1/xDSL WAN connectivity rates
- The flexibility to add or change WAN services to support changing needs and applications, including serial T1, E1, ISDN and broadband DSL, etc.
- VPN connections, or plan to migrate to them over time
- Low density (up to four ports) of integrated 10/100 switching
- Integrated security services as part of the Cisco Self-Defending Network, which enable network device protection, threat defense, secure connectivity, and endpoint protection and control
- Advanced management for security, routing, Quality of Service (QoS), and switching services with Cisco SDM Version 2.0

Platform Overview

	Fixed LAN Ports	HWIC Slots	AIM Slots	PVDM* Slots	NME* Slots	EVM* Slots	DRAM (MB)		Flash (MB)		Power Supply
							Default	Max	Default	Max	
Cisco 1841	2	2	1	0	0	0	128	384	32	128	AC

*NME = Enhanced Network Module; EVM = Extension Voice Module; PVDM = Packet Voice/Digital Signal Processor Module

Series Specifications

Dimensions (H x W x D)	1.73 x 13.5 x 10.8 in. (43.9 x 343 x 274 mm)
Console Port	1 (up to 115.2 Kbps)
Auxiliary Port	1 (up to 115.2 Kbps)
USB Port	1
Integrated Channel Service Unit/Data Service Unit (CSU/DSU)	Yes, with optional T1/E1, Fractional T1/E1, 56k/64k support
Voice/Data Support	Only data support
Compression	Software and hardware
Encryption	Hardware support on motherboard; optional AIM for enhanced performance
Maximum 10/100 Switch Ports	4 (without onboard Fast Ethernet ports)
Maximum Integrated Modems	4
Maximum ISDN Basic Rate Interface (BRI) Ports	2

Ordering Information

Product Number Product Description

Cisco 1800 Series Base Chassis Part Numbers

CISCO1841	Cisco 1800 Series Modular Router with two integrated Fast Ethernet slots, two WAN slots, IP BASE, 32 MB of Flash memory and 128 MB of DRAM
-----------	--

Product Bundles

Product Number Product Description

HSEC Bundles

CISCO1841-HSEC/K9	Cisco 1841 Security Bundle with IOS Advanced IP Services Image, AIM-VPN/SSL-1, 64 MB Flash/256 MB DRAM, 10 User SSL License
-------------------	---

Security

CISCO1841-SEC/K9	Cisco 1841 security bundle with advanced security, 64 MB Compact Flash/256 MB DRAM
CISCO1841-HSEC/K9	Cisco 1841 security bundle with AIM-VPN/SSL-1 Advanced IP Services, 64 MB Compact Flash/256 MB DRAM
CISCO1841-T1SEC/K9	Cisco 1841 security bundle with WIC-1DSU-T1-V2, Advanced Security, 64 MB Compact Flash/256 MB DRAM

Broadband Bundles

CISCO1841-ADSL	Cisco 1841 asymmetric DSL (ADSL) over POTS (ADLSO POTS) bundle, IP broadband, 32 MB Compact Flash/128 MB DRAM
CISCO1841-ADSL2	Cisco 1841 bundle, HWIC-1ADSL, IOS IP Broadband, 32 MB Flash/128 MB DRAM
CISCO1841-ADSL2-B	Cisco 1841 bundle, HWIC-ADSL-B/ST, IOS IP Broadband, 32 MB Flash/128 MB DRAM
CISCO1841-ADSLI	Cisco 1841 ADSLoSDN bundle, IP broadband, 32 MB Compact Flash/128 MB DRAM
CISCO1841-ADSL-DG	Cisco 1841 ADSLoPOTS bundle with Dying Gasp, IP broadband, 32 MB Compact Flash/128 MB DRAM
CISCO1841-SHDSDL-V3	Cisco 1841 bundle, WIC-1SHDSL-V3, IOS IP Broadband, 32 MB Flash/128 MB DRAM
CISCO1841-2SHDSL	Cisco 1841 2-pair G.SHDSL bundle, HWIC-2SHDSL, IP Base, 64 MB Flash/128 MB DRAM
CISCO1841-4SHDSL	Cisco 1841 4-pair G.SHDSL bundle, HWIC-2SHDSL, IP Base, 64 MB Flash/128 MB DRAM

T1 Bundles

CISCO1841-T1	Cisco 1841 T1 bundle, advanced security, 32 MB Compact Flash/128 MB DRAM
--------------	--

3G Bundles

C1841-3G-G	1841 bundle w/HWIC-3G-GSM, IP Base, 64FL/128DR
C1841-3G-V	1841 bundle w/HWIC-3G-CDMA-V, IP Base, 64FL/128DR
C1841-3G-S	1841 bundle w/HWIC-3G-CDMA-S, IP Base, 64FL/128DR
C1841-3G-G-SEC/K9	Cisco 1841, HWIC-3G-GSM, 64MB Flash /256MB DRAM, Adv Security
C1841-3G-V-SEC/K9	Cisco 1841, HWIC-3G-CDMA-V, 64MB Flash /256MB DRAM, Adv Security
C1841-3G-S-SEC/K9	Cisco 1841, HWIC-3G-CDMA-S, 64MB Flash /256MB DRAM, Adv Security



Cisco 1800 Series (Cisco 1861 Router Modular)

Cisco 1861 is a new platform focused on unified communications to the Cisco 1800 Series Integrated Services Routers portfolio. This new, affordable unified communications system makes anytime, anywhere secure access to information possible, thereby facilitating more effective and efficient ways of communicating with customers and employees.

The award-winning Cisco integrated services router is the ideal platform for delivering IP communications in enterprise branch offices, commercial offices, and small- and medium-sized business (SMB) offices. Through the integration of voice gateway, call processing, voicemail, Automated-Attendant, conferencing, transcoding, and security capabilities, Cisco integrated services router platforms deliver a complete office unified communications solution.

Benefits and Advantages

Product Overview

The Cisco 1861 Integrated Services Router, which is part of the Cisco 1800 Series Integrated Services Router portfolio, is a unified communications solution for SMBs and enterprise small branch offices that provides voice, data, voicemail, Automated-Attendant, video, and security capabilities while integrating with existing desktop applications such as calendar, e-mail, and customer relationship management (CRM) programs. This easy-to-manage platform takes full advantage of business-class, proven unified communications technologies and supports flexible deployment models based on your needs—a wide array of IP phones, public switched telephone network (PSTN) interfaces, and Internet connectivity.

Core components include the following:

- Integrated Cisco Unified Communications Manager Express or Cisco Unified Survivable Remote Site Telephony (SRST) for call processing
- Optional Cisco Unity® Express for voice messaging and Automated Attendant

- Integrated LAN switching with Power over Ethernet (PoE)-expandable through Cisco Catalyst® Switches
- Optional support for range of High-Speed WAN interface cards (HWICs)
- Optional security with firewall, VPN, Secure Sockets Layer (SSL), and intrusion prevention system (IPS) capabilities

Converged IP Communications

The Cisco 1861 Integrated Services Router can meet the IP communications needs of SMB and enterprise small branch offices while concurrently delivering an industry-leading level of security within a single communications system. The Cisco 1861 offers the Cisco Unified Communications Manager Express (CME) integrated as default through Cisco IOS® Software that provides call processing for Cisco IP phones. This solution is targeted at customers interested in deploying a converged IP telephony solution for up to 8 IP phones, and need an integrated WAN for data connectivity. Figure 2 illustrates the CME application for a standalone business using the

Benefits and Advantages continued

Cisco 1861 Integrated Services Router. With the Cisco 1861, you can securely deploy data, voice, and IP telephony on a single platform for your small to medium-sized branch offices, helping them streamline their operations and lower their network costs.

As the enterprise extends its IP telephony deployments from central sites to remote offices, one of the critical factors in achieving a successful deployment is the ability to support backup call control at the remote branch office. Cisco Unified SRST provides a cost-effective solution for supporting redundant call control in the remote branch office..

Cisco Unity Express

The optional embedded Cisco Unity Express helps enable voicemail, desktop messaging, and Automated-Attendant services for increased customer service and rich employee communications experience.

Cisco Unified CallConnectors for Desktop Applications

The Cisco 1861 Integrated Services Router integrates with common Windows desktop applications to give small business owners access to productivity gains once available only to large businesses. With Cisco Unified CallConnectors, you can integrate your Cisco Unified IP phones with common applications, including Microsoft Outlook, Internet Explorer, Microsoft Dynamics CRM, or Salesforce.com CRM.

Secure Network Connectivity for Data, Voice, and Video

Security has become a fundamental element of any network. Routers play an important role in any network defense strategy because security needs to be embedded throughout the network. The Cisco 1861 Integrated Services Router features advanced, integrated, end-to-end security for the

delivery of converged services and applications. With the optional Cisco IOS Software Advanced IP Services feature set, the Cisco 1861 provides a robust array of common security features such as a Cisco IOS Software Firewall, intrusion prevention, IPsec VPN, SSL VPN, advanced application inspection and control, Secure Shell (SSH) Protocol Version 2.0, and Simple Network Management Protocol Version 3 (SNMPv3) in one secure solution set. Additionally, by integrating security functions directly into the router itself, Cisco can provide unique intelligent security solutions other security devices cannot, such as Network Admissions Control (NAC) for antivirus defense; Voice and Video Enabled VPN (V3PN) for quality of service (QoS) enforcement when combining voice, video, and VPN; and Dynamic Multipoint VPN (DMVPN), Group Encrypted Transport (GET) VPN, and Easy VPN for enabling more scalable and manageable VPN networks. As Figure 4 demonstrates, a Cisco 1861 uniquely helps customers deliver concurrent, mission-critical data, voice, and video applications with integrated, end-to-end security at wire-speed performance.

LAN Switching

The Cisco 1861 Integrated Services Router has an integrated, managed Ethernet switch that provides 8 ports of 10/100 PoE. Additionally, the system capacity can be expanded by connecting the recommended Cisco Catalyst portfolio of switches.

Platform Features and Benefits

The Cisco 1861 Integrated Services Router is an all-in-one unified communications solution that integrates voice, data, video, and security into one platform. It brings unified communications to SMBs and enterprise small branch offices by providing a simplified, affordable solution that is easy to configure, deploy, and manage. By combining call control, messaging, and security into one device, the Cisco 1861 eliminates the added costs of multiple servers and provides a solution that is easy to set up and manage at a lower price point.

Platform Overview

Features	Details
Solution Packaging	<ul style="list-style-type: none"> Both foreign exchange office (FXO) and Basic Rate Interface (BRI) fixed configurations are offered for both Cisco Unified CME + Cisco Unity Express and Cisco Unified SRST applications. Each configuration is equipped with the appropriate number of feature licenses for call processing and voicemail, simplifying the product structure. The appropriate number of fixed digital signal processors (DSPs) is packaged with each configuration.
Modularity	<ul style="list-style-type: none"> A high-speed WIC (HWIC) slot is available for data WAN integration through a select list of HWICs. The default Cisco IOS Software image SP Services K9 can be upgraded to optional advanced images.
Ethernet Connectivity with QoS	<ul style="list-style-type: none"> Ethernet connectivity is provided for IP phones or wireless access points by PoE ports that provide connectivity speeds for up to 100BASE-T Ethernet technology without the need for additional power modules. Most Cisco Unified IP phones include a 10/100 switch with QoS to provide PC desktop connectivity to the network. Optimized QoS is provided for IP phone and desktop configurations. The QoS level helps ensure that voice over IP (VoIP) traffic takes precedence. Voice and data traffic travels in preconfigured VLANs Port security is provided to limit unauthorized access to the network.
Power Failover	<ul style="list-style-type: none"> A power failover feature is provided on the base configuration, giving access to the public switched telephone network (PSTN) lines in case of a power outage. When power is lost, FXO PSTN trunks are directly connected to foreign exchange station (FXS) analog ports, allowing for calls to be placed and received.
Recorded Announcements for Callers: Music on Hold (MOH)	<ul style="list-style-type: none"> The process for providing customized MOH announcements is simplified with a dedicated MOH port, allowing small-business owners to play recorded announcements to their callers by simply plugging the audio source into the provided 3.5 mm mini-jack. Customers can also use wave files stored on flash memory. MOH is an audio stream that is played to PSTN and VoIP G.711 or G.729 callers who are placed on hold by the phone user. This audio reassures the callers that they are still connected to the called party.
Deployment Options	<ul style="list-style-type: none"> The Cisco 1861 can be deployed as a desktop unit, wall-mounted, or installed in a standard 19-inch (48.26 cm) rack with an optional rack-mount kit.

Cisco Unified Communications Features

IP telephony is currently undergoing tremendous growth, accelerated by access to value-added features and applications that only IP telephony can provide to the end user. Additionally, the cost benefits of converging data, voice, and video on a single network are adding to the rapid acceptance of this technology. Because it is integrated into a single system, the Cisco 1861 Integrated Services Router for SMBs and enterprise small branch offices enhances the advantages of convergence by offering the following unique benefits:

- **Cost-effective operations through a single, integrated voice-and-data platform for all SMB and enterprise branch office needs:** This highly reliable platform provides robust QoS and the right level of security, encryption, and firewall to deliver enhanced VPN services to meet small-business needs. The system delivers integrated IP telephony, voicemail, and Automated-Attendant functions, allowing you to deploy one device to address all your business needs—thereby simplifying management, maintenance, and operations and delivering a lower total cost of ownership (TCO).

- **Sophisticated key system and private branch exchange (PBX) capabilities:**

SMBs and enterprise branch offices have different workflows and require specialized features to support their work practices. The Cisco 1861 delivers a robust set of telephony features for the small office and delivers unique, value-added capabilities through the Extensible Markup Language (XML). These capabilities, which cannot be delivered by traditional systems, enhance the productivity of the end user and the business.

- **Remote maintenance and troubleshooting:**

You can use the industry-standard Cisco IOS Software Command-Line Interface (CLI) or user-friendly GUI to configure and administer the Cisco 1861 Integrated Services Router system.

The Cisco 1861 Integrated Services Router appliance in the first phase offers the feature set available with Cisco Unified Communications Manager Express 4.1 and Cisco Unity Express 2.3.

IP Telephony Support Overview summarizes the unified communications features.

IP Telephony Support Overview

Features	Details
IP Phone Support	Onboard PoE switch ports can be used to power Cisco IP phones.
PVDM Support	Onboard support analog and digital voice, conferencing, transcoding, and secure Real-Time Transport Protocol (RTP) applications. This feature is not upgradable.
Integrated Call Processing	Cisco Unified Communications Manager Express (CME v4.2) is embedded in Cisco IOS Software at first customer shipment (FCS) and provides call processing for Cisco IP phones. Cisco CME delivers telephony features similar to those that are commonly used by business users to meet the requirements of the small to medium-sized offices. For additional information about Cisco Unified Communications Manager Express features, please visit http://www.cisco.com/go/ccme .
Integrated Voicemail and Automated Attendant	An integrated voicemail and Automated-Attendant solution using Cisco Unity Express v2.3 is available optionally as a factory option. Up to 8 mailboxes and 5 general delivery mailboxes are available with the Cisco Unity Express option. For additional information about Cisco Unity Express features, please visit http://www.cisco.com/go/cue .
PSTN Interfaces Support	Onboard voice ports integrated into the system by default include interfaces for PSTN: PBX; and key system connections, including FXS, FXO, and BRI.
Cisco Unified SRST	Branch offices can take advantage of centralized call control while cost-effectively providing local branch backup using SRST redundancy for unified communications. For additional information about Cisco Unified SRST features, please visit http://www.cisco.com/go/srst .

Platform Overview

Security is a fundamental element of any network, and Cisco products play an important role in embedding security at the customer's access edge. The optional Cisco IOS Software security features for the Cisco 1861 Integrated Services Router are activated with hardware-based encryption on the motherboard and provide a robust array of features such as Cisco IOS Firewall,

IP Security (IPsec) VPNs (Digital Encryption Standard [DES], Triple DES [3DES], and Advanced Encryption Standard [AES]), SSL Web VPN, SSHv2.0, and SNMP in one solution set.

Secure Networking Overview summarizes the enhanced security functions available through the optional security image.

Secure Network Overview

Features	Details
Cisco IOS Software Firewall	Sophisticated security and policy enforcement provides features such as stateful, application-based filtering (context-based access control), per-user authentication and authorization, real-time alerts, transparent firewall, and IPv6 firewall.
SSL	SSL provides security for Web transactions by handling authentication, data encryption, and digital signatures.
Onboard VPN Encryption Acceleration	The Cisco 1861 supports IPsec DES; 3DES; and AES 128, 192, and 256 cryptology by using an optional security image.
Network Admission Control (NAC)	A Cisco Self-Defending Network initiative, NAC seeks to dramatically improve the ability of networks to identify, prevent, and adapt to threats by allowing network access only to compliant and trusted endpoint devices.
Multiprotocol Label Switching (MPLS) VPN Support	The Cisco 1861 supports specific provider edge functions plus a mechanism to extend customers' MPLS VPN networks out to the customer edge with a Virtual Route Forwarding (VRF) firewall and VRF IPsec. For details about the MPLS VPN support on the different integrated services routers, please check the feature navigator tool at: http://www.cisco.com .
IPS	Flexible and high-performance support is offered through Cisco IOS Software. IPS offers the ability to load and enable selected intrusion detection system (IDS) signatures in the same manner as Cisco IDS Sensor Software.
Advanced Application Inspection and Control	Cisco IOS Firewall includes HTTP and several e-mail inspection engines that can be used to detect misuse of port 80 and e-mail connectivity.
Cisco Easy VPN Remote and Server Support	The Cisco 1861 eases administration and management of point-to-point VPNs by actively pushing new security policies from a single headend to remote sites.
DMVPN	DMVPN is a Cisco IOS Software solution for building IPsec + Generic routing encapsulation (GRE) VPNs in an easy and scalable manner.
GET VPN	GET VPN is a Cisco IOS Software solution that simplifies securing large Layer 2 or MPLS networks requiring partial or full-mesh connectivity by providing tunnel-less VPN connectivity.
URL Filtering	URL filtering is available externally with a PC server running the URL filtering software.
Standard 802.1x Support on Integrated Switching	Standard 802.1x applications require valid access credentials that make unauthorized access to protected information resources and deployment of unsecured wireless access points more difficult.
Network Address Translation (NAT)	NAT simplifies and reduces costs associated with global IP address allocation and management. Only a single registered IP address is required to support all users on an entire LAN infrastructure.

Cost-of-Ownership and Ease-of-Use Features

The Cisco 1861 continues the heritage of offering versatility, integration, and power to branch offices. The platform offers many enhancements to help enable the support of multiple services in the branch office, as shown in Cost-of-Ownership and Ease-of-Use Overview.

IP Telephony Support Overview

Features	Details
Integrated Channel Service Unit/Data Service Unit (CSU/DSU), Add/Drop Multiplexers, Firewall, Modem, Compression, and Encryption	These features consolidate typical communications equipment found in branch office wiring closets into a single, compact unit, providing better manageability because it saves space.
Cisco IOS IP Service-Level Agreements (IP SLAs)	With Cisco IOS IP SLAs, you can verify service guarantees, increase network reliability by validating network performance, proactively identify network problems, and increase return on investment (ROI) by easing the deployment of new IP services.
Cisco IOS Software Warm Reboot	This feature reduces system boot time and decreases downtime caused by Cisco IOS Software reboots.
CiscoWorks Support	This feature offers advanced management and configuration capabilities through a Web-based GUI.
Cisco AutoInstall	This feature configures remote routers automatically across a WAN connection to save the cost of sending technical staff to the remote site.
Cisco IOS Embedded Event Manager (EEM)	This feature enables automation of many network management tasks and directs the operation of Cisco IOS Software to increase availability, collect information, and notify external systems or personnel about critical events.

When to Deploy

Deploy the Cisco 1861 when you need:

- Unified communications solutions for SMB office, commercial offices and enterprise small branch offices for up to 8 IP phone users
- Integrated Cisco Unified Communications Manager Express or Cisco Unified Survivable Remote Site Telephony (SRST) for call processing
- Optional Cisco Unity® Express for voice messaging and Automated Attendant
- Integrated WAN for data connectivity with the flexibility to add or change WAN services to support changing needs and applications, including serial, T1/E1, and broadband DSL/Cable modem or 3G, etc.
- Integrated LAN switching with eight ports of 10/100 Power over Ethernet (PoE)-expandable through Cisco Catalyst® Switches
- Integrated security services such as firewall, VPN, SSL and Intrusion Prevention System capabilities (IPS)
- As part of the Cisco Self-Defending Network, which enable network device protection, threat defense, secure connectivity, and endpoint protection and control

1861 Summary

The Cisco 1861 Integrated Services Router, which is part of the Cisco 1800 Series, is an all-in-one, affordable unified communications platform targeted at SMBs and enterprise small branch offices with up to 8 employees. It takes advantage of industry-leading, business-class, proven unified communications technologies (voice, data, video, and security) integrated into one platform and facilitates integration with commonly used desktop applications such as Microsoft Outlook and Outlook Express, IBM Lotus Notes, and CRM software. Functions include Automated Attendant and voicemail, PSTN and Internet connectivity, and analog phone and fax machine support. A wide array of IP phones are supported by PoE ports. The Cisco 1861 Integrated Services Router solution also provides the capability to network the office for voice, video, and data networking and allows business owners and employees to be securely connected to the office while they are traveling or working from their home offices.

Product Number	Product Description
C1861-SRST-C-F/K9	Cisco 1861 Voice Bundle with IOS SP Services, PVDM2-32, Inbuilt CUE, 8 Feature Licenses (SRST and CUE), 4 FXS ports, 4 FXO ports, 8 Power Over Ethernet (PoE) ports, 128MB Flash/256MB DRAM
C1861-SRST-C-B/K9	Cisco 1861 Voice Bundle with IOS SP Services, PVDM2-32, Inbuilt CUE, 8 Feature Licenses (SRST and CUE), 4 FXS ports, 2 BRI ports, 8 Power Over Ethernet (PoE) ports, 128MB Flash/256MB DRAM
C1861-SRST-F/K9	Cisco 1861 Voice Bundle with IOS SP Services, PVDM2-32, 8 SRST Feature Licenses, 4 FXS ports, 4 FXO ports, 8 Power Over Ethernet (PoE) ports, 128MB Flash/256MB DRAM
C1861-SRST-B/K9	Cisco 1861 Voice Bundle with IOS SP Services, PVDM2-32, 8 SRST Feature Licenses, 4 FXS ports, 2 BRI ports, 8 Power Over Ethernet (PoE) ports, 128MB Flash/256MB DRAM
C1861-UC-4FXO-K9	Cisco 1861 Unified Communications Bundle with IOS SP Services, PVDM2-32, Inbuilt CUE, 8 User Licenses (CCME, CUE and Phone User licenses), 4 FXS ports, 2 BRI ports, 8 Power Over Ethernet (PoE) ports, 128MB Flash/256MB DRAM
C1861-4F-VSEC/K9	Cisco 1861 Unified Communications Bundle with IOS Advanced IP Serv, PVDM2-32, Inbuilt CUE, 8 User Licenses (CCME, CUE and Phone User licenses), 2 Unified CallConnector Personal Licenses, 4 FXS ports, 4 FXO ports, 8 Power Over Ethernet (PoE) ports, 128MB Flash/256MB DRAM
C1861-2B-VSEC/K9	Cisco 1861 Unified Communications Bundle with IOS Advanced IP Serv, PVDM2-32, Inbuilt CUE, 8 User Licenses (CCME, CUE and Phone User licenses), 2 Unified CallConnector Personal Licenses, 4 FXS ports, 2 BRI ports, 8 Power Over Ethernet (PoE) ports, 128MB Flash/256MB DRAM



Cisco 1900 Series Integrated Services Routers

Cisco® 1900 Series Integrated Services Routers build on 25 years of Cisco innovation and product leadership. The new platforms are architected to enable the next phase of branch-office evolution, providing rich media collaboration and virtualization to the branch while maximizing operational cost savings. The Integrated Services Routers Generation two platforms are future-enabled with multi-core CPUs, Gigabit Ethernet switching with enhanced POE, and new energy monitoring and control capabilities while enhancing overall system performance. Additionally, a new Cisco IOS® Software Universal image and Services Ready Engine module enable you to decouple the deployment of hardware and software, providing a stable technology foundation which can quickly adapt to evolving network requirements. Overall, the Cisco 1900 Series offer unparalleled total cost of ownership savings and network agility through the intelligent integration of market leading security, unified communications, wireless, and application services.

Cisco® 1941 builds on the best-in-class offering of the existing Cisco 1841 Integrated Services Routers by offering two models-Cisco 1941 and Cisco 1941W. In addition to the support of a wide range of wireless and wired connectivity options supported on Cisco 1941 Series, Cisco 1941W offers integration of IEEE 802.11n access point which is backwards compatible with IEEE 802.11a/b/g access points.

All Cisco 1900 Series Integrated Services Routers offer embedded hardware encryption acceleration, optional firewall, intrusion prevention, and application services. In addition, the platforms support the industries widest range of wired and wireless connectivity options such as T1/E1, xDSL, 3G, and GE.

Benefits and Advantages

Services on Demand

The Cisco 1900 Series Integrated Services Routers extend this leadership in total cost of ownership by reducing initial capital outlays by decoupling the delivery of software from hardware on optional service modules. In addition, customers receive a Universal IOS image, capable of enabling all of Cisco's rich IOS features allowing you to quickly deploy new services without having to download a new IOS image.

Investment Protection

The Cisco 1900 Series extends its leadership in total cost of ownership by reducing deployment costs and increasing flexibility. The platform also offers investment protection with support for many of the existing ISR modules.

Energy Efficiency

The Cisco 1900 architecture has been designed with higher efficiency power supplies that provide energy-savings features that include intelligent power management, allowing customers to control power to a specific module based on time of day, with full Cisco EnergyWise feature support in the future.

Cisco® 1941 builds on the best-in-class offering of the existing Cisco 1841 Integrated Services Routers by offering two models-Cisco 1941 and Cisco 1941W. In addition to the support of a wide range of wireless and wired connectivity options supported on Cisco 1941 Series, Cisco 1941W offers integration of IEEE 802.11n access point which is backwards compatible with IEEE 802.11a/b/g access points.

All Cisco 1900 Series Integrated Services Routers offer embedded hardware encryption acceleration, optional firewall, intrusion prevention, and application services. In addition, the platforms support the industries widest range of wired and wireless connectivity options such as T1/E1, xDSL, 3G, and GE.

Key Benefits

The Integrated Services Routers Generation 2 (ISR G2) provide superior services integration and agility. Designed for scalability, the modular architecture of these platforms enables you to grow and adapt with your business needs. Table 1 lists the business benefits of the Cisco 1900.

Benefits and Advantages continued

Benefit	Description
Service Integration	<ul style="list-style-type: none"> The Cisco 1941 Series offer increased levels of services integration with data, security, wireless and mobility services enabling greater efficiencies cost savings.
Services on Demand	<ul style="list-style-type: none"> A single Cisco IOS® Software Universal image is installed on each ISR G2. The Universal image contains all of the Cisco IOS technology sets which can be activated with a software license. This allows your business to quickly deploy advanced features without downloading a new IOS image. Additionally, larger default memory is included to support the new capabilities. The Cisco Services Ready Engine (SRE) enables a new operational model which allows you to reduce capital expenditures (CapEx) and deploy a variety of application services as needed on a single integrated compute services module.
High Performance with Integrated Services	<ul style="list-style-type: none"> The Cisco 1900 Series enables deployment in high speed WAN environments with concurrent services enabled up to 25 Mbps. Multi-Gigabit Fabric enables high bandwidth module to module communication without compromising routing performance
Network Agility	<ul style="list-style-type: none"> Designed to address customer business requirements, Cisco 1941 Series with the modular architecture, offers performance range of modular interfaces and services as your network needs grow. Modular interfaces offer increased bandwidth, a diversity of connection options, and network resiliency.
Energy Efficiency	<ul style="list-style-type: none"> The Cisco 1941 Series architecture provides energy savings features that include the following: <ul style="list-style-type: none"> The Cisco 1900 Series offers intelligent power management and allows the customer to control power to the modules based on the time of day. Cisco EnergyWise technology will be supported in the future. Services integration and modularity on a single platform performing multiple functions, optimizes raw materials consumption and energy usage. Platform flexibility and ongoing development of both hardware and software capabilities lead to a longer product lifecycle, lowering all aspects of the total cost of ownership, including materials and energy use. High efficiency power supplies are provided with each platform.
Investment Protection	<ul style="list-style-type: none"> The Cisco 1941 Series maximizes investment protection by supporting: <ul style="list-style-type: none"> Reuse of a broad array of existing modules supported on the original Integrated Services Routers provides a lower cost of ownership Rich set of Cisco IOS Software features carried forward from the original Integrated Services Routers and delivered in the universal image. Flexibility to grow as your business needs evolve

Architecture & Modularity



The Cisco 1941 Series is architected to meet the application demands of today's branch offices with design flexibility for future applications. The modular architecture is designed to support expanding customer requirements, increased bandwidth, and fully integrated power distribution to modules supporting 802.3af Power over Ethernet (PoE) and Cisco Enhanced PoE (ePoE). The table below lists the architectural features and benefits of the Cisco 1941 Series.

Architectural Feature	Description
Modular Platform	<ul style="list-style-type: none"> The Cisco 1941 Series ISR are highly modular platforms with multiple module slots to provide connectivity and services for varied branch network requirements. The ISRs offer an industry-leading breadth of LAN and WAN connectivity options through modules to accommodate field upgrades to future technologies without requiring replacement of the platform.
Processors	<ul style="list-style-type: none"> The Cisco 1941 Series is powered by high-performance multi-core processors that support growing demands of branch office networks by supporting high throughput WAN requirements.
MultiGigabit Fabric	<ul style="list-style-type: none"> The Cisco 1941 introduces an innovative MultiGigabit Fabric (MGF) which allows for efficient module to module communication, enabling direct services interactions across modules while reducing the overhead on the router processor.
Embedded IPsec/SSL VPN Hardware Acceleration	<ul style="list-style-type: none"> Embedded hardware encryption acceleration is enhanced to provide higher scalability, which, combined with an optional Cisco IOS Security license, enables WAN link security and VPN services (Both IPsec and SSL acceleration).
Integrated Gigabit Ethernet Ports	<ul style="list-style-type: none"> All onboard WAN ports are 10/100/1000 Gigabit Ethernet WAN routed ports.
Innovative universal-serial-bus (USB)-based console access	<ul style="list-style-type: none"> A new, innovative, mini-B USB console port supports management connectivity when traditional serial ports are not available. The traditional console and auxiliary ports are also available. Either the USB-based console or the RJ-45-based console port can be used to configure the router.
Optional Integrated Power Supply for Distribution of Power Over Ethernet (PoE)	<ul style="list-style-type: none"> An optional upgrade to the internal power supply provides in-line power (802.3af-compliant Power-over-Ethernet [PoE] and Cisco standard inline power) to optional integrated switch modules.
Integrated Wireless LAN	<ul style="list-style-type: none"> The Cisco 1941 offers a secure integrated access point in a single device. Integrated access point is based on the IEEE 802.11n draft 2.0 standard that uses MIMO (Multi-Input, Multiple-output) to improve coverage for existing 802.11a/ b/g clients and new 802.11n clients. The Cisco 1941 supports dual radios-802.11 b/g/n and 802.11a/n and is capable of operating in both autonomous and unified modes.

Modularity Features and Benefits

The Cisco 1941 provides significantly enhanced modular capabilities offering investment protection for customers. Most of the modules available on previous generations of Cisco routers, such as the Cisco 1841 ISR, are supported on the Cisco 1941. Additionally, modules used on the Cisco 1941 can easily be interchanged with other Cisco routers to provide maximum investment protection. Taking advantage of common interface cards across a network greatly reduces the complexity of managing inventory requirements, implementing large network rollouts, and maintaining configurations across a variety of branch-office sizes.

A complete list of supported modules is available at <http://www.cisco.com/go/1941>.

Benefit	Description
Cisco Enhanced High Speed WAN Interface Card (EHWIC)	<ul style="list-style-type: none"> The EHWIC slot replaces the high-speed WAN interface card (HWIC) slot and can natively support HWICs, WAN interface cards (WICs), voice interface cards (VICs), and voice/WAN interface cards (VWICs) Two integrated EHWIC slots are available on the Cisco 1941 for flexible configurations for support of two modules: One double wide HWIC-D or single wide EHWIC/HWIC module and a second single wide E-HIC/HWIC module are supported Each HWIC Slot offers high data throughput capability Up to 1.6 Gbps aggregate towards the router processor Up to 2 Gbps aggregate to other module slots over MultiGigabit Fabric (MGF)
	
Cisco Internal Services Module (ISM)	<ul style="list-style-type: none"> A single ISM Slot provides flexibility to integrate intelligent services modules that do not require interface ports. ISM replaces the Advanced Integration Module (AIM) slot, existing AIM modules are not supported in the ISM slot Each ISM Slot offers high data throughput capability Up to 4 Gbps aggregate towards the router processor Up to 2 Gbps aggregate to other module slots over MultiGigabit Fabric (MGF) Power to ISM slots can be managed by extensions similar to the Cisco EnergyWise framework, allowing organizations to reduce energy consumption in their network infrastructure. Full EnergyWise support will be available in future software releases. <p>Note: The Cisco 1941 cannot have ISM and WLAN on the same chassis. Please refer to ordering information for WLAN SKUs</p>
	
Compact Flash Slots	<ul style="list-style-type: none"> Two external Compact Flash slots are available on the Cisco 1941. Each slot can support high-speed storage densities upgradeable to 4GB in density.
USB 2.0 Ports	<ul style="list-style-type: none"> Two high-speed USB 2.0 ports are supported. The USB ports enable another mechanism secure token capabilities and storage.

Cisco IOS Software

The Cisco 1941 Series Integrated Services Routers deliver innovative technologies running on industry-leading Cisco IOS Software. Developed for wide deployment in the world's most demanding enterprise, access, and service provider networks, Cisco IOS Software Release 15 M&T provides support for a comprehensive portfolio of Cisco technologies, including new functionality and features delivered in Releases 12.4 and 12.4T, and new innovations that span multiple technology areas, including security, voice, high availability, IP Routing and Multicast, quality of service (QoS), IP Mobility, Multiprotocol Label Switching (MPLS), VPNs, and embedded management.

Cisco IOS Software Licensing and Packaging

A single Cisco IOS Universal image encompassing all functions is delivered with the platforms. You can enable advanced features by activating a software license on the Universal image. In previous generations of access routers, these feature sets required you to download a new software image. Technology packages and feature licenses, enabled through the Cisco software licensing infrastructure, simplify software delivery and decrease the operational costs of deploying new features.

Four major technology licenses are available on the Cisco 1941 Series Integrated Services Routers; you can activate the licenses through the Cisco software activation process identified at <http://www.cisco.com/go/sa>.

- IP Base: This technology package is available as default
- Data
- Security (SEC) or Security with No Payload Encryption (SEC-NPE)

For additional information and details about Cisco IOS Software licensing and packaging on Cisco 1941 Series Integrated Services Routers, please visit <http://www.cisco.com/go/1941>.

Key Branch Office Services

The Cisco Integrated Services Routers are industry-leading routers that offer unprecedented levels of services integration. Designed to meet the requirements of the branch office, these platforms provide a complete solution with voice, security, mobility, and data services. Businesses enjoy the benefit by deploying a single device that meets all their needs and save on capital and operational expenses.

Integrated Network Security for Data and Mobility

Security is essential to protect a business' intellectual property while also ensuring business continuity and providing the ability to extend the corporate workplace to employees who need anytime, anywhere access to company resources. As part of the Cisco SAFE architectural framework that allows organizations to identify, prevent, and adapt to network security threats—the Cisco 1900 Series Integrated Services Routers facilitate secure business transactions and collaboration.

The Cisco IOS Software Security technology package license for the Cisco 1900 Series offers a wide array of common security features such as advanced application inspection and control, threat protection, and encryption architectures for enabling more scalable and manageable VPN networks in one solution set. The Cisco 1941 Series offers native hardware-based encryption acceleration to provide greater IPsec

Key Branch Office Services continued

throughput with less overhead for the router processor when compared with software-based encryption solutions. Cisco Integrated Services Routers offer a comprehensive and adaptable security solution for branch-office routers that include features such as:

- Secure connectivity: Secure collaborative communications with Group Encrypted Transport VPN (GETVPN), Dynamic Multipoint VPN (DMVPN), or Enhanced Easy VPN.
- Integrated threat control: Respond to sophisticated network attacks and threats using Cisco IOS Firewall, Cisco IOS Zone-Based Firewall, IOS IPS, IOS Content Filtering, and Flexible Packet Matching (FPM).
- Identity Management: Intelligently protecting endpoints using technologies such as authentication, authorization, and accounting (AAA) and public key infrastructure (PKI).

Detailed information on the security features and solutions supported on the Cisco 1900 Series routers can be found at <http://www.cisco.com/go/routersecurity>.

Wireless and Mobility Services

Wireless LAN

The Cisco Integrated Services Routers supporting the Cisco Unified Wireless Network enable deployment of secure, manageable WLANs optimized for remote sites and branch offices, including fast secure mobility, survivable authentication, and simplified management. The Cisco Unified Wireless Network addresses critical points of potential failure and helps enable resiliency and survivability for WLANs at remote locations and branch offices. This solution protects the WLAN by providing fast recovery from a variety of faults that may occur. With Cisco's high availability for remote WLANs, hardware and software work together to enable rapid recovery from disruptions and help ensure fault transparency to users and network applications.

The new Cisco 1941W with IEEE 802.11n integrated access point support both unified and autonomous deployments. This integrated WiFi access point offers IEEE 802.11n draft 2.0 standard support for mobile access to high-bandwidth data, voice, and video applications through the use of multiple-input, multiple-output (MIMO) technology that provides increased throughput, reliability, and predictability. IEEE 802.11n wireless networks create a cohesive working environment by combining the mobility of wireless with the performance of wired networks. Cisco has innovative, next-generation wireless solutions that offer greater performance and extended reach for pervasive wireless connectivity. IEEE 802.11n technology delivers outstanding reliability and up to nine times the throughput of current IEEE 802.11 a/b/g networks. It makes wireless networks an integral part of every type of organization by offering the following benefits:

- Data rates of up to 600 Mbps support more users, devices, and mission-critical, bandwidth-intensive applications.
- New MIMO technology provides predictable WLAN coverage and reliable connectivity.
- Next-generation wireless technology provides superior investment protection to support emerging mobile applications.

These routers help extend corporate networks to secure remote sites while giving users access to the same applications found in corporate offices for both data and voice applications. When users require WLAN access, visibility, and control of network security are even more critical at the remote site. The new fixed Cisco Integrated Services Routers meet this need with a single device that combines integrated IEEE 802.11a/b/g/n capabilities with security features such as WiFi Protected Access (WPA), including authentication with IEEE 802.1X with the Cisco Light Extensible Authentication Protocol (LEAP) and Protected EAP (PEAP) and encryption with the WPA Temporal Key Integrity Protocol (TKIP).

Wireless and Mobility Services continued

Wireless WAN

Cisco third-generation (3G) wireless WAN (WWAN) modules combine traditional enterprise router functions, such as remote management, advanced IP services such as voice over IP (VoIP), and security, with mobility capabilities of 3G WAN access. Using high-speed 3G wireless networks, routers can replace or complement existing landline infrastructure, such as dialup, Frame Relay, and ISDN. Cisco 3G solutions support 3G standards High-Speed Packet Access (HSPA) and Evolution Data Only/Evolution Data Optimized (EVDO) providing you with a true multipath WAN backup and the ability to rapidly deploy primary WAN connectivity. For more information about 3G solutions on Cisco Integrated Services Routers, please refer to www.cisco.com/go/3g

Application Services

Wireless WAN

As organizations continue to centralize and consolidate their branch IT infrastructure in an effort to reduce cost and complexity in the branch office, they are challenged to provide adequate user experience, ensure continuous service availability, and deliver business-relevant applications when and where they are needed. To address these challenges, the Cisco 1941 Series provides the ability to host Cisco, 3rd party, and custom applications on Cisco Services Ready Engine (SRE) module that seamlessly integrate into the router. The module has its own processor, network interface, and memory that operate independently of the host router resources, helping to ensure maximum concurrent routing and application performance while reducing physical space requirements, lowering power consumption, and consolidating management.

Cisco Services Ready Engine

The Cisco Services Ready Engine solution is available in a Internal Service Module (ISM) form-factor. The Internal Service Module hardware offers up to seven times performance improvement over the previous-generation Advanced Integration Modules and provides a x86 processor. The Cisco SRE module enables on-demand provisioning of branch-office applications on the Cisco 1900 Series platforms so that you can deploy the right application, at the right time, in the right place. The hardware and software decoupling provided by the service-ready deployment model enables applications to be provisioned on the module at the time of its installation or remotely anytime thereafter. Supported solutions include Cisco Application Extension Platform (AXP), Cisco Wireless LAN Controller (WLC), and other applications under development. The Service Ready Engine enables organizations of various sizes to future-proof their network by allowing them to quickly deploy new branch-office applications without deploying new hardware, reducing the cost of rolling out branch-office services.

Managing Your Integrated Services Routers

Network Management applications are instrumental in lowering Operating Expenditures (OPEX) while improving network availability by simplifying and automating many of the day-to-day tasks associated with managing an end-to-end network. "Day-one-device-support" provides immediate manageability support for the Integrated Services Router enabling quick and easy deployment, monitoring, and troubleshooting from Cisco and third party applications.

Organizations rely on Cisco, third-party and in-house developed network management applications to achieve their Opex and productivity goals. Underpinning those applications are the embedded management features available in every ISR. The new ISRs continue a tradition of broad and deep manageability features within the devices. Features such as IPSLA, EEM, NetFlow, allow you to know what's going on in your network at all times. These features along with SNMP and SYSLOG support enable your organization's management applications.

Refer to Tables 4, 5 and 6 for details on IOS, Network Management and Manageability support on Cisco 1941 Series Integrated Services Routers.

When to Deploy

The Cisco 1941 Integrated Services Router (ISR) delivers highly secure data, mobility, and application services. Key features include:

- 2 integrated 10/100/1000 Ethernet ports
- 2 enhanced High-Speed WAN Interface Card slots that can host 2 single wide or 1 double wide and 1 single wide (e)HWIC
- 1 Internal Services Module slot
- Fully integrated power distribution to modules supporting 802.3af Power over Ethernet (PoE) and Cisco Enhanced PoE
- Security:
 - Embedded hardware-accelerated VPN encryption
 - Secure collaborative communications with Group Encrypted Transport VPN, Dynamic Multipoint VPN, or Enhanced Easy VPN
 - Integrated threat control using Cisco IOS Firewall, Cisco IOS Zone-Based Firewall, Cisco IOS IPS, and Cisco IOS Content Filtering
 - Identity management that uses authentication, authorization, and accounting (AAA), and public key infrastructure

The Cisco 1900 Integrated Routers Series are targeted for small branch sites with WAN bandwidth requirements up to 25Mbps.

For 1900 Series technical specifications please see the data sheet at:

http://www.cisco.com/en/US/prod/collateral/routers/ps10538/data_sheet_c78_556319.html

Ordering Information

The Cisco 1900 Series Integrated Services Routers are orderable and shipping. For information about how to order the Cisco 1900 Series, please visit the Cisco 1900 Series Ordering Guide. To place an order, visit the Cisco Ordering Home Page. For additional product numbers, including the Cisco 1900 Series bundle offerings, please check the Cisco 1900 Series Integrated Services Router Price List or contact your local Cisco account representative.

Product Number	Product Description
Cisco 1941/K9	Cisco 1941 with 2 onboard GE, 2 EHWIC slots, 1 ISM slot, 256MB CF default, 512MB DRAM default, IP Base
Cisco1941W-A/K9	Cisco 1941 Router w/ 802.11 a/b/g/n FCC Compliant, 2 onboard GE, 2 EHWIC slots, 256MB CF default, 512MB DRAM default, IP Base
Cisco1941W-E/K9	Cisco 1941 Router w/ 802.11 a/b/g/n ETSI Compliant, 2 onboard GE, 2 EHWIC slots, 256MB CF default, 512MB DRAM default, IP Base
Cisco1941W-P/K9	Cisco 1941 Router w/ 802.11 a/b/g/n Japan Compliant, 2 onboard GE, 2 EHWIC slots, 256MB CF default, 512MB DRAM default, IP Base
Cisco1941W-N/K9	Cisco 1941 Router w/ 802.11 a/b/g/n Aus and NZ Compliant, 2 onboard GE, 2 EHWIC slots, 256MB CF default, 512MB DRAM default, IP Base
Cisco1941W-C/K9	Cisco 1941 Router w/ 802.11 a/b/g/n China Compliant, 2 onboard GE, 2 EHWIC slots, 256MB CF default, 512MB DRAM default, IP Base



Cisco 2800 Series

Cisco is redefining best-in-class enterprise and small- to medium-sized business routing with a new line of Integrated Services Routers that are optimized for the secure, wire-speed delivery of concurrent data, voice, and video services. Founded on 20 years of leadership and innovation, Cisco 2800 Series integrated services routers intelligently embed data, security, and voice services into a single, resilient system for fast, scalable delivery of mission-critical business applications. The unique integrated systems architecture of the Cisco 2800 Series delivers maximum business agility and investment protection.

Benefits and Advantages

Enhanced Architecture

The Cisco 2800 Series features support for new interface cards. Depending on the router model, this can include up to four high-speed WAN interface card (HWIC) slots, up to one Enhanced Network Module (NME) slot, and up to one Extension Voice Module (EVM) slot. Embedded on the motherboard of the router is a hardware-based VPN accelerator, up to three PVDM (Packet Voice DSP Module) slots for integrated digital signal processor (DSP) modules, two advanced integration module (AIM) slots, up to two USB 1.1 ports, and two Fast Ethernet 10/100 ports (Cisco 2801, 2811) or two Gigabit Ethernet 10/100/1000 ports (Cisco 2821, 2851). Additionally, optional support for inline power (including 802.3af) is offered.

Investment Protection and Versatility

The Cisco 2800 Series provides significant additional value compared to prior generations of Cisco routers such as the Cisco 1700 and 2600 Series routers at similar price points by offering up to a five-fold performance improvement, up to a ten-fold increase in security and voice performance, new embedded service options, and dramatically increased slot performance and density while maintaining support for most of the more than 90 existing modules that are available today for the Cisco 1700 Series and Cisco 2600 Series.

Integrated Switching

With support of up to 64 ports of integrated switching with inline power, the Cisco 2800 Series offers an excellent platform for combining two of the most common components of any network infrastructure. Additionally, with support for the 802.3af (Power over Ethernet [PoE]) standard, the 4- and 9-port Cisco EtherSwitch HWICs and the 16-, 24-, and 48-port EtherSwitch Service Modules can provide power to any 802.3af-compliant devices, greatly expanding the number and types of devices that can be powered from the router's integrated switch ports. An optional upgrade to the internal power supply provides power to the integrated switch ports.

Integrated Services

With the optional integration of numerous services modules, the Cisco 2800 Series offers the ability to easily integrate the functions of standalone network appliances and components into the Cisco 2800 Series chassis itself. Many of these modules, such as the Cisco Network Analysis Module, Cisco Unity™ Express Voice Mail Module, Cisco Intrusion Prevention Module, and Cisco Wide Area Application Services Module, have embedded processors and hard drives that allow them to run largely independently of the router while allowing management from a single management interface. This flexibility greatly expands the potential applications of the Cisco 2800 Series beyond traditional routing, while maintaining the benefits of integration.

Benefits and Advantages continued

Secure Networking

Integrated on the motherboard of every Cisco 2800 Series router is hardware-based encryption acceleration that offloads the encryption processes to provide greater IPsec throughput with less overhead for the router CPU, when compared with software-based solutions. With the optional integration of VPN modules (for enhanced performance and tunnel count), intrusion prevention modules or NAC network modules for network admission control, combined with the rich Cisco IOS Software security feature set that includes firewall, intrusion prevention, voice and video-enabled VPN (V3PN), Group Encrypted Transport (GET) VPN and Dynamic Multipoint VPN (DMVPN), Cisco offers the industry's most robust and adaptable security solution for branch-office routers.

IP Telephony

The Cisco 2800 Series allows network managers to provide scalable analog and digital telephony without investing in a one-time solution, giving enterprises greater control of their converged telephony needs. Using voice and fax modules, the Cisco 2800 Series can be deployed for

applications ranging from voice over IP (VoIP) and voice over Frame Relay (VoFR) transport to robust, centralized solutions using the Cisco Survivable Remote Site Telephony (SRST) solution or distributed call processing using Cisco CallManager Express (CCME). The architecture is highly scalable with the ability to support up to 96 IP phones, 12 T1/E1s trunks, 52 foreign-exchange-office (FXS) ports, or 36 foreign-exchange-office (FXO) ports concurrent with data routing and other services.

Video Surveillance

The Cisco® Integrated Video Surveillance solution enables you to rapidly deploy highly distributed, IP-enabled video surveillance at your offices while migrating traditional analog surveillance equipment to IP. The solution based on Cisco 2800 and 3800 Series ISR offers the lowest total cost of ownership (TCO) for the branch office, ease of integration through network transparency, reliable data interoperability, and maximized overall security. It allows you to consolidate costly branch-office servers and deploy new applications centrally while still offering real-time access to physical security video and data.

Security Features

IPsec VPN

- Advanced Encryption Standard (AES) 128, 192, and 256; Triple Data Encryption Standard (3DES); and DES cryptology support
- Embedded hardware-based VPN acceleration on the motherboard
- Cisco Easy VPN remote; Cisco Easy VPN server
- Dynamic Multipoint VPN (DMVPN)
- Group Encrypted Transport (GETVPN)
- Virtual Tunnel Interfaces (VTI)
- VPN QoS—Preclassification support

Multiprotocol Label Switching (MPLS) VPN Support

- Limited provider edge capabilities
- Virtual Routing and Forwarding (VRF) firewall and VRF IPsec

Cisco IOS IPS

- Inline ability to drop packet, reset connection, locally shun, or send an alarm; dynamically load and enable selected attack signatures in the same manner as Cisco IPS Appliances. For broader signature support and higher performance, look at optional IPS AIM module for ISR.

IOS WebVPN (SSL VPN)

- Secure remote access for mobile users without installing PC client software
- Integrated into the router — no separate appliance required
- Cisco 2801 supports up to 75 users, Cisco 2811 and 2821 support up to 100 users, and Cisco 2851 supports up to 150 users with AIM-VPN/SSL-2
- Requires IOS WebVPN feature license FL-WEBVPN-10 or FL-WEBVPN-25 (purchase multiple quantities to add up to the desired number of users)
- Requires an IOS security feature set (IOS security feature set is included in all secure router bundles)

Security Features continued

Cisco IOS Firewall

- Feature rich, stateful firewall
- Per-user authentication and authorization
- Real-time alerts
- Transparent firewall
- IPv6 firewall
- VRF-aware firewall
- Advanced Application Inspection and Control
 - HTTP inspection engine
 - E-mail inspection engines (SMTP, ESMTP, IMAP, POP)

Network Foundation Protection

- Control Plane Policing (CPP)
- AutoSecure
- CPU/Memory Threshold
- Secure Shell (SSH)
- Access Control List (ACL)
- Command-Line Interface (CLI)
- Committed Access Rate (CAR)

URL Filtering

- Onboard with an optional content-engine network module
- Local URL filtering in Cisco IOS software based on external server

Onboard USB 1.1 port

- 1 or 2 onboard USB 1.1 ports
- Secure token and Flash memory support

Security Solutions

- Network Admission Control (NAC)
- Voice and Video Enabled IPsec VPN (V3PN)

Optional Security Modules

- Intrusion Prevention System (AIM-VPN-K9)
- VPN and Encryption Advanced Integration Modules (AIM-VPN/SSL-2)
- Network Admission Control Network Module (NME-NAC-K9)

Cisco Router and Security Device Manager (SDM)

- Ships by default

Certifications

- ICSA IPsec
- ICSA Firewall
- Common Criteria IPsec (EAL4) (in process)
- Common Criteria Firewall (EAL4+) (in process)
- FIPS 140-2, Level 2 (in process)

Series Features Overview

Features	Details
Multiprotocol Label Switching (MPLS) VPN Support	Specific Provider Edge (PE) capabilities
Intrusion Prevention System (IPS)	More than 1600 IPS signatures supported in Cisco IOS Software, with the ability to load and enable selected IPS signatures Optional high-performance IPS Network Module with more than 2000 signatures
URL Filtering	Onboard filtering with an optional content engine network module Local URL filtering in Cisco IOS Software based on external server
Cisco Router and Security Device Manager (SDM), version 2.0 and Above	Comes standard on all Cisco 2800 Series routers
Media Authentication and Encryption	Standards-based authentication and encryption using secure RTP provides a secure environment for IP Communications Advanced Encryption Standard (AES) 256-bit cryptography support
IP Telephony Features	
IP Phone Support	Optional integrated power supply with inline power: 802.3af support Up to 360W of inline power (Note: requires power supply upgrade)
Analog Voice Support	One EVM on the Cisco 2821 and Cisco 2851 Up to 52 FXS and 36 FXO ports

Series Features Overview continued

Features	Details
IP Telephony Features <small>continued</small>	
Digital Voice Support	Up to 192 calls
DSP (PVDM) Slots on Motherboard	Up to three DSP slots on motherboard Local Conferencing and Transcoding
Cisco CallManager Express (CCME)	Up to 96 phones
Cisco SRST	Up to 96 phones
Voice Mail and Automated Attendant	Up to 250 mailboxes with up to 16 concurrent sessions using Cisco Unity™ Express Network Module
Voice Interfaces	FXS, FXO, Direct Inward Dial (DID), E&M, Centralized Automated Message Accounting (CAMA), Cisco Unity Express (CUE), Basic Rate Interface (BRI), T1, E1 Primary Rate Interface (PRI), Q.SIG, Channel Associated Signaling (CAS)

Network Example

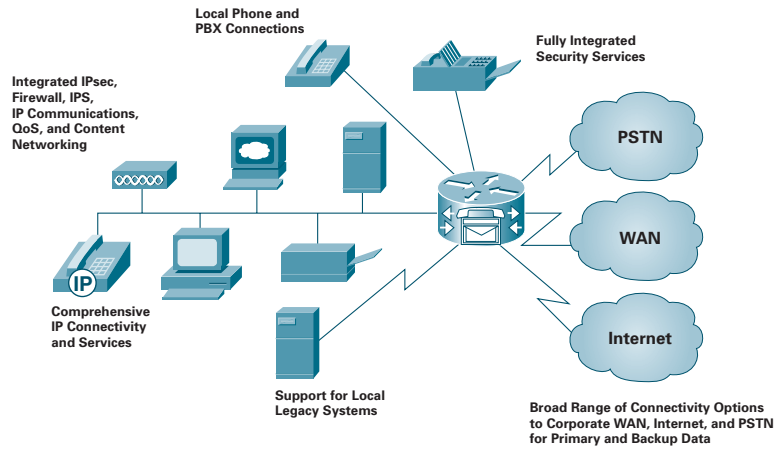

When To Deploy

Deploy the Cisco 2800 Series when you need:

- Performance and densities for concurrent data, security, voice, and advanced services up to multiple T1/E1/xDSL connections
- VPN connections, or plan to migrate to them over time
- Integrated security services as part of the Cisco Self Defending Network, which enable network device protection, threat defense, secure connectivity, and endpoint protection and control
- Ability to upgrade the internal power supply to support integrated 10/100 switching with PoE support for up to 64 ports with inline power

- High-availability features such as an integrated Redundant Power Supply (RPS) connector for quick connections to an external redundant power supply, Error Correction Code (ECC) Double Data Rate (DDR) SDRAM memory to detect and correct SDRAM errors without user intervention, and Cisco IOS Software warm reboot support for reduced downtime caused by system reboots (Note: Cisco 2801 does not support ECC DDR DRAM.)
- Secure integrated call processing, voice mail and automated attendant, flexible telephony interfaces, redundancy for centralized call processing, or robust DSP support, including local conferencing and transcoding
- Advanced management for security, routing, Quality of Service (QoS), and switching services with Cisco SDM Version 2.0

Application Example

Options

- Complete Cisco IP Communications and voice gateway capabilities
- Cisco Survivable Remote Site Telephony (SRST)
- Cisco Communications Express and Cisco Unity™ Express
- Integrated stateful firewall

Site-to-Site VPN using technologies such as EasyVPN, GET VPN, DMVPN

- Network admission control (NAC), and intrusion prevention
- Wide Area Application Services Acceleration
- Wireless WAN Backup (3G CDMA and GSM)
- Network Analysis
- Circuit Emulation over IP (CEoIP)
- Integrated low-density switching with PoE support
- Video Surveillance, Management and Storage
- Application Performance Assurance
- Application eXtensions Platform (AXP)

Platform Overview

Models	NME	EVM	AIM	HWIC	PVDM*	Fixed LAN Ports	DRAM (MB) Default Max	Compact Flash (MB) Default Max	Power Supply
Cisco 2801	0***	0	2	2**	2	2 FE	128 384	64 128	AC, AC-IP
Cisco 2811	1	0	2	4	2	2 FE	256 768	64 256	AC, AC-IP, DC
Cisco 2821	1 NME or NME-X	1	2	4	3	2 GE	256 1024	64 256	AC, AC-IP, DC
Cisco 2851	1 NME, NMD, NME-X, or NME-XD	1	2	4	3	2 GE	256 1024	64 256	AC, AC-IP, DC

* Number of PVDM slots on the motherboard, additional DSP resources can be added using a network module
 ** Four interface card slots total are supported on the Cisco 2801 router; two slots support HWIC, WIC, VIC, or VWIC modules; one slot supports WIC, VIC, or VWIC modules; one slot supports VIC or VWIC modules (in voice mode only)
 *** Cisco 2801 router does not support network modules

Series Specifications

Dimensions (H x W x D)	
Cisco 2801	1.72 x 17.5 x 16.5 in. (43.7 x 44.5 x 41.9 mm); 1-rack unit (RU) height
Cisco 2811	1.75 x 17.25 x 16.4 in. (44.5 x 43.8 x 41.6 mm); 1 RU height
Cisco 2821, Cisco 2851	3.5 x 17.25 x 16.4 in. (88.9 x 43.8 x 41.6 mm) 2 RU height
Console Port	1 (up to 115.2 Kbps)
Auxiliary Port	1 (up to 115.2 Kbps)
USB Port	
Cisco 2801	1
Cisco 2811, Cisco 2821, and Cisco 2851	2
Integrated Channel Service Unit/Data Service Unit (CSU/DSU)	Yes, with optional T1/E1, Fractional T1/E1, 56k/64k support
Voice/Data Support	Yes, for voice through VIC, VWIC, NM, and EVM
Compression	Software and hardware, with optional AIM support
Encryption	Hardware support on motherboard; optional AIM for enhanced performance
Maximum 10/100 Switch Ports with Inline Power	
Cisco 2801	16
Cisco 2811	32
Cisco 2821	40
Cisco 2851	64
Maximum Inline Power Distribution	
Cisco 2801	120W
Cisco 2811	160W
Cisco 2821	240W
Cisco 2851	360W
Maximum 1 GB Ports	5, including HWIC and NME modules (not supported on Cisco 2801)
Maximum Token Ring Ports	0
Maximum High-speed Serial (up to 2 Mbps)	20
Maximum Low-speed Serial (up to 128 Kbps)	48 synchronous, 96 asynchronous
Maximum Integrated Modems	24 analog
Maximum ISDN BRI Ports	20
Maximum ISDN PRI Ports	2
Integrated RPS Connector	
Cisco 2801	No
Cisco 2811, Cisco 2821, Cisco 2851	Yes; use Cisco RPS-675 Redundant Power System
Minimum Cisco IOS Software Release	
Cisco 2801	12.3(8)T4
Cisco 2811	12.3(8)T4
Cisco 2821	12.3(8)T4
Cisco 2851	12.3(8)T4

Ordering Information

All Cisco 2800 Series chassis ship with IP Base software, 64 MB of Compact Flash, either 128 or 256 MB of SDRAM, console, auxiliary and LAN cables, a power cord, 19-inch rack-mount brackets, and blank panels that cover unused WIC or network module slots.

Optional items:

- Cisco IOS Software feature set upgrade or revision; IP Base is default and included with the chassis
- Several voice/WAN interface card options
- Several WAN/LAN network module options
- Optional MFT Dedicated Echo Cancellation Modules for select voice/WAN interface cards
- Between 2 and 3 PVDMs plus additional PVDM capacity on select network modules
- Several services module options, including content engine, IPS, network analysis, and CESoIP
- Up to 2 AIMS
- Cisco EtherSwitch modules (4-, 9-, 16-, 24- [Cisco 2821 or 2851 only] or 48-port [Cisco 2851 only])
- External RPS (Cisco RPS-675 [not supported on 2801])
- Flash/SDRAM memory upgrade
- Cables
- Feature license for IP Telephony

Product Number Product Description**Cisco 2800 Series Base Chassis Part Numbers**

CISCO2851	Integrated Services Router with AC power, 2 GbE, slots for 1 NME-XD, 1EVM, 4 HWICs, 2 AIMS, 3 PVDMs; and Cisco IOS IP Base Software
CISCO2851-AC-IP	Integrated Services Router with AC power including inline power distribution capability, 2 GbE, slots for 1 NME-XD, 1 EVM, 4 HWICs, 2 AIMS, 3 PVDMs; and Cisco IOS IP Base Software
CISCO2851-DC	Integrated Services Router with DC power, 2 GbE, slots for 1 NME-XD, 1 EVM, 4 HWICs, 2 AIMS, 3 PVDMs; and Cisco IOS IP Base Software
CISCO2821	Integrated Services Router with AC power, 2 GbE, slots for 1 NME-X, 1 EVM, 4 HWICs, 2 AIMS, 3 PVDMs; and Cisco IOS IP Base Software
CISCO2821-AC-IP	Integrated Services Router with AC power including inline power distribution capability, 2 GbE, slots for 1 NME-X, 1 EVM, 4 HWICs, 2 AIMS, 3 PVDMs; and Cisco IOS IP Base Software
CISCO2821-DC	Integrated Services Router with DC power, 2 GbE, slots for 1 NME-X, 1 EVM, 4 HWICs, 2 AIMS, 3 PVDMs; and Cisco IOS IP Base Software
CISCO2811	Integrated Services Router with AC power, 2FE, slots for 1 NME, 4 HWICs, 2 AIMS, 2 PVDMs; and Cisco IOS IP Base Software
CISCO2811-AC-IP	Integrated Services Router with AC power including inline power distribution, 2FE, slots for 1 NME, 4 HWICs, 2 AIMS, 2 PVDMs; and Cisco IOS IP Base Software
CISCO2811-DC	Integrated Services Router with DC power, 2FE, slots for 1 NME, 4 HWICs, 2 AIMS, 2 PVDMs; and Cisco IOS IP Base Software
CISCO2801	Integrated Services Router with AC power, 2FE, slots for 4 Interface Cards, 2 AIMS, 2 PVDMs; and Cisco IOS IP Base Software
CISCO2801-AC-IP	Integrated Services Router with AC power including inline power distribution, 2FE, slots for 4 Interface Cards, 2 AIMS, 2 PVDMs; and Cisco IOS IP Base Software

Product Bundles

Product Number	Product Description
HSEC Bundles	
C2851-H-VSEC/K9	Cisco 2851 HVSEC Bundle with IOS Advanced IP Services, PVDM2-48, AIM-VPN/SSL-2, 50 User SRST License, 10 User SSL VPN License, 256 MB Flash/512 MB DRAM
C2821-H-VSEC/K9	Cisco 2821 HVSEC Bundle with IOS Advanced IP Services, PVDM2-32, AIM-VPN/SSL-2, 50 User SRST License, 10 User SSL VPN License, 256 MB Flash/512 MB DRAM
C2811-H-VSEC/K9	Cisco 2811 HVSEC Bundle with IOS Advanced IP Services, PVDM2-16, AIM-VPN/SSL-2, 35 User SRST License, 10 User SSL VPN License, 256 MB Flash/512 MB DRAM
C2801-H-VSEC/K9	Cisco 2801 HVSEC Bundle with IOS Advanced IP Services, PVDM2-8, AIM-VPN/SSL-2, 25 User SRST License, 10 User SSL VPN License, 128 MB Flash/384 MB DRAM
CISCO2851-HSEC/K9	Cisco 2851 Security Bundle with IOS Advanced IP Services Image, AIM-VPN/SSL-2, 64 MB Flash/256 MB DRAM, 10 User SSL License
CISCO2821-HSEC/K9	Cisco 2821 Security Bundle with IOS Advanced IP Services Image, AIM-VPN/SSL-2, 64 MB Flash/256 MB DRAM, 10 User SSL License
CISCO2811-SEC/K9	Cisco 2811 Security Bundle with IOS Advanced Security Image, 64 MB Flash/256 MB DRAM
CISCO2811-HSEC/K9	Cisco 2811 Security Bundle with IOS Advanced IP Services Image, AIM-VPN/SSL-2, 64 MB Flash/256 MB DRAM, 10 User SSL License
CISCO2801-HSEC/K9	Cisco 2801 Security Bundle with IOS Advanced IP Services Image, AIM-VPN/SSL-2, 64 MB Flash/256 MB DRAM, 10 User SSL License
Secure Voice Bundles	
CISCO2801-V3PN/K9	Cisco 2801 V3PN bundle, with AIM-VPN, PVDM2-8, FL-CCME-24, IOS Advanced IP Services, 64 MB Flash/256 MB DRAM
CISCO2811-V3PN/K9	Cisco 2811 V3PN bundle with AIM-VPN, PVDM2-16, CCME-36, IOS Advanced IP Services, 64 MB Flash/256 MB DRAM
CISCO2821-V3PN/K9	Cisco 2821 V3PN bundle with AIM-VPN, PVDM2-32, CCME-48, IOS Advanced IP Services, 64 MB Flash/256 MB DRAM
CISCO2851-V3PN/K9	Cisco 2851 V3PN bundle with AIM-VPN, PVDM2-48, CCME-72, IOS Advanced IP Services, 64 MB Flash/256 MB DRAM
C2801-VSEC-CCME/K9	Cisco 2801 VSEC Bundle with PVDM2-8, FL-CCME-24, IOS Advanced IP Services, 128 MB Flash/256 MB DRAM
C2801-VSEC-SRST/K9	Cisco 2801 VSEC Bundle with PVDM2-8, FL-SRST-24, IOS Advanced IP Services, 128 MB Flash/256 MB DRAM
C2811-VSEC-CCME/K9	Cisco 2811 VSEC Bundle with PVDM2-16, FL-CCME-36, IOS Advanced IP Services, 128 MB Flash/256 MB DRAM
C2811-VSEC-SRST/K9	Cisco 2811 VSEC Bundle with PVDM2-16, FL-SRST-36, IOS Advanced IP Services, 128 MB Flash/256 MB DRAM
C2821-VSEC-CCME/K9	Cisco 2821 VSEC Bundle with PVDM2-32, FL-CCME-48, IOS Advanced IP Services, 128 MB Flash/256 MB DRAM
C2821-VSEC-SRST/K9	Cisco 2821 VSEC Bundle with PVDM2-32, FL-SRST-48, IOS Advanced IP Services, 128 MB Flash/256 MB DRAM
C2851-VSEC-CCME/K9	Cisco 2851 VSEC Bundle with PVDM2-48, FL-CCME-96, IOS Advanced IP Services, 128 MB Flash/256 MB DRAM
C2851-VSEC-SRST/K9	Cisco 2851 VSEC Bundle with PVDM2-48, FL-SRST-96, IOS Advanced IP Services, 128 MB Flash/256 MB DRAM

Product Bundles continued

Product Number	Product Description
Secure Voice Bundles continued	
C2801-VSEC/K9	Cisco 2801 Voice Security Bundle, PVDM2-8, IOS Advanced IP Services, 64 MB Flash/256 MB DRAM
C2811-VSEC/K9	Cisco 2811 Voice Security Bundle, PVDM2-16, IOS Advanced IP Services, 64 MB Flash/256 MB DRAM
C2821-VSEC/K9	Cisco 2821 Voice Security Bundle, PVDM2-32, IOS Advanced IP Services, 64 MB Flash/256 MB DRAM
C2851-VSEC/K9	Cisco 2851 Voice Security Bundle, PVDM2-48, IOS Advanced IP Services, 64 MB Flash/256 MB DRAM
Voice Bundles	
CISCO2851-V/K9	Cisco 2851 voice bundle with PVDM2-48, 64 MB Compact Flash/256 MB DRAM, and Cisco IOS SP services
CISCO2851-CCME/K9	Cisco 2851 voice bundle with PVDM2-48, CCME featuring 96-phone license, 128 MB Flash/256 MB DRAM, and Cisco IOS SP services
CISCO2851-SRST/K9	Cisco 2851 voice bundle with PVDM2-48, SRST featuring 96-phone license, 128 MB Flash/256 MB DRAM, and Cisco IOS SP services
C2851-35UC/K9	Cisco 2851 Unified Communications Bundle with IOS SP Services, PVDM2-48, AIM-CUE, 35 User Licences (CCME, CUE, and Phone User licences), 10 Unified CallConnector Personal Licences, 128 MB Flash/256 MB DRAM
CISCO2821-V/K9	Cisco 2821 voice bundle with PVDM2-32, 64 MB Compact Flash/256 MB DRAM, and Cisco IOS SP services
CISCO2821-CCME/K9	Cisco 2821 voice bundle with PVDM2-32, CCME featuring 48-phone license, 128 MB Flash/256 MB DRAM, and Cisco IOS SP services
CISCO2821-SRST/K9	Cisco 2821 voice bundle with PVDM2-32, SRST featuring 48-phone license, 64 MB Compact Flash/256 MB DRAM, and Cisco IOS SP services
C2821-25UC/K9	Cisco 2821 Unified Communications Bundle with IOS SP Services, PVDM2-32, AIM-CUE, 25 User Licences (CCME, CUE, and Phone User licences), 10 Unified CallConnector Personal Licences, 128 MB Flash/256 MB DRAM
CISCO2811-V/K9	Cisco 2811 voice bundle with PVDM2-16, 64 MB Compact Flash/256 MB DRAM, and Cisco IOS SP services
CISCO2811-CCME/K9	Cisco 2811 voice bundle with PVDM2-16, CCME featuring 36-phone license, 128 MB Flash/256 MB DRAM, and Cisco IOS SP services
CISCO2811-SRST/K9	Cisco 2811 voice bundle with PVDM2-16, SRST featuring 36-phone license, 128 MB Flash/256 MB DRAM, and Cisco IOS SP services
C2811-15UC/K9	Cisco 2811 Unified Communications Bundle with IOS SP Services, PVDM2-32, AIM-CUE, 15 User Licences (CCME, CUE, and Phone User licences), 5 Unified CallConnector Personal Licences, 128 MB Flash/256 MB DRAM
CISCO2801-V/K9	Cisco 2801 voice bundle, PVDM2-8, Cisco IOS SP services, 64 MB Compact Flash/256 MB DRAM
CISCO2801-CCME/K9	Cisco 2801 voice bundle with CCME featuring 24-phone license, Cisco IOS SP services, 64 MB Compact Flash/256 MB DRAM
CISCO2801-SRST/K9	Cisco 2801 voice bundle with SRST featuring 24-phone license, Cisco IOS SP services, 64 MB Compact Flash/256 MB DRAM
C2801-10UC/K9	Cisco 2801 Unified Communications Bundle with IOS SP Services, PVDM2-32, AIM-CUE, 10 User Licences (CCME, CUE, and Phone User licences), 2 Unified CallConnector Personal Licences, 128 MB Flash/256 MB DRAM

Product Bundles continued

Product Number	Product Description
Security Bundles	
CISCO2851-SEC/K9	Cisco 2851 security bundle with Cisco IOS advanced security, and 64 MB Compact Flash/256 MB DRAM
CISCO2851-HSEC/K9	Cisco 2851 security bundle with Cisco IOS advanced IP services, 64 MB Compact Flash/256 MB DRAM, and AIM-VPN-EPII-PLUS
CISCO2821-SEC/K9	Cisco 2821 security bundle with Cisco IOS advanced security, and 64 MB Compact Flash/256 MB DRAM
CISCO2821-HSEC/K9	Cisco 2821 security bundle with Cisco IOS advanced IP services, 64 MB Compact Flash/256 MB DRAM, and AIM-VPN-EPII-PLUS
CISCO2811-SEC/K9	Cisco 2811 security bundle with Cisco IOS advanced security, and 64 MB Compact Flash/256 MB DRAM
CISCO2811-HSEC/K9	Cisco 2811 security bundle with Cisco IOS advanced IP services, 64 MB Compact Flash/256 MB DRAM, and AIM-VPN-EPII-PLUS
CISCO2801-SEC/K9	Cisco 2801 Security bundle with Cisco IOS advanced security, and 64 MB Compact Flash/256 MB DRAM
CISCO2801-HSEC/K9	Cisco 2801 security bundle with AIM-VPN-EPII-PLUS, Cisco IOS advanced IP services, and 64 MB Compact Flash/256 MB DRAM
Broadband Bundles	
CISCO2811-ADSL/K9	Cisco 2811 ADSL bundle, WIC-1ADSL (ADSLoPOTS), 64 MB Compact Flash/256 MB DRAM, Cisco IOS SP services
CISCO2801-ADSL/K9	Cisco 2801 DSL bundle, WIC-1ADSL (ADSLoPOTS), Cisco IOS SP Services, 64 MB Compact Flash/192 MB DRAM
CISCO2801-ADSL2/K9	Cisco 2801 bundle, HWIC-1ADSL, SP Services, 64 MB Flash/192 MB DRAM
CISCO2811-ADSL2/K9	Cisco 2811 bundle, HWIC-1ADSL, SP Services, 64 MB Flash/256 MB DRAM
C2801-SHDSDL-V3/K9	Cisco 2801 bundle, WIC-1SHDSL-V3, SP Services, 64 MB Flash/256 MB DRAM
C2801-2SHDSL/K9	Cisco 2801 2-pair G.SHDSL bundle, HWIC-2SHDSL, SP Services, 64 MB Flash/192 MB DRAM
C2801-4SHDSL/K9	Cisco 2801 4-pair G.SHDSL bundle, HWIC-4SHDSL, SP Services, 64 MB Flash/192 MB DRAM
C2811-SHDSDL-V3/K9	Cisco 2811 DSL bundle, WIC-1SHDSL-V3 (4-wire), SP Services, 64 MB Flash/256 MB DRAM
C2811-2SHDSL/K9	Cisco 2811 2-pair G.SHDSL bundle, HWIC-2SHDSL, SP Services, 64 MB Flash/256 MB DRAM
C2811-4SHDSL/K9	Cisco 2811 4-pair G.SHDSL bundle, HWIC-4SHDSL, SP Services, 64 MB Flash/256 MB DRAM
C2821-4SHDSL/K9	Cisco 2821 4-pair G.SHDSL bundle, HWIC-4SHDSL, SP Services, 64 MB Flash/256 MB DRAM
WAN Optimization Bundles	
CISCO2851-WAE/K9	2851, NME-WAE-502-K9, WAAS Trans, ASK9, 128F/256D
CISCO2821-WAE/K9	2821, NME-WAE-502-K9, WAAS Trans, ASK9, 128F/256D
CISCO2811-WAE/K9	2811, NME-WAE-502-K9, WAAS Trans, ASK9, 64F/256D
CISCO2811-WAE-302/K9	2811, NME-WAE-302-K9, WAAS Trans, ASK9, 64F/256D

Product Bundles continued

Product Number	Product Description
3G Bundles	
C2811-3G-G-SEC/K9	Cisco 2811, HWIC-3G-GSM, 64MB FL /256MB DRAM, Adv Security
C2811-3G-V-SEC/K9	Cisco 2811, HWIC-3G-CDMA-V, 64MB FL/256MB DRAM, Adv Security
C2811-3G-S-SEC/K9	Cisco 2811, HWIC-3G-CDMA-S, 64MB FL/256MB DRAM, Adv Security



Cisco 2900 Series Integrated Services Routers

The Cisco® 2900 Series Integrated Services Routers build on 25 years of Cisco innovation and product leadership. The new platforms are architected to enable the next phase of branch-office evolution, providing rich media collaboration and virtualization to the branch while maximizing operational cost savings. The Integrated Services Routers Generation 2 platforms are future-enabled with multi-core CPUs, support for high capacity DSPs (Digital Signal Processors) for future enhanced video capabilities, high powered service modules with improved availability, Gigabit Ethernet switching with enhanced POE, and new energy monitoring and control capabilities while enhancing overall system performance. Additionally, a new Cisco IOS® Software Universal image and Services Ready Engine module enable you to decouple the deployment of hardware and software, providing a flexible technology foundation which can quickly adapt to evolving network requirements. Overall, the Cisco 2900 Series offer unparalleled total cost of ownership savings and network agility through the intelligent integration of market leading security, unified communications, wireless, and application services.

Benefits and Advantages

Services on Demand

The Cisco 2900 Series Integrated Services Routers extend this leadership in total cost of ownership by reducing initial capital outlays by decoupling the delivery of software from hardware on optional service modules. In addition, customers receive a Universal IOS image, capable of enabling all of Cisco's rich IOS features allowing you to quickly deploy new services without having to download a new IOS image.

Investment Protection

The Cisco 2900 Series extends its leadership in total cost of ownership by reducing deployment costs and increasing flexibility. The platform also offers investment protection with support for many of the existing ISR modules.

Energy Efficiency

The Cisco 2900 architecture has been designed with higher efficiency power supplies that provide energy-savings features that include intelligent power management, allowing customers to control power to a specific module based on time of day, with full Cisco EnergyWise feature support in the future.

Cisco 2900 Series builds on the best-in-class offering of the existing Cisco 2800 Series Integrated Services Routers by offering four platforms (Figure 1): the Cisco 2901, 2911, 2921, and 2951 Integrated Services Routers.

All Cisco 2900 Series Integrated Services Routers offer embedded hardware encryption acceleration, voice- and video-capable digital signal processor (DSP) slots, optional firewall, intrusion prevention, call processing, voicemail, and application services. In addition, the platforms support the industries widest range of wired and wireless connectivity options such as T1/E1, xDSL, copper and fiber GE.

Benefits and Advantages continued

Overall, the Cisco 2900 Series offers unparalleled operational savings and network agility through the continued intelligent integration of market leading security, unified communications, wireless, and application optimization services.

Key Business Benefits

The Integrated Services Routers Generation 2 (ISR G2) provide superior services integration and agility. Designed for scalability, the modular architecture of these platforms enables you to grow and adapt with your business needs. The table below lists the business benefits of the Cisco 2900 Series.

Benefits	Description
Services Integration	<ul style="list-style-type: none"> The Cisco 2900 Series ISRs offer increased levels of services integration with voice, video, security, wireless, mobility, and data services, enabling greater efficiencies and cost savings.
Services on Demand	<ul style="list-style-type: none"> A single Cisco IOS® Software Universal image is installed on each ISR G2. The Universal image contains all of the Cisco IOS technology sets which can be activated with a software license. This allows your business to quickly deploy advanced features without downloading a new IOS image. Additionally, larger default memory is included to support the new capabilities. The Cisco Services Ready Engine (SRE) enables a new operational model which allows you to reduce capital expenditures (CapEx) and deploy a variety of application services as needed on a single integrated compute services module.
High Performance with Integrated Services	<ul style="list-style-type: none"> The Cisco 2900 Series enables deployment in high speed WAN environments with concurrent services enabled up to 75 Mbps. A multigigabit fabric (MGF) enables high-bandwidth module-to-module communication without compromising routing performance.
Network Agility	<ul style="list-style-type: none"> Designed to address customer business requirements, the Cisco 2900 Series modular architecture offers increased capacity and performance as your network needs grow. Modular interfaces offer increased bandwidth, a diversity of connection options, and network resiliency.

Benefits and Advantages continued

Benefits	Description
Energy Efficiency	<p>The Cisco 2900 Series architecture provides energy-saving features that include the following:</p> <ul style="list-style-type: none"> The Cisco 2900 Series offers intelligent power management and allows the customer to control power to the modules based on the time of day. Cisco EnergyWise technology will be supported in the future. Services integration and modularity on a single platform performing multiple functions, optimizes raw materials consumption and energy usage. Platform flexibility and ongoing development of both hardware and software capabilities lead to a longer product lifecycle, lowering all aspects of the total cost of ownership, including materials and energy use. High efficiency power supplies are provided with each platform.
Investment Protection	<p>The Cisco 2900 Series maximizes investment protection:</p> <ul style="list-style-type: none"> Reuse of a broad array of existing modules supported on the original Integrated Services Routers provides a lower cost of ownership A rich set of Cisco IOS Software features carried forward from the original Integrated Services Routers and delivered in a single universal image. Flexibility to adapt as your business needs evolve.

Platform Architecture and Modularity

The Cisco 2900 Series is architected to meet the application demands of today's branch offices with design flexibility for future applications. The modular architecture is designed to support increasing bandwidth requirements, time-division multiplexing (TDM) interconnections, and fully integrated power distribution to modules supporting 802.3af Power over Ethernet (PoE) and Cisco Enhanced PoE (ePoE).

Architectural Feature	Description
Modular Platform	<ul style="list-style-type: none"> The Cisco 2900 Series ISRs are highly modular platforms with several types of module slots to add connectivity and services for varied branch-office network requirements. The ISRs offer an industry-leading breadth of LAN and WAN connectivity options through modules to accommodate field upgrades for future technologies without requiring a platform replacement.
Processors	<ul style="list-style-type: none"> The Cisco 2900 Series are powered by high-performance multi-core processors that can support the growing demands of high-speed WAN connections to the branch-office while also running multiple concurrent services.
Embedded IP Security with Security Sockets Layer (IPsec/SSL) VPN Hardware Acceleration	<ul style="list-style-type: none"> Embedded hardware encryption acceleration is enhanced to provide higher scalability, which combined with an optional Cisco IOS Security license, enables WAN link security and VPN services (both IPsec and SSL acceleration). The onboard encryption hardware replaces and outperforms the advanced integration modules (AIMs) of previous generations.
Multigigabit Fabric (MGF)	<ul style="list-style-type: none"> The Cisco 2900 Series introduces an innovative multigigabit fabric (MGF) that allows for efficient module-to-module communication, enabling tighter services interactions across modules while reducing the overhead on the route processor.
TDM Interconnectivity Fabric	<ul style="list-style-type: none"> Unified communications services in the branch office are significantly enhanced with the use of a TDM interconnectivity fabric in the system architecture, allowing for scaling of DS-0 channel capacity.
Integrated Gigabit Ethernet Ports	<ul style="list-style-type: none"> All onboard WAN ports are 10/100/1000 Gigabit Ethernet WAN routed ports. One of the three 10/100/1000 Ethernet WAN ports on the Cisco 2921 and 2951 supports Small Form-Factor Pluggable (SFP)-based connectivity in lieu of a RJ-45 port and enabling fiber connectivity.
Innovative Universal-Serial-Bus (USB)-based Console Access	<ul style="list-style-type: none"> A new, innovative USB console port offers management connectivity for devices without a serial port such as modern laptop computers. Traditional console and auxiliary ports are also available.
Optional Integrated Power Supply for Distribution of PoE and Universal DC Power Supply	<ul style="list-style-type: none"> An optional upgrade to the internal power supply provides inline power (802.3af-compliant PoE and Cisco Inline Power) to integrated switch modules. On the Cisco 2911, 2921, and 2951, an optional DC power supply will be available in the future that extends deployment into central offices and industrial environments.



Platform Architecture and Modularity

Architectural Feature	Description
Optional External Redundant Power Supply (RPS)	<ul style="list-style-type: none"> The Cisco 2911, 2921, and 2951 allow for power redundancy through the use of an external RPS device, thereby decreasing network downtime and protecting the network from power-supply failures. Redundant power on the Cisco 2900 Series is supported through the Cisco RPS 2300 Redundant Power System. You can use the Cisco RPS 2300 to provide redundant power for Cisco 2900 Series ISRs as well as Cisco Catalyst® switches. In order to use the Cisco RPS 2300, an external RPS adapter is required (configurable option) to connect the platform to the external RPS.
PoE Boost	<ul style="list-style-type: none"> When connected to an external RPS device, the Cisco 2911, 2921, and 2951 can operate in a PoE boost configuration in lieu of redundant power mode—whereby the power capacity of the platform is increased to twice the normal level to power additional PoE ports.
Designed for Flexible Deployments	<ul style="list-style-type: none"> The Cisco 2911 and 2951 are designed for NEBS environments The 2911 is 12 inches deep and has an optional fan filter for deployments in a variety of environments. An assembly that provides front-to-back airflow is also available for 23 inch racks.

Modularity Features and Benefits

The Cisco 2900 Series provides significantly enhanced modular capabilities (refer to Table 3) offering investment protection for customers. Most of the modules available on previous generations of Cisco routers, such as the Cisco 2800 Series, are supported on the Cisco 2900 Series. Additionally, modules can be used on other supported Cisco platforms to provide maximum investment protection. Taking advantage of common interface cards across a network greatly reduces the complexity of managing inventory requirements, implementing large network rollouts, and maintaining configurations across a variety of branch-office sizes.

A complete list of supported modules, including a list of supported SFPs for the Cisco 2900 Series, is available at: <http://www.cisco.com/go/2900>.

ISR Modules	Description
<p>Cisco Service Module</p> 	<ul style="list-style-type: none"> Each service module slot offers high-data-throughput capability: <ul style="list-style-type: none"> Up to 4 Gbps aggregate toward the route processor Up to 2 Gbps aggregate to other module slots over MGF Service module (SM) slots are highly flexible with support for double-wide service modules (SM-D's), which are Service Modules that require two SM slots. SM-Ds in the Cisco 2921 and 2951 provide flexibility for higher-density modules. A service module slot replaces the network module and the extension module for voice/fax (EVM) slots and is offered on Cisco 2911, 2921, and 2951 ISRs. An adapter module enables backward compatibility with existing network modules, enhanced network modules (NMEs), and EVMs. Service module slots provide twice the power capabilities relative to the network-module slots, allowing for flexibility for higher-scale and better-performance modules. Power to service module slots can be managed by extensions similar to the Cisco EnergyWise framework, so your organization can reduce energy consumption in your network infrastructure. Full EnergyWise support will be available in future software releases.
<p>Cisco Enhanced High-Speed WAN Interface Card (EHWIC)</p> 	<ul style="list-style-type: none"> The EHWIC slot provides enhancements to the prior generation's high-speed WAN interface card (HWIC) slots while provide maximum investment protection by natively supporting HWICs, WAN interface cards (WICs), voice interface cards (VICs), and voice/WAN interface cards (VWICs). Four integrated EHWIC slots on the Cisco 2901, 2911, 2921, and 2951 allow for more flexible configurations. Each HWIC slot offers high-data-throughput capability: <ul style="list-style-type: none"> Up to 1.6 Gbps aggregate toward the route processor Up to 2 Gbps aggregate to other module slots over the MGF Flexibility to support double-wide modules is enabled by combining two EHWIC slots. Up to 2 double-wide HWIC (HWIC-D) modules are supported.

Modularity Features and Benefits

ISR Modules

Cisco Internal Services Module (ISM)



Description

- A single ISM slot provides flexibility to integrate intelligent service modules on an internal slot within the chassis
- Each ISM slot offers high-data-throughput capability:
 - Up to 4 Gbps aggregate toward the route processor
 - Up to 2 Gbps aggregate to other module slots over the MGF
- The ISM replaces the AIM slot; existing AIM modules are not supported in the ISM slot.
- Power to ISM slots can be managed by extensions similar to the Cisco EnergyWise framework, so your organization can reduce energy consumption in your network infrastructure. Full EnergyWise support will be available in future software releases.

Cisco High-Density Packet Voice Digital Signal Processor (DSP) Module (PVDM3) Slots on Motherboard



- PVDM3 slots natively support PVDM3 modules, providing support for richer density for rich-media voice and video.
- Each PVDM3 slot connects back to the system architecture through a 2 Gbps aggregate link through the MGF.
- Investment protection for PVDM2 modules is supported through an adapter module.
- Power to the PVDM slots can be managed by extensions similar to the Cisco EnergyWise framework, so your organization can reduce energy consumption in your network infrastructure. Full EnergyWise support will be available in future software releases.

Compact Flash Slots

- Two external Compact Flash slots are available on the Cisco 2900 Series Integrated Services Routers. Each slot can support high-speed storage densities upgradeable to 4 GB in density.

USB 2.0 ports

- Two high-speed USB 2.0 ports are supported. The USB ports enable secure token capabilities and storage.

Cisco IOS Software

Cisco 2900 Series Integrated Services Routers deliver innovative technologies running on industry-leading Cisco IOS Software. Developed for wide deployment in the world's most demanding enterprise, access, and service provider networks, the Integrated Services Routers Generation 2 platforms are supported on Cisco IOS Software releases 15M&T. Release 15.0(1)M is available immediately and provides support for a comprehensive portfolio of Cisco technologies, including the functionality and features delivered in releases 12.4 and 12.4T. New innovations in 15.0(1)M span multiple technology areas, including security, voice, high availability, IP Routing and Multicast, quality of service (QoS), IP Mobility, Multiprotocol Label Switching (MPLS), VPNs, and embedded management.

Cisco IOS Software Licensing and Packaging

A single Cisco IOS Universal image encompassing all IOS technology feature sets is delivered with the platforms. You can enable advanced features by activating a software license on the Universal image. In previous generations of access routers, these feature sets required you to download a new software image. Technology packages and feature licenses, enabled through the Cisco software licensing infrastructure, simplify software delivery and decrease the operational costs of deploying new features.

Four major technology licenses are available on the Cisco 2900 Series Integrated Services Routers; you can activate the licenses through the Cisco software activation process identified at <http://www.cisco.com/go/sa>.

The four licenses are as follows:

- IP Base: This technology package is available as default
- Data
- Unified Communications
- Security (SEC) or Security with No Payload Encryption (SEC-NPE)

For additional information and details about Cisco IOS Software licensing and packaging on Cisco 2900 Series Integrated Services Routers, please visit: <http://www.cisco.com/go/2900I>

For a more comprehensive list of features supported in Cisco IOS software refer to the Feature Navigator tool at: <http://www.cisco.com/go/fn>.

Key Branch-Office Services

The Cisco Integrated Services Routers are industry-leading platforms that offer unprecedented levels of services integration. Designed to meet the requirements of the branch office, these platforms provide a complete solution with voice, video, security, mobility and application services. Businesses enjoy the benefit of deploying a single device that meets all their needs, reducing capital and operational expenses.

Unified Communications, Collaboration, and Voice-Gateway Services

The Cisco 2900 Integrated Services Router is the foundation for collaboration in the small and midsize branch office, serving as a critical component of a Cisco's video architecture (Medianet) and enterprise Unified Communications solution. With embedded voice services and a wide range of supported telephony interfaces, the Cisco 2900 Series delivers maximum deployment flexibility for the distributed enterprise. Unified communications is enabled through a rich signaling and media-processing infrastructure, including a variety of protocols, media interworking, signal and media security, transcoding, conferencing, and QoS. Cisco Integrated Services Routers also feature a wide range of voice-gateway interfaces, supporting a broad array of signaling and physical network interfaces.

The Cisco 2900 Series enables a full range of existing and emerging video services, with scaling improvements to support Cisco TelePresence® conferencing, security, and session control. The Cisco Unified Border Element extends these capabilities for business-to-business TelePresence communications. The Cisco 2900 Series adds support for the new Cisco High-Density Packet Voice Digital Signal Processor (DSP) Module (PVD3M), which has been optimized for voice and video support. The new PVD3M modules support all voice-gateway functions of earlier generations of PVD3Ms and add higher density and more processing power to support emerging rich-media applications. The Cisco 2900 Series provides 2 or 3 onboard PVD3M slots, depending on the platform.

Cisco IOS Software continued

Cisco Unified Communications Manager Express and Survivable Remote Site Telephony

The Cisco Integrated Services Routers natively provide optional unified communications services within the Cisco IOS Software, minimizing the IT hardware footprint and total cost of ownership at the branch office. Cisco Unified Communications Manager Express (CME) provides a broad range of IP private-branch-exchange (PBX) and key-system features integrated into the router for the small and midsize branch office. Cisco Survivable Remote Site Telephony (SRST), also inherently available in Cisco IOS Software, and an option on the Cisco 2900 Series, helps ensure that branch-office employees have uninterrupted telephony services and features, even if the connection to a centralized Cisco Unified Communications Manager is disrupted. Coupled with Cisco Unity® Express, the integrated solution for voicemail, Automated Attendant, and interactive voice response (IVR), the Cisco 2900 Series offers the branch office a complete range of unified communications services while delivering industry-leading security within a single platform.

VoiceXML Application Services

The Cisco 2900 Series also supports standards-certified VoiceXML browser services. VoiceXML is an open-standard markup language used to create voice-enabled web browsers and IVR applications. Just as HTML enables you to retrieve data with a PC, VoiceXML enables you to retrieve data using voice or dual-tone-multifrequency (DTMF) telephony input. The Cisco 2900 Series can deliver a much higher range of concurrent voice-gateway services combined with VoiceXML browser services, for up to 200 sessions on the Cisco 2951.

Cisco Unified Border Element

The Cisco Unified Border Element capabilities supported on the Cisco 2900 Series address the emerging requirements in an IP-centric interconnect for branch-office unified communications between enterprises and service provider networks. Cisco Unified Border Element provides intelligent border-element functions such as physical and logical ingress and egress demarcation points, signaling and media control, and consolidated security and management features. The Cisco 2900 Series supports higher scale than previously provided on the Cisco 2800 Series, up to 3 times the number of sessions.

Integrated Network Security for Data, Voice, Video, and Mobility

Security is essential to protect a business' intellectual property while also ensuring business continuity and providing the ability to extend the corporate workplace to employees who need anytime, anywhere access to company resources. As part of the Cisco SAFE architectural framework that allows organizations to identify, prevent, and adapt to network security threats, the Cisco 2900 Series Integrated Services Routers facilitate secure business transactions and collaboration.

The Cisco IOS Software Security technology package for the Cisco 2900 Series offers a wide array of common security features such as advanced application inspection and control, threat protection, and encryption architectures for enabling more scalable and manageable VPN networks. The Cisco 2900 Series offers onboard hardware-based encryption acceleration to provide greater IPsec throughput with less overhead for the route processor when compared with software-based encryption solutions. Cisco Integrated Services Routers offer a comprehensive and adaptable security solution for branch offices that includes features such as:

- Secure connectivity: Secure collaborative communications with Group Encrypted Transport VPN, Dynamic Multipoint VPN (DMVPN), or Enhanced Easy VPN
- Integrated threat control: Responding to sophisticated network attacks and threats using Cisco IOS Firewall, Cisco IOS Zone-Based Firewall, Cisco IOS IPS, Cisco IOS Content Filtering, and Flexible Packet Matching (FPM)
- Identity management: Intelligently protecting endpoints using technologies such as authentication, authorization, and accounting (AAA) and public key infrastructure (PKI)

Detailed information about the security features and solutions supported on the Cisco 2900 Series is available at <http://www.cisco.com/go/routersecurity>.

Wireless and Mobility Services

Wireless LAN/WAN

The Cisco Integrated Services Routers supporting the Cisco Unified Wireless Architecture enable deployment of secure, manageable wireless LANs (WLANs) optimized for remote sites and branch offices, including fast secure mobility, survivable authentication, and simplified management. The Cisco Wireless LAN Controller Module on the Cisco 2900 Series allows small and medium-sized businesses (SMBs) and enterprise branch offices to cost-effectively deploy and manage secure WLANs. Cisco Wireless LAN Controllers work in conjunction with Cisco lightweight access points and the Cisco Wireless Control System (WCS) to provide system-wide WLAN functions, managing up to 6, 12, and 25 access points.

Wireless WAN

Cisco third-generation (3G) wireless WAN (WWAN) modules combine traditional enterprise router functions, such as remote management, advanced IP services such as voice over IP (VoIP), and security, with mobility capabilities of 3G WAN access. Using high-speed 3G wireless networks, routers can replace or complement existing landline infrastructure, such as dialup, Frame Relay, and ISDN. Cisco 3G solutions support 3G standards High-Speed Packet Access (HSPA) and Evolution Data Only/Evolution Data Optimized (EVDO) providing you with a true multipath WAN backup and the ability to rapidly deploy primary WAN connectivity. For more information about 3G solutions on Cisco Integrated Services Routers, please visit www.cisco.com/go/3g.

Integrated LAN Switching

The Cisco 2900 Integrated Services Routers (Cisco 2911 through Cisco 2951) support the new Cisco Enhanced EtherSwitch® Service Modules, which greatly expand router capabilities by integrating industry-leading Layer 2 or Layer 3 switching with feature sets identical to those found in the Cisco Catalyst 2960 and Catalyst 3650-E Series Switches performing local line-rate switching and routing.

The new Cisco Enhanced EtherSwitch Service Modules take advantage of the increased power capabilities on the Cisco 2900 ISRs. Additionally, the Cisco Enhanced EtherSwitch modules enable the newest Cisco power initiatives, Cisco EnergyWise, Cisco Enhanced Power over Ethernet (ePoE), per-port PoE power monitoring, and RPS-

enabled PoE boost. These technologies allow you to meet increased endpoint power requirements without increasing the total power consumption of the branch.

Application Services

As organizations continue to centralize and consolidate their branch-office IT infrastructure in an effort to reduce cost and complexity, they are challenged to provide an excellent user experience, ensure continuous service availability, and deliver business-relevant applications when and where they are needed. To address these challenges, the Cisco 2900 Series provides the capability to host Cisco, third-party, and custom applications on a portfolio of high-performance Cisco Services Ready Engine (SRE) modules that transparently integrate into the router. The modules have their own processors, storage, network interfaces, and memory that operate independently of the host router resources, helping to ensure maximum concurrent routing and application performance while reducing physical space requirements, lowering power consumption, and consolidating management.

Application Acceleration

The Cisco 2900 Series seamlessly combines industry leading security, IOS based traffic control and visibility, with Cisco application acceleration solutions. Cisco IOS Software features such as NBAR, IP SLA, and NetFlow provide visibility and monitoring of traffic patterns and application performance while IOS features such as QoS, ACLs, and PfR intelligently control the traffic to maximize the quality of the user experience and employee productivity. The user experience can be further enhanced through the addition of a Cisco WAAS Network Module which can be used to securely provide more advanced WAN optimization techniques such as TCP optimization, caching, compression, and application acceleration. Cisco Integrated Services Routers combined with Cisco WAAS Network Modules, provide optimal performance for applications delivered from a central data center to branch-office users. The solution allows you to consolidate costly server, storage, and backup infrastructure into data centers while maintaining LAN-like service levels for remote users.

Wireless and Mobility Services continued

Cisco Unified Computing System Express

The Cisco Services Ready Engine solution is available in a Service Module and Internal Service Module (ISM) form-factor. The Service Module hardware offers up to a seven times performance improvement over the previous-generation Network Modules and provides a multi-core x86-64 processor. The SRE modules also support up to 1 terabyte of storage, RAID configurations, hardware-assisted virtualization and cryptography options. The Cisco SRE module enables on-demand provisioning of branch-office applications on the Cisco 2900 Series platforms so that you can deploy the right application, at the right time, in the right place. The hardware and software decoupling provided by the service-ready deployment model enables applications to be provisioned on the module at the time of its installation or remotely anytime thereafter. Supported solutions include Cisco Wide Area Application Services (WAAS), Cisco Unity Express, Cisco Application Extension Platform (AXP), Cisco Wireless LAN Controller (WLC), Cisco Video Surveillance, and other applications under development. The Service Ready Engine enables organizations of various sizes to future-proof their network by allowing them to quickly deploy new branch-office applications without deploying new hardware, reducing the cost of rolling out branch-office services.

Managing Your Integrated Services Routers

Network management applications are instrumental in lowering operating expenses (OpEx) while improving network availability by simplifying and automating many of the day-to-day tasks associated with managing an end-to-end network. Day-one device support provides immediate manageability support for the Integrated Services Router, enabling quick and easy deployment, monitoring, and troubleshooting from Cisco and third-party applications.

Organizations rely on Cisco, third-party, and in-house developed network management applications to achieve their OpEx and productivity goals. Underpinning those applications are the embedded management features available in every Integrated Services Router. The new Integrated Services Routers continue a tradition of broad and deep manageability features such as IP service-level agreement (IP SLA), Cisco IOS Embedded Event Manager (EEM), and NetFlow which allow you to know the status of your network at all times. These features, along with Simple Network Management Protocol (SNMP) and syslog, enable your organization's management applications.

When to Deploy

The Cisco 2951 Integrated Services Router (ISR) delivers highly secure data, voice, video, and application services for small offices. Key features include:

- 3 integrated 10/100/1000 Ethernet ports with 1 port capable of RJ-45 or SFP connectivity
- 2 service module slots
- 4 Enhanced High-Speed WAN Interface Card slots
- 3 onboard digital signal processor (DSP) slots
- 1 internal service module slot for application services
- Fully integrated power distribution to modules supporting 802.3af Power over Ethernet (PoE) and Cisco Enhanced PoE

Security

- Onboard hardware acceleration for VPN encryption
- Secure collaborative communications with Group Encrypted Transport VPN, Dynamic Multipoint VPN, or Enhanced Easy VPN
- Integrated threat control using Cisco IOS Firewall, Cisco IOS Zone-Based Firewall, Cisco IOS IPS, and Cisco IOS Content Filtering
- Identity management using authentication, authorization, and accounting (AAA), and public key infrastructure

Voice

- High-density packet voice DSP module, optimized for voice and video support
- Standards-certified VoiceXML browser services
- Cisco Unified Border Element capabilities
- Cisco Unity Express voicemail support
- Support for Cisco Communications Manager Express and Survivable Remote Site Telephony

The Cisco 2921 Integrated Services Router (ISR) delivers highly secure data, voice, video, and application services for small offices. Key features include:

- 3 Integrated 10/100/1000 Ethernet ports with 1 port capable of RJ-45 or SFP connectivity
- 1 service module slot
- 4 Enhanced High-Speed WAN Interface Card (EHWIC) slots
- 3 onboard digital signal processor slots
- 1 internal service module slot for application services
- Fully integrated power distribution to modules supporting 802.3af Power over Ethernet (PoE) and Cisco Enhanced PoE

Security

- Embedded hardware-accelerated VPN encryption
- Secure collaborative communications with Group Encrypted Transport VPN, Dynamic Multipoint VPN, or Enhanced Easy VPN
- Integrated threat control using Cisco IOS Firewall, Cisco IOS Zone-Based Firewall, Cisco IOS IPS, and Cisco IOS Content Filtering
- Identity management: Intelligently protecting endpoints using authentication, authorization, and accounting (AAA), and public key infrastructure

Voice

- High-density packet voice DSP module, optimized for voice and video support
- Standards-certified VoiceXML browser services
- Cisco Unified Border Element capabilities
- Cisco Unity Express voicemail support
- Support for Cisco Communications Manager Express and Survivable Remote Site Telephony

When to Deploy continued

The Cisco 2911 Integrated Services Router (ISR) delivers highly secure data, voice, video, and application service. Key features include:

- 3 integrated 10/100/1000 Ethernet ports (RJ-45 only)
- 1 service module slot
- 4 enhanced high-speed WAN interface card slots
- 2 onboard digital signal processor (DSP) slots
- 1 Internal Service Module slot for application services
- Fully integrated power distribution to modules supporting 802.3af Power over Ethernet (PoE) and Cisco Enhanced PoE

Security

- Embedded hardware-accelerated VPN encryption for secure connectivity and collaborative communications Integrated threat control using Cisco IOS Firewall, Cisco IOS Zone-Based Firewall, Cisco IOS IPS, and Cisco IOS Content Filtering
- Identity management using authentication, authorization, and accounting (AAA) and public key infrastructure

Voice

- High-density-packet voice DSP module, optimized for voice and video support
- Standards-certified VoiceXML browser services
- Cisco Unified Border Element capabilities
- Cisco Unity Express voicemail support
- Support for Cisco Communications Manager Express and Survivable Remote Site Telephony

The Cisco 2901 Integrated Services Router (ISR) delivers highly secure data, voice, video, and application services for small offices. Key features include:

- 2 integrated 10/100/1000 Ethernet ports
- 4 enhanced high-speed WAN interface card slots
- 2 onboard digital signal processor (DSP) slots
- 1 onboard Internal Service Module for application services
- Fully integrated power distribution to modules supporting 802.3af Power over Ethernet (PoE) and Cisco Enhanced PoE

Security

- Embedded hardware-accelerated VPN encryption for secure collaborative VPN communications
- Integrated threat control using Cisco IOS Firewall, Cisco IOS Zone-Based Firewall, Cisco IOS IPS, and Cisco IOS Content Filtering
- Identity management that uses authentication, authorization, and accounting (AAA) and public key infrastructure

Voice

- High-density-packet voice DSP module, optimized for voice and video
- Standards-certified VoiceXML browser services
- Cisco Unified Border Element capabilities
- Cisco Unity Express voicemail support
- Support for Cisco Communications Manager Express and Survivable Remote Site Telephony

When to Deploy continued

The Cisco 2900 Integrated Routers Series are recommended to be deployed when enabling Borderless Networks at the Branch for small to medium size branch offices with user WAN bandwidth requirements up to 75Mbps. See picture below for specific 2900 Series recommended WAN bandwidth deployment guidelines.

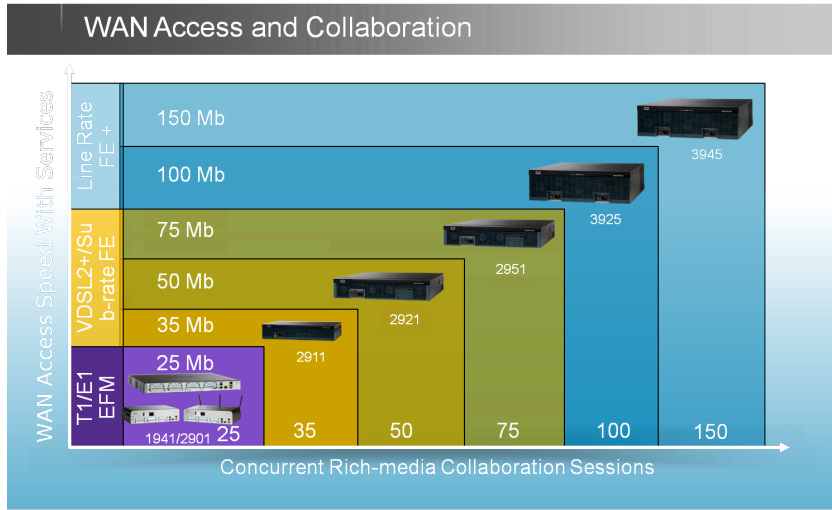

Ordering Information

For 2900 Series platform overview, series specifications, ordering information, product bundles, and technical specifications please see the data sheet at: http://cisco.com/en/US/prod/collateral/routers/ps10537/data_sheet_c78_553896.html

Ordering Information

The Cisco 2900 Series Integrated Services Routers are orderable and shipping. For information about how to order the Cisco 2900 Series, please visit the Cisco 2900 Series Ordering Guide.

To place an order, visit the Cisco Ordering Home Page which provides basic ordering information. For additional product numbers, including the Cisco 2900 Series bundle offerings, please check the Cisco 2900 Series Integrated Services Router Price List at: or contact your local Cisco account representative.

Ordering Information continued

Product Number	Product Description
CISCO2901/K9	Cisco 2901 with 2 onboard GE, 4 EHWIC slots, 2 DSP slots, 1 ISM slot, 256MB CF default, 512MB DRAM default, IP Base
CISCO2911/K9	Cisco 2911 with 3 onboard GE, 4 EHWIC slots, 2 DSP slots, 1 ISM slot, 256MB CF default, 512MB DRAM default, IP Base
CISCO2921/K9	Cisco 2921 with 3 onboard GE, 4 EHWIC slots, 3 DSP slots, 1 ISM slot, 256MB CF default, 512MB DRAM default, IP Base
CISCO2951/K9	Cisco 2951 with 3 onboard GE, 4 EHWIC slots, 3 DSP slots, 1 ISM slot, 256MB CF default, 512MB DRAM default, IP Base
SL-29-DATA-K9	Data License for Cisco 2901-2951
SL-29-UC-K9	Unified Communications License for Cisco 2901-2951
SL-29-SEC-K9	Security License for Cisco 2901-2951



Cisco 3800 Series

Based on 20 years of innovation, Cisco 3800 Integrated Services Routers extend Cisco's leadership in multiservice routing by providing customers with unparalleled network agility, performance, and intelligence. The Cisco 3800 Series is the flagship platform in a portfolio of next-generation routers that integrate advanced technologies, adaptive services, and secure enterprise communications.

These new routers offer the performance and reliable packet delivery necessary to deliver mission-critical network capabilities efficiently, including real-time applications such as Voice over IP (VoIP), business video, and collaborative communications. Architectural enhancements include embedded security processing, significant platform performance and memory improvements, and new high-density interface types. These design achievements complement the Cisco IOS Software features and superior investment protection that this platform inherits from the Cisco 3700 Series.

The Cisco 3800 Series, comprised of the Cisco 3825 and Cisco 3845, serves as a catalyst for midsize organizations and enterprise branch offices that want to gracefully scale their enterprise edges and take advantage of converged business services, while minimizing the cost and complexity of network upgrades.

Benefits and Advantages

Enhanced Architecture

The Cisco 3800 Series offers two modular platforms optimized for the secure delivery of concurrent voice, video, and data. The integrated services architecture of the Cisco 3800 Series builds on the highly successful Cisco 3700 Series design, and adds embedded security and voice processing to a highly modular system that is optimized for rapid deployment of intelligent network services and converged communications. The Cisco 3800 Series supports the bandwidth requirements for multiple Fast Ethernet interfaces per slot, time-division multiplexing (TDM) interconnections, and fully integrated power distribution to modules supporting 802.3af Power over Ethernet (PoE), while supporting the existing portfolio of modular interfaces.

Integrated Switching

With support for up to 112 ports of integrated switching with inline power, the Cisco 3800 Series offers an excellent platform for combining two of the most common components of any network infrastructure. The Cisco 3800 Series supports the 16-, 24-, and 48-port Cisco EtherSwitch® Service Network Modules which adhere to the 802.3af (PoE) standard. When partnered with the optional internal power supply upgrade, the EtherSwitch Service Network Modules and high-density WAN interface cards (HWICs) power any 802.3af compliant device through their integrated switch ports.

Investment Protection and Versatility

The Cisco 3800 Series provides significant additional value compared to prior generations of Cisco routers at similar price points by offering up to three times the performance, new embedded

Benefits and Advantages continued

service options, and dramatically increased slot performance and density while maintaining support for most of the more than 90 existing modules that are available today for the Cisco 3700 Series. This helps to ensure continuing investment protection to accommodate network expansion or changes in technology as new services and applications are deployed. By integrating the functions of multiple separate devices into a single, compact unit, Cisco 3800 Series Integrated Services Routers dramatically reduce the cost and complexity of managing remote networks. The Cisco 3800 Series delivers multiple concurrent services at wire-speed performance of up to T3/E3 speeds. The Cisco 3845 features a removable motherboard, fan assembly, and supports high-availability features such as online insertion and removal (OIR) of like network modules, and redundant integrated system and inline power supplies.

Integrated Services

With the optional integration of numerous services modules, the Cisco 3800 Series offers the ability to easily integrate the functions of standalone network appliances and components into the Cisco 3800 Series chassis itself. Many of these modules, such as the Cisco Network Analysis Module, Cisco Unity Express™ Voice Mail Module, Cisco Intrusion Prevention Module, and Cisco Wide Area Application Services Module, have embedded processors and hard drives that allow them to run largely independently of the router while allowing management from a single management interface. This flexibility greatly expands the potential applications of the Cisco 3800 Series beyond traditional routing, while maintaining the benefits of integration. The Cisco 3845 Integrated Services Router is optimized for the concurrent delivery of voice, video, and data at T3 wire-rate performance. The architecture provides high-performance embedded security and voice processing for reliable delivery of mission-critical traffic such as VoIP, business video, and collaborative communications.

The Cisco 3845 is engineered to help customers effectively scale deployment of services, offering the following hardware features:

- Two built-in autosensing 10/100/1000 Ethernet ports
- One small form-factor pluggable (SFP) slot gigabit Ethernet
- Two built-in USB ports

- Four network module slots for single-wide or extended network modules, two double-wide or extended double-wide network modules (NME-XD), or two extension voice/fax modules (EVM-HD)
- Four single-wide or two double-wide HWICs
- Two advanced integration modules (AIMs)
- Four Packet Voice DSP Modules (PVDM) slots for voice processing
- Onboard IP Security (IPsec) acceleration
- 802.3af-compliant inline power for IP phones or wireless access points

The Cisco 3825 is engineered to help customers effectively scale deployment of services, offering the following hardware features:

- Two built-in autosensing 10/100/1000 Ethernet ports
- One SFP slot gigabit Ethernet
- Two built-in USB ports

- Two network module slots for single-wide or extended network modules, one double-wide or extended double-wide network module (NME-XD), or one extension voice/fax module (EVM-HD)
- Four single-wide or two double-wide HWICs
- Two AIMs
- Four PVDM slots for voice processing
- Onboard IPsec encryption acceleration
- 802.3af-compliant inline power for IP phones or wireless access points
- External Redundant Power Supply (RPS) for system power and external redundant inline power for IP phones

Secure Networking

Integrated on the motherboard of every Cisco 3800 Series router is hardware-based encryption acceleration that offloads the encryption processes to provide greater IPsec throughput with less overhead for the router CPU when compared with software-based solutions. The integration of optional VPN modules (for enhanced performance and tunnel count), intrusion prevention modules or NAC network modules for network admission control, combined with the rich Cisco IOS Software security feature set that includes firewall, intrusion prevention, voice- and video-enabled VPN (V3PN), Group Encrypted Transport (GET) VPN, and Dynamic Multipoint VPN (DMVPN), Cisco offers the industry's most robust and adaptable security solution for branch office routers.

Benefits and Advantages continued

IP Telephony

The Cisco 3800 Series allows network managers to provide scalable analog and digital telephony without investing in a one-time solution, giving enterprises greater control of their converged telephony needs. Using voice and fax modules, the Cisco 3800 Series can be deployed for applications ranging from VoIP and Voice-over-Frame Relay (VoFR) transport to robust, centralized solutions using the Cisco Survivable Remote Site Telephony (SRST) solution or distributed call processing using Cisco Communication Express (CCME). The architecture is highly scalable with the ability to support up to 168 IP phones with the 3825 router and 240 IP phones with the 3845 router, 24 T1/E1s trunks, 88 foreign-exchange-station (FXS) ports, or 56 foreign-exchange-office (FXO) ports concurrent with data routing and other services.

Video Surveillance

The Cisco® Integrated Video Surveillance solution enables you to rapidly deploy highly distributed, IP-enabled video surveillance at your offices while migrating traditional analog surveillance equipment to IP. The solution based on Cisco 2800 and 3800 Series ISR offers the lowest total cost of ownership (TCO) for the branch office, ease of integration through network transparency, reliable data interoperability, and maximized overall security. It allows you to consolidate costly branch-office servers and deploy new applications centrally while still offering real-time access to physical security video and data.

Security Features

IPsec VPN

- Advanced Encryption Standard (AES) 128, 192, and 256 bit keys; Triple Data Encryption Standard (3DES); and DES cryptology support
- Embedded hardware-based VPN acceleration on the motherboard
- Cisco Easy VPN remote and server
- Group Encrypted Transport (GET-VPN)
- Dynamic Multipoint VPN (DMVPN)
- Virtual Tunnel Interfaces (VTI)
- 802.1x
- VPN QoS—Preclassification support

Multiprotocol Label Switching (MPLS) VPN Support

- Limited provider edge capabilities
- Virtual routing and forwarding (VRF) firewall and VRF IPsec

Cisco IOS IPS

- Inline ability to drop packet, reset connection, locally shun, or send an alarm
- Dynamically load and enable selected attack signatures in the same manner as Cisco IPS Appliances
- For broader signature support and higher performance, look at optional IPS AIM module for ISR

Network Foundation Protection

- Control Plane Policing (CPP)
- AutoSecure
- CPU/Memory Threshold
- Secure Shell (SSH)
- Access Control List (ACL)
- Command-Line Interface (CLI)
- Committed Access Rate (CAR)

IOS WebVPN (SSL VPN)

- Secure remote access for mobile users without installing PC client software
- Integrated into the router — no separate appliance required
- Cisco 3825 and 3845 support up to 200 users (with AIM-VPN/SSL-3)
- Requires IOS WebVPN feature license FL-WEBVPN-10, FL-WEBVPN-25 or FL-WEBVPN-100 (purchase multiple quantities to add up to the desired number of users)
- Requires an IOS security feature set (IOS security feature set is included in all secure router bundles)

Media Authentication and Encryption

- Standards-based authentication and encryption using secure RTP provides a secure environment for IP Communications
- Advanced Encryption Standard (AES) 128-bit cryptography support

Security Features continued

Cisco IOS Firewall

- Feature rich, stateful firewall
- Per-user authentication and authorization
- Real-time alerts
- Transparent firewall
- IPv6 firewall
- VRF-aware firewall
- Advanced Application Inspection and Control
 - HTTP inspection engine
 - E-mail inspection engines (SMTP, ESMTP, IMAP, POP)

URL Filtering

- Onboard with an optional content-engine network module
- Local URL filtering in Cisco IOS software based on external server

Onboard USB 1.1 port

- 2 onboard USB 1.1 ports
- Secure token and Flash memory support

Security Solutions

- Network Admission Control (NAC)
- Voice and Video Enabled IPsec VPN (V3PN)

Optional Security Modules

- Intrusion Prevention System Advanced Integration Modules (AIM-IPS-K9)
- VPN and Encryption Advanced Integration Modules (AIM-VPN/SSL-3)
- Network Admission Control Network Modules (NME-NAC-K9)

Cisco Router and Security Device Manager (SDM)

- Ships by default

Certifications

- ICSA IPsec
- ICSA Firewall
- Common Criteria IPsec (EAL4) (in process)
- Common Criteria Firewall (EAL4+) (in process)
- FIPS 140-2, Level 2

IP Telephony Features

IP Phone Support	Optional integrated power supply with inline power, 802.3af support, 360W of inline power
Analog Voice Support	Up to 88 FXS and 56 FXO ports
Digital Voice Support	Up to 720 calls
Packet Voice Digital Signal Processor (DSP) Module (PVDM) Slots on Motherboard	4 PVDM slots on motherboard, local conferencing and transcoding
Cisco CallManager Express	Up to 240 phones for the Cisco 3845 router, and up to 168 phones for the Cisco 3825 router
SRST	Up to 720 phones for the Cisco 3845 router, and up to 336 phones for the Cisco 3825 router
Voice Mail and Automated Attendant	Up to 250 mailboxes with up to 16 concurrent sessions using Cisco Unity™ Express Network Module
Voice Interfaces	FXS, FXO, Direct Inward Dial (DID), E&M, Centralized Automated Message Accounting (CAMA), Basic Rate Interface (BRI), T1, E1, Primary Rate Interface (PRI), Q.SIG, channel associated signaling (CAS)

Network Example

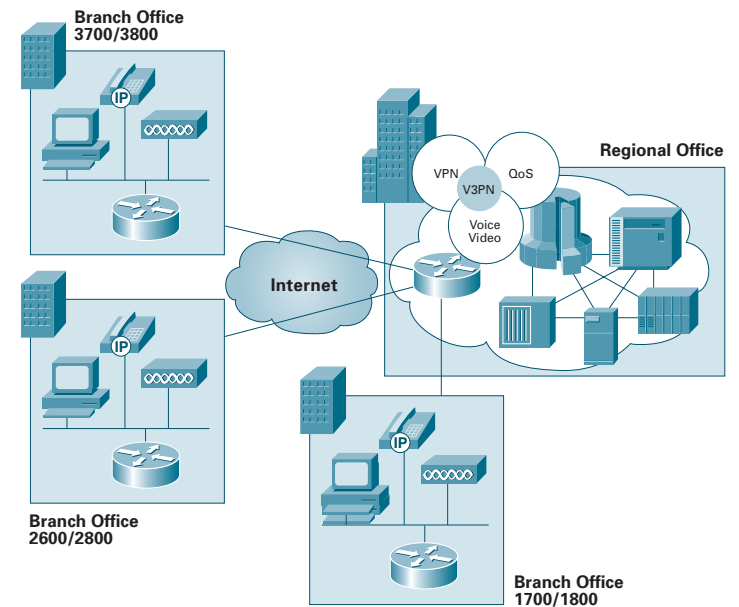

The figure above shows the Cisco 3800 Series routers converge voice, video, and data across a secure IPsec VPN network with high-quality, reliable performance. DMVPN creates tunnels on-the-fly based on user traffic. V3PN functionality provides QoS, multiprotocol, ease of provisioning, and secure connectivity.

When To Deploy

Deploy the Cisco 3800 Series when you need:

- The highest performance and densities for concurrent data, security, voice, and advanced services with headroom for growth
- Higher availability and resiliency with OIR, redundant system, and inline power options
- Higher WAN or voice densities with an additional (fourth) HWIC
- Low density (up to 96 ports), integrated 10/100 switching with PoE support; up to 48 ports with Cisco Inline Power
- Efficient, robust Error Correction Code (ECC) DDR SDRAM memory to detect and correct SDRAM errors without user intervention
- Integrated security services as part of Cisco Self Defending Network, which enable network device protection, threat defense, secure connectivity, and endpoint protection and control
- Integrated PVDMs, industry-leading call processing and autoattendant solutions, and high-density voice cards and modules that speed IP Communications and give customers a choice of telephony interface devices
- Advanced management for security, routing, QoS, and switching services with Cisco Router and Security Device Manager (SDM) 2.0
- Secure integrated call processing, voice mail and automated attendant, flexible telephony interfaces, redundancy for centralized call processing, with robust DSP support, including local call conforming and transcoding

Platform Overview

Cisco 3800 Series Features	Cisco 3825	Cisco 3845
Network Module Slots (These slots can accommodate standard network module, NME, and NME-X slots. The NME has the same form factor as the standard network module. The EVM-HD is supported. The NME-X, when available, will have a wider form factor than the NME. Two side-by-side NME slots can be combined to accommodate one NMD or, when available, a NME-XD.)	NM NME NME-X NMD NME-XD EVM-HD	NM NME NME-X NMD NME-XD EVM-HD
Maximum Number of Network Modules, NMEs, and NME-Xs Supported	2	4
Maximum Number of NMD/NME-XDs Supported	1	2
Maximum Number of EVM-HDs Supported	1	2
Number of HWIC Slots (These HWIC slots also support voice interface cards (VICs), voice/WAN interface cards (VWICs), and WICs)	4	4
Number of Fixed LAN Ports (fixed RJ-45 port for 10/100/1000 connectivity)	2 Gigabit Ethernet (10/100/1000)	2 Gigabit Ethernet (10/100/1000)
Number of Fixed SFP Ports (for SFP Gigabit Ethernet connectivity)	1	1
Number of AIM Slots (for optional AIMS for offloading compute-intensive features)	2	2
Number of PVDM Slots (for optional PVDM2s)	4	4
Number of USB 1.1 Ports (secure USB eToken and USB flash memory for secure Cisco IOS Software configuration distribution, and off-platform storage of VPN credentials)	4	2
Embedded VPN (hardware-based VPN encryption acceleration)	Yes	Yes
Number of Console Ports (up to 115.2 Kbps)	1	1
Number of Auxiliary Ports (up to 115.2 Kbps)	1	1
Memory (external compact Flash and internal DDR SDRAM with ECC)	Default: 64 MB Compact Flash; 256 MB DDR SDRAM Maximum: 256 MB Compact Flash; 1 GB DDR SDRAM	Default: 64 MB Compact Flash; 256 MB DDR SDRAM Maximum: 256 MB Compact Flash; 1 GB DDR SDRAM
Physical Specifications		
Dimensions (H x W x D)	3.5 x 17.1 x 14.7 in. 2 rack-unit (RU)	5.25 x 17.25 x 16 in. 3 RU
Weight (minimum)	23 lb	45 lb
Rack-mounting	Yes; 19- and 23-inch options	Yes; 19- and 23-inch options
Wall-mounting	No	No

Platform Overview continued

Cisco 3800 Series Features	Cisco 3825	Cisco 3845
AC: Input Voltage	100–240 VAC, autoranging	100–240 VAC, autoranging
AC: Input Frequency	47–63 Hz	47–63 Hz
AC: Input Current	3A (110V) 2A (230V) Startup current 50A maximum (one cycle)	4A (110V) 2A (230V) Startup current 50A maximum (one cycle)
DC: Input Voltage	24–60 VDC, auto-ranging positive or negative	24–60 VDC, autoranging positive or negative
DC: Input Current	12A (24V) 5A (60V) Startup current 50A<10 ms	18A (24V) 7A (60V) Startup current 50A<10 ms
Output	AC or DC power supply: 210W for system AC-IP power supply: 210W for system 360W for IP phones (-48V)	AC or DC power supply: 300W for system AC-IP power supply: 300W for system 360W for IP phones (-48V)
RPS	External only (Cisco RPS 675)	Internal AC, AC-IP, or DC RPS
Recommended RPS Unit	Cisco RPS 675	N/A
Power Dissipation		
AC without IP Phone Support	300W (1025 BTU/hr)	435W (1485 BTU/hr)
AC with IP Phone Support: System Only	370W (1262 BTU/hr)	555W (1890 BTU/hr)
AC with IP Phone Support: IP Phones	360W (1128 BTU/hr)	360W (1128 BTU/hr)
DC	325W (1100 BTU/hr)	460W (1570 BTU/hr)
Environmental Specifications		
Operating Temperature	32–104°F (0 to 40°C)	32–104°F (0 to 40°C)
Non-operating Temperature	-40–185°F (-40 to 85°C)	-40–185°F (-40 to 85°C)
Relative Humidity (non-condensing)	5–95%	5–95%
Operation Altitude	Up to 6500 ft. (2000 m), derate 1C per 1000 ft.	Up to 6500 ft. (2000 m), derate 1C per 1000 ft.
Noise Level (minimum)	50 dBA typical, 53 dBA maximum	56 dBA typical, 58 dBA maximum
Regulatory Compliance		
Safety	UL 60950 CAN/CSA C22.2 No. 60950 EN 60950 AS/NZS 60950	UL 60950 CAN/CSA C22.2 No. 60950 EN 60950 AS/NZS 60950

Platform Overview continued

Cisco 3800 Series Features	Cisco 3825	Cisco 3845
Regulatory Compliance <small>continued</small>		
EMC	47 CFR, Part 15 ICES-003 Class A EN55022 Class A CISPR22 Class A AS/NZS 3548 Class A VCCI V-3 EN 300386 EN 61000	47 CFR, Part 15 ICES-003 Class A EN55022 Class A CISPR22 Class A AS/NZS 3548 Class A VCCI V-3 EN 300386 EN 61000
TELCOM	47 CFR, Part 68 TIA/EIA/IS-968 CS-03 RTTE Directive	47 CFR, Part 68 TIA/EIA/IS-968 CS-03 RTTE Directive

Application Examples

Options

- Complete Cisco IP Communications and voice gateway capabilities
- Cisco Survivable Remote Site Telephony (SRST)
- Cisco Communications Express and Cisco Unity™ Express
- Integrated stateful firewall

Site-to-Site VPN using technologies such as EasyVPN, GET VPN, DMVPN

- Network admission control (NAC), and intrusion prevention
- Wide Area Application Services Acceleration
- Wireless WAN Backup; (3G CDMA and GSM)
- Network Analysis
- Circuit Emulation over IP (CEoIP)
- Integrated low-density switching with PoE support
- Video Surveillance, Management and Storage
- Application Performance Assurance
- Application eXtensions Platform (AXP)

High-Availability Features

Support for optional redundant system and inline power supply is offered on both the Cisco 3845 (internal) and the Cisco 3825 (external). OIR for network modules is offered on the Cisco 3845 only. Removable and field-replaceable components include the CPU motherboard, power supplies, and fan tray assembly (Cisco 3845 only).

Ordering Information

All Cisco 3800 Series Integrated Services Routers ship with Cisco IOS IP Base Software; 64 MB of Compact Flash and 256 MB of SDRAM; console, auxiliary and LAN cables; a power cord; 19-inch rack-mount brackets; and blank panels that cover unused WIC or network module slots. Optional items include:

- Cisco IOS Software feature set upgrade or revision
- Numerous voice/WAN interface card options
- Optional MFT Dedicated Echo Cancellation Modules for select voice/WAN interface cards

- Numerous WAN/LAN Network Modules
- Numerous service modules, including: Cisco Unity Express Voice Mail, Wide Area Application Services and Application eXtensions Platform (AXP)
- Up to 2 AIMs
- 16-, 24-, or 48-port EtherSwitch modules
- Integrated redundant system and inline power AC-IP power supplies (3845 only)
- Flash/SDRAM memory upgrade
- WAN interface cables

Ordering Information continued

Product Number	Product Description
CISCO3825	Cisco 3825 Integrated Services Router with 2 GbE, 1SFP, 2NME, 4HWIC, 2 AIM, IP Base software, and AC power
CISCO3825-AC-IP	Cisco 3825 Integrated Services Router with 2 GbE, 1SFP, 2NME, 4HWIC, 2 AIM, IP Base software, with AC Power and PoE
CISCO3825-DC	Cisco 3825 Integrated Services Router with 2 GbE, 1SFP, 2NME, 4HWIC, 2 AIM, IP Base software, and DC power
CISCO3845	Cisco 3845 Integrated Services Router with 2 GbE, 1SFP, 2NME, 4HWIC, 2 AIM, IP Base software, and AC power
CISCO3845-AC-IP	Cisco 3845 Integrated Services Router with 2 GbE, 1SFP, 2NME, 4HWIC, 2 AIM, IP Base software, and AC Power with PoE
CISCO3845-DC	Cisco 3845 Integrated Services Router with 2 GbE, 1SFP, 2NME, 4HWIC, 2 AIM, IP Base software, and DC power

Product Bundles

Product Number	Product Description
HSEC Bundles	
C3845-H-VSEC/K9	Cisco 3845 HVSEC Bundle with IOS Advanced IP Services, PVDM2-64, AIM-VPN/SSL-3, 100 User SRST License, 25 User SSL VPN License, 512 MB Flash/1GB DRAM
C3825-H-VSEC/K9	Cisco 3825 HVSEC Bundle with IOS Advanced IP Services, PVDM2-64, AIM-VPN/SSL-3, 100 User SRST License, 25 User SSL VPN License, 512 MB Flash/1GB DRAM
CISCO3845-HSEC/K9	Cisco 3845 Security Bundle with IOS Advanced IP Services Image, AIM-VPN/SSL-3, 128 MB Flash/512 MB DRAM, 25 User SSL License
CISCO3825-SEC/K9	Cisco 3825 Security Bundle with IOS Advanced Security Image, 64 MB Flash/256 MB DRAM
CISCO3825-HSEC/K9	Cisco 3825 Security Bundle with IOS Advanced IP Services Image, AIM-VPN/SSL-3, 128 MB Flash/512 MB DRAM, 25 User SSL License
Secure Voice Bundles	
CISCO3825-V3PN/K9	Cisco 3825 V3PN bundle w/AIMVPN, PVDM2-64, CCME-168, IOS Advanced IP Services, 64 MB Flash/256 MB DRAM
CISCO3845-V3PN/K9	Cisco 3845 V3PN bundle, AIM-VPN, PVDM2-64, CCME-240, IOS Advanced IP Services, 64 MB Flash/256 MB DRAM
C3825-VSEC/K9	Cisco 3825 Voice Security Bundle, PVDM2-64, IOS Advanced IP Services, 128 MB Flash/512 MB DRAM
C3825-VSEC-CCME/K9	Cisco 3825 VSEC Bundle w/PVDM2-64, FL-CCME-168, IOS Advanced IP Services, 128 MB Flash/512 MB DRAM
C3825-VSEC-SRST/K9	Cisco 3825 VSEC Bundle w/PVDM2-64, FL-SRST-168, IOS Advanced IP Services, 128 MB Flash/512 MB DRAM
C3845-VSEC/K9	Cisco 3845 Voice Security Bundle, PVDM2-64, IOS Advanced IP Services, 128 MB Flash/512 MB DRAM
C3845-VSEC-CCME/K9	Cisco 3845 VSEC Bundle w/PVDM2-64, FL-CCME-240, IOS Advanced IP Services, 128 MB Flash/512 MB DRAM
C3845-VSEC-SRST/K9	Cisco 3845 VSEC Bundle w/PVDM2-64, FL-SRST-240, IOS Advanced IP Services, 128 MB Flash/512 MB DRAM

Product Bundles continued

Product Number	Product Description
Security Bundles	
CISCO3825-SEC/K9	Cisco 3825 security bundle, advanced security, 64 MB Compact Flash/ 256 MB DRAM
CISCO3845-SEC/K9	Cisco 3845 security bundle, advanced security, 64 MB Compact Flash/ 256 MB DRAM
CISCO3825-HSEC/K9	Cisco 3825 security bundle, AIM-VPN/SSL-3, advanced IP services, 128 MB Flash/512 MB DRAM
CISCO3845-HSEC/K9	Cisco 3845 security bundle, AIM-VPN/SSL-3, advanced IP services, 128 MB Flash/512 MB DRAM
Voice Bundles	
CISCO3825-V/K9	Cisco 3825 voice bundle, PVDM2-64, SP services, 64 MB Compact Flash/ 256 MB DRAM
CISCO3845-V/K9	Cisco 3845 voice bundle, PVDM2-64, SP services, 64 MB Compact Flash/ 256 MB DRAM
CISCO3825-SRST/K9	Cisco 3825 voice bundle, PVDM2-64, FL-SRST-168, SP services, 128 MB Flash/512 MB DRAM
CISCO3845-SRST/K9	Cisco 3845 voice bundle, PVDM2-64, FL-SRST-240, SP services, 128 MB Flash/512 MB DRAM
CISCO3825-CCME/K9	Cisco 3825 voice bundle, PVDM2-64, FL-CCME-168, SP services, 128 MB Flash/512 MB DRAM
CISCO3845-CCME/K9	Cisco 3845 voice bundle, PVDM2-64, FL-CCME-240, SP services, 128 MB Flash/512 MB DRAM
C3825-35UC/K9	Cisco 3825 Unified Communications bundle with IOS SP Services, PVDM2-64, NME-CUE, 35 user licences (CCME, CUE, and Phone User licences), 10 Unified CallConnector Personal Licences, 128 MB Flash/ 256 MB DRAM
C3845-35UC/K9	Cisco 3845 Unified Communications bundle with IOS SP Services, PVDM2-64, NME-CUE, 35 user licences (CCME, CUE, and Phone User licences), 10 Unified CallConnector Personal Licences, 128 MB Flash/512 MB DRAM
WAN Optimization Bundles	
CISCO3825-WAE/K9	3825, NME-WAE-502/K9, WAAS Trans, Adv Security, 128F/512D
CISCO3845-WAE/K9	3845, NME-WAE-502/K9, WAAS Trans, Adv Security, 128F/512D

Notes



Cisco 3900 Series Integrated Services Routers

Cisco® 3900 Series Integrated Services Routers build on 25 years of Cisco innovation and product leadership. The new platforms are architected to enable the next phase of branch-office evolution, providing rich media collaboration and virtualization to the branch while maximizing operational cost savings. The new Integrated Services Routers Generation 2 are future-enabled with support for new high capacity DSPs (Digital Signal Processors) for future enhanced video capabilities, high powered service modules with improved availability, multi-core CPUs, Gigabit Ethernet switching with enhanced POE, and new energy visibility and control capabilities while enhancing overall system performance. Additionally, a new Cisco IOS® Software Universal image and Services Ready Engine module enable you to decouple the deployment of hardware and software, providing a flexible technology foundation which can quickly adapt to evolving network requirements. Overall, the Cisco 3900 Series offer unparalleled total cost of ownership savings and network agility through the intelligent integration of market leading security, unified communications, wireless, and application services.

Benefits and Advantages

Services on Demand

The Cisco 3900 Series Integrated Services Routers extend this leadership in total cost of ownership by reducing initial capital outlays by decoupling the delivery of software from hardware on optional service modules. In addition, customers receive a Universal IOS image, capable of enabling all of Cisco's rich IOS features allowing you to quickly deploy new services without having to download a new IOS image.

Investment Protection

The Cisco 3900 Series extends its leadership in total cost of ownership by reducing deployment costs and increasing flexibility. The platform also offers investment protection with support for many of the existing ISR modules.

Energy Efficiency

The Cisco 3900 architecture has been designed with higher efficiency power supplies that provide energy-savings features that include intelligent power management, allowing customers to control power to a specific module based on time of day, with full Cisco EnergyWise feature support in the future.

Cisco® 3900 Series builds on the best-in-class offering of the existing Cisco 3800 Series Integrated Services Routers by offering two platforms —the Cisco 3925 and the Cisco 3945 Integrated Services Routers.

Both Cisco 3900 Series Integrated Services Routers offer embedded hardware encryption acceleration, voice- and video-capable digital signal processor (DSP) slots, optional firewall, intrusion prevention, call processing, voicemail, and application services. In addition, the platforms support the industries widest range of wired and wireless connectivity options such as T1/E1, T3/E3, xDSL, Copper and Fiber GE. Overall, the Cisco 3900 Series offers superior performance and flexibility for flexible network deployments from small business offices to large enterprise office, all while providing industry-leading investment protection.

Key Business Benefits

The Integrated Services Routers Generation 2 (ISR G2) provides superior services integration and agility. Designed for scalability, the modular architecture of these platforms enables you to evolve and adapt with your growing business needs. The table below lists the business benefits of the Cisco 3900 Series.

Benefit	Description
Services Integration	<ul style="list-style-type: none"> The Cisco 3900 Series routers offer increased levels of services integration with voice, video, security, mobility, and data services. The Cisco 3900 Series provides the highest performance and slot densities among the routers in the Cisco ISR G2 portfolio, enabling you to maximize services integration and reducing overall capital and operational costs.
Services On Demand	<ul style="list-style-type: none"> A single Cisco IOS® Software Universal image is installed on each ISR G2. The Universal image contains all of the Cisco IOS technology sets which can be activated with a software license. This allows your business to quickly deploy advanced features without downloading a new IOS image. Additionally, larger default memory is included to support the new capabilities. The Cisco Services Ready Engine (SRE) enables a new operational model which allows you to reduce capital expenditures (CapEx) and deploy a variety of application services as needed on a single integrated compute services module.
High Performance with Integrated Services	<ul style="list-style-type: none"> The Cisco 3900 Series enables deployment in high speed WAN environments with concurrent services enabled (150 Mbps with Cisco 3945 and 100 Mbps with Cisco 3925). A multigigabit fabric (MGF) enables high-bandwidth module-to-module communication without compromising router performance.
Network Agility	<ul style="list-style-type: none"> Designed to address customer business requirements, the Cisco 3900 Series with the modular architecture offers increased capacity and performance as your network needs grow. The Services Performance Engine (SPE) modular motherboard enables upgrades to processing capability in the future. Dual integrated power supplies provide power redundancy or can be configured to provide additional ePOE power to endpoints. Modular interfaces offer increased bandwidth, a diversity of connection options, and network resiliency.

Key Business Benefits continued

Benefit	Description
Energy Efficiency	<ul style="list-style-type: none"> The Cisco 3900 Series architecture provides energy-savings features that include the following: <ul style="list-style-type: none"> The Cisco 3900 Series offers intelligent power management and allows the customer to control power to the modules based on the time of day. Cisco EnergyWise technology will be supported in the future. Services integration and modularity on a single platform performing multiple functions, optimizing raw materials consumption and energy usage. Platform flexibility and ongoing development of both hardware and software capabilities lead to a longer product lifecycle, lowering all aspects of the total cost of ownership, including materials and energy use. High efficiency power supplies and scalable power consumption based on your network needs.
Investment Protection	<ul style="list-style-type: none"> The Cisco 3900 Series maximizes investment protection by supporting: <ul style="list-style-type: none"> Reuse of a broad array of existing modules supported on the original Integrated Services Routers provides a lower cost of ownership A rich set of Cisco IOS Software features carried forward from the original integrated services routers and delivered in a single universal image. The Cisco 3900 Series offers extensive growth possibilities as your network expands: <ul style="list-style-type: none"> Services Performance Engine (SPE) modular motherboard enables flexibility to upgrades in the future. Highest scale for module density provides flexibility to add services as your business needs expand. 1GB default memory provides head-room to minimize field upgrades.

Series Features Overview

The Cisco 3900 Series is architected to meet the application demands of today's branch offices with design flexibility for future applications. The modular architecture is designed to support increasing bandwidth requirements, time-division multiplexing (TDM) interconnections, and fully integrated power distribution to modules supporting 802.3af Power over Ethernet (PoE) and Cisco Enhanced PoE (ePoE). The table below lists the architectural features and benefits of the Cisco 3900 Series.

Architectural Features	Description
Modular Platform	<ul style="list-style-type: none"> The Cisco 3900 Series routers are highly modular platforms with several types of module slots to add connectivity and services for varied branch-office network requirements. The routers offer an industry-leading breadth of LAN and WAN connectivity options through modules to accommodate field upgrades to future technologies without requiring platform replacement. The Cisco Services Performance Engine (SPE) on the Cisco 3900 offers the ability to increase the performance of the router with a field-upgradable motherboard as your network needs grow.
Processors	<ul style="list-style-type: none"> The Cisco 3900 Series are powered by high-performance multi-core processors that can support the growing demands of high-speed WAN connections to the branch-office while also running multiple concurrent services.
Embedded IP Security with Security Sockets Layer (IPsec/SSL) VPN Hardware Acceleration	<ul style="list-style-type: none"> Embedded hardware encryption acceleration is enhanced to provide higher scalability, which, combined with an optional Cisco IOS Security license, enables WAN link security and VPN services (both IPsec and SSL acceleration). The onboard encryption hardware out-performs the advanced integration modules (AIMs) of previous generations.
Multigigabit Fabric (MGF)	<ul style="list-style-type: none"> The Cisco 3900 Series introduces an innovative multigigabit fabric (MGF) that allows for efficient module-to-module communication, enabling tighter services interactions across modules while reducing the overhead on the router processor.
TDM Interconnectivity Fabric	<ul style="list-style-type: none"> Unified communications services in the branch office are significantly enhanced with the use of TDM interconnectivity fabric in the router architecture, allowing for scaling of DS-0 channel capacity.
Integrated Gigabit Ethernet Ports	<ul style="list-style-type: none"> The Cisco 3900 Series provides three 10/100/1000 Ethernet WAN ports. Two of the three 10/100/1000 Ethernet WAN ports on the Cisco 3900 Series can support Small Form-Factor Pluggable (SFP)-based connectivity in lieu of RJ-45 ports enabling fiber connectivity.
Innovative Universal-Serial-Bus (USB)-based Console Access	<ul style="list-style-type: none"> A new, innovative, mini-B USB console port supports management connectivity when traditional serial ports are not available. Traditional console and auxiliary ports are also available.
Optional Integrated Power Supply for Distribution of PoE and Universal DC Power Supply	<ul style="list-style-type: none"> An optional upgrade to the internal power supply provides inline power (802.3af-compliant PoE, Enhanced PoE, and Cisco Inline Power) to optional integrated switch modules. On the Cisco 3925 and 3945 routers, an optional DC power supply will be available in the future that extends possible deployment environments such as central offices and industrial environments.



Series Features Overview continued

Architectural Features	Description
Optional Integrated Redundant Power Supply (RPS) and PoE Boost	<ul style="list-style-type: none"> Both the Cisco 3925 and 3945 allow for power redundancy through the use of an optional integrated redundant power supply, thereby decreasing network downtime and protecting the network from power-supply failures. When populated with dual integrated power supplies, the Cisco 3925 and 3945 can operate in a configurable PoE boost mode in lieu of redundant power mode whereby the power capacity of the platform is increased to almost twice the normal power to support additional PoE ports.
Designed for Flexible Deployments	<ul style="list-style-type: none"> Both the Cisco 3925 and 3945 are designed for NEBS environments.



Modularity Features and Benefits

The Cisco 3900 Series provides significantly enhanced modular capabilities while maintaining investment protection for customers. Most of the modules available on previous generations of Cisco routers, such as the Cisco 3800 Series Integrated Services Routers, are supported on the Cisco 3900 Series. Additionally, modules used on the Cisco 3900 Series can easily be supported on other routers in the Cisco Integrated Services Router portfolio to provide maximum investment protection. Taking advantage of common interface cards across a network greatly reduces the complexity of managing inventory requirements, implementing large network rollouts, and maintaining configurations across a variety of branch-office sizes.

A complete list of supported modules, including a list of supported SFPs for the Cisco 3900 Series, is available at: <http://www.cisco.com/go/3900>

Architectural Features	Description
Cisco Services Performance Engine (SPE) 	<ul style="list-style-type: none"> Both the Cisco 3925 and Cisco 3945 offer a field-replaceable Services Performance Engine (SPE)-an option available on the Cisco 3900 Series only. The SPE is a modular motherboard that will be upgradable with higher-performance engines developed in the future. This engine protects your initial investment in the Cisco 3900 platform for a longer time period and scales router performance as your network and branch-office needs grow.
Cisco Service Module  	<ul style="list-style-type: none"> A service module slot replaces the network module and the extension module for voice/fax (EVM) slots and is offered on Cisco 3925, 3945 Integrated Services Routers. Each service-module slot offers high data-throughput capability: <ul style="list-style-type: none"> Up to 4 Gbps aggregate toward the router processor Up to 2 Gbps aggregate to other module slots over the MGF Service module (SM) slots are highly flexible with support for double-wide service modules (SM-D's), which are Service Modules that require two SM slots. SM-Ds in the Cisco 3925 and 3945 provide flexibility for higher-density modules. Service-module slots provide twice the power capabilities relative to the network-module slots, allowing flexibility for higher-scale and better-performance modules. An adapter module enables backward compatibility with existing network modules, enhanced network modules (NMEs), and EVMs. Power to service-module slots can be managed by extensions similar to the Cisco EnergyWise framework, so your organization can reduce energy consumption in your network infrastructure. Full Cisco EnergyWise support will be available in future software releases.

Modularity Features and Benefits continued

Architectural Features	Description
Cisco Enhanced High Speed WAN Interface Card (EHWIC) 	<ul style="list-style-type: none"> The EHWIC slot replaces the high-speed WAN interface card (HWIC) slot and can natively support HWIC, WAN interface cards (WICs), voice interface cards (VICs), and voice/WAN interface cards (VWIC). Four integrated EHWIC slots on the Cisco 3925 and 3945 allow for more flexible configurations. Each HWIC slot offers high-data-throughput capability: <ul style="list-style-type: none"> Up to 1.6 Gbps aggregate toward the router processor Up to 2 Gbps aggregate to other module slots over the MGF Flexibility to support doublewide modules is enabled by combining two EHWIC slots. Up to 2 doublewide HWIC (HWIC-D) modules are supported.
Cisco Internal Services Module (ISM) 	<ul style="list-style-type: none"> A single ISM slot provides flexibility to integrate intelligent services modules that do not require interface connections. Each ISM slot offers high-data-throughput capability: <ul style="list-style-type: none"> Up to 4 Gbps aggregate toward the router processor Up to 2 Gbps aggregate to other module slots over the MGF The ISM replaces the AIM slot; existing AIM modules are not supported in the ISM slot. Power to ISM slots can be managed by extensions similar to the Cisco EnergyWise framework, so your organization can reduce energy consumption in your network infrastructure. Full EnergyWise support will be available in future software releases.
Cisco High-Density Packet Voice Digital Signal Processor (DSP) Module (PVDM3) Slots on Motherboard 	<ul style="list-style-type: none"> PVDM3 slots natively support PVDM3 modules, providing support for richer density for rich-media voice and video. Each PVDM3 slot connects back to the system architecture through a 2-Gbps aggregate link through the MGF. Investment protection for PVDM2 modules is supported through an adapter module. Power to the PVDM slots can be managed by extensions similar to the Cisco EnergyWise framework, so your organization can reduce energy consumption in your network infrastructure. Full EnergyWise support will be available in future software releases.
Compact Flash Slots	<ul style="list-style-type: none"> Two external Compact Flash slots are available on the Cisco 3900 Series Integrated Services Routers. Each slot can support high-speed storage densities upgradable to 4 GB in density.
USB 2.0 Ports	<ul style="list-style-type: none"> Two high-speed USB 2.0 ports are supported. The USB ports support secure token capabilities and storage

Cisco IOS Software

Cisco 3900 Series Integrated Services Routers deliver innovative technologies running on industry-leading Cisco IOS Software. Developed for wide deployment in the world's most demanding enterprise, access, and service provider networks, Cisco IOS Software Release 15M and T provides support for a comprehensive portfolio of Cisco technologies, including the functionality and features delivered in releases 12.4 and 12.4T. New innovations in 15.0(1)M span multiple technology areas, including security, voice, high availability, IP Routing and Multicast, quality of service (QoS), IP Mobility, Multiprotocol Label Switching (MPLS), VPNs, and embedded management. Release 15.0(1)M is available immediately for the Cisco 3900 Integrated Services Router and will be an extended support release. For more information on Release 15(0)1M, visit <http://www.cisco.com/go/ios>

Cisco IOS Software Licensing and Packaging

A single Cisco IOS Universal image encompassing all functions is delivered with the platforms. You can enable advanced features by activating a software license on the Universal image. In previous generations of access routers, these feature sets required you to download a new software image. Technology packages and feature licenses, enabled through the Cisco software licensing infrastructure, simplify software delivery and decrease the operational costs of deploying new features.

Four major technology licenses are available on the Cisco 3900 Series Integrated Services Routers; you can activate the licenses through the Cisco software activation process identified at <http://www.cisco.com/go/sa>

- IP Base: This technology package is available as default.
- Data
- Unified Communications
- Security (SEC) or Security with No Payload Encryption (SEC-NPE)

For additional information and details about Cisco IOS Software licensing and packaging on Cisco 3900 Series Integrated Services Routers, please visit <http://www.cisco.com/go/3900>

For a more comprehensive list of features supported in Cisco IOS software refer to the Feature Navigator tool at: <http://www.cisco.com/go/fn>

Key Branch-Office Services

The Cisco Integrated Services Routers are industry leading routers that offer unprecedented levels of services integration. Designed to meet the requirements of the branch office, these platforms provide a complete solution with voice, video, security, mobility and application services. Businesses enjoy the benefit by deploying a single device that meets all their needs and save on capital and operational expenses.

Unified Communications, Collaboration, and Voice-Gateway Services

The Cisco 3900 Integrated Services Router is the foundation for collaboration in any sized branch office and is a critical component of Cisco's video architecture (Medianet) and enterprise Unified communications solution. With embedded voice services and a wide range of telephony interfaces supported, the Cisco 3900 Series delivers maximum deployment flexibility for the distributed enterprise. Unified communications is enabled through a rich signaling and media-processing infrastructure, including a variety of protocols, media interworking, signal and media security, transcoding, conferencing, and QoS. Cisco integrated services routers feature a wide range of voice-gateway interfaces, supporting a broad array of signaling and physical network interfaces. The performance improvements introduced with the Cisco 3900 Series help ensure that branch-office employees benefit from the same productivity advantages and wide breadth of services and applications as those enjoyed by the headquarters-based employees.

The Cisco 3900 Series enables a full range of existing and emerging video services, with scaling improvement to support Cisco TelePresence® conferencing, security, and session control. Cisco Unified Border Element extends these capabilities for business-to-business TelePresence communications.

The Cisco 3900 Series adds support for the new Cisco® High-Density Packet Voice Digital Signal Processor (DSP) Module (PVD3), which has been optimized for concurrent voice and video support. The PVD3 modules support all voice-gateway functions of earlier generations of PVDs, and add higher density and more processing power to support emerging rich-media applications. The Cisco 3900 Series is capable of supporting up to 4 onboard PVD3 slots, enable scale up to 768 G.729a channels.

Unified Communications Manager Express and Survivable Remote Site Telephony

The Cisco integrated services routers inherently provide optional unified communications services within the Cisco IOS Software, delivering the advantage of server hardware reduction and lower energy costs at the branch office. Cisco Unified Communications Manager Express (CME) provides the broad range of IP private-branch-exchange (PBX) and key-system features integrated into the router for branch office. Cisco Survivable Remote Site Telephony (SRST), also inherently available in Cisco IOS Software and an option on the Cisco 3900 Series, helps ensure that branch-office employees have uninterrupted telephony services and features, even if the connection to a centralized Cisco Unified Communications Manager is disrupted. Coupled with Cisco Unity® Express, the integrated solution for voicemail, Automated Attendant, and interactive voice response (IVR), the Cisco 3900 Series offers the branch office a complete range of unified communications services while delivering industry-leading security within a single platform.

Cisco Unified Border Element

The Cisco Unified Border Element capabilities supported on the Cisco 3900 address the emerging requirements in an IP-centric interconnect for branch-office unified communications between enterprises and service provider networks. Cisco Unified Border Element provides intelligent border-element functions such as physical and logical ingress and egress demarcation points, signaling and media control, and consolidated security and management features. The Cisco 3900 Series supports higher scale than previously provided on the Cisco 3800 Series, nearly twice the number of sessions.

VoiceXML Application Services

The Cisco 3900 Series inherently provides standards-certified VoiceXML browser services. VoiceXML is an open-standard markup language used to create voice-enabled web browsers and IVR applications. Just as HTML enables you to retrieve data with a PC, VoiceXML enables you to retrieve data using voice or dual-tone-multifrequency (DTMF) telephony input. The Cisco 3900 Series can deliver a much higher range of concurrent voice-gateway services combined with VoiceXML browsers services, for more than 300 sessions on the Cisco 3945.

Integrated Network Security for Data, Voice, Video, and Mobility

Security is essential to protect a business' intellectual property while also ensuring business continuity, and providing the ability to extend the corporate workplace to employees who need anytime, anywhere access to company resources. As part of the Cisco Self-Defending Network (SDN)-an architectural framework that allows organizations to identify, prevent, and adapt to network security threats, the Cisco 3900 Series Integrated Services Routers facilitates secure data transactions and secure collaboration.

The Cisco IOS Software Security technology package for the Cisco 3900 Series offers a wide array of common security features such as advanced application inspection and control, threat protection, and encryption architectures for enabling more scalable and manageable VPN networks. The Cisco 3900 Series offers onboard hardware-based encryption acceleration to provide greater IPsec throughput with less overhead for the route processor when compared with software-based encryption solutions. Cisco Integrated Services Routers offer a comprehensive and adaptable security solution for branch offices that includes features such as:

- Secure connectivity: Secure collaborative communications with Group Encrypted Transport VPN, Dynamic Multipoint VPN (DMVPN), or Enhanced Easy VPN
- Integrated threat control: Responding to sophisticated network attacks and threats using Cisco IOS Firewall, Cisco IOS Zone-Based Firewall, Cisco IOS IPS, Cisco IOS Content Filtering, and Flexible Packet Matching (FPM)
- Identity management: Intelligently protecting endpoints using technologies such as authentication, authorization, and accounting (AAA) and public key infrastructure (PKI)

Detailed information about the security features and solutions supported on the Cisco 3900 Series is available at <http://www.cisco.com/go/routersecurity>

Wireless and Mobility Services

Wireless LAN

The Cisco Integrated Services Routers supporting the Cisco Unified Wireless Architecture enable deployment of secure, manageable wireless LANs (WLANs) optimized for remote sites and branch offices, including fast secure mobility, survivable authentication, and simplified management. The Cisco Wireless LAN Controller Module on the Cisco 3900 Series routers allows small and medium-sized businesses and enterprise branch offices to cost-effectively deploy and manage secure WLANs. Cisco Wireless LAN Controllers work in conjunction with Cisco lightweight access points and the Cisco Wireless Control System (WCS) to provide system wide WLAN functions, managing up to 6, 12, and 25 access points. As components of the Cisco Unified Wireless Architecture, Cisco Wireless LAN Controllers present network administrators with the visibility and control necessary to effectively and securely manage business-class WLANs and mobility services, such as enhanced security, voice, guest access, and location services.

Wireless and Mobility Services continued

Wireless WAN

Cisco third-generation (3G) wireless WAN (WWAN) modules combine traditional enterprise router functions, such as remote management, advanced IP services such as voice over IP (VoIP), and security, with mobility capabilities of 3G WAN access. Using high-speed 3G wireless networks, routers can replace or complement existing landline infrastructure, such as dialup, Frame Relay, and ISDN. Cisco 3G solutions support 3G standards High-Speed Packet Access (HSPA) and Evolution Data Only/Evolution Data Optimized (EVDO) providing you with a true multipath WAN backup and the ability to rapidly deploy primary WAN connectivity. For more information about 3G solutions on Cisco Integrated Services Routers, please visit <http://www.cisco.com/go/3g>

Integrated LAN Switching

The Cisco 3900 Integrated Services Routers (Cisco 3925 and Cisco 3945) support the new enhanced Cisco EtherSwitch® Service Modules, which greatly expand router capabilities by integrating industry-leading Layer 2 or Layer 3 switching with feature sets identical to those found in the Cisco Catalyst® 3750-E and Catalyst 2960 Series Switches performing local line-rate switching and routing.

The new Cisco EtherSwitch Service Modules take advantage of the increased power capabilities on the Cisco 3900 Series platforms. Additionally, the Cisco Enhanced EtherSwitch modules enable Cisco energy and power initiatives, Cisco EnergyWise, Cisco Enhanced Power over Ethernet (ePoE) and per-port PoE power monitoring, and integrated RPS-enabled PoE boost. These technologies allow you to meet increased endpoint power requirements without increasing the total power consumption of the branch.

Application Services

Wireless WAN

As organizations continue to centralize and consolidate their branch-office IT infrastructure in an effort to reduce cost and complexity, they are challenged to provide adequate user experience, ensure continuous service availability, and deliver business-relevant applications when and where they are needed. To address these challenges, the Cisco 3900 Series provides the ability to host Cisco, third-party, and custom applications on a portfolio of high-performance Cisco Services Ready Engine modules that transparently integrate into the router. The modules have their own processors, hard disks, network interfaces, and memory that operate independently of the host router resources, helping to ensure maximum concurrent routing and application performance while reducing physical space requirements, lowering power consumption, and consolidating management.

Application Acceleration

The Cisco 3900 Series seamlessly combines industry leading security, IOS based traffic control and visibility, with Cisco WAAS solution. By combining Cisco IOS with a Cisco WAAS Network Module, a customer can maximize the quality and security of the user experience for applications and latency sensitive traffic such as Video. IOS features such as NBAR, IP SLA, and NetFlow provide visibility and monitoring of traffic patterns and application performance while IOS features such as QoS, ACLs, and PfR intelligently control the traffic to maximize the quality of the user experience and employee productivity. The user experience can be further enhanced through the addition of a Cisco WAAS Network Module which can be used to securely provide more advanced WAN optimization techniques such as TCP optimization, caching, compression, and application acceleration. Integrating Cisco Integrated Services Routers with Cisco WAAS network modules, provide optimal performance for applications delivered from a central data center to branch-office users. It also consolidates costly branch-office server, storage, and backup infrastructure into data centers while maintaining LAN-like service levels for remote users, and it minimizes WAN bandwidth expenses.

Cisco Services Ready Engine

The Cisco Services Ready Engine solution is available in a Service Module (SM) and Internal Service Module (ISM) form factor. The Service Module hardware offers up to a seven times performance improvement over the previous generation Network Modules and provides a multi-core x86 processor. The SRE modules also support up to 1 terabyte of storage, RAID configurations, hardware-assisted virtualization and cryptography options. The Cisco SRE module enables on-demand provisioning of branch-office applications on the Cisco 3900 Series platforms so that you can deploy the right application, at the right time, in the right place. The hardware and software decoupling provided by the service-ready deployment model enables applications to be provisioned on the module at the time of its installation or remotely anytime thereafter. Supported solutions include Cisco Wide Area Application Services (WAAS), Cisco Unity Express, Cisco Application Extension Platform (AXP), Cisco Wireless LAN Controller (WLC), Cisco Video Surveillance, and other applications under development. The Service Ready Engine enables organizations of various sizes to future-proof their network by allowing them to quickly deploy new branch-office applications without deploying new hardware, reducing the cost of rolling out branch-office services.

Managing Your Integrated Services Routers

Network management applications are instrumental in lowering operating expenses (OpEx) while improving network availability by simplifying and automating many of the day-to-day tasks associated with managing an end-to-end network. Day-one device support provides immediate manageability support for the Integrated Services Router, enabling quick and easy deployment, monitoring, and troubleshooting from Cisco and third-party applications.

Organizations rely on Cisco, third-party, and in-house developed network management applications to achieve their OpEx and productivity goals. Underpinning those applications are the embedded management features available in every Integrated Services Router. The new Integrated Services Routers continue a tradition of broad and deep manageability features such as IP service-level agreement (IP SLA), Cisco IOS Embedded Event Manager (EEM), and NetFlow which allow you to know the status of your network at all times. These features, along with Simple Network Management Protocol (SNMP) and syslog, enable your organization's management applications.

Please refer to the data sheet for additional details about the 3900

http://www.cisco.com/en/US/prod/collateral/routers/ps10536/data_sheet_c78_553924.html

When to Deploy

The Cisco 3945 Integrated Services Router (ISR) delivers highly secure data, voice, video, and application services to the small office. Key features include:

- Modular Services Performance Engine (SPE) 150, which can be upgraded for even higher performance as next-generation WAN environments evolve
- 3 integrated 10/100/1000 Ethernet ports with 2 ports capable of RJ-45 or SFP connectivity
- 4 service module slots
- 4 Enhanced High-Speed WAN Interface Card slots
- 4 onboard digital signal processor (DSP) slots
- 1 Internal Services Module slot
- Dual integrated power supplies
- Fully integrated power distribution to modules supporting 802.3af Power over Ethernet

Security

- Embedded hardware-accelerated VPN encryption for secure connectivity
- Integrated threat control using Cisco IOS Firewall, Cisco IOS Zone-Based Firewall, Cisco IOS IPS, and Cisco IOS Content Filtering
- Identity management using authentication, authorization, and accounting (AAA) and public key infrastructure

When to Deploy continued

Unified Communications

- High-density-packet voice DSP module, optimized for voice and video support
- Standards-certified VoiceXML browser services
- Cisco Unified Border Element capabilities for up to 1000 sessions
- Cisco Unity Express voicemail support
- Support for Cisco Communications Manager Express and Survivable Remote Site Telephony

The Cisco 3925 Integrated Services Router (ISR) delivers highly secure data, voice, video, and application services to small branch offices. Key features include:

- Modular Services Performance Engine (SPE) 100, which can be upgraded for even higher performance as next-generation WAN environments evolve
- 3 integrated 10/100/1000 Ethernet ports with 2 ports capable of RJ-45 or SFP connectivity
- 2 service module slots
- 4 Enhanced High-Speed WAN Interface Card (EHWIC) slots
- 4 onboard digital signal processor (DSP) slots
- 1 Internal Services Module slot
- Dual integrated power supplies
- Fully integrated power distribution to modules supporting 802.3af Power over Ethernet
- A universal IOS image that lets you deploy new IOS services quickly

Security

- Embedded hardware-accelerated VPN encryption for secure collaboration
- Integrated threat control using Cisco IOS Firewall, Cisco IOS Zone-Based Firewall, Cisco IOS IPS, and Cisco IOS Content Filtering
- Identity management using authentication, authorization, and accounting (AAA) and public key infrastructure

Unified Communications

- High-density-packet voice DSP module, optimized for voice and video support
- Standards-certified VoiceXML browser services
- Cisco Unified Border Element capabilities for up to 800 sessions
- Cisco Unity Express voicemail support
- Support for Cisco Communications Manager Express and Survivable Remote Site Telephony

The Cisco 3900 Integrated Routers Series are recommended to be deployed when enabling Borderless Networks at the Branch for small to medium size branch offices with user WAN bandwidth requirements up to 150Mbps. See picture below for specific 2900 Series recommended WAN bandwidth deployment guidelines.

WAN access and Collaboration

Notes

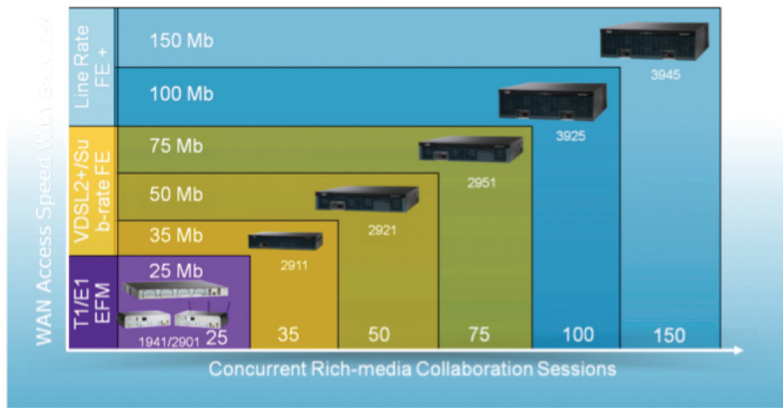

For 3900 Series technical specifications please see the data sheet at:

http://www.cisco.com/en/US/prod/collateral/routers/ps10536/data_sheet_c78_553924.html

· Ordering Information

· The Cisco 3900 Series Integrated Services Routers are orderable and shipping. For more information about how to order the Cisco 3900 Series, please visit the ISR G2 Ordering Guide. To place an order, visit the Cisco Ordering Home Page

For additional product numbers, including the Cisco 3900 Series bundle offerings, please check the Cisco price list or contact your local Cisco account representative. To place an order, visit the Cisco Ordering Home Page. To download software, visit the Cisco Software Center.

Product Name	Product Description
CISCO3925/K9	· Cisco 3925 with 3 onboard GE, C3900-SPE100/K9, 4 EHWIC slots, 4 DSP slots, 1 ISM slot, 2 SM slots, 256MB CF default, 1 GB DRAM default, IP Base
CISCO3945/K9	· Cisco 3945 with 3 onboard GE, C3900-SPE150/K9, 4 EHWIC slots, 4 DSP slots, 1 ISM slot, 4 SM slots, 256MB CF default, 1 GB DRAM default, IP Base



Cisco 7200 Series

Enterprises and service providers can meet new services aggregation requirements without expensive equipment upgrades or radical network redesigns by taking advantage of the industry's most popular WAN and MAN aggregation platform.

As companies deploy more services in branch offices using Cisco Integrated Services Routers, the role of the WAN aggregation router at the headend is being redefined. With more than 350,000 installed Cisco 7200 Series routers, Cisco is helping customers deploy new services and migrate to new WAN architectures using their existing networks.

The Cisco 7200 Series—which includes Cisco 7200 VXR Series routers and the 1-RU form factor Cisco 7201—plays a key role in the Cisco Self-Defending Network strategy by enabling:

- WAN and VPN aggregation: Scalable connectivity and IPsec encryption
- Data and identity protection: Perimeter defense, outbreak prevention, and identity-based access control
- Business continuity: Network availability and uninterrupted services

Both the Cisco 7200 VXR Series and the Cisco 7201 deliver exceptional versatility in a compact form factor, and are especially suitable for applications that require Gigabit Ethernet and OC-3/STM-1 connectivity with services being deployed. Offering processing speeds up to two million packets per second, three built-in Gigabit Ethernet ports on the routing engine (four on the Cisco 7201), interfaces ranging from NxDS0 to OC-3 POS and STM-1, and an unparalleled number of high-touch IP services, the Cisco 7200 VXR is an ideal high-end access router for large office environments.

A key strength of the Cisco 7200 VXR Series is its modularity and flexibility. It offers a selection of processors, an extensive range of LAN and WAN interfaces with up to 48 ports per chassis, and single or dual power supplies, enabling customers to customize their systems to achieve desired levels of performance, connectivity, and capacity. With the Port Adapter Jacket Card, Cisco 7200 VXR series 4- and 6-slot chassis can be turned into a 5- and 7-slot chassis for selected high-speed WAN port and security adapters. It is typically used for WAN and MAN services aggregation,

voice over IP, security, and various other IP applications due to its exceptionally broad feature offerings.

As a 1-RU form factor of a Cisco 7200 VXR Series, the Cisco 7201 provides packet forwarding speeds up to 2 Mpps. It also offers extensive port and service adapter support. In comparison to the Cisco 7200 VXR Series with NPE-G2 engine, the Cisco 7201 provides an additional fourth built-in Ethernet ports (10/100/1000) with support for one port adapter. The Cisco 7201 also supports AC and DC power supply with the option of dual DC power supply.

The Cisco 7201 is most attractive to customers looking for the functionality and performance of Cisco 7200 VXR Series routers, but less concerned with port density than a compact form factor and lower power consumption. Cisco 7301 continues to be available for applications where performance above 1 Mpps is not required.

Benefits and Advantages

Compact Form Factor

The Cisco 7200 VXR Series can support up to seven port/service adapters when utilizing the port adapter jacket card in its fully modular 3-RU form factor chassis. Up to 16 chassis can be supported in a 7' rack. The Cisco 7201 is the most powerful 1-RU router solution in the industry.

Exceptional Value

As the most powerful Cisco single-processor platform, the Cisco 7200 VXR Series offers customers a superior price/performance ratio supporting high-speed media and high-density configurations with up to 2 million packets per second processing at a competitive price point.

Simplified Network Convergence

The Cisco 7200 VXR Series' Multiservice Interchange (MIX)-enabled backplane allows for integration of data, voice, and video in a single WAN Edge device. With the latest Quality of Service (QoS) features, the Cisco 7200 VXR Series enables enterprises to save money by bypassing their carrier's long distance charges.

VPN Support

The dedicated VPN acceleration adapters supported in Cisco 7200 VXR and 7201 routers enable an integrated solution for routing and security including QoS, multicast, and multiprotocol traffic across the VPN. Utilizing the VPN Acceleration Module (SA-VAM2+) or VPN Services Adapter (C7200-VSA), the Cisco 7200 VXR series delivers up to 600 Mbps for the most demanding head-end, site-to-site VPN deployments. Cisco 7200 VXR and 7201 routers provide an integrated security solution which includes IPsec, FW, and IDS features sets.

Enhanced Security

Cisco 7200 VXR and Cisco 7201 routers help ensure the highest levels of network security. All Cisco 7200 Series routers support integrated SSL VPN, access control lists (ACLs), Network Address Translation (NAT), full NetFlow, firewall, intrusion prevention systems, IP Service Level Agreements (IP SLA), and a new category of IPsec Virtual Private Network (GET VPN) that eliminates the need for tunneling and enables higher levels of scalability.

Benefits and Advantages continued

Maximum ROI

A low price point makes the Cisco 7200 Series very attractive, while allowing customers to easily upgrade and redeploy their equipment as network needs change.

Connectivity/Flexibility

Providing high port density and an extensive range of LAN and WAN media, plus the three built-in GbE ports on the NPE-G1 and NPE-G2 engines, the Cisco 7200 Series dramatically reduces the cost per port and allows for flexible configurations to meet customers' specific network needs.

Feature-Rich

Full support for Cisco IOS Software and enhancements for high-performance network services enables the Cisco 7200 to offer industry-leading network services including MPLS, broadband aggregation, quality of service, security, and voice services.

Common Port Adapters

The Cisco 7200 VXR series shares the majority of the port adapters with Cisco 7201, Cisco 7301, Cisco 7304, Cisco 7500 Series, and Cisco 7600 Series routers, which simplifies inventory management and increases investment protection.

Security Features

IPsec VPN

- Advanced Encryption Standard (AES) 128, 192, and 256; Triple Data Encryption Standard (3DES); and DES cryptology support
- Cisco Easy VPN remote
- Cisco Easy VPN server
- Group Encrypted Transport VPN (GET VPN)
- Dynamic Multipoint VPN (DMVPN)
- Virtual Tunnel Interfaces (VTI)
- 802.1x
- VPN QoS—Preclassification support
- Support for up to 5000 IPsec tunnels

Multiprotocol Label Switching (MPLS) VPN Support

- Comprehensive provider edge capabilities
- Virtual routing and forwarding (VRF) firewall and VRF IPsec

Cisco IOS IPS

- Inline ability to drop packet, reset connection, locally shun, or send an alarm
- Dynamically load and enable selected attack signatures in the same manner as Cisco IPS Appliances

Network Foundation Protection

- Control Plane Policing (CPP)
- AutoSecure
- CPU/Memory Threshold
- Secure Shell (SSH)
- Access Control List (ACL)
- Command Line Interface (CLI)
- Committed Access Rate (CAR)

Cisco IOS Firewall

- Feature rich, stateful firewall
- Per-user authentication and authorization
- Real-time alerts
- Transparent firewall
- IPv6 firewall
- VRF-aware firewall
- Advanced Application Inspection and Control
 - HTTP inspection engine
 - E-mail inspection engines (SMTP, ESMTP, IMAP, POP)

IOS WebVPN (SSL VPN)

- Secure remote access for mobile users without installing PC client software
- Integrated into the router—no separate appliance required
- Cisco 7204VXR, Cisco 7206VXR, and Cisco 7201 routers support up to 150 users
- Requires IOS WebVPN feature license (licenses are per user) FL-WEBVPN-10, FL-WEBVPN-25 or FL-WEBVPN-100 (licenses are per user, purchase multiple quantities to add up to the desired number of users)
- Requires an IOS security feature set (IOS security feature set is included in all secure router bundles)

URL Filtering

- Local URL filtering in Cisco IOS software based on external server

Security Features continued

Security Solutions

- Network Admission Control (NAC)
- Voice and Video Enabled IPsec VPN (V3PN)
- Group Encrypted Transport VPN (GET VPN)
Tunnel-less VPN offering higher scalability
- Dynamic Multipoint VPN (DMVPN)

Optional Security Modules

- VPN and Encryption Service Adapters (SA-VAM2+C7200-VSA [on Cisco 7204 VXR and Cisco 7206VXR chassis only])

Cisco Router and Security Device Manager (SDM)

- Ships by default with Cisco 7200 VXR and Cisco 7201 security bundles

Certifications

- ICSA IPsec
- ICSA Firewall
- Common Criteria IPsec (EAL4)
- Common Criteria Firewall (EAL4+)
- FIPS 140-2, Level 2

Security Solutions Example

Easy VPN Server Application

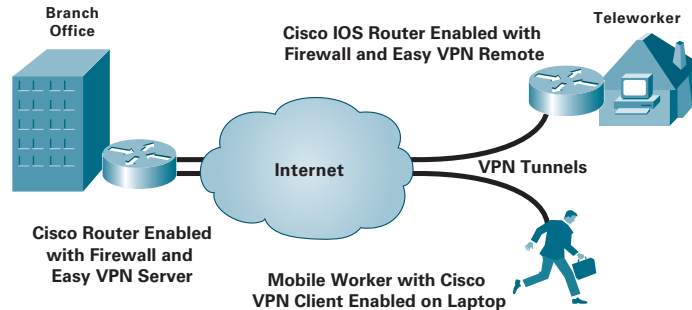

When To Deploy

Deploy the Cisco 7200 VXR Series when you need a high-performance access solution offering:

- Headquarters service aggregation with Integrated Services Routers at branch sites
- Flexibility in configurations
- A wide range of services
- A wide range of connectivity options
- High performance in a compact form factor

Deploy the Cisco 7201 router when you need high performance in a 1-RU form factor.

The Cisco 7201 router makes a very attractive security appliance given its 1-RU form factor with the four built-in Gigabit Ethernet ports and the integrated Network Processing Engine NPE-G2, offering up to 2 million packets per second routing performance.

Application Example

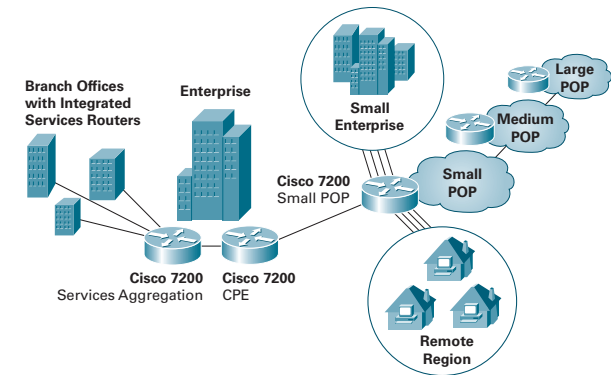

Series Specifications

These specifications apply to Cisco 7200 VXR routers with NPE-G1 and NPE-G2 as well as Cisco 7201 routers.

Flash Memory	NPE-G1: 64 MB (expandable to 256 MB) NPE-G2 and 7201: 256 MB
System DRAM Memory	NPE-G1: 256 MB (expandable to 1 GB) NPE-G2 and 7201: 1 GB (expandable to 2 GB)
Modular Slots	4- or 6-port/service adapter slots plus one additional slot when using the Port Adapter Jacket Card, 1 NPE slot, 1 I/O controller card slot
Supported Port Adapters	70+
Internal Power Supply	AC or DC, dual option
Dimensions (H x W x D)	
Cisco 7201	1.73 x 17.3 x 13.87 in.
Cisco 7204 VXR	5.25 x 16.8 x 17 in.
Cisco 7206 VXR	5.25 x 16.8 x 17 in.
Performance	Up to 2 Mpps with Cisco 7201 or NPE-G2 engine running inside the Cisco 7200 VXR chassis
Console Port	1
Auxiliary Port	1
Base Configuration: Cisco 7201	NPE-G2, 1 GB memory, 256 MB Flash, 4 fixed 10/100/1000 ports (can accommodate any one of the port adapters supported on the Cisco 7200 VXR Series), dual power supplies, IP software
Base Configuration: Cisco 7204 VXR	4-slot chassis, 1 AC power supply, IP software
Base Configuration: Cisco 7206 VXR	6-slot chassis, 1 AC power supply, IP software
Maximum Ethernet Ports	
Cisco 7201	12
Cisco 7204 VXR	32
Cisco 7206 VXR	48

Series Specifications continued

These specifications apply to Cisco 7200 VXR routers with NPE-G1 and NPE-G2 as well as Cisco 7201 routers.

Maximum High-speed Serial (up to 52 Mbps)	
Cisco 7201	1
Cisco 7204 VXR	8
Cisco 7206 VXR	12
Maximum Low-speed Serial (up to 2 Mbps)	
Cisco 7201	8
Cisco 7204 VXR	32
Cisco 7206 VXR	48
Integrated Modems	No
Maximum Number of ISDN PRI Ports	
Cisco 7204 VXR	32
Cisco 7206 VXR	48
Integrated CSU/DSU	Yes (dependent on port adapter configuration)
Compression	Supported in software (C7200-VSA is supported in Cisco 7204 VXR and Cisco 7206 VXR chassis only)
Encryption	Supported in hardware (with SA-VAM2+ or C7200-VSA)
Redundant Power Supply Support	Yes, for AC or DC. Cisco 7201 comes by default with either dual AC or dual DC power supplies
Minimum Cisco IOS Release	NPE-G2: Supported as of 12.4(4)XD, 12.4 (5th release) T, 12.2SB (4th release) and later Cisco IOS releases, 12.5 Mainline, and later Cisco IOS releases NPE-G1: Supported as of: 12.2(4)BW, 12.2(15)B, 12.2(14)S, 12.2(14)SU, 12.2(15)T, 12.1(14)E, 12.3(1), 12.3(2)T, 12.0(28)S, 12.3(1a)B, and later Cisco IOS releases. Cisco IOS 12.0(1)XE or later NPE-400: 12.1(3A)E, 12.1(5)T1, 12.0(14)S, and later Cisco IOS releases. NPE-225: Supported as of: 12.0(9)S, 12.1(1)E, 12.1(1)T, 12.1(1), 12.2(1), 12.2(2)T and later Cisco IOS releases, and Cisco 7201: 12.4(XD)7, 12.2(31)SB5, sixth release of 12.4T

Ordering Information

Cisco 7201 Bundles and Other Part Numbers

Product Number	Product Description
BASE System	
CISCO7201	Cisco 7201 Chassis, 1 GB Memory, Dual Power Supply, 256 MB Flash
Power Supplies	
PWR-7201-DC=	Cisco 7201 DC48 Power Supply Option Spare
PWR-7201-DC	Cisco 7201 DC48 Power Supply Option System
PWR-7201-AC=	Cisco 7201 AC Power Supply Option Spare
PWR-7201-AC	Cisco 7201 AC Power Supply Option System
Memory Options	
MEM-7201-FLD256=	Cisco 7201 Compact Flash Disk, 256 MB Spare
MEM-7201-FLD256	Cisco 7201 Compact Flash Disk, 256 MB System
MEM-7201-1GB=	Cisco 7201 Series 1 GB Memory Spare
MEM-7201-1GB	Cisco 7201 Series 1 GB Memory System
MEM-7201-2GB=	Cisco 7201 Series 2 GB Memory Spare
MEM-7201-2GB	Cisco 7201 Series 2 GB Memory System
Memory Options	
RCKMNT-7201=	Rack-mount Kit for Cisco 7201

Cisco 7204 VXR/Cisco 7206 VXR Bundles, Network Processing Engines and I/O Controller Cards

Product Number	Product Description
BASE System	
CISCO7201	Cisco 7201 Chassis, 1 GB Memory, Dual Power Supply, 256 MB Flash
7206VXR/NPE-G2	Cisco 7206 VXR with NPE-G2 Includes 3 GB E/FE/E Ports and IP Software
7206VXR/NPE-G1	Cisco 7206 VXR with NPE-G1 Includes 3 GB E/FE/E Ports and IP Software
Security	
7206VXRG2/2+VPNK9	Cisco 7206 VXR, NPE-G2, VAM2+C7200-JC-PA, AC Power, 1 GB System Memory, SDM
7206VXRG1/2+VPNK9	Cisco 7206 VXR, NPE-G1, VAM2+, AC Power, 512 MB System Memory, SDM
MPLS/IPV6	
7206-IPV6/ADSVC/K9	Cisco 7206 VXR IPv6/Advantage Entertainment Services Bundle with NPE-G2
Channel	
CISCO7206VXR-CH	Cisco 7206 VXR, 6-slot Chassis, 1 AC Power Supply with IP Software
CISCO7204VXR-CH	Cisco 7204 VXR, 4-slot Chassis, 1 AC Power Supply with IP Software

Ordering Information continuedCisco 7204 VXR/Cisco 7206 VXR Bundles, Network Processing Engines and I/O Controller Cards (continued)

Product Number	Product Description
BASE Chassis	
CISCO7206VXR	Cisco 7206 VXR, 6-slot Chassis, 1 AC Power Supply with IP Software
CISCO7204VXR	Cisco 7204 VXR, 4-slot Chassis, 1 AC Power Supply with IP Software
CISCO7206VXR-DC	Cisco 7206 VXR, 6-slot Chassis, 1 DC Power Supply with IP Software
CISCO7204VXR-DC	Cisco 7204 VXR, 4-slot Chassis, 1 DC Power Supply with IP Software
Processing Engines	
NPE-G2	Cisco 7200 Series NPE-G2 Engine with 3 GE/FE/E Ports
NPE-G1	Cisco 7200 Network Processing Engine with 3 GE/FE/E Ports
Input/Output Controller	
C7200-I/O-2FE/E	Cisco 7200 Input/Output Controller with Dual 10/100 Ethernet
C7200-I/O-GE+E	Cisco 7200 Input/Output Controller with GbE and Ethernet
Power Supplies	
PWR-7200-DC+=	Cisco 7200 DC (24V-60V) Power Supply Option
PWR-7200-AC=	Cisco 7200 AC Power Supply with United States Cord
PWR-7200-ACA=	Cisco 7200 AC Power Supply with Australian Cord
PWR-7200-ACE=	Cisco 7200 AC Power Supply with European Cord
PWR-7200-ACI=	Cisco 7200 AC Power Supply with Italian Cord
PWR-7200-ACU=	Cisco 7200 AC Power Supply with United Kingdom Cord
Memory Options	
MEM-NPE-G1-FLD64=	Cisco 7200 Compact Flash Disk for NPE-G1, 64 MB Option
MEM-NPE-G1-FLD128=	Cisco 7200 Compact Flash Disk for NPE-G1, 128 MB Option
MEM-NPE-G1-FLD256=	Cisco 7200 Compact Flash Disk for NPE-G1, 256 MB Option
MEM-NPE-G1-512MB=	2 256 MB Memory Modules (512 MB Total) for NPE-G1 in 7200
MEM-NPE-G1-1GB=	2 512 MB Memory Modules (1 GB Total) for NPE-G1 in 7200
MEM-NPE-G2-FLD256=	Cisco 7200 Compact Flash Disk for NPE-G2, 128 MB Option
MEM-NPE-G2-2GB=	7200 Series NPE-G2 2 GB Memory Spare

Notes

Cisco 7301 Series



The Cisco 7301 Series Router is a compact, high-performance single-rack-unit (1 RU) router coupled with a broad set of interfaces and Cisco IOS Software features, which makes it ideal for both service providers and enterprise applications.

Cisco 7301 Series is based on the Cisco 7200 NPE-G1 engine. The Cisco 7301 packs high performance in a space- and power-efficient chassis that includes a single Cisco 7000 Series port adapter slot, three onboard Gigabit Ethernet (copper or optical) or Fast Ethernet ports, and new high-speed bus technologies.

The key features of the Cisco 7301 Router are:

- Compact, power-efficient 1 RU form factor
- Single Cisco 7000 Series port adapter slot
- Complete Cisco IOS Software feature support
- Three onboard Gigabit Ethernet (copper or optical) or Fast Ethernet ports
- Pluggable Gigabit Ethernet optics (Small Form-Factor Pluggable [SFP] optics)
- Up to 1 GB of available DRAM, supporting up to 1 million routes
- Up to 256 MB of removable compact Flash memory
- Front-to-back airflow and single-sided management

Next-Generation Policy and Subscriber Solution

The Cisco 7301 supports Cisco Intelligent Services Gateway (ISG), the next-generation policy and subscriber management solution to deliver dynamic session awareness. Cisco ISG supports IP, Ethernet, ATM, Multiprotocol Label Switching (MPLS), and VPN architectures, whether the business model is for retail, wholesale, or business services. Cisco ISG allows for zero-touch provisioning, and provides the per-flow granularity and dynamic control required for triple-play services. Unlike some competitive offerings, Cisco ISG is standards-based for multi-vendor deployment. With RADIUS Change of Authorization (RFC 3576), subscriber profiles can be changed dynamically based on user self-management (through a Web portal) or through an OSS process. Network utilization improves because per-subscriber bandwidth needs are managed dynamically, increasing customer satisfaction.

Cisco ISG is a software feature set available in Cisco IOS Software Release 12.2SB and 12.2SRC for the 7200 Series, and 7301 Routers. Cisco ISG takes advantage of Cisco IOS routing capabilities to provide uplink redundancy, load-balancing, and MPLS integration. Cisco ISG is highly scalable, with consistent performance regardless of the features used. It can define and enforce local policy embedded directly in the network, or interact with centralized policy-management systems. Its integral role within the Cisco IP Next-Generation Network (NGN) Service Exchange Framework helps create consistent services in a highly flexible way.

Voice, Video, and Application Support

The Cisco 7301 Services Aggregation Routers offer integrated voice, video, and applications support, which include the TDM-enabled VXR chassis, voice port adapters, IP-to-IP gateway support, and comprehensive Cisco IOS Software features supporting optimum voice and video delivery to the extended enterprise.

The Cisco 7301 delivers exceptional versatility in a compact form factor, and are especially suitable for applications that require Gigabit Ethernet and OC-3/STM-1 connectivity with services being deployed. Offering processing speeds up to one million packets per second, three built-in Gigabit Ethernet ports on the routing engine, interfaces ranging from NxDS0 to OC-3 POS and STM-1, and an unparalleled number of high-touch IP.

Benefits and Advantages

Compact Form Factor and Low Power Consumption

With a processing performance of nearly 1 million-packets-per-second (Mpps), customers can maximize router performance where space is constrained. "Rack and stack" functionality allows customers to maximize the use of space in expensive Internet service provider (ISP) data centers. This is ideal for a dedicated security or QoS appliance at the edge of enterprise networks.

Exceptional Value

A powerful single-processor platform, the Cisco 7301 offers customers a superior price/performance ratio supporting high-speed media and high-density configurations with up to 1 million packets per second processing at a competitive price point.

VPN Support

The dedicated VPN acceleration adapters supported in the Cisco 7301 enable an integrated solution for routing and security including QoS, multicast, and multi-protocol traffic across the VPN. Utilizing the VPN Acceleration Module (SA-VAM2+), the Cisco 7301 delivers 3-Key Triple DES (168-bit) algorithms at speeds up to 260 Mbps for the most demanding headend, site-to-site VPN deployments. The Cisco 7301 provides an integrated security solution, which includes IPsec, FW, and IDS features sets.

Enhanced Security

With support for SSL VPN, access control lists (ACL), Network Address Translation (NAT), NetFlow, along with firewall, intrusion prevention, service level validation features, and a new category of Virtual Private Network (GET VPN) that eliminates the need for tunnels and increases scalability, the Cisco 7301 is an ideal platform for ensuring network security.

Benefits and Advantages continued

Maximum ROI

A low price point makes the Cisco 7301 very attractive, while allowing customers to easily upgrade and redeploy their equipment as network needs change.

Feature-Rich

The Cisco 7301 delivers a full suite of Cisco IOS Software services for managing network security, allocating Quality of Service (QoS) among applications and users, and providing value-added services such as NetFlow accounting and encryption. QoS applications such as Committed

Access Rate (CAR), Weighted Random Early Detection (WRED), and Weighted Fair Queuing (WFO) can be flexibly applied to provide precedence across IP addresses, applications, or specific users with a high level of granularity.

Common Port Adapters

The Cisco 7301 shares a majority of port adapters with the Cisco 7200 VXR, Cisco 7201, Cisco 7304, Cisco 7500, and Cisco 7600 series, which simplifies inventory management as well as provides investment protection through compatible interfaces amongst different router series.

Security Features

IPsec VPN

- Advanced Encryption Standard (AES) 128,192, and 256; Triple Data Encryption Standard (3DES); and DES cryptology support
- Cisco Easy VPN remote
- Cisco Easy VPN server
- Dynamic Multipoint VPN (DMVPN)
- Virtual Tunnel Interfaces (VTI)
- 802.1x
- VPN QoS—Preclassification support
- Support for up to 5000 IPsec tunnels

Multiprotocol Label Switching (MPLS) VPN Support

- Comprehensive provider edge capabilities
- Virtual routing and forwarding (VRF) firewall and VRF IPsec

Cisco IOS IPS

- Inline ability to drop packet, reset connection, locally shun, or send an alarm
- Dynamically load and enable selected attack signatures in the same manner as Cisco IPS Appliances

Network Foundation Protection

- Control Plane Policing (CPP)
- AutoSecure
- CPU/Memory Threshold
- Secure Shell (SSH)
- Access Control List (ACL)
- Command Line Interface (CLI)
- Committed Access Rate (CAR)

Cisco IOS Firewall

- Feature rich, stateful firewall
- Per-user authentication and authorization
- Real-time alerts
- Transparent firewall
- IPv6 firewall
- VRF-aware firewall
- Advanced Application Inspection and Control
 - HTTP inspection engine
 - E-mail inspection engines (SMTP, ESMTP, IMAP, POP)

IOS WebVPN (SSL VPN)

- Secure remote access for mobile users without installing PC client software
- Integrated into the router—no separate appliance required
- Supports up to 150 users
- Requires IOS WebVPN feature license (licenses are per user) FL-WEBVPN-10, FL-WEBVPN-25 or FL-WEBVPN-100 (licenses are per user, purchase multiple quantities to add up to the desired number of users)
- Requires an IOS security feature set (IOS security feature set is included in all secure router bundles)

URL Filtering

- Local URL filtering in Cisco IOS software based on external server

Security Features continued

Security Solutions

- Network Admission Control (NAC)
- Voice and Video Enabled IPsec VPN (V3PN)
- Group Encrypted Transport VPN (GET VPN) tunnel-less VPN offering higher scalability

Optional Security Modules

- VPN and Encryption Service Adapters (SA-VAM2+)

Cisco Router and Security Device Manager (SDM)

- Ships by default with Cisco 7301 security bundles

Certifications

- ICSA IPsec
- ICSA Firewall
- Common Criteria IPsec (EAL4)
- Common Criteria Firewall (EAL4+)
- FIPS 140-2, Level 2

Security Solutions Example

Easy VPN Server Application

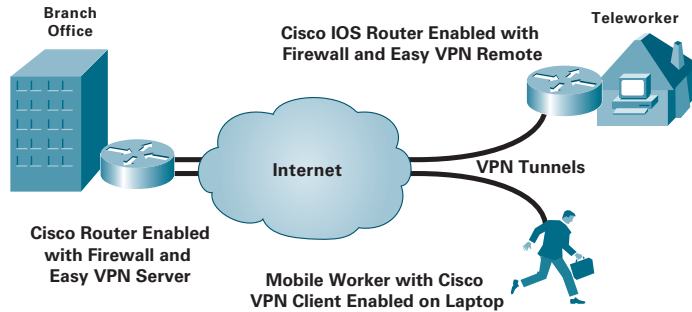

When To Deploy

With its combination of scalable performance, compact architecture, high density, and low price per port, the Cisco 7301 is ideally suited for a variety of key applications within both the service provider and enterprise markets.

Application Example

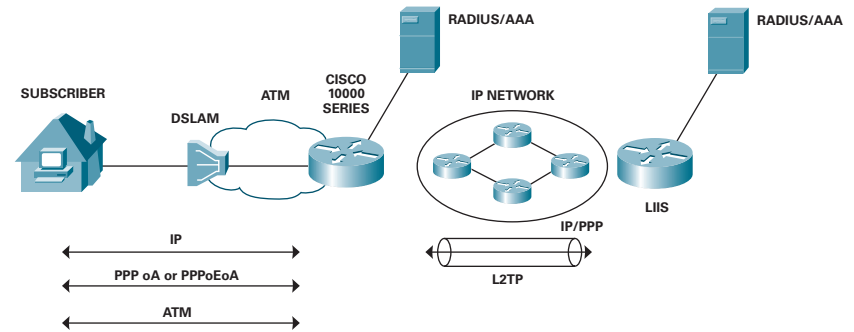
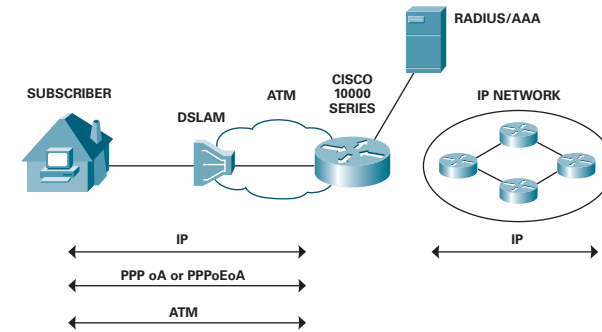

Key Application Service Providers

- **Broadband aggregation:** PTA/LAC or LNS/TS (Tunnel Switching) aggregation router capable of handling up to 8000 subscribers with per sessions features enabled and up to 16,000 simultaneous sessions with basic non-CPU intensive features and allowing for a pay-as-you-grow "rack and stack" architecture.
- **Managed services:** High-end customer premises equipment (CPE) or Multiprotocol Label Switching-customer edge (MPLS-CE) devices in managed L2 and L3 VPN solutions due to its high-performance, feature-rich support with both Gigabit Ethernet LAN connectivity and WAN port adapter connectivity.
- **Mesh Wireless and Public Wireless LAN Solutions:** With Intelligent Service Gateway the Cisco 7301 is ideal platform for these wireless solutions. ISG offers dynamic subscriber awareness, authentication, authorization, accounting, billing, and a customized portal.
- **High-availability design:** 100 percent redundancy via 2 CPEs configured for Hot Standby Router Protocol (HSRP) or Layer 3 load balancing.
- **Cost-effective BGP Route Reflector:** Ideally suited as a low cost route reflector with its ability to hold one million routes with its 1 GB of memory.

Key Applications for Enterprise Deployments

- **Large-branch-office router:** High-performance with features enabled branch-office router with support for up to OC-3/STM-1 or Gigabit Ethernet connectivity. It is ideal for Branch-office Internet gateway, Voice (IP-to-IP) Gateway and Site-to-Site Gateway.
 - **Enterprise High Speed Internet Gateway:** Dedicated high-performance Internet gateway with the option to connect to service provider by either using on board FE/GbE Ethernet ports or traditional WAN PA in one PA slot.
 - **Secure Internet gateway:** Support for features such as IP Security (IPsec) Protocol and stateful firewall at very high speeds make it an ideal Internet gateway (security) appliance.
 - **Key in different enterprise applications:** Master Controller in Optimized Edge Routing (OER) application, Key server or group member in Group Encrypted Transport (GET) VPN application, DMVPN hub, and Cisco IOS IP SLAs.
 - Ideally suited as a low cost route reflector with its ability to hold one million routes with its 1 GB of memory.
- By enabling the multifunction capabilities of the Cisco 7301 router, customers can simplify their network architectures, significantly reduce initial equipment costs, and increase revenue opportunities through value-added services.

Series Specifications

Flash Memory	64 MB (expandable to 256 MB)
System DRAM Memory	256 MB (expandable to 1 GB)
Modular Slots	1-port/service adapter slot
Supported Port Adapters	70+
Internal Power Supply	AC or DC, dual option
Dimensions (H x W x D)	1.73 in. x 17.3 in. x 13.87 in. (4.39 cm x 43.9 cm x 35.23 cm)
Performance	Up to 1 Mpps
Console Port	1
Auxiliary Port	1
Base Configuration: Cisco 7301	Includes the network processing engine NPE-G1, 3 fixed 10/100/1000 ports (can accommodate any one of the port adapters that are supported on the Cisco 7200 VXR series) with AC Power Supply, 256 MB of DRAM and 64 MB of Flash, and IP Software
Maximum Ethernet Ports Cisco 7301	5
Maximum High-speed Serial (up to 52 Mbps) Cisco 7301	1
Maximum Low-speed Serial (up to 1 Mbps) Cisco 7301	8
Voice/Data Support	Yes
Integrated Modems	No
Integrated CSU/DSU	Yes (dependent on port adapter configuration)
Compression	Supported in software
Encryption	Supported in hardware (with SA-VAM2+)
Redundant Power Supply Support	Yes, for AC or DC

Series Specifications continued

Minimum Cisco IOS Release	12.2(14)S, 12.2(14)SU, 12.2(15)T, 12.1(14)E, 12.3(1), 12.3(2)T, 12.0(28)S, 12.3(1a)B, 12.4T and later Cisco IOS releases
Weight	Chassis fully configured with a port adapter 10.5 lb approximately (4.76 kg)
Heat dissipation	50W (170 BTU typical, 75W (255 BTU) maximum)
Power dissipation	75W maximum configuration
Temperature	32 to 104°F (0 to 40°C), operating; -4 to 149°F (-20 to 65°C), non-operating
Humidity	10 to 90% humidity non-condensing

Ordering Information

Cisco 7301 Bundles and Other Part Numbers

Product Number	Product Description
Security	
CISCO7301/2+VPNK9	Cisco 7301, VAM2+, AC Power, 512 MB System Memory, SDM
Broadband	
CISCO7301-BB	Cisco 7301, 512 MB Memory, 16k License, 64 MB Flash, AC Power, IP/IOS
CISCO7301-BB-8K	Cisco 7301, 256 MB SDRAM, 8K Sub Broadband Feature License
CISCO7301BB-1G	Cisco 7301, 1 GB Memory, 64 MB FI, AC Power, IP IOS, up to 16k Sub BBA License
CISCO7301BB-8K-1G	Cisco 7301, 1 GB Memory, 64 MB FI, AC Power, IP IOS, up to 8k SubBBA License
Voice	
CISCO7301/ITP/BUN	ITP Signaling Gateway Bundle
BASE Chassis	
CISCO7301	Cisco 7301 Chassis, 256 MB Memory, AC Power, 64 MB Flash
CISCO7301-2AC=	Cisco 7301 Chassis with Dual AC Power Supply Spare
CISCO7301-2DC48=	Cisco 7301 Chassis with Dual DC 48 Power Supply Spare
Power Supplies	
PWR-7301-AC	Cisco 7301 Chassis, 256 MB Memory, AC Power, 64 MB Flash
PWR-7301/2-AC	Cisco 7301 Dual AC Power Supply Option
PWR-7301/2-DC48	Cisco 7301 Dual DC 48 Power Supply Option

Ordering Information continued

Product Number	Product Description
Memory Options	
MEM-7301-1GB=	1 GB Memory Upgrade for Cisco 7301
MEM-7301-512MB=	512 MB Memory Upgrade for Cisco 7301
MEM-7301-256=	256 MB Memory Upgrade for Cisco 7301
MEM-7301-FLD64	Compact Disk Flash for Cisco 7301, 64 MB Option
MEM-7301-FLD64=	Compact Disk Flash for Cisco 7301, 64 MB Option
MEM-7301-FLD128	Compact Disk Flash for Cisco 7301, 128 MB Option
MEM-7301-FLD128=	Compact Disk Flash for Cisco 7301, 128 MB Option
MEM-7301-FLD128=	Compact Disk Flash for Cisco 7301, 256 MB Option
MEM-7301-FLD128=	Compact Disk Flash for Cisco 7301, 256 MB Option
Cisco 7301 Accessories	
RCKMNT-7301=	Rack-mount Kits for 7301
7206VXRG2/2+VPNK9	Cisco 7206 VXR, NPE-G2, VAM2+C7200-JC-PA, AC Power, 1 GB System Memory, SDM
Cisco 7301 Feature Licenses	
FR-ISG73=	ISG-SSG Feature License for 7301
FL731-LI=	Lawful Intercept Upgrade for Cisco 7301 Series
FL-GK-IPIP7301	Cisco 7301 IP-to-IP Gateway
FL-GK-NEW-7301=	License for A 7301 Based GK For Voice

Notes



Cisco 7304 Series

Cisco 7304 Series Routers are designed for the network edge where high-performance IP services and redundancy are required to maintain profitability, service differentiation, and business agility. Using a compact, modular form factor, the Cisco 7304 delivers high-touch IP services at multi-gigabit speeds necessary for applications in the enterprise and service provider high-end Customer Premise Equipment (CPE). This versatile platform delivers a breadth of Cisco IOS features in addition to an evolving set of hardware-accelerated IP services. Providing a range of IP connectivity up to Gigabit Ethernet/OC-48, engineered for high availability and multiprotocol support, the Cisco 7304 scales to meet critical application needs of today and in the future.

Benefits and Advantages

High-performance IP/MPLS Services

The Cisco 7304 Series Routers take advantage of innovative Cisco adaptive network processing capabilities to power a broad set of network applications and services. The performance of the Cisco 7304 Series Routers make them ideal for high performance, multi-gigabit applications. The Cisco 7304, with modular engine support, uses the Network Service Engine (NSE-150) to power IP/MPLS services at up to 3.5 Mpps while delivering multiple IP/MPLS features such as MPLS, NAT, QoS, and NetFlow accounting.

Highly Scalable and Available

Cisco 7304 Series Routers can support a broad set of interfaces from DS-0 to OC-48 speeds, including built-in Fast Ethernet and Gigabit Ethernet interfaces—meeting performance demands well into the future. The Cisco 7304 is designed with the necessary memory and processing power for the next generation of applications that require large route table support, optical interfaces, and high-performance services processing. The Cisco 7304 supports dual route processors and power supplies, making it an ideal solution for providing mission-critical network availability.

Exceptional Value

Meeting today's connectivity needs, the Cisco 7304 Series Routers deliver built-in Ethernet interfaces, while supporting a wide variety of Cisco 7000 Series port adapters. With both copper and optical Gigabit Ethernet capabilities, these routers offer exceptional value for customers linking to high-speed LAN or Ethernet WAN connections without additional cost or interfaces.

When to Deploy

Deploy the Cisco 7304 when you need:

- A compact and modular form factor that allows for incremental investments
- Scalable deployment with a range of connectivity options, including OC-12 POS and OC-48 POS
- High availability support, including redundant route processor and power supply
- Multiple OC-3 performance or greater — NSE-150 Network Services Engine offers up to 3.5 Mpps forwarding performance
- Built-in Gigabit Ethernet (GbE)— 4 GbE ports per NSE-150 enable cost-effective and high-performance GbE connectivity
- Hardware-accelerated services for feature performance of up to 3.5 Mpps
- Multiprotocol support

Application Example

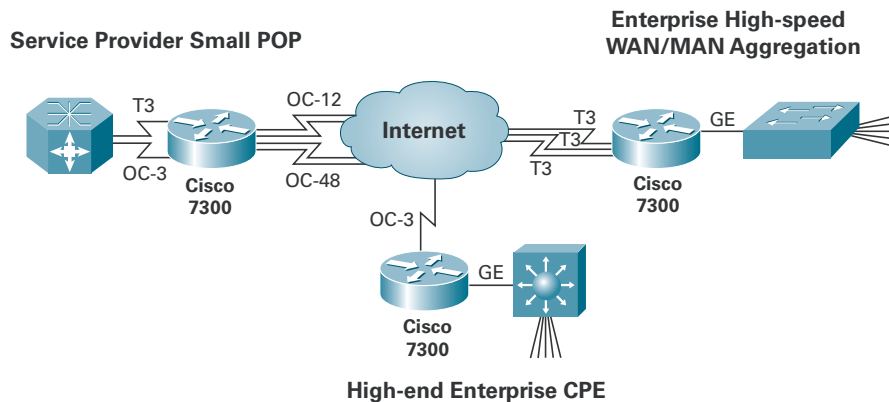

Series Specifications

Base Configuration	4-slot Chassis, NSE-100, NSE-150, or NPE-G100, 1 AC Power Supply, 512 MB
Processor	NPE-G100: SiByte BCM1250 at 800 MHz NSE-150: PXF and SiByte BCM1250 at 800 MHz
Redundant Processor	Optional, Uses 2 Interface Card Slots
WAN Interface Range	DS0 to OC-48/STM-16
Forwarding Rate	NPE-G100: Up to 1 Mpps NSE-150: Up to 3.5 Mpps
Backplane Capacity	16 Gbps
Compact Flash Memory	NSE-150: 256 MB NPE-G100: 256 MB
System DRAM Memory	NPE-G100: 1 GB NSE-150: 2 GB

Series Specifications continued

Modular Slots	4
Fixed Ports	NSE-150: 4 Gigabit Ethernet Ports NPE-G100: 3 Gigabit Ethernet Ports
Console Port	1
Auxiliary Port	1
Maximum Ethernet Ports	4 fixed GbE ports
Performance	Up to 3.5 Mpps
Voice/Data Support	No
Integrated Modems	No
Integrated CSU/DSU	Yes (T3)
Compression	SW
Encryption	No
Internal Power Supply	AC or DC (both redundant)
Redundant Power Supply Support	Yes
Chassis Height	4 RU
Rack Mountable	Yes, up to 11 per rack
Dimensions (H x W x D)	7 x 17.2 x 20.5 in.
Minimum Cisco IOS Release	Cisco IOS 12.2(31)SB

Ordering Information

Product Number	Product Description
CISCO7304=	Cisco 7300, 4-slot Chassis
CISCO7304-G100	4-slot Chassis, NPE-G100, 1 Power Supply
CISCO7304-G100-CH	Channel Bundle: Chassis, G100, PWR-AC, MEM-1GB, CFM-256, IOS, FAN
CISCO7304-NSE-150	4-slot Chassis, NSE-150, 1 Power Supply, 2 GB Memory
CISCO7304CH-NSE150	Channel Bundle: Chassis, NSE-150, PWR-AC, IOS IP PLUS, FAN

Ordering Information *continued*

Product Number	Product Description
Cisco 7304 Processors	
7304-NPE-G100	Cisco 7304 NPE-G100 with 1 GB SDRAM, 256 MB Flash, (3)GE/FE/E
7304-NPE-G100/2	Redundant 7304 NPE-G100 with 1 GB SDRAM, 256 MB Flash, (3)GE/FE/E
7300-NSE-150/2	Redundant Cisco 7304 NSE-150 with 2 GB SDRAM, 256 MB Flash, (4) GbE
7300-NSE-150	Cisco 7304 NSE-150 with 2 GB SDRAM, 256 MB Flash, (4) GbE
Cisco 7304 Power Supplies	
7300-PWR-DC=	Cisco 7304 DC Power Supply Spare
7300-PWR-AC=	Cisco 7304 AC Power Supply Spare
7300-PWR/2-DC	Cisco 7304 Redundant DC Power Supply Option
7300-PWR/2-AC	Cisco 7304 Redundant AC Power Supply Option
Cisco 7304 Memory Options	
7304-MEM-G100-1GB=	1 GB SDRAM for NPE-G100, Spare
Cisco 7304 Series Compact Flash Options	
7304-I/O-CFM-256M=	Cisco 7304 Compact Flash Memory, 256 MB
Cisco 7304 Line Cards	
7300-1OC48POS-SM=	1-port OC-48 POS Line Card for Cisco 7304 w/ Single-mode IR
7300-1OC12ATM=	1xOC-12 ATM Line Card
7300-2OC3ATM-MM=	2-port OC-3 ATM Line Card for Cisco 7304 with Multi-mode
7300-2OC3ATM-SM=	2-port OC-3 ATM Line Card for Cisco 7304 with Single-mode IR
SPA-4FE-7304=	4-port 10/100 Fast Ethernet Shared Port Adapter
SPA-2GE-7304=	2-port Half-Height Gigabit Ethernet Shared Port Adapter
Cisco 7304 Carrier Cards	
7300-CC-PA=	7304 Carrier Card for 7200 Series Port Adapters
7304-MS-100=	Cisco 7304 SPA Modular Services Carrier Card
Cisco 7304 Port Adapters	
PA-A3-8E1MA=	8-port ATM Inverse Mux E1 (120 ohm) Port Adapter, Spare
PA-A3-8T1MA=	8-port ATM Inverse Mux T1 Port Adapter, Spare
PA-A6-E3=	1-port Enhanced ATM E3 Port Adapter
PA-A6-OC3MM=	1-port Enhanced ATM OC-3c/STM-1 Multi-mode Port Adapter
PA-A6-OC3SM=	1-port Enhanced ATM OC-3c/STM-1 Single-mode (IR) Port Adapter
PA-A6-OC3SML=	1-port Enhanced ATM OC-3c/STM-1 Single-mode (LR) Port Adapter
PA-A6-T3=	1-port Enhanced ATM DS3 Port Adapter
PA-POS-1OC3=	1-port Packet/SONET OC-3c/STM-1 Port Adapter

Ordering Information *continued*

Product Number	Product Description
Cisco 7304 Port Adapters <i>continued</i>	
PA-POS-2OC3=	2-port Packet/SONET OC-3c/STM-1 Port Adapter
PA-POS-1OC3-2PAK=	Packet over SONET OC-3 2 PACK Bundle
PA-4E1G/75=	4-port E1 G.703 Serial Port Adapter (75 ohm/Unbalanced)
PA-4E1G/120=	4-port E1 G.703 Serial Port Adapter (120 ohm/Balanced)
PA-4T+=	4-port Serial Port Adapter, Enhanced
PA-8T-232=	8-port Serial, 232 Port Adapter
PA-8T-V35=	8-port Serial, V.35 Port Adapter
PA-8T-X21=	8-port Serial, X.21 Port Adapter
PA-E3=	1-port E3 Serial Port Adapter with E3 DSU
PA-2E3=	2-port E3 Serial Port Adapter with E3 DSUs
PA-T3+=	1-port T3 Serial Port Adapter Enhanced
PA-2T3+=	2-port T3 Serial Port Adapter Enhanced, Spare
PA-H=	1-port HSSI Port Adapter, Spare
PA-2H=	2-port HSSI Port Adapter, Spare
PA-MC-2E1/120=	2-port Multi-channel E1 Port Adapter with G.703 120 ohm interface
PA-MC-2T1=	2-port Multi-channel T1 Port Adapter with Integrated CSU/DSUs
PA-MC-4T1=	4-port Multi-channel T1 Port Adapter with Integrated CSU/DSUs
PA-MC-8TE1+=	8-port Multi-channel T1/E1 8PRI Port Adapter
PA-MC-E3=	1-port Multi-channel E3 Port Adapter
PA-MC-STM-1MM=	1-port Multi-channel STM-1 Multi-mode Port Adapter
PA-MC-STM-1SM=	1-port Multi-channel STM-1 Single-mode Port Adapter
PA-MC-T3=	1-port Multi-channel T3 Port Adapter
PA-MC-2T3+=	2-port Multi-channel T3 Port Adapter
PA-4E=	4-port Ethernet 10BASE T Port Adapter
PA-8E=	8-port Ethernet 10BASE T Port Adapter
PA-2FE-FX=	2-port Fast Ethernet 100BASEFX Port Adapter
PA-2FE-TX=	2-port Fast Ethernet 100BASE TX Port Adapter
PA-GE=	Gigabit Ethernet Port Adapter
Cisco 7304 Shared Port Adapters	
SPA-2XT3/E3=	2-port Clear Channel T3/E3 Shared Port Adapter
SPA-4XT3/E3=	4-port Clear Channel T3/E3 Shared Port Adapter
SPA-2XOC3-POS=	2-port OC-3/STM-1 POS Shared Port Adapters
SPA-4XOC3-POS=	4-port OC-3/STM-1 POS Shared Port Adapters
SPA-1XOC12-POS=	1-port OC-12/STM-4 POS Shared Port Adapters
SPA-BLANK=	Blank Cover for regular SPA

Ordering Information continued

Product Number	Product Description
Cisco 7304 Accessories	
7300-HALFSLOTBLNK=	Cisco 7304 Half-slot Blank Card, Spare
7300-4RU/RCKBRKT=	Cisco 7304 Chassis Rack-mount Bracket Spare
7300-CNTR-SPTUM=	Cisco 7304 Center Septum Spare
Cisco 7304 Software Options	
S73A-12231SB	Cisco 7300 Series IOS Enterprise
S73AR1K91-12231SB	Cisco 7300 Series IOS Enterprise/SNASW Secured Shell 3DES
S73C-12231SB	Cisco 7300 Series IOS IP Plus
S73Z-12231SB	Cisco 7300 Series IOS Service Provider
S73ZK91-12231SB	Cisco 7300 Series IOS Service Provider/Secured Shell 3DES
S73AR1K91-12228SB	Cisco 7300 Series IOS Enterprise/SNASW Secured Shell 3DES

Notes

Cisco ASR 1000 Series



Cisco ASR 1000 Series Routers transform and future-proof the network edge for service providers and enterprises by offering industry-leading performance, service capabilities, reliability, and efficiencies in a compact form factor. The Cisco ASR 1000 Series consists of four different versions: the Cisco ASR 1002-Fixed Router, the Cisco ASR 1002 Router, the Cisco ASR 1004 Router, and the Cisco ASR 1006 Router. All four models use the powerful Cisco QuantumFlow Processor which provides a leap in performance and resiliency for network processors.

The Cisco ASR 1000 Series delivers multiple services embedded in the Cisco QuantumFlow Processor at wire speeds of up to 20 Gbps. The services supported on the Cisco Packet QuantumFlow Processor include security services (for example, encryption and firewall), Quality of Service (QoS), Network Based Application Recognition (NBAR), Cisco IOS® Flexible Packet Matching, broadband aggregation, and Cisco Unified Border Element (CUBE) for Enterprise and Session Border Controller, among others.

With the separation of the control and data planes in the Cisco ASR 1000 Series Router architecture, software redundancy (on the Cisco ASR 1002-F, ASR 1002 and 1004 models) and hardware redundancy (on the Cisco ASR 1006 Router) are provided. Additionally, the modular Cisco IOS XE Software that is introduced with the Cisco ASR 1000 Series facilitates In Service Software Upgrade (ISSU).

The Cisco ASR 1000 Series is supported in Cisco IOS XE Software, which is introduced with the Cisco ASR 1000 Series Routers as a modular operating system. Cisco IOS XE Software is designed to provide modular packaging, feature velocity, and powerful resiliency. Because of the extreme flexibility and robust performance of the Cisco ASR 1000 Series Embedded Services Processors (ESPs), which are based on the Cisco QuantumFlow Processor technology, Network Security, Deep Packet Inspection, Cisco IOS Firewall, and many other advanced features are implemented in Cisco IOS XE Software without the need of additional hardware support (for example, in the form of a service blade).

One of the most innovative features is that the Cisco IOS XE Software supports dual Cisco IOS Software images in one single Cisco ASR 1000 Series Route Processor for software redundancy in the Cisco ASR 1002-F, the Cisco ASR 1002 and the Cisco ASR 1004 Router. This dual Cisco IOS Software image could be the same image for backup, or a different image also on a different Cisco IOS XE Software release for resilient upgrade. Information about the compatibility of

supported dual images is available in the release notes. The (optionally) hardware-redundant route processor and ESP configuration in the Cisco ASR 1006 Router does not support Cisco IOS Software redundancy in a single route processor since each of the two RPs support one Cisco IOS XE image.

Benefits and Advantages

Four Models

The Cisco ASR 1000 Series consists of four different versions: the Cisco ASR 1002-F, the Cisco ASR 1002 Router, the Cisco ASR 1004 Router, and the Cisco ASR 1006 Router.

Fills a Gap

From a price-to-performance perspective, the Cisco ASR 1000 Series Routers solution fits well between the Cisco 7200 and Cisco 7300 Series Routers and the higher-end Cisco 7600 Series Routers and Cisco Catalyst® 6000 Series Switches, thus dramatically enhancing the Cisco midrange routing portfolio.

Enhanced Value

The Cisco ASR 1000 Series provides a significant enhanced value compared to prior generations of Cisco midrange routing solutions by providing more than tenfold performance improvement with services running. Additionally, the routers have hardware and software redundancy, as well as an industry-leading high-availability design.

Multiple Services

The Cisco ASR 1000 Series delivers multiple services embedded in the Cisco QuantumFlow Processor at wire speeds of up to 20 Gbps.

The services supported on the Cisco QuantumFlow Processor include:

- Security services, such as encryption and firewall
- Quality of service (QoS)
- Network Based Application Recognition (NBAR)
- Cisco IOS® Flexible Packet Matching (FPM)
- Broadband aggregation
- Cisco Unified Border Element for Service Providers and for Enterprise (formerly referred to as Session border controller), among others.

Software and Hardware Redundancy

With the separation of the control and data planes in the Cisco ASR 1000 Series Routers architecture, software redundancy (on the Cisco ASR 1002-F, ASR 1002 and 1004 Routers) and hardware redundancy (on the Cisco ASR 1006 Router) are provided.

Nonstop Communications

Additionally, the modular Cisco IOS XE Software that is introduced with the Cisco ASR 1000 Series facilitates in-service software upgrade (ISSU).

When to Deploy

Deploy the Cisco ASR 1000 Series when you need:

- Superior application availability at the WAN edge: guarantee high-priority applications by creating a virtual “glass ceiling” for lower-priority applications.
- Multiservice, scalable, and secure headend: The Cisco ASR 1000 Series offers full-service IP Security (IPsec) VPN aggregation that scales to meet the new bandwidth demands of service provider IP VPNs.
- Embedded high-speed firewall: With the Zone-Policy Firewall, the Cisco ASR 1000 Series acts as an implicit complete barrier between any interfaces not members of the same zone.
- Managed CPE: This implementation of branch architecture offers powerful investment protection with services and scale.

When to Deploy continued

- Next-generation voice and multimedia example: Cisco Session Border Controller (SBC): The SBC implementation performs the voice and video gateway functions simultaneously with regular IP data services. No appliance or additional service blade is required. The control protocols and media protocols work transparently within a complex voice architecture.
- Broadband L2TP access concentrator (LAC) or L2TP Network Server (LNS): Layer 2 Tunneling Protocol (L2TP) endpoint to tunnel Point-to-Point Protocol (PPPoX) or IP sessions with bandwidth demands in the STM-1 ATM, Fast Ethernet, Gigabit Ethernet, and 20 Gigabit Ethernet range.
- Service provider edge: Layer 3 VPN (L3VPN) provider edge: Example: Distributed provider edge, or provider edge in global VPN networks for bandwidth demands such as asymmetric DSL (ADSL), T1/E1, STM-1, STM-4, Fast Ethernet, Gigabit Ethernet, etc.
- Service provider edge: High-end route reflector: As a route reflector for bandwidth support of 10 Gbps.

Application Example

Boardless Networks Secure WAN with ASR 1000

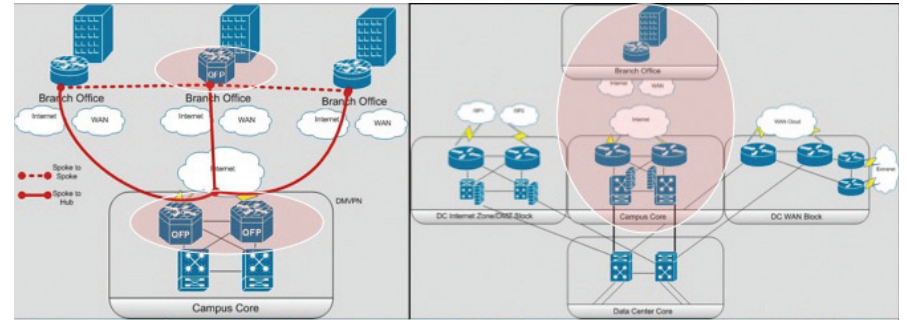

Product	Business	Technology	Operations
ASR1000 Solution Benefits	<ul style="list-style-type: none"> • Highly scalable built-in encryption engine for both IPsec and SSLVPN based solutions • Scalable IOS Firewall solution up to 20Gb 	<ul style="list-style-type: none"> • Based on multi-core encryption engine supporting both IKE and IPsec acceleration • Tighter QoS and HA integration • Support for DMVPN, EasyVPN, and GETVPN solutions 	<ul style="list-style-type: none"> • Ease of provisioning due to seamless crypto engine integration into data plane • Sub-50 ms failover times for crypto data plane
Cisco Quantum Flow Processor Solution Benefits	<ul style="list-style-type: none"> • Efficient QoS, and multicast interaction with crypto engine • IOS Zone-based Firewall integrated with crypto solutions 	<ul style="list-style-type: none"> • Instant Services turn-on using embedded crypto engine • IOS Firewall acceleration using native QFP off-load • Jumbo frame support 	<ul style="list-style-type: none"> • Crypto feature consistency across all Embedded Services Processors (ESP) • IOS Firewall CLI consistent with Cisco's Integrated Services Routers

Platform Overview

Feature	ASR1002-F	ASR1002	ASR1004	ASR1006
Fixed Ports	4 GEs	4 GEs	0	0
SPA Interface Processor (SIP) Slots	Integrated	Integrated	2	3
Shared Port Adapter (SPA) Slots	1	3	8	12
Interface Range	DS0 to OC-192; 10 Mbps to 10 Gbps	DS0 to OC-192; 10 Mbps to 10 Gbps	DS0 to OC-192; 10 Mbps to 10 Gbps	DS0 to OC-192; 10 Mbps to 10 Gbps
Forwarding Rate	Integrated; 2.5 Gbps with ESP2.5 Up to 2 Mpps	5 Gbps with ESP5; 10 Gbps with ESP10. Up to 8 Mpps with ESP5; up to 15 Mpps with ESP10	10 Gbps with ESP10; 20 Gbps with ESP20. Up to 15 Mpps with ESP10; up to 20 Mpps with ESP20	10 Gbps with ESP10; 20 Gbps with ESP20. Up to 15 Mpps with ESP10; up to 20 Mpps with ESP20
Embedded Services Processor (Data Plane)	Integrated (ESP2.5)	ESP5, ESP10, ESP10-N (non-crypto)	ESP10, ESP10-N (non-crypto), ESP20	ESP10, ESP10-N (non-crypto), ESP20
Route Processor (Control Plane)	Integrated (RP1)	Integrated (RP1)	RP1	RP1
System DRAM Memory	4 GB (default); 4 GB (max.)	4 GB (default); 4 GB (max.)	2 GB (default); 4 GB (max.)	2 GB (default); 4 GB (max.)
Minimum Cisco IOS Release	IOS XE 2.4	IOS XE 2.1	IOS XE 2.1	IOS XE 2.1
Internal Power Supply	AC or DC	AC or DC	AC or DC	AC or DC
Redundant Power Supply (RPS) support	Yes, Dual AC or DC by default (same power supplies as for ASR1002)	Yes, Dual AC or DC by default	Yes, Dual AC or DC by default	Yes, Dual AC or DC by default
Chassis Height	2 RU	2 RU	4 RU	6 RU
Rack Mountable	Yes	Yes	Yes	Yes
Dimensions (H x W x D)	3.5 x 172 x 22 in.	3.5 x 172 x 22 in.	70 x 172 x 22 in.	70 x 172 x 22 in.
Airflow	Front-to-back	Front-to-back	Front-to-back	Front-to-back

Ordering Information

Product Number	Product Description
Cisco ASR 1000 Series Base Bundles	
ASR1002-5G/K9	ASR 1002 w/ESP-5G, AESK9, 4GB DRAM
ASR1002-10G/K9	ASR 1002 w/ESP-10G, AESK9, 4GB DRAM
ASR1004-10G/K9	ASR 1004 w/ESP-10G, RP1, SIP10, AESK9
ASR1004-20G/K9	ASR 1004 w/ESP-20G, RP1, SIP10, AESK9
Cisco ASR 1000 Series Broadband Bundles	
ASR1006-10G-B16/K9	ASR 1006 BB Bundle w/2xESP-10G, 2xRP1, SIP10, AISK9, 16K BB License
ASR1006-10G-B24/K9	ASR 1006 BB Bundle w/2xESP-10G, 2xRP1, SIP10, AISK9, 24K BB License
ASR1K6R2-20-B32/K9	ASR 1006 BB Bundle w/2xESP-20G, 2xRP2, SIP10, AISK9, 32K BB License

Ordering Information continued

Product Number	Product Description
Cisco ASR 1000 Series VPN Bundles	
ASR1002F-VPN/K9	ASR 1002-F VPN Bundle w/AESK9, License, 4GB DRAM
ASR1002-5G-VPN/K9	ASR 1002 VPN Bundle w/ESP-5G, AESK9, License, 4GB DRAM
ASR1002-10G-VPN/K9	ASR 1002 VPN Bundle w/ESP-10G, AESK9, License, 4GB DRAM
ASR1004-10G-VPN/K9	ASR 1004 VPN Bundle w/ESP-10G, RP1, SIP10, AESK9, License
ASR1004-20G-VPN/K9	ASR 1004 VPN Bundle w/ESP-20G, RP1, SIP10, AESK9, License
ASR1006-20G-VPN/K9	ASR 1006 VPN Bundle w/ESP-20G, RP1, SIP10, AESK9, License
ASR1004-20G-VPN/K9	ASR 1004 VPN Bundle w/ESP-20G, RP1, SIP10, AESK9, License
ASR1006-20G-VPN/K9	ASR 1006 VPN Bundle w/ESP-20G, RP1, SIP10, AESK9, License
ASR1K4-20G-VPN/K9	ASR 1004 VPN Bundle w/ESP-20G, RP2, SIP10, AESK9, License
ASR1K6-20G-VPN/K9	ASR 1004 VPN Bundle w/ESP-20G, RP2, SIP10, AESK9, License
Cisco ASR 1000 Series Security Bundles	
ASR1002F-SEC/K9	ASR 1002-F VPN+FW Bundle w/AESK9, License, 4GB DRAM
ASR1002-5G-SEC/K9	ASR 1002 VPN+FW Bundle w/ESP-5G, AESK9, License, 4GB DRAM
ASR1002-10G-SEC/K9	ASR 1002 VPN+FW Bundle w/ESP-10G, AESK9, License, 4GB DRAM
ASR1004-10G-SEC/K9	ASR 1004 VPN+FW Bundle w/ESP-10G, RP1, SIP10, AESK9, License
ASR1006-10G-SEC/K9	ASR 1006 VPN+FW Bundle w/ESP-10G, RP1, SIP10, AESK9, License
ASR1004-20G-SEC/K9	ASR 1004 VPN+FW Bundle w/ESP-20G, RP1, SIP10, AESK9, License
ASR1006-20G-SEC/K9	ASR 1006 VPN+FW Bundle w/ESP-20G, RP1, SIP10, AESK9, License
ASR1K4R2-20G-SECK9	ASR 1004 VPN+FW Bundle w/ESP-20G, RP2, SIP10, AESK9, License
ASR1K6R2-20G-SECK9	ASR 1006 VPN+FW Bundle w/ESP-20G, RP2, SIP10, AESK9, License
Cisco ASR 1000 Series Security + HA Bundles	
ASR1002F-SHA/K9	ASR 1002-F Sec+HA Bundle w/AESK9, License, 4GB DRAM
ASR1002-5G-SHA/K9	ASR 1002 Sec+HA Bundle w/ESP-5G, AESK9, License, 4GB DRAM
ASR1002-10G-SHA/K9	ASR 1002 Sec+HA Bundle w/ESP-10G, AESK9, License, 4GB DRAM
ASR1004-10G-SHA/K9	ASR 1004 Sec+HA Bundle w/ESP-10G, RP1, SIP10, AESK9, License
ASR1006-10G-SHA/K9	ASR 1006 Sec+HA Bundle w/2xESP-10G, 2xRP1, SIP10, AESK9, License
ASR1004-20G-SHA/K9	ASR 1004 Sec+HA Bundle w/ESP-20G, RP1, SIP10, AESK9, License
ASR1006-20G-SHA/K9	ASR 1006 Sec+HA Bundle w/2xESP-20G, 2xRP1, SIP10, AESK9, License
ASR1K4R2-20G-SHAK9	ASR 1004 Sec+HA Bundle w/ESP-20G, RP2, SIP10, AESK9, License
ASR1K6R2-20G-SHAK9	ASR 1006 Sec+HA Bundle w/2xESP-20G, 2xRP2, SIP10, AESK9, License

Ordering Information continued

Product Number	Product Description
Cisco ASR 1000 Series Flexible Packet Inspection Bundles	
ASR1002-5G-FPI/K9	ASR 1002 FPI Bundle w/ESP-5G, AESK9, License, 4GB DRAM
ASR1002-10G-FPI/K9	ASR 1002 FPI Bundle w/ESP-10G, AESK9, License, 4GB DRAM
ASR1004-10G-FPI/K9	ASR 1004 FPI Bundle w/ESP-10G, RP1, SIP10, AESK9, License
ASR1006-10G-FPI/K9	ASR 1006 FPI Bundle w/ESP-10G, RP1, SIP10, AESK9, License
ASR1004-20G-FPI/K9	ASR 1004 FPI Bundle w/ESP-20G, RP1, SIP10, AESK9, License
ASR1006-20G-FPI/K9	ASR 1006 FPI Bundle w/ESP-20G, RP1, SIP10, AESK9, License
ASR1K4R2-20G-FPIK9	ASR 1004 FPI Bundle w/ESP-20G, RP2, SIP10, AESK9, License
ASR1K6R2-20G-FPIK9	ASR 1006 FPI Bundle w/ESP-20G, RP2, SIP10, AESK9, License
Cisco ASR 1000 Series High Availability Bundles	
ASR1002-5G-HA/K9	ASR 1002 HA Bundle w/ESP-5G, AESK9, License, 4GB DRAM
ASR1002-10G-HA/K9	ASR 1002 HA Bundle w/ESP-10G, AESK9, License, 4GB DRAM
ASR1004-10G-HA/K9	ASR 1004 HA Bundle w/ESP-10G, RP1, SIP10, AESK9, License
ASR1006-10G-HA/K9	ASR 1006 HA Bundle w/2xESP-10G, 2xRP1, SIP10, AESK9
ASR1004-20G-HA/K9	ASR 1004 HA Bundle w/ESP-20G, RP1, SIP10, AESK9, License
ASR1006-20G-HA/K9	ASR 1006 HA Bundle w/2xESP-20G, 2xRP1, SIP10, AESK9
Cisco ASR 1000 Series Chassis	
ASR1002-F	Cisco ASR 1002 System, Fixed ESP, Crypto, 4 built-in GE, 4GB DRAM
ASR1002-F=	Cisco ASR 1002 System, Fixed ESP, Crypto, 4 built-in GE, 4GB DRAM, Spare
ASR1002	Cisco ASR 1002 Chassis, 4 built-in GE, Dual Power Supply, 4GB DRAM
ASR1002=	Cisco ASR 1002 Chassis, 4 built-in GE, 4GB DRAM, Spare
ASR1004	Cisco ASR 1004 Chassis, Dual Power Supply
ASR1004=	Cisco ASR 1004 Chassis, Spare
ASR1006	Cisco ASR 1006 Chassis, Dual Power Supply
ASR1006=	Cisco ASR 1006 Chassis, Spare
Cisco ASR 1000 Embedded Services Processor	
ASR1000-ESP5	Cisco ASR 1000 Embedded Services Processor, 5Gbps, Crypto, ASR 1002 Only
ASR1000-ESP5=	Cisco ASR 1000 Embedded Services Processor, 5G, Crypto, 1002 only, Spare
ASR1000-ESP10	Cisco ASR 1000 Embedded Services Processor, 10G, Crypto
ASR1000-ESP10=	Cisco ASR 1000 Embedded Services Processor, 10G, Crypto, Spare
ASR1000-ESP10-N	Cisco ASR 1000 Embedded Services Processor, 10G, Non Crypto
ASR1000-ESP10-N=	Cisco ASR 1000 Embedded Services Processor, 10G, Non Crypto, Spare
ASR1000-ESP20	Cisco ASR 1000 Embedded Services Processor, 20G, Crypto
ASR1000-ESP20=	Cisco ASR 1000 Embedded Services Processor, 20G, Crypto, Spare

Ordering Information continued

Product Number	Product Description
Cisco ASR 1000 Route Processor	
ASR1000-RP1	Cisco ASR 1000 Route Processor 1, 2GB DRAM
ASR1000-RP1=	Cisco ASR 1000 Route Processor 1, 2GB DRAM, Spare
ASR1000-RP2	Cisco ASR 1000 Route Processor 2, 8GB DRAM
ASR1000-RP2=	Cisco ASR 1000 Route Processor 2, 8GB DRAM, Spare
Cisco ASR 1000 SPA Interface Processor	
ASR1000-SIP10	Cisco ASR 1000 SPA Interface Processor 10
ASR1000-SIP10=	Cisco ASR 1000 SPA Interface Processor 10, Spare
Cisco ASR 1000 USB Memory Options	
MEMUSB-1024FT	1GB USB Flash Token
MEMUSB-1024FT=	1GB USB Flash Token, Spare
Cisco ASR 1000 Shared Port Adapters	
For the list of SPAs supported on ASR 1000 Series, see "ASR 1000 SPA and Optics support" at http://www.cisco.com/en/US/prod/collateral/routers/ps9343/powerpoint_c97-496015.pdf or check the Cisco ASR 1000 Price List or contact your local Cisco account representative.	
Cisco ASR 1000 Optics	
For the list of SPAs supported on ASR 1000 Series, see "ASR 1000 SPA and Optics support" at http://www.cisco.com/en/US/prod/collateral/routers/ps9343/powerpoint_c97-496015.pdf or check the Cisco ASR 1000 Price List or contact your local Cisco account representative.	
Cisco ASR 1000 Software-RP1	
SASR1R1-AES	Cisco ASR 1000 Series RP1 Advanced Enterprise without Crypto
SASR1R1-AESK9	Cisco ASR 1000 Series RP1 Advanced Enterprise Services
SASR1R1-AIS	Cisco ASR 1000 Series RP1 Advanced IP Services without Crypto
SASR1R1-AISK9	Cisco ASR 1000 Series RP1 Advanced IP Services
SASR1R1-IPB	Cisco ASR 1000 Series RP1 IP Base without Crypto
SASR1R1-IPBK9	Cisco ASR 1000 Series RP1 IP Base
SASR1R1-WMAK9	Cisco ASR 1000 Series RP1 WebEx Node
Cisco ASR 1000 Software-RP2	
SASR1R2-AES	Cisco ASR 1000 Series RP2 Advanced Enterprise without Crypto
SASR1R2-AESK9	Cisco ASR 1000 Series RP2 Advanced Enterprise Services
SASR1R2-AIS	Cisco ASR 1000 Series RP2 Advanced IP Services without Crypto
SASR1R2-AISK9	Cisco ASR 1000 Series RP2 Advanced IP Services
SASR1R2-IPB	Cisco ASR 1000 Series RP2 IP Base without Crypto
SASR1R2-IPBK9	Cisco ASR 1000 Series RP2 IP Base
SASR1R2-WMAK9	Cisco ASR 1000 Series RP2 WebEx Node

Ordering Information continued

Product Number	Product Description
Cisco ASR 1000 Licenses	
FLASR1-IOSRED-RTU=	SW Redundancy Right-to-use Feat License for ASR 1000 Series, Spare
FLASR1-IOSRED-RTU	SW Redundancy Right-to-use Feat License for ASR 1000 Series
FLASR1-IPSEC-RTU=	Encryption Right-to-use Feature License for ASR 1000 Series, Spare
FLASR1-IPSEC-RTU	Encryption Right-to-use Feature License for ASR 1000 Series
FLASR1-FW-RTU=	Firewall Right-to-use Feature License for ASR 1000 Series, Spare
FLASR1-FW-RTU	Firewall Right-to-use Feature License for ASR 1000 Series
FLASR1-FPI-RTU=	Flex. Pack Insp. Right-to-use Feat License, ASR 1000 Series, Spare
FLASR1-FPI-RTU	Flex. Pack Insp. Right-to-use Feat License, ASR 1000 Series
FLASR1-BB-RTU=	Broadband Right-to-use Feature License for ASR 1000 Series, Spare
FLASR1-BB-RTU	Broadband Right-to-use Feature License for ASR 1000 Series
FLASR1-BB-4K=	Broadband 4K Sessions Feature License for ASR 1000 Series, Spare
FLASR1-BB-4K	Broadband 4K Sessions Feature License for ASR 1000 Series
FLASR1-BB-16K	Broadband 16K Sessions Feature License for ASR 1000 Series
FLASR1-BB-32K=	Broadband 32K Sessions Feature License for ASR 1000 Series, Spare
FLASR1-BB-32K	Broadband 32K Sessions Feature License for ASR 1000 Series
FLASR1-SBC-RTU=	DBE Base Right-to-use License for Release 2.3.x and Prior, Spare
FLASR1-SBC-RTU	DBE Base Right-to-use License for Release 2.3.x and Prior
FLASR1-SBC-H248=	DBE H248 Right-to-use License for Release 2.3.x and Prior, Spare
FLASR1-SBC-H248	DBE H248 Right-to-use License for Release 2.3.x and Prior
FLASR1-SBC-4K=	DBE 4K Sessions Feature License for ASR1000 Series, Spare
FLASR1-SBC-4K	DBE 4K Sessions License for Release 2.3.x and Prior
FLASR1-SBC-16K=	DBE 16K Sessions License for Release 2.3.x and Prior, Spare
FLASR1-SBC-16K	DBE 16K Sessions License for Release 2.3.x and Prior
FLASR1-CUBES-250P	CUBE(SP) 250 Session Perpetual License for ASR 1000 Series
FLASR1-CUBES-250P=	CUBE(SP) 250 Session Perpetual License for ASR 1000 Series
FLASR1-CUBES-2KP	CUBE(SP) 2K Session Perpetual License for ASR 1000 Series
FLASR1-CUBES-2KP=	CUBE(SP) 2K Session Perpetual License for ASR 1000 Series
FLASR1-CUBES-4KP	CUBE(SP) 4K Session Perpetual License for ASR 1000 Series
FLASR1-CUBES-4KP=	CUBE(SP) 4K Session Perpetual License for ASR 1000 Series

Ordering Information continued

Product Number	Product Description
Cisco ASR 1000 Licenses continued	
FLASR1-CUBES-16KP	CUBE(SP) 16K Session Perpetual License for ASR 1000 Series
FLASR1-CUBES-16KP=	CUBE(SP) 16K Session Perpetual License for ASR 1000 Series
FLASR1-CUBES-32KP	CUBE(SP) 32K Session Perpetual License for ASR 1000 Series
FLASR1-CUBES-32KP=	CUBE(SP) 32K Session Perpetual License for ASR 1000 Series
FLASR1-CUBES-LAB	CUBE(SP) Lab Use Only Perpetual License for ASR 1000 Series
FLASR1-CUBES-LAB=	CUBE(SP) Lab Use Only Perpetual License for ASR 1000 Series
FLASR1-CUBES-TPEX	CUBE(SP) Perpetual License for ASR 1000 Series in B2BTP Exchange
FLASR1-CUBES-TPEX=	CUBE(SP) Perpetual License for ASR 1000 Series in B2BTP Exchange
FLASR1-CUBEE-100P	Unified Border Element - Enterprise Edition 100 Sessions
FLASR1-CUBEE-500P	Unified Border Element - Enterprise Edition 500 Sessions
FLASR1-CUBEE-1KP	Unified Border Element - Enterprise Edition 1000 Sessions
FLASR1-CUBEE-4KP	Unified Border Element - Enterprise Edition 4000 Sessions
Cisco ASR 1000 Licenses continued	
FLASR1-LI-RTU	Cisco ASR 1000 Lawful Intercept RTU
FLASR1-LI-RTU=	Cisco ASR 1000 Lawful Intercept RTU
Cisco ASR 1000 Upgrade Licenses	
FLASR1-IPB-AESK9=	Cisco ASR 1000 Series IP Base to Advanced Enterprise Services Upgrade
FLASR1-IPB-AISK9=	Cisco ASR 1000 Series IP Base to Advanced IP Services Upgrade
FLASR1-AES-AIS=	Cisco ASR 1000 Series Advanced Enterprise to Advanced IP Services Upgrade
Cisco ASR 1000 Software Spare	
ASR1000-SW-SPARECD	Cisco ASR 1000 Series Software Spare CD
Cisco ASR 1000 CD Feature Packs	
CDASR1000R1-IPB=	CD ASR 1000 RP1 IP Base without Crypto, Spare
CDASR1000R1-IPBK9=	Cisco ASR 1000 RP1 IP Base, Spare
CDASR1000R1-AISK9=	Cisco ASR 1000 RP1 Advanced IP Services, Spare
CDASR1000R1-AESK9=	Cisco ASR 1000 RP1 Advanced Enterprise Services, Spare
Cisco ASR 1000 Power Supply & Power Cords	
Please contact your local Cisco account representative or check the Cisco ASR 1000 Price List.	

Ordering Information continued

Cisco ASR 1000 Accessories

ASR1002-ACS=	Cisco ASR 1002 Accessory Kit, Spare
ASR1002-FIPS-KIT=	ASR 1002 FIPS Opacity Kit
ASR1004-FIPS-KIT=	ASR 1004 FIPS Opacity Kit
ASR1006-FIPS-KIT=	ASR 1006 FIPS Opacity Kit
ASR1004-ACS=	Cisco ASR 1004 Accessory Kit, Spare
ASR1006-ACS=	Cisco ASR 1006 Accessory Kit, Spare
SPA-BLANK=	Blank Cover for Regular SPA
ASR1000-SIP-BLANK=	Blank Cover ASR 1000 SIP, Spare
ASR1000-ESP-BLANK=	Blank Cover for ASR 1000 ESP, Spare
ASR1000-RP-BLANK=	Blank Cover for ASR 1000 RP, Spare

Notes



Cisco 7600 Series

The Cisco 7600 Series combines optical WAN/MAN networking and high-volume Ethernet aggregation with a focus on the delivery of high-touch services for the IP and MPLS edge. It combines Layer 2 and Layer 3 networking capabilities with a high-bandwidth, high-performance architecture including hardware-based forwarding of MPLS, IPv4, and IPv6. Cisco 7600 series form factors include the Cisco 7604, 7606, 7609, and 7613. Each router can deliver DS0 to OC-192 WAN and nx10-Mbps Ethernet to nx10 Gigabit Ethernet connectivity into service provider edge, metropolitan-area, and enterprise networks for a variety of triple-play and aggregation solutions.

Benefits and Advantages

The Cisco 7604 is a small form factor router that offers a wide range of interfaces ranging from DS0 to OC-192, FE, GbE, 10GbE, allowing it to be deployed in a wide range of applications. It supports redundant supervisors and high-availability features—making the Cisco 7604 resilient.

Security Features

The Cisco 7604 advanced security services offer protection for the device, service, and network:

Device Protection

- Control plane protection
- User access
- Spoofed address

Service Protection

- VRF Aware IPsec VPN
- Virtualized firewall
- Virtualized intrusion detection

Network Protection

- Clean pipes
- Distributed denial of service protection
- Network Protection Access Control Lists
- Reverse Path Forwarding

When to Deploy

This flexible router is ideal for addressing high-performance applications such as:

- High-end CPE
- Enterprise WAN Aggregation
- Leased Line Aggregation
- IP/MPLS Provider Edge
- MPLS HA
- Metro Ethernet
- Mobile RAN

Application Example

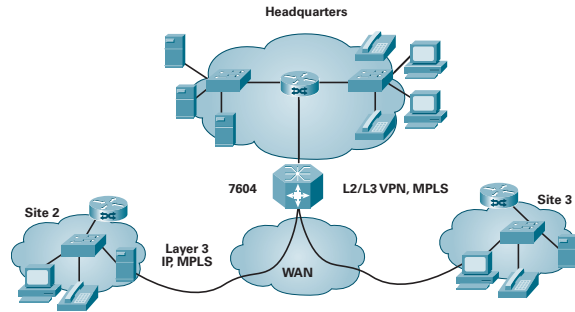

High-Availability Features

The Cisco 7604 supports redundant processors and power supplies. The Cisco 7604 offers the following high-availability software features in 12.2.18SX.E:

- Online Insertion and Removal
- Hot Standby Routing Protocol
- Fast Software Upgrade
- Route Processor Redundancy Plus
- Nonstop Forwarding
- Stateful Switchover

Platform Overview

Feature	Cisco 7603-S	Cisco 7604	Cisco 7606-S/7606	Cisco 7609-S/7609	Cisco 7613
Fixed Ports	SFP and 10/100/1000 (rsp720, Sup720)	SFP and 10/100/1000 (rsp720, Sup720)	SFP and 10/100/1000 (rsp720, Sup720)	SFP and 10/100/1000 (rsp720, Sup720)	SFP and 10/100/1000 (rsp720, Sup720)
Expansion Slots	3 (horizontal)	4 (horizontal)	6 (horizontal)	9 (vertical)	13 (horizontal)
WAN Interface Range	DS0 to OC-192	DS0 to OC-192	DS0 to OC-192	DS0 to OC-192	DS0 to OC-192
LAN Interface Range	10 Mbps to 10 Gbps	10 Mbps to 10 Gbps	10 Mbps to 10 Gbps	10 Mbps to 10 Gbps	10 Mbps to 10 Gbps
Processor	Supervisors: RSP720-3C, RSP720-3CXL, Sup720-3B, Sup720-3BXL, Sup32	Supervisors: RSP720-3C, RSP720-3CXL, Sup720-3B, Sup720-3BXL, Sup32	Supervisors: RSP720-3C, RSP720-3CXL, Sup720-3B, Sup720-3BXL, Sup32	Supervisors: RSP720-3C, RSP720-3CXL, Sup720-3B, Sup720-3BXL, Sup32	Supervisors: RSP720-3C, RSP720-3CXL, Sup720-3B, Sup720-3BXL, Sup32

Platform Overview continued

Feature	Cisco 7603-S	Cisco 7604	Cisco 7606-S/7606	Cisco 7609-S/7609	Cisco 7613
Forwarding Rate Centralized	15 Mpps	Up to 30 Mpps	Up to 30 Mpps	Up to 30 Mpps	Up to 30 Mpps
Forwarding Rate Distributed	120 Mpps	170 Mpps	170 Mpps	170 Mpps	170 Mpps
Backplane Capacity	240 Gbps	320 Gbps	480 Gbps	720 Gbps	720 Gbps
Flash PCMCIA Memory	Up to 1 GB	Up to 1 GB	Up to 1 GB	Up to 1 GB	Up to 1 GB
System DRAM Memory	4 GB on RSP720-3CXL, 2 GB on RSP720-3CXL 1 GB on Sup720-3BXL, 512MB on Sup720-3B	4 GB on RSP720-3CXL, 2 GB on RSP720-3CXL 1 GB on Sup720-3BXL, 512 MB on Sup720-3B	4 GB on RSP720-3CXL, 2 GB on RSP720-3CXL 1 GB on Sup720-3BXL, 512 MB on Sup720-3B	4 GB on RSP720-3CXL, 2 GB on RSP720-3CXL 1 GB on Sup720-3BXL, 512 MB on Sup720-3B	4 GB on RSP720-3CXL, 2 GB on RSP720-3CXL 1 GB on Sup720-3BXL, 512 MB on Sup720-3B
Internal Power Supply	DC	AC or DC	AC or DC	AC or DC	AC or DC
RPS Support	Yes	Yes	Yes	Yes	Yes
Chassis Height	4 RU	5 RU	7 RU	20 RU	18 RU
Rack Mountable	Yes, up to 11 per rack	Yes, up to 9 per rack	Yes, up to 6 per rack	Yes, up to 2 per rack	Yes, up to 2 per rack
Dimensions (H x W x D)	7 x 17.37 x 20.3 in.	8.75 x 17.5 x 21.8 in.	12.25 x 17.37 x 21.75 in.	36.75 x 17.2 x 20.7 in.	33.3 x 17.2 x 18.1 in.

Ordering Information

Product Number	Product Description
Cisco 7613 Systems	
7613-RSP720C-P	Cisco 7613 Chassis, 13-slot, RSP720-3C, Power Supply
7613-RSP720C-R	Cisco 7613 Chassis, 13-slot, Redundant System, 2RSP720-3C, 2 Power Supply
7613-RSP720CXL-P	Cisco 7613 Chassis, 13-slot, RSP720-3CXL, Power Supply
7613-RSP720CXL-R	Cisco 7613 Chassis, 13-slot, Redundant System, 2RSP720-3CXL, 2 Power Supply
CISCO7613	Cisco 7613 Chassis, 13-slot
CISCO7613/EHA1	Bundle: Cisco Enhanced Home Agent R1 for 7613 (600k Sessions)
CISCO7613=	Spare Cisco 7613 Chassis, Equipped with High-speed FAN2
7613-S323B-8G-P	Cisco 7613 Chassis, 13-slot, SUP32-8GE-3B, Power Supply
7613-S323B-8G-R	Cisco 7613 Chassis, 13-slot, Redundant SUP32-8GE-3B and Power Supply
7613-S323B-10G-P	Cisco 7613 Chassis, 13-slot, SUP32-2X10GE-3B, Power Supply

Ordering Information continued

Product Number	Product Description
Cisco 7613 Systems continued	
7613-S323B-10G-R	Cisco 7613 Chassis, 13-slot, Redundant SUP32-2X10GE-3B and Power Supply
7613-SUP720XL-PS	Cisco 7613 Chassis, 13-slot, SUP720-3BXL and Power Supply
7613-2SUP720XL-2PS	Cisco 7613 Chassis, 13-slot, Redundant System, 2 SUP720-3BXL and 2 Power Supply
7613-SUP7203B-PS	Cisco 7613 Chassis, 13-slot, SUP7203B, Power Supply
7613-2SUP7203B-2PS	Cisco 7613 Chassis, 13-slot, 2 SUP7203B, 2 Power Supply
7613-VPN+K9	Cisco 7613 IPsec VPN System Bundle
Cisco 7609 Systems	
7609-RSP720C-P	Cisco 7609 Chassis, 9-slot, RSP720-3C, Power Supply
7609-RSP720C-R	Cisco 7609 Chassis, 9-slot, Redundant System, 2RSP720-3C, 2 Power Supply
7609-RSP720CX-L-P	Cisco 7609 Chassis, 9-slot, RSP720-3CXL, Power Supply
7609-RSP720CX-L-R	Cisco 7609 Chassis, 9-slot, Redundant System, 2RSP720-3CXL, 2 Power Supply
7609S-RSP720C-P	Cisco 7609-S Chassis, 9-slot, RSP720-3C, Power Supply
7609S-RSP720C-R	Cisco 7609-S Chassis, 9-slot, Redundant System, 2RSP720-3C, 2 Power Supply
7609S-RSP720CX-L-P	Cisco 7609-S Chassis, 9-slot, RSP720-3CXL, Power Supply
7609S-RSP720CX-L-R	Cisco 7609-S Chassis, 9-slot, Redundant System, 2RSP720-3CXL, 2 Power Supply
7609S-S32-10G-B-P	Cisco 7609-S Chassis, 9-slot, SUP32-2X10GE-3B, Power Supply
7609S-S32-10G-B-R	Cisco 7609-S Chassis, 9-slot, Redundant SUP32-2X10GE-3B, Power Supply
7609S-S32-8G-B-P	Cisco 7609-S Chassis, 9-slot, SUP32-8GE-3B, Power Supply
7609S-S32-8G-B-R	Cisco 7609-S Chassis, 9-slot, Redundant SUP32-8GE-3B, Power Supply
7609S-SUP720B-P	Cisco 7609-S Chassis, 9-slot, SUP720-3B, Power Supply
7609S-SUP720B-R	Cisco 7609-S Chassis, 9-slot, Redundant System, 2SUP720-3B, 2 Power Supply
7609S-SUP720BXL-P	Cisco 7609-S Chassis, 9-slot, SUP720-3BXL, Power Supply
7609S-SUP720BXL-R	Cisco 7609-S Chassis, 9-slot, Redundant System, 2SUP720-3BXL, 2 Power Supply
CISCO7609	Cisco 7609 Chassis
CISCO7609-S	Cisco 7609-S Chassis
CISCO7609-S=	Cisco 7609-S Chassis
CISCO7609/EHA1	Bundle: Cisco Enhanced Home Agent R1 for 7609 (300k Sessions)
CISCO7609=	Cisco 7609 Chassis Spare
7609-S323B-8G-P	Cisco 7609 Chassis, 9-slot, SUP32-8GE-3B, Power Supply
7609-S323B-8G-R	Cisco 7609 Chassis, 9-slot, Redundant SUP32-8GE-3B and Power Supply
7609-S323B-10G-P	Cisco 7609 Chassis, 9-slot, SUP32-2X10GE-3BB, Power Supply
7609-S323B-10G-R	Cisco 7609 Chassis, 9-slot, Redundant SUP32-2X10GE-3B and Power Supply
7609-SUP720XL-PS	Cisco 7609 Chassis, 9-slot, SUP720-3BXL and Power Supply
7609-2SUP720XL-2PS	Cisco 7609 Chassis, 9-slot, Redundant System, 2 SUP720-3BXL and 2 Power Supply

Ordering Information continued

Product Number	Product Description
Cisco 7609 Systems continued	
7609-SUP7203B-PS	Cisco 7609 Chassis, 9-slot, SUP7203B, Power Supply
7609-2SUP7203B-2PS	Cisco 7609 Chassis, 9-slot, 2 SUP7203B, 2 Power Supply
7609-VPN+K9	Cisco 7609 IPsec VPN System Bundle
Cisco 7606 Systems	
7606-RSP720C-P	Cisco 7606 Chassis, 6-slot, RSP720-3C, Power Supply
7606-RSP720C-R	Cisco 7606 Chassis, 6-slot, Redundant System, 2RSP720-3C, 2 Power Supply
7606-RSP720CX-L-P	Cisco 7606 Chassis, 6-slot, RSP720-3CXL, Power Supply
7606-RSP720CX-L-R	Cisco 7606 Chassis, 6-slot, Redundant System, 2RSP720-3CXL, 2 Power Supply
CISCO7606	Cisco 7606 Chassis
7606-S323B-8G-P	Cisco 7606 Chassis, 6-slot, SUP32-8GE-3B, Power Supply
7606-S323B-8G-R	Cisco 7606 Chassis, 6-slot, Redundant SUP32-8GE-3B and Power Supply
7606-S323B-10G-P	Cisco 7606 Chassis, 6-slot, SUP32-2X10GE-3B, Power Supply
7606-S323B-10G-R	Cisco 7606 Chassis, 6-slot, Redundant SUP32-2X10GE-3B and Power Supply
7606-SUP720XL-PS	Cisco 7606 Chassis, 6-slot, SUP720-3BXL and Power Supply
7606-2SUP720XL-2PS	Cisco 7606 Chassis, 6-slot, Redundant System, 2 SUP720-3BXL and 2 Power Supply
7606-SUP7203B-PS	Cisco 7606 Chassis, 6-slot, SUP7203B, Power Supply
7606-2SUP7203B-2PS	Cisco 7606 Chassis, 6-slot, 2 SUP7203B, 2 Power Supply
CISCO7606=	Cisco 7606 Chassis Spare
CISCO7606-CHASS	Cisco 7606 Chassis
7606-VPN+K9	Cisco 7606 IPsec VPN System Bundle
Cisco 7604 Systems	
CISCO7604	Cisco 7604 Chassis
7604-RSP720C-P	Cisco 7604 Chassis, 4-slot, RSP720-3C, Power Supply
7604-RSP720C-R	Cisco 7604 Chassis, 4-slot, Redundant System, 2RSP720-3C, 2 Power Supply
7604-RSP720CX-L-P	Cisco 7604 Chassis, 4-slot, RSP720-3CXL, Power Supply
7604-RSP720CX-L-R	Cisco 7604 Chassis, 4-slot, Redundant System, 2RSP720-3CXL, 2 Power Supply
CISCO7604=	Cisco 7604 Chassis Spare
7604-S323B-8G-P	Cisco 7604 Chassis, 4-slot, SUP32-8GE-3B, Power Supply
7604-S323B-8G-R	Cisco 7604 Chassis, 4-slot, Redundant SUP32-8GE-3B and Power Supply
7604-S323B-10G-P	Cisco 7604 Chassis, 4-slot, SUP32-2X10GE-3B, Power Supply
7604-S323B-10G-R	Cisco 7604 Chassis, 4-slot, Redundant SUP32-2X10GE-3B and Power Supply
7604-SUP7203B-PS	Cisco 7604 Chassis, 4-slot, SUP720-3B, Power Supply
7604-2SUP7203B-2PS	Cisco 7604 Chassis, 4-slot, 2 SUP720-3B, 2 Power Supply
7604-SUP720XL-PS	Cisco 7604 Chassis, 4-slot, SUP720-3BXL, Power Supply

Ordering Information continued

Product Number	Product Description
Cisco 7604 Systems continued	
7604-2SUP720XL-2PS	Cisco 7604 Chassis, 4-slot, 2SUP720-3BXL, 2 Power Supply
7604-VPN+-K9	Cisco 7604 IPsec VPN System Bundle
Cisco 7603 FlexWAN Modules	
7603S-S32-10G-B-P	Cisco 7603-S Chassis, 3-slot, SUP32-2X10GE-3B, Power Supply
7603S-S32-8G-B-P	Cisco 7603-S Chassis, 3-slot, SUP32-8GE-3B, Power Supply
CISCO7603-S	Cisco 7603-S Chassis
CISCO7603-S=	Cisco 7603-S Chassis Spare
Cisco 7613 Systems	
7613-RSP720C-P	Cisco 7613 Chassis, 13-slot, RSP720-3C, Power Supply
7613-RSP720C-R	Cisco 7613 Chassis, 13-slot, Redundant System, 2RSP720-3C, 2 Power Supply
7613-RSP720CXL-P	Cisco 7613 Chassis, 13-slot, RSP720-3CXL, Power Supply
7613-RSP720CXL-R	Cisco 7613 Chassis, 13-slot, Redundant System, 2RSP720-3CXL, 2 Power Supply
CISCO7613	Cisco 7613 Chassis
CISCO7613/EHA1	Bundle: Cisco Enhanced Home Agent R1 for 7613 (600k Sessions)
CISCO7613=	Spare Cisco 7613 Chassis, equipped with High-speed FAN2
7613-S323B-8G-P	Cisco 7613 Chassis, 13-slot, SUP32-8GE-3B, Power Supply
7613-S323B-8G-R	Cisco 7613 Chassis, 13-slot, Redundant SUP32-8GE-3B and Power Supply
7613-S323B-10G-P	Cisco 7613 Chassis, 13-slot, SUP32-2X10GE-3B, Power Supply
7613-S323B-10G-R	Cisco 7613 Chassis, 13-slot, Redundant SUP32-2X10GE-3B and Power Supply
7613-SUP720XL-PS	Cisco 7613 13-slot, SUP720-3BXL and Power Supply
7613-2SUP720XL-2PS	Cisco 7613 Chassis, 13-slot, Redundant System, 2 SUP720-3BXL and 2 Power Supply
7613-SUP7203B-PS	Cisco 7613 Chassis, 13-slot, SUP7203B, Power Supply
7613-2SUP7203B-2PS	Cisco 7613 Chassis, 13-slot, 2 SUP7203B, 2 Power Supply
7613-VPN+-K9	Cisco 7613 IPsec VPN System Bundle
Cisco 7600 Ethernet Services Modules	
7600-ES20-GE3C	7600 ES20 Line Card, 20xGbE SFP with DFC 3C
7600-ES20-GE3C=	7600 ES20 Line Card, 20xGbE SFP with DFC 3C
7600-ES20-GE3CXL	7600 ES20 Line Card, 20xGbE SFP with DFC 3CXL
7600-ES20-GE3CXL=	7600 ES20 Line Card, 20xGbE SFP with DFC 3CXL
7600-ES20-10G3C	7600 ES20 Line Card, 2x10GbE XFP with DFC 3C
7600-ES20-10G3C=	7600 ES20 Line Card, 2x10GbE XFP with DFC 3C
7600-ES20-10G3CXL=	7600 ES20 Line Card, 2x10GbE XFP with DFC 3CXL
7600-ES20-10G3CXL	7600 ES20 Line Card, 2x10GbE XFP with DFC 3CXL

Ordering Information continued

Product Number	Product Description
Cisco 7600 Shared Port Adapters and SPA Interface	
7600-SIP-200	Cisco 7600 Series SPA Interface Processor-200
SPA-24CHT1-CE-ATM	24-port Channelized T1/E1/J1 ATM and Circuit Emulation SPA
SPA-1CHOC3-CE-ATM=	1-port Channelized OC-3/STM-1 ATM and Circuit Emulation SPA
7600-SIP-200=	Cisco 7600 Series SPA Interface Processor-200
SPA-24CHT1-CE-ATM=	24-port Channelized T1/E1/J1 ATM and Circuit Emulation SPA
7600-SIP-400	Cisco 7600 Series SPA Interface Processor-400
7600-SIP-400=	Cisco 7600 Series SPA Interface Processor-400
7600-SIP-600	Cisco 7600 Series SPA Interface Processor-600
7600-SIP-600=	Cisco 7600 Series SPA Interface Processor-600
7600-SSC-400	Cisco 7600/Catalyst 6500 Services SPA Carrier Card
7600-SSC-400=	Cisco 7600/Catalyst 6500 Services SPA Carrier Card
SPA-2XOC3-ATM	2-port OC-3c/STM-1 ATM Shared Port Adapter
SPA-2XOC3-ATM=	2-port OC-3c/STM-1 ATM Shared Port Adapter
SPA-2XOC3-POS	2-port OC-3/STM-1 POS Shared Port Adapters
SPA-2XOC3-POS=	2-port OC-3/STM-1 POS Shared Port Adapters
SPA-4XOC3-ATM	4-port OC-3c/STM-1 ATM Shared Port Adapter
SPA-4XOC3-ATM=	4-port OC-3c/STM-1 ATM Shared Port Adapter
SPA-1XCHSTM1/OC3	1-port Channelized STM-1/OC-3c to DS0 Shared Port Adapter
SPA-1XCHSTM1/OC3=	1-port Channelized STM-1/OC-3c to DS0 Shared Port Adapter
SPA-1XOC12-POS	1-port OC-12/STM-4 POS Shared Port Adapters
SPA-1XOC12-POS=	1-port OC-12/STM-4 POS Shared Port Adapters
SPA-1XOC12-ATM	1-port OC-12c/STM-4 ATM Shared Port Adapter
SPA-1XOC12-ATM=	1-port OC-12c/STM-4 ATM Shared Port Adapter
SPA-1XOC48POS/RPR	1-port OC-48/STM-16 POS/RPR Shared Port Adapters
SPA-1XOC48POS/RPR=	1-port OC-48/STM-16 POS/RPR Shared Port Adapters
SPA-2XOC48POS/RPR	2-port OC-48/STM-16 POS/RPR Shared Port Adapters
SPA-2XOC48POS/RPR=	2-port OC-48/STM-16 POS/RPR Shared Port Adapters
SPA-2X1GE-V2	Cisco 2-port Gigabit Ethernet Shared Port Adapter
SPA-2X1GE-V2=	Cisco 2-port Gigabit Ethernet Shared Port Adapter
SPA-2XT3/E3	2-port Clear Channel T3/E3 Shared Port Adapter
SPA-2XT3/E3=	2-port Clear Channel T3/E3 Shared Port Adapter
SPA-4XT3/E3	4-port Clear Channel T3/E3 Shared Port Adapter
SPA-4XT3/E3=	4-port Clear Channel T3/E3 Shared Port Adapter

Ordering Information continued

Product Number	Product Description
Cisco 7600 Shared Port Adapters and SPA Interface continued	
SPA-4X1FE-TX-V2	Cisco 4-port Fast Ethernet (TX) Shared Port Adapter
SPA-4X1FE-TX-V2=	Cisco 4-port Fast Ethernet (TX) Shared Port Adapter
SPA-2XCT3/DS0	2-port Channelized T3 to DS0 Shared Port Adapter
SPA-2XCT3/DS0=	2-port Channelized T3 to DS0 Shared Port Adapter
SPA-4XCT3/DS0	4-port Channelized T3 to DS0 Shared Port Adapter
SPA-4XCT3/DS0=	4-port Channelized T3 to DS0 Shared Port Adapter
SPA-4XOC48POS/RPR	4-port OC-48/STM-16 POS/RPR Shared Port Adapters
SPA-4XOC48POS/RPR=	4-port OC-48/STM-16 POS/RPR Shared Port Adapters
SPA-1XOC48-ATM	Cisco 1-port OC-48c/STM-16 ATM Shared Port Adapter
SPA-1XOC48-ATM=	Cisco 1-port OC-48c/STM-16 ATM Shared Port Adapter
SPA-1XTENGE-XFP	1-port 10 Gigabit Ethernet Shared Port Adapter XFP-based
SPA-1XTENGE-XFP=	1-port 10 Gigabit Ethernet Shared Port Adapter XFP-based
SPA-2X1GE	Cisco 2-port Gigabit Ethernet Shared Port Adapter
SPA-2X1GE=	Cisco 2-port Gigabit Ethernet Shared Port Adapter
SPA-5X1GE	5-port Gigabit Ethernet Shared Port Adapter
SPA-5X1GE=	5-port Gigabit Ethernet Shared Port Adapter
SPA-5X1GE-V2	Cisco 5-port Gigabit Ethernet Shared Port Adapter
SPA-5X1GE-V2=	Cisco 5-port Gigabit Ethernet Shared Port Adapter
SPA-8XCHT1/E1	8-port Channelized T1/E1 to DS0 Shared Port Adapter
SPA-8XCHT1/E1=	8-port Channelized T1/E1 to DS0 Shared Port Adapter
SPA-8X1FE-TX-V2	Cisco 8-port Fast Ethernet (TX) Shared Port Adapter
SPA-8X1FE-TX-V2=	Cisco 8-port Fast Ethernet (TX) Shared Port Adapter
SPA-10X1GE	10-port Gigabit Ethernet Shared Port Adapter
SPA-10X1GE=	10-port Gigabit Ethernet Shared Port Adapter
SPA-IPSEC-2G	Cisco 7600 / Catalyst 6500 IPsec VPN SPA - DES/3DES/AES
SPA-IPSEC-2G=	Cisco 7600 / Catalyst 6500 IPsec VPN SPA - DES/3DES/AES
SPA-BLANK	Blank Cover for regular SPA
SPA-BLANK=	Blank Cover for regular SPA
SPA-OC192POS-LR	1-port OC-192/STM-64 POS/RPR SMLR Optics
SPA-OC192POS-LR=	1-port OC-192/STM-64 POS/RPR SMLR Optics
SPA-OC192POS-VSR	1-port OC-192/STM-64 POS/RPR VSR Optics
SPA-OC192POS-VSR=	1-port OC-192/STM-64 POS/RPR VSR Optics

Ordering Information continued

Product Number	Product Description
Cisco 7600 Shared Port Adapters and SPA Interface continued	
SPA-OC192POS-XFP	1-port OC-192/STM-64 POS/RPR XFP Optics
SPA-OC192POS-XFP=	1-port OC-192/STM-64 POS/RPR XFP Optics
SFP-OC48-IR1	OC-48c/STM-16c
SFP-OC48-LR2	OC-48c/STM-16c SFP, Long Reach (80km)
SFP-OC48-SR	OC-48c/STM-16c SFP, Short Reach
Cisco 7600 Common Equipment	
RSP720-3C-GE=	Cisco 7600 Route Switch Processor 720 Gbps Fabric, PFC3C, GbE
RSP720-3CXL-GE=	Cisco 7600 Route Switch Processor 720 Gbps Fabric, PFC3CXL, GE
WS-SUP32-GE-3B	Catalyst 6500 Supervisor 32 with 8 GbE Uplinks and PFC3B
WS-SUP32-GE-3B=	Catalyst 6500 Supervisor 32 with 8 GbE Uplinks and PFC3B
WS-SUP32-10GE-3B	Catalyst 6500 Supervisor 32 with 2-port 10GbE and PFC3B
WS-SUP32-10GE-3B=	Catalyst 6500 Supervisor 32 with 2-port 10GbE and PFC3B
WS-SUP720-3B	Catalyst 6500/Cisco 7600 Supervisor 720 Fabric MSFC3 PFC3B
WS-SUP720-3B=	Catalyst 6500/Cisco 7600 Supervisor 720 Fabric MSFC3 PFC3B
WS-SUP720-3BXL	Catalyst 6500/Cisco 7600 Supervisor 720 Fabric MSFC3 PFC3BXL
WS-SUP720-3BXL=	Catalyst 6500/Cisco 7600 Supervisor 720 Fabric MSFC3 PFC3BXL
WS-F6700-DFC3BXL	Catalyst 6500 Dist Fwd Card-3BXL, for WS-X67xx
WS-F6700-DFC3BXL=	Catalyst 6500 Dist Fwd Card-3BXL, for WS-X67xx
WS-F6700-DFC3B	Catalyst 6500 Dist Fwd Card, 256K Routes for WS-X67xx
WS-F6700-DFC3B=	Catalyst 6500 Dist Fwd Card, 256K+ Routes for WS-X67xx
WS-F6K-DFC3B	Catalyst 6500 Dist Fwd Card-3B for 65xx, 6816 Modules
WS-F6K-DFC3B=	Catalyst 6500 Dist Fwd Card-3B for 65xx, 6816 Modules
WS-F6K-DFC3BXL	Catalyst 6500 Dist Fwd Card-3BXL for 65xx, 6816 Modules
WS-F6K-DFC3BXL=	Catalyst 6500 Dist Fwd Card-3BXL for 65xx, 6816 Modules
WS-F6K-PFC3B	Catalyst 6500 Sup720 Policy Feature Card-3B
WS-F6K-PFC3B=	Catalyst 6500 Sup720 Policy Feature Card-3B
WS-F6K-PFC3BXL=	Sup720 PFC-3BXL Plus 2x1 Gigabit Memory
WS-F6700-DFC3C	Catalyst 6500 Dist Fwd Card for WS-X67xx Modules
WS-F6700-DFC3CXL	Catalyst 6500 Dist Fwd Card-3CXL, for WS-X67xx

Ordering Information continued

Product Number	Product Description
Cisco 7600 FlexWAN Module*	
PA-POS-1OC3-2PAK=	Packet over SONET OC-3 2 Pack Bundle
WS-X6582-2PA	Cisco 7600/Catalyst 6500 Enhanced FlexWAN, Fabric-enabled
WS-X6582-2PA=	Cisco 7600/Catalyst 6500 Enhanced FlexWAN, Fabric-enabled
PA-4T+	4-port Serial Port Adapter, Enhanced
PA-4T+=	4-port Serial Port Adapter, Enhanced
PA-8T-V35	8-port Serial, V.35 Port Adapter
PA-8T-V35=	8-port Serial, V.35 Port Adapter
PA-8T-232	8-port Serial, 232 Port Adapter
PA-8T-232=	8-port Serial, 232 Port Adapter
PA-8T-X21	8-port Serial, X.21 Port Adapter
PA-8T-X21=	8-port Serial, X.21 Port Adapter
PA-H	1-port HSSI Port Adapter
PA-H=	1-port HSSI Port Adapter, Spare
PA-H=	1-port HSSI Port Adapter, Spare
PA-2H	2-port HSSI Port Adapter
PA-2H=	2-port HSSI Port Adapter, Spare
PA-A3-8E1IMA	8-port ATM Inverse Mux E1 (120 ohm) Port Adapter
PA-A3-8E1IMA=	8-port ATM Inverse Mux E1 (120 ohm) Port Adapter, Spare
PA-A3-8T1IMA	8-port ATM Inverse Mux T1 Port Adapter
PA-A3-8T1IMA=	8-port ATM Inverse Mux T1 Port Adapter, Spare
PA-A6-OC3MM	1-port Enhanced ATM OC-3c/STM-1 Multi-mode Port Adapter
PA-A6-OC3MM=	1-port Enhanced ATM OC-3c/STM-1 Multi-mode Port Adapter
PA-A6-OC3SML	1-port Enhanced ATM OC-3c/STM-1 Single-mode (LR) Port Adapter
PA-A6-OC3SML=	1-port Enhanced ATM OC-3c/STM-1 Single-mode (LR) Port Adapter
PA-A6-T3	1-port Enhanced ATM DS3 Port Adapter
PA-A6-T3=	1-port Enhanced ATM DS3 Port Adapter
PA-A6-E3	1-port Enhanced ATM E3 Port Adapter
PA-A6-E3=	1-port Enhanced ATM E3 Port Adapter
PA-E3	1-port E3 Serial Port Adapter with E3 DSU
PA-E3=	1-port E3 Serial Port Adapter with E3 DSU
PA-2E3	2-port E3 Serial Port Adapter with E3 DSUs
PA-2E3=	2-port E3 Serial Port Adapter with E3 DSUs
PA-T3+	1-port T3 Serial Port Adapter Enhanced
PA-T3+=	1-port T3 Serial Port Adapter Enhanced
PA-2T3+	2-port T3 Serial Port Adapter Enhanced
PA-2T3+=	2-port T3 Serial Port Adapter Enhanced, Spare

Ordering Information continued

Product Number	Product Description
Cisco 7600 FlexWAN Module* continued	
PA-MC-E3	1-port Multi-channel E3 Port Adapter
PA-MC-E3=	1-port Multi-channel E3 Port Adapter
PA-MC-T3	1-port Multi-channel T3 Port Adapter
PA-MC-T3=	1-port Multi-channel T3 Port Adapter
PA-MC-2E1/120	2-port Multi-channel E1 Port Adapter with G.703 120 ohm Interface
PA-MC-2E1/120=	2-port Multi-channel E1 Port Adapter with G.703 120 ohm Interface
PA-MC-2T3+	2-port Multi-channel T3 Port Adapter
PA-MC-2T3+=	2-port Multi-channel T3 Port Adapter
PA-MC-2T1	2-port Multi-channel T1 Port Adapter with Integrated CSU/DSUs
PA-MC-2T1=	2-port Multi-channel T1 Port Adapter Port Adapter with Integrated CSU/DSUs
PA-MC-4T1	4-port Multi-channel T1 Port Adapter with Integrated CSU/DSUs
PA-MC-4T1=	4-port Multi-channel T1 Port Adapter with Integrated CSU/DSUs
PA-POS-1OC3	1-port Packet/SONET OC-3c/STM-1 Port Adapter
PA-POS-1OC3=	1-port Packet/SONET OC-3c/STM-1 Port Adapter
PA-POS-2OC3	2-port Packet/SONET OC-3c/STM-1 Port Adapter
PA-POS-2OC3=	2-port Packet/SONET OC-3c/STM-1 Port Adapter
PA-MC-STM-1MM	1-port Multi-channel STM-1 Multi-mode Port Adapter
PA-MC-STM-1MM=	1-port Multi-channel STM-1 Multi-mode Port Adapter
PA-MC-STM-1SMI	1-port Multi-channel STM-1 Single Mode Port Adapter
PA-MC-STM-1SMI=	1-port Multi-channel STM-1 Single Mode Port Adapter
PA-MC-8TE1+	8-port Multi-channel T1/E1 8PRI Port Adapter
PA-MC-8TE1+=	8-port Multi-channel T1/E1 8PRI Port Adapter
Cisco 7600/Catalyst 6500 Ethernet Modules	
WS-X6548V-GE-TX	Catalyst 6500 48-port Fabric-enabled 10/100/1000 Inline Power Module
WS-X6548V-GE-TX=	Catalyst 6500 48-port Fabric-enabled 10/100/1000 Inline Power Module
WS-X6548-GE-TX	Catalyst 6500 48-port Fabric-enabled 10/100/1000 Module
WS-X6548-GE-TX=	Catalyst 6500 48-port Fabric-enabled 10/100/1000 Module
WS-X6548-GE-45AF	Catalyst 6500 PoE 802.3af 10/100/1000 48-port (RJ-45) CEF256 Card
WS-X6548-GE-45AF=	Catalyst 6500 PoE 802.3af 10/100/1000 48-port (RJ-45) CEF256 Card
WS-X6524-100FX-MM	Catalyst 6500 24-port 100FX, MT-RJ, Fabric-enabled
WS-X6524-100FX-MM=	Catalyst 6500 24-port 100FX, MT-RJ, Fabric-enabled
WS-X6408A-GBIC	Catalyst 6000 8-port GbE, Enhanced QoS (Require GBICs)
WS-X6408A-GBIC=	Catalyst 6000 8-port GbE, Enhanced QoS (Require GBICs)
WS-X6196-RJ-21	Catalyst 6500 96-port 10/100 Upgradable - PoE 802.3af
WS-X6196-RJ-21=	Catalyst 6500 96-port 10/100 Upgradable - PoE 802.3af
WS-X6196-21AF	Catalyst 6500 96-port, PoE 802.3af 10/100 - RJ-21

Ordering Information continued

Product Number	Product Description
Cisco 7600/Catalyst 6500 Ethernet Modules continued	
WS-X6196-21AF=	Catalyst 6500 96-port, PoE 802.3af 10/100, RJ-21
WS-X6148X2-RJ-45	Catalyst 6500 96-port 10/100 (RJ-45), Upgradable to PoE 802.3af
WS-X6148X2-RJ-45=	Catalyst 6500 96-port 10/100 (RJ-45), Upgradable to PoE 802.3af
WS-X6148X2-45AF	Catalyst 6500 PoE 802.3af 10/100, 96-port (RJ-45) Line Card
WS-X6148X2-45AF=	Catalyst 6500 PoE 802.3af 10/100, 96-port (RJ-45) Line Card
WS-X6148V-GE-TX	Catalyst 6500 48-port 10/100/1000 Inline Power Module, RJ-45
WS-X6148V-GE-TX=	Catalyst 6500 48-port 10/100/1000 Inline Power Module, RJ-45
WS-X6148-RJ45V	Catalyst 6500 48-port 10/100 Inline Power, RJ-45
WS-X6148-RJ45V=	Catalyst 6500 48-port 10/100 Inline Power, RJ-45
WS-X6148-RJ-45	Catalyst 6500 48-port 10/100, Upgradable to Voice, RJ-45
WS-X6148-RJ-45=	Catalyst 6500 48-port 10/100, Upgradable to Voice, RJ-45
WS-X6148-RJ21V	Catalyst 6500 48-port 10/100 Inline Power Module, RJ-21
WS-X6148-RJ21V=	Catalyst 6500 48-port 10/100 Inline Power Module, RJ-21
WS-X6148-RJ-21	Catalyst 6500 48-port 10/100 Upgradable to Voice, RJ-21
WS-X6148-RJ-21=	Catalyst 6500 48-port 10/100 Upgradable to Voice, RJ-21
WS-X6148-GE-TX	Catalyst 6500 48-port 10/100/1000 GbE Module, RJ-45
WS-X6148-GE-TX=	Catalyst 6500 48-port 10/100/1000 GbE Module, RJ-45
WS-X6148-GE-45AF	Catalyst 6500 PoE 802.3af 10/100/1000, 48-port (RJ-45) Line Card
WS-X6148-GE-45AF=	Catalyst 6500 PoE 802.3af 10/100/1000, 48-port (RJ-45) Line Card
WS-X6148-FE-SFP	Catalyst 6500 48-port 100BASE-X Module (Require SFP)
WS-X6148-FE-SFP=	Catalyst 6500 48-port 100BASE-X Module (Require SFP)
WS-X6148A-RJ-45	Catalyst 6500 48-port 10/100 with TDR, Upgradable - PoE 802.3af
WS-X6148A-RJ-45=	Catalyst 6500 48-port 10/100 with TDR, Upgradable - PoE 802.3af
WS-X6148A-GE-TX	Catalyst 6500 48-port 10/100/1000 with Jumbo Frame, RJ-45
WS-X6148A-GE-TX=	Catalyst 6500 48-port 10/100/1000 with Jumbo Frame, RJ-45
WS-X6148A-GE-45AF	Catalyst 6500 48-port PoE 802.3af 10/100/1000, with Jumbo Frame
WS-X6148A-GE-45AF=	Catalyst 6500 48-port PoE 802.3af 10/100/1000, with Jumbo Frame
WS-X6148A-45AF	Catalyst 6500 48-port PoE 802.3af 10/100, Card with TDR
WS-X6148A-45AF=	Catalyst 6500 48-port PoE 802.3af 10/100, Card with TDR
WS-X6148-45AF	Catalyst 6500 PoE 802.3af 10/100, 48-port (RJ-45) Line Card
WS-X6148-45AF=	Catalyst 6500 PoE 802.3af 10/100, 48-port (RJ-45) Line Card
WS-X6148-21AF	Catalyst 6500 PoE 802.3af 10/100, 48-port (RJ-21) Line Card
WS-X6148-21AF=	Catalyst 6500 PoE 802.3af 10/100, 48-port (RJ-21) Line Card
WS-F6K-DFC	Dist Fwd Card for 65xx, 6816 Modules used with Sup2
WS-F6K-DFC=	Dist Fwd Card for 65xx, 6816 Modules used with Sup2

Ordering Information continued

Product Number	Product Description
Cisco 7600/Catalyst 6500 Ethernet Modules continued	
WS-X6516A-GBIC	Catalyst 6500 16-port GbE Module, Fabric-enabled (Require GBICs)
WS-X6516A-GBIC=	Catalyst 6500 16-port GbE Module, Fabric-enabled (Require GBICs)
WS-X6816-GBIC	Catalyst 6500 16-port GbE module, 2 Fabric I/F, (Require GBICs, DFC/DFC3)
WS-X6816-GBIC=	Catalyst 6500 16-port GbE module, 2 Fabric I/F, (Require GBICs, DFC/DFC3)
WS-X6548-RJ-21	Catalyst 6500 48-port 10/100, RJ-21, Fabric-enabled
WS-X6548-RJ-21=	Catalyst 6500 48-port 10/100, RJ-21, Fabric-enabled
WS-X6548-RJ-45	Catalyst 6500 48-port 10/100, RJ-45, Cross-bar
WS-X6548-RJ-45=	Catalyst 6500 48-port 10/100, RJ-45, Cross-bar
WS-X6516-GE-TX	Catalyst 6500 16-port 10/100/1000 GbE Module, Cross-bar
WS-X6516-GE-TX=	Catalyst 6500 16-port 10/100/1000 GbE Module, Cross-bar, Spare
WS-X6748-GE-TX	Catalyst 6500 48-port 10/100/1000 GbE Module, Fabric-enabled, RJ-45
WS-X6748-GE-TX=	Catalyst 6500 48-port 10/100/1000 GbE Module, Fabric-enabled, RJ-45
WS-X6724-SFP	Catalyst 6500 24-port GbE Module, Fabric-enabled (Require SFPs)
WS-X6724-SFP=	Catalyst 6500 24-port GbE Module, Fabric-enabled (Require SFPs)
WS-X6748-SFP	Catalyst 6500 48-port GbE Module, Fabric-enabled (Require SFPs)
WS-X6748-SFP=	Catalyst 6500 48-port CEF720 GbE Module (Require SFPs)
WS-X6704-10GE	Catalyst 6500 4-port 10 Gigabit Ethernet Module (Require XENPAKs)
WS-X6704-10GE=	Catalyst 6500 4-port 10 Gigabit Ethernet Module (Require XENPAKs)
Cisco 7600 Services Modules	
SPA-IPSEC-2G	Cisco 6500/7600 IPsec VPN SPA - DES/3DES/AES
SPA-IPSEC-2G=	Cisco 6500/7600 IPsec VPN SPA - DES/3DES/AES
SPA-IPSEC-SSC400-1	Cisco 6500/7600 IPsec VPN SPA Bundle 1 (System only)
SPA-IPSEC-SSC400-2	Cisco 6500/7600 IPsec VPN SPA Bundle 2 (System only)
WS-SVC-ADM-1-K9	Catalyst 6500 Cisco Anomaly Detection Module
WS-SVC-ADM-1-K9=	Catalyst 6500 Cisco Anomaly Detection Module
WS-SVC-AGM-1-K9	Catalyst 6500 Cisco Anomaly Guard Module
WS-SVC-AGM-1-K9=	Catalyst 6500 Cisco Anomaly Guard Module
WS-SVC-CMM	Communication Media Module
WS-SVC-CMM-24FXS	24-port FXS Interface Port Adapter
WS-SVC-CMM-24FXS=	24-port FXS Interface Port Adapter
WS-SVC-CMM-6E1	6-port E1 Interface Port Adapter
WS-SVC-CMM-6E1=	6-port E1 Interface Port Adapter
WS-SVC-CMM-6T1	6-port T1 Interface Port Adapter
WS-SVC-CMM-6T1=	6-port T1 Interface Port Adapter
WS-SVC-CMM-ACT	Adhoc Conferencing and Transcoding PA

Ordering Information continued

Product Number	Product Description
Cisco 7600 Services Modules continued	
WS-SVC-CMM-ACT=	Adhoc Conferencing and Transcoding PA
WS-SVC-CMM-BLANK	CMM Module Blank Panel Cover
WS-SVC-CMM-BLANK=	CMM Module Blank Panel Cover
WS-SVC-CMM=	Communication Media Module
WS-SVC-IDS2-BUN-K9	600M IDSM-2 Mod for Catalyst
WS-SVC-IDS2BUNK9=	600M IDSM-2 Module, Spare
WS-SVC-FWM-1-K9	Firewall Blade for 6500 and 7600, VFW License Separate
WS-SVC-FWM-1-K9=	Firewall Blade for 6500 and 7600, VFW License Separate
WS-SVC-NAM-1	Catalyst 6500 Network Analysis Module-1
WS-SVC-NAM-1=	Catalyst 6500 Network Analysis Module-1
WS-SVC-NAM-2	Catalyst 6500 Network Analysis Module-2
WS-SVC-NAM-2=	Catalyst 6500 Network Analysis Module
WS-SVC-PSD-1	Persistent Storage Device
WS-SVC-PSD-1=	Persistent Storage Device
WS-X6066-SLB-APC	Catalyst 6000 Content Switching Module
WS-X6066-SLB-APC=	Catalyst 6500/7600 Content Switching Module
WS-X6066-SLB-S-K9	Content Switching Module with SSL Daughter Card
WS-X6066-SLB-S-K9=	Content Switching Module with SSL Daughter Card
WS-SVC-SSL-1-K9	SSL Module for Catalyst 6500
WS-SVC-SSL-1-K9=	SSL Module for Catalyst 6500
WS-SVC-SSL-CSM-K9=	Catalyst 6500 SSL and CSM Bundle
WS-SVC-MWAM-1	Multi-Processor WAN Application Module
WS-SVC-MWAM-1=	Multi-Processor WAN Application Module
WS-SVC-CSG-1	Content Services Gateway
WS-SVC-CSG-1=	Content Services Gateway
WS-SVC-WEBVPN-K9	SSL VPN Module for Catalyst 6500
WS-SVC-WEBVPN-K9=	SSL VPN Module for Catalyst 6500
SC-ADM-4.0-K9	Cisco Traffic Anomaly Detector Module MVP-OS R4.0 Software
SC-SBC-NAP-CSG1-1	No App Image For WS-SVC-CSG-1=
Cisco 7600 GBICs, Optics and Xenpaks	
WS-G5484	1000BASE-SX Short Wavelength GBIC (Multi-mode only)
WS-G5484=	1000BASE-SX Short Wavelength GBIC (Multi-mode only)
WS-G5486	1000BASE-LX/LH Long Haul GBIC (Single-mode or Multi-mode)
WS-G5486=	1000BASE-LX/LH Long Haul GBIC (Single-mode or Multi-mode)
WS-G5487	1000BASE-ZX Extended Reach GBIC (Single-mode)

Ordering Information continued

Product Number	Product Description
Cisco 7600 GBICs, Optics and Xenpaks continued	
WS-G5487=	1000BASE-ZX Extended Reach GBIC (Single-mode)
CWDM-GBIC-1470=	1000BASE-CWDM 1470nm GBIC (Single-mode only)
CWDM-GBIC-1490=	1000BASE-CWDM 1490nm GBIC (Single-mode only)
CWDM-GBIC-1510=	1000BASE-CWDM 1510nm GBIC (Single-mode only)
CWDM-GBIC-1530=	1000BASE-CWDM 1530nm GBIC (Single-mode only)
CWDM-GBIC-1550=	1000BASE-CWDM 1550nm GBIC (Single-mode only)
CWDM-GBIC-1570=	1000BASE-CWDM 1570nm GBIC (Single-mode only)
CWDM-GBIC-1590=	1000BASE-CWDM 1590nm GBIC (Single-mode only)
CWDM-GBIC-1610=	1000BASE-CWDM 1610nm GBIC (Single-mode only)
CWDM-MUX8A=	8-channels CWDM MUX/DEMUX Module
CWDM-OADM1-1470=	Dual Single Channel OADM Module (1470nm)
CWDM-OADM1-1490=	Dual Single Channel OADM Module (1490nm)
CWDM-OADM1-1510=	Dual Single Channel OADM Module (1510nm)
CWDM-OADM1-1530=	Dual Single Channel OADM Module (1530nm)
CWDM-OADM1-1550=	Dual Single Channel OADM Module (1550nm)
CWDM-OADM1-1570=	Dual Single Channel OADM Module (1570nm)
CWDM-OADM1-1590=	Dual Single Channel OADM Module (1590nm)
CWDM-OADM1-1610=	Dual Single Channel OADM Module (1610nm)
CWDM-OADM4-1=	4-channels CWDM OADM Module (1470, 1490, 1510, 1530)
CWDM-OADM4-2=	4-channels CWDM OADM Module (1550, 1570, 1590, 16100)
WDM-1300-1550-S=	1300nm/1550nm WDM Splitter Cable
CWDM-CHASSIS-2=	2-slot Chassis for CWDM Mux Plug in Modules
XENPAK-10GB-CX4	Cisco 10GBASE-CX4 XENPAK Module
XENPAK-10GB-LR	10GBASE-LR XENPAK Module
XENPAK-10GB-LR=	10GBASE-LR XENPAK Module
XENPAK-10GB-LX4	10GBASE-LX4 XENPAK Module
XENPAK-10GB-LX4=	10GBASE-LX4 XENPAK Module
XENPAK-10GB-SR	10GBASE-SR XENPAK Module
XENPAK-10GB-SR=	10GBASE-SR XENPAK Module
XENPAK-10GB-ZR	10GBASE-ZR XENPAK Module
XENPAK-10GB-ZR=	10GBASE-ZR XENPAK Module
GLC-LH-SM	GbE SFP, LC Connector LX/LH Transceiver
GLC-LH-SM=	GbE SFP, LC Connector LX/LH Transceiver
GLC-SX-MM	GbE SFP, LC Connector SX Transceiver
GLC-SX-MM=	GbE SFP, LC Connector SX Transceiver

Ordering Information continued

Product Number	Product Description
Cisco 7600 GBICs, Optics and Xenpaks continued	
GLC-SX-MM24	24 GLC-SX-MM SFP
GLC-ZX-SM	1000BASE-ZX SFP
GLC-ZX-SM=	1000BASE-ZX SFP
GLC-T	1000BASE-T SFP
GLC-T=	1000BASE-T SFP
GLC-T24	24 GLC-T SFP
SFP-GE-L	1000BASE-LX/LH SFP (DOM)
SFP-GE-L=	1000BASE-LX/LH SFP (DOM)
SFP-GE-S	1000BASE-SX SFP (DOM)
SFP-GE-S=	1000BASE-SX SFP (DOM)
SFP-GE-Z	1000BASE-ZX Gigabit Ethernet SFP (DOM)
SFP-GE-Z=	1000BASE-ZX Gigabit Ethernet SFP (DOM)
SFP-OC3-IR1	OC-3/STM-1 SFP, Single-mode Fiber, Intermediate Reach
SFP-OC3-IR1=	OC-3/STM-1 SFP, Single-mode Fiber, Intermediate Reach
SFP-OC3-LR1	OC-3/STM-1 SFP, Single-mode Fiber, Long Reach (40km)
SFP-OC3-LR1=	OC-3/STM-1 SFP, Single-mode Fiber, Long Reach (40km)
SFP-OC3-LR2	OC-3/STM-1 SFP, Single-mode Fiber, Long Reach (80km)
SFP-OC3-LR2=	OC-3/STM-1 SFP, Single-mode Fiber, Long Reach (80km)
SFP-OC12-IR1	OC-12/STM-4 SFP, Intermediate Reach (15km)
SFP-OC12-IR1=	OC-12/STM-4 SFP, Intermediate Reach (15km)
SFP-OC12-LR1	OC-12/STM-4 SFP, Long Reach (40km)
SFP-OC12-LR1=	OC-12/STM-4 SFP, Long Reach (40km)
SFP-OC12-LR2	OC-12/STM-4 SFP, Long Reach (80km)
SFP-OC12-LR2=	OC-12/STM-4 SFP, Long Reach (80km)
SFP-OC48-IR1	OC-48c/STM-16c
SFP-OC48-IR1=	OC-48c/STM-16c
SFP-OC48-SR	OC-48c/STM-16c SFP, Short Reach
SFP-OC48-SR=	OC-48c/STM-16c SFP, Short Reach
XFP-10GLR-OC192SR	Multirate XFP Module for 10GBASE-LR and OC-192 SR-1
XFP-10GLR-OC192SR=	Multirate XFP Module for 10GBASE-LR and OC-192 SR-1
XFP-10GZR-OC192LR	10GBASE-ZR and OC-192 LR2 XFP Module
XENPAK-10GB-LW	10GBASE-LW XENPAK Module
XENPAK-10GB-LW=	10GBASE-LW XENPAK Module

Notes



Cisco Catalyst 6500 Series

The Cisco Catalyst® 6500 sets the new standard for IP Communications, MPLS networks and application delivery in enterprise campus and service provider networks. The Catalyst 6500 Series delivers scalable, secure, converged, L2 and L3 services, from the data center and campus to the WAN aggregation and the Internet edge.

Delivering scalable performance and port density with investment protection across several chassis configurations and LAN, WAN, and MAN interfaces, the Catalyst 6500 Series switches feature an unparalleled range of integrated services modules, including multi-gigabit network security, content switching, telephony, and network analysis modules.

The Catalyst 6500 Series delivers a consistent network operating environment through an architecture that uses a common set of modules and Cisco IOS software across all models. This helps to optimize IT infrastructure usage and enhance return on investment. With connectivity for services ranging from DS0 to OC-192, and nx10-Mbps Ethernet to high-density 10 Gigabit Ethernet, the Catalyst 6500 Series with IOS software modularity maximizes network uptime with stateful failover capability between redundant routing and forwarding engines.

The Cisco Catalyst 6500 Series demonstrates an ongoing commitment to innovation with numerous industry-leading features. Support for Flexible Packet Matching and Application Intelligence in hardware is the latest example of Catalyst 6500 Series innovation, benefiting WAN service aggregation and Internet edge deployments by securing the enterprise network against attack, as well as monitoring and prioritizing mission-critical applications versus discretionary traffic for maximum business efficiency.

Benefits and Advantages

Maximum Network Uptime

Cisco IOS Software Modularity, together with platform, power supply, supervisor engine, switch fabric, and integrated services redundancy provides one-to-three second stateful failover, and delivers application and services continuity in a converged network. The Cisco Catalyst 6500 Series with Cisco IOS Software Modularity boosts operational efficiency and minimizes downtime by enabling modular Cisco IOS subsystems to run in independent processes. This minimizes unplanned downtime through self-healing processes, simplifies software changes through subsystem In-Service Software Upgrades (ISSU), and enables process-level, automated policy control by integrating Cisco Embedded Event Manager (EEM).

Benefits and Advantages continued

Integrated Security

A comprehensive portfolio of proven and integrated multi-gigabit security services modules are available with the Catalyst 6500 Series. Integrated network security simplifies operations and reduces total cost of ownership. Cisco Catalyst 6500 security service modules include intrusion detection, firewall, scalable IPsec VPN solutions and Secure Sockets Layer (SSL).

Services Integration and Flexibility

Catalyst 6500 Series application intelligence with PISA technology helps ensure application performance and security in converged data, voice, video, and wireless Campus and WAN environments. Catalyst 6500 supports a wide range of integrated and advanced services such as security, wireless LAN, and Layer 4-7 content services; provides the widest range of interfaces and densities from 10/100/1000 Ethernet to 10 Gigabit, and DS-0 to OC-192; and performs in deployments from the data center, to the Campus and WAN edge.

Scalable Performance

Cisco Catalyst 6500 Series provides up to 400 Mpps performance with a distributed forwarding architecture that supports a mix of Cisco Express Forwarding implementations and switch-fabric speeds for optimal data center, campus, and WAN edge deployments, as well as service provider networks. Catalyst 6500 Series provides consistent and scalable routing services to maximize application performance to branch offices over the WAN with advanced IOS routing solutions.

Operational Consistency

Featuring 3-, 4-, 6-, 9-, and 13-slot chassis configurations, Catalyst 6500 Series shares a common set of modules, Cisco IOS Software, Cisco Catalyst Operating System Software, and network management tools. Catalyst 6500 Series can be deployed across the network from the core network to the WAN and Internet edge, simplifying network operations and reducing spares expense.

Validated Solutions

All Cisco Catalyst 6500 Series applications are tested in Safe Harbor, with the recent addition of enterprise WAN applications for an end-to-end tested solution.

Features Section

Operational Consistency

- Shares WAN SIP and SPA modules with Cisco 7304 Router, 7600, 10000, 12000 Series and CRS-1 to reduce sparring and training costs
- Shares WAN port adapters with Cisco 7500 Series routers for smooth migration and investment protection
- Cisco IOS Software and Cisco Catalyst Operating System Software supported on all supervisor engines, providing smooth migration from Cisco 7500 Series deployments; comprehensive CatOS to IOS migration tool
- Investment Protection with support for three generations of interchangeable, hot-swappable modules in the same chassis

Network Uptime and Resiliency

- Cisco Catalyst 6500 Series with Cisco IOS Software Modularity boosts operational efficiency and minimizes downtime
- Provides packet-loss protection and the fastest recovery from network disruption
- Offers optional, redundant, high-performance Cisco Catalyst 6500 Series Supervisor Engine 720, passive backplane, multimodule Cisco EtherChannel technology, IEEE 802.3ad link aggregation, IEEE 802.1s only, and Hot Standby Router Protocol/Virtual Router Redundancy Protocol (HSRP/VRRP) high-availability features

Features Section continued

Integrated High-Performance Network Security

Integrated gigabit-per-second services modules, simplify network management and reduce TCO. These include:

- Firewall Services Module provides access security
- Intrusion Detection System (IDS) Services Module provides intrusion detection and prevention services
- Network Analysis Service Module provides network traffic visibility with full Remote Monitoring (RMON) support and graphical reporting capability
- SSL Service Module provides high-performance, secure e-commerce traffic termination
- IPsec VPN Shared Port Adapter (SPA) provides secure, cost-efficient connectivity, with support for Cisco advanced IPsec VPN solutions such as Dynamic Multipoint VPN and Easy VPN.
- Advanced Encryption Standard (AES) 128, 192, and 256; Triple Data Encryption Standard (3DES); and DES cryptology support.

Content and Application Services

- Catalyst 6500 Supervisor Engine 32 PISA (Programmable Intelligent Services Accelerator) monitors, classifies, and controls application traffic in the campus and at the WAN edge. Hardware accelerated Network-Based Application Recognition (NBAR) enhances network management and bandwidth utilization
- Content Switching Module (CSM) delivers high-performance, feature-rich server and firewall load balancing to ensure a safer and more manageable infrastructure with unprecedented control
- Integrated SSL acceleration, combined with CSM, provides a high-performance e-commerce solution
- Integrated firewall and CSM provides a secure, high-performance, data center solution

Layer 3 Services

- Multiprotocol Layer 3 routing support with scalable routing table support in hardware
- IPv6 support in hardware with comprehensive services
- Multiprotocol Label Switching (MPLS) in hardware with comprehensive L2-L3 VPN services
- VPLS and H-VPLS support
- EoMPLS/VPLS over GRE (SXI)

Data, Voice, and Video Services

- Integrated IP Communications support in all Cisco Catalyst 6500 Series platforms
- 10/100 and 10/100/1000 line cards; field-upgradable with inline power
- IEEE 802.3af Power over Ethernet (PoE) support; Cisco Inline Power support
- Dense T1/E1 and FXS, voice interfaces for PSTN access and phone, fax, and PBX connections
- High-performance IP Multicast video and audio application support
- Integrated management systems

Interface Flexibility, Scalability, and Density

- Port density and interface options for data center, campus, and WAN/Internet edge deployments
- Broad range of high-speed WAN, ATM, and SONET interfaces
- Support for up to 576 10/100/1000 gigabit-over-copper ports or 1152 10/100 Ethernet ports
- 96-port 10/100 RJ-45 module, with optional field-upgrade to 802.3af PoE
- Support for up to 192 Gigabit Ethernet ports
- 10 Gigabit Ethernet, Channelized OC-48 dense OC-3 Packet over SONET (POS)
- Single-device management for WAN aggregation, campus, and metro connectivity
- Layer 3 routing and forwarding with upgradable supervisor engines

Metro Ethernet WAN

- 802.1Q and 802.1Q tunneling (QinQ) for point-to-point and multipoint Ethernet services
- Ethernet over MPLS with VLAN translation capability
- Layer 2 - Layer 3 Quality of Service (QoS) with rate limiting and traffic shaping
- High-availability features - enhanced Spanning Tree Protocol, IEEE 802.1s, IEEE 802.1w, and Cisco EtherChannel IEEE 802.3ad link aggregation

For updated feature and hardware support please refer to the release notes at: http://www.cisco.com/en/US/docs/switches/lan/catalyst6500/ios/12.2SX/release/notes/ol_14271.html

When to Deploy

The Catalyst 6500 Series is ideal for addressing high-performance applications such as:

- Enterprise WAN Service Aggregation
- Leased Line Aggregation
- IP/MPLS Provider Edge or Provider router
- MPLS HA
- Metro Ethernet
- High-end CPE

Application Example

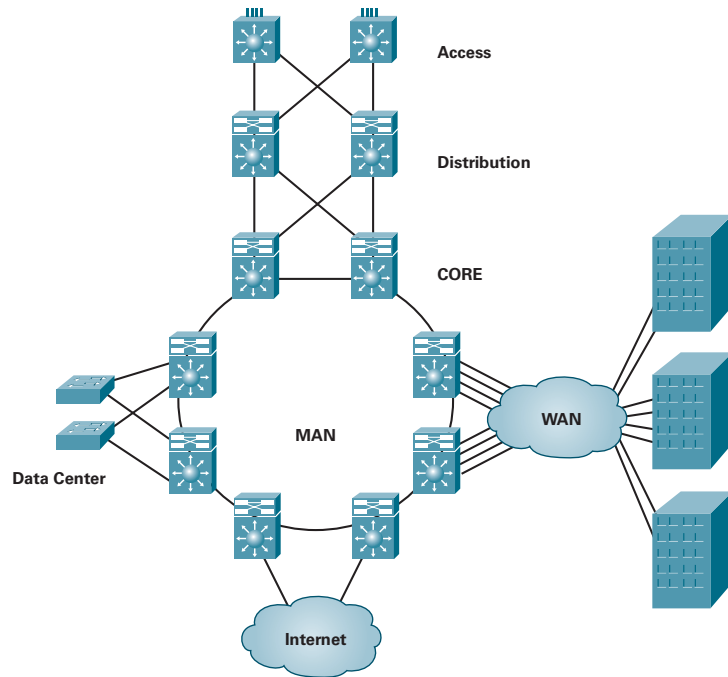

Platform Overview

Feature	Cisco 6503-E	Cisco 6504-E	Cisco 6506-E	Cisco 6509-E	Cisco 6513
Fixed Ports	SFP, 10GbE X2 & 10/100/1000	Same as 503-E	Same as 503-E	Same as 6503-E	Same as 503-E
Expansion Slots	3 (horizontal)	4 (horizontal)	6 (horizontal)	9 (horizontal)	13 (horizontal)
WAN Interface Range	DS0 to OC-192	DS0 to OC-192	DS0 to OC-192	DS0 to OC-192	DS0 to OC-192

Platform Overview continued

Feature	Cisco 6503-E	Cisco 6504-E	Cisco 6506-E	Cisco 6509-E	Cisco 6513
Fixed Ports	SFP, 10GbE X2 & 10/100/1000	Same as 503-E	Same as 503-E	Same as 6503-E	Same as 503-E
Expansion Slots	3 (horizontal)	4 (horizontal)	6 (horizontal)	9 (horizontal)	13 (horizontal)
WAN Interface Range	DS0 to OC-192	DS0 to OC-192	DS0 to OC-192	DS0 to OC-192	DS0 to OC-192
Processor	Supervisor 32 Supervisor 32 PISA Supervisor 720-3B Supervisor-3BXL	Same as 6503-E	Same as 6503-E	Same as 6503-E	Same as 6503-E
Forwarding Rate	Up to 30 Mpps	Same as 503-E	Same as 503-E	Same as 6503-E	Same as 503-E
Backplane Capacity	240 Gpbs	320 Gpbs	480 Gpbs	720 Gpbs	720 Gpbs
Flash	Up to 512 MB	Same as 503-E	Same as 503-E	Same as 6503-E	Same as 503-E
PCMCIA Memory	Sup32 Up to 1G on Sup720				
System DRAM Memory	Up to 512 MB on Sup32 Up to 1G on Sup720	Same as 503-E	Same as 503-E	Same as 6503-E	Same as 503-E
Internal Power Supply	AC or DC	Same as 503-E	Same as 503-E	Same as 6503-E	Same as 503-E
RPS Support	Yes	Same as 503-E	Same as 503-E	Same as 6503-E	Same as 503-E
Chassis Height	4 RU	5 RU	12 RU	15 RU	20 RU
Dimensions (H x W x D)	7 x 1737 x 21.75 in.	4.25 x 170 x 4.5 in.	19.2 x 175 x 18.2 in.	24.5 x 175 x 18.2 in.	33.3 x 173 x 18.1 in.

Ordering Information

Product Number	Product Description
Cisco 6513 Systems	
WS-C6513	Catalyst 6500 13-slot Chassis, 20 RU, no Power Supply, no Fan Tray
WS-C6513-S32-GE	Catalyst 6513 Chassis, WS-SUP32-GE-3B, Fan Tray (Requires Power Supply)
WS-C6513-S32-10GE	Catalyst 6513 Chassis, WS-SUP32-10GE-3B, Fan Tray (Requires Power Supply)
WS-C6513-VPN+K9	Catalyst 6513 IPsec VPN SPA Security System
WS-C6513-FWM-K9	Catalyst 6513 Firewall Security System
WS-C6513-CSM	CSM, 6513, Sup720 Bundle
WS-C6513-CSMS-K9	CSM-S, 6513, Sup720 Bundle

Ordering Information continued

Product Number	Product Description
Cisco 6509-E Systems	
WS-C6509-E	Catalyst 6500 Enhanced 9-slot Chassis, 15 RU, no Power Supply, no Fan Tray
WS-C6509E-S32-GE	Catalyst 6509-E Chassis, WS-SUP32-GE-3B, Fan Tray, (Requires Power Supply)
WS-C6509E-S32-10GE	Catalyst 6509-E Chassis, WS-SUP32-10GE-3B, Fan Tray, (Requires Power Supply)
WS-C6509-E-PFC2	Catalyst 6509-E Chassis, FAN TRAY, Sup2-PFC2, no Power Supply
WS-C6509-E-VPN+K9	Catalyst 6509-E IPsec VPN SPA Security System
WS-C6509-E-FWM-K9	Catalyst 6509-E Firewall Security System
WS-C6509-E-ACE-K9	ACE 8G 6509 Bundle
WS-C6509-E-WISM	Catalyst 6509-E WiSM Bundle (SUP720-3B, WiSM, Fan Tray, no Power Supply)
WS-C6509E-CSM	CSM, 6509, Sup720 Bundle
WS-C6509E-CSMS-K9	CSM-S, 6509, Sup720 Bundle
Cisco 6506-E Systems	
WS-C6506-E	Catalyst 6500 Enhanced 6-slot Chassis, 12 RU, no Power Supply, no Fan Tray
WS-C6506E-S32-GE	Catalyst 6506-E, WS-SUP32-GE-3B, Fan Tray (Requires Power Supply)
WS-C6506E-S32-10GE	Catalyst 6506-E chassis, WS-SUP32-10GE-3B, Fan Tray (Requires Power Supply)
WS-C6506-E-PFC2	Catalyst 6506E, Sup2-PFC2, Fan Tray, no Power Supply
WS-C6506E-IPS10GK9	6506E+4 x IDSM2+ Sup32 + 2 10GbE XENPAKs and Power
WS-C6506E-IPSF-K9	6506E+4 x IDSM2+ Sup32 + 8 Fiber SFP and Power
WS-C6506-E-VPN+K9	Catalyst 6506E IPsec VPN SPA Security System
WS-C6506-E-FWM-K9	Catalyst 6506E Firewall Security System
WS-C6506-E-WLSM	Catalyst 6506 with WLSM Bundle
Cisco 6504-E Systems	
WS-C6504-E	Catalyst 6500 Enhanced 4-slot Chassis, 5 RU, no Power Supply, no Fan Tray
WS-C6504E-S32-GE	6504-E Chassis + Fan Tray + Sup32-GE
WS-C6504E-S32-10GE	6504-E Chassis + Fan Tray + Sup32-10GE
WS-C6504-E-VPN+K9	Catalyst 6504-E IPsec VPN SPA Security System
WS-C6504-E-ACE-K9	ACE 4G 6504 Bundle
WS-C6504-E-WISM	Catalyst 6504-E WiSM Bundle (SUP720-3B, WiSM, Fan Tray, (2) Power Supply)
Cisco 6503-E Systems	
WS-C6503-E	Catalyst 6500 Enhanced 3-slot Chassis, 4 RU, no Power Supply, no Fan Tray
WS-C6503E-S32-GE	Catalyst 6503-E, WS-SUP32-GE-3B, Fan Tray (Requires Power Supply)
WS-C6503E-S32-10GE	Catalyst 6503-E Chassis, WS-SUP32-10GE-3B, Fan Tray (Requires Power Supply)
WS-C6503-E-FWM-K9	Cisco Catalyst 6503-E Firewall Security System
WS-C6503-E-WLSM	Catalyst 6503 with WLSM Bundle

Ordering Information continued

Product Number	Product Description
Cisco 6503-E Systems continued	
WS-C6503E-CSM	CSM, 6503, Sup720 Bundle
WS-C6503E-CSMS-K9	CSM-S, 6503, Sup720 Bundle
Cisco 6500 FlexWAN Modules and Port Adapter Modules	
WS-X6582-2PA=	Cisco 7600/Catalyst 6500 Enhanced FlexWAN, Fabric-enabled
PA-4T+	4-port Serial Port Adapter, Enhanced
PA-8T-V35	8-port Serial, V35 Port Adapter
PA-8T-232	8-port Serial, 232 Port Adapter
PA-8T-X21	8-port Serial, X.21 Port Adapter
PA-MC-2T1	2-port Multi-channel T1 Port Adapter with Integrated CSU/DSUs
PA-MC-4T1	4-port Multi-channel T1 Port Adapter with Integrated CSU/DSUs
PA-MC-8T1	8-port Multi-channel T1 8PRI Port Adapter
PA-MC-8TE1+	8-port Multi-channel T1/E1 8PRI Port Adapter
PA-MC-8E1/120	8-port Multi-channel E1 Port Adapter with G.703 120 ohm Interface
PA-MC-2E1/120	2-port Multi-channel E1 Port Adapter with G.703 120 ohm Interface
PA-4E1G/75	4-port E1 G.703 Serial Port Adapter (75 ohm/Unbalanced)
PA-4E1G/120	4-port E1 G.703 Serial Port Adapter (120 ohm/Balanced)
PA-T3	1-port T3 Serial Port Adapter
PA-T3+	1-port T3 Serial Port Adapter Enhanced
PA-E3	1-port E3 Serial Port Adapter with E3 DSU
PA-2T3	2-port T3 Serial Port Adapter
PA-2T3+	2-port T3 Serial Port Adapter Enhanced
PA-2E3	2-port E3 Serial Port Adapter with E3 DSUs
PA-MC-T3	1-port Multi-channel T3 Port Adapter
PA-MC-2T3+	2-port Multi-channel T3 Port Adapter
PA-MC-E3	1-port Multi-channel E3 Port Adapter
PA-MC-STM-1MM	1-port Multi-channel STM-1 Multi-mode Port Adapter
PA-MC-STM-1SMI	1-port Multi-channel STM-1 Single-mode Port Adapter
PA-T3	1-port T3 Serial Port Adapter
PA-T3+	1-port T3 Serial Port Adapter Enhanced
PA-E3	1-port E3 Serial Port Adapter with E3 DSU
PA-2T3	2-port T3 Serial Port Adapter
PA-2T3+	2-port T3 Serial Port Adapter Enhanced
PA-2E3	2-port E3 Serial Port Adapter with E3 DSUs
PA-MC-T3	1-port Multi-channel T3 Port Adapter

Ordering Information continued

Product Number	Product Description
Cisco 6500 FlexWAN Modules and Port Adapter Modules <small>continued</small>	
PA-MC-2T3+	2-port Multi-channel T3 Port Adapter
PA-MC-E3	1-port Multi-channel E3 Port Adapter
PA-MC-STM-1MM	1-port Multi-channel STM-1 Multi-mode Port Adapter
PA-MC-STM-1SMI	1-port Multi-channel STM-1 Single-mode Port Adapter
PA-A3-T3	1-port ATM Enhanced DS3 Port Adapter
PA-A3-E3	1-port ATM Enhanced E3 Port Adapter
PA-A3-OC3MM	1-port ATM Enhanced OC-3c/STM-1 Multi-mode Port Adapter
PA-A3-OC3SMI	1-port ATM Enhanced OC-3c/STM-1 Single-mode (IR) Port Adapter
PA-A3-OC3SML	1-port ATM Enhanced OC-3c/STM-1 Single-mode (LR) Port Adapter
PA-A3-8T1IMA	8-port ATM Inverse Mux T1 Port Adapter
PA-A3-8E1IMA	8-port ATM Inverse Mux E1 (120 ohm) Port Adapter
PA-A6-OC3MM	1-port Enhanced ATM OC-3c/STM-1 Multi-mode Port Adapter (8k VCs)
PA-A6-OC3SMI	1-port Enhanced ATM OC-3c/STM-1 Single-mode (IR) Port Adapter
PA-A6-T3	1-port Enhanced ATM DS3 Port Adapter (8k VCs)
PA-A6-E3	1-port Enhanced ATM E3 Port Adapter (8k VCs)
PA-POS-OC3MM	1-port POS OC-3SM/STM-1 Multi-mode Port Adapter
PA-POS-OC3SMI	1-port POS OC-3SM/STM-1 Single-mode Intermedia Reach Port Adapter
PA-POS-OC3SML	1-port POS OC-3SM/STM-1 Single-mode Long Reach Port Adapter
PA-POS-2OC3	2-port POS OC-3c/STM-1 Port Adapter
PA-POS-2OC3MM	2-port POS OC-3SM/STM-1 Multi-mode Port Adapter
PA-POS-2OC3SMI	2-port POS OC-3SM/STM-1 Single-mode Intermedia Reach Port Adapter
PA-POS-2OC3SML	2-port POS OC-3SM/STM-1 Single-mode Long Reach Port Adapter
PA-H	1-port HSSI Port Adapter
PA-2H	2-port HSSI Port Adapter
PA-FE-TX	1-port Fast Ethernet Port Adapter
PA-FE-FX	1-port Fast Ethernet Port Adapter, Fiber
PA-2FE-TX	2-port Fast Ethernet Port Adapter
PA-2FE-FX	2-port Fast Ethernet Port Adapter, Fiber

Ordering Information continued

Product Number	Product Description
Cisco 7600 and Catalyst 6500 SIP Modules and SPA Modules	
7600-SIP-200=	Cisco 7600/6500 Series SPA Interface Processor-200
7600-SIP-400=	Cisco 7600/6500 Series SPA Interface Processor-400
7600-SIP-600=	Cisco 7600/6500 Series SPA Interface Processor-600
SPA-2XOC3-ATM=	2-port OC-3c/STM-1 ATM Shared Port Adapter
SPA-2XOC3-POS=	2-port OC-3/STM-1 POS Shared Port Adapter
SPA-4XOC3-ATM=	4-port OC-3c/STM-1 ATM Shared Port Adapter
SPA-1XCHSTM1/OC3=	1-port Channelized STM-1/OC-3c to DS0 Shared Port Adapter
SPA-1XOC12-POS=	1-port OC-12/STM-4 POS Shared Port Adapters
SPA-1XOC12-ATM=	1-port OC-12c/STM-4 ATM Shared Port Adapter
SPA-1XOC48POS/RPR=	1-port OC-48/STM-16 POS/RPR Shared Port Adapters
SPA-2XT3/E3=	2-port Clear Channel T3/E3 Shared Port Adapter
SPA-4XT3/E3=	4-port Clear Channel T3/E3 Shared Port Adapter
SPA-4X1FE-TX-V2=	4-port Fast Ethernet (TX) Shared Port Adapter
SPA-2XCT3/DS0=	2-port Channelized T3 to DS0 Shared Port Adapter
SPA-4XCT3/DS0=	4-port Channelized T3 to DS0 Shared Port Adapter
SPA-1XOC48-ATM=	1-port OC-48c/STM-16 ATM Shared Port Adapter
SPA-1XTENGE-XFP=	1-port 10 Gigabit Ethernet Shared Port Adapter XFP-based
SPA-2X1GE=	2-port Gigabit Ethernet Shared Port Adapter
SPA-5X1GE=	5-port Gigabit Ethernet Shared Port Adapter
SPA-8XCHT1/E1=	8-port Channelized T1/E1 to DS0 Shared Port Adapter
SPA-8X1FE-TX-V2=	8-port Fast Ethernet (TX) Shared Port Adapter
SPA-10X1GE=	10-port Gigabit Ethernet Shared Port Adapter
SPA-OC192POS-LR=	1-port OC-192/STM-64 POS/RPR SMLR Optics
SPA-OC192POS-VSR=	1-port OC-192/STM-64 POS/RPR VSR Optics
SPA-OC192POS-XFP=	1-port OC-192/STM-64 POS/RPR XFP Optics
WS-X6704-10GE=	4-port 10 Gigabit Ethernet Module (Requires XENPAKs)
WS-X6708-10G-3C=	8-port 10 Gigabit Ethernet Module with DFC3C (Requires X2)
WS-X6708-10G-3CXL=	8-port 10 Gigabit Ethernet Module with DFC3CXL (Requires X2)
WS-X6516A-GBIC=	16-port GbE Module, Fabric-enabled (Requires GBICs)
WS-X6724-SFP=	24-port GbE Module, Fabric-enabled (Requires SFPs)
WS-X6748-SFP=	48-port CEF720 GbE Module (Requires SFPs)
WS-X6748-GE-TX=	48-port 10/100/1000 GbE Module, Fabric-enabled, RJ-45
WS-X6148X2-RJ-45=	96-port 10/100 (RJ-45), Upgradable to PoE 802.3af
WS-X6148X2-45AF=	96-port PoE 802.3af 10/100 (RJ-45) Line Card

Ordering Information continued

Product Number	Product Description
Cisco 7600 and Catalyst 6500 SIP Modules and SPA Modules <small>continued</small>	
WS-X6816-GBIC=	16-port GbE Module, 2 Fabric I/F, (Requires GBICs, DFC/DFC3)
WS-X6516-GE-TX=	16-port 10/100/1000 GbE Module, Cross-Bar, Spare
WS-X6548-RJ-21=	48-port 10/100, RJ-21, Fabric-enabled
WS-X6548-RJ-45=	48-port 10/100, RJ-45, Cross-bar
WS-X6524-100FX-MM=	24-port 100FX, MT-RJ, Fabric-enabled
WS-SVC-WISM-1-K9=	Wireless Services Module (WiSM)
WS-SVC-FWM-1-K9=	Firewall Blade for 6500 and 7600, VFW License Separate
WS-SVC-IDS2BUNK9=	IDS-2 600M Module, Spare
WS-SVC-WEBVPN-K9=	SSL VPN Module for Catalyst 6500
7600-SSC-400=	Cisco 7600/Catalyst 6500 Services SPA Carrier Card
ACE10-6500-K9	Application Control Engine (ACE) Module
WS-SVC-IPSEC-1=	IPsec VPN Security Module for 6500 and 7600 Series
SPA-IPSEC-2G=	Cisco 7600/Catalyst 6500 IPsec VPN SPA - DES/3DES/AES
WS-SVC-ADM-1-K9=	Catalyst 6500 Cisco Anomaly Detection Module
WS-SVC-AGM-1-K9=	Catalyst 6500 Cisco Anomaly Guard Module
WS-SVC-AON-1-K9	Application-oriented Networking (AON) Module
WS-X6066-SLB-S-K9=	Content Switching Module with SSL Daughter Card
WS-X6066-SLB-APC=	Catalyst 6500/7600 Content Switching Module
WS-SVC-SSL-1-K9=	SSL Module for Catalyst 6500
WS-SVC-NAM-1=	Catalyst 6500 Network Analysis Module-1
WS-SVC-NAM-2=	Catalyst 6500 Network Analysis Module
WS-SVC-WLAN-1-K9=	Wireless LAN Services Module, CEF256
WS-SVC-CMM=	Communication Media Module
WS-SVC-CSG-1=	Content Services Gateway
WS-SVC-MWAM-1=	Multi-processor WAN Application Module
WS-SVC-PSD-1=	Persistent Storage Device

Notes

Cisco Interface Card Compatibility Quick Look

3825	2851	1841
3845	2821	
	2811	
	2801	

Serial WICs

WIC-1T 1-port serial WIC	•	•	•
WIC-2T 2-port serial WIC	•	•	•
WIC-1DSU-T1-V2 1-port T1/fractional T1 DSU/CSU WIC	•	•	•
WIC-1DSU-56K4 1-port 4-wire 56/64 Kbps WIC	•	•	•
WIC-2A/S 2-port asynchronous/synchronous serial WIC	•	•	•
HWIC-4T 4-port serial high-speed WAN interface card	•	•	
HWIC-16A 16-port asynchronous high-speed WAN interface card	•	•	
HWIC-4A/S 4-port asynchronous/synchronous high-speed WAN interface card	•	•	•
HWIC-8A/S-232 8-port asynchronous/synchronous high-speed WAN interface card	•	•	•
HWIC-8A 8-port asynchronous high-speed WAN interface card	•	•	•

ISDN BRI WICs

WIC-1B-S/T-V3 1-port ISDN WIC (dial and leased line)	•	•	•
WIC-1B-U-V2 1-port ISDN with NT-1 WIC (dial and leased line)	•	•	•

Cisco Interface Card Compatibility Quick Look continued

3825	2851	1841
3845	2821	
	2811	
	2801	

DSL WICs and HWICs

WIC-1ADSL 1-port ADSL WIC	•	•	•
WIC-1ADSL-DG 1-port ADSL WIC with Dying Gasp	•	•	•
WIC-1ADSL-I-DG 1-port ADSLoSDN WIC with Dying Gasp	•	•	•
WIC-1SHDSL-V3 1-port G.SHDSL WIC (2 or 4 wire only)	•	•	•
HWIC-1ADSL HWIC with ADSL over POTS	•	•	•
HWIC-1ADSLI HWIC with ADSL over ISDN	•	•	•
HWIC-ADSL-B/ST HWIC with ADSL over POTS and ISDN BRI ports	•	•	•
HWIC-ADSLI -B/ST HWIC with ADSL over POTS and ISDN BRI ports	•	•	•

Cable (DOCSIS-based) HWICs

HWIC-CABLE-D-2 1-port DOCSIS-based Cable HWIC	•	•	•
HWIC-CABLE-E/J-2 1-port Euro/J-DOCSIS-based Cable HWIC	•	•	•

Analog Modem WICs

WIC-1AM-V2 1-port analog modem WIC	•	•	•
WIC-2AM-V2 2-port analog modem WIC	•	•	•

Ethernet and High-Speed Switching WICs

HWIC-4ESW 4-port Fast Ethernet switch HWIC	•	•	•
HWIC-4ESW-POE 4-port Power over Ethernet (PoE)-ready, Fast Ethernet switch HWIC	•	•	•
IPLM-4= 4-port inline power module, spare	•	•	
HWIC-D-9ESW 9-port double-wide, Fast Ethernet switch HWIC	•	•	
HWIC-D-9ESW-POE 9-port double-wide, Power over Ethernet (PoE)-ready, Fast Ethernet switch HWIC	•	•	
IPLM-8= 8-port Inline power module, spare	•	•	

Cisco Interface Card Compatibility Quick Look continued

3825	2851	1841
3845	2821	
	2811	
	2801	

Ethernet and High-Speed Switching WICs continued

HWIC-1FE 1-port Layer 3 Fast Ethernet	•	•	•
HWIC-2FE 1-port Layer 3 Fast Ethernet	•	•	•
HWIC-1GE-SFP 1-port Gigabit Ethernet	•	2811, 2821, 2851 only	

T1, E1, T1/E1, and G.703 Multiflex Trunk Voice and WAN Interface Cards

WVIC-1MFT-T1 1-port RJ-48 multiflex trunk – T1	•	•	•
WVIC2-1MFT-T1/E1 1-port second-gen multiflex trunk voice/WAN Interface Card - G.703	•	•	•
WVIC-2MFT-T1 2-port RJ-48 multiflex trunk – T1	•	•	•
WVIC2-2MFT-T1/E1 2-port second-gen multiflex trunk voice/WAN Interface Card - T1/E1	•	•	•
WVIC-2MFT-T1-DI 2-port RJ-48 multiflex trunk – T1 with drop and insert	•	•	•
WVIC-1MFT-E1 1-port RJ-48 multiflex trunk – T1	•	•	•
WVIC-2MFT-E1 2-port RJ-48 multiflex trunk – T1	•	•	•
WVIC-2MFT-E1-DI 2-port RJ-48 multiflex trunk – E1 with drop and insert	•	•	•
WVIC-1MFT-G703 1-port RJ-48 multiflex trunk – G.703	•	•	•
WVIC2-1MFT-G703 1-port second-gen multiflex trunk voice/WAN Interface Card - G.703	•	•	•
WVIC-2MFT-G703 2-port RJ-48 multiflex trunk – G.703	•	•	•
WVIC2-2MFT-G703 2-port second-gen multiflex trunk voice/WAN Interface Card - G.703	•	•	•

Multiflex Trunk Dedicated Echo Cancellation Modules

(requires appropriate Multiflex Trunk Voice/WAN Interface Card)

EC-MFT-32* 32 channel multiflex trunk dedicated echo cancellation module	•	•	
EC-MFT-64* 64 channel multiflex trunk dedicated echo cancellation module	•	•	

Cisco Interface Card Compatibility Quick Look continued

3825	2851	1841
3845	2821	
	2811	
	2801	

Analog Voice Interface Cards

VIC-2DID 2-port DID (direct inward dial) voice/fax interface card	•	•
VIC2-2FXS 2-port voice interface card – FXS	•	•
VIC2-2FXO 2-port voice interface card – FXO (universal for all countries, also supports CAMA)	•	•
VIC2-4FXO 4-port voice interface card – FXO (universal for all countries)	•	•
VIC2-2E/M 2-port voice interface card – E and M	•	•
VIC-4FXS/DID 4-port FXS/DID (direct inward dial) voice/fax interface card	•	•

ISDN BRI Voice Interface Cards

VIC2-2BRI-NT/TE 2-port voice interface card – BRI (NT and TE)	•	•
---	---	---

Cisco Advanced Integration Module Compatibility Quick Look

3825	2851	1841
3845	2821	
	2811	
	2801	

Compression Advanced Integration Modules

AIM-COMPR4 Compression advanced integration module for Cisco 3660	•		
AIM-COMPR2-V2 Compression advanced integration module for Cisco 2600		2811, 2821, 2851 only	

VPN and Encryption Advanced Integration Modules

AIM-VPN/SSL-3: DES/3DES/AES VPN encryption and compression AIM – high performance	3845 only		
AIM-VPN/SSL-3: DES/3DES/AES VPN encryption and compression AIM – enhanced performance	3825 only	•	
AIM-VPN/SSL-1: DES/3DES/AES VPN encryption and compression AIM – basic performance			•
AIM-VPN/SSL-1 DES/3DES/AES/SSL VPN Encryption/Compression			•
AIM-VPN/SSL-2 DES/3DES/AES/SSL VPN Encryption/Compression		•	
AIM-VPN/SSL-3 DES/3DES/AES/SSL VPN Encryption/Compression	•		

Voice-mail Advanced Integration Modules

AIM-CUE High-performance	6 ports	6 ports
------------------------------------	---------	---------

Cisco Advanced Integration Module Compatibility Quick Look *continued*

3825	2851	1841
3845	2821	
	2811	
	2801	

ATM Advanced Integration Modules

AIM-ATM High-performance ATM segmentation and reassembly (SAR) advanced integration module	.	2811, 2821, 2851 only
AIM-ATM-1E1 High-performance E1 ATM bundle, one AIM-ATM and one VVIC-1MFT-E1	.	2811, 2821, 2851 only
AIM-ATM-1T1 High-performance T1 ATM bundle, one AIM-ATM and one VVIC-1MFT-T1	.	2811, 2821, 2851 only
AIM-ATM-1T1/E1 High performance T1/E1 ATM bundle, one VVIC2-1MFT-T1/E1 and one AIM-ATM	.	2811, 2821, 2851 only
AIM-ATM-4E1 High-performance E1 ATM bundle, two VVIC-2MFT-E1 and one AIM-ATM	.	2811, 2821, 2851 only
AIM-ATM-4T1 High-performance T1 ATM bundle, two VVIC-2MFT-T1 and one AIM-ATM	.	2811, 2821, 2851 only
AIM-ATM-4T1/E1 High performance T1/E1 ATM bundle, two VVIC2-2MFT-T1/E1 and one AIM-ATM	.	2811, 2821, 2851 only

Cisco Port Adapter
Compatibility Quick Look

7200 VXR	7201	7301	7304 Carrier Card (VIP4/VIP6)	7500 VIP4/VIP6	7600 Enhanced FlexWAN	6500 Enhanced FlexWAN
----------	------	------	----------------------------------	-------------------	-----------------------------	-----------------------------

ATM Port Adapters

PA-A3-8T1/MA 8-port ATM inverse Mux T1 port adapter
PA-A6-OC3SMI 1-port ATM-enhanced OC-3c/ STM-1 Singlemode (IR) port adapter
PA-A6-OC3SML 1-port ATM-enhanced OC-3c/ STM-1 Singlemode (LR) port adapter
PA-A6-E3 1-port ATM-enhanced E3 port adapter (8k VCs)

Cisco Port Adapter Compatibility Quick Look continued							
PA-A6-T3 1-port ATM-enhanced DS3 port adapter (8kVCs)	7200 VXR	7201	7301	7304 Carrier Card	7500 (VIP4/VIP6)	7600 Enhanced FlexWAN	6500 Enhanced FlexWAN

Ethernet Port Adapters

PA-2FE-TX/FX 2-port Fast Ethernet 100Base-TX/FX port adapter
PA-4E 4-port Ethernet 10Base-T port adapter
PA-8E 8-port Ethernet 10Base-T port adapter
PA-GE Gigabit Ethernet port adapter

Serial and High-Speed Serial Port Adapters

PA-H 1-port HSSI port adapter
PA-2H 2-port HSSI port adapter
PA-E3 1-port E3 serial port adapter with E3 DSU
PA-2E3 2-port E3 serial port adapter with E3 DSUs
PA-T3+ 1-port T3 serial port adapter, enhanced
PA-2T3+ 2-port T3 serial port adapter, enhanced

Serial Port Adapters

PA-4E1G 4-port E1 G.703 serial port adapter (75 and 120 ohm/balanced)
PA-4T+ 4-port serial port adapter, enhanced
PA-8T-232 8-port serial, EIA-232 port adapter
PA-8T-V35 8-port serial, V.35 port adapter

Cisco Port Adapter Compatibility Quick Look continued							
PA-8T-X21 8-port serial, X.21 port adapter	7200 VXR	7201	7301	7304 Carrier Card	7500 (VIP4/VIP6)	7600 Enhanced FlexWAN	6500 Enhanced FlexWAN

Multichannel Serial Port Adapters

PA-MC-4T(1) 4-port multichannel T1 port adapter with integrated CSU/DSUs
PA-MC-8TE1+ 8-port multichannel T1/E1 8PRI port adapter
PA-MC-2E1/120 2-port multichannel E1 port adapter with G.703 120 ohm interface
PA-MC-E3 1-port multichannel E3 port adapter
PA-MC-T3 1-port multichannel T3 port adapter
PA-MC-2T3+ 2-port multichannel T3 port adapter
PA-MC-STM-1MM/SMI 1-port multichannel STM-1 multimode and single-mode port adapter
PA-MC-T3-EC 1-port Multichannel T3 Enhanced Capability

Cisco Port Adapter Compatibility Quick Look *continued*

PA-MC-2T3-EC
2-port Multichannel T3 Enhanced
Capability

7200 VXR	7201	7301	7304 Carrier Card	7500 (VIP4/VIP6)	7600 Enhanced FlexWAN	6500 Enhanced FlexWAN

SONET PAs

PA-POS-OC3-SMI
8-port MIX-enabled multichannel
T1/E1 with CSU/DSU

--	--	--	--	--	--	--

PA-POS-OC3-SML
8-port MIX-enabled multichannel
T1/E1 with CSU/DSU

--	--	--	--	--	--	--

PA-POS-OC3-MM
1-port packet/SONET OC-3c/
STM-1 multimode port adapter

--	--	--	--	--	--	--

PA-POS-1OC3
1-port packet/SONET OC-3 port
adapter

--	--	--	--	--	--	--

PA-POS-2OC3
2-port packet/SONET OC-3 port
adapter

--	--	--	--	--	--	--

VPN Service Adapters

SA-VAM2+
AES wide key crypto card

C7200-VSA
Cisco 7200 VPN Services Adapter

NPE-G2
only

Cisco Shared Port Adapter
Compatibility Quick Look

7304- MSC-100	ASR1002F SIP-10 is integrated	ASR1002 SIP-10 is integrated	ASR1004 SIP-10	ASR1006 SIP-10	7600- SIP-200
------------------	-------------------------------------	------------------------------------	-------------------	-------------------	------------------

Shared Port Adapters

SPA-4XT-Serial
Cisco 4-Port Serial Interface SPA

--	--	--	--	--	--

SPA-8XCHT1/E1
8-port Channelized T1E1 SPA

--	--	--	--	--	--

SPA-2XT3/E3
2-port T3/E3 Serial SPA

--	--	--	--	--	--

SPA-4XT3/E3
4-port T3/E3 Serial SPA

--	--	--	--	--	--

SPA-2XCT3/DS0
2-port Channelized T3 to DS0 SPA

--	--	--	--	--	--

SPA-4XCT3/DS0
4-port Channelized T3 to DS0 SPA

--	--	--	--	--	--

SPA-1XCHSTM1/OC3
1-port Channelized STM-1 to OC-3
SPA

--	--	--	--	--	--

SPA-1XOC3-ATM-V2
1 port OC-3/STM-1 ATM SPA,
Version 2

--	--	--	--	--	--

SPA-3XOC3-ATM-V2
3-port OC-3/STM-1 ATM SPA,
Version 2

--	--	--	--	--	--

SPA-2XOC3-ATM
2-port OC-3/STM-1 ATM SPA

--	--	--	--	--	--

SPA-4XOC3-ATM
4-port OC-3/STM-1 ATM SPA

--	--	--	--	--	--

SSPA-1XOC12-ATM
1-port OC-12/STM-4 ATM SPA

--	--	--	--	--	--

SPA-1XOC12-ATM-V2
1-Port Clear Channel OC-12/STM-4
ATM SPA, Version 2

--	--	--	--	--	--

SPA-1XOC48-ATM
1-port OC-48/STM-16 ATM SPA

--	--	--	--	--	--

SPA-2XOC3-POS
2-port OC-3c/STM-1c POS SPA

--	--	--	--	--	--

SPA-4XOC3-POS
4-port OC-3c/STM-1c POS SPA

--	--	--	--	--	--

SPA-8XOC3-POS
8-port OC-3c/STM-1c POS SPA

--	--	--	--	--	--

SPA-1XOC12-POS
1-port OC-12c/STM-4c POS SPA

--	--	--	--	--	--

SPA-2XOC12-POS
2-port OC-12c/STM-4c POS SPA

--	--	--	--	--	--

SPA-4XOC12-POS
8-port OC-12c/STM-4c POS SPA

--	--	--	--	--	--

Cisco Series Port Adapter Compatibility Quick Look *continued*

	7304- MSC-100	ASR1002F SIP-10 is integrated	ASR1002 SIP-10 is integrated	ASR1004 SIP-10	ASR1006 SIP-10	7600- SIP-200
Shared Port Adapters <i>continued</i>						
SPA-8XOC12-POS 8-port OC-48c/STM-16c POS/ RPR SPA		•	•	•	•	
SPA-1XOC48-POS/RPR 1-port OC-48c/STM-16c POS/ RPR SPA		•	•	•	•	
SPA-2XOC48-POS/RPR 2-port OC-48c/STM-16c POS/ RPR SPA		•	•	•	•	
SPA-4XOC48-POS/RPR 4-port OC-48c/STM-16c POS/ RPR SPA		•	•	•	•	
SPA-OC192POS-VSR 1-port OC-192c/STM-64c POS/ RPR SPA VSR optics						
SPA-OC192POS-LR 1-port OC-192c/STM-64c POS/ RPR SMLR optics						
SPA-1XOC192POS-XFP 1-port OC-192c/STM-64c POS/ RPR XFP optics		•	•	•	•	
SPA-2X1GbE 2-port 1GbE SPA						
SPA-5X1GbE 5-port 1GbE SPA						
SPA-10X1GbE 10-port 1GbE SPA						
SPA-1XTENGE-XFP 1-port 10GbE SPA XFP based		•	•	•	•	
SPA-4X1FE-TX-V2 4-port 10BASE-T/100BASE-TX Fast Ethernet SPA		•	•	•	•	
SPA-8X1FE-TX-V2 8-port 10BASE-T/100BASE-TX Fast Ethernet SPA		•	•	•	•	•
SPA-2X1GE-V2 2-port 1GbE SPA, Version 2		•	•	•	•	
SPA-5X1GE-V2 5-port 1GbE SPA, Version 2		•	•	•	•	
SPA-8X1GE-V2 8-port 1GbE SPA, Version 2		•	•	•	•	
SPA-10X1GE-V2 10-port 1GbE SPA, Version 2				•	•	
SPA-1X10GE-L-V2 1-Port 10 GbE SPA, Version 2		•	•	•	•	
SPA-WMA-K9 Cisco WebEx Node SPA				•	•	

Cisco Series Port Adapter Compatibility Quick Look *continued*

	6500- SIP-200	7600- SIP-400	6500- SIP-400	7600- SIP-600	6500- SIP-600
Shared Port Adapters <i>continued</i>					
SPA-4XT-Serial Cisco 4-Port Serial Interface SPA					
SPA-8XCHT1/E1 8-port Channelized T1E1 SPA		•			
SPA-2XT3/E3 2-port T3/E3 Serial SPA		•			
SPA-4XT3/E3 4-port T3/E3 Serial SPA		•			
SPA-2XCT3/DS0 2-port Channelized T3 to DS0 SPA		•			
SPA-4XCT3/DS0 4-port Channelized T3 to DS0 SPA		•			
SPA-1XCHSTM1/OC3 1-port Channelized STM-1 to OC-3 SPA		•			
SPA-1XOC3-ATM-V2 1 port OC-3/STM-1 ATM SPA, Version 2					
SPA-3XOC3-ATM-V2 3-port OC-3/STM-1 ATM SPA, Version 2					
SPA-2XOC3-ATM 2-port OC-3/STM-1 ATM SPA	•	•	•		
SPA-4XOC3-ATM 4-port OC-3/STM-1 ATM SPA	•	•	•		
SSPA-1XOC12-ATM 1-port OC-12/STM-4 ATM SPA	•				
SPA-1XOC12-ATM-V2 1-Port Clear Channel OC-12/STM-4 ATM SPA, Version 2		•	•		
SPA-1XOC48-ATM 1-port OC-48/STM-16 ATM SPA		•	•		
SPA-2XOC3-POS 2-port OC-3c/STM-1c POS SPA	•	•	•		
SPA-4XOC3-POS 4-port OC-3c/STM-1c POS SPA	•				
SPA-8XOC3-POS 8-port OC-3c/STM-1c POS SPA					
SPA-1XOC12-POS 1-port OC-12c/STM-4c POS SPA		•	•		
SPA-2XOC12-POS 2-port OC-12c/STM-4c POS SPA					
SPA-4XOC12-POS 8-port OC-12c/STM-4c POS SPA		•	•	•	



Corporate Headquarters
Cisco Systems, Inc.
170 West Tasman Drive
San Jose, CA 95134-1706
USA
www.cisco.com
Tel: 408 526-4000
800 553-NETS (6387)
Fax: 408 526-4100

European Headquarters
Cisco Systems International BV
Haarlerbergpark
Haarlerbergweg 13-19
1101 CH Amsterdam
The Netherlands
www-europe.cisco.com
Tel: +31 0 20 357 1000
Fax: +31 0 20 357 1100

Americas Headquarters
Cisco Systems, Inc.
170 West Tasman Drive
San Jose, CA 95134-1706
USA
www.cisco.com
Tel: 408 526-7660
Fax: 408 527-0883

Asia Pacific Headquarters
Cisco Systems, Inc.
168 Robinson Road
#28-01 Capital Tower
Singapore 068912
www.cisco.com
Tel: +65 6317 7777
Fax: +65 6317 7799

Cisco Systems has more than 200 offices in the following countries and regions. Addresses, phone numbers, and fax numbers are listed on the **Cisco.com Website at www.cisco.com/go/offices**

To order Cisco Catalyst Switching Guide, go to:
www.cisco.com/go/routerguidestore

Argentina • Australia • Austria • Belgium • Brazil • Bulgaria • Canada • Chile • China PRC • Colombia • Costa Rica • Croatia • Cyprus • Czech Republic
Denmark • Dubai, UAE • Finland • France • Germany • Greece • Hong Kong SAR • Hungary • India • Indonesia • Ireland • Israel • Italy
Japan • Korea • Luxembourg • Malaysia • Mexico • The Netherlands • New Zealand • Norway • Peru • Philippines • Poland • Portugal
Puerto Rico • Romania • Russia • Saudi Arabia • Scotland • Singapore • Slovakia • Slovenia • South Africa • Spain • Sweden
Switzerland • Taiwan • Thailand • Turkey • Ukraine • United Kingdom • United States • Venezuela • Vietnam • Zimbabwe

Copyright © 2009 Cisco Systems, Inc. All rights reserved. CCSP, CCVP, the Cisco Square Bridge logo, Follow Me Browsing, and StackWise are trademarks of Cisco Systems, Inc.; Changing the Way We Work, Live, Play, and Learn, and iQuick Study are service marks of Cisco Systems, Inc.; and Access Registrar, Aironet, ASIST, BPX, Catalyst, CCDA, CCDP, CCIE, CCIP, CCNA, CCNP, Cisco, the Cisco Certified Internetwork Expert logo, Cisco IOS, Cisco Press, Cisco Systems, Cisco Systems Capital, the Cisco Systems logo, Cisco Unity, Empowering the Internet Generation, Enterprise/Solver, EtherChannel, EtherFast, EtherSwitch, Fast Step, FormShare, GigaDrive, GigaStack, HomeLink, Internet Quotient, IOS, IP/TV, iQ Expertise, the iQ logo, iQ Net Readiness Scorecard, LightStream, Linksys, MeetingPlace, MGX, the Networkers logo, Networking Academy, Network Registrar, *Packet*, PIX, Post-Routing, Pre-Routing, ProConnect, RateMUX, ScriptShare, ScriptShare, SlideCast, SMARTnet, StrataView Plus, TeleRouter, The Fastest Way to Increase Your Internet Quotient, and TransPath are registered trademarks or trademarks of Cisco Systems, Inc. and/or its affiliates in the United States and certain other countries. All other trademarks mentioned in this document or Website are the property of their respective owners. The use of the word partner does not imply a partnership relationship between Cisco and any other company. (0502R)

Cisco Series Port Adapter Compatibility Quick Look continued

	6500-SIP-200	7600-SIP-400	6500-SIP-400	7600-SIP-600	6500-SIP-600
--	--------------	--------------	--------------	--------------	--------------

Shared Port Adapters continued

SPA-8XOC12-POS 8-port OC-48c/STM-16c POS/ RPR SPA					
SPA-1XOC48-POS/RPR 1-port OC-48c/STM-16c POS/ RPR SPA		•	•		
SPA-2XOC48-POS/RPR 2-port OC-48c/STM-16c POS/ RPR SPA		•	•	•	
SPA-4XOC48-POS/RPR 4-port OC-48c/STM-16c POS/ RPR SPA				•	•
SPA-OC192POS-VSR 1-port OC-192c/STM-64c POS/ RPR SPA VSR optics				•	•
SPA-OC192POS-LR 1-port OC-192c/STM-64c POS/ RPR SMLR optics				•	•
SPA-1XOC192POS-XFP 1-port OC-192c/STM-64c POS/ RPR XFP optics				•	•
SPA-2X1GbE 2-port 1GbE SPA				•	•
SPA-5X1GbE 5-port 1GbE SPA	•	•			
SPA-10X1GbE 10-port 1GbE SPA				•	•
SPA-1XTENGE-XFP 1-port 10GbE SPA XFP based				•	•
SPA-4X1FE-TX-V2 4-port 10BASE-T/100BASE-TX Fast Ethernet SPA	•				
SPA-8X1FE-TX-V2 8-port 10BASE-T/100BASE-TX Fast Ethernet SPA	•				
SPA-2X1GE-V2 2-port 1GbE SPA, Version 2		•			
SPA-5X1GE-V2 5-port 1GbE SPA, Version 2		•			
SPA-8X1GE-V2 8-port 1GbE SPA, Version 2					
SPA-10X1GE-V2 10-port 1GbE SPA, Version 2					
SPA-1X10GE-L-V2 1-Port 10 GbE SPA, Version 2					
SPA-WMA-K9 Cisco WebEx Node SPA					

Cisco USB Flash Memory
Compatibility Quick Look

	800	1800	2800	3800	7200
--	-----	------	------	------	------

USB Flash Memory

MEMUSB-64FT 64 MB USB Flash Memory	871 only	1811, 1812, 1841 only	•	•	
MEMUSB-128FT 128 MB USB Flash Memory	871 only	1811, 1812, 1841 only	•	•	
MEMUSB-256FT 256 MB USB Flash Memory	871 only	1811, 1812, 1841 only	•	•	
MEMUSB-7200-256FT 128 MB USB Flash Memory					NPE-G2