



## Linksys E-Series Routers



User Guide





# Linksys E-Series

---

E900

---

E1200

---

E1500

---

E2500

---

E3200

---

E4200

---

# E900 Contents

## Product overview

E900. . . . .	1
Package contents	1
Features	1
Back view	2
Bottom view	2

## Setting Up: Basics

How to create a home network. . . . .	13
What is a network?	13
How to set up a home network	13
Where to find more help. . . . .	13
How to set up your router . . . . .	13
How to start Cisco Connect	14
How to improve your wireless connection speed . . . . .	15
How to test your Internet connection speed . . . . .	15
How to connect devices to your network . . . . .	16
How to connect a computer to your network	16
How to connect a printer	18
How to connect other devices	18
How to change your router's name and password. . . . .	24

## Setting Up: Advanced

How to open the browser-based utility . . . . .	25
How to manually set up your router. . . . .	26
How to manually set up your Internet connection	26
How to set up the DHCP server on your router. . . . .	29
How to set up DHCP reservation	30
How to find your network on the Internet. . . . .	30
How to clone a MAC address . . . . .	31
How to connect to your corporate office using a VPN . . . . .	32
How to optimize your router for gaming and voice . . . . .	32
How to remotely change your router settings . . . . .	34
How to enable Voice over IP on your network . . . . .	35
How to configure UPnP . . . . .	35
How to use a router as an access point . . . . .	36
How to put your new router behind an existing router. . . . .	37
To add your router to an existing router or gateway	38
To share an Internet connection	38
To extend your network	39
How to expose a device to the Internet . . . . .	40

## Improving Security

---

How do I know if my network is secure? . . . . .	42
Network security following a manual setup. . . . .	42
How to set up wireless security using Wi-Fi Protected Setup . .	43
Wi-Fi Protected Setup activity light	43
Connecting a device using the Wi-Fi Protected Setup button	43
How to connect a device using its Wi-Fi Protected Setup PIN	44
How to connect a device using the router's Wi-Fi Protected Setup PIN	44
How to connect a device manually	44
How to control access to your wireless network . . . . .	45
How to improve security using the built-in firewall	46

## Port Forwarding and Port Triggering

---

How to set up port forwarding . . . . .	57
How to set up port forwarding for a single port	57
How to set up port forwarding for multiple ports	58
How to set up port forwarding for a range of ports	58
How to set up port range triggering for online gaming . . . . .	59
How to configure your Xbox for online gaming . . . . .	60

## Maintaining and Monitoring

---

How to back up and restore your router configuration. . . . .	61
How to restore factory defaults	61
How to upgrade the router's firmware . . . . .	62
How to check the status of your router. . . . .	64
How to disable the Ethernet port status lights	65
How to test your Internet connection	66
How to configure and use logs	67

## Browser-based Utility Menu Structure

---

E900. . . . .	69
---------------	----

## Specifications

---

Linksys E900. . . . .	74
-----------------------	----

# E1200/E1500 Contents

## Product overview

E1200/E1500 . . . . .	3
Package contents . . . . .	3
Features . . . . .	3
Back view . . . . .	4
Bottom view . . . . .	5
Determining your router's version . . . . .	5

## Setting Up: Basics

How to create a home network. . . . .	13
What is a network? . . . . .	13
How to set up a home network . . . . .	13
Where to find more help. . . . .	13
How to set up your router . . . . .	13
How to start Cisco Connect . . . . .	14
How to improve your wireless connection speed . . . . .	15
How to test your Internet connection speed . . . . .	15
How to connect devices to your network . . . . .	16
How to connect a computer to your network . . . . .	16
How to connect a printer . . . . .	18
How to connect other devices . . . . .	18
How to change your router's name and password. . . . .	24

## Setting Up: Advanced

How to open the browser-based utility . . . . .	25
How to manually set up your router. . . . .	26
How to manually set up your Internet connection . . . . .	26
How to set up the DHCP server on your router. . . . .	29
How to set up DHCP reservation . . . . .	30
How to find your network on the Internet. . . . .	30
How to clone a MAC address . . . . .	31
How to connect to your corporate office using a VPN . . . . .	32
How to optimize your router for gaming and voice . . . . .	32
How to remotely change your router settings . . . . .	34
How to enable Voice over IP on your network . . . . .	35
How to configure UPnP . . . . .	35
How to use a router as an access point . . . . .	36
How to put your new router behind an existing router. . . . .	37
To add your router to an existing router or gateway . . . . .	38
To share an Internet connection . . . . .	38
To extend your network . . . . .	39
How to expose a device to the Internet . . . . .	40

## Improving Security

---

How do I know if my network is secure? . . . . .	42
Network security following a manual setup. . . . .	42
How to set up wireless security using Wi-Fi Protected Setup . .	43
Wi-Fi Protected Setup activity light	43
Connecting a device using the Wi-Fi Protected Setup button	43
How to connect a device using its Wi-Fi Protected Setup PIN	44
How to connect a device using the router's Wi-Fi Protected Setup PIN	44
How to connect a device manually	44
How to control access to your wireless network . . . . .	45
How to improve security using the built-in firewall	46

## Port Forwarding and Port Triggering

---

How to set up port forwarding . . . . .	57
How to set up port forwarding for a single port	57
How to set up port forwarding for multiple ports	58
How to set up port forwarding for a range of ports	58
How to set up port range triggering for online gaming . . . . .	59
How to configure your Xbox for online gaming . . . . .	60

## Maintaining and Monitoring

---

How to back up and restore your router configuration. . . . .	61
How to restore factory defaults	61
How to upgrade the router's firmware . . . . .	62
How to check the status of your router. . . . .	64
How to disable the Ethernet port status lights	65
How to test your Internet connection	66
How to configure and use logs	67

## Browser-based Utility Menu Structure

---

E1200/E1500 . . . . .	70
-----------------------	----

## Specifications

---

Linksys E1200 . . . . .	75
Linksys E1500 . . . . .	76

# E2500 Contents

## Product overview

E2500 . . . . .	6
Package contents . . . . .	6
Features . . . . .	6
Back view . . . . .	7
Bottom view . . . . .	7

## Setting Up: Basics

How to create a home network. . . . .	13
What is a network? . . . . .	13
How to set up a home network . . . . .	13
Where to find more help. . . . .	13
How to set up your router . . . . .	13
How to start Cisco Connect . . . . .	14
How to improve your wireless connection speed . . . . .	15
How to test your Internet connection speed . . . . .	15
How to connect devices to your network . . . . .	16
How to connect a computer to your network . . . . .	16
How to connect a printer . . . . .	18
How to connect other devices . . . . .	18
How to change your router’s name and password. . . . .	24

## Setting Up: Advanced

How to open the browser-based utility . . . . .	25
How to manually set up your router. . . . .	26
How to manually set up your Internet connection . . . . .	26
How to get the most out of your dual-band router . . . . .	27

How to set up the DHCP server on your router. . . . .	29
How to set up DHCP reservation . . . . .	30
How to find your network on the Internet. . . . .	30
How to clone a MAC address . . . . .	31
How to connect to your corporate office using a VPN . . . . .	32
How to optimize your router for gaming and voice . . . . .	32
How to remotely change your router settings . . . . .	34
How to enable Voice over IP on your network . . . . .	35
How to configure UPnP . . . . .	35
How to use a router as an access point . . . . .	36
How to put your new router behind an existing router. . . . .	37
To add your router to an existing router or gateway . . . . .	38
To share an Internet connection . . . . .	38
To extend your network . . . . .	39
How to expose a device to the Internet . . . . .	40

## Improving Security

How do I know if my network is secure? . . . . .	42
Network security following a manual setup. . . . .	42
How to set up wireless security using Wi-Fi Protected Setup . . . . .	43
Wi-Fi Protected Setup activity light . . . . .	43
Connecting a device using the Wi-Fi Protected Setup button . . . . .	43
How to connect a device using its Wi-Fi Protected Setup PIN . . . . .	44
How to connect a device using the router’s Wi-Fi Protected Setup PIN . . . . .	44
How to connect a device manually . . . . .	44
How to control access to your wireless network . . . . .	45
How to improve security using the built-in firewall . . . . .	46

## Port Forwarding and Port Triggering

---

How to set up port forwarding . . . . .	57
How to set up port forwarding for a single port	57
How to set up port forwarding for multiple ports	58
How to set up port forwarding for a range of ports	58
How to set up port range triggering for online gaming . . . . .	59
How to configure your Xbox for online gaming . . . . .	60

## Maintaining and Monitoring

---

How to back up and restore your router configuration. . . . .	61
How to restore factory defaults	61
How to upgrade the router’s firmware . . . . .	62
How to check the status of your router. . . . .	64
How to disable the Ethernet port status lights	65
How to test your Internet connection	66
How to configure and use logs	67

## Browser-based Utility Menu Structure

---

E2500 . . . . .	71
-----------------	----

## Specifications

---

Linksys E2500 . . . . .	77
-------------------------	----



# E3200 Contents

## Product overview

E3200 . . . . .	8
Package contents . . . . .	8
Features . . . . .	8
Back view . . . . .	9
Bottom view . . . . .	9

## Setting Up: Basics

How to create a home network. . . . .	13
What is a network? . . . . .	13
How to set up a home network . . . . .	13
Where to find more help. . . . .	13
How to set up your router . . . . .	13
How to start Cisco Connect . . . . .	14
How to improve your wireless connection speed . . . . .	15
How to test your Internet connection speed . . . . .	15
How to connect devices to your network . . . . .	16
How to connect a computer to your network . . . . .	16
How to connect a printer . . . . .	18
How to connect other devices . . . . .	18
How to change your router’s name and password. . . . .	24

## Setting Up: Advanced

How to open the browser-based utility . . . . .	25
How to manually set up your router. . . . .	26
How to manually set up your Internet connection . . . . .	26
How to get the most out of your dual-band router . . . . .	27

How to set up the DHCP server on your router . . . . .	29
How to set up DHCP reservation . . . . .	30
How to find your network on the Internet. . . . .	30
How to clone a MAC address . . . . .	31
How to connect to your corporate office using a VPN . . . . .	32
How to optimize your router for gaming and voice . . . . .	32
How to remotely change your router settings . . . . .	34
How to enable Voice over IP on your network . . . . .	35
How to configure UPnP . . . . .	35
How to use a router as an access point . . . . .	36
How to put your new router behind an existing router. . . . .	37
To add your router to an existing router or gateway . . . . .	38
To share an Internet connection . . . . .	38
To extend your network . . . . .	39
How to expose a device to the Internet . . . . .	40

## Improving Security

How do I know if my network is secure? . . . . .	42
Network security following a manual setup. . . . .	42
How to set up wireless security using Wi-Fi Protected Setup . . . . .	43
Wi-Fi Protected Setup activity light . . . . .	43
Connecting a device using the Wi-Fi Protected Setup button . . . . .	43
How to connect a device using its Wi-Fi Protected Setup PIN . . . . .	44
How to connect a device using the router’s Wi-Fi Protected Setup PIN . . . . .	44
How to connect a device manually . . . . .	44
How to control access to your wireless network . . . . .	45
How to improve security using the built-in firewall . . . . .	46

## Using an External Drive

---

How to configure storage . . . . .	48
How to create shared folders	48
How to manage group and user access to shared folders	49
How to create a group	49
How to create a new user	50
How to grant group access to a share	51
How to configure your router's storage for remote access. . . . .	52
How to configure the FTP server	52
How to share folders and set access rights	53
How to access files remotely . . . . .	54

## Port Forwarding and Port Triggering

---

How to set up port forwarding . . . . .	57
How to set up port forwarding for a single port	57
How to set up port forwarding for multiple ports	58
How to set up port forwarding for a range of ports	58
How to set up port range triggering for online gaming . . . . .	59
How to configure your Xbox for online gaming . . . . .	60

## Maintaining and Monitoring

---

How to back up and restore your router configuration. . . . .	61
How to restore factory defaults	61
How to upgrade the router's firmware . . . . .	62
How to check the status of your router. . . . .	64
How to disable the Ethernet port status lights	65
How to test your Internet connection	66
How to configure and use logs	67

## Browser-based Utility Menu Structure

---

E3200 . . . . .	72
-----------------	----

## Specifications

---

Linksys E3200 . . . . .	78
-------------------------	----

# E4200 Contents

## Product overview

E4200 . . . . .	10
Package contents . . . . .	10
Features . . . . .	10
Top view . . . . .	11
Back view . . . . .	11

## Setting Up: Basics

How to create a home network. . . . .	13
What is a network? . . . . .	13
How to set up a home network . . . . .	13
Where to find more help. . . . .	13
How to set up your router . . . . .	13
How to start Cisco Connect . . . . .	14
How to improve your wireless connection speed . . . . .	15
How to test your Internet connection speed . . . . .	15
How to connect devices to your network . . . . .	16
How to connect a computer to your network . . . . .	16
How to connect a printer . . . . .	18
How to connect other devices . . . . .	18
How to change your router’s name and password. . . . .	24

## Setting Up: Advanced

How to open the browser-based utility . . . . .	25
How to manually set up your router. . . . .	26
How to manually set up your Internet connection . . . . .	26
How to get the most out of your dual-band router . . . . .	27

How to set up the DHCP server on your router. . . . .	29
How to set up DHCP reservation . . . . .	30
How to find your network on the Internet. . . . .	30
How to clone a MAC address . . . . .	31
How to connect to your corporate office using a VPN . . . . .	32
How to optimize your router for gaming and voice . . . . .	32
How to remotely change your router settings . . . . .	34
How to enable Voice over IP on your network . . . . .	35
How to configure UPnP . . . . .	35
How to use a router as an access point . . . . .	36
How to put your new router behind an existing router. . . . .	37
To add your router to an existing router or gateway . . . . .	38
To share an Internet connection . . . . .	38
To extend your network . . . . .	39
How to expose a device to the Internet . . . . .	40

## Improving Security

How do I know if my network is secure? . . . . .	42
Network security following a manual setup. . . . .	42
How to set up wireless security using Wi-Fi Protected Setup . . . . .	43
Wi-Fi Protected Setup activity light . . . . .	43
Connecting a device using the Wi-Fi Protected Setup button . . . . .	43
How to connect a device using its Wi-Fi Protected Setup PIN . . . . .	44
How to connect a device using the router’s Wi-Fi Protected Setup PIN . . . . .	44
How to connect a device manually . . . . .	44
How to control access to your wireless network . . . . .	45
How to improve security using the built-in firewall . . . . .	46

## Using an External Drive

---

How to configure storage . . . . .	48
How to create shared folders	48
How to manage group and user access to shared folders	49
How to create a group	49
How to create a new user	50
How to grant group access to a share	51
How to configure your router's storage for remote access. . . . .	52
How to configure the FTP server	52
How to share folders and set access rights	53
How to access files remotely . . . . .	54
How to set up your router as a media server . . . . .	54
How to connect your UPnP device to the media server	56

## Port Forwarding and Port Triggering

---

How to set up port forwarding . . . . .	57
How to set up port forwarding for a single port	57
How to set up port forwarding for multiple ports	58
How to set up port forwarding for a range of ports	58
How to set up port range triggering for online gaming . . . . .	59
How to configure your Xbox for online gaming . . . . .	60

## Maintaining and Monitoring

---

How to back up and restore your router configuration. . . . .	61
How to restore factory defaults	61
How to upgrade the router's firmware . . . . .	62
How to check the status of your router. . . . .	64
How to disable the Ethernet port status lights	65
How to test your Internet connection	66
How to configure and use logs	67

## Browser-based Utility Menu Structure

---

E4200 . . . . .	73
-----------------	----

## Specifications

---

Linksys E4200 . . . . .	79
-------------------------	----

# Product overview

## E900



### Package contents

In addition to your router, your router package includes:

- Network (Ethernet) cable
- AC power adapter
- Setup CD containing router setup software and documentation

### Features

#### *Wireless-N technology*

Built with leading 802.11n technology, create a powerful home wireless network in minutes. Connect your computers, Internet-ready TVs, game consoles, smartphones, and other Wi-Fi devices at fast transfer rates for an unrivaled experience.

#### *Advanced security*

Keep Wi-Fi freeloaders and Internet threats at bay with WPA2 encryption and SPI firewall to help keep your network protected.

#### *Benefits of Fast Ethernet*

Use the four Fast Ethernet (10/100) ports for quick file sharing between computers and servers.

#### *Home network ready*

Connect computers, printers, and more to your wireless network and the Internet. QoS traffic prioritization technology delivers maximum speed and performance so you can enjoy fast downloads and reliable gaming.

#### *Easy to manage*

Cisco Connect software helps you customize your settings and quickly add multiple devices to your network:

#### *IPv6 enabled*

Supports the latest Internet protocol technology to future-proof your network.

### Back view

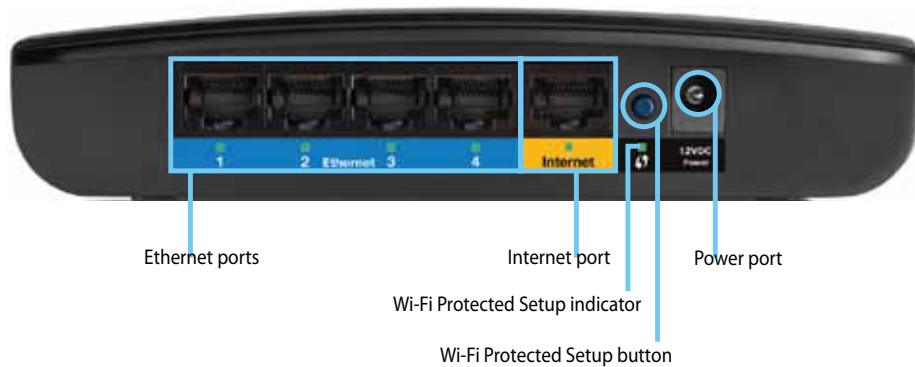

- **Ethernet ports**—Connect Ethernet cables (also called network cables) to these Fast Ethernet (10/100) ports, color coded blue, and to wired Ethernet network devices on your network.
- **Internet port**—Connect an Ethernet cable (also called a network or Internet cable) to this port, color coded yellow, and to your modem.
- **Wi-Fi Protected Setup™ button**—Press this button to easily configure wireless security on Wi-Fi Protected Setup-enabled network devices. For more information, see “How to set up wireless security using Wi-Fi Protected Setup” on page 43.
- **Power indicator**—Stays on steadily while power is connected and following a successful Wi-Fi Protected Setup connection. Flashes slowly during bootup, during firmware upgrades, and during a Wi-Fi Protected Setup connection. Flashes quickly when there is a Wi-Fi Protected Setup error.
- **Power**—Connect the included AC power adapter to this port.

**CAUTION**

Use only the adapter that came with your router.

### Port activity indicator

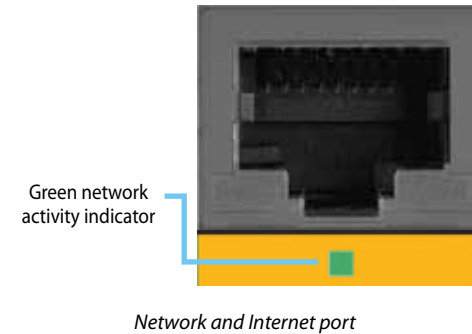

- **Green activity indicator**—On Ethernet ports, stays on when a cable connects the port to another Ethernet port. On the Internet port, stays on while connected to a modem. On both port types, it flashes while transferring data.

### Bottom view



- **Reset button**—Press and hold this button for 5-10 seconds (until the port lights flash at the same time) to reset the router to its factory defaults. You can also restore the defaults using the browser-based utility. For more information, see “How to restore factory defaults” on page 61.

## E1200/E1500



### Package contents

In addition to your router, your router package includes:

- Network (Ethernet) cable
- AC power adapter
- Setup CD containing router setup software and documentation

### Features

#### **Wireless-N technology**

Built with leading 802.11n technology, create a powerful home wireless network in minutes. Connect your computers, Internet-ready TVs, game consoles, smartphones, and other Wi-Fi devices at fast transfer rates for an unrivaled experience.

#### **SpeedBoost**

Higher quality antenna technology helps maintain high speeds across greater distances throughout your home. (E1500 only; not on E1200)

#### **Advanced security**

Keep Wi-Fi freeloaders and Internet threats at bay with WPA2 encryption and SPI firewall to help keep your network protected.

#### **Benefits of Fast Ethernet**

Use the four Fast Ethernet (10/100) ports for quick file sharing between computers and servers.

#### **Home network ready**

Connect computers, printers, and more to your wireless network and the Internet. QoS traffic prioritization technology delivers maximum speed and performance so you can enjoy fast downloads and reliable gaming.

#### **Easy to manage**

Cisco Connect software helps you customize your settings and quickly add multiple devices to your network:

#### **Separate guest network**

Create a separate, password-protected network for guests.

#### **Parental controls**

Limit access time and websites with parental controls.

#### **IPv6 enabled (E1200V2 and E1500)**

Supports the latest Internet protocol technology to future-proof your network.



### Back view

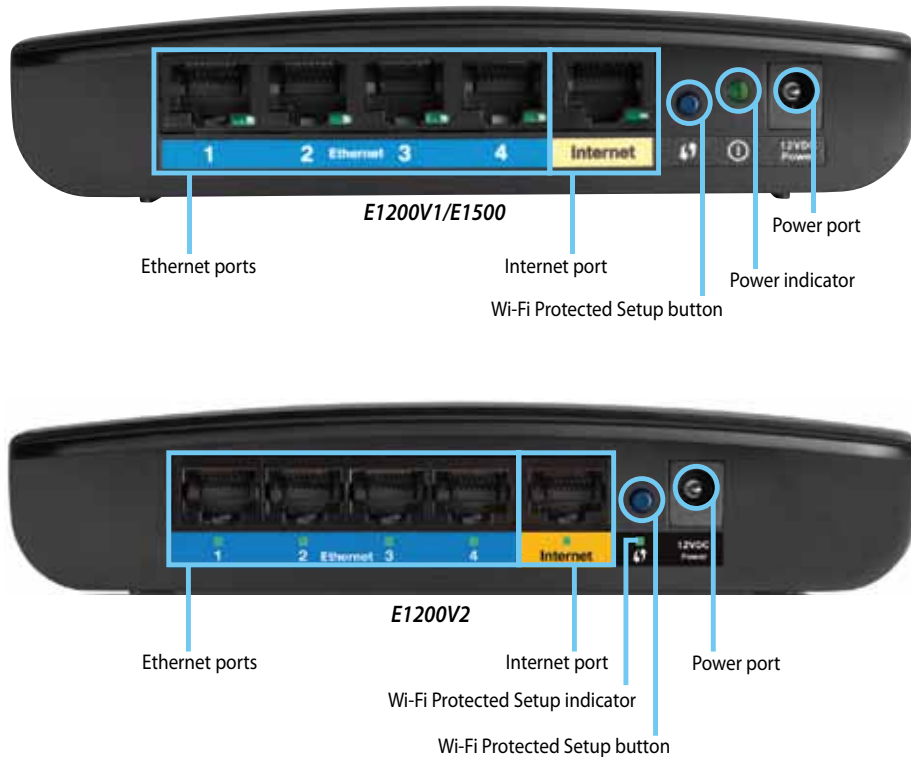

- **Ethernet ports**—Connect Ethernet cables (also called network cables) to these Fast Ethernet (10/100) ports, color coded blue, and to wired Ethernet network devices on your network.
- **Internet port**—Connect an Ethernet cable (also called a network or Internet cable) to this port, color coded yellow, and to your modem.
- **Wi-Fi Protected Setup™ button**—Press this button to easily configure wireless security on Wi-Fi Protected Setup-enabled network devices. For more information, see “How to set up wireless security using Wi-Fi Protected Setup” on page 43.

- **Power indicator**—Stays on steadily while power is connected and following a successful Wi-Fi Protected Setup connection. Flashes slowly during bootup, during firmware upgrades, and during a Wi-Fi Protected Setup connection. Flashes quickly when there is a Wi-Fi Protected Setup error.
- **Power**—Connect the included AC power adapter to this port.

#### CAUTION

Use only the adapter that came with your router.

### Port activity indicator

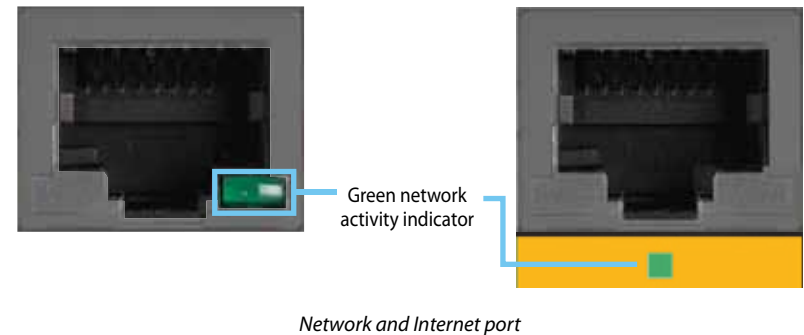

- **Green activity indicator**—On Ethernet ports, stays on when a cable connects the port to another Ethernet port. On the Internet port, stays on while connected to a modem. On both port types, it flashes while transferring data.



## Bottom view



- **Reset button**—Press and hold this button for 5-10 seconds (until the port lights flash at the same time) to reset the router to its factory defaults. You can also restore the defaults using the browser-based utility. For more information, see “How to restore factory defaults” on page 61.

## Determining your router's version

To determine your router model's version, either examine the back panel (differences are shown on the preceding page) or the system label on the bottom of the router. If your router is version 2, a **V2** appears on the label.

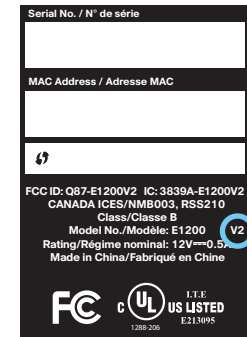

## E2500



### Package contents

In addition to your router, your router package includes:

- Network (Ethernet) cable
- AC power adapter
- Setup CD containing router setup software and documentation

### Features

#### *Wireless-N technology*

Built with leading 802.11n technology, create a powerful home wireless network with double the capacity for surfing the Internet, streaming multimedia, and running applications simultaneously. Connect your computers, Internet-ready TVs, game consoles, smartphones, and other Wi-Fi devices at fast transfer rates for an unrivaled experience.

#### *The power of dual band*

Double your network bandwidth with simultaneous dual-band N (2.4 and 5 GHz). The dual-band feature is designed to avoid interference and optimize throughput for smoother and faster HD video streaming, file transfers, and wireless gaming.

#### *Advanced security*

Keep Wi-Fi freeloaders and Internet threats at bay with WPA2 encryption and SPI firewall to help keep your network protected.

#### *Benefits of Fast Ethernet*

Use the four Fast Ethernet (10/100) ports for quick file sharing between computers and servers.

#### *Network ready*

Connect computers, printers, scanners, and more to your wireless network and the Internet. QoS traffic prioritization technology delivers maximum speed and performance so you can enjoy fast downloads and reliable VoIP.

#### *Easy to manage*

Cisco Connect software helps you customize your settings and quickly add multiple devices to your network:

#### *Separate guest network*

Create a separate, password-protected network for guests.

#### *Parental controls*

Limit access time and websites with parental controls.

#### *IPv6 enabled*

Supports the latest Internet protocol technology to future-proof your network.

### Back view

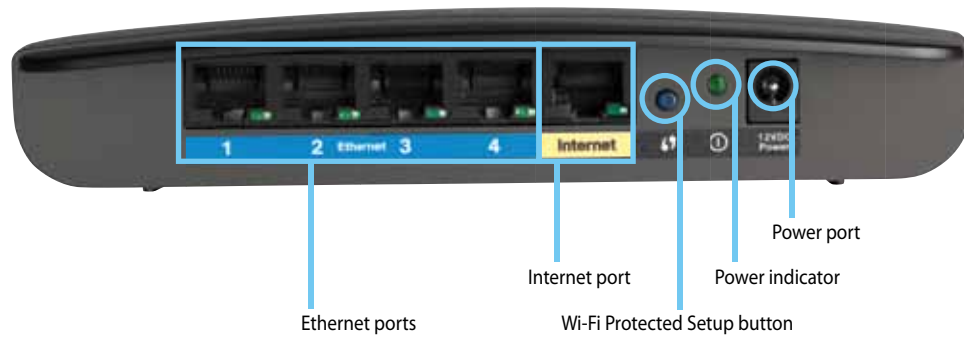

- **Ethernet ports**—Connect Ethernet cables (also called network cables) to these Fast Ethernet (10/100) ports, color coded blue, and to wired Ethernet network devices on your network.
- **Internet port**—Connect an Ethernet cable (also called a network or Internet cable) to this port, color coded yellow, and to your modem.
- **Wi-Fi Protected Setup™ button**—Press this button to easily configure wireless security on Wi-Fi Protected Setup-enabled network devices. For more information, see “How to set up wireless security using Wi-Fi Protected Setup” on page 43.
- **Power indicator**—Stays on steadily while power is connected and following a successful Wi-Fi Protected Setup connection. Flashes slowly during bootup, during firmware upgrades, and during a Wi-Fi Protected Setup connection. Flashes quickly when there is a Wi-Fi Protected Setup error.
- **Power**—Connect the included AC power adapter to this port.

**CAUTION**

Use only the adapter that came with your router.

### Port activity indicator

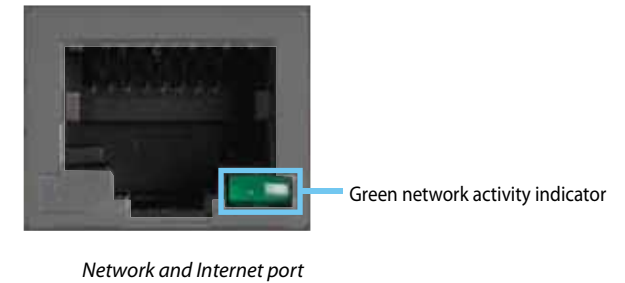

- **Green activity indicator**—On Ethernet ports, stays on when a cable connects the port to another Ethernet port. On the Internet port, stays on while connected to a modem. On both port types, it flashes while transferring data.

### Bottom view



- **Reset button**—Press and hold this button for 5-10 seconds (until the port lights flash at the same time) to reset the router to its factory defaults. You can also restore the defaults using the browser-based utility. For more information, see “How to restore factory defaults” on page 61.

## E3200



### Package contents

In addition to your router, your router package includes:

- Network (Ethernet) cable
- AC power adapter
- Setup CD containing router setup software and documentation

### Features

#### **Wireless-N technology**

Built with leading 802.11n technology, create a powerful home wireless network optimized for video, music, and multi-player gaming. Connect your computers, Internet-ready TVs, game consoles, smartphones, and other Wi-Fi devices at blazingly fast transfer rates for an unrivaled experience.

#### **The power of dual band**

Double your network bandwidth with simultaneous dual-band N (2.4 and 5 GHz). The dual-band feature is designed to avoid interference and optimize throughput for smoother and faster HD video streaming, file transfers, and wireless gaming.

#### **SpeedBoost**

Higher quality antenna technology helps maintain high speeds across greater distances throughout your home.

#### **Advanced security**

Keep Wi-Fi freeloaders and Internet threats at bay with WPA2 encryption and SPI firewall to help keep your network protected.

#### **Benefits of gigabit**

Use the four Gigabit Ethernet (10/100/1000) ports for quick file sharing (up to 10x faster than standard Ethernet) between other Gigabit-enabled devices like computers and servers.

#### **Built-in USB port**

The USB port lets you add an external USB drive to your network and share files at home or over the Internet. You can also connect a USB printer and share it across your network.

#### **Home theater ready**

Bring the ultimate entertainment experience to your home by connecting computers, Internet-ready TVs, game consoles, media players, and more to your wireless network and the Internet. Simultaneous dual-band N and QoS traffic prioritization technology delivers maximum speed and performance so you can enjoy fast downloads, smooth video and music streaming, and reliable gaming and VoIP.

#### **Easy to manage**

Cisco Connect software helps you customize your settings and quickly add multiple devices to your network:

#### **Separate guest network**

Create a separate, password-protected network for guests.

#### **Parental controls**

Limit access time and websites with parental controls.

#### **IPv6 enabled**

Supports the latest Internet protocol technology to future-proof your network.

### Back view

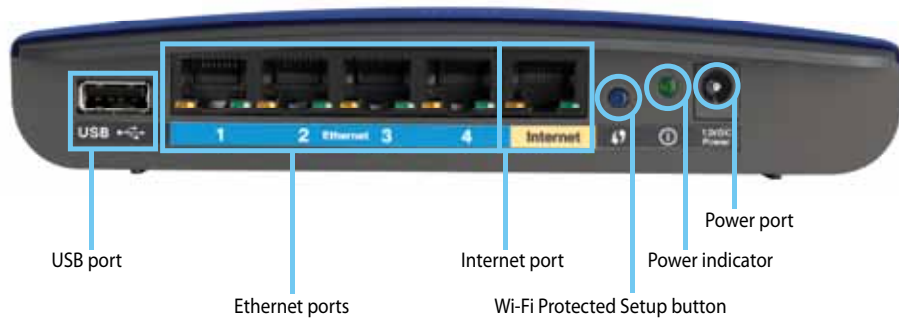

- **USB port**—To easily share disk storage with other users on your network or on the Internet, connect a USB drive to this port. For more information, see “Using an External Drive” on page 48. You can also connect a USB printer and share it across your network. For more information, see “How to connect a printer” on page 18.
- **Ethernet ports**—Connect Ethernet cables (also called network cables) to these Gigabit (10/100/1000) ports, color coded blue, and to wired Ethernet network devices on your network.
- **Internet port**—Connect an Ethernet cable (also called a network or Internet cable) to this port, color coded yellow, and to your modem.
- **Wi-Fi Protected Setup™ button**—Press this button to easily configure wireless security on Wi-Fi Protected Setup-enabled network devices. For more information, see “How to set up wireless security using Wi-Fi Protected Setup” on page 43.
- **Power indicator**—Stays on steadily while power is connected and following a Wi-Fi Protected Setup connection. Flashes slowly during bootup, during firmware upgrades, and during a Wi-Fi Protected Setup connection. Flashes quickly when there is a Wi-Fi Protected Setup error.
- **Power**—Connect the included AC power adapter to this port.

**CAUTION**

Use only the adapter that came with your router.

### Port activity indicators

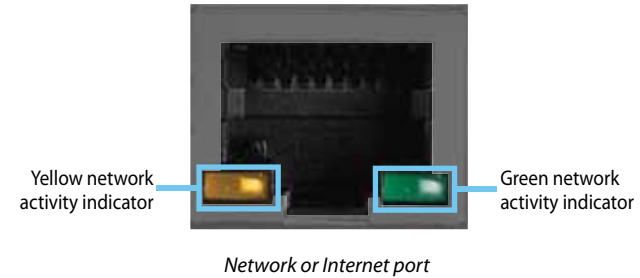

- **Green network activity indicator**—On Ethernet ports, turns on when a cable connects the port to another Gigabit Ethernet port. On the Internet port, turns on while connected to a modem.
- **Yellow activity indicator**—Flashes to indicate network activity over that port.

### Bottom view



- **Reset button**—Press and hold this button for 5-10 seconds (until the port lights flash at the same time) to reset the router to its factory defaults. You can also restore the defaults using the browser-based utility. For more information, see “How to restore factory defaults” on page 61.

## E4200



### Package contents

In addition to your router, your router package includes:

- Network (Ethernet) cable
- AC power adapter
- Setup CD containing router setup software and documentation

### Features

#### **Wireless-N technology**

Built with leading 802.11n wireless technology, your router offers maximum speed and range to create an ultra-powerful network designed for home theater performance. Connect your computers, Internet-ready TVs, game consoles, smartphones and other Wi-Fi devices at blazingly fast transfer rates for an unrivaled experience.

#### **The power of dual band**

Double your network bandwidth with simultaneous dual-band N (2.4 and 5 GHz). The dual-band feature is designed to avoid interference and optimize throughput for smoother and faster HD video streaming, file transfers, and wireless gaming.

#### **SpeedBoost**

Higher quality antenna technology helps maintain high speeds across greater distances throughout your home.

#### **Advanced security**

Keep Wi-Fi freeloaders and Internet threats at bay with WPA2 encryption and SPI firewall to help keep your network protected.

#### **Benefits of gigabit**

Use the four Gigabit Ethernet (10/100/1000) ports for quick file sharing (up to 10x faster than standard Ethernet) between other Gigabit-enabled devices like computers and servers.

#### **Built-in USB port and UPnP media server**

The USB storage port lets you add an external USB drive to your network and share files at home or over the Internet. It also features a built-in UPnP AV media server for seamless streaming of your video and media files to an Xbox 360, PS3, or other UPnP-compatible device. You can also connect a USB printer and share it across your network.

#### **Home theater ready**

Bring the ultimate entertainment experience to your home by connecting computers, Internet-ready TVs, game consoles, media players, and more to your wireless network and the Internet. Simultaneous dual-band N and QoS traffic prioritization technology delivers maximum speed and performance so you can enjoy fast downloads, smooth video and music streaming, and reliable gaming and VoIP.

#### **Quick to install**

Cisco Connect software helps you easily set up your router.



### IPv6 enabled

Supports the latest Internet protocol technology to future-proof your network.

### Easy to manage

Cisco Connect software helps you customize your settings and quickly add multiple devices to your network:

### Separate guest network

Create a separate, password-protected network for guests.

### Parental controls

Limit access time and websites with parental controls.

## Top view



- **Indicator light**—Stays on steadily while power is connected and following a successful Wi-Fi Protected Setup connection. Pulses slowly during bootup, during firmware upgrades, and during a Wi-Fi Protected Setup connection. Flashes quickly when there is a Wi-Fi Protected Setup error.

## Back view

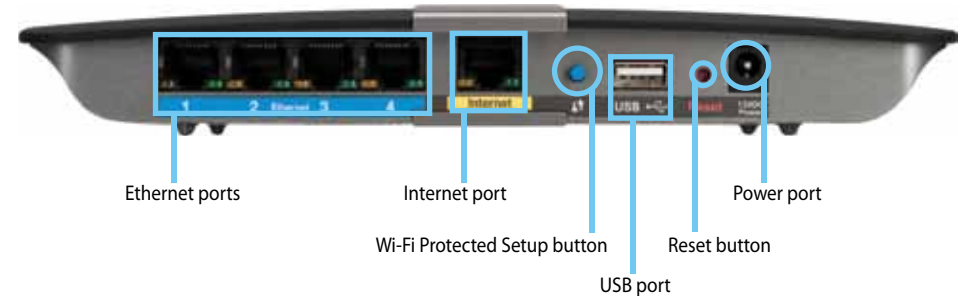

- **Ethernet ports**—Connect Ethernet cables (also called network cables) to these Gigabit (10/100/1000) ports, color coded blue, and to wired Ethernet network devices on your network.
- **Internet port**—Connect an Ethernet cable (also called a network or Internet cable) to this port, color coded yellow, and to your modem.
- **Wi-Fi Protected Setup™ button**—Press this button to easily configure wireless security on Wi-Fi Protected Setup-enabled network devices. For more information, see “How to set up wireless security using Wi-Fi Protected Setup” on page 43.
- **USB port**—To easily share disk storage with other users on your network or on the Internet, connect a USB drive to this port. For more information, see “Using an External Drive” on page 48. You can also connect a USB printer and share it across your network. For more information, see “How to connect a printer” on page 18.
- **Reset button**—Press and hold this button for 5-10 seconds (until the port lights flash at the same time) to reset the router to its factory defaults. You can also restore the defaults using the browser-based utility. For more information, see “How to restore factory defaults” on page 61.
- **Power**—Connect the included AC power adapter to this port.

### CAUTION

Use only the adapter that came with your router.

## Port activity indicators

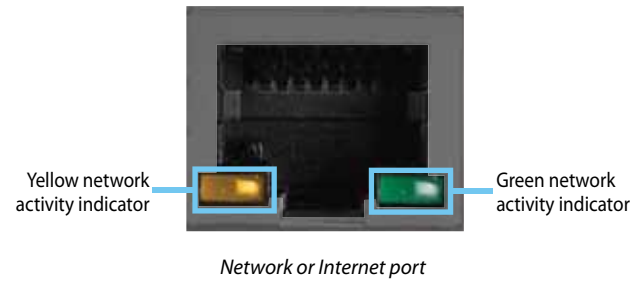

- **Green network activity indicator**—On Ethernet ports, turns on when a cable connects the port to another Gigabit Ethernet port. On the Internet port, turns on while connected to a modem.
- **Yellow network activity indicator**—Flashes to indicate network activity over that port.



# Setting Up: Basics

## How to create a home network

For **ALL**

### What is a network?

A network is any group of devices that can communicate with each other. A home network can also include Internet access, which requires a router like this one.

A typical home network may include multiple computers, a printer, a modem, and a router. A large home network may also have a switch, additional routers, access points, and many Internet-capable media devices such as TVs, game consoles, and web cameras.

- **Modem**—Connects a computer or a router to your ISP (Internet Service Provider).
- **Router**—Connects your wireless and wired network devices to each other and to the modem (and to your ISP).
- **Switch**—Allows you to connect several wired network devices to your home network. Your router has a built-in network switch (the Ethernet ports). If you have more wired network devices than available Ethernet ports on your router, you will need an additional switch to consolidate the wired connections.

### How to set up a home network

1. Purchase the proper equipment. For a network that includes Internet access, you'll need:
  - Computers with an Ethernet port or wireless networking capabilities
  - A modem for connecting to your ISP (typically supplied by your ISP)
  - A router to connect your computers with each other and to the modem
  - Internet service to your home, provided by an ISP (Internet Service Provider)

2. Make sure that your modem is working. Your ISP can help you set up your modem and verify that it's working correctly.
3. Set up your router. See "How to set up your router" on page 13.
4. To connect a computer or other network device to the network, see "How to connect a computer to your network" on page 16 and "How to connect other devices" on page 18.

## Where to find more help

For **ALL**

In addition to this User Guide, you can find help at these locations:

- [Linksys.com/support](http://Linksys.com/support) (documentation, downloads, FAQs, technical support, live chat, forums)
- Setup CD (Troubleshooting Guide, legal and regulatory notices)
- Cisco Connect help (run Cisco Connect, then click Learn More where available)
- Browser-based utility context-sensitive help (open the utility, then click **Help** in the right-side column.)

## How to set up your router

For **ALL**

The easiest and fastest way to set up your router is to run the Cisco Connect setup software. You can find Cisco Connect on the CD that came with your router or download it from the router's support site at [Linksys.com/support](http://Linksys.com/support). Cisco Connect shows you how to connect your router to your home network, step by step. To get started, see "How to start Cisco Connect" below.

If you are an advanced user, you can set up your router manually using the browser-based utility. To get started, see "How to open the browser-based utility" on page 25.

## How to start Cisco Connect

When you run the setup CD, Cisco Connect (your router's setup software) is automatically installed onto your computer. You can then use Cisco Connect to easily manage your router. To install Cisco Connect on another computer after your router has been set up, see "How to install Cisco Connect on another computer" on page 12.

### NOTES:

Your Cisco Connect CD works with only this router model.

If you lose your setup CD, you can download the software from [Linksys.com/support](http://Linksys.com/support).

### To start Cisco Connect for the first time:

1. Insert the CD into your CD or DVD drive.
2. Click **Set up your Linksys Router**.

If you do not see this:

- For Windows, click **Start, Computer**, then double-click the **CD** drive and the **Setup** icon.
  - For Mac, double-click the **CD** icon on your desktop, then double-click the **Setup** icon.
3. Follow the on-screen instructions to complete your router setup. When setup has finished, Cisco Connect has also been installed onto your hard drive.

After your router has been set up and Cisco Connect has been installed, you can use Cisco Connect to easily manage many of your router's settings.



### To start Cisco Connect on a Windows computer:

1. Click **Start, All Programs**, then click **Cisco Connect**. The Cisco Connect main menu opens.

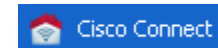

### To start Cisco Connect on a Mac OS X computer:

1. Open the **Applications** folder, then double-click the **Cisco Connect** icon. The Cisco Connect main menu opens.



### To install Cisco Connect on another computer:

1. See "How to connect a computer using an Easy Setup Key" on page 16. When finished, Cisco Connect has also been installed onto the computer's hard drive.

### CAUTION

After your router has been set up, do not run the setup CD to install Cisco Connect to another computer. If you run the setup CD again, you will be prompted to enter the router's network name (SSID) and password.

## How to improve your wireless connection speed

For **ALL**

Follow these tips to improve your network's wireless connection speed:

- Make sure that your router is in a good location:
  - For the widest coverage area, install your router near the center of your home, and near the ceiling, if possible.
  - Avoid placing the router on or near metal objects (such as file cabinets and metal furniture), reflective surfaces (such as glass or mirrors), or masonry walls.
  - Any obstruction can weaken the wireless signal (even non-metallic objects), so the fewer obstructions between the router and the wireless device, the better.
- Place the router in a location away from other electronics, motors, and fluorescent lighting.
- Many environmental variables can affect the router's performance, so if your wireless signal is weak, place the router in several locations and test the signal strength to determine the ideal position.
- If possible, upgrade wireless network interfaces (such as wireless network cards in computers) from older wireless standards to 802.11n. If a wirelessly networked device uses an older standard, the performance of the entire wireless network may be slower.

## How to test your Internet connection speed

For **ALL**

**To test your Internet connection speed:**

1. Run Cisco Connect, then click **Change** under *Router settings*. The *Router settings* screen opens.



2. Click **Launch Test** under *Internet Speed*. The *Internet speed test* screen opens.
3. Follow the on-screen instructions to complete the test.



## How to connect devices to your network

For **ALL**

### How to connect a computer to your network

You can connect a computer to your network using an Easy Setup Key (the easiest way) or manually.

### How to connect a computer using an Easy Setup Key

To use an Easy Setup Key, you first need to create one using any available USB drive. After it has been created, you can use the same key to connect several computers to your network.

**TIP**

The Easy Setup Key stores network information (name, password, security type, and security key) so you don't have to remember them.

**To create an Easy Setup Key:**

1. Run Cisco Connect, then click **Add device** under *Computers and devices*. The *Computers and other devices* screen opens.



2. Click **Computer**.



3. Select **No, I don't have an Easy Setup Key**, then click **Next**.
4. Insert a USB drive into an available USB port on your computer. This USB drive will be your new Easy Setup Key.

Cisco Connect detects the newly attached USB drive and copies the router's settings and a copy of Cisco Connect to it.

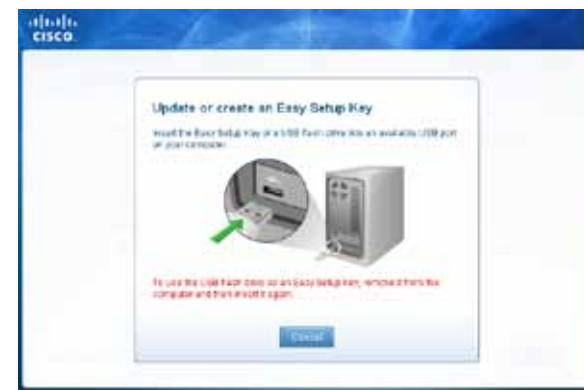

5. When the files have finished copying, remove the Easy Setup Key from your computer. You can now use it to install Cisco Connect onto other computers and to connect them to the network.
6. Click **Close**.

**To use your Easy Setup Key to connect a computer to your network:**

1. Run Cisco Connect, then click **Add device** under *Computers and devices*. The *Computers and other devices* screen opens.
2. Click **Computer**.



3. Select **Yes, I have an Easy Setup Key**, then click **Next**. The *Connecting another computer* screen opens.
4. Insert the Easy Setup Key into an available USB port on the computer that you want to connect to the network. The *Connecting another computer* screen opens.  
If you do not see this, use Windows Explorer or Finder to view the Easy Setup Key files, then double-click **Connect**.
5. Click **Connect to your router**, then follow the on-screen instructions.
6. Return to the computer running Cisco Connect, then click **Next**.
7. Enter a name for the newly connected computer, then click **Finish**.

**How to connect a computer manually**

To connect a computer without using an Easy Setup Key, you will need to print or take note of some information.

**IMPORTANT**

When you manually connect a computer to the network, the computer will *not* have Cisco Connect installed on it.

**To manually connect a computer to your network:**

1. Run Cisco Connect, then click **Add device** under *Computers and devices*. The *Computers and other devices* screen opens.



2. Click **Computer**.
3. Select **I want to connect manually using my wireless settings**, then click **Next**. A screen opens that displays network information.
4. Write down the Network name (SSID), Security Key, and Security Type information, or click **Print these settings** if you have a printer attached.
5. At the computer you want to connect, enter the network information into your wireless manager.
6. After that computer connects to your network, return to the computer running Cisco Connect, then click **Next**.
7. Click **Connect to your Linksys router**, then follow the on-screen instructions.
8. When you are prompted to enter a name for the newly connected computer, enter the name, then click **Finish**.

## How to connect a printer

When you install a printer that requires a cable, you can:

- Follow the printer's instructions for setting it up, then follow your computer's operating system instructions to share the printer with your network.

### TIP

Setting up your printer this way does not require Cisco Connect.

- OR -

- If your router is a Linksys E3200 or E4200, you can connect a USB printer to the router's USB port to make the printer available to any networked computer.

When you set up a wireless printer, you need to make sure that:

- Your printer has been completely set up except for being connected to the network.
- Your printer supports the WPA/WPA2 wireless encryption standard.
- If your wireless printer supports WPS (Wi-Fi Protected Setup), you should use WPS to connect it to your network. See "How to set up wireless security using Wi-Fi Protected Setup" on page 43.

### To connect a wireless printer to your network:

1. Run Cisco Connect, then click **Add device** under *Computers and devices*. The *Computers and other devices* screen opens.



2. Click **Printer**, then click **Wireless printer**. A screen opens that displays network information.
3. Write down the Network name (SSID), Security Key, and Security Type information, or click **Print these settings** if you have a different printer already connected.
4. Follow your printer's instructions for entering the wireless network information into your printer.
5. After the printer connects to your network, click **Next** in Cisco Connect.
6. Return to the computer running Cisco Connect, then click **Next**. The *Name your printer* screen opens.
7. Enter a name for the printer, then click **Finish**.
8. Follow your computer operating system's instructions for adding the new printer to your list of available printers.

### To connect a USB printer to your network through the router's USB port:

For **E3200** **E4200**

1. Run Cisco Connect, then click **Add device** under *Computers and devices*. The *Computers and other devices* screen opens.
2. Click **Printer**, then click **USB Printer**.
3. Follow the on-screen instructions for connecting the printer. This process may take several minutes.
4. Repeat Steps 1-3 on each computer you want to print from. For information on installing Cisco Connect onto other computers, see "To install Cisco Connect on another computer:" on page 14.

## How to connect other devices

Many other types of wireless network devices can connect to your home network, including:

- Game consoles
- Internet-capable TVs and media players
- Digital music players
- Smart phones



Because of the wide variety of devices and methods of connecting, you must manually enter network information into the devices for a successful network connection.

### To manually connect a device to your network:

1. Run Cisco Connect, then click **Add device** under *Computers and devices*. The *Computers and other devices* screen opens.



2. Click **Other wireless devices**. A screen opens that displays network information.
3. Write down the Network name (SSID), Security Key, and Security Type information, or click **Print these settings** if you have a printer attached.



4. Follow your device's instructions for entering the wireless network information into the device.
5. After the device connects to your network, return to the computer running Cisco Connect, then click **Next**.
6. Enter a name for device, then click **Finish**.

For more instructions on connecting a game console to your network, see also:

- "How to optimize your router for gaming and voice" on page 32
- "How to set up port forwarding" on page 57
- "How to set up port range triggering for online gaming" on page 59

## How to set up parental controls

For **E1200** **E1500** **E2500** **E3200** **E4200**

With your router, you can use parental controls to:

- Set the times that Internet access is allowed.
- Block websites that you specify or based on their content.
- Set the above restrictions for specific computers.

### TIPS

- You can also set parental controls in the browser-based utility. On the E4200, click the **Access Restrictions** tab. On other Linksys routers, click the **Access Restrictions** tab, then click the **Parental Controls** page.
- When someone tries to open a blocked website, a window opens asking for the parental controls password. Enter the password to view the blocked content.

## How to access parental controls

The first time you try to access parental controls, you are asked to set a password.

### To access parental controls for the first time:

1. Run Cisco Connect, then click **Change** under **Parental controls**. The *Parental controls password* screen opens.



2. Enter a password (from 4 to 32 characters), then enter a secret question and answer.
  - The password must contain from 4 to 32 valid characters, which are A-Z, a-z, and 0-9.
  - The answer to the secret question should be something not easily guessed by others. If you forget your password, you can reset it by correctly answering your secret question.
3. To save your settings, click **OK**. The *Parental controls* main screen appears.

### To access parental controls after the first time:

1. Run Cisco Connect, then click **Change** under **Parental controls**. The *Enter the parental controls password* screen opens.
2. Enter the parental control password, then click **OK**.

### NOTE

If you forgot the password, click **I forgot my password** and enter the answer to your secret question.

The *Parental controls* main screen appears.





### To change the parental controls password:

1. In the Parental controls main screen, click **Change parental controls password**, then follow the on-screen instructions.



### How to select the computers to have parental controls

It's not necessary to set parental controls over each computer on your home network. You can set the controls on only those computers that children can access.

### To select computers that will have parental controls:

1. In the *Parental controls* main screen, click + (add) under the *Restrict Internet access on* box.

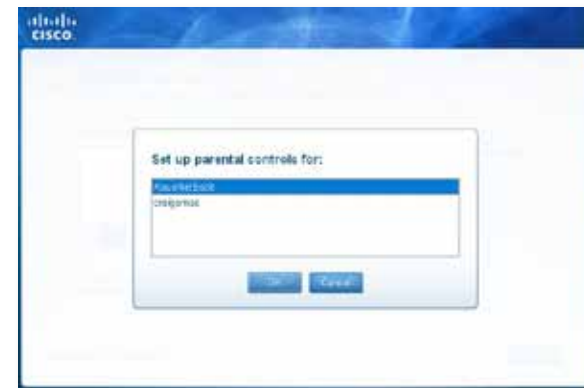

2. Click the computer name, then click **OK**. The computer is added to the list of computers with parental controls.
3. To remove parental controls from a computer, click the computer name in the *Restrict Internet access on* box, then click – (remove).

## How to set parental controls

1. In the *Parental controls* main screen, click the computer name to set parental controls for.
2. Under *Block Internet access*, specify when the computer's Internet access will be blocked:
  - **Never** does not block Internet access.
  - **Always** blocks Internet access at all times.
  - **Specific times** blocks Internet access only during specific times. If you select this option, set the schedule for **School nights** (Monday through Friday) and **Weekends** (Saturday and Sunday).
3. To create or change a list of specific websites to block, click **Edit** next to *Block specific sites*. The *Block these sites* screen opens.



- a. On a blank line, enter a website address that you want to block.
  - b. Click **Save** to save the list and return to the *Parental controls* main screen.
4. To save your changes, click **Finish**.
  5. Repeat the above steps for each computer that you want to set parental controls for.

## How to set up guest access to your network

For **E1200** **E1500** **E2500** **E3200** **E4200**

You can use your router's guest access feature to provide your guests with access to the Internet, while restricting their access to other resources on your local network. The guest network is shown as an open, unsecure wireless network that your guests can easily connect to. To prevent unauthorized users from using your Internet access, your guest network requires that a password be entered for Internet access. The guest network is enabled by default.

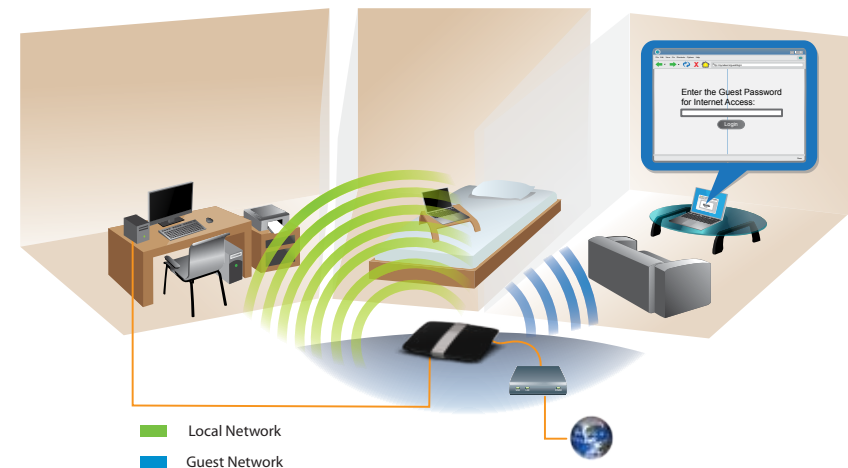

Local Access and Guest Access Diagram

**To set up guest access to your network:**

1. Run Cisco Connect, then click **Change** under *Guest Access*. The *Guest Access* screen opens.



2. Under *Allow guest access*, click **yes (default)** to allow guest Internet access. Otherwise, click **no** to disable guest access.
3. Take note of the Guest account's network name and password. You will need to provide this information to your guests.

**TIPS**

To keep your guest network secure, click **Change** to change the guest password when the guest no longer needs access to the account.

You can view the Guest account's name and password in Cisco Connect's main screen.

4. In the **Total guests** allowed drop-down box, select the number of simultaneous guest network users you want to allow.
5. Click **Finish** to apply your changes.

**TIP**

The first time your guest tries to access the Internet through a web browser, they will see the *Guest access* screen. To continue, they must enter the password you provided in the **Password** field, then click **LOGIN**.



## How to change your router's name and password

For **ALL**

You can change the name and password of your router, but if you do so, all wireless devices connected to your router will lose their Internet connection until you reconnect them using the new router name and password.

### CAUTION

If you change your router's name and password using the browser-based utility, you may not be able to manage your router using Cisco Connect. We recommend using the procedure below to change your router's login information.

### To change your router's name and password:

1. Run Cisco Connect, then click **Change** under *Router settings*.
2. Under *Personalize*, click **Change**. A *Changing router name and password* warning appears



3. Click **Yes** if you want to continue.
4. Enter the new router name and password, then click **Change**.

### TIP

After you make changes, update your Easy Setup Key to make it easier to reconnect all of the other computers on the network.

# Setting Up: Advanced

## How to open the browser-based utility

For **ALL**

To access some advanced settings, you need to open the browser-based utility.

### CAUTION

If you change settings in the browser-based utility, you might not be able to run Cisco Connect later.

### To open the browser-based utility:

1. Run Cisco Connect, click **Change** under *Router settings*, click **Advanced settings**, then click **OK**.

– or –

Open a web browser on a computer connected to your network, then go to **192.168.1.1**. If your router is version 2 (look for **V2** on router's bottom label), you can go to **myrouter.local** instead.

The router prompts you for a user name and password.

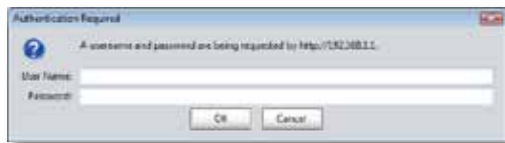

2. Enter the user name and password, then click **OK**. The utility's main menu opens.

### TIPS

If you set up your router without using Cisco Connect, your router's default username and password is **admin**.

If you used Cisco Connect to set up your router, you can see your router's user name and password by running Cisco Connect, then clicking **Router settings**.



## How to manually set up your router

### For **ALL**

Although running Cisco Connect is the easiest way to set up and maintain your router, advanced users may want to manually configure their router. Be careful when changing settings using this method.

#### To manually set up your router:

1. If you have started the Cisco Connect setup, exit Cisco Connect.
2. Connect your router's power adapter to a power outlet.
3. Connect an Ethernet cable to the computer and to an available numbered **Ethernet** (blue) port on the back of your router.
4. Open a web browser on the computer and open the address **192.168.1.1**. A login window appears. If your router is version 2 (look for **V2** on router's bottom label), you can go to **myrouter.local** instead.

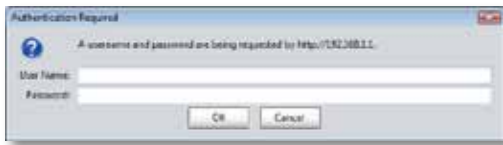

5. Enter the default password (**admin**). If your router is the E4200 V2 (check the version number on the bottom of your router), you must enter **admin** as the user name. Otherwise, you can leave the user name blank.

The browser-based utility opens to the main menu.

6. After you finish changing settings, click **Save Settings** at the bottom of the screen.
7. To exit the browser-based utility, close the web browser window.

#### TIP

For field descriptions, click **Help** in the right side of the screen.

## How to manually set up your Internet connection

In most cases, Cisco Connect automatically sets up your Internet connection (see "How to start Cisco Connect" on page 14). For some *ISPs* (Internet Service Providers), especially those outside of the United States, you may need to manually configure your router's Internet connection. Your router supports six types of Internet connections.

### Basic Internet connection settings

#### To manually configure your router's Internet connection:

*Setup > Basic Setup*

1. Log into the browser-based utility (see "How to open the browser-based utility" on page 25).
2. Click the **Setup** tab, then click the **Basic Setup** page.
3. In the **Internet Connection Type** drop-down list, click the type of Internet connection provided by your ISP. (Telstra Cable not available on the E4200.)

#### TIP

For field descriptions, click **Help** on the right side of the screen.

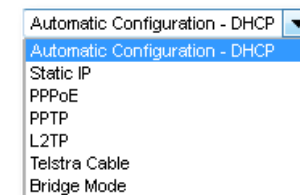

- Complete the fields required by your ISP.
  - Complete the *Optional Settings* only if required by your ISP.
4. Click **Save Settings** at the bottom of the page.

## IPv6 Internet connection settings

For **E900** **E1200V2** **E1500** **E2500** **E3200** **E4200**

IPv6 is a new IP protocol that uses simplified packet headers and requires IPSec. It also has improved support for mobile IP and computing devices. If your router model supports IPv6, an *IPv6 Setup* page is available under the *Setup* tab.

### NOTE

To use your router's IPv6 Internet connection settings, IPv6 service from your ISP (Internet service provider) is required. For more information on this service, ask your ISP.

### To manually configure your router's IPv6 settings:

*Setup* > *IPv6 Setup*

1. Log into the browser-based utility (see "How to open the browser-based utility" on page 25).
2. Click the **Setup** tab, then click the **IPv6 Setup** page.
3. **IPv6 - Automatic**—Select **Enabled** to automatically use IPv6 for all network addressing.
4. **6rd Tunnel**—Allows your router to send IPv6 IP addresses over IPv4 networks. To enable this option, **IPv6 - Automatic** must be set to **Disabled**. To let your router handle the 6rd Tunnel settings (such as prefixes and address masks), change the 6rd Tunnel setting to **Automatic Configuration**. Select **Manual Configuration** to change these settings manually.
  - **Prefix**—Enter the prefix address used for the tunnel provided by your ISP.
  - **Prefix Length**—Enter the prefix length used for the tunnel provided by your ISP.
  - **Border Relay**—Enter the border relay address used for the tunnel provided by your ISP.
  - **IPv4 Address Mask**—Enter the IPv4 address mask length used for the tunnel provided by your ISP.
5. Click **Save Settings** at the bottom of the page.

## How to get the most out of your dual-band router

For **E2500** **E3200** **E4200**

**I bought a dual band router, but I'm not sure that I'm getting the most out of it. What should I check?** Of the many reasons for owning a dual-band router, the most common is to ensure available bandwidth for streaming high-definition video. At the same time, owners want to make sure that their video streams won't be interrupted by other wireless network traffic. To get the most out of your dual-band router, you can:

- Upgrade your wireless clients
- Split your traffic

### Upgrade your wireless clients

If you have network adapters that support only legacy wireless network standards such as 802.11b, you should consider upgrading them with Wireless-N (802.11n) network adapters. Wireless-B (802.11b) devices can slow your entire wireless network. For the best performance, all of your wireless devices should support Wireless-N. You can then select *Wireless-N Only* as your Network Mode below.

### NOTE

If you select *Wireless-N Only*, you may need to temporarily change your network settings to Mixed to provide access to guests without Wireless-N networking.

### Split your traffic

The best way to improve your multimedia wireless performance is to split your wireless traffic between your router's two bands (ranges of radio frequencies). Your router supports the 2.4 GHz band and the 5 GHz band, and handles the two bands as two separate wireless networks to help manage the traffic.

The most common way to split wireless traffic is to use the 2.4 GHz band for basic Internet tasks such as web browsing, email, and downloads, and use the 5.0 GHz band for streaming multimedia. There are several reasons for this approach:



- Although the 2.4 GHz band may be more crowded with wireless traffic from your neighbors, it's fine for basic Internet traffic that is not time-sensitive (such as e-mail).
- Even though you are connected to your own wireless network, you are still sharing "air time" with nearby networks.
- The 5 GHz band is much less crowded than the 2.4 GHz band, so it's ideal for streaming multimedia.
- The 5 GHz band has more available channels, so it is more likely that you will have your own, interference-free channel for your wireless network.

By default, your dual-band router uses the same network name on both the 2.4 GHz band and the 5 GHz band. If you are connecting to your router with a computer that has a dual-band wireless network adapter, you might not be able to determine which band you're using. The easiest way to segment your traffic is to rename one of your wireless networks. With a separate, descriptive name, it will be easy to connect to the right network.

#### To reconfigure your wireless network:

*Wireless > Basic Wireless Settings or Wireless Settings*

1. Log into the browser-based utility (see "How to open the browser-based utility" on page 25).
2. Click the **Wireless** tab, then click the **Basic Wireless Settings** or **Wireless Settings** page.
3. Click **Manual**. This enables you to make changes to all of the fields below.

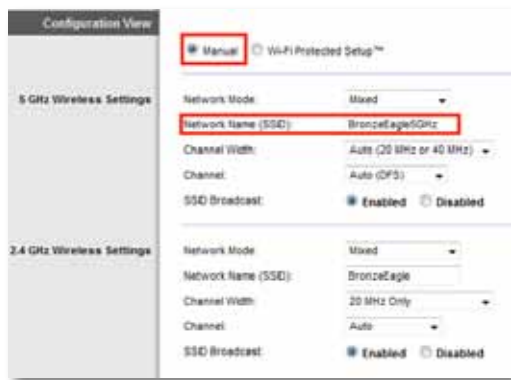

- a. **Network Mode**—Your choice depends upon the clients that will connect to your network. If all of your devices are Wireless-N capable, you can select Wireless-N Only for either or both bands.

On the 5 GHz band, you can select:

- **Mixed** (default), which accepts connections from 802.11a or 802.11n clients
- **Wireless-A Only** (802.11a only)
- **Wireless-N Only** (802.11n only)
- **Disabled**, which disables the 5.0 GHz band on this router

On the 2.4 GHz band, you can select:

- **Mixed**
- **Wireless-B/G Only**
- **Wireless-B only**
- **Wireless-G Only**
- **Wireless-N Only**
- **Disabled**

- b. **Network Name (SSID)**—Provide a unique SSID for your 5 GHz wireless network. The name must not exceed 32 keyboard characters. In the example above, the 5 GHz wireless network was renamed *BronzeEagle5GHz*.

- c. **Channel Width**—We recommend that you keep the default (Auto) settings. In Auto mode, the router and the network clients automatically switch to the 40 MHz mode if:

- Your wireless clients support the 40 MHz mode (sometimes called *Bonded* mode) in which two 20 MHz channels are bonded together for better performance.
- There is no adjacent interference.

With more available channels and less chance of interference on the 5 GHz band, you have the option to force the 40MHz mode.

On the 5GHz band, you can select:

- **Auto (20 MHz or 40 Mhz)**
- **20 MHz Only**
- **40 MHz Only**



On the 2.4 GHz band, you can select:

- **Auto (20 MHz or 40MHz)**
- **20 MHz Only**

- d. **Channel**—Choose the operating channel for each band. Your router will automatically select the channel with the least amount of interference if you leave the default **Auto** or **Auto (DFS)** setting. We recommend keeping the default settings for both bands.
- e. **SSID Broadcast**—When wireless clients look for wireless networks to connect to, they detect the SSID (wireless network name) broadcast by the router. To broadcast your router's SSID, keep the default setting (Enabled). If you do not want to broadcast the router's SSID, select **Disabled**. We recommend keeping the default setting (**Enabled**) for both bands.
- f. **Security Mode** (setting is on this page for the E4200, and on the *Wireless > Wireless Security* page for other routers)—The 5 GHz and 2.4 GHz networks can use different security options. Select the security option for each wireless network. If the security mode you select requires a passphrase, a *Passphrase* field appears, and you must enter a passphrase.

#### TIP

Wireless-N networks should use the WP2-Personal security mode for best performance.

4. To apply your changes, click **Save Settings** at the bottom of the screen.

## How to set up the DHCP server on your router

### For **ALL**

Your router can be used as a *DHCP* (Dynamic Host Configuration Protocol) server to automatically assign an IP address to each computer or device on your network. The DHCP server is enabled by default. If you already have a DHCP server on your network, or if you do not want to use your router as a DHCP server, you should disable this setting.

### To configure your router's DHCP server settings:

*Setup > Basic Setup > DHCP Server Settings*

1. Log into the browser-based utility (see "How to open the browser-based utility" on page 25).
2. Click the **Setup** tab, then click the **Basic Setup** page.
3. Review the *DHCP Server Setting* fields (in the middle of the screen). You can:
  - Enable or disable the DHCP server.
  - Change the starting address for the DHCP server.
  - Change the number of users (253 maximum).
4. If you change any of the settings, click **Save Settings** at the bottom of the page.



#### TIP

For field descriptions, click **Help** on the right side of the screen.

## How to set up DHCP reservation

**Why would I use it?** *DHCP reservation* allows you to assign a unique, fixed IP address to a specific device on your network. Assigning a fixed IP address is a good way to manage devices such as print servers, web cameras, network printers, and game consoles. A fixed IP address is also recommended if you want to use port forwarding for devices that need to receive inbound traffic from the Internet (“How to set up port forwarding” on page 57).

### To configure DHCP reservation:

*Setup > Basic Setup > DHCP Reservation*

1. Log into the browser-based utility (see “How to open the browser-based utility” on page 25).
2. Click the **Setup** tab, then click the **Basic Setup** page.
3. Click **DHCP Reservation** (in the middle of the screen).
4. Click **Select** next to the client you want to create a DHCP reservation for.
5. Click **Add Clients**. The client you selected is added to the *Clients Already Reserved* table.

You can also manually enter a client name, IP address, and MAC address of a device to create a DHCP reservation.

6. Click **Save Settings**.



### TIP

For field descriptions, click **Help** on the right side of the screen.

## How to find your network on the Internet

For **ALL**

**Why would I need to find my network on the Internet?** If you want to remotely access a USB drive attached to your router or view a web camera, you need to find your network on the Internet.

Working with several DDNS service providers, your router’s DDNS feature lets you configure a domain name for your network, which you can then use to easily find your network on the Internet. If your ISP changes your network’s IP address, the DDNS service providers detect the address change and continue to route your domain name to that address.

### TIP

Before you configure DDNS on your router, you must sign up for DDNS service from a DDNS service provider that’s supported by your router.

### To set up DDNS:

*Setup > DDNS*

1. Sign up for DDNS service at either [www.dyndns.org](http://www.dyndns.org) or [www.tzo.com](http://www.tzo.com).
2. Log into the browser-based utility (see “How to open the browser-based utility” on page 25).
3. Click the **Setup** tab, then click the **DDNS** page.
4. In the **DDNS Service** drop-down list, click your DDNS service provider. The examples below are based on TZO.com. The settings used by DynDNS.org are slightly different.

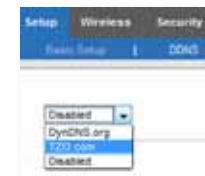

- Complete the fields with information provided by your DDNS provider, then click **Save Settings**. The *Status* field tells you what actions have been taken.

In this example, the domain name registered with TZO.com is *BronzeEagle953.linksysnet.com*. If an Internet camera had been configured (see “How to set up port forwarding for a single port” on page 57), you could access the camera by typing the domain name into the address bar of your web browser followed by the port number used for the device. For example, if the camera in the above example used port 1024, the URL would be:

**BronzeEagle953.linksysnet.com:1024**

## How to clone a MAC address

### For **ALL**

On any home network, each network device has a unique *MAC* (Media Access Control) address. Some ISPs register the MAC address of the device (usually a router or a computer) connected directly to the modem. If your computer's MAC address is registered with your ISP and you do not want to re-register the MAC address, then you can *clone* the address (assign the registered MAC address of your previous device to your new router). If you want to use the MAC address from an old router that you are replacing with your new router, you should first determine the MAC address of your old router, then manually enter it into your new router.

### NOTE

For many ISPs that provide dynamic IP addresses automatically, the stored MAC address in the modem is reset each time you reset the modem. If you are installing this router for the first time, reset your modem before connecting the router to your modem. To reset your modem, disconnect power for about one minute, then reconnect power.

### To clone a MAC address from your computer:

*Setup > MAC Address Clone*

- Log into the browser-based utility (see “How to open the browser-based utility” on page 25).
- Click the **Setup** tab, then click the **MAC Address Clone** page.
- Click **Enabled**.
- Click either **Clone My PC's MAC** or enter the 12-digit MAC address of your old router.
- Click **Save Settings**.

## How to connect to your corporate office using a VPN

For **ALL**

**What is a VPN, and do I need to change my router settings?** A *VPN* (Virtual Private Network) is a network that uses a public network, such as the Internet, to provide secure communications between a remote computer and another network. Corporations often provide VPN access to their networks to enable employees to work from remote offices or while traveling. Most corporate VPNs use the Internet to provide connectivity between remote employees and the corporate network.

For a typical VPN, the corporation installs a VPN gateway on their corporate network. Employees authorized to work remotely connect to the VPN gateway through the Internet using VPN software and security methods provided by their employers. Robust security and authentication schemes ensure a secure connection and access by only authorized users.

The default VPN settings in your router have been configured to pass through (allow) the most common types of VPN protocols, so usually no changes are needed.

### To change your VPN passthrough settings:

*Security > VPN Passthrough*

1. Log into the browser-based utility (see “How to open the browser-based utility” on page 25).
2. Click the **Security** tab, then click the **VPN Passthrough** page.
3. Select each setting that you want to change.

#### TIP

For brief descriptions of the VPN passthrough field settings, click **Help** in the right side of the screen. More complete descriptions are provided below.

- **IPSec Passthrough** – *IPSec* (Internet Protocol Security) is a suite of protocols used to implement secure exchange of packets at the IP layer. The VPN clients on the local network can establish an IPSec VPN tunnel through the router. This option is enabled by default.

- **PPTP Passthrough** – *PPTP* (Point-to-Point Tunneling Protocol) allows the *PPP* (Point-to-Point Protocol) to be tunneled through an IP network. The VPN clients on the local network can establish a PPTP VPN tunnel through the router. This option is enabled by default.
- **L2TP Passthrough** – *L2TP* (Layer 2 Tunneling Protocol) enables point-to-point sessions using the Internet on the Layer 2 level. The VPN clients on the local network can establish an L2TP VPN tunnel through the router. This option is enabled by default.

4. Click **Save Settings** to save your changes.

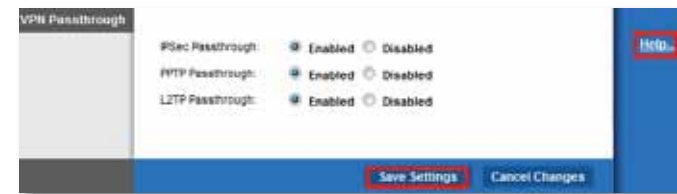

## How to optimize your router for gaming and voice

For **ALL**

**How does my router prioritize traffic to the Internet?** Your router has QoS (Quality of Service) settings that can prioritize traffic from your network out to the Internet. Performance for demanding, real-time applications, such as online gaming, VoIP calls, video streaming, and videoconferencing, can be improved by configuring Internet access priorities.

QoS is applied only to traffic that is uploaded to the Internet. The router cannot control the quality of the traffic after it reaches the Internet.

#### TIP

For more information on optimizing your router for online gaming, see “Port Forwarding and Port Triggering” on page 57.

**To configure QoS:**

*Applications & Gaming > QoS*

1. Log into the browser-based utility (see “How to open the browser-based utility” on page 25).
2. Click the **Applications & Gaming** tab, then click the **QoS** page.

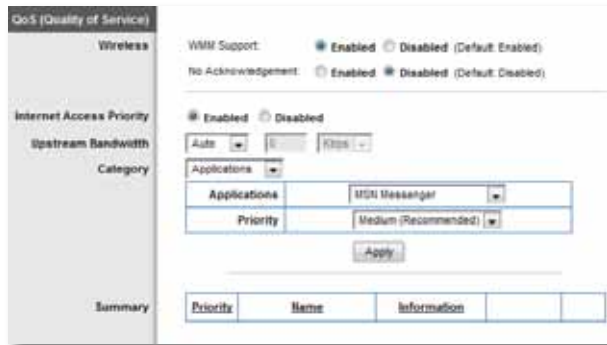
**TIP**

For field descriptions, click **Help** on the right side of the screen.

3. To help manage traffic priority with devices that support WMM, select **Enabled** under *WMM Support*. Otherwise, select **Disabled**.

**TIP**

*WMM* (Wi-Fi MultiMedia) Support is a wireless QoS feature based on the IEEE 802.11e standard. WMM improves quality for audio, video, and voice applications by prioritizing wireless traffic. This feature requires that the wireless client devices in your network also support WMM.

4. To have the router re-send data if an error occurs, select **Disabled** under *No Acknowledgement*. Otherwise, select **Enabled**.
5. To set access priorities for a specific device or application, select **Enabled** next to *Internet Access Priority*.
6. In the **Category** drop-down list, select the type of item you want to set a priority for. A list of installed items fitting that description appears.

**TIP**

Do not set all priorities to **High**, because all items will have the same priority, and it would be easier to disable Internet Access Priority for the same result.

- **Applications** and **Online Games**—Let you assign a priority for an application or online game.
  - a) Select the application or online game that you want to add from the drop-down list, then select the priority.
  - b) Click **Apply**, then click **Save Settings**.

**TIP**

If you want to add a new application or game, you need to know its port and protocol information (see the application or game’s documentation for help).

- **MAC Address** and **Voice Device**—Let you prioritize network traffic based on the device that is accessing the network. For example, if you want your gaming console to have higher priority than your computer for accessing the Internet, you can assign a higher priority to your game console using its MAC address. We recommend giving any voice devices a high priority.
  - a) Select **MAC Address** or **Voice Device** from the drop-down list, then enter the name of the device you want to add.
  - b) Enter the device’s 12-digit MAC address, then select the priority.
  - c) Click **Apply**, then click **Save Settings**.

**TIP**

You can often find a device’s 12-digit MAC address on the bottom of the device. Or, if the device is connected to your network and turned on, you can click the **Administration** tab in the router’s browser-based utility, click the **Local Network** page, then click **DHCP Client Table**.

### 7. Configure **Upstream Bandwidth**.

- To allow the router to detect the maximum, select **Auto** (default). Auto sets speeds in multiples of 512 Kbps.
- To specify the maximum, select **Manual**, then select the bandwidth you want it to use.

#### CAUTION

If you specify a maximum bandwidth that is too high, the router cannot apply priorities correctly, and QoS problems may result.

### 8. When you are done setting priorities, click **Save Settings**.

## How to remotely change your router settings

For **ALL**

**Why would I want to remotely change my router settings?** There may be times when you want to change parental control settings, or change settings for remote file access, while you are away from home.

#### To set up remote access:

*Administration > Management*

- Log into the browser-based utility (see “How to open the browser-based utility” on page 25).
- Click the **Administration** tab, then click the **Management** page and locate the *Remote Management Access* settings in the middle of the screen.
- For *Remote Management*, select **Enabled**.
- For *Access via*, select **HTTP** (default) or select **HTTPS** to use *SSL* (Secure Socket Layer) to encrypt data transmitted for higher security.
- To be able to upgrade your router’s firmware remotely, select **Enabled** next to *Remote Upgrade*.
- To allow remote access from anywhere on the Internet, select **Any IP Address** (default) next to *Allowed Remote IP Address*. Otherwise, enter a range of allowed IP addresses.

- For *Remote Management Port*, keep the setting of **8080** (default) unless you already have a device on your network that uses port 8080 (such as a web camera).
- Click **Save Settings** at the bottom of the screen to accept your changes.

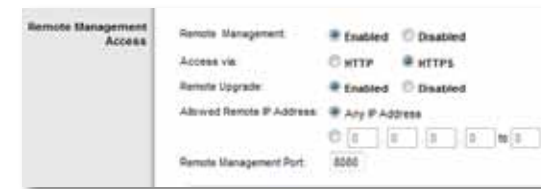

- Click the **Administration** tab, then click the **Management** page and take note of the *Internet IP Address* and the *Remote Management Port* settings. You will use this information to access your router remotely.

#### To access your router remotely:

- Open a web browser and enter the Internet address of your router, then press **Enter**.
  - If you selected **HTTP** for your *Access via* setting, enter **http://** then the IP address.
  - OR –
  - If you selected **HTTPS** for your *Access via* setting above, enter **https://** then the IP address.
- Add a colon (:), then the *Remote Management Port* number. Example:  
**https://69.192.16.170:8080**

#### TIP

If you enabled the Dynamic Domain Name Service (see “How to find your network on the Internet” on page 30), you could type in your domain name in place of your router’s Internet IP address. For example:

**https://BronzeEagle953.linksysnet.com:8080**

You are prompted for a user name and the password. Use the same login information that you use to access your router at home. After you have logged into your router’s browser-based utility remotely, you can change any router setting, just as you would normally from your local network.



## How to enable Voice over IP on your network

For **ALL**

**Do I need to configure Voice over IP?** *VoIP* (Voice over Internet Protocol) is a technology for using the Internet as an interface for telephone communications. To use VoIP, you need to get an account with a VoIP service provider. The VoIP service provider typically provides you with a telephone adapter (TA) that connects to your network. If you do not use your network to make phone calls, you don't need to change the default settings.

The *SIP* (Session Initiation Protocol) *ALG* (Application Layer Gateway) feature allows SIP packets, used by some VOIP service providers, to traverse (go through) your router's firewall.

### To configure the router for VoIP:

*Administration > Management*

1. Log into the browser-based utility (see "How to open the browser-based utility" on page 25).
2. Click the **Administration** tab, then click the **Management** page.
3. If your VoIP service uses SIP, select **Enabled** next to *SIP ALG*.  
– OR –

If your VoIP service uses other NAT traversal solutions such as *STUN* (Session Traversal Utilities for NAT), *TURN* (Traversal Using Relay NAT), or *ICE* (Interactive Connectivity Establishment), select **Disabled** (default).



### NOTE

You may need to contact your VoIP service provider to determine the type of NAT traversal configuration they use.

## How to configure UPnP

For **ALL**

**What is UPnP?** *UPnP* (Universal Plug and Play) allows devices connected to a network to discover each other and automatically create working configurations. Examples of UPnP-capable devices include web cameras, online gaming applications, and VoIP devices. UPnP is enabled by default.

### To configure UPnP:

*Administration > Management*

1. Log into the browser-based utility (see "How to open the browser-based utility" on page 25).
2. Click the **Administration** tab, then click the **Management** page.
3. To use UPnP, select **Enabled** (default) next to *UPnP*. Otherwise, select **Disabled**.
4. To allow changing router settings while using UPnP, select **Enabled** (default) next to *Allow Users to Configure*. Otherwise, select **Disabled**.
5. To prevent local network users from disabling your Internet connection through UPnP, select **Disabled** (default) next to *Allow Users to Disable Internet Access*. Otherwise, select **Enabled**.



## How to use a router as an access point

**How can I use this new router as an access point?** If you have a large area to cover with your wireless signal, or if part of your home has weak signals due to interference, you can use this router to extend the range of your old router's wireless network.

For **ALL**

### To set up your new router as an access point:

*Setup > Basic Setup*

1. Use a network cable to connect this router's **Internet** port to the **Ethernet** or **LAN** port on the router that is connected to your modem.
2. Log into the browser-based utility (see "How to open the browser-based utility" on page 25).
3. Click the **Setup** tab, then click the **Basic Setup** page.
4. For **Internet Connection Type**, select **Bridge Mode**.
5. Click **Save Settings** to apply the changes. The new router's LAN IP address will be changed and obtained from the router that is connected to your modem.

#### IMPORTANT

While in Bridge Mode, the following browser-based utility pages will be unavailable:

- Setup tab: IPv6 Setup, DDNS, MAC Address Clone, Advanced Routing
- Security tab: all pages
- Access Restrictions tab: all pages
- Applications & Gaming tab: all pages
- Administration tab: Log

For **ALL**

**How can I use my old router as an access point?** If you have a large area to cover with your wireless signal, or if part of your home has weak signals due to interference, you can use your old router to extend the range of your wireless network. This is a complex process, so this procedure assumes that you have some networking knowledge.

#### TIP

Check the documentation for your old router. Some brands of routers include either a switch on the outside of the case or a software option to convert it to an access point. If either of these options is available, follow your old router's instructions to convert it to an access point.

You need to take note of your new router's settings, then apply some of those settings to the old router so it can work as an access point.

### To view your new router's settings:

*Wireless > Basic Wireless Settings (non-E4200)*

*Wireless > Wireless Security (non-E4200)*

*Wireless > Wireless Settings (E4200)*

*Status > Wireless Network*

*Setup > Basic Setup*

1. Make sure that your new router is connected to the Internet.
2. In the browser-based utility, click the **Wireless** tab
3. For the E4200, click **Wireless Settings** and take note of the *Network Name (SSID)*, *Security Mode*, and *Passphrase*.  
Or, for other Linksys router models:
  - a. Click the **Basic Wireless Settings** page and take note of the *Network Name (SSID)*.
  - b. Click the **Wireless** tab, then click the **Wireless Security** page and take note of the *Security Mode* and the passphrase.
4. Click the **Status** tab, then click the **Wireless Network** page and take note of the *Channel*.
5. Click the **Setup** tab, then click the **Basic Setup** page and take note of the DHCP server's IP Address range (192.168.1.100 to 192.168.1.149 by default)



**To use your old router as an access point:**

1. With your computer connected to your old router, log into its browser-based administration utility.

**NOTE**

Save your changes after finishing each step below.

2. Open the setup page for the local network (LAN).
3. In the **Router IP address** field, enter an unused IP address for the LAN network of your new router.

For example, if your new router has an IP address of 192.168.1.1, you should choose an IP address on the 192.168.1.0 network. You can choose any address within the range of 192.168.1.2 to 192.168.1.254. You should exclude addresses in the range that will be used by the DHCP Server of your new router (192.168.1.100 to 192.168.1.149). A safe choice might be 192.168.1.250. Take note of this address, because this will be the address that you will use to manage your old router in the future.

4. In the **Subnet Mask** field, enter **255.255.255.0** or, if available, select that subnet mask from a drop-down list.
5. Disable the DHCP server on your old router. (Because your old router will be operating as an access point instead of a router, you don't want it to distribute IP addresses. There should be only one active DHCP server on your network, and that should be your new router.)
6. To reconfigure the wireless network on your old router:
  - a. Open the wireless network setup page.
  - b. Change the network name (SSID) to match the name of your new network. Having the same network name and security settings enables you to seamlessly roam between your new router and your old router.
  - c. Change the security mode to match the security mode on your new router.
  - d. Change the passphrase (sometimes called the pre-shared key) on your old router to match the passphrase on your new router.

- e. Change the wireless channel to a non-conflicting channel. Some manufacturers have an "Auto" function for channel selection that automatically selects a wireless channel that does not interfere with other nearby wireless networks. If your old router supports an Auto function, select that. Otherwise, you may need to manually select the wireless operating channel on your old router. In the 2.4 GHz wireless spectrum, there are only three non-overlapping channels: 1, 6, and 11. Pick a channel that does not overlap the operating channel of your new router. For example, if your new router is operating on channel 11, configure your old router for either channel 1 or channel 6.
7. Connect an Ethernet network cable to one of the LAN/Ethernet ports on your old router and an Ethernet port on your new router.

**CAUTION**

Do **not** connect the cable to the Internet port on your old router. If you do, you may not be able to set up the router as an access point on the current network.

## How to put your new router behind an existing router

**For ALL**

**Why would I put my new router behind an existing router?** There are several possible scenarios in which you might want to use your new router "behind" another router:

1. You might be in an environment that shares the landlord's Internet connection with all tenants. In this case, you should put your own router behind the landlord's router in order to create your own private network and to isolate computers on your network from the rest of the building.
2. You are sharing an office building Internet connection, and you want to control Internet access or the content viewed by your employees.
3. You already have an existing network and you want to extend the network's range or add wireless capabilities to your network.
4. You want to separate older, less secure network devices from the rest of the network.

## To add your router to an existing router or gateway

In most cases, you can easily add your router to an existing wireless network by running Cisco Connect. If you are unable to set up the additional router using the instructions below, see "To share an Internet connection" on page 38 or "To extend your network" on page 39.

### To add a router to your existing wireless network:

1. Insert the Cisco Connect setup CD into a CD/DVD drive on your computer, then follow the on-screen instructions.
2. When you are told to connect your router's **Internet** port to the **LAN/Ethernet** port on your modem, connect your router's **Internet** port to the **LAN/Ethernet** port on your existing (upstream) router or gateway.
3. Follow the on-screen instructions until setup is complete.

## To share an Internet connection

### NOTE

This is a complex process, so this procedure assumes that you have some networking knowledge.

### To add another router to share an Internet connection:

*This topic covers cases one and two above*

1. Determine the IP address range for your upstream (office or building) network.

To determine the address range by using a Windows computer:

- a. Connect your computer into your upstream network's router.
- b. Click **Start, Run**, type **CMD**, then click **OK**. The command prompt window appears.
- c. Type **ipconfig**, then press **Enter**.

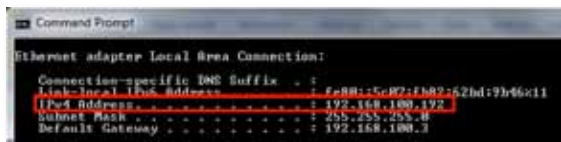

### TIP

Although you can determine your computer's IP address in many ways, this method is very fast.

- d. Take note of the IP address. In this example, the IP address is 192.168.100.192.

To determine the address range by using a Mac computer:

- a. Connect your computer into your upstream network's router.
- b. From the *Dock*, click **System preferences**, click **Network**, then click **Ethernet** in the window to the left. A network status window appears.



- c. Take note of the IP address. In this example, the IP address is 192.168.100.139.

Example: The above examples show that upstream IP addresses are on the 192.168.100.0 network. (The "0" indicates the entire network.) Your upstream network's address may be different. The default address of your new Linksys router is 192.168.1.1. In setting up one router behind another, you must make sure that the local network on your new router is different than the network of your upstream router. In the above example, because the default local network on your Linksys router 192.168.1.0 is on a different subnet than the office network's 192.168.100.0, you will be able to place your Linksys router behind the other router.

2. Connect an Ethernet network cable to a LAN/Ethernet port on your upstream network to the yellow **Internet** port on your router.

### CAUTION

Connect the upstream network to your router's yellow **Internet** port, *not* one of the blue Ethernet ports. If you connect to an Ethernet port, you create IP addressing problems for the office network.

**TIPS**

An office network often has a wall plate with an Ethernet port that you can connect to.

If you are doing this in a home environment (without wall ports), connect an Ethernet network cable between a LAN port on your upstream router and the **Internet** port on your Linksys router.



3. Run Cisco Connect on each computer that you want to connect to the Linksys router. Each computer needs either a wired or wireless connection to the Linksys router. For more information, see “How to connect a computer to your network” on page 16.

The computers that are connected to the Linksys router are now on the same network, and are isolated from the upstream network. However, you will still have access to the Internet through the upstream router (by way of your Linksys router). Because two routers are between your computer and the Internet, Internet traffic undergoes two network address translations. This is sometimes referred to as *Double NAT*.

Your computers can also use the built-in capabilities of your Linksys router, such as parental controls. If you need further control over the type of content your employees or family access, you can create an account with an Internet filtering site such as [www.opendns.com](http://www.opendns.com) or [www.bsecure.com](http://www.bsecure.com). After you create an account with them, use their DNS in place of your ISP’s DNS.

**To use their DNS:**

*Setup > Basic Setup*

1. Log into the browser-based utility (see “How to open the browser-based utility” on page 25).
2. Click the **Setup** tab, then click the **Basic Setup** page.
3. Complete the **Static DNS** fields with the information provided by your content filtering provider.

Static DNS 1:	0	. 0	. 0	. 0
Static DNS 2:	0	. 0	. 0	. 0
Static DNS 3:	0	. 0	. 0	. 0

4. Click **Save Settings**.

**To extend your network**

*This topic covers cases three and four above.*

**NOTE**

This is a complex process, so this procedure assumes that you have some networking knowledge.

**To extend your network or add wireless capabilities:**

1. If you want to extend your network, you may also follow the instructions above. One example of this might be to provide a separate wireless network for your children to keep their wireless network traffic separate from your wireless network. You might also want to isolate one network from another network so that network shares aren’t visible across networks. In this case, use an Ethernet cable to connect the **Internet** port of the downstream router to one of the LAN ports of the upstream router. Make sure that the local network subnets on the two routers are different.  
- OR -

You can extend your network by turning the downstream router into an access point. (See “How to use a router as an access point” on page 36). When you use a router as an access point, computers connected to the access point are on the same IP subnet as all other devices connected to the router. File, printer, and media sharing is much easier if all devices are on the same subnet.

## How to expose a device to the Internet

For **ALL**

**Why would I expose a device to the Internet?** If you are operating a web server, a mail server, or a web camera, you may want to expose that device to the Internet so anybody can access it. Your router includes a *DMZ* (Demilitarized Zone) feature that forwards all inbound ports presented on the WAN interface, except those that are specifically forwarded, to an individual IP address or MAC address. This feature is normally not used, because it presents significant security risks to the device that you designate for the DMZ. The DMZ device is not protected by the built-in firewalls, Internet filters, or router web filters, and is open to attacks from hackers.

A much better way of “exposing” devices to the Internet would be to use port forwarding. See “How to set up port forwarding” on page 57.

### To set up a device in the DMZ:

*Applications & Gaming > DMZ*

1. Configure your device with a static IP address. See your device’s documentation for help with setting a static IP address or use DHCP reservation (see “How to set up the DHCP server on your router” on page 29).
2. Log into the browser-based utility (see “How to open the browser-based utility” on page 25).
3. Click the **Applications & Gaming** tab, then click the **DMZ** page.
4. Select **Enabled**.

5. In the *Source IP Address* section, select **Any IP Address** to allow access to your DMZ device from the entire Internet, or select the **source range** button and enter a range of allowed source addresses.
6. In the *Destination* section, enter the last three digits of the IP address of the device that will be in the DMZ. The rest of the IP address is already completed.
7. Click **Save Settings** to apply your changes.

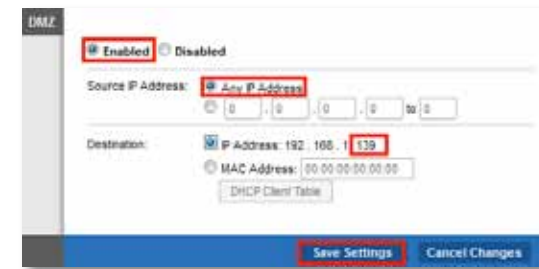

If you prefer to specify the 12-digit MAC address of the device you want to place in the DMZ instead of setting up a DHCP address reservation, you can replace Step 6 with the following steps:

- a. Click **Enabled**.
- b. In the *Source IP Address* section, select **Any IP Address** (default) to allow access to your DMZ device from the entire Internet, or select the **source range** button and enter a range of allowed source addresses.
- c. In the *Destination* section, select **MAC Address**, then click **DHCP Client Table**. A separate window opens showing the current DHCP client list.

Client Name	Interface	IP Address	MAC Address	Expires Time	
MacBook	Wireless	192.168.1.139	00:1E:C2:8D:3E:A4	23:26:40	Delete
NetBook	LAN	192.168.1.140	00:24:8C:8D:FE:E9	23:28:24	Delete

Refresh Close

### TIP

The DHCP Client Table is only available if you select **MAC Address**.

- d. Click **Select** next to the device that you want to place in the DMZ. In this example, the first device was selected. The corresponding MAC address was copied into the *MAC Address* field as shown below.
- e. Click **Save Settings** to apply your changes.



# Improving Security

## How do I know if my network is secure?

For **ALL**

If you configured your router using Cisco Connect, your network is secure. During setup, Cisco Connect creates a name for your network, enables industry-standard WPA/WPA2 wireless security, and assigns a highly secure password for your wireless network and the administrator's account.

### To confirm that your network is secure:

1. Run Cisco Connect.



2. In the upper-right corner of the screen, check for the green light that indicates your router is online and secure. If the green light is on, no additional action is required to secure your network.

## Network security following a manual setup

For **ALL**

If you configured your router manually (not recommended), you must manually configure security.

### To manually set your router's password:

*Administration > Management*

1. Log into the browser-based utility (see "How to open the browser-based utility" on page 25).
2. Click the **Administration** tab, then click the **Management** page.
3. In the *Router Access* section, enter a secure password for your router, then re-enter the password to confirm it. Your password should be at least eight characters in length. The most secure type of password should include a mix of uppercase and lowercase letters, numbers, and punctuation.
4. Click **Save Settings** at the bottom of the screen.

### To manually set your router's network name (SSID):

*Wireless > Wireless Settings (E4200)*

*Wireless > Basic Wireless Settings (non-E4200)*

1. Log into the browser-based utility (see "How to open the browser-based utility" on page 25).
2. Click the **Wireless** tab, then click the **Wireless Settings** page (for E4200 routers) or **Basic Wireless Settings** page (for non-E4200 routers).
3. For *Configuration View*, select **Manual**.
4. Enter a new network name in the **Network Name (SSID)** field, then click **Save Settings** at the bottom of the screen.



**To manually set your router's wireless security settings:***Wireless > Wireless Settings (E4200)**Wireless > Wireless Security (non-E4200)*

1. Log into the browser-based utility (see "How to open the browser-based utility" on page 25).
2. Click the **Wireless** tab, then click the **Wireless Settings** page (for E4200 routers) or **Basic Wireless Settings** page (for non-E4200 routers).
3. Select your preferred security type from the **Security Mode** drop-down list. For most home networks, we recommend **WPA2/WPA Mixed Mode**.
4. Enter a passphrase (security key) for your wireless network in the **Passphrase** field. The most secure type of security key should include a mix of uppercase and lowercase letters, numbers, and punctuation.
5. Click **Save Settings** at the bottom of the screen.

## How to set up wireless security using Wi-Fi Protected Setup

For **ALL**

**Why would I use Wi-Fi Protected Setup?** Wi-Fi Protected Setup™ is a feature of your router that makes it easy to add devices to your wireless network. If you have network devices, such as wireless printers, that support Wi-Fi Protected Setup, then you can use Wi-Fi Protected Setup to add the devices.

### Wi-Fi Protected Setup activity light

The power indicator light on the back of the router (or on top for the E4200) indicates the status of Wi-Fi Protected Setup while you are connecting devices.

- When Wi-Fi Protected Setup is connecting a network device, the light flashes slowly.
- If there is an error, the light flashes quickly for two minutes. Wait until it stops flashing, then try again.
- When Wi-Fi Protected Setup has finished connecting a device, the light is continuously lit.
- Wait until the light is continuously lit before starting the next Wi-Fi Protected Setup session.

Connect network devices using one of the three methods below.

**NOTE**

Wi-Fi Protected Setup configures one device at a time. Repeat the instructions for each device that supports Wi-Fi Protected Setup.

### Connecting a device using the Wi-Fi Protected Setup button

Use this method if your device has a Wi-Fi Protected Setup button or prompts you to press the Wi-Fi Protected Setup button on your router.

**To connect a device using the Wi-Fi Protected Setup button:***Wireless > Basic Wireless Settings*

1. Press the **Wi-Fi Protected Setup** button on the network device you are connecting to.
2. Press the **Wi-Fi Protected Setup** button on the back of the router.



- OR -

- a. Log into the browser-based utility (see "How to open the browser-based utility" on page 25).
- b. Click the **Wireless** tab, then, if your router is not an E4200, click the **Basic Wireless Settings** page.
- c. Click **Wi-Fi Protected Setup**.
- d. Click the **Wi-Fi Protected Setup** button in the router's *Wi-Fi Protected Setup* screen.

1. If your client device has a Wi-Fi Protected Setup™ button, click or press that button and then click the button on the right.



- e. After the device has been configured, click **OK**.

## How to connect a device using its Wi-Fi Protected Setup PIN

Use this method if your device has a Wi-Fi Protected Setup *PIN* (Personal Identification Number).

### To connect a device using the device's Wi-Fi Protected Setup PIN:

*Wireless > Basic Wireless Settings*

1. Log into the browser-based utility (see "How to open the browser-based utility" on page 25).
2. Click the **Wireless** tab, then, if your router is not an E4200, click the **Basic Wireless Settings** page.
3. Click **Wi-Fi Protected Setup**.
4. Enter the PIN from the device into the **PIN** field on the router's *Wi-Fi Protected Setup* screen, then click **Register**.

2. If your client device has a Wi-Fi Protected Setup™ PIN number, enter that number here  and then click

5. After the device has been connected, click **OK**.

## How to connect a device using the router's Wi-Fi Protected Setup PIN

Use this method if your client device asks for the router's PIN.

### To connect a device using the device's Wi-Fi Protected Setup PIN:

*Wireless > Basic Wireless Settings*

1. Log into the browser-based utility (see "How to open the browser-based utility" on page 25).
2. Click the **Wireless** tab, then, if your router is not an E4200, click the **Basic Wireless Settings** page.
3. Click **Wi-Fi Protected Setup**.

4. On the client device, enter the PIN listed on the router's *Wi-Fi Protected Setup* screen. It is also listed on the bottom of the router. In the example below, the router's PIN is 32744781.

3. If your client asks for the Router's PIN number, enter this number 32744781 in your client device.

5. Follow the device's instructions to complete setup.

## How to connect a device manually

If you have devices that do not support Wi-Fi Protected Setup, note the wireless settings in the *Basic Wireless Settings* screen, then manually configure those devices.

For each wireless network, the Network Name (SSID), Security, and Passphrase are displayed at the bottom of the screen.

<b>5 GHz Wireless Settings</b>	Network Name (SSID):	BronzeEagle
	Security:	WPA2/WPA Mixed Mode
	Passphrase:	B6eM9UkCjz
<b>2.4 GHz Wireless Settings</b>	Network Name (SSID):	BronzeEagle
	Security:	WPA2/WPA Mixed Mode
	Passphrase:	B6eM9UkCjz



## How to control access to your wireless network

For **ALL**

**Why would I need to control access to my wireless network?** If you used Cisco Connect to configure your router, your wireless network is already secure. By default, Cisco Connect enables industry-standard WPA (Wi-Fi Protected Access) security using WPA2/WPA mixed mode. Cisco Connect configures your network with a complex, 10-character password that is almost impossible to compromise. If you set up your wireless network manually and have not enabled wireless security, your wireless network will be an “open” network that almost anyone nearby with a Wi-Fi-enabled device could access.

**What is MAC filtering?** The best way to secure your wireless network is to use Cisco Connect to automatically configure and secure it. However, if you choose not to use the built-in security features of your router, you can still control access to your wireless network using MAC filtering.

Every network device has a unique, 12-digit MAC (Media Access Control) address. Using MAC filtering, you can allow only known MAC addresses onto your network. You can also exclude specific MAC addresses or deny them access to your wireless network.

*Example:* Because each MAC filtering configuration is unique, the following procedure uses the simplified example of setting up MAC filtering to allow one wireless device access to the network.

### To set up MAC filtering to allow one wireless device access to your network:

*Wireless > Wireless MAC Filter*

1. Log into the browser-based utility (see “How to open the browser-based utility” on page 25).
2. Click the **Wireless** tab, then click the **Wireless MAC Filter** page.
3. Click **Enabled**.

4. Select **Permit**.

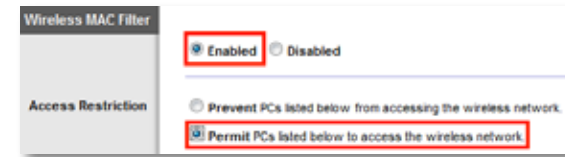

#### TIP

You can also use MAC filtering to prevent specific PCs from accessing your network by selecting **Prevent**. However, it’s easier to permit only known devices than to exclude unknown devices.

5. Click **Wireless Client List**. A separate window opens and displays the currently connected devices. In the example below, the only device permitted onto the network is the MacBook. However, two other devices are also connected to the network.



6. Next to the device entry, select **Save to MAC Address Filter List**, then click **Add**. The Mac Address Filter List is updated with the MAC address of the device you added.

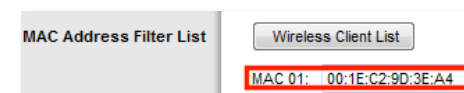

- Click **Save Settings** at the bottom of the page.
- Click **Wireless Client List** again to check the updated device list. Only the device you selected remains on the network.

Client Name	Interface	IP Address	MAC Address	Status	Save to MAC Address Filter List
MacBook	Wireless-N	192.168.1.25	08:1E:C2:5D:3E:A4	Connected	<input checked="" type="checkbox"/>

Add Refresh Close

## How to improve security using the built-in firewall

**Why would I need to change my security settings?** By default, the firewall settings in your router have been optimized for most home environments, so no changes are needed. The *SPI* (Stateful Packet Inspection) firewall is enabled by default. In addition, anonymous Internet requests and IDENT requests are filtered by default. All web filters are disabled, because enabling them may cause problems for sites that depend on ActiveX controls, Java, or cookies.

### General firewall settings

#### To change your firewall settings:

*Security->Firewall*

- Log into the browser-based utility (see “How to open the browser-based utility” on page 25).
- Click the **Security** tab, then click the **Firewall** page. (Not all routers have the options shown here.)

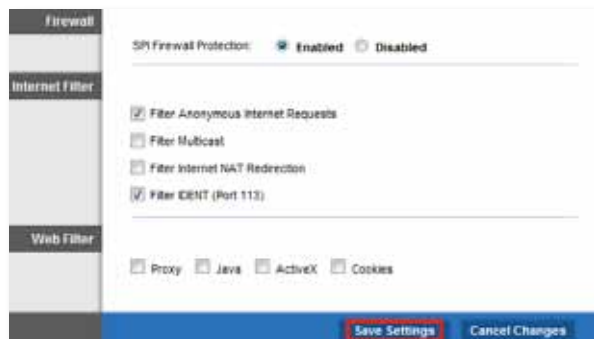

- Select each setting that you want to change.

#### TIP

For descriptions of the filters, click **Help** on the right side of the screen. More complete descriptions are included below.

- SPI Firewall Protection**—This helps protect your local network from Internet threats. This option is enabled by default. On some router models, this setting is separated into IPv6 and IPv4 options so that each can be handled separately.

#### CAUTION

To help protect your network, you should keep this option enabled.

- Filter Anonymous Internet Requests**—This filter blocks Internet requests from unknown sources such as ping requests. This option is enabled by default.
- Filter Multicast**—Multicasting allows a single transmission to simultaneously reach specific recipients within your local network. Select this option to block multicasting. This option is disabled by default.
- Filter Internet NAT Redirection for IPv4 Internet Only**—This filter prevents a local computer from using a URL or Internet IP address to access the local server. Select this option to enable the filter. This option is disabled by default. On some router models, this setting applies to IPv4 Internet only.
- Filter IDENT (Port 113)**—This filter prevents port 113 from being scanned by devices from the Internet. This option is enabled by default.
- Proxy**—This filter blocks the use of Internet proxy servers. To deny proxy requests, select this option. Proxy access is allowed by default. (Not available on the E4200.)
- Java**—This filter blocks Java, so you may not be able to access Java content on websites. To deny Java requests, select this option. Java content is allowed by default. (Not available on the E4200.)

- **ActiveX**—This filter blocks ActiveX, so you may not be able to access ActiveX content on websites. To deny ActiveX requests, select this option. ActiveX content is allowed by default. (Not available on the E4200.)
  - **Cookies**—This filter blocks cookies, which are data stored on your computer and used by websites when you interact with them. To deny cookie requests, select this option. Cookie usage is allowed by default. (Not available on the E4200.)
4. Click **Save Settings** to update your changes.

### IPv6 firewall settings

For **E900** **E1200V2** **E1500** **E2500** **E3200** **E4200**

On some router models, the IPv6 firewall lets you customize IPv6 port services for applications. When users send these types of requests to your network via the Internet, the router will allow those requests to the appropriate computers.

#### NOTE

To use your router's IPv6 Internet connectino settings, IPv6 service from your ISP (Internet service provider) is required. For more information on this service, ask your ISP.

### To set IPv6 firewall settings:

*Applications & Gaming->IPv6 Firewall*

1. Log into the browser-based utility (see "How to open the browser-based utility" on page 25).
2. Click the **Applications & Gaming** tab, then click the **IPv6 Firewall** page.

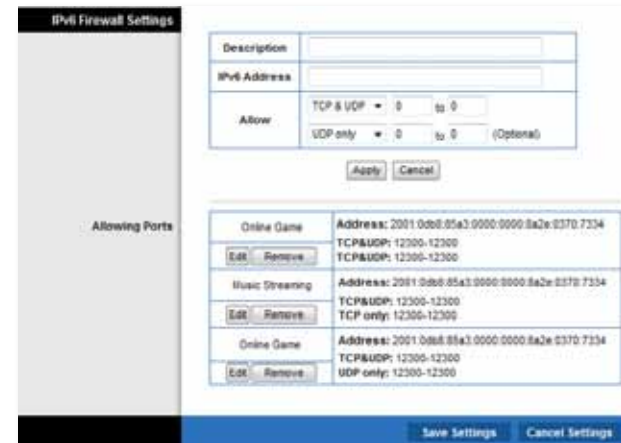

3. Select each setting that you want to change.
  - **Description**—Enter a description of the application.
  - **IPv6 Address**—Enter the IPv6 address of the computer that should receive the traffic.
  - **Allow**—Select the protocol(s) and range of port(s) used by incoming traffic.
4. Click **Apply** to save your changes. The *Allowing Ports* section lists the settings you have saved.
5. To change a saved setting, click **Edit**. To delete a saved setting, click **Remove**.

# Using an External Drive

## How to configure storage

For **E3200** **E4200**

**Why would I need to configure storage?** By default, when you connect a storage device to your router, the entire contents of the device are available for read and write access to anyone on your local network (no login credentials are required). However, you can also create shared folders that you can configure to share only with specified groups.

**To control access to the USB drive attached to your router, you need to perform two tasks:**

1. Create one or more shared folders (see “How to create shared folders” below)
2. Manage group and User Access to Shared Folders (see “How to share folders and set access rights” on page 53)

## How to create shared folders

**To create a shared folder:**

*Storage > Disk*

1. Log into the browser-based utility (see “How to open the browser-based utility” on page 25).
2. Click the **Storage** tab, then click the **Disk** page.



3. Click **Create Share** next to the partition you want to share. The *Shared Folder* screen opens.
4. If you want to share the entire partition, select **Share Entire Partition**, then click **Save Settings** at the bottom of the screen.



- OR -

If you want to share a specific folder:

- a. Enter a unique name in the **Display Name** field.
- b. Click **Select** next to the folder name you want to share.
  - To open a subfolder, click **Enter into Folder**.
  - To navigate to a previous folder, click **Return to Upper Folder**.
  - To create a new folder, type the name into the **New Folder** field, then click **Create**.

- c. Click **Save Settings** at the bottom of the screen, then repeat the above steps to add more folders that you want to share.



## How to manage group and user access to shared folders

To manage access to shared folders, you need to disable Anonymous Disk Access, then create groups and user accounts on your router. Access to the router is controlled by user accounts, but access to shared folders is controlled by groups.

1. Disable Anonymous Disk Access (see “How to disable anonymous disk access” on page 49).
2. Create a group that you will use to assign rights to a shared folder.
3. Create users and assign those users to the group.
4. Add the group to the shared folder that you want to control.

## How to disable anonymous disk access

By default, no password is needed for read and write access to the drive. Before you can manage group and user access to shared folders, you must disable anonymous disk access.

### To disable anonymous disk access:

*Storage > Administration*

1. Log into the browser-based utility (see “How to open the browser-based utility” on page 25).
2. Click the **Storage** tab, then click the **Administration** page.
3. Next to *Anonymous Disk Access*, select **Disabled**.



4. Click **Save Settings** at the bottom of the screen.

## How to create a group

By default, the default Admin group has read and write access to all shared folders. By default, the Guest group has read only access and has no access rights to any of the shared folders.

### IMPORTANT

More than one group can be configured with access to a shared folder, but a user can be a member of only one group.

### To create a group:

*Storage > Administration*

1. Log into the browser-based utility (see “How to open the browser-based utility” on page 25).
2. Click the **Storage** tab, then click the **Administration** page.

- Under *Group Management*, click **Create New Group**.

**Group Account**

Group Name:

Description:

Access:

- Complete the **Group Name** and **Description** fields.
- From the **Access** drop-down list, select **read-only** to grant read-only rights to the group, or select **read-and-write** to grant read and write rights to the group.
- Click **Create**. The group is now created, and its access rights are displayed in the **Access** column.
- To change a group's name or access rights, click **Edit** next to the group name.
- To delete a group, click **Delete** next to the group name.

**Group Management**

Group Name	Access	Edit	Delete
admin	r & w	--	--
guest	r	--	--
PhotoFriends	r	<input type="button" value="Edit"/>	<input type="button" value="Delete"/>

### How to create a new user

Two user accounts (*Admin* and *Guest*) are preconfigured for router access. The password for the *Admin* user is the same password that you use to access the router. By default, the user *Admin* is a member of the group named *Admin*, and the user *Guest* is a member of the group named *Guest*. To keep it simple, consider creating user accounts on your router that use the same user names and passwords that are used by your computer's operating system.

**NOTE**

Users can be a member of only one group.

**To create a new user:**

*Storage > Administration*

- Log into the browser-based utility (see "How to open the browser-based utility" on page 25).
- Click the **Storage** tab, then click the **Administration** page.
- Under *User Management*, click **Create New User**.

**User Management**

User Name	Group	Edit	Delete
admin	admin	<input type="button" value="Edit"/>	--
guest	guest	<input type="button" value="Edit"/>	--

- Complete the **Name**, **Full Name**, and **Description** fields.
- Enter and confirm a password.

- From the **Group Member** drop-down list, select the group to assign the user to, then click **Create**. The new user is displayed in the user list.

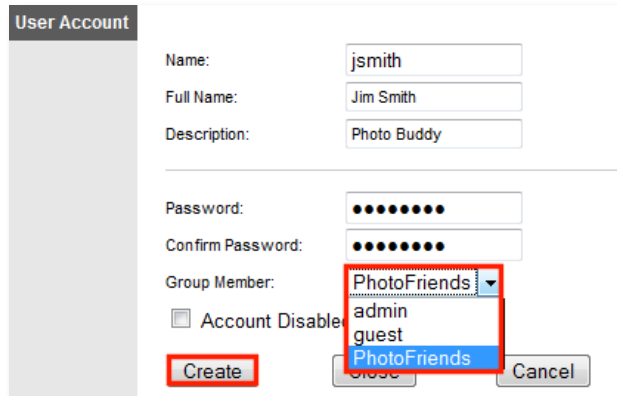

- To change the user name, description, or group membership, or to temporarily disable the account, click **Edit**.

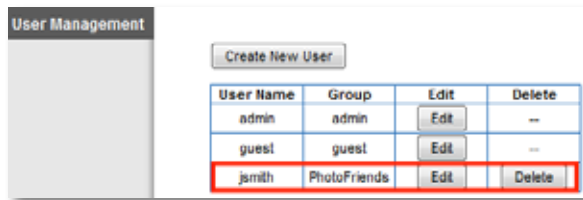

- To delete the user, click **Delete**.

## How to grant group access to a share

### To grant group access to a share

Storage > Disk

- Log into the browser-based utility (see "How to open the browser-based utility" on page 25).
- Make sure that *Anonymous Disk Access* has been disabled. (See "How to disable anonymous disk access" on page 49.)
- Click the **Storage** tab, then click the **Disk** page.

- In the *Shared Folder* section, click **Edit** next to the shared folder you want to change group access for.

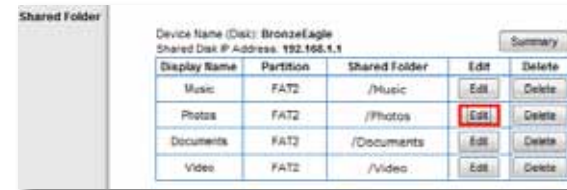

- To grant a group access the shared folder, click the group's name in the *Available Groups* column, then click >> to move the group to the *Groups with Access* column.
- To remove a group's access to the shared folder, click the group's name in the *Groups with Access* column, then click << to move the group to the *Available Groups* column.



- Click **Save Settings** to apply your changes.



## How to configure your router's storage for remote access

For **E3200** **E4200**

**Why would I need to access my router's storage remotely?** If your router's storage is set up for remote access, you can access your files anywhere you have an Internet connection. To do this, you must enable the router's built-in FTP (File Transfer Protocol) server. After your router is set up, you can access files from anywhere by using either a web browser or FTP software.

**To set up your router for remote file access, you need to:**

1. Configure the FTP server
2. Select folders (or the entire drive) to share and set access rights for those folders

## How to configure the FTP server

**To configure the FTP server:**

*Storage > FTP Server*

1. Log into the browser-based utility (see "How to open the browser-based utility" on page 25).
2. Click the **Storage** tab, then click the **FTP Server** page.

3. Next to *FTP Server*, click **Enabled**.



### TIP

If you used Cisco Connect to set up your router, the FTP Server Name field is already completed with the name of your wireless network. If you set up your router manually, the default name is Cisco followed by the last five digits of the router's serial number.

4. You can also:
  - Change the **FTP Port** (default is **21**) for the FTP server
  - Change the **Encoding** (character set) for the transfer of files in other languages. The router supports:
    - Unicode (UTF-8) (default)
    - Chinese Simplified (GB18030)
    - Vietnamese (CP1258)
    - ISO 8859\_1.

### TIP

For field descriptions, click **Help** on the right side of the screen.

5. To apply your changes, click **Save Settings**.



## How to share folders and set access rights

You can select which folders to share. You can also select which users can access the folders. For more information on managing access rights, see “How to configure storage” on page 48.

### To configure FTP and control folder access:

Storage > FTP Server

1. In the *Storage* tab's *FTP Server* page, click **Specify Folder**.

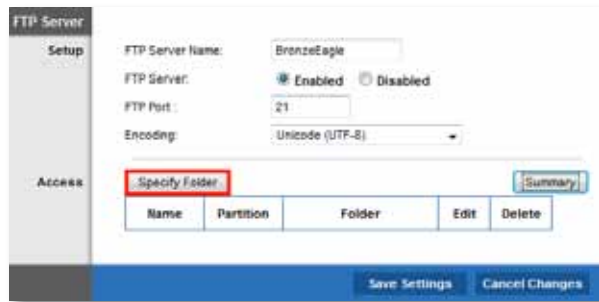

The *FTP Folder* screen opens in a separate window.

2. In the **Display Name** field, enter a unique name for the FTP folder. The name must use only alphanumeric characters (letters A to Z and numbers 0 to 9) and can be up to 15 characters long.
3. To share the entire drive, click **Share Entire Partition**.  
– OR –  
To share only specific folders:
  - Click **Select** next to the folder you want to share.
  - To navigate to a previous folder, click **Return to Upper Folder**.
  - To view and select folders within a folder, click **Enter into Folder** next to the folder name.
4. To create a folder, enter a unique folder name into the **New Folder** box, then click **Create**.
5. To change group access, select a group in the *Available Groups* or *Groups with Access* column, then click >> or << to move the group to the other column.

6. To apply your changes and enable FTP access, click **Save Settings**.



7. To apply your changes and create the shared folder for FTP access, click **Save Settings**. You are returned to the *FTP Server* page, where a summary of shared folders is displayed.
8. To modify shared folder settings:
  - To change a FTP folder's name or group access, click **Edit**.
  - To delete an FTP folder, click **Delete**.
  - To see a detailed summary of FTP folders, click **Summary**. A separate window opens and shows the folder's *Display Name*, *Partition*, *Share Folder*, and *Groups with Access*. Click **Close** to close the window.



## How to access files remotely

For **E3200** **E4200**

To access files remotely, you must first attach a USB drive to your router and set up that storage for remote access. For instructions, see “How to configure your router’s storage for remote access” on page 52. You can then access files from anywhere on the Internet.

### To access files remotely:

1. Make sure that your router is configured to share files. For more information, see “How to configure your router’s storage for remote access” on page 52.
2. Make sure that your router has user accounts set up, and that you have taken note of the user name and password you will use to access the router’s storage. If you have enabled Anonymous FTP (not recommended), you will not need a user name and password. For more information, see “How to configure storage” on page 48.
3. Take note of the IP address of your router. To view your router’s IP address, open the browser-based utility, click the **Status** tab, then click the **Router** page and take note of the numbers in the *Internet IP Address* field.

– OR –

If you have *DDNS* (Dynamic Domain Name Service), take note of the domain name registered to your router. For more information, see “How to find your network on the Internet” on page 30.

4. At any remote location where you can access the Internet, you can:
    - Use FTP (File Transfer Protocol) client software to connect to your router. You will need to enter your router’s IP address. If access to your router requires a user name and password, you will also need to enter those details. For more information on using the FTP client software, see its documentation or help.
- OR –
- Type the router’s IP address into a web browser’s Internet address field, press **Enter**, then enter your user name and password.

FTP software and web browsers display FTP content in many ways, but you can usually use these common actions to navigate through FTP folders:

- Click a folder name to open it.
- Click a double period (..) or **Up to a higher level directory** to open a parent folder.
- Click or right-click a file to download or view it.
- Drag a file from another window and drop it into the FTP window to upload it. (To upload a file, your user account must have write access.)

## How to set up your router as a media server

For **E4200**

**What is a media server and how would I use it?** A media server lets you share media content across your network. Your router can act as a media server if it has a USB drive attached and if you have UPnP AV (Audio and Video)-enabled or DLNA (Digital Living Network Alliance)-certified devices in your home. Examples of UPnP AV-enabled devices include digital media players, gaming consoles with a built-in media player, and digital picture frames.

For example, if you have a digital media adapter that sends content to your entertainment system, and if your router’s set up as a media server, then the digital media adapter can access your router’s attached USB drive.

You can specify which folders are used by the media server, add and delete folders, and specify how often the folders are scanned for new content.

### To configure your router as a media server:

*Storage > Media Server*

1. Log into the browser-based utility (see “How to open the browser-based utility” on page 25).
2. Click the **Storage** tab, then click the **Media Server** page.
3. Click **Enabled** to enable the media server.

Media Server Name:

UPnP Media Server:  **Enabled**  Disabled

- Enter a name for your media server in the **Media Server Name** box. The name must use only alphanumeric characters (letters A to Z and numbers 0 to 9) and can be up to 15 characters long.
- Click **Specify Folder to Scan**. A new window opens.

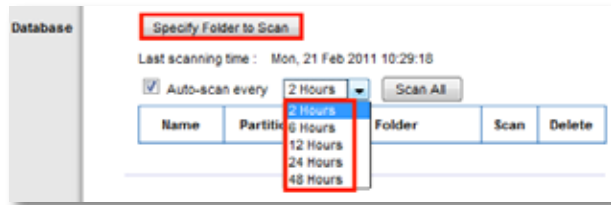

- In the **Display Name** field, enter a unique name for the media folder. The name must use only alphanumeric characters (letters A to Z and numbers 0 to 9) and can be up to 15 characters long.
- To share the entire drive, click **Share Entire Partition**.
  - OR –
  - To share only specific folders:
    - Click **Select** next to each folder you want to share.
    - To navigate to a previous folder, click **Return to Upper Folder**.
    - To view and select folders within a folder, click **Enter into Folder** next to the folder name.

- To create a folder, enter a unique folder name into the **New Folder** box, then click **Create**.



- To save your selections and create the media folder, click **Save Settings**. A summary of shared folders is displayed
- To delete an individual media folder, click **Delete**.

#### NOTE

If you delete a media folder, you are not deleting the folder's contents. You are only removing it as a folder that the media server will use.

- To manually scan all shared folders, click **Scan All**.
  - OR –
  - To scan an individual folder, click **Scan** next to the folder.
- To schedule a scan of the media folder for new media content, select **Auto-scan every**, then select a time interval from the drop-down list.

## How to connect your UPnP device to the media server

After you set up your router's media server, you need to connect an UPnP-compatible device (such as an UPnP-compatible game console or digital media player) to the network so that you can play the media server's content.

### To connect an UPnP device to your router's media server:

1. Connect your UPnP device to your home network with wired (Ethernet cable) or wireless networking. If you are connecting wirelessly, you need to know your network's name and password. See your device's documentation for help.
2. On your UPnP device, change the media source to the media server name you specified on your router. (See "How to set up your router as a media server" on page 54)
3. See your UPnP device's documentation for help with playing media on the device.

# Port Forwarding and Port Triggering

## How to set up port forwarding

For **ALL**

Why would I use port forwarding? Port forwarding is a feature that forwards inbound traffic from the Internet on a specific port or ports to a specific device or port on your local network. You can set up port forwarding for:

- A single port (see “How to set up port forwarding for a single port” below)
- Multiple ports (see “How to set up port forwarding for multiple ports” on page 58)
- A range of ports (see “How to set up port forwarding for a range of ports” on page 58)

## How to set up port forwarding for a single port

**Why would I use port forwarding for a single port?** Single port forwarding is a feature that forwards inbound traffic from the Internet on a specific port to a single device on your local network. An example of single port forwarding would be to forward inbound web requests, typically on port 80, to a web server.

### To set up single port forwarding:

*Applications & Gaming > Single Port Forwarding*

1. Follow your device’s instructions for configuring it with a static IP address or use DHCP reservation to assign it a permanent address (see “How to set up the DHCP server on your router” on page 29).
2. Log into the browser-based utility (see “How to open the browser-based utility” on page 25).

3. Click the **Applications & Gaming** tab, then click the **Single Port Forwarding** page.

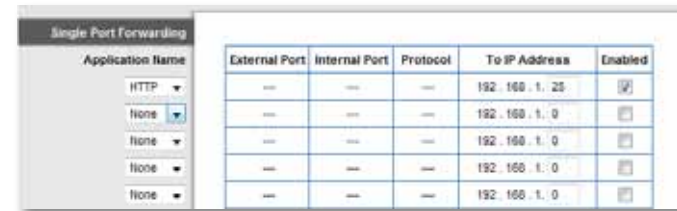

4. Select the type of application from the **Application Name** drop-down list. One of the more common types to select is **HTTP**, but see your device’s documentation for recommendations.
5. In the **To IP Address** field, enter the last three digits of the IP address you have reserved for the computer you want to forward Internet traffic to. The rest of the IP address has already been completed for you.
6. Select **Enabled** next to the *IP Address field*.
7. Click **Save Changes** at the bottom of the screen.

### TIP

For other devices not included in the Application Name drop-down list, see the device’s documentation for port and protocol information.

## How to set up port forwarding for multiple ports

**Why would I set up port forwarding for multiple ports?** Port forwarding is a feature that forwards inbound traffic from the Internet on a specific port to a single device on your local network. Unlike a web camera that typically only requires a single port to be forwarded, some applications require forwarding of multiple ports. VNC (Virtual Network Computing) software that allows you to operate your computer remotely from anywhere on the Internet is an example of an application that requires multiple ports to be forwarded. To forward to multiple ports, just create additional entries to forward additional ports to the same IP address.

*Example:* You want to set up your computer so you can remotely access it using VNC software. By default, VNC uses TCP ports 5800 and 5900.

### To set up single port forwarding for multiple ports:

*Applications & Gaming > Single Port Forwarding*

1. Make sure that the software you want to use has been installed onto a networked computer.
2. Log into the browser-based utility (see “How to open the browser-based utility” on page 25).
3. Set up DHCP reservation for the IP address of the computer on which you installed the software. (See “How to set up the DHCP server on your router” on page 29).
4. Click the **Applications & Gaming** tab, then click the **Single Port Forwarding** page.
5. For each entry, enter a descriptive name in the **Application Name** field.
6. For each entry, enter in the same port number for the **External Port** and the **Internal Port**.
7. In the **To IP Address** field, enter the last three digits of the IP address you have reserved for the computer you want to forward Internet traffic to. The rest of the IP address has already been completed for you.

8. Select **Enabled** next to the *IP Address* field.

Application Name	External Port	Internal Port	Protocol	To IP Address	Enabled
HTTP	---	---	---	192.168.1.25	<input type="checkbox"/>
None	---	---	---	192.168.1.0	<input type="checkbox"/>
None	---	---	---	192.168.1.0	<input type="checkbox"/>
None	---	---	---	192.168.1.0	<input type="checkbox"/>
None	---	---	---	192.168.1.0	<input type="checkbox"/>
VNC Default	5800	5900	TCP	192.168.1.140	<input checked="" type="checkbox"/>
VNC Java	5900	5900	TCP	192.168.1.140	<input checked="" type="checkbox"/>

9. Click **Save Changes** at the bottom of the screen.

### NOTE

If you want to use software such as VNC on multiple computers, you will need to reconfigure the default ports that VNC uses on each additional computer. Then, create additional port forwarding entries for each additional computer. See your software’s documentation for help.

## How to set up port forwarding for a range of ports

**Why would I set up port forwarding for a range of ports?** Port forwarding is a feature that forwards inbound traffic from the Internet on a range of ports to a single device on your local network. Unlike a web camera that typically only requires a single port to be forwarded, some applications require forwarding to a range of ports.

*Example:* You want to set up your computer so you can use BitTorrent, a popular peer-to-peer file sharing application. BitTorrent uses port 6881 by default. If that port is busy, the requesting BitTorrent client tries the next port in sequence. The most common configuration for home routers with a single BitTorrent computer is to set up port forwarding using a range of ports starting with 6881 and ending with port 6889.



**To set up port range forwarding:**

*Applications & Gaming > Port Range Forwarding*

1. Log into the browser-based utility (see “How to open the browser-based utility” on page 25).
2. Set up a DHCP reservation for the IP address of the computer on which you installed the software. (See “How to set up the DHCP server on your router” on page 29). In this example, the IP address of the desktop computer with BitTorrent installed is 192.168.1.140.
3. Click the **Applications & Gaming** tab, then click the **Port Range Forwarding** page.
4. Enter a descriptive name, then enter the **Start Port** and the **End Port** values to specify the range. In this example, the range is 6881 to 6889.
5. Select **TCP** as the protocol.
6. In the **To IP Address** field, enter the last 3 digits of the IP address of the device running the software. The rest of the IP address fields already completed. In this example, you would enter 140.
7. Select **Enabled** next to the *To IP Address* field.

Application Name	Start - End Port	Protocol	To IP Address	Enabled
BitTorrent - Desktop	6881 to 6889	TCP	192.168.1.140	<input checked="" type="checkbox"/>
BitTorrent - MacBook	6890 to 6899	TCP	192.168.1.142	<input checked="" type="checkbox"/>

8. Click **Save Settings** at the bottom of the page.

**NOTES:**

To use software like BitTorrent on multiple computers on your network, create additional entries with a unique range of ports as shown above. BitTorrent only works with ports between 6881 and 6999.

Depending on your computer’s firewall software, you may need to open a range of ports in your firewall to enable software that uses port range forwarding

## How to set up port range triggering for online gaming

For **ALL**

**Why would I use port triggering instead of port forwarding?** Port range triggering allows the router to watch outgoing data for specific port numbers. The IP address of the computer that sends the matching data is remembered by the router, so that when the requested data returns through the router, the data is routed back to the proper computer. An example of port range triggering would be to enable a USB or Bluetooth headset for online chat and gaming.

**To set up port range triggering for multiple entries:**

*Applications & Gaming > Port Range Triggering*

1. Log into the browser-based utility (see “How to open the browser-based utility” on page 25).
2. Click the **Applications & Gaming** tab, then click the **Port Range Triggering** page.
3. See your device documentation for information on the ports that the device uses.
4. For each entry in the *Port Range Triggering* table:
  - Enter a descriptive name (such as *PS3 Headset*)
  - For single ports, enter the same port number in each **Triggered Range** and **Forwarded Range** box.
  - For port ranges, enter the same number ranges in each **Triggered Range** and **Forwarded Range** column.

Application Name	Triggered Range	Forwarded Range	Enabled
PS3Headset	80 to 80	80 to 80	<input checked="" type="checkbox"/>
PS3Headset	8000 to 7000	8000 to 7000	<input checked="" type="checkbox"/>
PS3Headset	10700 to 10700	10700 to 10700	<input checked="" type="checkbox"/>
PS3Headset	50000 to 50000	50000 to 50000	<input checked="" type="checkbox"/>

5. Click **Save Settings** at the bottom of the page.



## How to configure your Xbox for online gaming

For **ALL**

**Why would I set up my Xbox for online gaming?** Online gaming adds another dimension to using your Xbox. As with other online gaming applications and gaming consoles, you need to forward multiple ports to use your Xbox for online gaming. The procedure for setting up your Xbox is almost identical to setting up multiple port forwarding for VNC remote control. (See “How to set up port forwarding for multiple ports” on page 58).

### NOTE

For more information on configuring your router for online gaming, see “How to optimize your router for gaming and voice” on page 32.

Refer to your game console documentation to determine the ports used by your device. The Xbox uses four ports:

- TCP port 80
- UDP port 88
- TCP/UDP port 53
- TCP/UDP port 3074

### To set up an Xbox using multiple entries of single port forwarding:

*Applications & Gaming > Single Port Forwarding*

1. Connect your Xbox 360 to your router.
1. Log into the browser-based utility (see “How to open the browser-based utility” on page 25).
2. Set up a DHCP reservation for the IP address of the Xbox. (See “How to set up the DHCP server on your router” on page 29).

– OR –

Refer to your game console’s documentation to set a static IP address for your device.

3. Click the **Applications & Gaming** tab, then click the **Single Port Forwarding** page. The Xbox uses four ports, so create four port forwarding entries on this page.

4. Enter the port and protocol information as shown in the image below.

Application Name	External Port	Internal Port	Protocol	To IP Address	Enabled
HTTP	---	---	---	192.168.1.25	<input checked="" type="checkbox"/>
None	---	---	---	192.168.1.0	<input type="checkbox"/>
None	---	---	---	192.168.1.0	<input type="checkbox"/>
None	---	---	---	192.168.1.0	<input type="checkbox"/>
None	---	---	---	192.168.1.0	<input type="checkbox"/>
XBoxLive	80	80	TCP	192.168.1.125	<input checked="" type="checkbox"/>
XBoxLive	88	88	UDP	192.168.1.125	<input checked="" type="checkbox"/>
XBoxLive	53	53	Both	192.168.1.125	<input checked="" type="checkbox"/>
XBoxLive	3074	3074	Both	192.168.1.125	<input checked="" type="checkbox"/>

5. In the **To IP Address** field, enter a 1- to 3-digit number that corresponds to the last three digits of the IP Address of the Xbox 360. The rest of the IP address is already completed.
6. Select **Enabled** next to the *To IP Address* field for each entry.
7. Click **Save Settings** at the bottom of the page.

# Maintaining and Monitoring

## How to back up and restore your router configuration

For **ALL**

**Why do I need to back up my router configuration?** As with any valuable data, you should back up your router configuration. Your router might contain many customized settings. Those settings would be lost if you reset your router to its factory defaults, and you would need to re-enter all of them manually. If you back up your router configuration, restoring settings is easy.

### To back up your router configuration:

*Administration > Management*

1. Log into the browser-based utility (see “How to open the browser-based utility” on page 25).
2. Click the **Administration** tab, then click the **Management** page.
3. Click **Back Up Configurations** at the bottom of the screen.



You are prompted to save the file.

4. Click **OK** or **Save**.



5. Specify a file location, then click **Save**.

### To restore your router configuration:

*Administration > Management*

1. Log into the browser-based utility (see “How to open the browser-based utility” on page 25).
2. Click the **Administration** tab, then click the **Management** page.
3. Click **Restore Configurations** at the bottom of the screen.

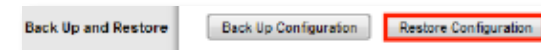

A separate window opens.

4. Click **Browse** to navigate to the location of your configuration file, then select the file and click **Open**.
5. To restore the configuration, click **Start to Restore**.

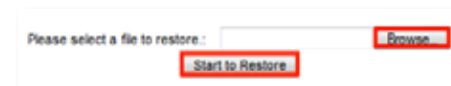

## How to restore factory defaults

**Why would I need to restore to factory defaults?** If you are experiencing difficulties with the router and have exhausted all other troubleshooting measures, you may want to reset the router to factory defaults. Resetting the router erases all of your settings, so you must restore the settings after. We recommend that you back up your configuration before resetting your router to factory defaults. See “How to back up and restore your router configuration” on page 61.

You can use the Reset button or the router’s browser-based utility to restore your router to factory defaults.

**To reset your router to factory defaults with the reset button:**

**CAUTION**

Whenever you restart the router, all logs that are not saved will be lost.

1. With your router connected to power and turned on, press and hold the **Reset** button on the bottom of your router for 5-10 seconds.



E1200, E1500, E2500, and E3200 Reset Button



E4200 Reset Button

**To reset your router to factory defaults using the browser-based utility:**

*Administration > Factory Defaults*

1. Log into the browser-based utility (see “How to open the browser-based utility” on page 25).
2. Click the **Administration** tab, then click the **Factory Defaults** page.

3. Click **Restore Factory Defaults**.

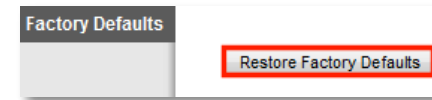

A confirmation window opens.

4. Click **OK**.



## How to upgrade the router's firmware

For **ALL**

**Why would I need to upgrade my router's firmware?** Linksys may periodically publish a firmware upgrade either to fix a problem or to add features to your router.

**IMPORTANT**

Do not interrupt the upgrade process. You should not turn off the router or press the Reset button during the upgrade. Doing so may permanently disable the router.

If you are upgrading from a laptop computer, make sure that the laptop is connected to a power source or that the battery is fully charged.

Disable your computer's Sleep mode. It might interrupt the upgrade process.

If you are upgrading from a computer with a wireless network connection, make sure that you have strong wireless signal strength. If not, move your computer closer to your router.

**TIPS**

Each time you run Cisco Connect, it checks for software updates and installs them, if available. Use the following instructions only if you don't run Cisco Connect.

**To upgrade the router's firmware:**

For **E900** **E1200** **E1200V2** **E1500** **E2500** **E3200**

[Linksys.com/support](http://Linksys.com/support)  
Administration > Firmware Upgrade

1. Log into the browser-based utility (see "How to open the browser-based utility" on page 25).
2. Click the **Status** tab, then click the **Router** page and take note of the current firmware version for your router.
3. Using your web browser, connect to [Linksys.com/support](http://Linksys.com/support), then find your router model.
4. Click the **Downloads** tab, then select the hardware version for your router from the **Select Hardware Version** drop-down list.



5. Compare the latest available firmware version on the website with your current version. If there is a newer version, click **Release Notes** to see if the newer version contains new features you want or solves a problem you are having.
6. If you want the new version, click **Download** and save the file to your computer. Take note of the file location.



During the upgrade process, the router may lose the settings you have changed. Make a backup of your router configuration *before* starting the upgrade process. See "How to back up and restore your router configuration" on page 61.

7. In the browser-based utility, click the **Administration** tab, then click the **Firmware Upgrade** page.
8. Click **Browse**, then go to the location where you saved the upgrade file.
9. Select the upgrade file, then click **Start Upgrade** and follow the on-screen instructions. The upgrade process begins, and a progress bar appears. When the firmware has been uploaded, a new page opens with an "Upgrade is successful" notice, and the router reboots.



**To upgrade the router's firmware:**

For **E4200**

Administration > Firmware Upgrade

1. Log into the browser-based utility (see "How to open the browser-based utility" on page 25).
2. Click the **Administration** tab, then click the **Firmware Upgrade** page.
3. Click **Check For Updates**, then follow the on-screen instructions for installing any available updates.

**TIP**

To have your router automatically check for updates, select **Update Automatically**. The router will check for updates at midnight according to the time zone setting on the Basic Setup page. If an update is found, it will be immediately installed, then the router will restart.

## How to check the status of your router

For **ALL**

**Why would I want to check the status of my router?** Your router status tells you whether you have a secure Internet connection and informs you about the status of your network-connected devices.

### To check your router status using Cisco Connect:

1. In Windows, click **Start, All Programs**, then click **Cisco Connect**.  
– OR –  
On a Mac, open the **Applications** folder, then click **Cisco Connect**.  
The Cisco Connect main menu opens.
2. Look in the upper-right corner of the Cisco Connect main menu. If your router is online and secure, you see *online secure* and a green indicator.

### To check your router status using the browser-based utility:

Status > Router  
Status > Local Network  
Status > Wireless Network  
Status > Ports

1. Log into the browser-based utility (see “How to open the browser-based utility” on page 25).
2. Click the **Status** tab, then click the **Router** page. Detailed information about your router status is displayed. (Screen from IPv6-enabled router shown.)

#### TIP

For field descriptions, click **Help** on the right side of the screen.



- Click the **Status** tab, then click the **Local Network** page. Your local network's IP address information and the DHCP server settings are displayed. (Screen from IPv6-enabled router shown.)

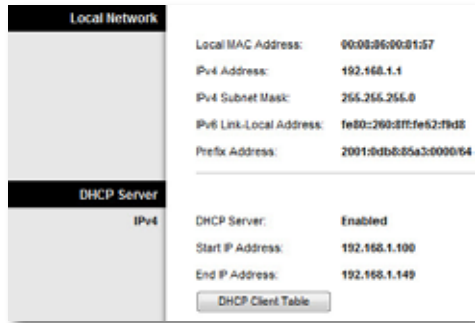

- Click **DHCP Client Table** to display the currently assigned IP addresses.

Client Name	Interface	IP Address	MAC Address	Expires Time	
Macbook	Wireless	192.168.1.139	00:1E:C2:8D:3E:A4	23:28:40	Delete
NetBook	LAN	192.168.1.140	00:24:8C:6D:FE:E9	23:28:24	Delete

Refresh Close

- Click the **Status** tab, then click the **Wireless Network** page. Your wireless network status is displayed.



- Click the **Status** tab, then click the **Ports** page. The link status and speed (speed data available only for the E3200 and E4200) for each of the Ethernet ports and the Internet port are displayed.

## How to disable the Ethernet port status lights

**Why would I want to disable the Ethernet port status lights?** Depending on the placement of the router in a home, some users might find the lights distracting. You can easily disable the lights using Cisco Connect, but you can also disable them using the browser-based utility.

### To disable the lights using Cisco Connect:

- In Windows, click **Start, All Programs**, then click **Cisco Connect**.  
– OR –  
On a Mac, open the **Applications** folder, then click **Cisco Connect**.  
The Cisco Connect main menu opens.
- Under **Router Settings**, click **Change**.
- Under **Port lights**, click **Off**, then click **Finish**.

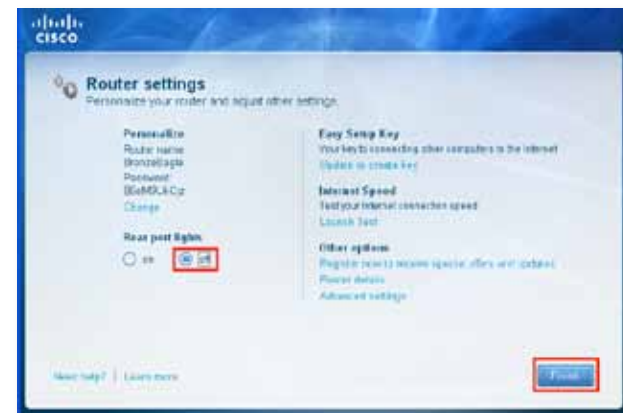



**To disable the lights using the browser-based utility:**

For **E900 E1200 E1200V2 E1500 E2500 E3200**

*Status > Ports*

1. Log into the browser-based utility (see “How to open the browser-based utility” on page 25).
2. Click the **Status** tab, then click the **Ports** page.
3. In the *Rear Port Lights* section, click **Off**, then click **Save Settings**.

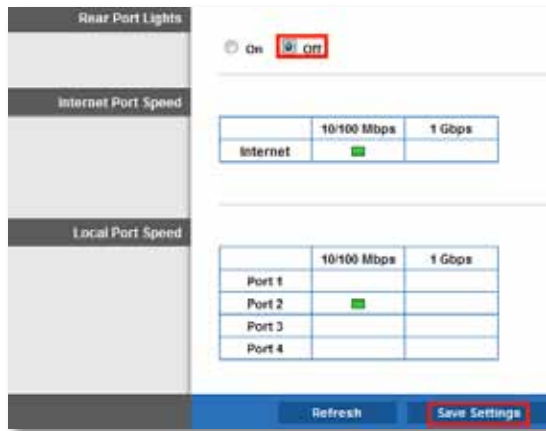

**To disable the lights using the browser-based utility:**

For **E4200**

*Setup > Basic Setup*

1. Log into the browser-based utility (see “How to open the browser-based utility” on page 25).
2. Click the **Setup** tab, then click the **Basic Setup** page.
3. Set **Rear Port Lights** to **Off**, then click **Save Settings** at the bottom of the page.

**How to test your Internet connection**

**What utilities are included in my router to test my Internet connection?**

Your router includes two diagnostic tests, Ping and Traceroute, that let you check network connections, including network devices and your Internet connection.

**To diagnose your Internet connection:**

*Administration > Diagnostics*

1. Log into the browser-based utility (see “How to open the browser-based utility” on page 25).
2. Click the **Administration** tab, then click the **Diagnostics** page.



3. To check whether an address can be reached, enter an IP address or URL, a packet size, and number of times to ping in the *Ping Test* section, then click **Start to Ping**.

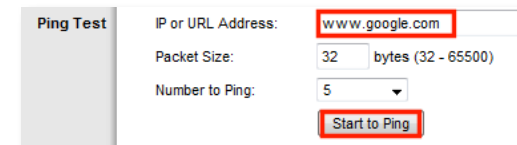



A window opens showing the ping test results. You will see a response for each successful ping.

**NOTE**

If an Internet URL fails to respond to ping, it doesn't necessarily mean that the site is down. For security reasons, some sites are configured to not respond to ping requests.

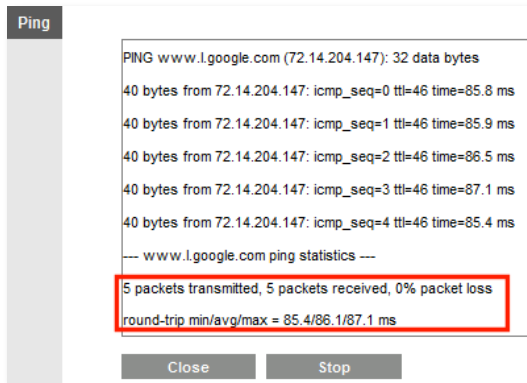

- To trace the route that packets take between your router and a specific address, enter an address in the **IP or URL Address** field of the *Traceroute Test* section, then click **Start to Traceroute**.



A window opens with the test results.



### How to configure and use logs

**What kind of logging capabilities does my router have?** Your router can track all traffic for your Internet connection. Your router supports four types of logs:

**CAUTION**

All logs that are not saved will be lost whenever the router restarts.

**To enable and view router logs:**

*Administration > Log*

- Log into the browser-based utility (see "How to open the browser-based utility" on page 25).
- Click the **Administration** tab, then click the **Log** page.
- To monitor traffic between the local network and the Internet, select **Enabled** (default), then click **Save Settings**.

4. To view the logs, click **View Log**. The *Log* window opens.

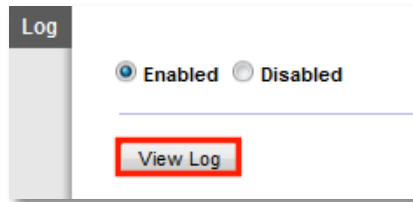

5. Select the log you want to see from the **Type** drop-down list.

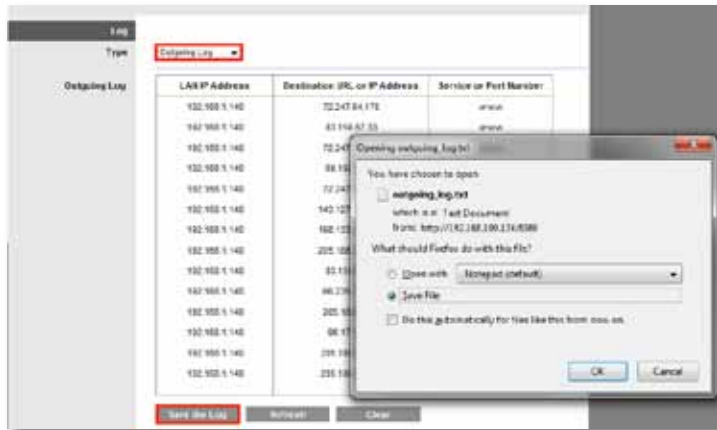

- **Incoming Log**—The source IP addresses and destination port numbers for incoming Internet traffic
  - **Outgoing Log**—Local IP addresses, destination URLs/IP addresses, and service/port numbers for outgoing Internet traffic
  - **Security Log**—Logins for the browser-based utility
  - **DHCP Client Log**—Local DHCP server status information
6. To save the log, click **Save the Log**, then click **OK** or **Save**.

#### CAUTION

All logs that are not saved will be lost whenever the router restarts.

# Browser-based Utility Menu Structure

## E900

### Setup

#### Basic Setup

- Language
- Internet Setup
  - Internet Connection Type
  - Optional Settings
- Network Setup
  - Router Address
  - DHCP Server Setting
- Time Settings
  - Time Zone

#### Reboot

#### IPv6 Setup

- Internet Setup
  - Internet Connection Type
- Network Setup
  - 6rd Tunnel

#### DDNS

- DDNS
  - DDNS Service

#### MAC Address Clone

- MAC Address Clone

#### Advanced Routing

- NAT
- Dynamic Routing (RIP)
- Static Routing

### Wireless

#### Basic Wireless Settings

- Configuration View

#### Wireless Security

- Wireless Security

#### Wireless MAC Filter

- Wireless MAC Filter
  - Access Restriction
  - MAC Address Filter List

### Security

#### Firewall

- Firewall
- Internet Filter
- Web Filter
- VPN Passthrough
  - VPN Passthrough

### Applications & Gaming

#### Single Port Forwarding

- Single Port Forwarding

#### Port Range Forwarding

- Port Range Forwarding

#### Port Range Triggering

- Port Range Triggering

#### DMZ

- DMZ

#### IPv6 Firewall

#### QoS

- QoS (Quality of Service)
  - Wireless
  - Internet Access Priority
  - Upstream Bandwidth
  - Category
  - Summary

### Administration

#### Management

- Router Access
- Local Management Access
- Remote Management Access
- Advanced features
- UPnP
- Back up and Restore

#### Log

- Log

#### Diagnostics

- Diagnostics
  - Ping Test
  - Traceroute Test

#### Factory Defaults

- Factory Defaults

#### Firmware Upgrade

- Firmware Upgrade

### Status

#### Router

- Router Information
- Internet Connection
  - IPv4
  - IPv6

#### Local Network

- Local Network
- DHCP Server
  - IPv4
  - DHCP Client Table

#### Wireless Network

- Wireless Network

#### Ports

- Rear Port Lights
- Internet Port Link
- Local Port Link

## E1200/E1500

### Setup

- Basic Setup
  - Language
  - Internet Setup
    - Internet Connection Type
    - Optional Settings
  - Network Setup
    - Router Address
    - DHCP Server Setting
  - Time Settings
    - Time Zone
  - Reboot
- IPv6 Setup (E1200V2/E1500 only)
  - Internet Setup
    - Internet Connection Type
  - Network Setup
    - 6rd Tunnel
- DDNS
  - DDNS
    - DDNS Service
- MAC Address Clone
  - MAC Address Clone
- Advanced Routing
  - NAT
  - Dynamic Routing (RIP)
  - Static Routing

### Wireless

- Basic Wireless Settings
  - Configuration View
- Wireless Security
  - Wireless Security
- Guest Access
  - Guest Access
- Wireless MAC Filter
  - Wireless MAC Filter
    - Access Restriction
    - MAC Address Filter List

### Security

- Firewall
  - Firewall
  - Internet Filter
  - Web Filter
- VPN Passthrough
  - VPN Passthrough

### Access Policy

- Parental Controls
  - Target Devices
  - Schedule
  - Block Specific Sites

### Applications & Gaming

- Single Port Forwarding
  - Single Port Forwarding
- Port Range Forwarding
  - Port Range Forwarding
- Port Range Triggering
  - Port Range Triggering
- DMZ
  - DMZ
- IPv6 Firewall (E1200V2/E1500 only)
- QoS
  - QoS (Quality of Service)
    - Wireless
    - Internet Access Priority
    - Upstream Bandwidth
    - Category
    - Summary

### Administration

- Management
  - Router Access
  - Local Management Access
  - Remote Management Access
  - Advanced features
  - UPnP
  - Back up and Restore
- Log
  - Log
- Diagnostics
  - Diagnostics
    - Ping Test
    - Traceroute Test
- Factory Defaults
  - Factory Defaults
- Firmware Upgrade
  - Firmware Upgrade

### Status

- Router
  - Router Information
  - Internet Connection
    - IPv4
    - IPv6 (E1200V2/E1500 only)
- Local Network
  - Local Network
  - DHCP Server
    - IPv4
    - DHCP Client Table
- Wireless Network
  - Wireless Network
- Ports
  - Rear Port Lights
  - Internet Port Link
  - Local Port Link

## E2500

### Setup

- Basic Setup
  - Language
  - Internet Setup
    - Internet Connection Type
    - Optional Settings
  - Network Setup
    - Router Address
    - DHCP Server Setting
  - Time Settings
    - Time Zone
  - Reboot
- IPv6 Setup
  - Internet Setup
    - Internet Connection Type
  - Network Setup
    - 6rd Tunnel
- DDNS
  - DDNS
    - DDNS Service
- MAC Address Clone
  - MAC Address Clone
- Advanced Routing
  - NAT
  - Dynamic Routing (RIP)
  - Static Routing

### Wireless

- Basic Wireless Settings
  - Wi-Fi Protected Setup
    - 5 GHz Wireless Settings
    - 2.4 GHz Wireless Settings
  - Configuration View
- Wireless Security
  - 5 GHz Wireless Security
  - 2.4 GHz Wireless Security
- Guest Access
  - Guest Access
- Wireless MAC Filter
  - Wireless MAC Filter
    - Access Restriction

MAC Address Filter List

### Security

- Firewall
  - Firewall
  - Internet Filter
  - Web Filter
- VPN Passthrough
  - VPN Passthrough

### Access Policy

- Parental Controls
  - Target Devices
  - Schedule
  - Block Specific Sites

### Applications & Gaming

- Single Port Forwarding
  - Single Port Forwarding
    - Application Name
- Port Range Forwarding
  - Port Range Forwarding
    - Application Name
- Port Range Triggering
  - Port Range Triggering
- DMZ
  - DMZ
- IPv6 Firewall
- QoS
  - QoS (Quality of Service)
    - Wireless
    - Internet Access Priority
    - Upstream Bandwidth
    - Category
    - Summary

### Administration

- Management
  - Router Access
  - Local Management Access
  - Remote Management Access
  - Advanced features
  - UPnP
  - Back Up and Restore
- Log
  - Log
- Diagnostics
  - Diagnostics
    - Ping Test
    - Traceroute Test
- Factory Defaults
  - Factory Defaults
- Firmware Upgrade
  - Firmware Upgrade

### Status

- Router
  - Router Information
  - Internet Connection
    - IPv4
    - IPv6
- Local Network
  - Local Network
  - DHCP Server
    - IPv4
    - DHCP Client Table
- Wireless Network
  - 5 GHz Wireless Network
  - 2.4 GHz Wireless Network
- Ports
  - Rear Port Lights
  - Internet Port Link
  - Local Port Link

## E3200

### Setup

- Basic Setup
  - Language
  - Internet Setup
    - Internet Connection Type
    - Optional Settings
  - Network Setup
    - Router Address
    - DHCP Server Setting
  - Time Settings
    - Time Zone
  - Reboot
- IPv6 Setup
  - Internet Setup
    - Internet Connection Type
  - Network Setup
    - 6rd Tunnel
- DDNS
  - DDNS Service
- MAC Address Clone
- Advanced Routing
  - NAT
  - Dynamic Routing (RIP)
  - Static Routing

### Wireless

- Basic Wireless Settings
  - Wi-Fi Protected Setup
    - 5 GHz Wireless Settings
    - 2.4 GHz Wireless Settings
  - Configuration View
- Wireless Security
  - 5 GHz Wireless Security
  - 2.4 GHz Wireless Security
- Guest Access
- Wireless MAC Filter
  - Wireless MAC Filter
    - Access Restriction
    - MAC Address Filter List

### Security

- Firewall
  - Firewall
  - Internet Filter
  - Web Filter
- VPN Passthrough

### Storage

- Disk
  - Disk Management
    - Shared Folder
    - Format Disk
- FTP Server
  - Setup
  - Access
- Administration
  - Information
  - Anonymous Access
  - User Management
  - Group Management

### Access Policy

- Parental Controls
  - Target Devices
  - Schedule
  - Block Specific Sites

### Applications & Gaming

- Single Port Forwarding
  - Application Name
- Port Range Forwarding
  - Application Name
- Port Range Triggering
- DMZ
- IPv6 Firewall
- QoS
  - QoS (Quality of Service)
    - Wireless
    - Internet Access Priority
    - Upstream Bandwidth
    - Category
    - Summary

### Administration

- Management
  - Router Access
  - Local Management Access
  - Remote Management Access
  - Advanced features
  - UPnP
  - Back Up and Restore
- Log
- Diagnostics
  - Ping Test
  - Traceroute Test
- Factory Defaults
- Firmware Upgrade

### Status

- Router
  - Router Information
  - Internet Connection
    - IPv4
    - IPv6
- Local Network
  - Local Network
  - DHCP Server
    - IPv4
    - DHCP Client Table
- Wireless Network
  - 5 GHz Wireless Network
  - 2.4 GHz Wireless Network
- Ports
  - Rear Port Lights
  - Internet Port Link
  - Local Port Link

## E4200

### Setup

#### Basic Setup

- Language
- Internet Setup
  - Internet Connection Type
- Network Setup
  - Router Address
  - DHCP Server Setting
- Time Settings
  - Time Zone
- Port Lights
- Reboot

#### IPv6 Setup

- Internet Setup
  - Internet Connection Type
- Network Setup
  - 6rd Tunnel

#### DDNS

- DDNS Service

#### MAC Address Clone

#### Advanced Routing

- NAT
- Dynamic Routing (RIP)
- Static Routing

### Wireless

#### Wireless Settings

- Configuration View
- 5 GHz Wireless Settings
- 2.4 GHz Wireless Settings

#### Guest Access

#### Wireless MAC Filter

- Wireless MAC Filter
  - Access Restriction
  - MAC Address Filter List

### Security

#### Firewall

- Firewall
- Internet Filter

#### VPN Passthrough

### Storage

#### Disk

- Disk Management
- USB Port Speed
- Shared Folder

#### Media Server

- UPnP Media Server
- Setup
- Database

#### FTP Server

- Setup
- Share

#### Administration

- Information
- User Management
- Group Management

### Access Restrictions

#### Parental Controls

- Target Devices
- Schedule
- Block Specific Sites

### Applications & Gaming

#### Single Port Forwarding

- Application Name

#### Port Range Forwarding

- Application Name

#### Port Range Triggering

#### DMZ

#### IPv6 Firewall

#### QoS

- QoS (Quality of Service)
  - Wireless
  - Internet Access Priority
  - Upstream Bandwidth
  - Category
  - Summary

### Administration

#### Management

- Router Access
- Local Management Access
- Remote Management Access
- ALG
- UPnP
- Back Up and Restore

#### Log

#### Diagnostics

- Ping Test
- Traceroute Test

#### Factory Defaults

#### Firmware Upgrade

### Status

#### Router

- Router Information
- Internet IPv4 Connection
- Internet IPv6 Connection

#### Local Network

- Local Network
- DHCP Server

#### Wireless Network

- 5 GHz Wireless Network
- 2.4 GHz Wireless Network

#### Ports

- Internet Port Speed
- Local Port Speed



# Specifications

## Linksys E900

Model Name	Linksys E900
Description	Wireless-N300 Router
Model Number	E900
Switch Port Speed	10/100 Mbps (Fast Ethernet)
Radio Frequency	2.4 GHz
# of Antennas	2
Ports	Power, Internet, and Ethernet (1-4)
Buttons	Reset, Wi-Fi Protected Setup™
LEDs	Power/Wi-Fi Protected Setup, Internet, Ethernet (1-4)
UPnP	Supported
Security features	WEP, WPA, WPA2
Security Key Bits	Up to 128-bit encryption

## Environmental

Dimensions	188.7 × 151.7 × 31.2 mm (7.43" × 5.97" × 1.23")
Unit Weight	202.0g (7.13 oz.)
Power	12V, 0.5A
Certifications	FCC, UL/cUL, ICES-003, RSS210, CE, Wi-Fi (IEEE 802.11b/g/n), WPA2™, WMM®, Wi-Fi Protected Setup, Windows 7
Operating Temp.	0 to 40°C (32 to 104°F)
Storage Temp.	-20 to 60°C (-4 to 140°F)
Operating Humidity	10 to 80% non-condensing
Storage Humidity	5 to 90% non-condensing

### NOTES

For regulatory, warranty, and safety information, see the CD that came with your router or go to [Linksys.com/support](http://Linksys.com/support).

Specifications are subject to change without notice.

Maximum performance derived from IEEE Standard 802.11 specifications. Actual performance can vary, including lower wireless network capacity, data throughput rate, range and coverage. Performance depends on many factors, conditions and variables, including distance from the access point, volume of network traffic, building materials and construction, operating system used, mix of wireless products used, interference and other adverse conditions.

## Linksys E1200

Model Name	Linksys E1200
Description	Wireless-N Router
Model Number	E1200
Switch Port Speed	10/100 Mbps (Fast Ethernet)
Radio Frequency	2.4 GHz
# of Antennas	2
Ports	Power, Internet, and Ethernet (1-4)
Buttons	Reset, Wi-Fi Protected Setup™
LEDs	Power/Wi-Fi Protected Setup, Internet, Ethernet (1-4)
UPnP	Supported
Security features	WEP, WPA, WPA2
Security Key Bits	Up to 128-bit encryption

## Environmental

Dimensions	188.7 × 151.7 × 31.2 mm (7.43" × 5.97" × 1.23")
Unit Weight	<b>V1:</b> 252.7g (8.91 oz.) <b>V2:</b> 202.0g (7.13 oz.)
Power	12V, 0.5A
Certifications	FCC, UL/cUL, ICES-003, RSS210, CE, Wi-Fi (IEEE 802.11b/g/n), WPA2™, WMM®, Wi-Fi Protected Setup, Windows 7
Operating Temp.	0 to 40°C (32 to 104°F)
Storage Temp.	-20 to 60°C (-4 to 140°F)
Operating Humidity	10 to 80% non-condensing
Storage Humidity	5 to 90% non-condensing

### NOTES

For regulatory, warranty, and safety information, see the CD that came with your router or go to [Linksys.com/support](http://Linksys.com/support).

Specifications are subject to change without notice.

Maximum performance derived from IEEE Standard 802.11 specifications. Actual performance can vary, including lower wireless network capacity, data throughput rate, range and coverage. Performance depends on many factors, conditions and variables, including distance from the access point, volume of network traffic, building materials and construction, operating system used, mix of wireless products used, interference and other adverse conditions.

## Linksys E1500

Model Name	Linksys E1500
Description	Wireless-N Router with SpeedBoost
Model Number	E1500
Switch Port Speed	10/100 Mbps (Fast Ethernet)
Radio Frequency	2.4 GHz
# of Antennas	3
Ports	Power, Internet, and Ethernet (1-4)
Buttons	Reset, Wi-Fi Protected Setup
LEDs	Power/Wi-Fi Protected Setup, Internet, Ethernet (1-4)
UPnP	Supported
Security features	WEP, WPA, WPA2
Security Key Bits	Up to 128-bit encryption

## Environmental

Dimensions	188.7 × 151.7 × 31.2 mm (7.43" × 5.97" × 1.23")
Unit Weight	254.1g (8.96 oz.)
Power	12V, 0.5A
Certifications	FCC, UL/cUL, ICES-003, RSS210, CE, Wi-Fi (IEEE 802.11b/g/n), WPA2, WMM, Wi-Fi Protected Setup, Windows 7
Operating Temp.	0 to 40°C (32 to 104°F)
Storage Temp.	-20 to 60°C (-4 to 140°F)
Operating Humidity	10 to 80% non-condensing
Storage Humidity	5 to 90% non-condensing

### NOTES

For regulatory, warranty, and safety information, see the CD that came with your router or go to [Linksys.com/support](http://Linksys.com/support).

Specifications are subject to change without notice.

Maximum performance derived from IEEE Standard 802.11 specifications. Actual performance can vary, including lower wireless network capacity, data throughput rate, range and coverage. Performance depends on many factors, conditions and variables, including distance from the access point, volume of network traffic, building materials and construction, operating system used, mix of wireless products used, interference and other adverse conditions.

## Linksys E2500

Model Name	Linksys E2500
Description	Advanced Dual-Band N Router
Model Number	E2500
Switch Port Speed	10/100 Mbps (Fast Ethernet)
Radio Frequency	2.4 and 5 GHz
# of Antennas	4 (2 per band)
Ports	Power, Internet, and Ethernet (1-4)
Buttons	Reset, Wi-Fi Protected Setup
LEDs	Power/Wi-Fi Protected Setup, Internet, Ethernet (1-4)
UPnP	Supported
Security features	WEP, WPA, WPA2
Security key bits	Up to 128-bit encryption

## Environmental

Dimensions	225 x 35 x 180 mm (8.86" x 1.38" x 7.09")
Unit Weight	452 g (15.94 oz)
Power	12V, 1A
Certifications	FCC, IC, CE, Wi-Fi A/B/G/N
Operating Temp.	0 to 40°C (32 to 104°F)
Storage Temp.	-20 to 60°C (-4 to 140°F)
Operating Humidity	10 to 80%, relative humidity, non-condensing
Storage Humidity	5 to 90% non-condensing

### NOTES

For regulatory, warranty, and safety information, see the CD that came with your router or go to [Linksys.com/support](http://Linksys.com/support).

Specifications are subject to change without notice.

Maximum performance derived from IEEE Standard 802.11 specifications. Actual performance can vary, including lower wireless network capacity, data throughput rate, range and coverage. Performance depends on many factors, conditions and variables, including distance from the access point, volume of network traffic, building materials and construction, operating system used, mix of wireless products used, interference and other adverse conditions.

## Linksys E3200

Model Name	Linksys E3200
Description	High Performance Dual-Band N Router
Model Number	E3200
# of Antennas	6 (3 per band)
Switch Port Speed	10/100/1000 Mbps (Gigabit Ethernet)
Radio Frequency	2.4 and 5 GHz
Ports	Internet, Ethernet (1-4), USB, Power
Buttons	Reset, Wi-Fi Protected Setup
LEDs	Power/Wi-Fi Protected Setup, Internet, Ethernet (1-4)
UPnP	Supported
Security features	WEP, WPA, WPA2
Security key bits	Up to 128-bit encryption
Storage File System Support	FAT, and NTFS, and HFS+

## Environmental

Dimensions	6.69" x 0.98" x 7.48" (170 x 25 x 190 mm)
Unit Weight	7.62 oz (216 g)
Power	12V, 2A
Certifications	FCC, IC, CE, Wi-Fi A/B/G/N
Operating Temp.	32 to 95°F (0 to 35°C)
Storage Temp.	-4 to 140°F (-20 to 60°C)
Operating Humidity	10 to 80% relative humidity, non-condensing
Storage Humidity	5 to 90% non-condensing

### NOTES

For regulatory, warranty, and safety information, see the CD that came with your router or go to [Linksys.com/support](http://Linksys.com/support).

Specifications are subject to change without notice.

Maximum performance derived from IEEE Standard 802.11 specifications. Actual performance can vary, including lower wireless network capacity, data throughput rate, range and coverage. Performance depends on many factors, conditions and variables, including distance from the access point, volume of network traffic, building materials and construction, operating system used, mix of wireless products used, interference and other adverse conditions.

## Linksys E4200

Model Name	Linksys E4200
Description	Maximum Performance Dual-Band N Router
Model Number	E4200
Switch Port Speed	10/100/1000 Mbps (Gigabit Ethernet)
Radio Frequency	2.4 and 5 GHz
# of Antennas	6 (3 per band)
Ports	Power, USB, Internet, Ethernet (1-4)
Buttons	Reset, Wi-Fi Protected Setup
LEDs	Top panel: Power Back panel: Internet, Ethernet (1-4)
UPnP	Supported
Security Features	WEP, WPA, WPA2
Security Key Bits	Up to 128-bit encryption
Storage File System Support	FAT, and NTFS, and HFS+

## Environmental

Dimensions	8.86" x 0.98" x 6.30" (225 x 25 x 160 mm)
Unit Weight	12.7 oz (0.36 g)
Power	12V, 2A
Certifications	FCC, IC, CE, Wi-Fi a/b/g/n, Windows 7, DLNA
Operating Temp.	32 to 104°F (0 to 40°C)
Storage Temp.	-4 to 140°F (-20 to 60°C)
Operating Humidity	10 to 80% relative humidity, non-condensing
Storage Humidity	5 to 90% non-condensing

### NOTES

For regulatory, warranty, and safety information, see the CD that came with your router or go to [Linksys.com/support](http://Linksys.com/support).

Specifications are subject to change without notice.

Maximum performance derived from IEEE Standard 802.11 specifications. Actual performance can vary, including lower wireless network capacity, data throughput rate, range and coverage. Performance depends on many factors, conditions and variables, including distance from the access point, volume of network traffic, building materials and construction, operating system used, mix of wireless products used, interference and other adverse conditions.

Visit [linksys.com/support](http://linksys.com/support) for award-winning 24/7 technical support



Cisco, the Cisco logo, and Linksys are trademarks or registered trademarks of Cisco and/or its affiliates in the United States and other countries. A listing of Cisco's trademarks can be found at [www.cisco.com/go/trademarks](http://www.cisco.com/go/trademarks). All other trademarks mentioned in this document are the property of their respective owners.

© 2012 Cisco and/or its affiliates. All rights reserved.

3425-01486

111216MS