

# clarion®

**Owner's manual**

使用说明书

사용 설명서

คู่มือผู้ใช้

**Buku petunjuk untuk pemilik**

## ***DB566USB***

**CD/USB/MP3/WMA RECEIVER**

**CD/USB/MP3/WMA 接收器**

**CD/USB/MP3/WMA 리시버**

**เครื่องรับสัญญาณจาก CD/USB/MP3/WMA**

**PENERIMA CD/USB/MP3/WMA**

# Contents

1. FEATURES .....	2
2. PRECAUTIONS .....	3
3. HANDLING COMPACT DISCS .....	4
4. CONTROLS .....	5
MAIN UNIT .....	5
DISPLAY .....	5
5. BUTTON TERMINOLOGY .....	6
Names of the Buttons and Their Functions .....	6
6. DCP (Detachable Control Panel) .....	8
7. REMOTE CONTROL .....	9
Inserting the Battery .....	9
Functions of Remote Control Unit Buttons .....	10
8. OPERATIONS .....	11
Basic Operations .....	11
Radio Mode Operations .....	13
CD/MP3/WMA Mode Operations .....	14
USB Mode Operation .....	16
Operation Common to CD and USB Drive .....	18
Operations Common to Each Mode .....	21
9. TROUBLESHOOTING .....	22
10. ERROR DISPLAYS .....	24
11. SPECIFICATIONS .....	24

## 1. FEATURES

- USB slot on control panel
- MP3 and WMA compatible with ID3-TAG display
- “Z-ENHANCER” sound customization & “MAGNA BASS EX” dynamic bass enhancement



## 2. PRECAUTIONS

1. During extreme cold temperatures, condensation may form on the disc and/or the optical part of the player. If the disc exhibits condensation, carefully wipe off the disc with a soft cloth. In the event the disc still does not play properly, eject the disc and allow the condensation to disappear naturally from the optical parts of the player. Radio, Auxiliary and USB functions can still be used during this time which may take up to an hour.
2. Driving on extremely bumpy roads may cause the CD to skip.
3. This unit uses a precision mechanism. Even in the event that trouble arises, never open the case, disassemble the unit, or lubricate the rotating parts.

English

### CAUTION

USE OF CONTROLS, ADJUSTMENTS, OR PERFORMANCE OF PROCEDURES OTHER THAN THOSE SPECIFIED HEREIN, MAY RESULT IN HAZARDOUS RADIATION EXPOSURE. THE COMPACT DISC PLAYER SHOULD NOT BE ADJUSTED OR REPAIRED BY ANYONE EXCEPT PROPERLY QUALIFIED SERVICE PERSONNEL.

MODEL **DB566USB** Clarion

12V  $\ominus$  GROUND  
AM 531-1629kHz / FM 87.0-108MHz

This product includes technology owned by Microsoft Corporation and cannot be used or distributed without a license from MSLGP.

**051 722 877**

SERIAL No.  
PE-2888K

276-0084-00  
Clarion Co., Ltd.  
MADE IN MALAYSIA

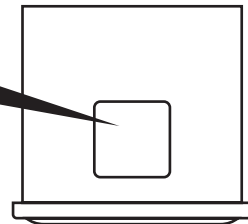

Bottom View of Source Unit

### INFORMATION FOR USERS:

CHANGES OR MODIFICATIONS TO THIS PRODUCT NOT APPROVED BY THE MANUFACTURER WILL VOID THE WARRANTY.

## 3. HANDLING COMPACT DISCS

This unit has been designed specifically for playback of compact discs bearing the  mark. No other discs can be played.

To remove the compact disc from its storage case, press down on the center of the case and lift the disc out, holding it carefully by the edges.

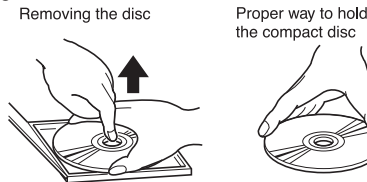

Always handle the compact disc by the edges. Never touch the surface.

To remove fingerprints and dust, use a soft cloth, and wipe in a straight line from the center of the compact disc to the circumference.

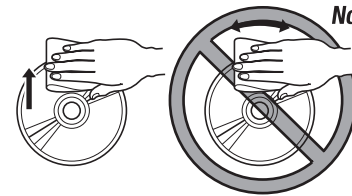

New discs may have some roughness around the edges. The unit may not work or the sound may skip if such discs are used. Use a ball-point pen, etc. to remove roughness from the edge of the disc.

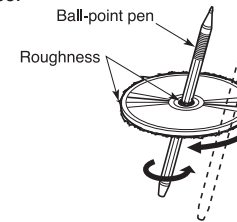

### Note:

- Do not use commercially available CD protection sheets or discs equipped with stabilizers, etc. These may get caught in the internal mechanism and damage the disc.

### Note on compact discs

Never stick labels on the surface of the compact disc or mark the surface with a pencil or pen.

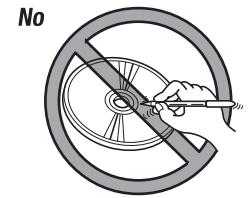

Do not use any solvents such as commercially available cleaners, anti-static spray, or thinner to clean compact discs.

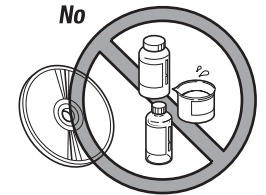

Do not use compact discs that have large scratches, are misshapen, or cracked, etc. Use of such discs will cause misoperation or damage.



Do not expose compact discs to direct sunlight or any heat source.

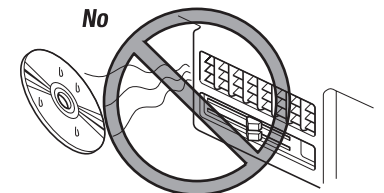

Be sure to unfold and read the next page.

请务必展开并阅读下一页。  
반드시 다음 페이지를 펴서 읽으십시오.

กรุณาพลิกอ่านหน้าต่อไป

Pastikan untuk membuka lipatan ini dan baca halaman berikutnya.

## 4. CONTROLS / 控制 / 제어부 / ตัวควบคุม / KONTROL

### MAIN UNIT / 主机 / 메인유닛 / ชุดอุปกรณ์ตัวหลัก / UNIT UTAMA

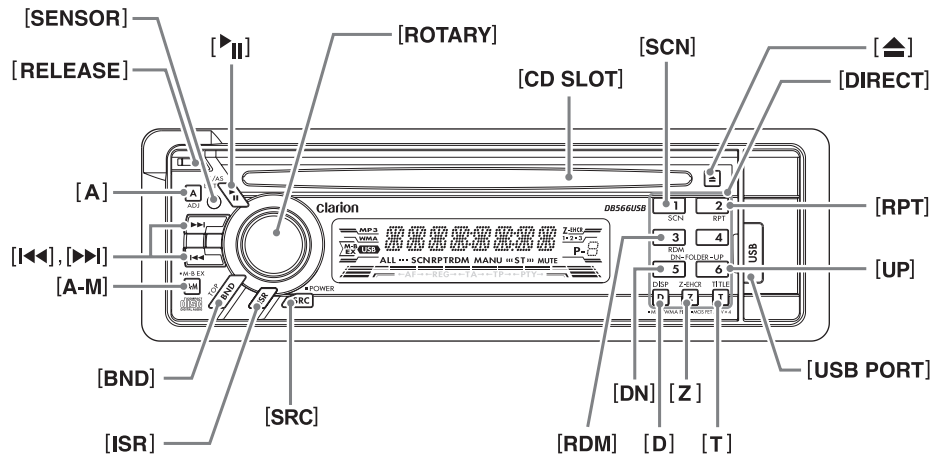

### DISPLAY / 显示 / 디스플레이 / หน้าจอแสดงผล / TAMPILAN



Note: Be sure to unfold this page and refer to the front diagrams as you read each chapter.

注意: 阅读各章时请务必展开此页并阅读前面的图。

주: 반드시 이 페이지를 펴서 각 장을 읽을 때 앞면 도표를 참고하십시오.

หมายเหตุ: อย่าลืมเปิดอ่านหน้านี้และดูแผนผังประกอบเมื่ออ่านแต่ละบท

Catatan: Pastikan untuk membuka halaman ini dan lihat diagram depan sewaktu anda membaca setiap bab.

## 5. BUTTON TERMINOLOGY

Note:

- Be sure to read this chapter referring to the front diagrams of chapter "4. CONTROLS" on page 5.

### Names of the Buttons and Their Functions

#### [RELEASE] button

- Press the [RELEASE] button to unlock the detachable panel.

#### [A] button

- Press the button to switch to the ADJ mode.

#### [<<<, >>>] buttons

- Select a station while in the Radio mode or select a track when listening to a CD/USB. These buttons are used to make various settings.
- Press and hold the button for 1 second or longer to enter the fast-forward or fast-backward in CD/USB mode.

#### [A-M] button

- Press the button to switch to the Audio mode (Bass, Treble, Balance, Fader).
- Press and hold for 1 second or longer to turn on or off the M-B EX mode.

#### [BND] button

- Switch the band, seek tuning or manual tuning while in the Radio mode.
- Play a first track while in the CD/MP3/WMA or USB mode.

#### [ISR] button

- Recall ISR radio station in memory.
- Press and hold for 2 seconds or longer: Store current station into ISR memory (Radio mode only).

#### [SRC] button

- Press the button to turn on the power.  
Press and hold the button for 1 second or longer to turn off the power.
- Switch the Operation mode among the Radio mode, etc.

#### [D] button

- During Radio/CD mode, switch the display indication (Main display, Clock display).
- During MP3/WMA/USB mode, switch the display indication in the following order:  
Track No./Play time → Folder No./Track No.  
→ Title Display → Clock Display → Track No./Play time...

#### [Z] button

- Press the button to select one of the 3 types of sound characteristics already stored in memory.

#### [T] button

- Press the button to switch the track titles, while in the MP3/WMA/USB mode.
- Press and hold the button for 1 second or longer to scroll the title during title display, while in the MP3/WMA or USB mode.

#### [UP], [DN] buttons

- Select the Folder (MP3/WMA disc or USB drive).
- Press the button to select CD-DA or MP3/WMA on a multi-session disc.

#### [RDM] button

- Perform random play while in the CD/MP3/WMA or USB mode.
- Press and hold the button for 1 second or longer to perform folder random play while in the MP3/WMA or USB mode.

#### [SCN] button

- Perform scan play for 10 seconds of each track while in the CD/MP3/WMA or USB mode.
- Press and hold the button for 1 second or longer to perform folder scan play while in the MP3/WMA or USB mode.

#### [RPT] button

- Repeat play while in the CD/MP3/WMA or USB mode.
- Press and hold the button for 1 second or longer to perform folder repeat play while in the MP3/WMA or USB mode.

#### [DIRECT] buttons

- Store a station into memory or recall it directly while in the Radio mode.

#### [USB PORT]

- USB drive insertion port.

## Names of the Buttons and Their Functions

---

### [] button

- Eject a CD when it is loaded in the unit.

### [CD SLOT]

- CD insertion slot.

### [SENSOR]

- Receiver for remote control unit.
- Operating range: 30° in all directions.

### [] button

- Perform preset scan while in the Radio mode.  
Press and hold the button for 2 seconds or longer to perform auto store.
- Play or pause a track while in the CD/MP3/WMA or USB mode.

### [ROTARY] knob

- Adjust the volume by turning the knob clockwise or counterclockwise.
- Use the knob to perform various settings.

## 6. DCP (Detachable Control Panel)

The control panel can be detached to prevent theft. When detaching the control panel, store it in the DCP (Detachable Control Panel) case to prevent scratches.

We recommend taking the DCP with you when leaving the car.

### Removing the DCP

1. Press the [SRC] button for 1 second or longer to switch off the power.
2. Press in the [RELEASE] button.

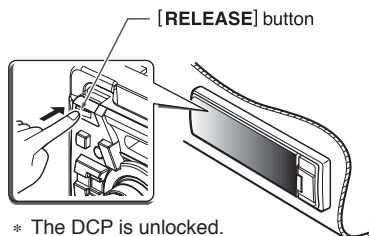

3. Pull the DCP towards you and remove it.

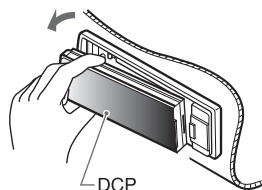

### Attaching the DCP

1. Insert the right side of the DCP into the main unit.
2. Insert the left side of the DCP to attach into the main unit.

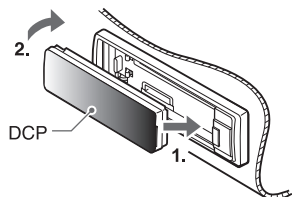

### Storing the DCP in the DCP case

Hold the DCP, in the orientation as shown in the figure below, and put it into the supplied DCP case. (Ensure the DCP is in the correct orientation.)

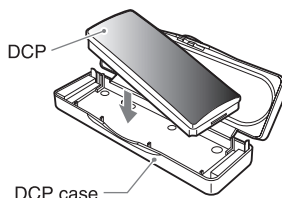

### CAUTION

- The DCP can easily be damaged by impact. After removing it, be careful not to drop it or subject it to strong shocks.
- If the FLIP DOWN PANEL is kept open, the DCP may drop due to vibration of the car. This may result in damage to the DCP. So close the FLIP DOWN PANEL or remove the DCP and store in the case.
- The connector connecting the main unit and the DCP is an extremely important part. Be careful not to damage it by pressing on it with fingernails, pens, screwdrivers, etc.

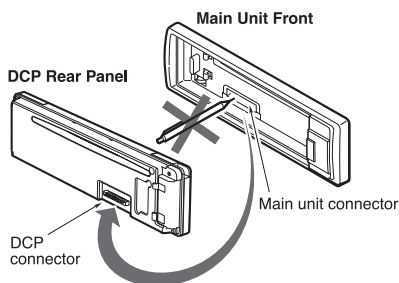

#### Note:

- If the DCP is dirty, wipe off the dirt with a soft, dry cloth only.

# 7. REMOTE CONTROL

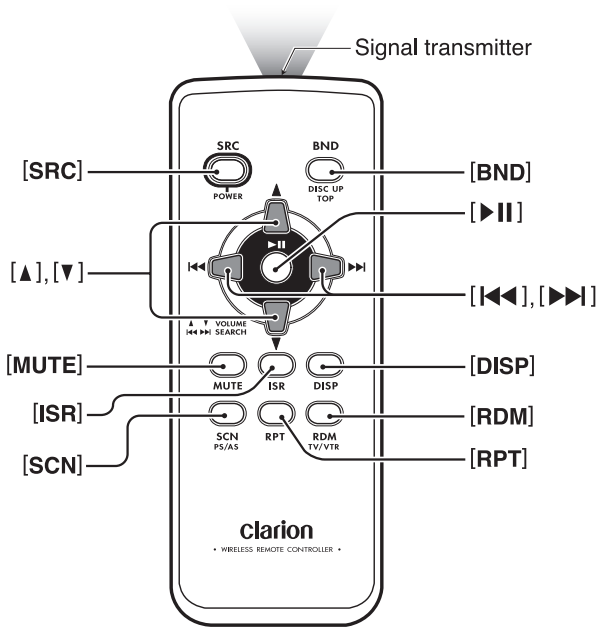

## Inserting the Battery

1. Turn over the remote control unit and slide the cover in the direction indicated by the arrow in the illustration.
2. Insert the battery (CR2025) into the insertion guides, with the printed side (+) facing upwards.
3. Press the battery in the direction indicated by the arrow so that it slides into the compartment.
4. Replace the cover and slide in until it clicks into place.

### Notes:

Misuse may result in rupture of the battery, producing leakage of fluid and resulting in personal injury or damage to surrounding materials. Always follow these safety precautions:

- Use only the designated battery.
- When replacing the battery, insert properly, with +/- polarities oriented correctly.
- Do not subject battery to heat, or dispose of in fire or water. Do not attempt to disassemble the battery.
- Dispose of used batteries properly.

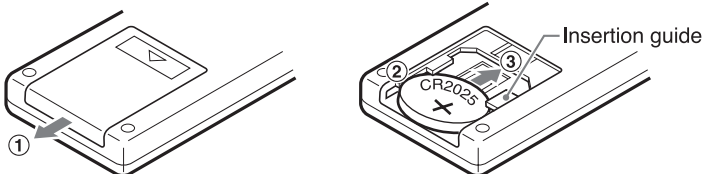

## Functions of Remote Control Unit Buttons

Button \ Mode	Radio	CD	MP3/WMA and USB
[SRC]	Press the button to power on. Press and hold the button for 1 second or longer: Power off. Switch between Radio, CD/MP3/WMA, USB and AUX.		
[BND]	Switch reception band.	Play the first track. Top play.	
[▲], [▼]	Increase and decrease volume (in all modes).		
[◀◀], [▶▶]	Move preset channels up and down.	Move tracks up and down. Press and hold the button for 1 second or longer: Fast-forward/fast-backward.	
[▶  ]	Turn mute on and off.	Switch between playback and pause.	
[MUTE]			
[ISR]	Recall ISR radio station in memory. Press and hold for 2 seconds or longer: Stores current station into ISR memory (Radio mode only).		
[DISP]	Switch among main display and clock display.		Switch among main display, title display and clock display.
[SCN]	Preset scan. Press and hold the button for 2 seconds or longer: Auto store.	Scan play. Press and hold the button for 1 second or longer to perform folder scan play while in the MP3/WMA or USB mode.	
[RPT]	No function.	Repeat play. Press and hold the button for 1 second or longer to perform folder repeat play while in the MP3/WMA or USB mode.	
[RDM]	No function.	Random play. Press and hold the button for 1 second or longer to perform folder random play while in the MP3/WMA or USB mode.	

\* Some of the corresponding buttons on the main unit and remote control unit have different functions.



# 8. OPERATIONS

## Basic Operations

**Note:** Be sure to read this chapter referring to the front diagrams of chapter "4. CONTROLS" on page 5.

### CAUTION

Be sure to lower the volume before switching off the unit power or the ignition key. The unit remembers its last volume setting. If you switch the power off with the volume up, when you switch the power back on, the sudden loud volume may hurt your hearing and damage the unit.

### Turning on/off the power

#### Note:

- Be careful about using this unit for a long time without running the engine. If you drain the car's battery too much, you may not be able to start the engine and this can reduce the service life of the battery.

1. Press the [SRC] button.
2. The illumination and display on the unit light up. The unit automatically remembers its last Operation mode and will automatically switch to display that mode.
3. Press and hold the [SRC] button for 1 second or longer to turn off the power for the unit.

### Selecting a mode

1. Press the [SRC] button to change the Operation mode.
2. Each time you press the [SRC] button, the Operation mode changes in the following order:

**Radio mode → CD/MP3/WMA mode → (USB mode) → AUX mode → Radio mode...**

#### Notes:

- If the CD mode is selected when no disc is inserted, the display shows "NO DISC".
- If no USB drive is inserted, USB mode will not be displayed.

### Switching the display

Press the [D] button to select the desired display.

Each time you press the [D] button, the display switches in the following order:

#### ● Radio/CD Mode:

Main display → Clock display → Main display

#### ● MP3/WMA/USB Mode:

Main-1 display (Track No., play time) → Main-2 Display (Folder No., Track No.) → Title Display → Clock Display → Main-1 Display...

- \* Once selected, the preferred display becomes the display default. When a function adjustment such as volume is made, the screen will momentarily switch to that function's display, then revert back to the preferred display several seconds after the adjustment.

### Adjusting the volume

Turning the [ROTARY] knob clockwise increases the volume; turning it counterclockwise decreases the volume.

- \* The volume level is from 0 (minimum) to 33 (maximum).

### Audio mode adjustments

1. Press the [A-M] button to select the Adjustment mode. The mode switches as follows each time the [A-M] button is pressed:

**BASS → TREB → BAL → FAD → Previous mode**

2. Turning the [ROTARY] knob to adjust the selected Audio mode.

BASS (Bass) : Adjustment range : -7 to +7

TREB (Treble): Adjustment range : -7 to +7

BAL (Balance): Adjustment range : L13 to R13

FAD (Fader) : Adjustment range : F12 to R12

- \* The display returns to the previous mode 7 seconds after the adjustment.

#### Note:

- Bass and Treble can only be adjusted when the "Z-Enhancer" is off.

## Basic Operations

### Setting the Z-Enhancer

This unit is provided with 3 types of sound tone effects stored in memory. Select the one you prefer.

\* The factory default setting is “**Z-EHCR OFF**”.

Each time you press the [**Z**] button, the tone effect changes in the following order:

“**Z-EHCR OFF**” → “**Z-EHCR 1**” → “**Z-EHCR 2**”  
 “**Z-EHCR 3**” → “**Z-EHCR OFF**” ...

- Z-EHCR 1 : bass emphasized
- Z-EHCR 2 : treble emphasized
- Z-EHCR 3 : bass and treble emphasized
- Z-EHCR OFF : no sound effect

### Adjusting the balance

1. Press the [**A-M**] button and select “**BAL 0**”.
2. Turning the [**ROTARY**] knob clockwise emphasizes the sound from the right speaker; turning it counterclockwise emphasizes the sound from the left speaker.

\* The factory default setting is “**BAL 0**”.  
 (Adjustment range: L13 to R13)

3. When the adjustment is complete, press the [**A-M**] button several times until the Function mode is reached.

### Adjusting the fader

1. Press the [**A-M**] button and select “**FAD 0**”.
2. Turning the [**ROTARY**] knob clockwise emphasizes the sound from the front speakers; turning it counterclockwise emphasizes the sound from the rear speakers.

\* The factory default setting is “**FAD 0**”.  
 (Adjustment range: F12 to R12)

3. When the adjustment is complete, press the [**A-M**] button several times until the Function mode is reached.

### Adjusting MAGNA BASS EX

The MAGNA BASS EX does not adjust the low sound area like the normal sound adjustment function, but emphasizes the deep bass sound area to provide you with a dynamic sound.

\* The factory default setting is off.

1. Press and hold the [**A-M**] button for 1 second or longer to turn on the MAGNA BASS EX effect. “**M-B EX**” lights in the display.
2. Press and hold the [**A-M**] button for 1 second or longer to turn off the MAGNA BASS EX effect. “**M-B EX**” goes off from the display.

### AUX function

This system has external input jacks so you can listen to sounds and music from external devices connected to this unit.

1. Press the [**SRC**] button and select the AUX mode to activate the AUX function.

# Radio Mode Operations

## Listening to the radio

1. Press the [SRC] button and select the Radio mode, then the radio will be on.
2. To select a preset band, press the [BND] button, then select one of the preset bands such as FM1, FM2, FM3 or AM. Every time the [BND] button is pressed, the display will change as:  
FM1 → FM2 → FM3 → AM → FM1...
3. Press the [◀▶] button to tune in the desired station.

## Seek tuning

1. Press the [BND] button and select the desired band (FM or AM).
  - \* If "MANU" is lit in the display, press and hold the [BND] button for 1 second or longer. "MANU" in the display goes off and seek tuning is now available.
2. Press the [◀▶] button to start automatic station tuning.

When the [▶] button is pressed, search will be performing in the direction of higher frequencies. When the [◀] button is pressed, search will be performed in the direction of lower frequencies.

## Manual tuning

There are 2 ways available: Quick tuning and step tuning.

When you are in the step Tuning mode, the frequency changes one step at a time. In the quick Tuning mode, you can quickly tune the desired frequency.

1. Press the [BND] button and select the desired band (FM or AM).
  - \* If "MANU" is not lit in the display, press and hold the [BND] button for 1 second or longer. "MANU" is lit in the display and manual tuning is now available.
2. Tune into a station.

### ● Quick tuning:

Press and hold the [◀▶] button for 1 second or longer to begin station tuning.

### ● Step tuning:

Press the [◀▶] button to perform manual tuning.

## Preset memory function

Preset memory function can store up to 24 stations:

Six stations for each of FM1, FM2, FM3 and AM.

## Manual memory function

1. Press the [BND] button, to select a band you want to store in the memory.
2. Press the [◀▶] button to tune into a desired station.
3. Press and hold one of the [DIRECT] buttons for 2 seconds or longer to store the current station into preset memory.

## Auto store

Auto store is a function for storing up to 6 stations that are automatically tuned in sequentially. If 6 receivable stations cannot be received, a previously stored station remains un-overwritten at the memory position.

1. Press the [BND] button and select the desired band (FM or AM).
2. Press and hold the [▶] button for 2 seconds or longer. The stations with good reception are stored automatically to the preset channels.

## Preset scan

Preset scan receives the stations stored in preset memory in order. This function is useful when searching for a desired station in memory.

1. Press the [▶] button.
2. When a desired station is tuned in, press the [▶] button again to continue receiving that station.

### Note:

- Be careful not to press and hold the [▶] button for 2 seconds or longer, otherwise the auto store function is engaged and the unit starts storing stations.

## Radio Mode Operations

### Recalling a preset station

A total of 24 preset positions (6-FM1, 6-FM2, 6-FM3, 6-AM) exists to store individual radio stations in memory. Pressing the corresponding [DIRECT] button recalls the stored radio frequency automatically.

1. Press the [BND] button and select the desired band (FM or AM).
2. Press the corresponding [DIRECT] button to recall the stored station.
  - \* Press and hold one of the [DIRECT] buttons for 2 seconds or longer to store that station into preset memory.

### Instant station recall (ISR)

Instant station recall is a special radio preset that instantly accesses a favorite radio station at a touch of a button. The ISR function even operates with the unit in other modes.

#### ● ISR memory

1. Select the station that you wish to store in ISR memory.
2. Press and hold the [ISR] button for 2 seconds or longer.

#### ● Recalling a station with ISR

In any mode, press the [ISR] button to turn on the radio function and tune the selected radio station. "ISR" appears in the display. Press the [ISR] button again to return to the previous mode.

## CD/MP3/WMA Mode Operations

### What is MP3?

MP3 is an audio compression method and classified into audio layer 3 of MPEG standards. This audio compression method has penetrated into PC users and become a standard format. This MP3 features the original audio data compression to about 12 percent of its initial size with a high quality sound. This means that about 10 music CDs can be recorded on a CD-R disc or CD-RW disc to allow a long listening time without having to change CDs.

### What is WMA?

WMA is the abbreviation of Windows Media Audio, an audio file format developed by Microsoft Corporation.

#### Notes:

- If you play a file with DRM (Digital Rights Management) for WMA remaining ON, no audio is output.
- Windows Media™, and the Windows® logo are trademarks, or registered trademarks of Microsoft Corporation in the United States and/or other countries.

#### ● To disable DRM (Digital Rights Management):

1. When using Windows Media Player 8, click on TOOLS → OPTIONS → COPY MUSIC tab, then under COPY SETTINGS unclick the check box for PROTECT CONTENT. Then, reconstruct files.
2. When using Windows Media Player 9, click on TOOL → OPTIONS → MUSIC RECORD tab, then under Recording settings, unclick the check box for RECORD PROTECTED MUSIC. Then, reconstruct files.
3. When using Windows Media Player 10, click on TOOL → OPTIONS → RIP MUSIC tab, then under Rip settings, unclick the check box for COPY PROTECT MUSIC. Then, reconstruct files. Personally constructed WMA files are used at your own responsibility.

#### ● Precautions when creating MP3/WMA disc

Please refer to the usable sampling rates and bit rates of chapter "11. SPECIFICATIONS" on page 24.

## CD/MP3/WMA Mode Operations

### ● File extensions

- Always add a file extension “.MP3” or “.WMA” to MP3 or WMA file by using single byte letters. If you add a file extension other than specified or forget to add the file extension, the file cannot be played.

### ● Logical format (File system)

1. When writing MP3/WMA file on a CD-R disc or CD-RW disc, please select “**ISO9660 level 1, 2 or JOLIET or Romeo**” as the writing software format. Normal play may not be possible if the disc is recorded on another format.
2. The folder name and file name can be displayed as the title during MP3/WMA play but the title must be within 28 single byte alphabetical letters and numerals (including an extension).
3. Do not affix a name to a file inside a folder having the same name.

### ● Folder structure

1. A disc with a folder having more than 8 hierarchical levels will be impossible.

### ● Number of files or folders

1. Up to 255 files can be recognized per folder. Up to 255 files can be played.

#### Note:

- The company will not guarantee any unexpected result caused by exceeding the files limitation.
2. Tracks are played in the order that they were recorded onto a disc. (Tracks might not always be played in the order displayed on the PC.)
  3. Some noise may occur depending on the type of encoder software used while recording.

## CD-DA/MP3/WMA selection on multi-session CD

1. If a multi-session CD which contains CD-DA and MP3/WMA files is being inserted, user can select either CD-DA or MP3/WMA files to be played.

#### Note:

- CD-DA files will always be the first to be played while MP3/WMA files will be playing subsequently.
2. Press the [UP] button will move to the next folder and MP3/WMA files to be played. Press the [DN] button at the time will return to CD-DA playing files.

## Disc-In-Play function

As long as the ignition key is turned to the ON or ACC position, this function allows you to turn the power to the unit and start playing the disc automatically when the disc is inserted even if the power is not turned on.

### CAUTION

- **Do not try to put your hand or fingers in the disc insertion slot. Also never insert foreign objects into the slot.**
- **Do not insert discs where adhesive comes out from cellophane tape or a rental CD label, or discs with marks where cellophane tape or rental CD labels were removed. It may be impossible to extract these discs from the unit and they may cause the unit to break down.**

## Backup eject function

Just pressing the [▲] button ejects the disc even if the power to the unit was not turned on. Remove the disc after it is ejected.

#### Notes:

- If you force a CD into before auto reloading, this can damage the CD.
- If a CD (12 cm) is left in the ejected position for 15 seconds, the CD is automatically reloaded. (Auto reload).
- 8 cm CDs are not auto reloaded. Be sure to remove it when ejected.

## Listening to a disc already loaded in the unit

Press the [SRC] button to select the CD/MP3/WMA mode.

When the unit enters the CD/MP3/WMA mode, play starts automatically.

If there is no disc loaded, the indication “**NO DISC**” appears in the title display.

**Radio → CD/MP3/WMA → (USB) → AUX → Radio...**

## CD/MP3/WMA Mode Operations

### Loading a CD

Insert a CD into the center of the CD SLOT with the labeled side facing up. "LOADING" appears in the display, the CD plays automatically after loading.

#### Notes:

- Never insert foreign objects into the CD SLOT.
- If the CD is not inserted easily, there may be another CD in the mechanism or the unit may require service.
- Discs not bearing the  mark and CD-ROMs cannot be played by this unit.
- Some CDs recorded in CD-R/CD-RW mode may not be usable.

### Loading 8 cm compact discs

- \* No adapter is required to play an 8 cm CD.
- \* Insert the 8 cm CD into the center of the insertion slot.

For CD/MP3/WMA playback, please refer to "Operations Common to CD and USB Drive".

## USB Mode Operation

### What is USB?

USB is the abbreviation of Universal Serial Bus, an external bus standard that supports data transfer rates of 12Mbps. The main unit is USB 2.0 compatible. (It is compliant with Universal Serial Bus Revision 1.1 specification, which is Full Speed supported but not running at High-Speed). This means that the transfer rates only supports until 12Mbps, which is the maximum speed of USB1.1. USB also support hot plugging, which is the ability to add and remove devices to a main unit while the unit is running and automatically recognize the change.

### Supported audio files playback

Only MP3 and WMA files are currently supported. For further information on MP3/WMA playback, please refer to "Operations Common To CD and USB Drive".

### Hot plugging function

When the unit is powered on, this function allows you to start playing the tracks automatically when the USB drive is inserted.

### CAUTION

- Do not try to put your hand or fingers in the USB insertion port. Also never insert foreign objects into the port.
- Do not insert USB devices other than "USB mass storage class" as this will have no function to the main unit or device and may have unexpected result.
- The main unit cannot be connected with the personal computer or laptop.
- USB drive that contains WMA files with DRM protected will not be read by the main unit.
- Reading time for a USB drive may differ depends on the contents of the data.
- USB drive insertion may result in protruding as it might be dangerous to the user while driving. For safety purposes, it is advisable to use an USB extension cable to connect between the USB drive and the USB port on the main unit.

## USB Mode Operation

- USB drives may have different shape depends on brands. Some USB drives may not be able to plug into the port due to the shape design. Please use an extension cable instead.
- The company will not guarantee that every USB drive brands will be able to work with the main unit.
- Please remove your USB drive while you are not inside your vehicle because USB drive may not have automotive specification and it will be damaged by overheating environment.
- Electrostatic may result data loss in the USB drive.
- The company will not responsible for any data loss when using the USB drive with the main unit. Please backup your data before proceeding.
- Please make sure that the total supported files limitation in the USB drive, which are 255 files. The company will not guarantee any unexpected result caused by exceeding the files limitation.

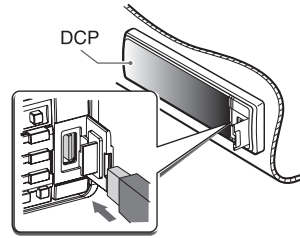

### Unplug the USB drive

Just pull out the USB drive from the port during USB mode, the unit will revert to Radio mode automatically.

### Listening to a track with USB drive already plug into the unit

Press the [SRC] button to select the USB mode.

When the unit enters the USB mode, track will start to play automatically.

If there is no USB drive inserted, USB mode will not be shown for selection.

\* The mode changes each time the [SRC] button is pressed.

**Radio → CD/MP3/WMA → (USB) → AUX → Radio...**

### Plugging in a USB drive

Plug the USB drive into the port with the correct direction.

#### Note:

- Do not forcibly plug the USB drive to the port with incorrect direction as this will damage the USB drive as well as the USB port.

# Operation Common to CD and USB Drive

## Pausing play

1. Press the [▶||] button to pause play. "PAUSE" appears in the display.
2. To resume track play, press the [▶||] button again.

## Displaying CD titles

This unit can display title data for MP3/WMA.

1. Press the [D] button to display the title.
2. Each time you press the [T] button, the title display changes in the following order:

### ● MP3/WMA disc

Folder → Track → Album TAG → Artist TAG → Title TAG → Folder...

#### Notes:

- If MP3/WMA disc is not input TAG, "NO TAG" appears in the display.
- For MP3, supports ID3 Tags V2.4/2.3/2.2/1.1/1.0.
- Tag displays give priority to V2.4/2.3/2.2.
- In the case of album Tags for WMA, the information written into the extension header is displayed.
- Only ASCII characters can be displayed in Tags.

## Display selection

1. You can choose the display type for MP3/WMA by pressing the [D] button.

To select the next type, press the [D] button again.

The arrangement is shown below.

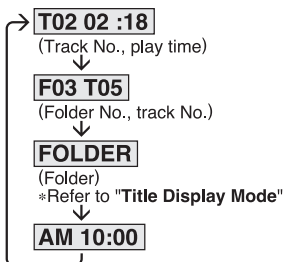

## Title display mode

1. There are 5 types of display for the Title Display mode.
2. To select the next type, press the [T] button for less than 1 second.

The arrangement is shown below.

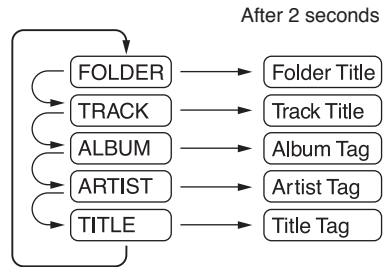

3. The displayed item can be scrolled by pressing the [T] button for more than 1 second.
4. If a MP3/WMA file does not support for ID3 TAG, the display will show "NO TAG"
5. If a MP3/WMA file encode with ID3 TAG header but not consist of any TAG information, the display will show nothing.

#### Notes:

- The folder name will be displayed as "ROOT" which the file allocates in the root folder.
- The MP3 player decodes each file ID3 TAG ver 2 by default, if ID3 TAG ver 2 is unavailable, ID3 TAG ver 1 will be decoded.
- UNICODE ID3 (Chinese, Japanese and etc) is not supported.

## Selecting a track

### ● Track-up

1. Press the [▶▶] button to move to the beginning of the next track.
2. Each time the [▶▶] button is pressed, playback proceeds to another track in the advancing direction.

### ● Track-down

1. Press the [◀◀] button to move the beginning of the current track.
2. Press the [◀◀] button twice to move to the beginning of the previous track.



## Operation Common to CD and USB Drive

### Fast-forward/fast-backward

#### ● Fast-forward

Press and hold the [▶▶] button for 1 second or longer.

#### ● Fast-backward

Press and hold the [◀◀] button for 1 second or longer.

\* For Audio CD mode pressing the [◀◀, ▶▶] button for 1 second or longer will move forward or backward 5 times faster than normal play, and pressing it for 3 seconds or longer will do the operation 30 times faster.

\* For MP3/WMA mode pressing the [◀◀, ▶▶] button for 1 second or longer will move forward or backward 5 times faster than normal play, and pressing it for 3 seconds or longer will do the operation 10 times faster.

### MP3/WMA playing order

When selected for playing folder up down functions, files and folders are accessed in the order in which they were written by the CD-ROM writer or USB drive. Because of this, the order in which they are expected to be played may not match the order in which they are actually played. You may be able to set the order in which MP3/WMA are to be played by writing them onto a medium such as a CD-R/USB drive with their file names beginning with play sequence numbers such as "01" to "99", depending on your CD writer.

For example, a medium with the following folder/file hierarchy is shown below.

Example of a medium's folder/file hierarchy.

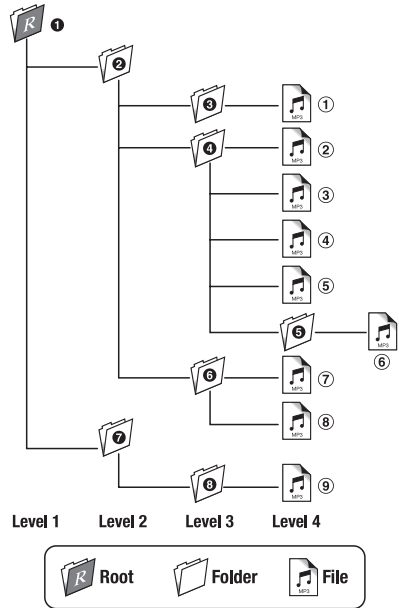

### Folder Select

This function allows you to select a folder containing MP3/WMA files and start playing from the first track in the folder.

1. Press the [DN] or the [UP] button.

Press the [DN] button to move the previous folder. Press the [UP] button to move the next folder.

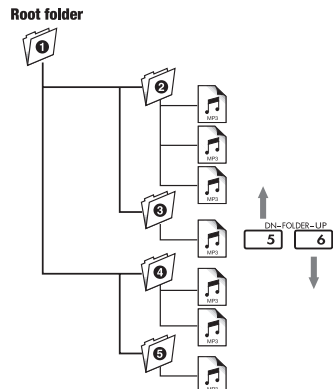

## Operation Common to CD and USB Drive

- \* Press the [UP] button while in the final folder to shift to the first folder.
  - \* Folder without an MP3/WMA file is not selectable.
2. Press the [◀▶] button to select a track.

### Top function

Press the [BND] button, then the CD/USB will start playing from the first song (track number 1).

### Other various play functions

#### ● Scan play

##### CD-DA :

This function allows you to locate and play the first 10 seconds of all the tracks recorded on a disc.

##### MP3/WMA :

This function allows you to locate and play the first 10 seconds of all the tracks in current folder.

1. Press the [SCN] button to perform scan play.  
The indication "SCN" lights in the display.  
\* Scan play starts from the next track after the track currently being played.

#### ● Folder scan play

##### MP3/WMA :

This function allows you to locate and play the first 10 seconds of the first track of all the folders on an MP3/WMA disc/USB drive.

1. Press and hold the [SCN] button for 1 second or longer to perform folder scan play.  
The indications "ALL..." and "SCN" light in the display.  
\* Folder scan play starts from the next track after the track currently being played.

#### ● Repeat play

##### CD-DA, MP3/WMA :

This function allows you to play the current track repeatedly.

1. Press the [RPT] button to perform repeat play.  
The indication "RPT" lights in the display.

#### ● Folder repeat play

##### MP3/WMA :

This function allows you to play all tracks in the MP3/WMA folder repeatedly.

1. Press and hold the [RPT] button for 1 second or longer to perform folder repeat play.  
The indications "ALL..." and "RPT" light in the display.

#### ● Random play

##### CD-DA :

This function allows you to play all tracks recorded on a disc in a random order.

##### MP3/WMA :

This function allows you to play all tracks of current folder in a random order.

1. Press the [RDM] button to perform random play.  
The indication "RDM" lights in the display.

#### ● Folder random play

##### MP3/WMA :

This function allows you to play all the tracks of all the folders recorded on an MP3/WMA disc/USB drive in a random order.

1. Press and hold the [RDM] button for 1 second or longer to perform folder random play.  
The indications "ALL..." and "RDM" light in the display.

#### ● To cancel play

1. Press the operating button previously selected.

# Operations Common to Each Mode

## To change display setting

1. Press the [A] button to switch to the adjustment selection display.
2. Press the [◀▶] button to select the "item name".  
"CLOCK(E)" ↔ "SCRN SVR" ↔ "A-SCROLL"
3. Turn the [ROTARY] knob to select the "desired setting value".
  - \* In the case of item names appearing with the "E" suffix, after the item name, the [▶] button must be pressed to display the setting value.
  - \* After completing settings, press the [A] button to return to the previous mode.

## Setting the clock

- 2-1. Select "CLOCK (E)".
- 3-1. Press the [▶] button.
- 3-2. Press the [◀▶] lever upward or downward to select the hour or the minute.
- 3-3. Turn the [ROTARY] knob to set the correct time.
  - \* The clock is displayed in 12-hour format.
- 3-4. Press the [▶] button to store the time into memory.

### Note:

- You cannot set the clock when it is displayed with only the ignition on. If you drain or remove the car's battery or take out this unit, the clock is reset. While setting the clock, if another button or operation is selected, the clock set mode is canceled.

## Turning the screen saver function on or off

This unit is provided with the screen saver function which allows you to show various kinds of patterns and characters in the operation status indication area of the display in a random order. You can turn on and off this function.

If the button operation is performed with the screen saver function on, the operation display corresponding to the button operation is shown for about 30 seconds and the display returns to the screen saver display.

- \* The factory default setting is "ON".

2-1. Select "SCRN SVR".

3-1. Turn the [ROTARY] knob to select the setting.

Each time you turn the [ROTARY] knob, the setting changes in the following order:

SS OFF ↔ SS ON.

## Setting the method for title scroll

Set how to scroll in MP3/WMA title.

- \* The factory default setting is "ON".

2-1. Select "A-SCROLL".

3-1. Turn the [ROTARY] knob to select "ON" or "OFF".

### • ON:

To scroll automatically.

### • OFF:

To scroll just 1 time when the title was changed or the [T] button was pressed for 1 second or longer.

# 9. TROUBLESHOOTING

	Problem	Cause	Measure
General	Power does not turn on. (No sound is produced)	Fuse is blown.	Replace with a fuse of the same amperage. If the fuse blows again, consult your store of purchase.
		Incorrect wiring.	Consult your store of purchase.
	No sound output when operating the unit with amplifiers or power antenna attached.	Power antenna lead is shorted to ground or excessive current is required for remote-on the amplifiers or power antenna.	<ol style="list-style-type: none"> <li>1. Turn the unit off.</li> <li>2. Remove all wires attached to the power antenna lead. Check each wire for a possible short to ground using an ohm meter.</li> <li>3. Turn the unit back on.</li> <li>4. Reconnect each amplifier remote wire to the power antenna lead one by one. If the amplifiers turn off before all wires are attached, use an external relay to provide remote-on voltage (excessive current required).</li> </ol>
	Nothing happens when button are pressed. Display is not accurate.	The microprocessor has malfunctioned due to noise, etc.	Turn off the power, then press the <b>[RELEASE]</b> button and remove the DCP. Press the reset button for about 2 seconds with a thin rod.
		DCP or main unit connectors are dirty.	Wipe the dirt off with a soft cloth moistened with cleaning alcohol.
	No sound heard.	The speaker protection circuit is operating.	<ol style="list-style-type: none"> <li>1. Turn down sound volume. Function can also be restored by turning the power off and on again. (Speaker volume is reduced automatically when the speaker protection circuit operates).</li> <li>2. If the sound is muted again, consult our service department.</li> </ol>

	Problem	Cause	Measure
CD/MP3/WMA	No sound heard.	MP3/WMA files are absent in a disc.	Write MP3/WMA files onto the disc properly.
		Files are not recognized as an MP3/WMA file.	Use MP3/WMA files encoded properly.
		File system is not correct.	Use ISO9660 level 1, 2 or JOLIET or Romeo file system.
	Sound skips or is noisy.	Disc is dirty.	Clean the disc with a soft cloth.
		Disc is heavily scratched or warped.	Replace with a disc with no scratches.
	Sound is cut or skipped. Noise is generated or noise is mixed with sound.	MP3/WMA files are not encoded properly.	Use MP3/WMA files encoded properly.
	Sound is bad directly after power is turned on.	Water droplets may form on the internal lens when the car is parked in a humid place.	Let dry for about 1 hour with the power on.
Wrong filename	File system is not correct.	Use ISO9660 level 1, 2 or JOLIET or Romeo file system.	

	Problem	Cause	Measure
MP3/WMA (USB Drive)	No sound heard.	MP3/WMA files are absent in a USB drive.	Write MP3/WMA files onto the USB drive properly.
		Files are not recognized as an MP3/WMA file.	Use MP3/WMA files encoded properly.
	Sound is cut or skipped. Noise is generated or noise is mixed with sound.	MP3/WMA files are not encoded properly.	Use MP3/WMA files encoded properly.
	USB drive cannot be detected.	USB drive may be damaged.	Reinsert the USB drive to try again. Replace with a new USB drive if failed.
		USB drive connector is in bad condition.	
	USB drive is unable to plug into the USB port.	The USB drive connector may be inserted in the wrong direction with the port.	Reinsert the USB drive with the correct direction.
The USB drive connector is damaged.		Replace with a new USB drive.	

## 10. ERROR DISPLAYS

	Error Display	Cause	Measure
CD/MP3/WMA DISC	ERROR 2	A DISC is caught inside the CD deck and is not ejected.	This is a failure of CD deck's mechanism and consult your store of purchase.
	ERROR 3	A DISC cannot be played due to scratches, loaded upside-down inside the CD deck etc.	Replace with a non-scratched, non-warped-disc. Eject the disc then reload it properly.
	NO FILE	No audio file is detected in the DISC.	Replace with audio contents loaded DISC.

	Error Display	Cause	Measure
USB DRIVE	MNT ERR	Failure detection of USB drive when it is plugged into the port.	Unplug the USB drive and re-plug into the port.
	NO FILE	No audio file is detected in the media.	Replace with audio contents loaded USB drive.
	USB ERR	USB connector short circuit/overloaded.	Unplug the USB drive, turn off the power and then turn on the power again.

## 11. SPECIFICATIONS

### FM tuner

Frequency Range: 87.0 MHz to 108 MHz  
 Usable Sensitivity: 11 dBf  
 50 dB Quieting Sensitivity: 17 dBf  
 Alternate Channel Selectivity: 75 dB  
 Stereo Separation (1 kHz): 35 dB  
 Frequency Response ( $\pm 3$  dB): 30 Hz to 15 kHz

### AM tuner

Frequency Range:  
 AM 531 kHz to 1629 kHz  
 Usable Sensitivity: 25  $\mu$ V

### CD player

System: Compact disc audio system  
 Usable Discs: Compact disc  
 Frequency Response: 10 Hz to 20 kHz ( $\pm 1$  dB)  
 Signal-to-Noise Ratio: 85 dB (1 kHz) IHF-A  
 Dynamic Range: 80 dB (1 kHz)  
 Harmonic Distortion: 0.01%

## Specifications

### CD

MP3	
Decode Format	MPEG 1, 2 and 2.5 - Layer 3
Sampling rate (kHz)	MPEG-1 : 32, 44.1, 48 MPEG-2 : 16, 22.05, 24 MPEG-2.5 : 11.025, 44.1
Bit-rate (kbps)	MPEG-1 : 32 - 320 MPEG-2 : 8 - 160 MPEG-2.5 : 8 - 160 VBR
CD-ROM Format	ISO 9660 Level 1, 2, Romeo and Joliet
WMA	
Sampling rate (kHz)	22.05 - 44.1
Bit-rate (kbps)	48, 64, 80, 96, 128, 160, 192
CD-ROM Format	ISO 9660 Level 1, 2, Romeo and Joliet

### USB

USB 1.1 and 2.0 compatible with a maximum transfer rates of up to 12Mbps. (Full speed)

MP3	
Decode Format	MPEG 1, 2 and 2.5 - Layer 3
Sampling rate (kHz)	MPEG-1 : 32, 44.1, 48 MPEG-2 : 16, 22.05, 24 MPEG-2.5 : 8, 11.025, 12
Bit-rate (kbps)	MPEG-1 : 32 - 320 MPEG-2 : 8 - 160 MPEG-2.5 : 8 - 160 VBR
WMA	
Sampling rate (kHz)	8, 11.025, 16, 22.05, 32, 44.1
Bit-rate (kbps)	48, 64, 80, 96, 128, 160, 192

### Common in MP3/WMA Disc and USB drive

Folder Level Limit	: 8 Level
Folder Support	: 255
File Support	: 255
Folder Name	: Maximum 28 bytes
File Name	: Maximum 28 bytes

### Audio

Maximum Power Output: 200 W (50 W X 4 ch)

Continuous Average Power Output:  
17 W X 4, into 4  $\Omega$ , 20 Hz to 20 kHz, 1%THD

Bass Control Action (100 Hz):  $\pm 14$  dB

Treble Control Action (10 kHz):  $\pm 14$  dB

Line Output (with A/C 1 kHz, 10 k $\Omega$ ): 1.8 V

### General

Power Supply Voltage:  
14.4 V DC (10.8 V to 15.6 V allowable), negative ground

Current Consumption: Less than 15 A

Speaker Impedance: 4  $\Omega$  (4  $\Omega$  to 8  $\Omega$  allowable)

Weight: 2.42 lb. (1.1 kg)

Dimensions:  
178 mm Width X 50 mm Height X 152 mm Depth

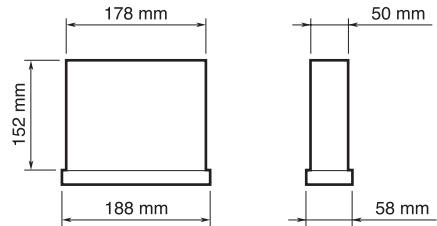

### Notes:

- Specifications comply with JEITA Standards.
- Specifications and design are subject to change without notice for further improvement.
- Please make sure when connecting external power amplifier, that you properly, to the car chassis, ground the amplifier.
- If this is not done, severe damage to the source unit may happen.

# Clarion Co., Ltd.

---

All Rights Reserved. Copyright © 2006: Clarion Co., Ltd.  
Printed in Malaysia / 在马来西亚印刷 / 인쇄국: 말레이시아  
/ พิมพ์ในประเทศไทย / Dicetak di Malaysia

**PE-2888K**  
**280-8404-01**