

clarion®

Owner's manual
Mode d'emploi
Istruzioni per l'uso

FZ709

Bluetooth® USB/MP3/WMA/AAC RECEIVER
/ CeNET CONTROL

Bluetooth® RÉCEPTEUR USB/MP3/WMA/AAC
/ CONTRÔLE CeNET

Bluetooth® RECEPTOR USB/MP3/WMA/AAC
/ CONTROL CeNET

Clarion Co., Ltd.

All Rights Reserved. Copyright © 2009: Clarion Co., Ltd.
Printed in Malaysia / Imprimé en Malaisie / Stampato in Malaysia

PE-8502B
280-8706-00

English

CLARION PRODUCT REGISTRATION INFORMATION

For USA and Canada only

Dear Customer:

Congratulations on your purchase of a Clarion mobile electronic products. We are confident that you'll enjoy your Clarion experience.

There are many benefits to registering your product. We invite you to visit our website at www.clarion.com to register your Clarion product.

We have made product registration simple with our easy to use website. The registration form is short and easy to complete. Once you're registered, we can keep you informed of important product information.

Register at www.clarion.com - it's easy to keep your Clarion product up to date.

Français

INFORMATIONS SUR L'ENREGISTREMENT DES PRODUITS CLARION

Seulement pour les États-Unis et le Canada

Cher client, chère cliente:

Nous vous remercions d'avoir choisi un produit électronique mobile Clarion. Vous apprécierez sans aucun doute votre expérience avec Clarion.

L'enregistrement de votre produit peut vous faire bénéficier de nombreux avantages. Nous vous invitons à visiter notre site Web à l'adresse www.clarion.com pour enregistrer votre produit Clarion.

L'enregistrement de produit sur notre site Web est une procédure simple. Le formulaire d'enregistrement est simple et facile à remplir. Une fois votre produit enregistré, vous pourrez rester informé(e) des informations produit importantes.

Enregistrez-vous sur www.clarion.com pour que votre produit Clarion reste à jour en toute simplicité.

Español

INFORMACIÓN DE REGISTRO DE PRODUCTO CLARION

Sólo para los EE.UU. y Canadá

Estimado Cliente:

Felicidades por comprar un producto electrónico móvil Clarion. Confiamos en que disfrutará de su experiencia Clarion.

Existen muchas ventajas de registrar su producto. Los invitamos a visitar nuestro sitio web en: www.clarion.com to para registrar su producto Clarion.

Hemos simplificado nuestro registro de producto a través de nuestro sitio web fácil de usar. El formulario de registro es breve y fácil de completar. Una vez se haya registrado, le mantendremos informado acerca de información importante del producto.

Regístrese en www.clarion.com - es fácil mantener su producto Clarion actualizado.

USA Representative:

CLARION CORPORATION OF AMERICA

6200 Gateway Drive, Cypress, CA 90630, U.S.A.

Tel: 1-310 327 9100 Fax: 1-310 327 1999

www.clarion.com

Display Items

Title display

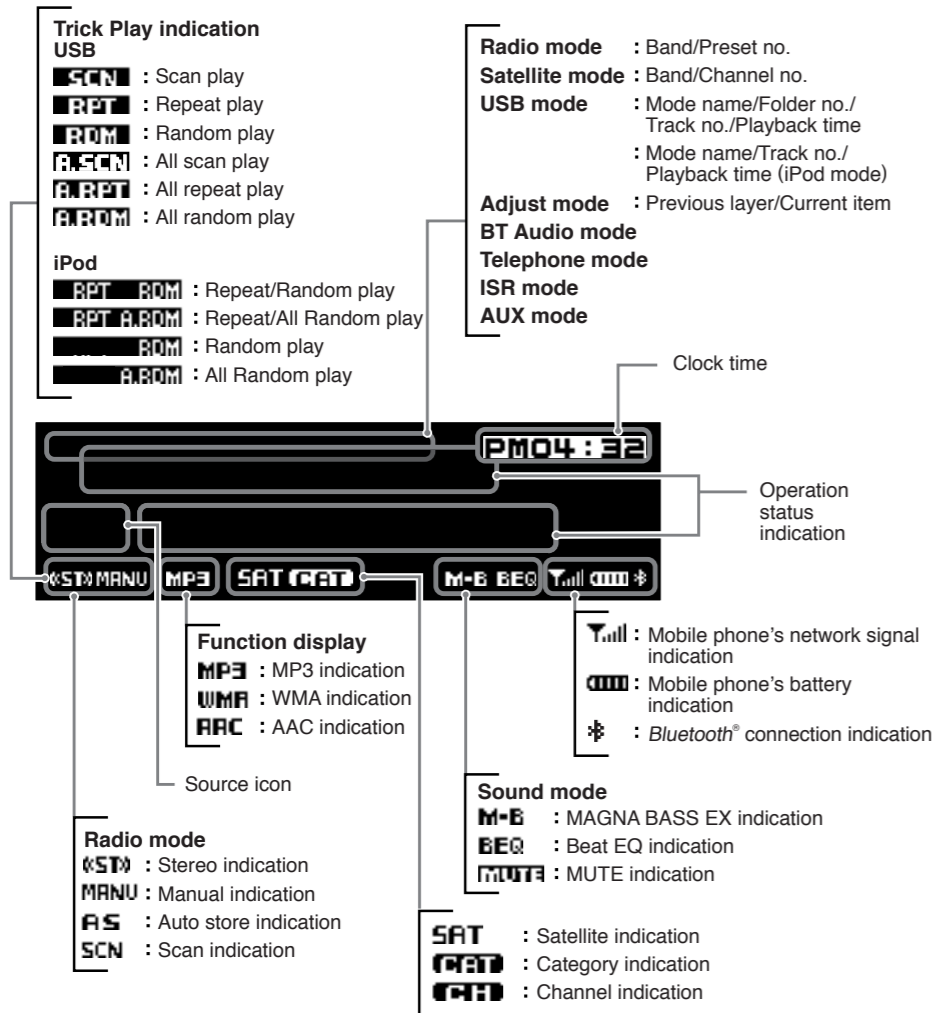

OEL Screen

The organic electro-luminescence display (OEL Display) of this product is made by high technology basis.

However, it is possible that there might be part of the pixels which is always lighting or not lightning. Sometimes unevenness of color and brightness might be occurred depend on the point of view to watch in a characteristic.

A descending line across the screen will be displayed regularly to prevent OEL Display burn-in.

Please note that these are not hardware/software failures as it happens to be the structure of the organic electro-luminescence display.

Contents

1. FEATURES	3
2. PRECAUTIONS	4
3. CONTROLS	5
MAIN UNIT	5
4. NOMENCLATURE	6
Names of the Buttons and Their Functions	6
Slider's Key Operation	7
Display Items	8
OEL Display	8
5. REMOTE CONTROL	9
Inserting the Battery	9
Functions of Remote Control Unit Buttons	10
6. OPERATIONS	11
Basic Operations	11
Radio Mode Operations	16
USB Operations	18
iPod Operations	22
Satellite Radio Operations	26
Bluetooth® Operations	28
Common Operations	33
7. TROUBLESHOOTING	37
8. ERROR DISPLAYS	40
9. SPECIFICATIONS	41

1. FEATURES

- OEL Display and Touch Sensor Operation.
- BBE MP for compressed Audio Improvement.
- USB Direct Connection for iPod®.

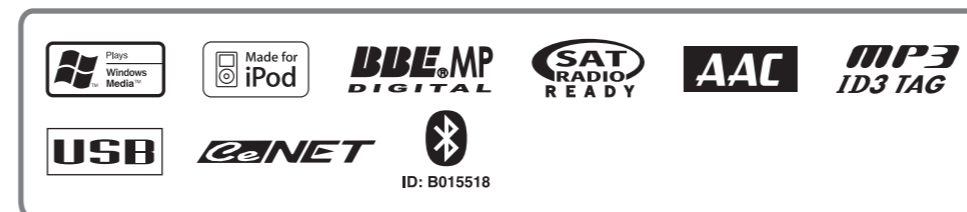

2. PRECAUTIONS

This equipment has been tested and found to comply with the limits for a Class B digital device, pursuant to Part 15 of the FCC Rules.

These limits are designed to provide reasonable protection against harmful interference in a residential installation.

This equipment generates, uses, and can radiate radio frequency energy and, if not installed and used in accordance with the instructions, may cause harmful interference to radio communications. However, there is no guarantee that interference will not occur in a particular installation.

If this equipment does cause harmful interference to radio or television reception, which can be determined by turning the equipment off and on, the user is encouraged to try to correct the interference by one or more of the following measures:

- Reorient or relocate the receiving antenna.
- Increase the separation between the equipment and receiver.
- Connect the equipment into an outlet on a circuit different from that to which the receiver is connected.
- Consult the dealer or an experienced radio/TV technician for help.

CAUTION

USE OF CONTROLS, ADJUSTMENTS, OR PERFORMANCE OF PROCEDURES OTHER THAN THOSE SPECIFIED HEREIN, MAY RESULT IN HAZARDOUS RADIATION EXPOSURE.

THIS PLAYER SHOULD NOT BE ADJUSTED OR REPAIRED BY ANYONE EXCEPT PROPERLY QUALIFIED SERVICE PERSONNEL.

INFORMATION FOR USERS:

CHANGES OR MODIFICATIONS TO THIS PRODUCT NOT APPROVED BY THE MANUFACTURER WILL VOID THE WARRANTY AND WILL VIOLATE FCC APPROVAL.

BBE MP (Minimized Polynomial Non-Linear Saturation) Process improves digitally compressed sound, such as MP3, by restoring and enhancing the harmonics lost through compression. BBE MP works by regenerating harmonics from the source material, effectively recovering warmth, details and nuance.

Manufactured under license from BBE Sound, Inc.

Licensed by BBE Sound, Inc. under one or more of the following US patents: 5510752, 5736897. BBE and BBE symbol are registered trademarks of BBE Sound, Inc.

"Made for iPod" means that an electronic accessory has been designed to connect specifically to iPod and has been certified by the developer to meet Apple performance standards.

Apple is not responsible for the operation of this device or its compliance with safety and regulatory standards. iPod and iTunes are trademarks of Apple Inc., registered in the U.S. and other countries.

Windows Media™, and the Windows® logo are trademarks, or registered trademarks of Microsoft Corporation in the United States and/or other countries.

The Bluetooth® word mark and logos are owned by the Bluetooth® SIG, Inc. and any use of such marks by Clarion Co., Ltd. is under license. Other trademarks and trade names are those of their respective owners.

©2008 SIRIUS XM Radio Inc. "SIRIUS", "The Best Radio on Radio", the SIRIUS logos, channel names and logos and related marks are trademarks of SIRIUS XM Radio Inc. All other trademarks, service marks, and logos are the property of their respective owners. All rights reserved.

*Be sure to unfold and read the next page.
 Veuillez déployer et vous référer à la page suivante.
 Cerciórese de desplegar y de leer la página siguiente.*

3. CONTROLS/ LES COMMANDES/ CONTROLLI

MAIN UNIT / APPAREIL PRINCIPAL / APPARECCHIO PRINCIPALE

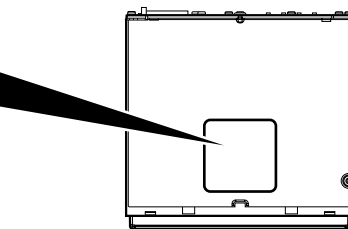
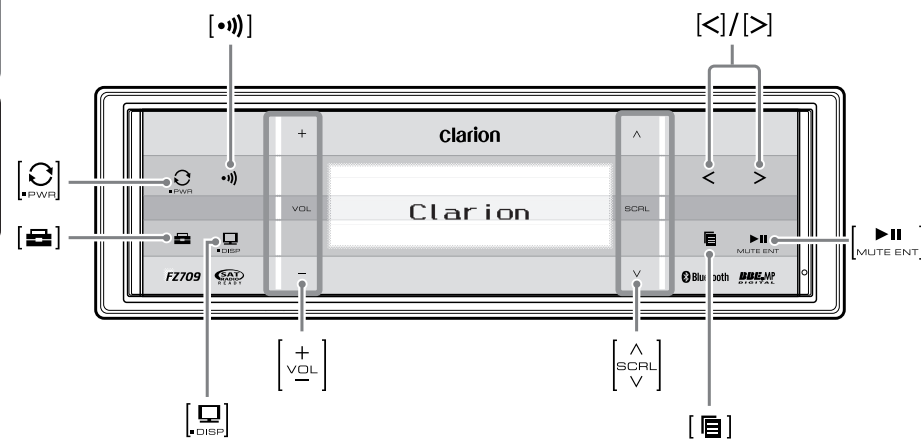

Bottom View of Source Unit
Vue de l'appareil Pilote Par Dessous
Vista Inferior de la Unidad Fuente

Note: Be sure to unfold this page and refer to the front diagrams as you read each chapter.

Remarque: Veuillez déplier cette page et vous référer aux schémas quand vous lisez chaque chapitre.

Nota: Assicurarsi di aprire questa pagina e fare riferimento a questi diagrammi quando si legge ciascun capitolo.

4. NOMENCLATURE

Note:

- Be sure to read this chapter referring to the front diagrams of chapter "3. CONTROLS" on page 5.

Names of the Keys and Their Functions

[PWR] key

- Touch the [PWR] key to power on the unit.
- Touch and hold the key for 1 second or longer to turn off the power.
- Switch to Source menu.

[••)] key

- Recall ISR radio station in memory.
- Touch and hold the key for 2 seconds or longer: Store current station into ISR memory (Radio mode only).

[DISP] key

- Switch to ADJ menu.
- Switch Title display.
- Touch and hold the key for 1 second or longer to switch the display layout (Title mode → Indicator mode → Clock).

[<|/>] key

- Seek a station while in the Radio mode.
- Select a track while in the USB mode.
- Touch and hold the key for 1 second or longer to enter the Fast-forward or Fast backward mode while in USB mode.

[DISP] key

- Switch the band, or seek tuning or manual tuning while in the Radio mode.
- Switch to List Search, or Top folder while in the USB mode.
- Switch between last menu level and Play display, or Top iPod menu while in the iPod mode.

[MUTE ENT] key

- Play or pause a track while in the USB mode.
- Toggle Mute on/off while in the Radio mode.
- Touch and hold the key for 2 seconds or longer to memory new value during setting mode.
- Dial the selected phone number through call method.

[VOL] slider

- Adjust the volume.

[SCRL] slider

- Select a station while in the Radio mode.
- Select the folder while in the USB mode.
- End a call or reject an incoming call.
- This key is used to make various settings.

[USB PORT]

- USB memory device insertion port (at rear panel).

[AUX] input

- The input jack for connecting an external device (at rear panel).

Slider's Key Operation

■ Slide

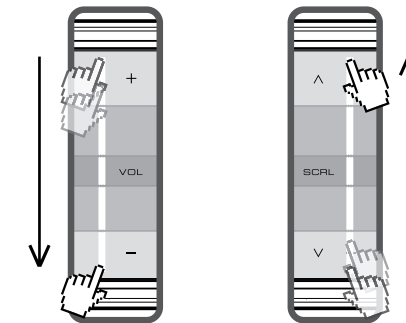

- Touch & hold slider [+] will increase volume continuously.

- Touch and release [+] once will increase the volume 1 step.

- Touch & hold slider [-] will decrease volume continuously.

- Touch and release [-] once will decrease the volume 1 step.

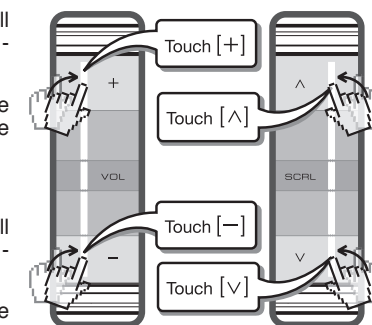

- Touch & hold [^] will scroll up items continuously.

- Touch and release [^] once will scroll up items 1 step.

- Touch & hold [v] will scroll down items continuously.

- Touch and release [v] once will scroll down items 1 step.

5. REMOTE CONTROL

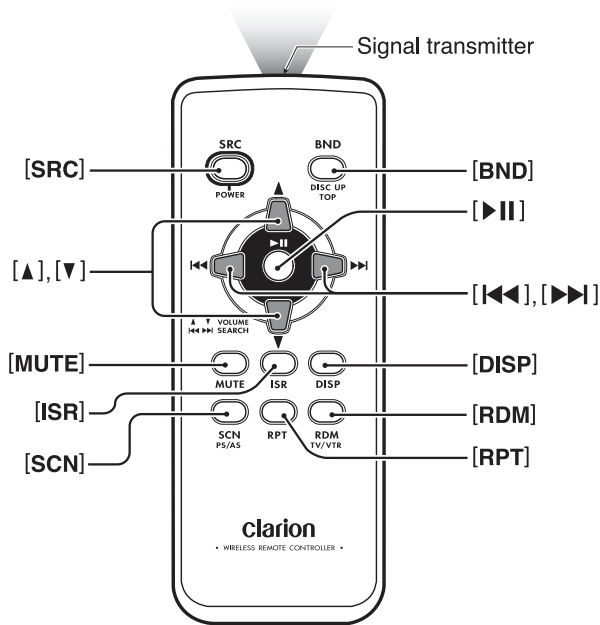

Inserting the Battery

1. Turn over the remote control unit and slide the cover in the direction indicated by the arrow in the illustration.
2. Insert the battery (CR2025) into the insertion guides, with the printed side (+) facing upwards.
3. Press the battery in the direction indicated by the arrow so that it slides into the compartment.
4. Replace the cover and slide in until it clicks into place.

Notes:

Misuse may result in rupture of the battery, producing leakage of fluid and resulting in personal injury or damage to surrounding materials. Always follow these safety precautions:

- Use only the designated battery.
- When replacing the battery, insert properly, with +/- polarities oriented correctly.
- Do not subject battery to heat, or dispose of in fire or water. Do not attempt to disassemble the battery.
- Dispose of used batteries properly.

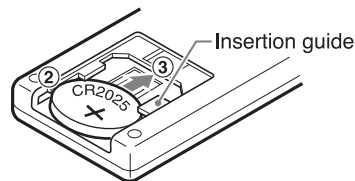
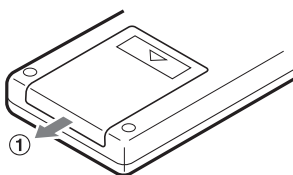

Functions of Remote Control Unit Buttons

Mode Button	Radio/Satellite	USB	iPod	BT Audio	AUX
[SRC]	Press the button to power on. Press and hold the button for 1 second or longer: Power off. Switch among radio, Satellite radio receiver, USB, BT Audio, AUX and iPod.				
[BND]	Switch reception band.	Play the first track. Top play.	iPod menu	No function.	
[▲], [▼]	Increase and decrease volume (in all modes).				
[◀◀], [▶▶]	Move preset channels up and down.	Move tracks up and down. Press and hold the button for 1 second or longer: Fast-forward/fast-backward.		Move tracks up and down.	No function.
[▶]	No function.	Switch between playback and pause.		No function.	
[MUTE]	Turn mute on and off.				
[ISR]	Recall ISR radio station in memory. Press and hold for 2 seconds or longer: Store current station into ISR memory (Radio mode only).				
[DISP]	Switch among main display, title display.			No function.	
[SCN]	Preset scan. Press and hold the button for 2 seconds or longer: Auto store.	Scan play. Press and hold the button for 1 second or longer to perform folder scan play.	No function.	No function.	
[RPT]	No function.	Repeat play. Press and hold the button for 1 second or longer to perform folder repeat play.	Toggle repeat on/off.	No function.	
[RDM]	No function.	Random play. Press and hold the button for 1 second or longer to perform folder random play.	Random play. Press and hold the button for 1 second or longer to perform folder random play.	No function.	

* Some of the corresponding buttons on the main unit and remote control unit have different functions.

* TV/VTR is not supported in this model.

6. OPERATIONS

Basic Operations

Note: Be sure to read this chapter referring to the front diagrams of chapter “2. CONTROLS” on page 3.

⚠ CAUTION

Be sure to lower the volume before switching off the unit power or the ignition key. The unit remembers its last volume setting. If you switch the power off with the volume up, when you switch the power back on, the sudden loud volume may hurt your hearing and damage the unit.

Please operate this unit by the finger. It is not possible to operate it normally with gloves worn.

Turning on/off the power

Note:

- Be careful about using this unit for a long time without running the engine. If you drain the car’s battery too far, you may not be able to start the engine and this can reduce the service life of the battery.
1. Touch the [PWR] key to power on the unit.
 2. The unit automatically remembers its last Operation mode and will automatically switch to display that mode.
 3. Touch and hold the [PWR] key for 1 second or longer to turn off the power for the unit.

Note:

- **System check**
The first time this unit is turned on after the wire connections are completed, it must be checked what equipment is connected. When the power is turned on, the “SYSTEM CHECK” appears in the display. This unit will switch to Radio mode after system check.

Selecting a mode

1. Touch the [PWR] key to switch to Source menu.
2. Touch the corresponding key beside the Source mode name to enter into desired mode.
3. There are 6 selections in the Source menu:



- * iPod can connect to this unit via USB SLOT.
- * SIRIUS and XM mode only available when a Satellite Radio Receiver is connected through the CeNET cable.

Adjusting the volume

1. Slide up along the [VOL+] slider or touch the [+] key to increases the volume.
 2. Slide down along the [VOL-] slider or touch the [-] key to decreases the volume.
- * The volume level is from 0 (minimum) to 33 (maximum).

Switching the title display

1. Touch the [DISP] key to switch the title display.
2. Each time you touch the [DISP] key, the display switches in the following order:

- **Tuner/AUX/BT mode**

No Title display.

- **SAT mode**

CHANNEL (CATEGORY) → CATEGORY (TITLE)
→ TITLE (ARTIST) → ARTIST (RADIO TEXT) →
RADIO TEXT (CHANNEL) →
CHANNEL (CATEGORY)

- **iPod mode**

TRACK (ALBUM) → ALBUM (ARTIST) →
ARTIST (TRACK) → TRACK (ALBUM)

- **USB mode**

ALBUM (TRACK) → ARTIST (TITLE) →
ARTIST (TRACK) → FOLDER (TRACK) →
FOLDER (TITLE) → ALBUM (TRACK)

Basic Operations

- * Once selected, the preferred title display becomes the display default. When a function adjustment such as volume is made, the screen will momentarily switch to that function's display, then revert back to the preferred title display several seconds after the adjustment.
- * If the button operation is performed with the screen saver function on, the operation display corresponding to the button operation is shown for about 30 seconds and the display returns to the screen saver display. For details, refer to the subsection "Turning the screen saver function on or off" in section "Common Operations".

Switching the display layout

1. Touch the [DISP] key for more than 1 second to switch display layout.
2. Each time you touch the [DISP] key for more than 1 second, the display layout switches in the following order:

Title mode → Indicator mode → Clock

Example: iPod



(Title mode)



(Indicator mode)

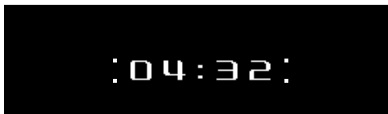

(Clock)

Sound adjustments

You can adjust a sound effect or tone quality to your preference.

To change sound setting

1. Touch the [ADJ] key to switch to ADJ menu.
2. Select "SOUND" in the menu to enter Sound Adjustment mode.
3. Slide along the [SCRL] slider or touch [^]/[V] key, the Sound Adjustment mode changed as following order:
 "BEAT EQ" ↔ ("BASS" ↔ "MID" ↔ "TREBLE")*1 ↔ "BBE MP"*2 ↔ "BALANCE" ↔ "FADER" ↔ "M-BEX" ↔ "HPF" ↔ "S-W LPF" ↔ "S-W VOL" ↔ "BEAT EQ"...

Notes:

*1: BASS/MID/TREBLE are only available if "CUSTOM" is selected in "BEAT EQ".

*2: BBE MP is only available if "USB" is selected in source mode and the "OUTPUT FORM" is set to "DIGITAL". (Please refer to page 25)

● Setting the BEAT EQ

This unit is provided with 4 types of sound tone effects stored in memory. Select the one you prefer.

* The factory default setting is "OFF".

- ① Select "BEAT EQ".
- ② Touch [>] key to enter detail setting stage.
- ③ During detail setting stage, each time your slide along [SCRL] slider or touch [^]/[V] key, the tone effect changes in the following order:

"OFF" ↔ "BASS BOOST" ↔ "IMPACT" ↔ "EXCITE" ↔ "CUSTOM"

OFF : No sound effect

BASS BOOST : Bass emphasized

IMPACT : Bass and treble emphasized

EXCITE : Bass and treble emphasized mid emphasized

CUSTOM : User custom

Basic Operations

When “BASS BOOST”/“IMPACT”/“EXCITE” is set:

“BASS BOOST”/“IMPACT”/“EXCITE” will appear after the “BEAT EQ” item in the sound Adjustment mode.

- ③-①-①. Select the item and touch [>] key to enter detail setting stage.
- ③-③-②. Slide along [^{SCAL}] slider or touch [^]/[v] key to adjust the setting in the range of -3 to +3.
* The factory default setting is “0”.
- ③-③-③. After completing settings, touch the [ENT] key to return to the 1st selected item.

When “CUSTOM” is set:

- ③-③-①. Slide along [^{SCAL}] slider or touch [^]/[v] key to select the “BASS”, “MID” or “TREBLE” mode to adjust.

● Adjusting the bass

This adjustment can be performed only when the BEAT EQ is set to “CUSTOM”.

- ③-①. Select “BASS”.
- ③-②. Touch [>] key to enter detail setting stage.



- ③-③. Touch [<]/[>] key to select Gain(“G”), center frequency(“F”) or Q factor(“Q”).
- ③-④. Slide along [^{SCAL}] slider or touch [^]/[v] key to adjust the value.
* The factory default setting:
G : “0” (Adjustment range: +7 to -7)
F : “50Hz” (Adjustment range: 50/100/200)
Q : “1.0” (Adjustment range: 0.7/1.0/1.4/2.0)

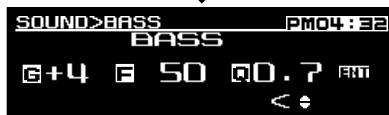
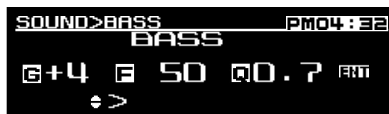

- ③-⑤. After completing settings, touch the [ENT] key to return to the 1st selected item.

● Adjusting the mid

This adjustment can be performed only when the BEAT EQ is set to “CUSTOM”.

- ③-①. Select “MID”.
- ③-②. Touch [>] key to enter detail setting stage.



- ③-③. Touch [<]/[>] key to select Gain(“G”), center frequency(“F”) or Q factor(“Q”).
- ③-④. Slide along [^{SCAL}] slider or touch [^]/[v] key to adjust the value.
* The factory default setting:
G : “0” (Adjustment range: +7 to -7)
F : “500Hz” (Adjustment range: 500/1k/2k)
Q : “1.0” (Adjustment range: 0.7/1.0/1.4/2.0)

Basic Operations



- ③⑤. After completing settings, touch the [ENT] key to return to the 1st selected item.

● Adjusting the treble

This adjustment can be performed only when the BEAT EQ is set to “CUSTOM”.

- ③①. Select “TREBLE”.
 ③②. Touch [>] key to enter detail setting stage.



- ③③. Touch [<]/[>] key to select Gain(“G”), center frequency(“F”) or Q factor(“Q”).
 ③④. Slide along [^{SCRL}] slider or touch [^]/[v] key to adjust the value.
 * The factory default setting:
 G : “0” (Adjustment range: +7 to -7)
 F : “10kHz” (Adjustment range: 5k/10k/15k)
 Q : “1.0” (Adjustment range: 0.7/1.0/1.4/2.0)



- ③⑤. After completing settings, touch the [ENT] key to return to the 1st selected item.

● Setting the BBE MP (Sound Enhancement and Restoration for compressed audio files)

BBE MP (Minimized Polynomial Non-Linear Saturation) Process improves digitally compressed sound, such as MP3, by restoring and enhancing the harmonics lost through compression. BBE MP works by regenerating harmonics from the source material, effectively recovering warmth, detail and nuance.

* This function is effective for the audio files in the USB/iPod mode, but it is ineffective for the video in the USB/iPod mode.

- ③①. Select “BBE MP”.
 ③②. Touch [>] key to enter detail setting stage.
 ③③. Slide along [^{SCRL}] slider or touch [^]/[v] key to select the value in sequence of “OFF” ↔ “ON”.
 * The factory default setting is “OFF”.

Basic Operations

When “ON” is set:

- ③-① Touch [>] key to enter detail setting stage.
- ③-② Slide along [$\overset{\wedge}{\text{SCRL}}\underset{\vee}{}$] slider or touch [\wedge]/[\vee] key to select the value in sequence of “HIGH” \leftrightarrow “MID” \leftrightarrow “LOW”
 - * The factory default setting is “MID”.
- ③-④ After completing settings, touch the [ENT] key to return to the 1st selected item.

● Adjusting the balance

- ③-① Select “BALANCE”.
- ③-② Touch [>] key to enter detail setting stage.
- ③-③ Slide along [$\overset{\wedge}{\text{SCRL}}\underset{\vee}{}$] slider or touch [\wedge]/[\vee] key to adjust the balance of the right and left speakers.
 - * The factory default setting is “CENTER”.
(Adjustment range: RIGHT 12 to LEFT 12)
- ③-④ After completing settings, touch the [ENT] key to return to the 1st selected item.

● Adjusting the fader

- ③-① Select “FADER”.
- ③-② Touch [>] key to enter detail setting stage.
- ③-③ Slide along [$\overset{\wedge}{\text{SCRL}}\underset{\vee}{}$] slider or touch [\wedge]/[\vee] key to adjust the balance of the rear and front speakers.
 - * The factory default setting is “CENTER”.
(Adjustment range: FRONT 12 to REAR 12)
- ③-④ After completing settings, touch the [ENT] key to return to the 1st selected item.

● Adjusting the M-BEX

- ③-① Select “M-BEX”.
- ③-② Touch [>] key to enter detail setting stage.
- ③-③ Slide along [$\overset{\wedge}{\text{SCRL}}\underset{\vee}{}$] slider or touch [\wedge]/[\vee] key to turn on or turn off the MAGNA BASS EXTEND effect.
 - * The factory default setting is “OFF”.
(Adjustment range: ON/OFF)
- ③-④ After completing settings, touch the [ENT] key to return to the 1st selected item.

● Adjusting the high pass filter

- ③-① Select “HPF”.
- ③-② Touch [>] key to enter detail setting stage.
- ③-③ Slide along [$\overset{\wedge}{\text{SCRL}}\underset{\vee}{}$] slider or touch [\wedge]/[\vee] key to select the setting in sequence “60” \leftrightarrow “90” \leftrightarrow “120” \leftrightarrow “THROUGH”
 - * The factory default setting is “THROUGH”.
 - * This is supported only with amplifiers equipped with this function. Output is not supported from RCA cables.

● Setting the subwoofer

You can set the low pass filter of subwoofer.

- ③-① Select “S-W LPF”.
- ③-② Touch [>] key to enter detail setting stage.
- ③-③ Slide along [$\overset{\wedge}{\text{SCRL}}\underset{\vee}{}$] slider or touch [\wedge]/[\vee] key to select the setting in sequence “THROUGH” \leftrightarrow “60” \leftrightarrow “90” \leftrightarrow “120”
 - * The factory default setting is “THROUGH”.

● Adjusting the subwoofer output volume

You can adjust the volume output from the unit’s subwoofer output terminal.

This adjustment can be performed only when the “S-W LPF” is set to “60”, “90” or “120”.



- ③-① Select “S-W VOL”.
- ③-② Touch [>] key to enter detail setting stage.
- ③-③ Slide along [$\overset{\wedge}{\text{SCRL}}\underset{\vee}{}$] slider or touch [\wedge]/[\vee] key to increase or decreases the subwoofer volume.
 - * The factory default setting is “0”.
(Adjustment range: +6 to -6)
 - * When the volume level is more than 30, the subwoofer volume adjustment value can not reach +6.

Note:

- During SOUND Adjustment mode, if no operation is performed for more than 10 seconds, this mode can be cancelled and return to previous mode.

Radio Mode Operations



Listening to the radio

1. Touch the [] key to switch to Source menu.
2. Select "TUNER" to enter Radio mode.
3. To select a preset band, touch the [] key and then select one of the preset bands such as FM1, FM2, FM3 or AM1.
Every time the [] key is touched, the band switches in the following order:
FM1 → FM2 → FM3 → AM1 → FM1...
4. Touch the [<]/[>] key to tune in the desired station.

Tuning

There are 3 types of tuning mode available, seek tuning, manual tuning and preset tuning.

Seek tuning



1. Touch the [] key and select the desired band (FM or AM).
* If **MANU** is lit in the display, touch and hold the [] key for 1 second or longer. **MANU** in the display goes off and seek tuning is now available.
2. Touch the [<]/[>] key to start automatic station tuning.

When the [>] key is touched, the station is sought in the direction of higher frequencies; if the [<] key is touched, the station is sought in the direction of lower frequencies.

Manual tuning

There are 2 ways available:
Quick tuning and step tuning.

When you are in the step Tuning mode, the frequency changes one step at a time. In the Quick Tuning mode, you can quickly tune the desired frequency.

1. Touch the [] key and select the desired band (FM or AM).
* If **MANU** is not lit in the display, touch and hold the [] key for 1 second or longer. **MANU** is lit in the display and manual tuning is now available.
2. Tune into a station.

● Quick tuning

Touch and hold the [<]/[>] key for 1 second or longer to begin station tuning.





● Step tuning

Touch the [<]/[>] key to perform manual tuning.

Radio function

You need to enter the TUNER OPTION to perform the Radio function.



TUNER OPTION

1. During Tuner mode, touch the [] key to switch to ADJ menu.
2. Select "OPTION" in the menu to enter Tuner Option mode.
3. Slide along [] slider or touch []/[] key, the TUNER OPTION mode changed as following order:
"P.CH MEMORY" ↔ "PRESET SCAN"
↔ "AUTO STORE" ↔ "TITLE INPUT"
"P.CH MEMORY"...

● Preset memory function

Preset memory function can store up to 24 stations: Six stations for each of FM1, FM2, FM3, and AM1.

● Manual memory function

1. Select "P.CH MEMORY".
2. Touch [>] key to enter detail setting stage.
3. Slide along [] slider or touch []/[] key to select the preset channel number to be stored.
4. Touch [ENT] key for 2 seconds to store the frequency into the selected preset channel.
5. "MEMORY" is displayed for 2 seconds before revert to main display.

Radio Mode Operations

● Preset scan

Preset scan receives the stations stored in preset memory in order. This function is useful when searching for a desired station in memory.

- ③① Select **"PRESET SCAN"**.
- ③② Touch [ENT] key to start scan preset channel.
- ③③ When a desired station is tuned in, touch the [<]/[>] key to continue receiving that station.

● Auto store

Auto store is a function for storing up to 6 stations that are automatically tuned in sequentially. If 6 receivable stations cannot be received, a previously stored station remains un-overwritten at the memory position.

- ③① Select **"AUTO STORE"**.
- ③② Touch [ENT] key to start performing auto store function.
- ③③ The stations with good reception are stored automatically to the preset channels.
 - * If auto store is performed in the FM bands, the stations are stored in FM3 even if FM1 or FM2 was chosen for storing stations.
 - * **"AUTO STORE"** will appears in the display.



Recalling a preset station

A total of 24 preset positions (6-FM1, 6-FM2, 6-FM3, 6-AM1) exists to store individual radio stations in memory.

There are 2 methods to recall a preset station.

Method 1:

- ③① Select **"P.CH MEMORY"**.
- ③② Touch [>] key to enter detail setting stage.
- ③③ Slide along [SCRL] slider or touch [^]/[v] key to select the desired preset station.
- ③④ Touch [ENT] key for less than 1 second to recall the stored radio frequency.

Method 2:

1. Touch the [] key to select the desired band.
2. Slide along [SCRL] slider or touch [^]/[v] key to select the desired preset station.
3. Touch [ENT] key to recall the stored radio frequency.

Entering titles

Titles up to 10 characters long can be stored in memory and displayed for Radio stations.

- ③① Select **"TITLE INPUT"**.
- ③② Touch [>] key to enter detail setting stage.
- ③③ Touch [<]/[>] key to move the cursor.
- ③④ Slide along [SCRL] slider or touch [^]/[v] key to input the text.
- ③⑤ Touch and hold the [ENT] key for 2 seconds or longer to store the title into memory.
 - * Entered titles will be deleted when back up power is disconnected.

Instant station recall (ISR)

Instant station recall is a special radio preset that instantly accesses a favorite radio station at a touch of a key. The ISR function even operates with the unit in other modes.

● ISR memory

1. Select the station that you wish to store in ISR memory.
2. Touch and hold the [••] key for 2 seconds.

● Recalling a station with ISR

In any mode, touch the [••] key to turn on the radio function and tune the selected radio station. Touch the [••] key again to return to the previous mode.

USB Operations

USB memory device operation

About USB memory

- USB is an acronym for Universal Serial Bus, and refers to an external bus standard supporting data transfer rates of 12 Mbps.
- This unit is compatible with USB 1.1/2.0 with maximum data transfer rates of 12 Mbps.
- USB memory devices that can be played by connecting to the unit's USB cable are limited to those recognized as "**USB mass storage class devices**"; operation is not guaranteed with all USB memory devices.
 - * Devices compatible with "**USB Mass Storage Class**" can be used merely by connecting to the host device, without need for special drivers or application software.
- Consult the manufacturer of your USB memory device for information regarding whether it is supported by "**USB Mass Storage Class**" standards.
- Audio files playable on this unit are limited to MP3/WMA/AAC files.
- To prevent the accidental loss of data, always back up important data on your computer.
- This unit does not support connections to a computer. In addition, connections made through a USB hub device are also not supported.
- When a USB memory device is composed of two or more drives, only one of the drives will be detected.
- USB memory devices with security functions cannot be played.
- The order in which tracks are recorded may differ depending on the USB memory device connected (the actual playback order may not be the same as that indicated on your computer's display).
- If you continuously operate folder up/down, the play time keeps as "**00:00**", and the sound is not emitted.

What is MP3?

MP3 is an audio compression method and classified into audio layer 3 of MPEG standards. This audio compression method has penetrated into PC users and become a standard format. This MP3 features the original audio data compression to about 10 percent of its initial size with a high sound quality. This means that several music CDs can be recorded on a USB memory device to allow a long listening time*.

* Depends on the USB memory device storage capacity.

What is WMA?

WMA is the abbreviation of Windows Media Audio, an audio file format developed by Microsoft Corporation.

Notes:

- If you play a file with DRM (Digital Rights Management) for WMA remaining ON, no audio is output (The "--:--" and **WMA** indicator blinks for 5 seconds and go to next track).
- Windows Media™, and the Windows® logo are trademarks, or registered trademarks of Microsoft Corporation in the United States and/or other countries.

● To disable DRM (Digital Rights Management)

1. When using Windows Media Player 9/10/11, click on TOOL → OPTIONS → MUSIC RECORD tab, then under Recording settings, unclick the check box for RECORD PROTECTED MUSIC. Then, reconstruct files.

Personally constructed WMA files are used at your own responsibility.

USB Operations

What is AAC?

- AAC is an acronym for “**Advanced Audio Coding**” and refers to the audio compression method used with video compression standards MPEG-2 and MPEG-4.
- AAC files composed with the following conditions can be played:
 - AAC files encoded with iTunes.
 - iTunes Ver. 7.0 or earlier.
 - File extension “.m4a” (“.M4A”)
 - Tracks purchased at an iTunes Store, and copyright-protected files cannot be played.
 - When playing AAC files that include image data, additional time may be required before playback begins.
 - Files may not play properly, depending on the iTunes version under which an AAC file is encoded.

Precautions when creating MP3/WMA/AAC file

● Usable sampling rates and bit rates

See “**USB**” (page 42) for details.

● File extensions

1. Always add a file extension “.MP3”, “.WMA” or “.M4A” to MP3, WMA or AAC file by using single byte letters. If you add a file extension other than specified or forget to add the file extension, the file cannot be played.
2. Files without MP3/WMA/AAC data will not play. The indication “**NO FILE**” appears in the play time display if you attempt to play files without MP3/WMA/AAC data.
 - * When VBR files are played, the play time display may differ the play location.
 - * When MP3/WMA/AAC files are played, a little no sound part is caused between tunes.

● Logical format (File system)

1. When writing MP3/WMA/AAC file, please select “**FAT12**”, “**FAT16**” or “**FAT32**” as the file system format. Normal play may not be possible if the files are recorded on another format.
2. The folder name and file name can be displayed as the title during MP3/WMA/AAC play but the title must be within 64 single byte alphabetical letters and numerals (including an extension).
3. Do not affix a name to a file inside a folder having the same name.

Note:

- File names in small letters with less than 8 characters (not including file extension) will be displayed in capital letters.

● Folder structure

1. A USB with a folder having more than 8 hierarchical levels will be impossible.

● Number of files or folders

1. Up to 255 files per folder can be recognized. Up to 512 folders can be recognized and up to total of 130560 files can be played.
2. Tracks are played in the order that they were recorded onto a USB. (Tracks might not always be played in the order displayed on the PC.)
3. Some noise may occur depending on the type of encoder software used while recording.

CAUTION

- **Insert and remove a USB memory device only when the device is not being accessed. Connecting or disconnecting the device at the following times may result in the loss of data:**

- If the USB memory device is removed or power is disconnected during writing to the device.
- When the device is subjected to static electricity or electric noise.

- **Do not leave a USB memory device unattended in an automobile. Exposure to direct sunlight or high temperatures may cause deformation or other malfunction of the USB memory device.**

USB Operations

Connecting a USB memory device

1. Connect the USB memory device to the USB slot.

Playback will begin from the first file recorded on the device.

- * If the device is not recognized, touch the [] key to switch to the Source menu and select the source to the device.
- * Always insert the device fully into the connector. Incomplete connections may cause the device not to be recognized.
- * Depending on the number of tracks recorded, some amount of time may be required until all tracks are read into the unit.
- * The order in which tracks are recorded may differ depending on the device connected (the actual playback order may not be the same as that indicated on your computer's display).

To listen to tracks on a connected USB memory device

1. Touch the [] key to switch to the Source menu and select the "USB". When USB memory device is selected, playback (except DRM files) will begin from the location at which playback was previously stopped.
 - * When a USB memory device is connected the USB mode will be displayed.
 - * When a USB memory device is disconnected and then reconnected, playback will begin from the previous position where playback is stopped.
 - * When a USB memory device is disconnected and then a different USB memory device is connected, playback will begin from the first file recorded on the device.

To stop play

1. Touch the [] key and switch the function to a source other than the USB memory device.



CAUTION

Do not remove the USB memory device when the USB mode is selected, since it may result in loss or damage to data on the USB memory device.

Always backup and save important data on your computer.

2. Remove the USB memory device from the USB slot.

Pausing play

1. Touch the [] key to pause play. "PAUSE" appears in the display.
2. To resume play, touch the [] key again.

Selecting a track

● Track-up

1. Touch the [>] key to move to the beginning of the next track.
2. Each time the [>] key is touched, playback proceeds to another track in the advancing direction.

● Track-down

1. Touch the [<] key to move to the beginning of the current track.
2. Touch the [<] key twice to move to the beginning of the previous track.

Fast-forward/fast-backward

● Fast-forward

Touch and hold the [>] key for 1 second or longer.

● Fast-backward





Touch and hold the [<] key for 1 second or longer.

Top function

Touch the [] key for 1 second or longer, then the USB memory device will start playing the first track of current folder.

Other various play functions

USB OPTION

1. During USB mode, touch the [] key to switch to ADJ menu.
2. Select "OPTION" in the menu to enter USB Option mode.
3. Slide along [] slider or touch []/[] key, the USB Option mode changed as following order:
"SCAN" ↔ "REPEAT" ↔ "RANDOM"
↔ "SCAN"...

Note:

- During trick play, "TRICK OFF" will be appeared before "SCAN" item.

USB Operations

● Scan play

This function allows you to locate and play the first 10 seconds of all the tracks in current folder.

- ③-①. Select **"SCAN"**.
- ③-②. Touch [**>**] key to enter detail setting stage.
- ③-③. Slide along [**SCRL**] slider or touch [**^**]/[**v**] key to select **"TRACK"**.
- ③-④. Touch the [**ENT**] key, **"TRACK SCAN"** will be displayed for 2 seconds.
- ③-⑤. During scan,  will keep blinking.

* Scan play starts from the next track after the track currently being played.

* Scan play will proceed to next folder after all the tracks in the current folder have been scanned.

● All scan play

This function allows you to locate and play the first 10 seconds of the first track of all the folders.

- ③-①. Select **"SCAN"**.
- ③-②. Touch [**>**] key to enter detail setting stage.
- ③-③. Slide along [**SCRL**] slider or touch [**^**]/[**v**] key to select **"ALL"**.
- ③-④. Touch the [**ENT**] key, **"ALL SCAN"** will be displayed for 2 seconds.
- ③-⑤. During scan,  will keep blinking.

* All scan play starts from the first track of next folder.

● Repeat play

This function allows you to play the current track repeatedly.

- ③-①. Select **"REPEAT"**.
- ③-②. Touch [**>**] key to enter detail setting stage.
- ③-③. Slide along [**SCRL**] slider or touch [**^**]/[**v**] key to select **"TRACK"**.
- ③-④. Touch the [**ENT**] key, **"TRACK REPEAT"** will be displayed for 2 seconds.
- ③-⑤.  lights in the display.

● All repeat play

This function allows you to play all tracks in the MP3/WMA/AAC current folder repeatedly.

- ③-①. Select **"REPEAT"**.
- ③-②. Touch [**>**] key to enter detail setting stage.
- ③-③. Slide along [**SCRL**] slider or touch [**^**]/[**v**] key to select **"ALL"**.
- ③-④. Touch the [**ENT**] key, **"ALL REPEAT"** will be displayed for 2 seconds.
- ③-⑤.  lights in the display.

● Random play

This function allows you to play all tracks of current folder in a random order.

- ③-①. Select **"RANDOM"**.
- ③-②. Touch [**>**] key to enter detail setting stage.
- ③-③. Slide along [**SCRL**] slider or touch [**^**]/[**v**] key to select **"TRACK"**.
- ③-④. Touch the [**ENT**] key, **"TRACK RANDOM"** will be displayed for 2 seconds.
- ③-⑤.  lights in the display.

● All random play

This function allows you to play all the tracks of all the folders recorded on an USB in a random order.

- ③-①. Select **"RANDOM"**.
- ③-②. Touch [**>**] key to enter detail setting stage.
- ③-③. Slide along [**SCRL**] slider or touch [**^**]/[**v**] key to select **"ALL"**.
- ③-④. Touch the [**ENT**] key, **"ALL RANDOM"** will be displayed for 2 seconds.
- ③-⑤.  lights in the display.



● To cancel trick play



- ③-①. Select **"TRICK OFF"**.
- ③-②. Touch [**ENT**] key to cancel trick play.
- ③-③. Display will return to playback display.

USB Operations

Folder Select

This function allows you to select a folder containing MP3/WMA/AAC files and start playing from the first track in the folder.

1. Slide along [] slider or touch []/[] key.

Touch [] key to move the next folder. Touch [] key to move the previous folder.

- * Touch [] key while in the final folder will shift to the first folder.
- * Folder without a MP3/WMA/AAC file is not selectable.
- * Folder name will be displayed for a while.

iPod Operations

This section describes operations when connected to an Apple iPod via the USB slot.

Notes:

- See the iPod Owner's Manual for details regarding operation conditions.
- The unit will not operate, or may operate improperly with unsupported versions.
- For a list of compatible Apple iPod unit with the this model, please contact your Clarion dealer or www.clarion.com.

Connecting an iPod

When an iPod is connected to the USB slot, "Shuffle" set on the iPod will become as follows:

- "Shuffle (Albums)" play → Random play
- "Shuffle (Songs)" play → All random play

The iPod have iPod menu which can toggle with Play mode by touching the [] key for 1 second or longer.

If iPod supports video capability, the following screen will be displayed first before switching to the iPod menu.



Touch [] key to enter music menu or video menu.

Select iPod mode

1. Connect your iPod to the USB connector. The system will automatically detect the connected device and change to the USB mode (iPod mode) and start playback after a while.

● When an iPod is already connected

1. Touch the [] key to switch to the source menu.
2. Touch the "USB" to select the iPod mode. The system changes to the USB mode (iPod mode), and starts playback from the previous position.

iPod Operations

Note:

- The following operations in Play mode operate the same as in USB mode:

- * **Track selection:** [<], [>]
- * **Fast-forward/fast-backward:** [<], [>]
- * **Pause:** []





See “USB Operations” (page 18) for details.

Other various play functions (in Play mode)

Notes:

- These functions are not supported when in the iPod menu.
- The Random function set on the iPod remains the same after attachment/detachment of the iPod.
- The Repeat function on the iPod will be changed when you connect/disconnect the iPod to the unit.

iPod OPTION





- During USB mode, touch the [] key to switch to ADJ menu.
- Select “OPTION” in the menu to enter iPod Option mode.
- Slide along [] slider or touch []/[] key, the iPod Option mode changed as following order:
 “REPEAT” ↔ “RANDOM” ↔
 “OUTPUT FORM” ↔ “SIMPLE MODE”
 ↔ “REPEAT”...

Note:

- During trick play, “TRICK OFF” will be appeared before “REPEAT” item.



● Repeat play

Play back one track repeatedly.

- Select “REPEAT”.
- Touch [>] key to enter detail setting stage.
- Slide along [] slider or touch []/[] key to select “ON”.
- Touch the [ENT] key, “REPEAT ON” will be displayed for 2 seconds.
-  lights in the display.





● Repeat off

This function allows you to play all tracks in the current folder repeatedly.

- Select “REPEAT”.
- Touch [>] key to enter detail setting stage.
- Slide along [] slider or touch []/[] key to select “OFF”.
- Touch the [ENT] key, “REPEAT OFF” will be displayed for 2 seconds.





● Random play

Play all albums within a selected category, in random order. (Corresponds to “Shuffle (Albums)” command on iPod.)

- Select “RANDOM”.
- Touch [>] key to enter detail setting stage.
- Slide along [] slider or touch []/[] key to select “TRACK”.
- Touch the [ENT] key, “TRACK RANDOM” will be displayed for 2 seconds.
-  lights in the display.

● All random play

Play all tracks within a selected category, in random order. (Corresponds to “Shuffle (Songs)” command on iPod.)

- Select “RANDOM”.
- Touch [>] key to enter detail setting stage.
- Slide along [] slider or touch []/[] key to select “ALL”.
- Touch the [ENT] key, “ALL RANDOM” will be displayed for 2 seconds.
-  lights in the display.

● To cancel trick play

- Select “TRICK OFF”.
- Touch the [ENT] key to cancel trick play.
- Display will return to playback display.

Note:

- When playing the last track within a selected category in Random mode, if ACC is switched off then on again, playback will begin from a different track.

iPod Operations

● Selecting category from the iPod music menu

1. Touch and hold the [] key for 1 second or longer.
2. Select to switch to music menu or video menu.
3. If “**MUSIC**” is selected from the list, iPod music menu categories will be displayed.

Notes:

- If the iPod does not support video, the iPod music menu categories will be displayed directly.
 - Repeat and Random mode operations are not supported when in the iPod menu.
 - In iPod menu, if you touch the [<]/[>] or touch [^]/[v] key fast, playback may not be performed.
4. Slide along [] slider or touch [^]/[v] key to select the category.
 5. There are 6 categories in the iPod music menu:
 - **Playlists**
 - **Artists**
 - **Albums**
 - **Songs**
 - **Genres**
 - **Composers**
 6. Touch [<]/[>] key to switch between layer.
 7. When the track name display is showing, touch the [ENT] key.

Playback will begin from the first track in the selected category, and the iPod menu will be canceled.

* Subfolders may be displayed, depending on the category.

In this case, use the [<]/[>] key to switch between subfolders, then use the [ENT] key to select the desired subfolder.

* When the track name display is showing, touch the [<] key will return to the currently playing folder name display.

8. Slide along [] slider or touch [^]/[v] key to select a track within a category.

● Selecting category from the iPod video menu



1. Touch and hold the [] key for 1 second or longer.
2. Select to switch to music menu or video menu.
3. If “**VIDEO**” is selected from the list, iPod video menu categories will be displayed.

Note:

- Repeat and Random mode operations are not supported when in the iPod menu.
4. Slide along [] slider or touch [^]/[v] key to select the category.
 5. The categories in the iPod video menu is depend on the iPod.
 - * During video files playback, if ACC is switched off then switched on again, or if iPod is disconnected, playback cannot be resumed.
 - * Random play cannot be selected in iPod video mode. There is no album in the video menu.
 - * Please set the language setting in the iPod to English as this unit can only display English.

● iPod menu ABC search

This function searches the subfolders for desired alphabetical letters.

1. During iPod menu, slide along [] slider or touch [^]/[v] key and select the desired category.
2. Touch the [] key for 1 second or longer.
 - * A small window for alphabet selection will be displayed.
3. Select the alphabet by slide along [] slider or touch [^]/[v] key and touch [ENT] key to perform search.
4. “**SEARCHING**” will be displayed.
 - * During search, touch the [ENT] key to cancel search.

iPod Operations

● About title display

This unit supports the display of title information transmitted from a connected iPod.

- Character code information is UTF-8; displayable characters include English alphanumerics, some symbols, and some umlaut characters.
- Unsupported characters will be replaced by asterisks (*).

● Output Form

This function is to select digital output or analog output from this unit. This setting is for video playback via iPod 5G.

When you connect other than iPod 5G or when you play only audio files, please set this setting to **"DIGITAL"**.

If you set this setting to **"ANALOG"**, optional iPod video cable CCA723 is required.

* The factory default setting is **"DIGITAL"**.

- ③①. Select **"OUTPUT FORM"**.
- ③②. Touch [**>**] key to enter detail setting stage.
- ③③. Slide along [^{SCRL} **∇**] slider or touch [**∇**]/[**∧**] key to select **"DIGITAL"** or **"ANALOG"**.
- ③④. After completing settings, touch the [**ENT**] key to return to the 1st selected item.

Note:

- The setting will only take effect after disconnecting and re-connecting the iPod.

● Select Simple Control mode

This function is to select the mode to operate the iPod contents.

* The factory default setting is **"OFF"**.

- ③①. Select **"SIMPLE MODE"**.
- ③②. Touch [**>**] key to enter detail setting stage.
- ③③. Slide along [^{SCRL} **∇**] slider or touch [**∧**]/[**∇**] key to select **"ON"** or **"OFF"**.

● ON

To operate iPod contents from iPod.

● OFF

To operate iPod contents from this unit.

- ③④. After completing settings, touch the [**ENT**] key to return to the 1st selected item.

Notes:

- During iPod Simple mode ON, **"iPod Mode"** will be displayed as below and cannot switch to other display layout:



- During Simple Mode On, do not operate from iPod and this unit at the same time.
- iPod 5G and iPod nano 1G cannot select both digital output and simple control mode on at the same time.
 - * Output form: Digital and Simple mode: OFF - Default
 - * Output form: Digital and Simple mode: ON - Not selectable
 - * Output form: Analog and Simple mode: ON/OFF - Requires CCA723 cable
- During Simple Mode On, please do not change the repeat setting to **"OFF"** in the iPod.

Satellite Radio Operations

This function is available when a Satellite Radio Tuner is connected.

This unit can control the following Satellite Radio Tuner through the CeNET Translator Adapter.

- XM Satellite Mini Tuner
(Which needs Universal CeNET Translator Adapter)
- SIRIUS Satellite Universal Tuner
(Which needs CeNET Translator: CLA-SC1)

Note:

- The function is differ depending to the connected receiver, they are distinguished by the following notations:
 - "XM": for an XM Satellite Radio Tuner
 - "SIRIUS": for a SIRIUS Satellite Radio Tuner

Selecting a Satellite Radio mode

1. Touch the [] key to switch to Source menu.
2. Select the "SIRIUS" or "XM" to changes to the specified Satellite Radio mode.

Selecting a band

1. Touch the [] key to select a band.
This changes the reception band as follows:
 - "XM": XM1 → XM2 → XM3 → XM1 ...
 - "SIRIUS": SR1 → SR2 → SR3 → SR1 ...

Information displayed during reception





The following information is displayed when the satellite radio cannot be received normally.

- When the tuner is turned on the first time or after a reset: "UPDATING"
- When a channel is being tuned in (no signal is yet received):
 - XM: "LOADING", SIRIUS: "ACQUIRING"
- A channel without a broadcast has been selected:
 - XM: "CH UNAVAIL", SIRIUS: "INVALID CH"
- A channel not covered by your contract:
 - XM: "UPDATING", SIRIUS: "CALL 888"
"539-SIRI" (alternated)

Satellite function

You need to enter the SAT OPTION to perform the Satellite function.

SAT OPTION

- ①. During Sirius or XM mode, touch the [] key to switch to ADJ menu.
- ②. Select OPTION in the menu to enter SAT OPTION mode.
- ③. Slide along [] slider or touch []/[] key, the SAT OPTION mode changed as following order:
"P.CH MEMORY" ↔ "PRESET SCAN"
↔ "CATEGORY SCAN" ↔
"P.CH MEMORY" ...

Displaying channel labels

1. Touch the [] key to select the desired channel label.
CATEGORY → TITLE → ARTIST →
RADIO TEXT

Channel selection

1. Channels are selected with the [<] or [>] key.
* For details see the following operation descriptions.

Note:

- The audio output is muted and other button operations are not accepted during channel selection.

Tuning mode

There are two channel selection modes: quick tuning mode and step tuning mode.

- **Quick tuning**
 1. Touch and hold the [<] or [>] key for 1 second or longer.
- **Step tuning**
 1. Touch the [<] or [>] key.

Recalling a preset station

A total of 18 satellite radio stations can be stored.

- "XM": 6-XM1, 6-XM2 and 6-XM3
- "SIRIUS": 6-SR1, 6-SR2 and 6-SR3

Satellite Radio Operations

This allows you to store your favorite satellite radio stations in memory for later recall.

There are 2 methods to recall a preset station.

Method 1:

- ①-①. Select **"P.CH MEMORY"**.
- ①-②. Touch [**>**] key to enter detail setting stage.
- ①-③. Slide along [**SCRL**] slider or touch [**^**]/[**v**] key to select the desired preset station.
- ①-④. Touch [**ENT**] key for less than 1 second to recall the stored radio frequency.

Method 2:

1. Touch the [**■**] key to select the desired band.
2. Slide along [**SCRL**] slider or touch [**^**]/[**v**] key to select the desired preset station.
3. Touch [**ENT**] key to recall the stored radio frequency.

● Preset memory

1. Touch the [**■**] key to select the desired band.
- ①-①. Select **"P.CH MEMORY"**.
- ①-②. Touch [**>**] key to enter detail setting stage.
- ①-③. Slide along [**SCRL**] slider or touch [**^**]/[**v**] key to select the preset channel number to be stored.
- ①-④. Touch [**ENT**] key for 2 seconds to store the frequency into the selected preset channel.
- ①-⑤. **"MEMORY"** is displayed for 2 seconds before revert to main display.

● Receiving stations selected by category

Satellite Radio allows you to select broadcast channel category (contents).

1. Touch the [**■**] key for more than 1 second to select the category selection mode.
 - * If touch for more than 1 second again, returns to the channel selection mode.
2. Slide along [**SCRL**] slider or touch [**^**]/[**v**] key to change the category item.
3. Touch the [**<**] or [**>**] key to tune in a station.

Notes:

- When the category selection mode is entered, the category of the last received channel is displayed first.
- The category selection mode is canceled when no channel with the selected category can be found.
- If the [**<**]/[**>**] key are not touched within 7 seconds, the category selection mode is canceled, and resumes to the Channel mode.

● Recalling a preset category

Touch the [**■**] key for more than 1 second to select the category selection mode.

- ①-①. Select **"P.CH MEMORY"**.
- ①-②. Touch [**>**] key to enter detail setting stage.
- ①-③. Slide along [**SCRL**] slider or touch [**^**]/[**v**] key to select the desired preset category.
- ①-④. Touch [**ENT**] for less than 1 second to recall the preset category.

● Presetting a category

Touch the [**■**] key for more than 1 second to select the category selection mode.

- ①-①. Select **"P.CH MEMORY"**.
- ①-②. Touch [**>**] key to enter detail setting stage.
- ①-③. Slide along [**SCRL**] slider or touch [**^**]/[**v**] key to select the preset category number to be stored.
- ①-④. Touch [**ENT**] for 2 seconds to store the category into the selected preset memory.
- ①-⑤. **"MEMORY"** is displayed for 2 seconds before revert to main display.

Notes:

- When the name of a channel stored in memory is changed by a broadcasting channel, the display may show a channel name that differs from the stored name.
- A channel stored in memory may be discontinued at the option of the broadcasting channel.
- If no operation is performed for more than 1 second, category seek tuning can automatically tune in a receivable broadcast channel category.

Satellite Radio Operations

● Scan function

There are two scan modes: the category scan mode and the preset scan mode.

During scanning channels are displayed in abbreviated form, the display mode cannot be switched.

● Preset scan (PRESET SCAN)

A preset scan scans the channels (up to 18 channels) stored in the preset memory about every 10 seconds.

- ③①. Select "PRESET SCAN".
- ③②. Touch [ENT] to start scan preset channel.
- ③③. When a desired station is tuned in, touch the [<]/[>] key to continue receiving that station.

● Category scan (CATEGORY SCAN)

In a category scan, broadcast channels in the same category as the current channel are selected about every 10 seconds.

- ③①. Select "CATEGORY SCAN".
- ③②. Touch [ENT] key to start category scan.
- ③③. When a desired channel is tuned in, touch the [<]/[>] key to stay in that channel.

Note:

- Category scanning is not available when no category is defined for the current channel.

Bluetooth® Operations

The *Bluetooth*® interface allows you to utilize your car's built-in audio system for wireless mobile phone or music handsfree communication.

This unit will be able to retrieve phonebook contacts, perform outgoing call, receive incoming call and listen to music.

Note:

- When an audio device is paired, the following operations are the same as USB mode:

- * Play/Pause
- * Track up/down

See "USB Operations" (page23) for details.

Basic Operations

CALL METHOD

- ①. Touch the [☰] key to switch to ADJ menu.
- ②. Select "TEL" in the menu.
- ③. Touch the [>] key to select "CALL" to enter TEL menu.
- ④. Slide along [[^]SCR_L] slider or touch [^]/[v] key, the call method changed as following order:
 "PHONE BOOK" ↔ "HISTORY" ↔
 "REDIAL" ↔ "DIAL NUMBER"
 ↔ "PHONE BOOK"...

Note:

- "CALL" will only appear if paired mobile phone is connected.

● Call from Phonebook

User can search the contact name in the phonebook and make call.

Alternatively, user can call from mobile phone.

Bluetooth® Operations

- ④①. Select **"PHONE BOOK"**.
- ④②. Touch the [>] key to enter the contact name mode (In this case, slide along [^{SCRL}] slider or touch [^]/[v] key to select the desired contact name).
- ④③. When the contact name is displayed, touch the [>] key to view details.
- ④④. When contact name or contact details is displayed, touch the [ENT] key to call the mobile phone number.

● Received/Dialled/Missed Call History

You can browse and call from Received/Dialled/Missed Call History.

- ④①. Select **"HISTORY"**.
- ④②. Touch the [>] key to enter the contact name mode (In this case, slide along [^{SCRL}] slider or touch [^]/[v] key to select the desired contact name).
- ④③. When the contact name is displayed, touch the [>] key to view details.
- ④④. When contact name or contact details is displayed, touch the [ENT] key to call the mobile phone number.

Note:

- Only calls after phone connected with this unit will be displayed in the history list. There is no synchronization history calls between connected phone and this unit.

● Redial a Call

You can call a last dialed number of the phone.

- ④①. Select **"REDIAL"**.
- ④②. Touch the [ENT] key to redial the last number of the phone.

● Dial Number Call

Outgoing call can be made by entering telephone numbers.

Telephone number uses 0, 1, 2, 3, 4, 5, 6, 7, 8, 9, *, #, and +.

- ④①. Select **"DIAL NUMBER"**.
- ④②. Touch the [>] key to enter the dial mode.
- ④③. Touch the [<] or [>] button to move the cursor.
- ④④. Slide along [^{SCRL}] slider or touch [^]/[v] key to select the numbers.
- ④⑤. Touch the [ENT] key to call the mobile phone number.

● Answering a call

1. You can answer an incoming call by touching any key (except slide along the [^{SCRL}] slider).

● End a call

1. You can reject an incoming call or end an ongoing call by sliding down the [^{SCRL}] slider.







TEL OPTION

- ①. Touch the [] key to switch to ADJ menu.
- ②. Select **"TEL"** in the menu.
- ③. Touch the [<] key to select **"OPT"** to enter TEL OPTION mode.
- ④. Slide along the [^{SCRL}] slider or touch [^]/[v] key, the TEL OPTION mode changed as following order:
"PAIRING" ↔ "SELECT" ↔
↔ "DELETE" ↔ ("DISCONNECT
"ADD PHONEBOOK") ↔ "DEL
PHONEBOOK" ↔ "DEL HISTORY" ↔
"BOOK TYPE" ↔ "MIC GAIN" ↔
"RING VOL" ↔ "TONE SELECT" ↔
"NOISE CANCEL" ↔ "AUTO ANSWER"
↔ "AUTO CONNECT" ↔ "PASS
KEY" ↔ "ADDRESS" ↔ "VERSION"
↔ "BT NAME" ↔ "PAIRING"...

Notes:

- When user pairing at first time, **"BOOK TYPE"** is displayed before **"PAIRING"**. By select book type once, it appear later in the option list.
- The **"DISCONNECT"** will only appear if paired mobile phone is connected.
- The **"ADD PHONEBOOK"** will only appear if paired mobile phone is connected and selected Book Type has reserved memory for storing contacts.







BT  OPTION

- ①. During BT  mode, touch the [] key to switch to ADJ menu.
- ②. Select “**OPTION**” in the menu to enter the BT  OPTION mode.
- ③. Slide along the [] slider or touch []/[] key, the BT  OPTION mode changed as following order:
“**PAIRING**” ↔ “**DELETE**” ↔ “**PASS KEY**” ↔ “**ADDRESS**” ↔ “**VERSION**” ↔ “**PAIRING**”...

● PAIRING





This option is used to perform *Bluetooth*® pairing with the mobile phone and audio.

Up to a maximum of 5 mobile phones and an audio device can be paired.



- ④①. Select “**PAIRING**”.
- ④②. Touch the [] key to enter detail setting stage.
- ④③. Slide along [] slider or touch []/[] key to select “**TELEPHONE**” or “**AUDIO**” and then touch the [**ENT**] key.
- ④④. When you select “**TELEPHONE**”, slide along [] slider or touch []/[] key to select “**MEMORY 1**” to “**MEMORY 5**”.
- ④⑤. Touch the [**ENT**] key to enter pairing mode.

● SELECT

This is a setting for user to select one of the paired mobile phones.

- ④①. Select “**SELECT**”.
- ④②. Touch the [] key to view the paired mobile phones list.
- ④③. Slide along [] slider or touch []/[] key to choose one of the 5 mobile phones.
- ④④. Touch the [**ENT**] key to connect. Connected device will be able to use all the functionalities provided.





Notes:

- Make sure Bluetooth setting on the mobile phone is turned on during connection request.
- “” indicator will appear if *Bluetooth*® device is connected.
- “” and “” indicator will only appear if supported by the mobile phone.

● DELETE

This is a setting for user to delete one of the paired devices from the list.

In TEL OPTION:

- ④①. Select “**DELETE**”.
- ④②. Touch the [] key to view the paired mobile phones list.
- ④③. Slide along [] slider or touch []/[] key to choose one of the 5 mobile phones.
- ④④. Touch the [**ENT**] key, “**DELETED?**” is displayed.
- ④⑤. Touch the [**ENT**] key for 2 seconds to delete the paired device.

In BT  OPTION:

- ③①. Select “**DELETE**”.
- ③②. Touch the [] key, “**DELETED?**” is displayed.
- ③③. Touch the [**ENT**] key for 2 seconds to delete the paired device.

Note:

- After a device has been deleted, paired device will not automatically rearrange in the list.

● DISCONNECT

This option is used to disconnect the currently connected device.

- ③①. Select “**DISCONNECT**”.
- ③②. Touch the [] key, “**DISCONNECT?**” is displayed.
- ③③. Touch the [**ENT**] key for 2 seconds to disconnect the connected device.

● ADD PHONEBOOK

This option is used to add contacts from the mobile phone. User can choose 2 methods of phonebook download: send contacts via phone and retrieve contacts via this unit.

● Send Contacts Via Phone:

Use mobile phones to send selected contacts:

- ③①. Select **"ADD PHONEBOOK"**.
- ③②. Touch the [>] key, slide along [[^]SCRL / _v] slider or touch [^]/[v] key to select **"VIA PHONE"**.
- ③③. Touch [ENT] key to enter standby mode, **"STAND BY"** is blinking.
- ③④. During standby mode, use the last connected mobile phone to send contacts to the unit.

● Retrieve Contacts Via This Unit:

Transfer all contacts from mobile phone to unit:

- ③①. Select **"ADD PHONEBOOK"**.
- ③②. Touch the [>] key, slide along [[^]SCRL / _v] slider or touch [^]/[v] key to select **"DOWNLOAD ALL"**.
- ③③. Touch [ENT] key to request mobile phone transfers all contacts to unit.
- ③④. **"RECEIVING"** is blinking.

Notes:

- When the **"COMPLETED"** appears, add phone book is succeed.
- Total contacts that can be stored depend on the selected Book Type.

● DELETE PHONEBOOK

This is a setting for user to delete one or the entire phone numbers.

- ③①. Select **"DEL PHONEBOOK"**.
- ③②. Touch the [>] key, the current connected phone is displayed.
- ③③. Touch the [ENT] key to enter selection mode.
- ③④. Slide along [[^]SCRL / _v] slider or touch [^]/[v] key to select **"ALL DELETE"** or **"1 DELETE"** and touch [ENT] key.
- ③⑤. When you select **"ALL DELETE"**, touch the [ENT] key to proceed.
- ③⑥. When you select **"1 DELETE"**, slide along [[^]SCRL / _v] slider or touch [^]/[v] key to select one of the desired phone number and touch [ENT] key.
- ③⑦. Touch the [ENT] key for 2 seconds to delete.

● DELETE HISTORY

This option used to delete the call history.

- ③①. Select **"DEL HISTORY"**.
- ③②. Touch the [>] key, **"DELETE?"** is displayed.
- ③③. Touch the [ENT] key for 2 seconds to delete.

● BOOK TYPE

The unit provides 3 types of phone book which are stored in memory.

* The factory default setting is **"TYPE 3"**.

- ③①. Select **"BOOK TYPE"**.
- ③②. Touch the [>] key to enter detail setting stage.
- ③③. Slide along [[^]SCRL / _v] slider or touch [^]/[v] key to select the setting in sequence **"TYPE1"**, **"TYPE 2"** or **"TYPE 3"**.
- ③④. **"ALL MEMORY IS DELETED"** is displayed.
- ③⑤. Touch [ENT] key for 2 seconds to change setting.

PHONE \ TYPE	1	2	3
MEMORY 1	250 pieces	200 pieces	100 pieces
MEMORY 2	250 pieces	100 pieces	100 pieces
MEMORY 3	0 piece	100 pieces	100 pieces
MEMORY 4	0 piece	50 pieces	100 pieces
MEMORY 5	0 piece	50 pieces	100 pieces

Note:

- Once setting is changed, all previous stored phone-book data will be cleared.

Bluetooth® Operations

● MIC GAIN

MIC gain can be set by each paired mobile phone device. Each registered device has unique MIC gain setting.

- ③① Select "**MIC GAIN**".
- ③② Touch the [>] key to enter detail setting stage.
- ③③ Slide along [] slider or touch [^]/[v] key to change the MIC gain setting.

* The factory default setting is 3.
(Adjustment level: 1 to 5)

● RING VOL

This option is used to change the ringing volume by each paired mobile phone device.

The unit can be performed only when the "**TONE SEL**" model is set to "**INTERNAL**".

* The factory default setting is 5.
(Adjustment level: 1 to 10)

- ③① Select "**RING VOL**".
- ③② Touch the [>] key to enter detail setting stage.
- ③③ Slide along [] slider or touch [^]/[v] key to change the ringing volume.

● TONE SELECT

This option is used to select tone.

* The factory default setting is "**INTERNAL**".

- ③① Select "**TONE SELECT**".
- ③② Touch the [>] key to enter detail setting stage.
- ③③ Slide along [] slider or touch [^]/[v] key to select "**INTERNAL**" or "**AUTO**".

● INTERNAL

Only built-in ringing tone of this unit will be used.

● AUTO

Either in-band ringing tone or built-in tone will be used depends on the phone.

● NOISE CANCEL

This option is used to set noise volume in this unit.

* The factory default setting is "**LOW**".

- ③① Select "**NOISE CANCEL**".
- ③② Touch the [>] key to enter detail setting stage.
- ③③ Slide along [] slider or touch [^]/[v] key to select "**LOW**" or "**HIGH**".

● AUTO ANSWER

This is a setting to determine whether any incoming call will be automatically or manually answered.

* The factory default setting is "**OFF**".

- ③① Select "**AUTO ANSWER**".
- ③② Touch the [>] key to enter detail setting stage.
- ③③ Slide along [] slider or touch [^]/[v] key to select "**ON**" or "**OFF**".

● ON

Any incoming call is automatically answered in 5 seconds.

● OFF

User needs to manually answer the call.

● AUTO CONNECT

This function allows this unit to be connected automatically with previously connected device upon powering up this unit.

* The factory default setting is "**ON**".

- ③① Select "**AUTO CONNECT**".
- ③② Touch the [>] key to enter detail setting stage.
- ③③ Slide along [] slider or touch [^]/[v] key to select "**ON**" or "**OFF**".

● ON

Automatic connection is enabled.

● OFF

Automatic connection is disabled.

Bluetooth® Operations

● PASS KEY

User can set new 4 digits of pass key that range from 0 to 9 for pairing authentication security. This new pass key will be used for subsequent pairing mode with other *Bluetooth*® device.

* The factory default setting is "1234".

- ③-①. Select "**PASS KEY**".
- ③-②. Touch the [>] key to enter detail setting stage.
- ③-③. Slide along [<] or [>] key to move the cursor.
- ③-④. Slide along [[^]SCRL / _v] slider or touch [^]/[v] key to select the desired digit.
- ③-⑤. Touch [ENT] key for 2 seconds to store in memory.
- ③-⑥. "**MEMORY**" is displayed.

Note:

- Both *Bluetooth*® device and this unit must have the same pass key in order for pairing to be successful.

● ADDRESS

This will hold the unique *Bluetooth*® address. The address is 12 figures.

- ③-①. Select "**ADDRESS**".
- ③-②. Touch the [>] key, the *Bluetooth*® address appears in the display.

● BT NAME

This will hold the unit's name for pairing purpose.

- ③-①. Select "**BT NAME**".
- ③-②. Touch the [>] key, the unit's name appears in the display.

● VERSION

This will display the software version of the *Bluetooth*®.

- ③-①. Select "**VERSION**".
- ③-②. Touch the [>] key, the *Bluetooth*® version appears in the display.

Common Operations

Security code

This unit can deter theft by checking registered security code if security code is registered. The security code is registered in the Adjustment mode "**CODE**" item.

For first time installation, no security code is required.

If security code is registered, changing or disconnecting the vehicle battery will cause the security code input to be requested for activation. "**INPUT 0000**" will be displayed and "0000" is blinking.



1. Slide along [[^]SCRL / _v] slider or touch [^]/[v] key to choose 1~6 to input the security code.
 - * After input first digit, "0000" will stop blinking.
2. Touch [>] key to go on with the next digit.



3. Touch [>] key to confirm during finish input the 4 security code.







4. Successful password input will power ON the unit.

⚠ CAUTION

If entered code is wrong, "----" will be displayed for a given period during which no operation can be performed. After the locking period, "INPUT 0000" will be displayed again. For mistakes less than 7 times, the locking time will be 15 seconds; from 7th time onwards, the locking time will be 15 minutes.

Common Operations



Adjustment Mode

1. Touch the [] key to switch to ADJ menu.
2. Select "SETTING" in the menu to enter setting mode.
3. Each time you slide along the [] or touch []/[] key, the setting mode changed as following order:

"CLOCK EDIT" ↔ "DISP BRIGHT" ↔
 "BEEP" ↔ "CODE" ↔ "SCREEN SAVER"
 ↔ "AUTO SCROLL" ↔
 "SCROLL SPEED" ↔ "DIMMER" ↔
 "BLINKING LED" ↔ "AMP CANCEL" ↔
 ↔ "SYSTEM CHECK"

* If no operation is performed for more than 10 seconds, ADJ mode is cancelled and the display returns to the previous mode.



● Setting the clock

- ③① Select "CLOCK EDIT".
- ③② Touch [>] key to enter detail setting stage.
- ③③ Slide along the [] or touch []/[] key to adjust the value.
- ③④ Touch [>] key to switch to minute adjustment or touch [<] key to switch to hour adjustment.
- ③⑤ During finish adjustment, touch [ENT] key for 2 seconds to memory the new setting value.

● Setting the display brightness

You can adjust the display brightness to match the angle of installation of the unit.

* The factory default setting is "5".
 (Adjustment level: 1 to 8)



- ③① Select "DISP BRIGHT".
- ③② Touch [>] key to enter detail setting stage.
- ③③ Slide along [] slider or touch []/[] key to adjust the value.

Notes:

- If both the dimmer and the car's illumination are turned on, "ILLUMI ON" and the adjustment value will be displayed. If the dimmer is turned on and the car's illumination is turned off, "ILLUMI OFF" and the adjustment value will be displayed.
- If the dimmer is turned off, only the adjustment value will be displayed.
- The display brightness level setting during dimmer and car's illumination are turned on has independent adjustment value.

● Setting the beep

* The factory default setting is "ON".



- ③① Select "BEEP".
- ③② Touch [>] key to enter detail setting stage.
- ③③ Slide along [] slider or touch []/[] key to select "ON" or "OFF".

● Setting the code

- ③① Select "CODE".
- ③② Touch [>] key to enter detail setting stage.



When no code is registered

- ③③ Slide along [] slider or touch []/[] key to adjust the value.
- ③④ Touch [<]/[>] key to set the previous or next digit.



- ③⑤. During finish adjustment, touch [ENT] key for 2 seconds to memory the new setting value.



- ③⑥. "MEMORY XXXX" will be displayed for 2 seconds where "XXXX" is the entered digits.



Note:

- White down your personal code in case you forget it.

When code is registered

- ③③. Slide along [$\begin{matrix} \wedge \\ \text{SCRL} \\ \vee \end{matrix}$] slider or touch [\wedge]/[\vee] key to input the registered code.
- ③④. Touch [<]/[>] key to set the previous or next digit.



- ③⑤. During finish adjustment, touch [ENT] key for 2 seconds to confirm.



- ③⑥. If successfully delete the registered code, "DELETED" will be displayed for 2 seconds and back to 1st item.



- ③⑦. If unsuccessfully delete the registered code, "FAILED" will be displayed for 2 seconds and back to the "INPUT 0000" display.



● **Turning the screen saver function on or off**

This unit is provided with the screen saver function which allows you to show various kinds of patterns in the operation status indication area of the display in a random order. You can turn on or off this function. If the button operation is performed with the screen saver function on, the operation display corresponding to the button operation is shown for about 30 seconds and the display returns to the screen saver display.

* The factory default setting is "ON".

- ③①. Select "SCREEN SAVER".
- ③②. Touch [>] key to enter detail setting stage.
- ③③. Slide along [$\begin{matrix} \wedge \\ \text{SCRL} \\ \vee \end{matrix}$] slider or touch [\wedge]/[\vee] key to select "ON" or "OFF".

Common Operations

● Setting the method for title scroll

Set how to scroll in MP3/WMA/AAC title.

* The factory default setting is "ON".

- ③① Select "**AUTO SCROLL**".
- ③② Touch [>] key to enter detail setting stage.
- ③③ Slide along [] slider or touch [^]/[v] key to select "ON" or "OFF".
 - **ON**
To scroll automatically.
 - **OFF**
To scroll just 1 time.

● Setting the scroll speed

This function allows you to adjust the speed of the title scroll.

* The factory default setting is "3".

- ③① Select "**SCROLL SPEED**".
- ③② Touch [>] key to enter detail setting stage.
- ③③ Slide along [] slider or touch [^]/[v] key to adjust the speed value. (Parameter range: 1~5)

● Setting the dimmer control

You can set the dimmer control "ON" or "OFF".

* The factory default setting is "ON".

- ③① Select "**DIMMER**".
- ③② Touch [>] key to enter detail setting stage.
- ③③ Slide along [] slider or touch [^]/[v] key to select "ON" or "OFF".

● Anti-theft indicator

The red Anti-theft indicator is a function for preventing theft.

* The factory default setting is "OFF".

- ③① Select "**BLINKING LED**".
- ③② Touch [>] key to enter detail setting stage.
- ③③ Slide along [] slider or touch [<]/[>] key to select "ON" or "OFF".

● Setting the external amplifier

When an external amplifier is used, the noise can be decreased by turning off the power supply of the internal amplifier.

* The factory default setting is "OFF".

- ③① Select "**AMP CANCEL**".
- ③② Touch [>] key to enter detail setting stage.
- ③③ Slide along [] slider or touch [^]/[v] key to select "ON" or "OFF".
 - **ON**
Use with connected AMP.
 - **OFF**
Use for inside AMP.

● Performing a system check

This function allows you to perform a system check from the adjust mode when required.

- ③① Select "**SYSTEM CHECK**".
- ③② Touch [ENT] key. "SYSTEM CHECK" appears in the display.
- ③③ After finish checking, this unit will switch to previous mode.



AUX function

This system has an external input jack on the rear panel so you can listen to sounds and music from external devices connected to this unit.

● Selecting AUX IN sensitivity

Make the following settings to select the sensitivity when sounds from external devices connected to this unit are difficult to hear even after adjusting the volume.

* The factory default setting is "MID".

1. During AUX mode, touch the [] key to switch to ADJ menu.
2. Select OPTION in the menu to enter AUX OPTION mode.
3. Select "**AUX SENSE**" and touch [>] key to enter detail setting stage.
4. Slide along [] slider or touch [^]/[v] key to select "HIGH", "MID" or "LOW".

Note:

- When AUX mode is selected, AUX IN sensitivity can be set.

7. TROUBLESHOOTING

	Problem	Cause	Measure
General	Power does not turn on. (No sound is produced)	Fuse is blown.	Replace with a fuse of the same amperage. If the fuse blows again, consult your nearest service dealers.
		Incorrect wiring.	Consult your nearest service dealers.
	No sound output when operating the unit with amplifiers or power antenna attached.	Power antenna lead is shorted to ground or excessive current is required for remote-on the amplifiers or power antenna.	<ol style="list-style-type: none"> 1. Turn the unit off. 2. Remove all wires attached to the power antenna lead. Check each wire for a possible short to ground using an ohm meter. 3. Turn the unit back on. 4. Reconnect each amplifier remote wire to the power antenna lead one by one. If the amplifiers turn off before all wires are attached, use an external relay to provide remote-on voltage (excessive current required).
No sound heard.	The speaker protection circuit is operating.	<ol style="list-style-type: none"> 1. Turn down sound volume. Function can also be restored by turning the power off and on again. (Speaker volume is reduced automatically when the speaker protection circuit operates). 2. If the sound is muted again, consult our service department. 	

	Problem	Cause	Measure
USB/iPod	No sound heard.	The device contains no MP3/WMA/AAC files.	Record MP3/WMA/AAC files properly to the device.
		The files are not proper MP3/WMA/AAC format.	Use only properly encoded MP3/WMA/AAC files.
		Connectors are loose.	Disconnect the device and reconnect securely.
	Sound is interrupted or has noise.	The MP3/WMA/AAC files are improperly encoded.	Use only properly encoded MP3/WMA/AAC files.
	The device isn't recognized.	The device is damaged.	Disconnect the device and reconnect. If the device is still not recognized, try replacing with a different device.
		Connectors are loose.	
Can't insert the device.	According to the state of operation on the device, the communication fault is caused.	Disconnect the device and reconnect securely.	
	The device has been inserted improperly.	Try reversing the connection direction of the device (usually the brand name surface should be facing left).	
	The connector is broken.	Replace with a new device.	

TROUBLESHOOTING

	Problem	Cause	Measure
BT Audio	Audio streaming is disconnected after telephone interrupt.	This is probably happen when audio streaming and telephone function are from the same device (mobile phone). Dependent on phones.	Reconnect A2DP/AVRCP (Audio streaming profiles) from the phone again after telephone interrupt.
	Cannot perform remote control for audio streaming.	AVRCP is not connected.	Disconnect and pair the device again.
	Audio streaming will begin to pulse on/off when using your connected phone.	Due to excessive <i>Bluetooth</i> [®] activity on a low bandwidth link. Some phones will not handle this well.	If your phone is facing this problem, please do not use your phone while audio streaming.
	Display is showing “ BT AUDIO ” but there is no sound output.	The external audio device may in Pause status. Some <i>Bluetooth</i> [®] audio devices might not support AVRCP.	Check whether both device and main unit are in play status. Change the status in the device if necessary. If problem persists, please power off and on the main unit or the device.
There might be connection links broken between the devices.		Please delete pairing information on both device and main unit and start re-pairing.	

* Advanced Audio Distribution Profile (A2DP) is used for *Bluetooth*[®] audio streaming support.

* Audio Video Remote Control Profile (AVRCP) is used for controlling audio streaming playback.

TROUBLESHOOTING

	Problem	Cause	Measure
Telephone	After pairing, car stereo is not able to receive and make calls.	<p><i>Bluetooth</i>® connection is not established yet.</p> <p>Normally it will take several seconds to establish the connection after pairing.</p> <p>Some phones will not automatic connect after pairing.</p>	<p>Use your phone to manually connect or enter Telephone mode. (Car stereo will try to reconnect).</p> <p>Power off and on the car stereo and perform pairing again. Always make sure pairing information on both device and main unit have been deleted before starting a new pairing activity.</p> <p>If the problem persists, please visit www.clarion.com for your phone compatibility.</p>
		Car stereo is connected to other device.	Disconnect the previous device and reconnect current device.
	Unable to reconnect to car stereo using phone.	The device pairing information may have been deleted from the unit.	Perform the above measure.
	There is no sound output when incoming call is answered.	Incoming call was answered too quickly before you hear the ringing tone. This can cause the audio not properly transferred to the main unit by some phones.	<p>Please use your phone to transfer the audio back to the phone for the current ongoing call.</p> <p>Kindly answer the call only when you hear a ringing tone next time.</p> <p>If the problem persists, please reconnect the phone or create new pairing before the next incoming call.</p>
	There is no sound output during conversation.	<i>Bluetooth</i> ® communication link is lost.	<p>Please disconnect the phone and reconnect.</p> <p>If the problem persists, please create new pairing for both phone and main unit.</p>
Cannot operate the handsfree function properly.	No response from mobile phone.	Turn off and on the mobile phone.	

8. ERROR DISPLAYS

	Error Display	Cause	Measure
USB/iPod	ERROR 2	The files are not proper MP3/WMA/AAC format.	Use only properly encoded MP3/WMA/AAC files.
	ERROR 3 (USB mode)	The MP3/WMA/AAC files are improperly encoded.	Use only properly encoded MP3/WMA/AAC files.
	ERROR 3 (iPod mode)	The iPod contains no audio files.	Insert an iPod containing audio files.
	CUR ERR	Over current detection.	Disconnect the devices and reconnect. If the devices are still not recognized, try replacing with a different devices.
	HUB ERR	Do not support the HUB devices.	Do not use the HUB devices.

	Error Display	Cause	Measure
BLUETOOTH®	FAILED	No <i>Bluetooth</i> ® device is found within range.	Please turn on the <i>Bluetooth</i> ® device and place the device within range of reception.
		The device pairing information might have been lost.	Please manually pair and reconnect the device.
		Device or unit is not in pairing mode or wrong pass key is entered.	Please make sure both the unit and device is in pairing mode and enter the correct pass key.
	CALL FAILURE	Call is not made successfully.	Please try a few times or dial from phone if necessary.
— — — — —	A2DP device is not connected.	Please manually pair and connect the A2DP device.	

* If an error display other than the ones described above appears, press the reset button. If the problem persists, turn off the power and consult your nearest service dealers.

9. SPECIFICATIONS

FM tuner

Frequency Range: 87.9 MHz to 107.9 MHz
 Usable Sensitivity: 11 dBf
 50 dB Quieting Sensitivity: 17 dBf
 Alternate Channel Selectivity: 60 dB
 Stereo Separation (1 kHz): 30 dB
 Frequency Response (± 3 dB): 30 Hz to 15 kHz

AM tuner

Frequency Range: AM 530 kHz to 1710 kHz
 Usable Sensitivity: $28\mu V$

USB

USB 1.1 and 2.0 compatible with a maximum transfer rates of up to 12Mbps. (Full speed)

MP3	
Decode Format	MPEG 1, 2 and 2.5 - Layer 3
Sampling rate (kHz)	MPEG-1: 32, 44.1, 48 MPEG-2: 16, 22.05, 24 MPEG-2.5: 8, 11.025, 12
Bit-rate (kbps)	MPEG-1: 32 - 320 MPEG-2: 8 - 160 MPEG-2.5: 8 - 160 VBR
WMA	
Sampling rate (kHz)	32, 44.1, 48
Bit-rate (kbps)	32, 36, 40, 44, 48, 64, 128, 160, 192 (WMA V2/V7/V8) 64, 80, 96, 128, 160kbps (WMA V9L1)
AAC	
Sampling rate (kHz)	8, 11.025, 12, 16, 22.05, 24, 32, 44.1, 48 (kHz)
Bit-rate (kbps)	8-320 kbps

Folder Level Limit: 8 Level
 Folder Support: 512
 File Support: 255 per folder
 Total File Support: 130560
 Folder Name: Maximum 64 single bytes alphabetical letters
 File Name: Maximum 64 single bytes alphabetical letters

Bluetooth® wireless technology

Compliance: Bluetooth® 2.0
 Frequency Range: 2.40~2.4835 GHz, ISM band
 RF Power: Class 2 (2.5mW)
 Profiles: HFP, A2DP, AVRCP, OPP, PBAP
 Operating Temperature: -20°C ~ 60°C
 Telephone Operation:
 Noise reduction, Echo cancellation, Full duplex telephone
 Mic Input (External): 2.2k ohm, 2V electret

Audio

Maximum Power Output: 200 W (50 W X 4 ch)
 Bass Control Action (100 Hz): ± 14 dB
 Middle Control Action (1 kHz): ± 14 dB
 Treble Control Action (10 kHz): ± 14 dB
 Line Output (with A/C 1 kHz, 10 k Ω): 4.0 V

General

Power Supply Voltage:
 14.4 V DC (10.8 V to 15.6 V allowable), negative ground
 Current Consumption: Less than 15 A
 Speaker Impedance: 4 Ω (4 Ω to 8 Ω allowable)
 Weight: 1.91 lb. (0.867 kg)
 Dimensions:
 178 mm Width X 50 mm Height X 154.2 mm Depth

SPECIFICATIONS

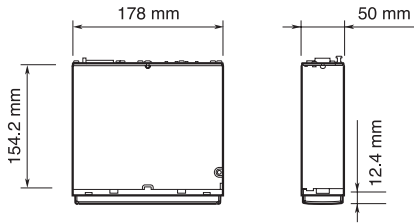

Notes:

- Specifications comply with JEITA Standards.
- Specifications and design are subject to change without notice for further improvement.
- Please make sure when connecting external power amplifier, that you properly, to the car chassis, ground the amplifier.
- If this is not done, severe damage to the source unit may happen.



Power Output:

18 W RMS x 4 Channels at 4 Ω and 1% THD+N

Signal to Noise Ratio:

87 dBA (reference: 1 W into 4 Ω)