

CLS-45i

Dual Speaker Amplified Cordless Phone
with Call-Waiting Caller ID



Operating Instructions

**Ameriphone products are manufactured by
Clarity, a Division of Plantronics, Inc.**

4289 Bonny Oaks Drive

Chattanooga, TN 37406

PHONE: (800) 426-3738

FAX: (800) 325-8871

email: ameriphones@plantronics.com

www.clarityproducts.com

Important Safety Instructions

When using your telephone equipment, basic safety precautions should always be followed to reduce the risk of fire, electric shock and injury to persons including the following:

1. Read and understand all instructions.
2. Follow all warnings and instructions marked on the telephone.
3. Do not use this telephone near a bathtub, wash basin, kitchen sink or laundry tub, in a wet basement, near a swimming pool or anywhere else where there is water.
4. Avoid using a telephone (other than a cordless type) during a storm. There may be a remote risk of electrical shock from lightning.
5. Do not use the telephone to report a gas leak in the vicinity of the leak.
6. Unplug this telephone from the wall outlets before cleaning. Do not use liquid cleaners or aerosol cleaners on the telephone. Use a damp cloth for cleaning.
7. Place this telephone on a stable surface. Serious damage and/or injury may result if the telephone falls.
8. Do not cover the slots and openings on this telephone. It should never be placed near or over a radiator or heat register. This telephone should not be placed in a built-in installation unless proper ventilation is provided.
9. Operate this telephone using the electrical voltage as stated on the base unit or the owner's manual. If you are not sure of the voltage in your home, consult your dealer or local power company.
10. Do not place anything on the power cord. Install the telephone where no one will step or trip on the cord.
11. Do not overload wall outlets or extension cords as this can increase the risk of fire or electrical shock.
12. Never push any objects through the slots in the telephone. They can touch dangerous voltage points or short out parts that could result in a risk of fire or electrical shock. Never spill liquid of any kind on the telephone.
13. To reduce the risk of electrical shock, do not take this phone apart. Opening or removing covers may expose you to dangerous voltages or other risks. Incorrect reassembly can cause electric shock when the appliance is subsequently used.
14. Unplug this product from the wall outlets and refer servicing to the manufacturer under the following conditions:
 - A. When the power supply cord or plug is frayed or damaged.
 - B. If liquid has been spilled into the product.
 - C. If the telephone has been exposed to rain or water.
 - D. If the telephone does not operate normally by following the operating instructions. Adjust only those controls that are covered by the

operating instructions. Improper adjustment may require extensive work by a qualified technician to restore the telephone to normal operation.

- E. If the telephone has been dropped or the case has been damaged.
 - F. If the telephone exhibits a distinct change in performance.
15. Never install telephone wiring during a lightning storm.
 16. Never install telephone jacks in wet locations unless the jack is specifically designed for wet locations.
 17. Never touch un-insulated telephone wires or terminals unless the telephone line has been disconnected at the network interface.
 18. Use caution when installing or modifying telephone lines.
 19. Use only the power cord and batteries indicated in this manual. Do not dispose of batteries in a fire. They may explode. Check with local codes for possible special disposal instructions.

Save These Instructions

ADDITIONAL SAFETY NOTES FOR CANADIAN USERS

The following items are included as part of the CS-03 Requirements. The standard connecting arrangement for the equipment is CA11A. This product meets the applicable Industry Canada technical specifications.

NOTICE: The Canadian Department of Communications label identifies certified equipment. This certification means that the equipment meets certain telecommunications network protective operational and safety requirements. The Department does not guarantee that the equipment will operate to the user's satisfaction.

Before installing this equipment, users should ensure that it is permissible to be connected to the facilities of the local telecommunications company. The equipment must also be installed using an acceptable method of connection. In some cases, the company's inside wiring associated with a single line individual service may be extended by means of a certified connector assembly (telephone extension cord).

The customer should be aware that compliance with the above conditions may not prevent degradation of service in some situations. Repairs to certified equip-

Safety

Instructions

(continued)

ment should be made by an authorized Canadian maintenance facility designated by the supplier. Any repairs or alterations made by the user to this equipment, or equipment malfunctions, may give the telecommunications company cause to request the user disconnect the equipment.

Users should ensure for their own protection that the electrical ground connections of the power utility, telephone lines and internal metallic water pipe system, if present, are connected together. This precaution may be particularly important in rural areas.

CAUTION: Users should not attempt to make such connections themselves, but should contact the appropriate electric inspection authority, or electrician, as appropriate.

The Ringer Equivalent Number is an indication of the maximum number of terminals allowed to be connected to a telephone interface. The termination on an interface may consist of any combination of devices subject only to the requirement that the sum of the Ringer Equivalent Number of all the devices not exceed five.

Save These Instructions

Safety Instructions For Batteries

Risk of explosion if battery is replaced by an incorrect type.

Dispose of used battery according to the instructions.

Use only the following type and size battery pack:

Cordless Telephone Battery Pack 3.6V, 750mAh 2/3 AA NiMH (Nickel Metal Hydride) Battery Pack GP75AAH3BMJZ GPI International Ltd.

Do not dispose of the battery pack in a fire. It may explode. Check with local codes for possible special disposal instructions.

Do not open or mutilate the battery pack. Released electrolyte is corrosive and may cause damage to the eyes or skin. It may be toxic if swallowed.

Exercise care in handling the battery pack to prevent shorting the battery with conductive materials such as rings, bracelets and keys. The battery pack or conductor may overheat and cause burns.

Charge the battery pack provided with or identified for use with this product only in accordance with the instructions and limitations specified in this manual.

Observe proper polarity orientation between the battery pack and battery charger.

Contents

Important Safety	
Instructions _____	ii
Additional Safety Notes for Canadian Users	iii
Safety Instructions for Batteries . .	iv
For Your Information _____	2
Warranty Service	2
Sales Receipt	2
Help from Ameriphone	2
About Your New CLS45i _____	3
Features _____	4
Installation and Using Your CLS45i _____	11
Installing, Replacing and Charging the Handset Battery Pack	11
Connecting Your Telephone	12
Wall Mounting	13
Setting Up Caller ID	14
Placing Calls	17
Receiving Calls	18
Handset Amplifier	18
Intercom	19
Caller ID Functions _____	19
Reviewing Caller ID Information .	19
Placing a Call from Caller ID Information	19
Deleting Selected Caller ID Information	20
Deleting All Caller ID Information	21
Saving Caller ID Information To Memory	20
Receiving Call Waiting Caller ID .	21
Speed Dial and Memory Functions _____	22
Storing Numbers in Memory	22
Memory Dialing - Base	23
Reviewing Memory Information on the Handset	23
Deleting a Stored Number	24
Other Calling Features _____	24
Transferring Calls from the Handset to the Base	24
Transferring Calls from the Base to the Handset	24
Three-Way Conference Calls	24
Troubleshooting _____	25
Regulatory Compliance _____	26
Important FCC Information for Customers	26
Warranty Procedure _____	30
Specifications _____	31

For Your Information

Thank you for selecting the CLS45i Dual-speaker Amplified Cordless Telephone from Ameriphone. These operating instructions and quick-reference guide provide the information you need for safe, efficient use of the CLS45i. Read this document thoroughly before using your telephone and keep it nearby for easy reference.

Warranty Service

Your telephone is designed to provide years of quality service. However, if there is a malfunction and the Troubleshooting recommendations on page 25 do not resolve the problem, follow the Warranty procedure on page 35.

Sales Receipt

Save your sales receipt as proof of purchase date should you need warranty service.

Help from Ameriphone

For help with using your CLS45i, call our Customer Service Department at 800-426-3738.

Package Checklist

Please make sure that your package includes the items shown in the following illustration.

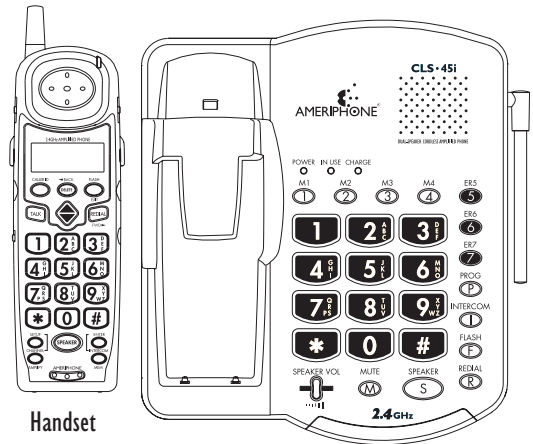

Handset

Base Unit



A/C Adapter

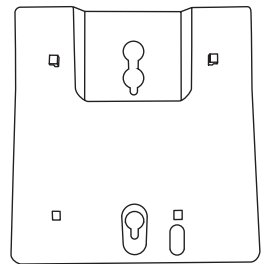

Phone Mounting Bracket

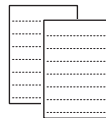

Phone Directory Cards



Telephone Line Cords

Battery Pack
(Located in handset battery compartment.
Plug in before using!)

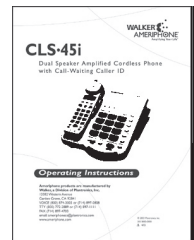

Operating Instructions

Package Components

About your new CLS45i

The CLS45i is the flagship of the Ameriphone® product line. It has been custom-engineered with an unprecedented array of features to provide years of convenience and assistance. It is powered by the latest technology yet thoughtfully designed for ease-of-use, especially for people who have trouble hearing on the telephone.

The CLS45i is a Dual-Speaker Amplified Cordless Telephone with 2.4GHz technology for greatly increased power and extended operating range.

It is, literally, two-phones-in-one ... two speaker-phones. There are *speakers in both the handset and the base*. This means that when the handset is either in or out of the base you can use the base as a standard speakerphone. There are dialing keypads and stored number memories in both the handset and the base. And, you can also use the handset independently as another speakerphone in another location in your home. You can also use it as an intercom between rooms.

The CLS45i has a powerful 40dB amplifier with separate volume and tone controls so that you can tailor the incoming sounds to the loudness and frequency that best suits your hearing. Plus, its bright, red ring flashers and super-loud ringers in both the base and handset make sure you know when your phone is ringing.

Your new phone is designed to achieve the maximum possible range by transmitting and receiving according to the highest specifications set forth by the FCC. We have rated this phone to operate at a maximum distance with the qualification that the range depends upon the environment in which the telephone is used. While using the telephone you may experience interference from other electronic devices. If you use the handset near a microwave oven which is being used, noise may be heard from the receiver or the speaker. Move away from the microwave oven and closer to the base unit. During a call, as you begin to move your handset

too far from your base unit, noise increases. If you pass the range limits of the base unit, your call will be terminated.

The CLS45i has both Caller ID and Call Waiting Caller ID capabilities. You will need to subscribe to the telephone company's Caller ID service to use these features. The LCD screen on the handset lets you view Caller ID information easily. It also guides you through the few simple steps to set up the other Special Features of the CLS45i.

On the base you'll find seven (7) one-touch speed dial memory buttons, including three red buttons specifically designated for emergency numbers. You can store other numbers in these memory locations if you wish, but emergency numbers will always be easiest to access if you store them in the red memory locations (ER5, ER6 and ER7).

Note: The CLS45i employs sophisticated circuitry to minimize acoustic feedback (squealing) while it is placed against your ear. However, you may experience some feedback while returning the handset to the base. To alleviate this either turn the phone off or turn the amplifier off before returning the handset to the base.

The handset can store frequently called numbers in ten (10) two-touch buttons.

The CLS45i has many other features and functions and they are explained in the following pages.

We hope you enjoy using your new CLS45i and that you are pleased with the added capability and independence it makes possible for you.

We sincerely thank you for your support of Ameriphone products. If we can be of help to you, please call our Customer Service department at 800-426-3738. We would also appreciate your feedback.

Features – Handset

The CLS45i has an extensive array of features. Included among them are:

- Amplification up to 40dB
- Hands-free Communication
- Caller ID (if subscribed)
- Intercom
- Memory Dialing
- Speakers for Three-way conference calling and call waiting (if subscribed)
- Portability within a given area

For added convenience and ease of use, there is a tactile nub on the #5 dialing key and tactile symbols on the memory and function keys on the base.

Since most of the features are available on both the handset and the base, let's first look at the handset features.

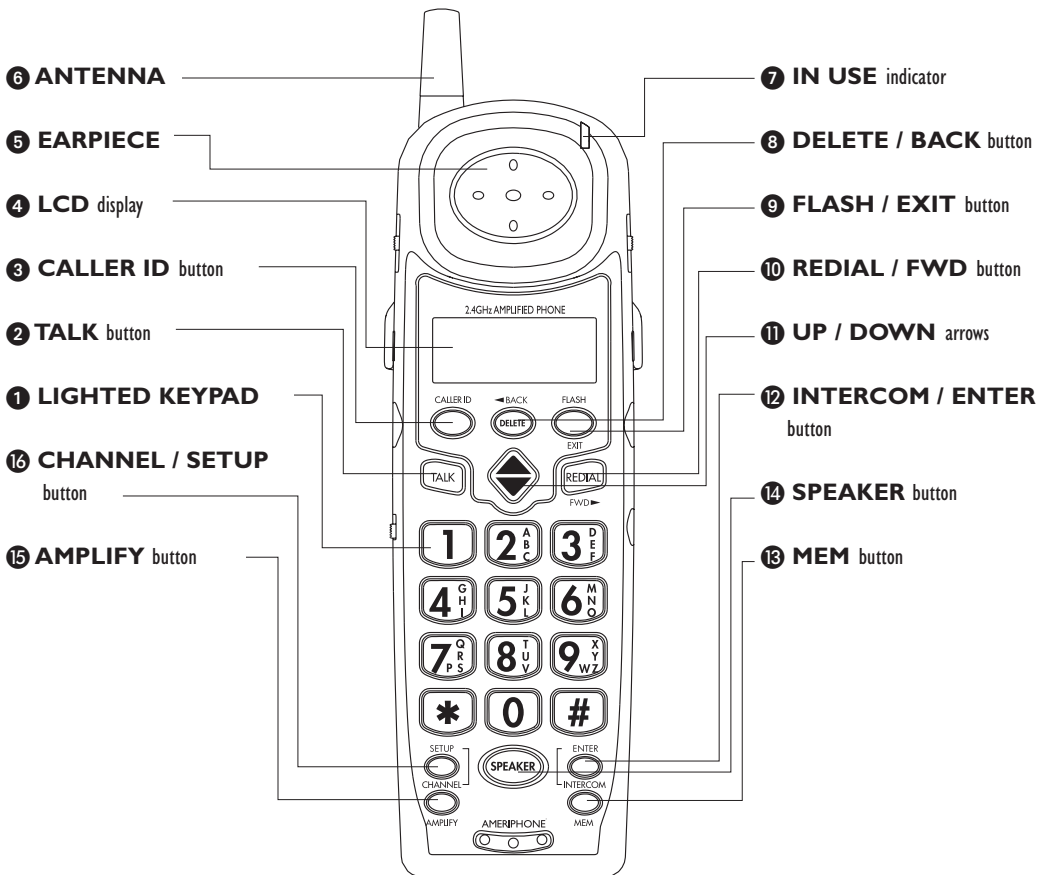

Handset Face

Features – Handset

The following controls and indicators are on the face of the handset.

- 1 **Keypad.** The keypad on the handset is backlit while in use.
 - 2 **TALK button.** Press to turn the handset ON and OFF. It can be used to answer, place or end a call.
 - 3 **CALLER ID button.** Press to dial the Caller ID position selected by the up/down button.
 - 4 **LCD Display.** Displays Caller ID and telephone status information. It stores up to 50 telephone numbers and has three language selections.
 - 5 **Earpiece.**
 - 6 **Antenna.**
 - 7 **IN USE / NEW CALL indicator.**

Lights up when the telephone is in use. It also flashes when there are new calls that have not been reviewed.
 - 8 **DELETE / BACK button.** This button is used:
 - a. to delete Caller ID entries
 - b. to backspace and delete characters when entering a new name and number into memory
 - 9 **FLASH / EXIT button.** Press to:
 - a. access telephone company subscription services, such as Call Waiting (if available)
 - b. exit any menu and return to the Standby screen
 - 10 **REDIAL / FWD button.** This button is used:
 - a. **To redial last number dialed:** Press to redial the last number that you dialed up to a maximum of 32 digits. It must be the first button pressed the next time you activate the handset, either by picking it up from the cradle or, if out of the cradle, by pressing TALK.
 - b. **To insert pauses into numbers:**

When storing numbers into memory, press REDIAL to insert pauses when necessary, such as when entering a sequence of numbers (calling card or credit card number). You may also be asked to provide information for identification or validation purposes when making telephone transactions, such as with a bank or other merchant. In these cases you would be prompted at each successive step to provide data such as the last 4-digits of your social security number, date of birth, phone number, zip code, etc. A pause is also used when programming a number that is followed by an extension or a menu selection.
 - c. **To advance the cursor to the next character location:** In storing names into memory, (such as “BEN”), once you have selected “B” on the “2” key, press REDIAL to move the cursor to the right where you will enter the “e” on the “3” key. Continue pressing REDIAL to advance the cursor until all the letters of the name have been selected. Press PROG to store the number.
- 11 **UP / DOWN arrows.** Press to scroll through the Caller ID and SETUP display.
 - 12 **INTERCOM / ENTER button.** Press to:
 - a. activate the Intercom function
 - b. store or confirm any selection during SETUP or when entering names/numbers into memory
 - 13 **MEM button.** The MEM button is used when storing and accessing frequently dialed and emergency telephone numbers

Features – Handset

into memory locations.

- 14 **SPEAKER button.** Pressing this button turns the handset speaker On and Off. It can also be used to answer incoming calls. For best results, after turning this function On and the handset is out of the cradle, place the handset face down or on its side so that the speaker grille is not blocked.
- 15 **AMPLIFY button.** This button turns the extra amplification On and Off. Press it to put the handset amplifier into the On mode for maximum volume boost. In the On position, the button is backlit and the maximum amplification is 40dB. When it is Off, the backlight goes out and the maximum amplification is approximately 18dB.
- 16 **CHANNEL / SETUP button.**
 - a. This button is used for switching channels when there is interference on the line. There are 40 channels. If there is interference on the line, pressing this button will move to another channel which should bring much improved clarity of reception.
 - b. Pressing CHANNEL for three (3) seconds will initiate the SETUP mode. You will see this indicated on the LCD display.

Handset Controls, Functions and Features

There are controls on either side of the handset and they are listed below.

Left Side:

- 1 **RINGER OFF/ON.** This switch turns the handset ringer On and Off.
- 2 **REMOTE jack.** This 3.5 mm jack is for

use with optional remote devices such as an Ameriphone ER Pillow Switch or Air Switch.

- 3 **VOL slide switch.** When AMPLIFY on the handset is Off, this volume control provides amplification from 0 to 18dB. When AMPLIFY is On, the volume control allows you to adjust the amplification up to 40dB.

Right Side:

- 4 **TONE LO HI.** Adjusts the tone to help you better understand incoming voice on the handset. The TONE control provides clarity, especially with similar sounding words. It is only functional when AMPLIFY is on.
- 5 **AUDIO jack.** 3.5mm jack used for connecting other assistive listening devices such as neckloop, cochlear implant or Personal Computer speaker.

Handset Left Side

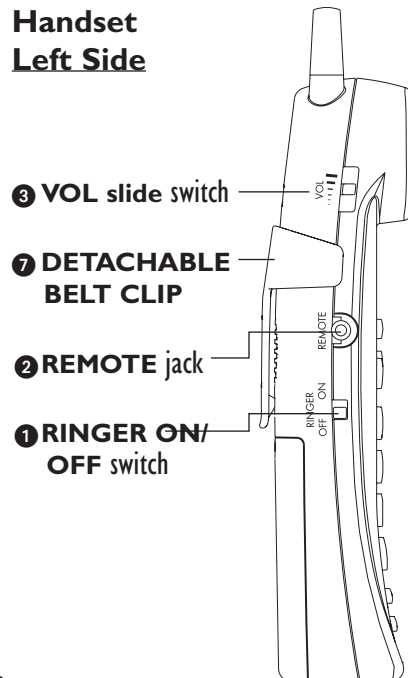

Features – Handset

6 HEADSET jack. 2.5mm jack to allow the use of a headset. Your handset, when connected to a headset (not included) will provide you with hands-free communication. In the event you wish to purchase a headset for your CLS45i, please contact Plantronics at 1-800-544-4660 for a location near you. We recommend the use of Plantronics models M-130 and M-175. Headsets are also available at most retail outlets and Special Needs distributors that sell telephone equipment.

Other Handset Features:

7 BELT CLIP. Your CLS45i has a detachable belt clip on the back of the handset.

8 RING FLASHER. This red light, located on the top right back corner of the handset, flashes when your telephone is ringing.

9 NEW CALL / IN USE indicator. Located at the top right-front corner of the earpiece, it flashes to let you know you have a new call or to indicate that the handset is in use.

Caller ID Display Indicator

When you receive a telephone call, the LCD display provides a number of Caller ID details, which are explained below.

- **New Call/Call counter** This line displays the number of calls and new calls in standby mode. If you have a call that has not yet been reviewed, the display reads “New” and the New Call / In Use light on the handset flashes.
- **Repeated Call Indicator** This indicator lights up and displays “RPT” if the displayed telephone number has called more than once.
- **Clock** Shows the real time (AM/PM) format, or the time stamp of a Caller ID record.
- **Date** Displays the date (mm/dd) format, or the date stamp of a Caller ID record.
- **12-Digit number line** Displays the caller’s number or digits you dialed.

Handset Right Side

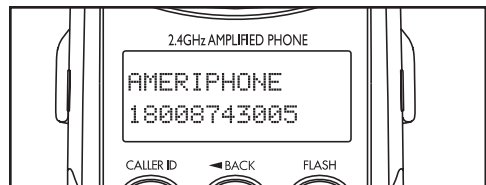
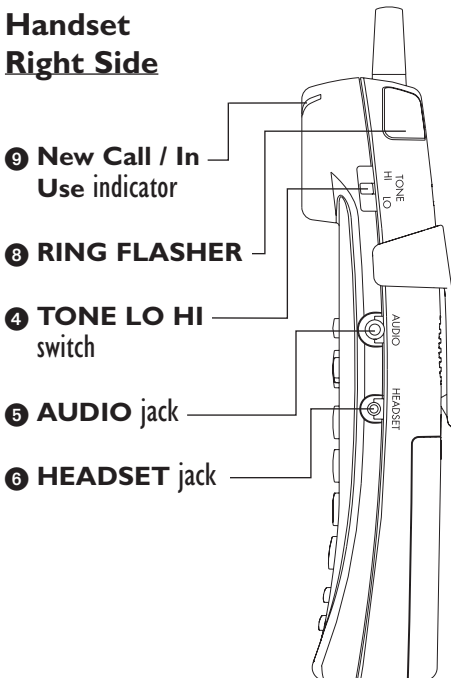

Features – Base

Base Faceplate

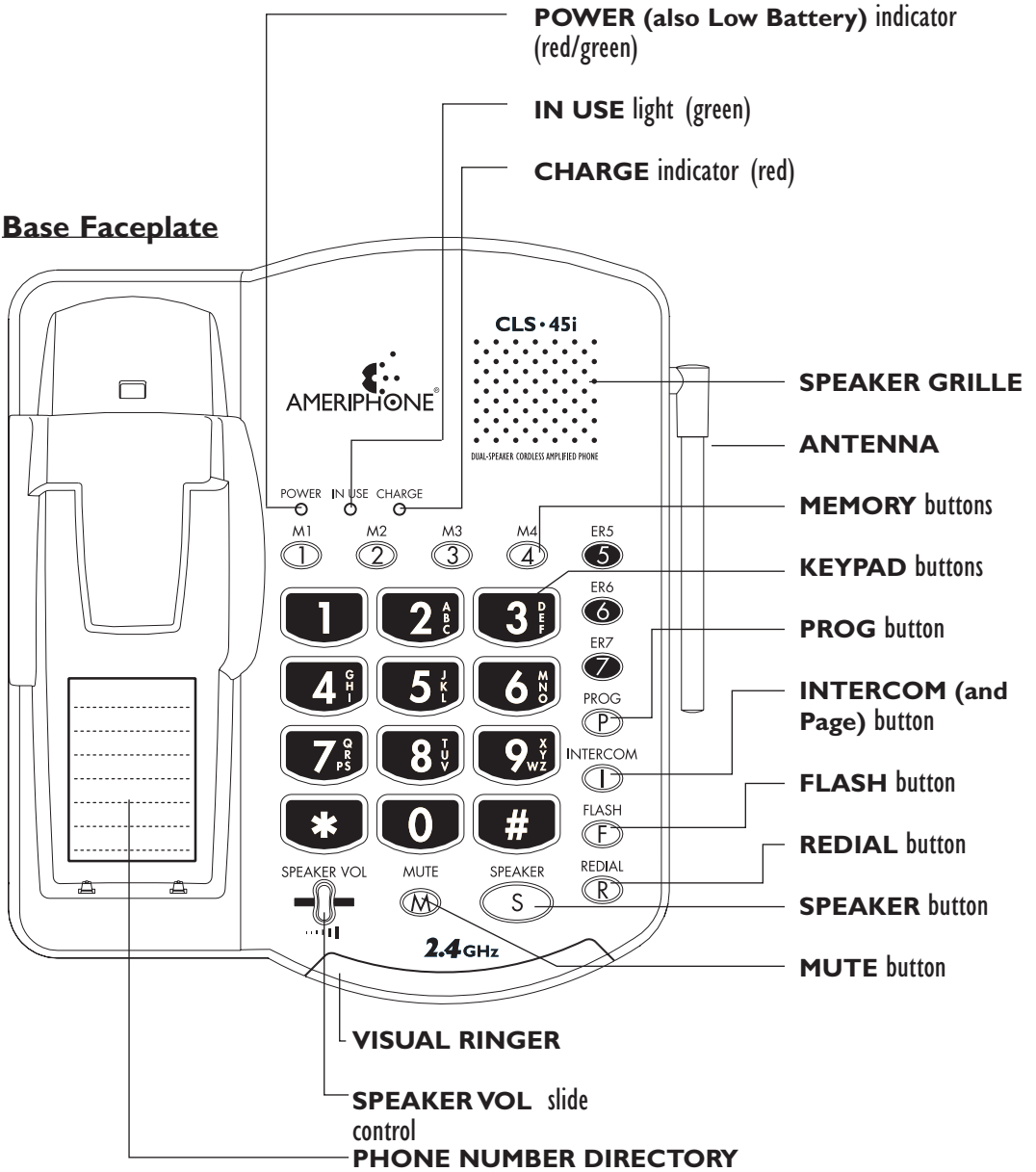

Features – Base

Features and controls on the faceplate (top) of the base.

POWER (also Low Battery) indicator.

This light is the left most of three lights above the keypad. It signals you to alert you to the status of the backup batteries and the AC power. See chart on page 12.

IN USE light. This green light is ON when the telephone line is in use. When transferring a call, this light changes from a steady light to a flashing light.

CHARGE indicator. This red light is ON when the handset is in the cradle.

KEYPAD buttons. The buttons on the keypad are backlit. They light up when you press SPEAKER.

MEMORY buttons. M1 through M4 and ER5 through ER7. M1 through M4 are for frequently-called numbers and ER5 through ER7 are for emergency numbers. Each stores a telephone number of up to 16 digits in length. These are one-touch buttons. See pages 21-22.

PROG button. Press when storing frequently called and emergency telephone numbers into memory. See page 22.

INTERCOM (and Page) button. Press to page the handset, transfer a call or for conversation between the base and handset. It can also be used to connect a three-way call between the handset, base and a third party on another telephone line.

FLASH button. Press to access special services from the telephone company such as Call Waiting and other subscribed services.

REDIAL (and Pause) button. Press to redial the last number you called. Pause lets you insert an extension or menu choice

when storing numbers. It lets you program numbers up to 32 digits. See additional description on page 5.

SPEAKER button. Backlit button lights up when Speaker is turned On. Press it and it provides hands-free communication with adjustable volume.

Note: In Speaker mode, only one party at a time can be heard. It is best that you wait until the other party is finished speaking before you speak. Otherwise parts of the conversation may be lost.

MUTE button. Press to turn the microphone on the base ON and OFF. It is for added privacy.

SPEAKER VOL slide control. Use this to adjust the volume of the speaker on the base.

ANTENNA. Keep the antenna raised for the maximum reception strength and to minimize interference on the line.

VISUAL RINGER. This flashes a bright red light when the telephone is ringing.

PHONE NUMBER DIRECTORY.

Included is a self-adhesive plastic sleeve and several directory listing cards on which you can note the phone numbers you have stored in memory buttons and other numbers if you choose. Simply peel the backing off the sleeve and affix it to the base in the lower area of the handset cradle as shown. You may remove the directory cards as often as you wish to make changes by sliding them out of the sleeve and then sliding them back. NOTE: writing the numbers in pencil will make changes easier to make and will extend the life of the directory cards. Extra cards are included.

Features – Base

Controls on the right side.

AMPLIFIER OFF ON. This switch determines the initial state of the amplification on the handset. It always returns the handset to whichever position the switch is set. When Off, the handset starts calls in non-amplified mode. When On, the handset starts calls in amplified mode. The Amplify button on the handset toggles between the amplification levels, regardless of the position of the switch. **CAUTION: when this switch is set to ON the volume will be louder than normal when the handset is turned on. To protect persons with normal hearing we suggest setting the switch to OFF. This will keep the volume at a normal level until the AMPLIFY button is pressed.**

T P (Tone/Pulse). Slide the switch to the type of telephone service you have; “T” (touch tone) or “P” (pulse) for rotary dialing.

RING TONE. Slide to set ringer tone to “L” (low) or “H” (high).

RINGER. Slide to set ringer loudness to “OFF”, “L” (low), “M” (medium) or “H” (high).

EXT SPK OUT (Audio) jack. This 3.5 mm jack is compatible with Personal Computer speakers and assistive listening devices such as a neckloop and cochlear implant. See page 7 (handset).

Back side of the base.

AC ADAPTER jack. This jack is for the AC adapter that provides electric power to your phone. See page 31 “Product Specifications.”

TELEPHONE LINE jack. Next to the DC adapter, this jack allows connection to the telephone line.

Base, right and back sides

T P (Tone/Pulse) switch

RINGER VOLUME switch

AMPLIFIER ON OFF switch

RING TONE switch

EXT SPK OUT (Audio) jack

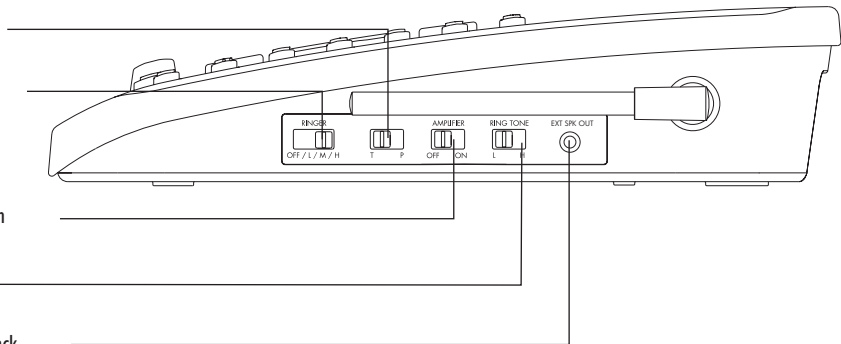

TELEPHONE LINE jack

AC ADAPTER jack

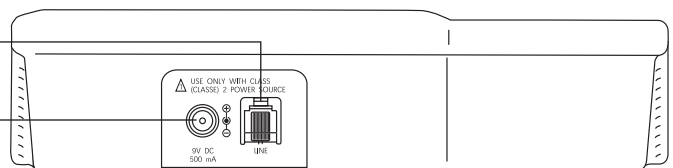

Installing and Using Your CLS45i

There are six (6) steps involved in setting up your CLS45i.

1. Install included battery pack into handset.
2. (Optional) Insert four AA alkaline batteries (for backup in case of AC power outage) into base.
3. Decide if you want the telephone to sit on a desk/tabletop or hang on the wall (if on the wall, follow Instructions for Wall Mounting)
4. Plug the telephone line cord into the phone base and telephone wall jack
5. Plug the electrical adapter into a 110-120V AC wall outlet
6. Place handset in the cradle face up and let charge overnight or for 10-14 hours
Once your telephone is set up and the handset is charged, you may proceed to program up to 17 phone numbers into the memory speed-dial buttons and set up the rest of the Special Features.

Installing, Replacing and Charging the Handset Battery Pack

Note: the battery pack must be fully charged before using the CLS-45i

Remove the battery cover on the back of the handset by pushing the battery compartment “button” and sliding the cover towards the bottom of the handset.

1. To install the battery pack, plug the cord of the battery pack into the terminal in the battery compartment. Replace the battery cover by sliding it into place until it “clicks”.
2. To replace the battery pack, remove the

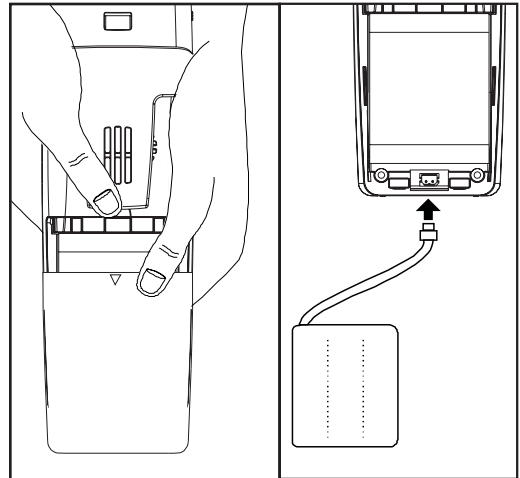

battery cover as stated above and unplug the battery from the battery compartment. Remove old battery pack. Install new battery pack and plug the cord of the battery pack into the terminal in the battery compartment.

Replace the battery cover by sliding it into place until it “clicks”.

Monitoring the Handset Battery Level

The battery icon will show “full” if there is an adequate charge level on the battery. As the phone is used the battery will discharge. When the handset battery is low the display will show the battery icon in an “empty” state, the unit will “beep” every thirty (30) seconds, and the IN USE/NEW CALL light will flash. If you are using the phone, the phone will go dead after approximately two (2) minutes. Place the handset back into the base to recharge the battery.

Installing and Using Your CLS45i

To maximize the battery charge, place the handset back into the cradle when not in use and each night.

When out of the cradle, the battery typically holds a charge for several days, depending upon use.

Maximizing Handset Battery Life

To maximize the battery life, fully discharge the battery and recharge it occasionally.

Simply unplug your telephone line cord from the wall telephone jack.

Press TALK and allow the handset to remain on for 10 to 14 hours.

Then, reconnect the phone cord to the wall telephone jack.

Return the handset to the base and allow it to fully charge for 12 hours.

Doing this process monthly reduces the memory buildup that occurs from frequent, partial charging.

Monitoring the Level of the Backup Batteries in the Base

Chart I

AC Power	No Battery installed	Good Battery	Low Battery	LED Color
yes		yes		green steady
yes	yes			red steady
yes			yes	blinks green/red
no		yes		blinks red
no			yes	blinks red, goes off

Chart I indicates how to read the lights and indicators on the base to determine the status of the batteries and AC power.

Connecting Your Telephone

Set the dial mode switch to T (tone) if you have touch tone service. Set the switch to P (pulse) if you have rotary dialing.

You may connect your telephone for desktop use or mounted on a wall.

- Raise the antenna on the base.
- Plug the other end of the telephone cord into the telephone wall jack.
- Plug the AC adapter into a standard 120V AC wall outlet.

Note: Use only with the #950 AC adapter supplied by Ameriphone.

CAUTION: Place the telephone and power cords where they will not interfere with movement, be damaged or create a fire or other electrical hazard.

Installing and Using Your CLS45i

Desktop Use

To use as a desk phone, remove the wall mounting bracket:

1. Remove the handset and turn the phone over so that the bottom is facing you.
2. Push the bracket in and down firmly until you feel it snap out of its mounting slots **1**.
3. Place the base on any desired and suitable location. The small rubber pads on the bottom of the phone will help keep the phone in place.

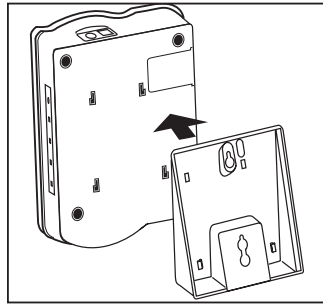

1

Wall Mounting

The wall mounting bracket is already installed on your CLS45i for your convenience. To attach your phone to the wall:

1. Locate a desired wall phone jack near an AC outlet. Notice the position of the two (upper and lower) protruding nail or screw heads as shown in illustration **2**. These heads fit into the slots on the bottom of the mounting bracket and hold the phone on to the wall. Plug the short phone line cord into the wall jack as shown.
2. Hold the base unit of the phone upright then angle it downwards. Feel for the lower protruding nail or screw head and insert this head into the lower hole on the mounting bracket as shown in **3**.
3. Next, insert the upper phone bracket onto the upper head. Slide the phone down until it is firmly in place on the wall. See **4**.
4. Once the phone is firmly in place on the wall, attach the short line cord to the phone, plug the AC adapter into the phone, and attach the phone's handset as shown in **5**.

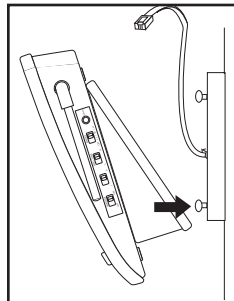

3

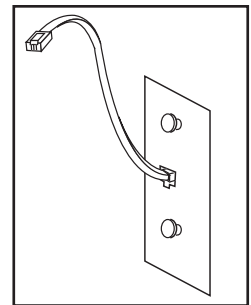

2

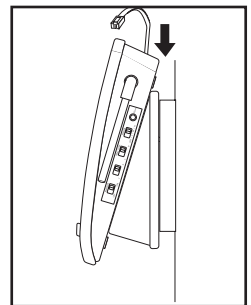

4

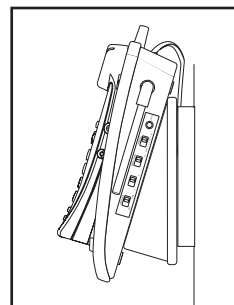

5

Setting Up Caller ID

The Caller ID SETUP procedure begins only after the handset is fully charged.

Enter SETUP Mode

NOTE: In SETUP, if there is no input within 30 seconds, the program will default to the last selection in that mode (e.g., Language) and the CLS45i will return to Standby. If at any time you want to exit SETUP and return to Standby, press FLASH.

Press and hold CHANNEL for three seconds.

Setting Language on the Handset

1. Press and hold CHANNEL for three (3) seconds to enter the SETUP mode. The Caller ID display now reads, "SET LANGUAGE."
2. Press INTERCOM once to enter the Language selection mode. The current selected language flashes.
3. Press UP (▲) or DOWN (▼) to scroll through the language options. The displayed language will change to "FRENCH" or "SPANISH."
4. Press INTERCOM to select your preference.
5. Press UP (▲) or DOWN (▼) to go to the next menu.

Setting Contrast on the Handset

1. Press and hold CHANNEL for three (3) seconds to enter the SETUP mode.
2. Press UP (▲) or DOWN (▼) to go to the next menu. The display shows the last selection.
3. Press INTERCOM once to enter the Contrast Level selection mode. The current selected level flashes.

4. Press UP (▲) or DOWN (▼) to change the level.
5. Press INTERCOM to select your preference.
6. Press UP (▲) or DOWN (▼) to go to the next menu.

Setting Time and Date

The time-and-date stamp is automatically updated when the first incoming Caller ID is received.

The time will start from the default Time/Date "12:00 AM 01/01".

If the time setting is lost during a power outage, the clock flashes when power is up again.

1. Press and hold CHANNEL for three (3) seconds to enter the SETUP mode.
2. Press UP (▲) until the display reads, "TIME/DATE".
3. Press INTERCOM to start changing the date. The display shows the current time and date on the top line, e.g. "12:05AM 12/20" with the month digits flashing.
4. Press UP (▲) or DOWN (▼) to change the month digits.
5. Press INTERCOM once to select. After the month digits are set, the date digits flash.
6. Press UP (▲) or DOWN (▼) to change the date digits.
8. Press INTERCOM once to select. After the date digits are set, the hour digits flash.
9. Press UP (▲) or DOWN (▼) to change the hour digits.
10. Press INTERCOM once to select. After the hour digits are set, the minute digits flash.
11. Press UP (▲) or DOWN (▼) to change the minute digits.
10. Press INTERCOM once to select. After the

Installing and Using Your CLS45i

minute digits are set, AM/PM will flash.

11. Press UP (▲) or DOWN (▼) to for either AM or PM.
12. Press INTERCOM once to select. After AM or PM is selected, the time/date digits will be blanked.
13. Press INTERCOM once to display the time/date again. Or, press UP (▲) or DOWN (▼) to go to the next menu.

Setting Caller ID On / Off

1. Press and hold CHANNEL for three (3) seconds to enter the SETUP mode.
2. Press UP (▲) or DOWN (▼) until the LCD display reads "CID MODE ON". When it is off, the display reads "CID MODE OFF".
3. Press UP (▲) to set the CID ON/OFF (default to ON).
4. Press INTERCOM once to enter the CID selection mode.
5. Press the UP (▲) or DOWN (▼) button to change the mode.
6. Press INTERCOM to confirm.
7. Press the UP (▲) or DOWN (▼) button to go to the next menu.

Setting Auto-Talk On / Off

When this feature is activated, an incoming call is automatically answered by picking up the handset from the cradle while the telephone is ringing.

NOTE: With Auto-Talk On, do not press TALK to answer, as doing so will disconnect (hang up on) the caller; and the call is automatically terminated when you place the handset back into the cradle. You may also disconnect by pressing TALK.

NOTE: With Auto-Talk Off, picking up the handset from the cradle does not answer the call. You will need to press TALK or SPEAKER to answer the call.

1. Press and hold CHANNEL for three (3) seconds to enter the SETUP mode.
2. Press UP (▲) until the LCD display reads "Auto-Talk ON/OFF" (default is On). If Auto-Talk is Off, the display reads "AUTOTALK OFF".
3. Press INTERCOM to enter the Auto-Talk selection mode. The current mode characters will then flash (ON/OFF).
4. Press UP (▲) or DOWN (▼) to change the mode.
5. Press INTERCOM to select.
6. Press UP (▲) or DOWN (▼) to go to the next menu.

Setting the Area Code

1. Press and hold CHANNEL for three (3) seconds to enter the SETUP mode.
2. While in SETUP press UP (▲) button until the LCD display reads "AREA CODE ?" and "::*:*" or last selected value "XYZ".
3. Press INTERCOM to enter the Area Code selection mode. The digits change with the first digit of the right set of digits ("XYZ -> XYZ") flashing.
4. Enter your area code using the numeric keys on the handset.

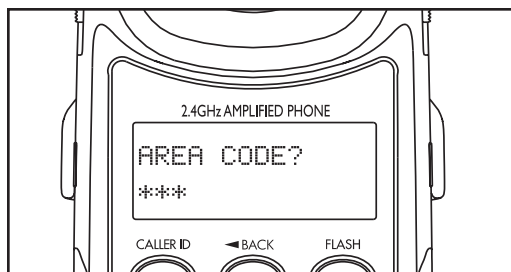

Installing and Using Your CLS45i

Press INTERCOM to confirm. When the area code is confirmed, the entered digits move to the far left and change from flashing to steady On.

Press UP (▲) or DOWN (▼) to go to the next menu.

To set up your CLS45i again, press CHANNEL and hold it down for three seconds in the Standby mode. You will again enter the SETUP mode.

Your CLS45i stays in the SETUP mode until (a) you complete the SETUP steps, or (b) you press FLASH/EXIT, or (c) you let 30 seconds elapse without pressing any keys. However, Caller ID information will still be recorded and can be reviewed once SETUP is complete.

Placing Calls

You can place calls from either the handset or the base. NOTE: Remember, you must charge the handset battery for 10-14 hours before using the handset for the first time.

PLACING CALLS FROM THE HANDSET

1. Press TALK or SPEAKER to talk and listen through the handset. The In Use indicator lights up; or,
2. Press the SPEAKER to use the handset as a speakerphone (you can talk and listen through the speaker on the back of the handset)
3. The SPEAKER button lights up
4. The In Use indicator lights up
5. Listen for the dial tone.
6. Dial the telephone number
7. When you have finished the call, press SPEAKER or TALK to hang up. The In Use indicator light goes out.

PLACING CALLS FROM THE BASE WITH THE HANDSET EITHER IN OR OUT OF THE CRADLE (USING THE BASE AS A SPEAKERPHONE)

1. Press SPEAKER
2. The SPEAKER button lights up
3. Listen for the dial tone
4. Dial the telephone number
5. When you have finished the call, press SPEAKER.
6. The SPEAKER light goes out

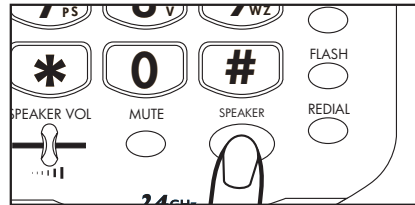

“Temporary” Tone Dialing Mode

If you have set your phone to the Pulse dialing mode and wish to place a call in the Tone dialing mode, you can do that without changing your settings. Simply press “*” once to enter Tone temporarily. Any numeric key pressed after “*” will be dialed in Tone mode. You can also REDIAL in Tone.

Tone mode will be active until you hang up at which point the phone will automatically reset to the Pulse dialing mode.

Receiving Calls

When a call comes in, you can answer from either the handset or the base.

ANSWERING FROM THE HANDSET WHEN IT IS IN ITS CRADLE

You must pick up the handset to answer.

Installing and Using Your CLS45i

When the telephone rings, the visual ringers will flash on both the base and handset. Note that when the handset is in the cradle, only the base will ring.

1. Lift the handset to begin your conversation.
 - a. If Auto-Talk is On, do not press the TALK key.
 - b. If Auto-Talk is Off, you will need to press the TALK key.
2. To end your conversation, press TALK or place the handset back in the cradle. When returning the handset to the cradle, it should be facing up so that you can see the Caller ID and because it charges automatically when it is in the cradle facing up.

ANSWERING FROM THE HANDSET WHEN IT IS OUT OF ITS CRADLE

Sometimes you may temporarily leave the handset in another room and you can answer from the handset wherever it is. Note: The handset's RINGER switch must be in the ON position for the ringer to operate.

1. When the phone rings, press the TALK or SPEAKER button to answer.
2. When you are through talking, press the TALK or SPEAKER button again to hang up.

ANSWERING CALLS FROM THE BASE WITH THE HANDSET EITHER IN OR OUT OF THE CRADLE (USING THE BASE SPEAKERPHONE)

1. Press SPEAKER
2. The SPEAKER button lights up
3. Listen and talk through the speaker from up to 20 feet away
4. Adjust the volume of the speaker by moving the sliding SPEAKER VOL control left or right.

5. When you have finished the call, press SPEAKER.
6. The SPEAKER light goes out

Handset Amplifier

The CLS45i has a powerful amplifier that can provide up to 40dB of incoming amplification depending upon your settings.

When AMPLIFY is Off on the handset, the handset VOL control allows for amplification up to 18dB.

When the handset AMPLIFY button is On, the handset volume control allows for amplification to adjust from up to 40dB. A backlight under the button turns on when the Amplify button is activated.

To adjust the volume:

1. Press the AMPLIFY button. It lights up.
2. Slide the VOL control (on the top left side of the handset) to select the level of amplification that best suits your hearing needs.

CAUTION: Repeated incremental exposure to amplification levels greater than 18dB may be harmful to individuals who do not have hearing disabilities. Do not remove the warning label. If it is likely that a visually impaired person will use the telephone, securely attach the provided warning printed in Braille to the back of the handset.

Installing and Using Your CLS45i

Handset Tone Control

To adjust the frequency of the incoming sounds to the level that gives you the greatest clarity, simply slide the TONE Control switch to LO or HI.

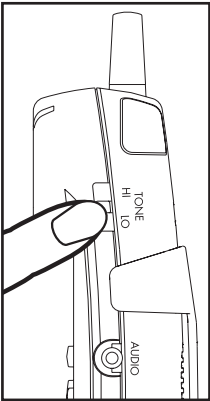

Intercom

The CLS45i can be used like an intercom if you want to speak to or page someone in another room. It can also be used for a three-

way call between the handset, base and a third party on another telephone line.

Paging and Talking to the Handset from the Base

Press INTERCOM on the base and the handset beeps for 15 seconds. If you press and hold INTERCOM, it beeps for 60 seconds.

To stop the beep:

- from the base, press INTERCOM once
- from the handset, press INTERCOM once if you want to talk to the base.

Press INTERCOM twice if you want to end Paging.

Talking to the Base from the Handset

1. Press INTERCOM on the handset. The base is paged, beeps twice and goes directly into Intercom mode, talking with the handset immediately.
2. To exit Intercom mode, press INTERCOM on either the handset or the base.

Reviewing Caller ID Information

Each incoming call is stored using up to 12 characters for the name and up to 16 digits for the number.

If there is new call information, the New Call / In Use light flashes.

1. While in Standby mode, press the UP (▲) or DOWN (▼) button to display the number of new calls and the number of total calls.
2. Press UP (▲) or DOWN (▼) again to view the Caller ID content.
 - a. Press DOWN (▼) to scroll the Caller ID information from the most recent record. Or,
 - b. Press UP (▲) button to scroll through the Caller ID information from the oldest record.

If the caller's number is more than 12 digits, there are two keys you can use as right and left arrows.

1. Press the asterisk (*) to scroll left or
2. Press the pound sign (#) to scroll to the right and view the entire number.

While it scrolls over the list, “-END-” displays. If the CID list is empty, the display reads “NO CID.”

At any time you can press FLASH once to return to Standby mode. Or it will return to Standby automatically after 30 seconds of inactivity.

Placing a Call from Caller ID Information

When reviewing the Caller ID List, press CALLER ID to dial the number with the handset in handset mode. Pressing CALLER ID twice adds a “1” before the dialing digits.

When you place calls using Caller ID information, you have 4 dialing options:

1. For numbers with 7 digits without a “1” prefix:
 - if the area code of the Caller ID number matches the stored area code, press CALLER ID button once within 2 seconds. This action sends out 7 digits only.
2. For numbers with an Area Code + 7 digits but without a “1” prefix
 - If the area code of the Caller ID number matches the stored area code, press CALLER ID twice within 2 seconds. This action sends out Area Code + 7 digits only.
3. For numbers with 10 digits but without a “1” prefix
 - If the stored area code is different from the Caller ID, the memory should store all 10 digits. Press CALLER ID once within 2 seconds to send out 10 digits without a “1” prefix.
4. For numbers with 10 digits with a “1” prefix
 - If the stored area code is different from the Caller ID, the memory should store all 10 digits. Press CALLER ID button twice within 2 seconds to send out a “1” prefix and 10 digits.

Caller ID Functions

Deleting Selected Caller ID Information

1. While reviewing the Caller ID, press DELETE to delete the displayed caller information. The display flashes “ERASE ?”
2. Press INTERCOM to select. The display briefly reads “CID ERASED.” The next Caller ID entry appears automatically or the display reads, “- NO CALLS -” if the list is empty.

Deleting All Caller ID Information

1. While reviewing the Caller ID, hold down DELETE for two seconds. The display flashes “ERASE ALL ?”
2. Press INTERCOM to select. The display briefly reads “ALL CID” and “ERASED” and then “- NO CALLS -”.

At any time, you can press FLASH one time to return to standby mode. Or it will return to standby automatically when 30 seconds has elapsed without any keys being pressed.

Saving Caller ID Information to Memory

1. While reviewing Caller ID, press MEM button. The display reads “SAVE TO” and “MEMO?”
2. Press INTERCOM to select. Then the display reads “ENTER MEMO” and “LOCATION.”
3. Enter location number [X] (0 through 9).
 - a. If the memory location [X] is empty, the display reads “SAVE AT” and “MEMO X?”
 - b. If the memory location [X] is not empty, display flashes “OVERWRITE” and “MEMO X?”
4. Press INTERCOM to select. Both the phone number (up to 16 digits) and caller's name (12 characters) will be stored in that memory location. Or press FLASH to exit.

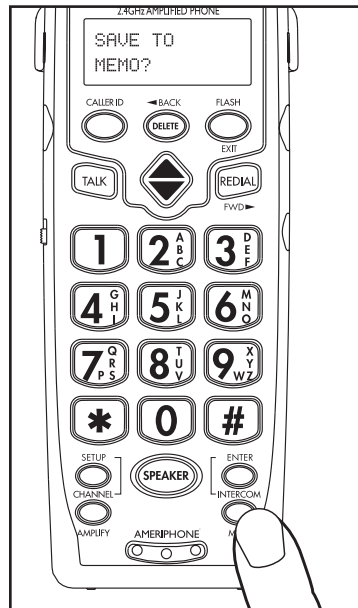

Caller ID Functions

Receiving Call Waiting / Caller ID Calls

When you are on an existing call, you will hear a beep. The display shows incoming call waiting caller ID information.

1. To answer the incoming Call Waiting call, press FLASH. The original call will be placed on Hold and you will be connected to the incoming caller. When you have finished speaking to the incoming caller, press FLASH again to return to your original call.



2. If you access the Call Waiting call, the Caller ID information will disappear and the Time/Day screen will appear.
3. If you do not access the call waiting call, the Caller ID information is transferred into the Caller log. This caller information is considered "old."

Unknown Call

If a call is from another country or caller's number is not available, "UNKNOWN NUMBER" is displayed. It will be stored in Caller ID log.

Blocked Call

If the number is blocked or withheld, "BLOCKED NUMBER" is displayed. It will be stored in Caller ID log.

Repeated Call

If this is a repeated call, it means you have received calls from this same number before and that they have not been reviewed.

Speed Dial and Memory Functions

Storing Numbers in Memory

The CLS45i stores 17 telephone numbers in memory:

- 10 on the handset and
- 7 on the base.

Note: When storing numbers in either the base or handset memory buttons, it's a good idea to make a record of where you stored them. There is no other means for checking to see in which key you have stored a number.

Storing Numbers in the Handset Memory Buttons

The unit must be in Standby mode.

The 0 through 9 number keys on your keypad can be used to store a telephone number in memory. Each stores one number.

Press MEM once and the display reads, "ENTER MEMO NUMBER."

Press the DOWN (▼) button until the display reads "- ." in the top right corner and the words "END OF RECORD" appear on the second and third lines of the display.

Press MEM once to add a number. If no buttons are pressed for 30 seconds, the handset returns to Standby mode.

Enter the number to be stored (up to 16 digits).

Press INTERCOM and the display reads, "ENTER NAME." Enter up to 12 characters, using the numeric pad. You will note that in addition to the numbers, there are also letters

on keys 2 through 9 (for example, the "2" has "A," "B," and "C").

To create the name you would:

- Press "2" once to select "A"
- Press "2" twice to select "B"
- Press "2" three times to select "C"
- Press "2" four times to select "2"; or
- Press DELETE to backspace and erase the digit or character by the last cursor position.

Press INTERCOM and the display reads "ENTER MEMO LOCATION".

Enter the memory location (0 through 9) and press INTERCOM to confirm.

If the location is empty (available), a long beep indicates you have successfully stored that entry and the display reads, "MEMO X" and "STORED".

If the location is not empty, the display reads "OVERWRITE" and "MEMO X? " This is asking you to decide whether or not you want to leave the already-stored number in that location or overwrite it with the new entry you have just created.

If you do want to overwrite the location with the new entry, press INTERCOM to confirm. The display reads "MEMO X" and "STORED". Press ENTER to overwrite the location with the new entry. Press EXIT to return to Standby mode.

This memory storing sequence exits at any wrong key sequence or if no key is pressed after 30 seconds.

Speed Dial and Memory Functions

Storing Numbers in the Base Memory Buttons

The memory buttons for the base are M1 through M4 and ER5 through ER7.

1. Press PROG.
2. Dial the number to be programmed (up to 16 digits).
3. Press PROG.
4. Press one of the memory buttons (M1 through M4, ER5 through ER7). A beep follows. The number is stored.

Adding Memory Numbers followed by an Extension or Menu Choices.

NOTE: If you want to save a number that is followed by an extension or menu choice, program as you would a regular number, with one exception: after you enter the main number, press the REDIAL button. Example: if you wanted to store the number 714 555 2232, but needed to reach extension 323, you would press the following keys:
714 555 2232 REDIAL 323.

Changing Stored Numbers on the Base

If you want to replace one of your stored numbers with another, simply program the new number on top of the old number. For example, if the number you want to replace is stored on M3 on the base, store the new number on the M3 button.

Memory Dialing on the Handset

There are two ways to do this.

Starting with the TALK or SPEAKER Button:

1. In standby mode, press TALK or SPEAKER to open the line.
2. Press MEM and the desired memory key location (0 through 9). The number is dialed automatically.

Starting with MEM Button (the unit must be in standby mode):

1. Press the MEM button once.
2. Press desired memory location key (0 through 9).
3. Press TALK or SPEAKER. The handset opens the line and automatically dials the number.

Memory Dialing on the Base

1. Press the memory key where the number is stored (M1, M2, M3, M4, ER5, ER6, ER7) and the number is dialed automatically.
2. To dial hands-free using the speaker, first press SPEAKER, listen for the dial tone, and then press the memory key.

Reviewing Memory Information on the Handset

Unit must be in stand-by mode.

1. Press MEM once. The display reads, "ENTER MEMO NUMBER".
2. Enter location number (0 - 9) or press UP-(▲) or DOWN (▼) to review the last to first location.
 - If the location is not blank, the display

Speed Dial and Memory Functions

shows location, name and telephone number.

- If the memory location is blank, the display shows location number in the top right corner and the words, "RECORD EMPTY?"
3. Press UP (▲) or DOWN (▼) to review the previous or next location.
 4. Press "DOWN (▼). At the end of the memory the display shows "- -" in the top right corner plus the words, "END OF RECORD."

Press FLASH once to return the handset to stand-by mode. Or, Press MEM again to add a memory entry. If no key is pressed for 30 seconds, the handset will return to Standby mode.

Deleting a Stored Number

The unit must be in standby mode.

1. Press MEM once. The display reads "ENTER MEMO NUMBER."
2. Enter location number (0 through 9) or press UP (▲) or DOWN (▼) to review the last or first location. The display shows location number in the top right corner plus the name and telephone number.
3. Press DELETE to erase memory. The display indicates this action.
4. Press INTERCOM to confirm. The display reads "MEMO X" and "ERASED" together with a success key tone. Use any other key to return to memory review menu.

Transferring Calls from the Handset to the Base

While talking on the handset with either the TALK or the SPEAKER button engaged,

1. Press INTERCOM on the handset to place the call on Hold and connect with the intercom on the base.
2. Press SPEAKER on the base for the base to pick up the call.

Note: You can retrieve the call again by pressing TALK or SPEAKER.

Transferring Calls from the Base to the Handset

The base must be in SPEAKERPHONE mode (SPEAKER button must be On.).

1. Press INTERCOM on the base. This places the call on Hold and the In-Use light changes from steady On to flashing. A series of rings occur on the handset and the display reads, "PAGING" and "LINE ON HOLD."
2. Press INTERCOM on the handset to talk to the base. The display reads, "INTERCOM" and "LINE ON HOLD."
3. Press INTERCOM on the handset again to bring the handset back into standard talk mode

Three-Way Conference Calls

JOINING A CALL IN PROGRESS ON THE HANDSET:

1. Press SPEAKER on the base unit. The handset display changes from "TALK" to "CONF"
2. To disconnect the base from the conference call, press the SPEAKER button on the base. Handset again reads "TALK."

Troubleshooting

JOINING A CALL IN PROGRESS ON THE BASE:

1. Press SPEAKER or TALK on the handset. The handset display changes from "LINE IN USE" TO "CONF."
2. To disconnect the handset from the conference call, press TALK or SPEAKER. The handset display again reads "LINE IN USE."

For your convenience, we have listed some common problems that may occur with cordless phones, followed by a list of items that should be checked.

Telephone does not work?

Check to ensure:

- Base is plugged into POWER SOURCE.
- Handset is CHARGED.
- TONE/PULSE switch is in the right position
- TELEPHONE LINE CORD is plugged into both the TELEPHONE and the TELEPHONE LINE JACK.

Range of telephone limited?

Check to ensure:

- ANTENNA on the base is raised
- Base is centrally located in your residence
- Base is not located near appliances

No dial tone?

Check to ensure:

- Telephone plug is connected to the TELEPHONE LINE
- Base is plugged into the POWER SOURCE

Received signal filters or fades?

Check to ensure:

- Battery pack in HANDSET is fully charged
- HANDSET is not too far from the BASE
- ANTENNA on BASE is raised

Interference on reception?

Check the following:

- Noise may be picked up from electrical products in the home or electrical storms. Generally, this noise is a minor annoyance and should not be interpreted as a defect in your system.
- Choose an alternate channel using CHANNEL on the handset.

Static?

Check to ensure:

- That the ANTENNA is not touching another metal object.
- Raise or reposition the ANTENNA on the base. If, after pressing TALK, you receive three beeps and no dial tone, check to ensure:
- Base is plugged into POWER SOURCE.

Regulatory Compliance

Important Information for Customers

Part 68 of FCC Rules Information

This CLS45i complies with Part 68 of the FCC rules and the requirements adopted by the ACTA. On the bottom of this equipment is a label that contains, among other information, a product identifier in the format US:AAAEQ##TXXXX. If requested, this number must be provided to the telephone company.

A plug and jack used to connect this CLS45i telephone to the premises wiring and telephone network must comply with the applicable FCC Part 68 rules and requirements adopted by the ACTA. A compliant telephone cord and modular plug, USOC RJ11C, is provided with this product. It is designed to be connected to a compatible modular jack that is also compliant. See installation instructions for details.

The Ringer Equivalence Number (REN) is used to determine the number of devices that may be connected to a telephone line. Excessive RENs on a telephone line may result in the devices not ringing in response to an incoming call. In most but not all areas, the sum of RENs should not exceed five (5.0). To be certain of the number of devices that may be connected to a line, as determined by the total RENs, contact the local telephone company. For products approved after July 23, 2001,

the REN for this product is part of the product identifier that has the format US:AAAEQ##TXXXX. The digits represented by ## are the REN without a decimal point (e.g., 03 is a REN of 0.3). For earlier products, the REN is separately shown on the label.

If this telephone equipment causes harm to the telephone network, the telephone company will notify you in advance that temporary discontinuance of service may be required. But if advance notice isn't practical, the telephone company will notify the customer as soon as possible. Also, you will be advised of your right to file a complaint with the FCC if you believe it is necessary.

The telephone company may make changes in its facilities, equipment, operations or procedures that could affect the operation of the equipment. If this happens the telephone company will provide advance notice in order for you to make necessary modifications to maintain uninterrupted service.

If trouble is experienced with this telephone equipment, for repair or warranty information, please contact Clarity, 800-426-3738. If the equipment is causing harm to the telephone network, the telephone company may request that you disconnect the equipment until the problem is resolved.

This telephone equipment is not intended to be repaired and it contains no repairable parts. Opening the equipment or any attempt to perform repairs will void the warranty. For service or repairs, call 1-800-426-3738.

Connection to party line service is subject to state tariffs. Contact the state public utility commission, public service commission or corporation commission for information.

If your home has specially wired alarm equipment connected to the telephone line, ensure the installation of this telephone equipment does not disable your alarm equipment. If you have questions about what will disable alarm equipment, consult your telephone company or a qualified installer.

This telephone equipment is hearing aid compatible.

We recommend the installation of an AC surge arrester in the AC outlet to which this equipment is connected. The telephone companies report that electrical surges, typically lighting transients, are very destructive to customer terminal equipment connected to AC power sources

Customer-Owned Coin/ Credit Card Phones

To comply with state tariffs, the telephone company must be given notification prior to connection. In some states, the state public utility commission, public service commission or corporation commission must give prior approval of connection.

Part 15 of FCC Rules Information

This device complies with part 15 of the FCC Rules. Operation is subject to the following two conditions:

1. This device may not cause harmful interference, and
2. this device must accept any interference received, including interference that may cause undesired operation.

Your telephone equipment has been tested and found to comply with the limits of a Class B digital device, pursuant to Part 15 of FCC rules. These limits are designed to provide reasonable protection against harmful interference in residential installation.

This equipment generates, uses, and can radiate radio frequency energy and, if not installed and used in accordance with the instructions, may cause harmful interference to radio communications. However, there is no guarantee that interference

Regulatory Compliance

Important Information for Customers

(continued)

will not occur in a particular installation; if this equipment does cause harmful interference to radio or television reception, which can be determined by turning the equipment off and on, you are encouraged to try to correct the interference by one of the following measures:

1. Where it can be done safely, reorient the receiving television or radio antenna.
2. To the extent possible, relocate the television, radio or other receiver with respect to the telephone equipment. (This increases the separation between the telephone equipment and the receiver)
3. Connect the telephone equipment into an outlet on a circuit different from that to which the television, radio, or other receiver is connected.
4. Consult the dealer or an experienced radio/TV technician for help.

CAUTION: Changes or modifications not expressly approved by the manufacturer responsible for compliance could void the user's authority to operate the equipment.

THE PARTY RESPONSIBLE FOR
PRODUCT COMPLIANCE:
Ameriphone Products by Clarity®,
A Division of Plantronics, Inc.
4289 Bonny Oaks Drive
Chattanooga, TN 37406
PHONE: (800) 426-3738

Industry Canada Technical Specifications

This product meets the applicable Industry Canada technical specifications.

Before installing this equipment, users should ensure that it is permissible to be connected to the facilities of the local telecommunications company. The equipment must also be installed using an acceptable method of connection. In some cases, the company's inside wiring associated with a single line individual service may be extended by means of a certified connector assembly (telephone extension cord). The customer should be aware that compliance with the above conditions may not prevent degradation of service in some situations.

Repairs to certified equipment should be made by an authorized Canadian maintenance facility designated by the supplier. Any repairs or alterations made by the user to this equipment, or equipment malfunctions, may give the telecommunications company cause to request the user to disconnect the equipment.

Users should ensure for their own protection that the electrical ground connections of the power utility, telephone lines and internal metallic water pipe system, if present, are connected together. This precaution may be particularly important in rural areas.

CAUTION: Users should not attempt to make such connections themselves, but should contact the appropriate electric inspection authority, or electrician, as appropriate.

The Ringer Equivalence Number is an indication of the maximum number of terminals allowed to be connected to a telephone interface. The termination on an interface may consist of any combination of devices subject only to the

requirement that the sum of the Ringer Equivalence Numbers of all the devices does not exceed five.

[The term “IC:” before the certification/ registration number only signifies that the Industry Canada technical specifications were met.]

This warranty applies only to Ameriphone products that are purchased and used in the United States or Canada.

Warranty Procedure

Clarity warrants the CLS45i Cordless Amplified Telephone against any defect in materials or workmanship for the period of one year from the date of purchase.

If your Ameriphone telephone is defective and returned within 30 days of the date of purchase, your Clarity dealer will replace it at no charge.

If returned after 30 days but within one year from the date of purchase, we will repair or replace it at no charge. In the repair of your CLS45i Cordless Amplified Telephone, we may use new or reconditioned replacement parts. If we elect to replace your CLS45i Cordless Amplified Telephone, we may replace it with a new or reconditioned product of the same or similar design. Repair or replacement will be warranted for either 90 days or the remaining time on the original warranty period, whichever is longer.

Implied warranties, including those of fitness for a particular purpose and merchantability (an unwritten warranty that the product is fit for ordinary use), are limited to one year from date of purchase. We will not pay for loss of time, inconvenience, loss of use of your CLS45i Amplified Telephone, or property damage caused by your CLS45i Amplified Telephone or its failure to work, or any other incidental or consequential damages.

Some states do not allow limitations on how long an implied warranty lasts or the exclusion of incidental or consequential damages, so the above exclusions or limitations may not apply to you.

To get warranty service for your CLS45i Cordless Amplified Telephone, you must provide proof of the purchase date.

Within 30 days of the date of purchase, return your CLS45i Cordless Amplified Telephone to the place where you purchased it for immediate replacement. After 30 days, call Clarity at 800-426-3738 voice or 800-772-2889 TTY for the authorized service center nearest you. You must prepay all shipping costs. We suggest you save the original package materials in the event you need to ship the CLS45i Cordless Amplified Telephone.

When shipping for warranty repair, include your name, address, phone number, proof of date of purchase, and a description of the problem. After repairing the product, we, (or the service center) will ship it back to you at no cost within the United States and Canada. CANADIAN RESIDENTS: call Clarity at 800-426-3738, 800-772-2889 TTY for instructions. This warranty does not cover defects resulting from accidents, damage while in transit to our service location, alterations, unauthorized repair, failure to follow instructions, misuse, use outside the United States or Canada, fire, flood, and acts of God. Nor do we warrant the product to be compatible with any particular telephone equipment, party line, key telephone systems or more sophisticated switching systems. If your CLS45i Cordless Amplified Telephone is not covered by this warranty, call us at 800-426-3738 voice or 800-772-2889 TTY for advice as to whether we will repair your CLS45i Cordless Amplified Telephone and other repair information. The repair shall be warranted for 90 days.

Product Specifications

CLS•45i Dual Speaker Cordless Amplified Telephone

Operates on analog telephone lines

Amplification

Incoming up to 40dB

Electrical

Adapter Class 2 transformer

Input 120V AC 60Hz

Output 9V DC 500mA

Jacks

Handset

3.5mm remote input

3.5mm audio output

2.5mm headset

Base

3.5mm speaker output

Battery Specifics Handset

Operating

Number 1 battery pack (3 cell)

Size 2/3 AA

Type 3.6V 750mAh NiMH

Base

Backup

4

AA

Alkaline

Features and Specifications subject to change without notice.