

RAV 600/900 User Manual

ClearOne[®]
*You're Virtually There*SM

Table of Contents

Introduction	1
Table of Contents	ii
The RAV 600/900	2
Product Overview	4
Basic Room Design	7
Installation Overview	9
Connecting the RAV	13
Basic Connections	14
Auxiliary Devices	18
RAV-Ware Software Configuration	25
Introduction	26
Configuring System Settings	31
Customizing RAV Components	35
Line Input and Output	38
Record and Playback	40
Camera Controls	42
Dialer and Phonebook Usage	43
Advanced Features	46
Using the RAV	51
Using the Controller	52
Programming Phone Preferences	54
Web Interface	61
Overview	62
Appendix	69
Maintenance	70
Troubleshooting	70
Pinouts	73
Specifications	74
Compliance	112

RAV 600/900 Installation and Operation Manual
ClearOne Part No. 800-153-001 November 2004

© 2004 ClearOne Communications, Inc. All rights reserved. No part of this document may be reproduced in any form or by any means without written permission from ClearOne Communications. Printed in the United States of America. ClearOne Communications reserves specific privileges. Information in this document is subject to change without notice.

Introduction

1

The RAV 600/900

The RAV product line is the first out-of-the-box room audio conferencing solution with the sound quality and flexibility of a professionally installed system. The RAV includes an audio conferencing mixer that uses distributed acoustical echo cancelling technology to provide the most intelligible full duplex audio conference experience available. Features include:

- Audio mixer for high quality audio performance in all acoustical environments.
- Internal telephone hybrid with touch-tone dialing capability, call controls including auto-answer, flash duration adjustment, ringer adjustment and phonebook with speed dial capabilities
- Microphone pods provide 360° audio pickup so every participant within the microphone pick-up range can be heard
- Ceiling or wall-mount Bose® speakers allow everyone in the room to experience rich, natural sounding audio.

Services and support

If you need additional information on how to install, set up or operate your RAV 600/900, please contact us. We welcome and encourage your comments so we can continue to improve our products and serve your needs.

Technical support

Tel: 1-800-283 5936 (USA) or
1-801-974-3760
Fax: 1-801-974-3669
E-mail: tech.support@clearone.com
Web: www.clearone.com

Sales and customer service

Tel: 1-800-945-7730 (USA) or
1-801-975-7200
Fax: 1-800-933-5107 (USA) or
1-801-977-0087
E-mail: sales@clearone.com

Product returns

All product returns require a return material authorization (RMA) number. Please contact ClearOne Technical Support before attempting to return your product. Make sure you return all the items that shipped with your product and include a brief description of how the product was being used when the problem occurred.

Unpacking

Carefully remove all components of the RAV system from the packaging. Ensure that you received the following items:

RAV 600/900

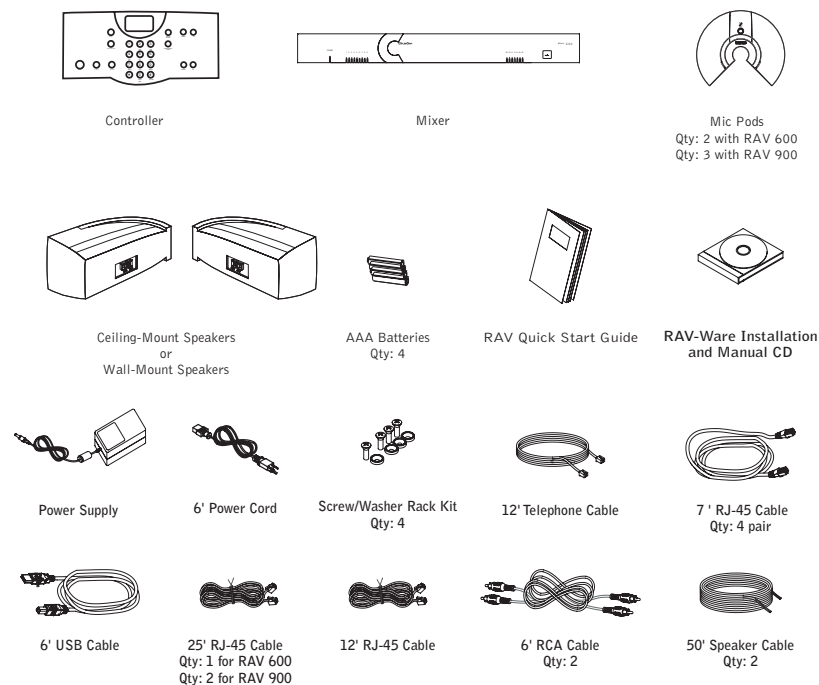



Figure 1.1 RAV unpacking

 **Note:** Rack mount ears come attached to the Mixer box. Refer to installation instructions for more information.

If any parts are missing, please call the Technical Support Group at 1-800-283-5936 (USA) or 1-801-974-3760.

 **Note:** ClearOne is not responsible for product damage incurred during shipment. You must make claims directly with the carrier. Inspect your shipment carefully for obvious signs of damage. If the shipment appears damaged, retain the original boxes and packing material for inspection by the carrier. Contact your carrier immediately.

Product Overview

Controller

The controller allows you to manage all calls, program user preferences and adjust settings for your RAV.

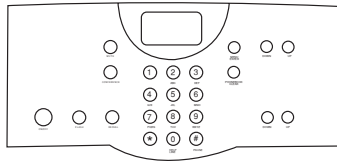

Key Functions

LCD Icon	Function
ANTENNA SIGNAL	Indicates commands are received and acknowledged by base unit and represents the signal strength from the base unit to the controller.
BATTERY	Indicates battery level
Key	Function
ON/OFF	Press to activate the phone and access the dial tone. Press again to hang up the phone.
FLASH	Press to use call forwarding, access call waiting, or make a three-way conference call (if supported by your telephone service).
MUTE	Press once to mute microphones during a call. Press again to unmute.
STATUS	Press to dial your conferencing services provider. This number must be programmed to speed dial number 20.
REDIAL	Press once to dial the last number called.
MENU ENTER	Press once to access the controller programming menu. Once you are in the Menu, this key serves as the Enter key.
PHONEBOOK CLEAR	Press once to dial stored numbers. When you are in the Menu, use this key to delete entries or to go back to the previous screen.
DOWN UP	Press down or up to navigate through the menu and phonebook.
VOLUME	Press while on a call to adjust call volume and ringer.

Mixer

Front

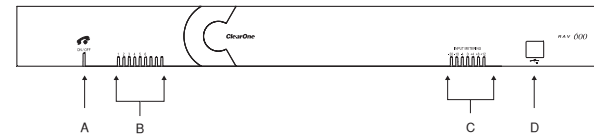

Figure 1.2. Mixer front

- Telephone LED.** This indicator lights red when the mixer is powered, but RAV is not in use. The indicator lights green when the RAV is in use and flashes green during an incoming call.
- Microphone status LEDs.** Nine indicators (RAV 900) or six indicators (RAV 600) indicate the activation status of the microphone elements. When a microphone element is activated, the corresponding LED lights green. When microphones are muted, all LEDs turn red.
- Meter LEDs.** These LEDs represent the output level from all audio inputs.
- USB port.** This port enables USB connection to a PC.

Back

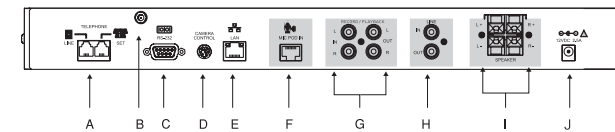

Figure 1.3. Mixer back

- Telephone Set, Line.** RJ-11 connection to an analog telephone jack and an analog telephone set.
- RF antenna connector.** Connect the external RF antenna to this port.
- RS-232.** RS-232 control port for connection to a control system such as AMX or Crestron or to a computer.
- Camera Control.** VISCA camera control port. This connection enables microphone activation to trigger camera presets (voice tracking).
- LAN.** This is a 10/100 BaseT auto-detecting Ethernet port for system control through a data network.
- Mic Pod In.** Use a Cat. 5 cable with RJ-45 connectors to connect the microphone pods.
- Playback In/Record Out.** RCA connection to recording devices such as a VCR.
- Line In/Out.** RCA connection to a codec, amplifier or sound card.
- Speaker Output.** Use speaker wire to connect these push terminals to the Bose loudspeakers.
- Power. 12 VDC.** Power supply.

Microphone Pods

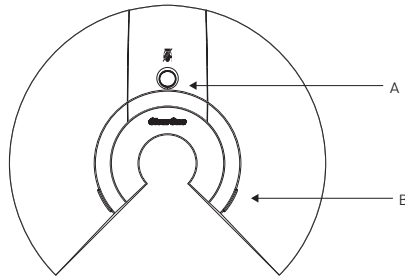

Figure 1.4. Microphone pods

- A. **Mute Button.** Press to mute or unmute all microphones in the RAV system.
- B. **LEDs.** These two LEDs illuminate green when the microphones are not muted and illuminate red when the microphone is muted. The LEDs flash red if the microphones are not connected properly.

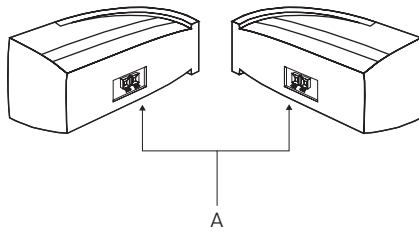

Figure 1.5. Speakers

Speakers (ceiling or wall-mount)

- A. **Push Terminal connectors.** Connect to the RAV mixer using speaker wire (wall-mount speakers are pictured).

Basic Room Design

Basic Room Design for RAV

To ensure best microphone and loudspeaker placement (ceiling or wall-mount), please use the following guidelines. For more information on Room Design, or to view the RAV online training course, visit www.clearone.com.

Microphones

Center mic pods on the table at an equal distance apart. Place the controller on the same table as the mics. In typical conferencing environments, participants should be seated 4–8' from a mic pod.

Mic pick-up range is dependent on room conditions. Background noise, reflective hard surfaces and the number of participants may affect the pick-up range. Use the following guidelines for best placement of your RAV mic pods and then adjust for your specific room conditions.

Performance level	Best	Good	Fair
Distance between microphone and participant	4'	8'	12'

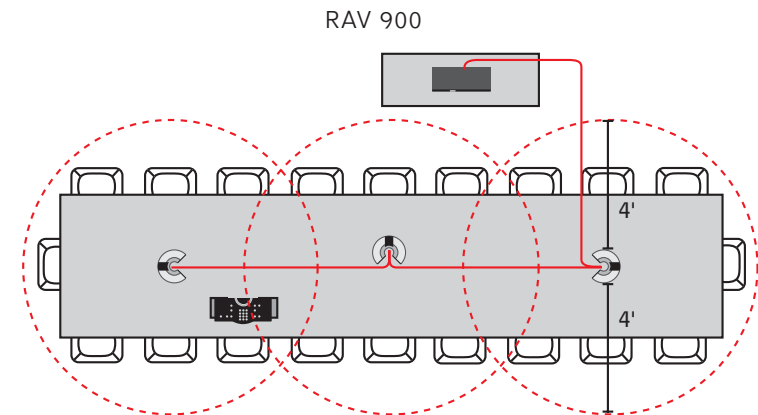

Figure 1.6. Recommended microphone placement

Loudspeakers

Ceiling-mount loudspeakers

For best performance, ceiling loudspeakers should be installed directly above the microphone pods. If you have a RAV 900 with three mic pods, install the ceiling loudspeakers above the first and third mic pods. The ceiling speakers must be set to 8 Ohms. Please refer to the Bose user manual for instructions.

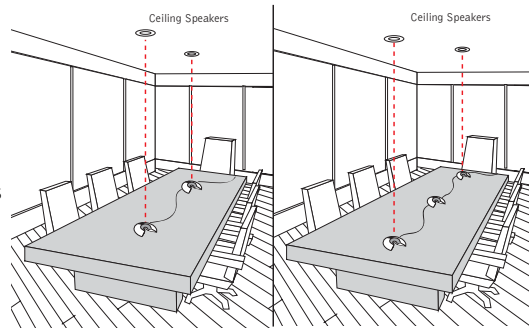

Figure 1.7 Recommended ceiling-mount speaker placement

Wall-mount loudspeakers

Place the left channel loudspeaker on the left side of the room and the right channel loudspeaker on the right. (Refer to the label on the back of each loudspeaker.) Make sure the back of each loudspeaker is parallel to the front wall.

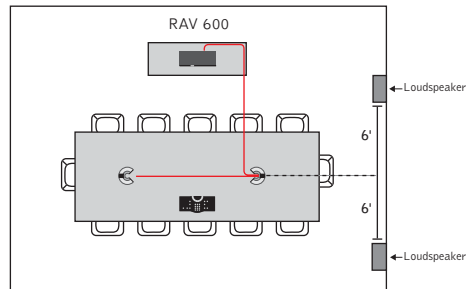

Figure 1.8 Recommended wall-mount speaker placement

For best controller performance

- Do not install the RAV mixer in a metal cabinet unless you are using the remote antenna accessory.
- Keep the mixer within line of sight of the controller, such as on the top of a credenza.
- Ensure antenna is connected to the back of the mixer and is pointed up.
- If installing the mixer in an equipment rack, make sure it is placed at or near the top of the rack.

For best audio performance

- Use the provided cables.
- Do not move microphones while on a call.
- Speak at a normal conversation level and direct your voice toward the microphones.
- Do not place microphones next to fans, projectors or computers.

Installation Overview

Read the user manual

Please read through the RAV Quick Start Guide and print User Manual to familiarize yourself with the RAV system. Refer to the Help File in RAV-Ware for information on the software. Read through all requirements and safety information to be sure you set up and configure your RAV correctly.

Make sure your network is ready

Review all system requirements. Then check with your network administrator to be sure your network meets all the RAV requirements.

Connect cables

Connect all cables. If you are planning on using the RAV for web or videoconferencing, you'll need to connect peripheral equipment. See pages 14–22.

Install software

Install RAV-Ware and then use to adjust sound levels and to configure settings for additional equipment such as a video codec or a recording device. See pages 26–49.

Begin using

Use the controller to answer and make calls. See pages 52–59.

System Requirements

Component	Requirement
Operating System and RAM	Windows 98 64 MB RAM
	Windows 2000 256 MB RAM
	Windows XP 256 MB RAM
Processor	300 MHz Pentium III or better
Monitor	1024 x 768 SVGA (16 bit) high color
Video Card	SVGA 1024 x 768 minimum
Free Hard Disk Space	20 MB minimum
RS-232 COM port	Up to 115,200 baud rate
USB port	USB 1.1–2.0
Macromedia Flash Player 6.0	

 **Note:** Using a USB to serial adapter is not recommended.

Network information

To use RAV over a local area network (LAN), you need to know if the LAN uses Dynamic Host Configuration Protocol (DHCP) or if you need a static IP address.

If the LAN uses DHCP, there is no need to make any network adjustments unless you want to assign a static IP address.

If the LAN does not use DHCP, gather the following information prior to LAN setup:

- The IP address to be assigned to the RAV
- The subnet mask
- The IP address of the default gateway

Connecting the RAV

2

Basic Connections

Connecting the RAV should take less than one hour. Once basic connections for audio conferencing are made, the system is ready to use.

Audio conferencing

To set up audio conferencing

1. If you are installing the mixer into a rack, remove the side panels, rotate them and then reattach using the four screws and washers (optional).

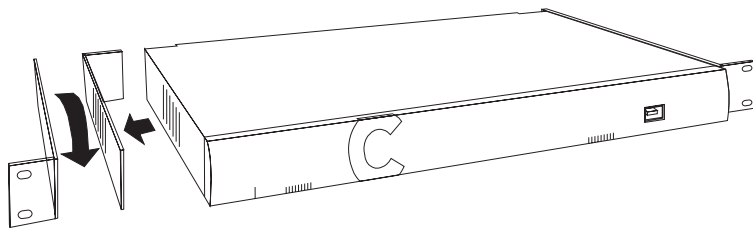

Figure 2.1. Attach rack ears

2. Connect first microphone pod to the mixer with the 25' Cat. 5 cable.

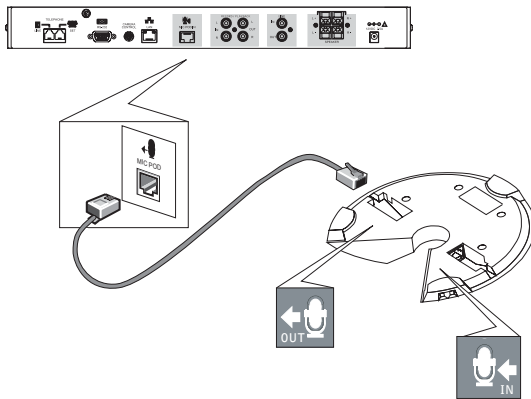

Figure 2.2. Connect to first microphone pod

3. Connect the second and third microphone pod using the 12' Cat. 5 cables. (Third microphone on the RAV 900 only).

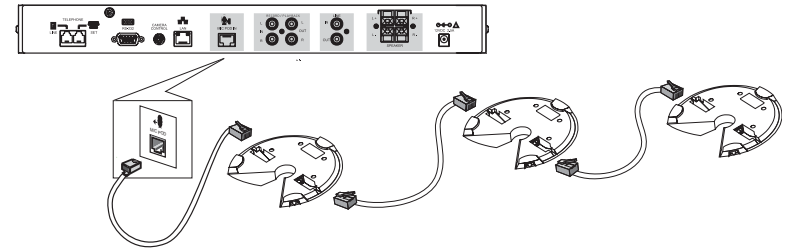

Figure 2.3. Connect additional microphones

4. Connect the speakers to the mixer.

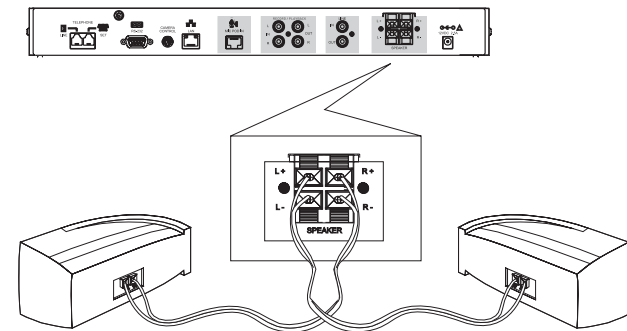



Figure 2.4. Connect speakers

 **Note:** For best performance, speakers must be installed properly. If you are using the ceiling-mount loudspeakers, you must change the setting to 8 Ohms. Refer to the instructions included in the Bose loudspeaker box.

5. Using the RJ-11 cable, connect an analog telephone jack to the Line jack on the mixer.

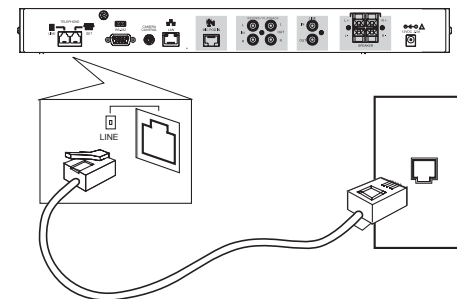

Figure 2.5. Connect telephone cable

 **Note:** For instructions on connecting to a digital line, refer to page 18.

6. Using an RJ-11 cable (not supplied), connect an analog telephone set to the Set jack on the mixer. (optional)

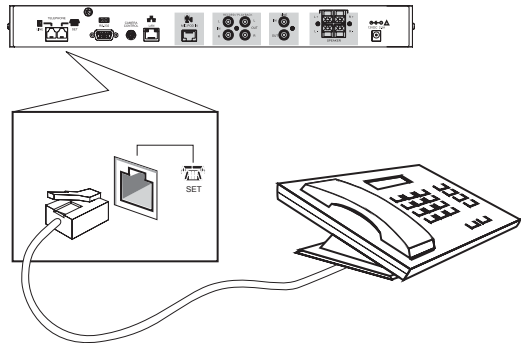

Figure 2.6. Connection to network

7. Using the 7' Cat. 5 cable, connect the mixer to the network. (Network settings can be changed in RAV-Ware.)

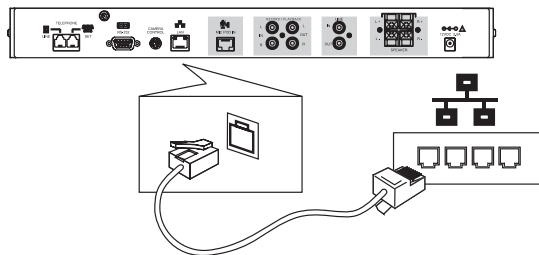

Figure 2.7. Connection to network

8. Using the power supply cords, connect the mixer to an electrical outlet.

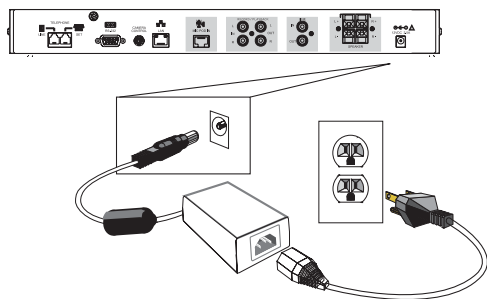

Figure 2.8. Connection to electrical outlet

9. Attach the external antenna and turn it so the it is in an upright position.

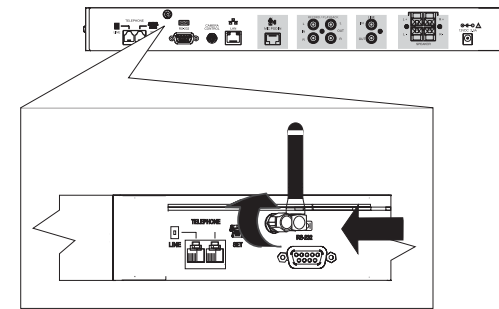

Figure 2.9. Attach external antenna

10. Insert four AAA batteries into the RF controller.

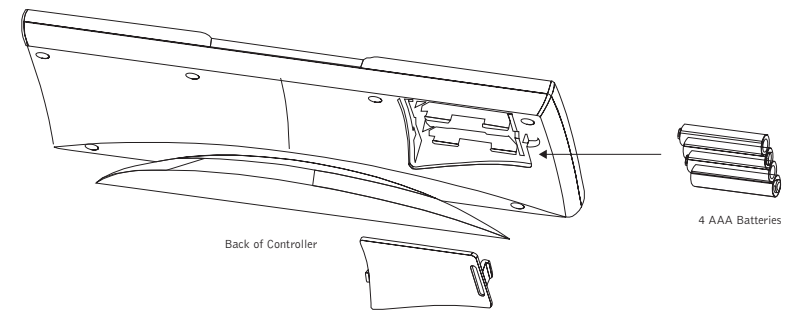

Figure 2.10. Insert batteries

Auxiliary Devices

The mixer allows connection to a number of different audio and video peripherals, such as video codecs, VCRs, cameras and computers.

Connecting video codecs, amplifiers and sound cards

Line input/output devices such as video codecs, amplifiers and sound cards can be connected to the Line In and Line Out connectors on the RAV mixer. These connectors are mono-audio.

To connect to a video codec

1. Using an RCA cable, connect the **Line In** on the RAV mixer to the line out on a video codec.

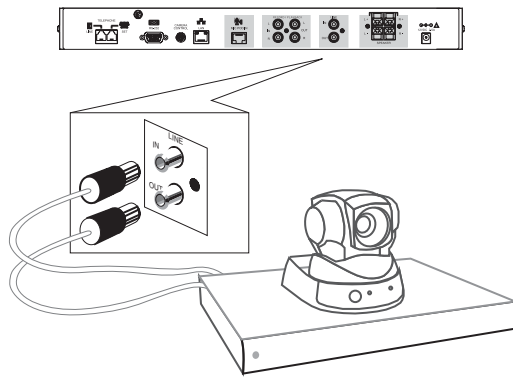

Figure 2.13. Connecting a Line In/Out device

2. Using an RCA cable, connect the **Line Out** on the RAV mixer to the line in on a video codec.

To connect to a sound card

1. Using an RCA cable, connect the **Line In** on the RAV mixer to the line out on a sound card.

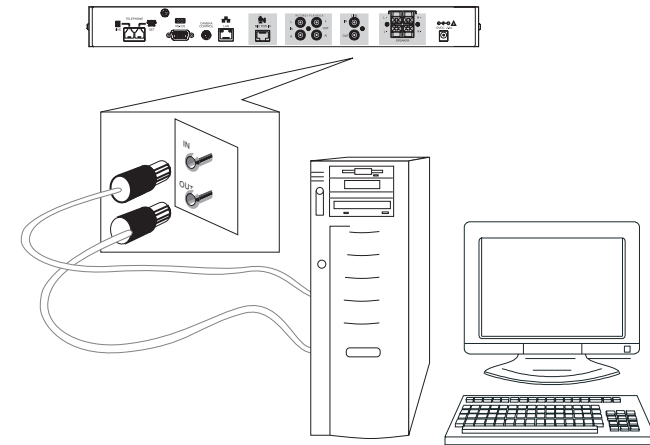

Figure 2.14. Connecting a Line In/Out device

2. Using an RCA cable, connect the **Line Out** on the RAV mixer to the line in on a sound card.

To connect to amplifier

- Using an RCA cable, connect the **Line Out** on the RAV mixer to the line in on an amplifier.

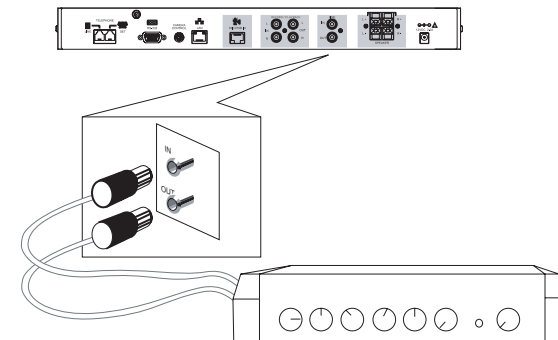



Figure 2.15. Connecting a Line In/Out device

or

- Using an RCA cable, connect the **Record Out** on the RAV mixer to the line in on a sound card.

 **Note:** User RAV-Ware to adjust the equalization and volume of these devices. Refer to pages 38–42 for more information.

Connecting VCRs and DVD players

Record/Playback offers stereo audio input and output. You can record your audio/video conference or play audio using a playback device such as a VCR or DVD player.

 **Note:** You can also connect a mono-signal device or a non-record/playback device to these line in/out connectors.

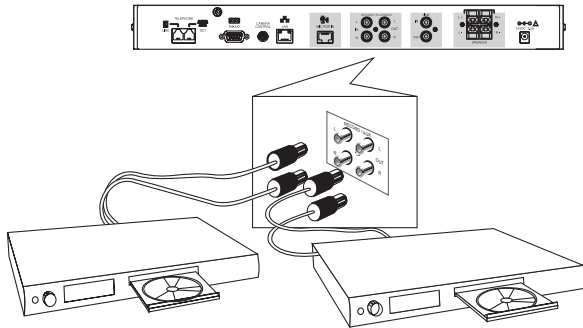

Figure 2.16. Connecting a Record/Playback device

To connect to record/playback

- For recording, connect the **Left and Right audio Out** on the RAV to the left and right audio in on the VCR or DVD player.
- For playback, connect the **Left and Right audio In** on the RAV to the left and right out on the VCR or DVD player.

Connecting PTZ cameras

The RAV system provides voice tracking capabilities through VISCA control port connection to a Pan, Tilt, Zoom camera. Voice Tracking allows the camera to move to preset positions based on microphone activation. For instructions on programming the presets, see page 36.

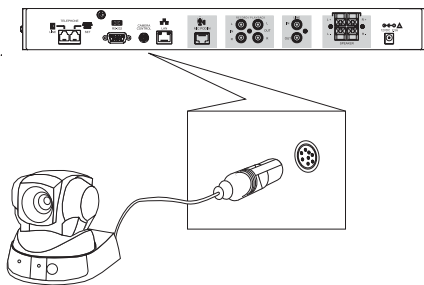

Figure 2.17. Connecting a camera

To add a camera

- Connect the camera to the **Camera Control** port on the mixer.

 **Note:** The camera video signals connect to a video codec.

Connecting for serial control

You can connect a computer or a control device, such as an AMX or Crestron, to the RAV mixer through the serial control port.

To connect a computer serial port

- Connect computer to **Control** port on the back of the mixer using a standard serial cable.

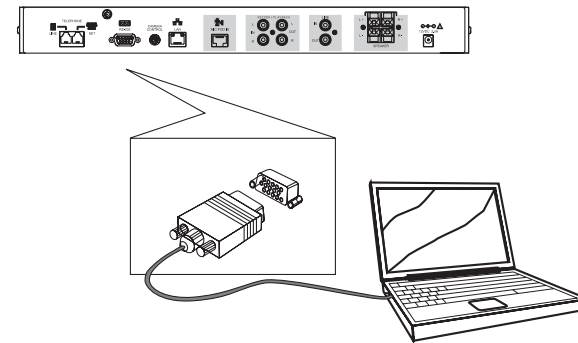

Figure 2.18. Connecting a computer serially

Connecting for USB control

You can connect a computer to the RAV to access RAV-Ware through the USB port.

To connect a computer through the USB port

- Connect computer to the **USB** port on the front of the mixer using a USB cable.

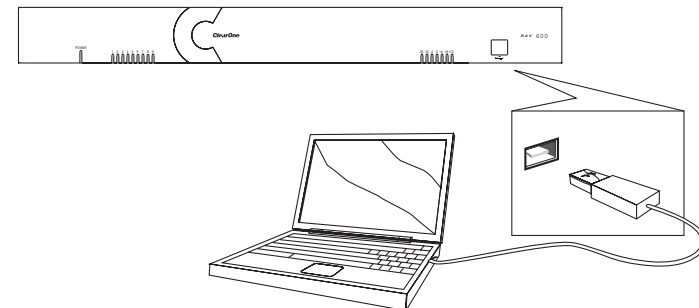



Figure 2.19. Connecting a computer through the USB

 **Note:** The USB drivers are installed when you install RAV-Ware.

Digital phones

If you have a digital (PBX) telephone service, you need to run an analog extension from the PBX (recommended for best performance) or use a digital-to-analog telephone line converter. For more information, contact ClearOne Technical Support.

 **Note:** If you connect the RAV through a digital to analog line converter, you will not be able to use the tabletop controller or the RAV-Ware dialing interface to make calls. You will instead need to dial from the digital phone. The phone handset must be kept off hook for the duration of the call.

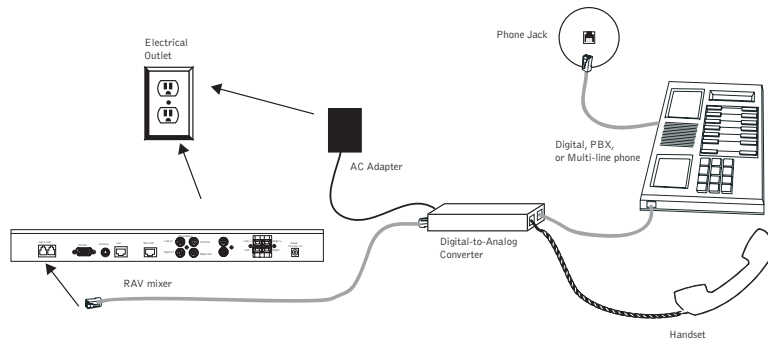

Figure 2.20. Connecting the RAV mixer to digital-to-analog converter

To connect to a digital phone

1. Connect one end of the telephone cable into the telephone line on the back of the mixer and the other end into the digital-to-analog converter.
2. Connect the converter's power adapter into an electrical outlet.
3. Connect a second telephone cable from the converter to a PBX phone. Consult the converter user manual for more information.

RAV-Ware
Software Configuration

3

Introduction

Getting started with RAV-Ware

Please ensure that you have administrative privileges before attempting to install RAV-Ware on computers running Windows 2000 or later. You should also review the System Requirements on page 9, to ensure software will run correctly and that you have all the necessary network information.

Install RAV-Ware

1. Close all programs or applications running on your PC or laptop and insert the RAV-Ware CD that shipped with your RAV system into the CD-ROM drive.
 - If the Autorun feature is enabled on the PC, the CD will open automatically.
 - If the Autorun window does not open, select Run from the Start menu. Type <drive>:\setup.exe where <drive> is the letter of the CD-ROM drive (e.g., D:\setup.exe).

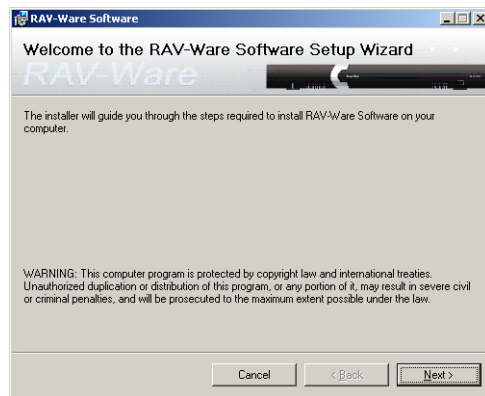



Figure 3.1. Installing RAV-Ware

2. Follow the on-screen instructions.

 **Note:** The Disk Cost button allows you to view all available disk space.

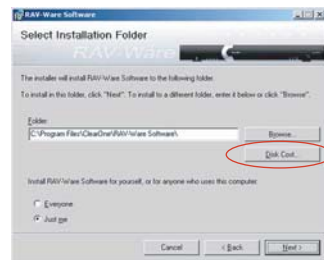

Figure 3.2. Disk Cost

RAV-Ware overview

ClearOne's RAV-Ware™ software provides an easy interface for configuring system settings and customizing the audio in your RAV 600/900 business conferencing system. While the RAV system is designed to work out of the box for audio conferencing setups, RAV-Ware is required to adjust audio levels and equalizer settings for the RAV components as well as the auxiliary audio devices. Once installed, RAV-Ware allows configuration locally through USB or RS-232 connection, or remotely through the Ethernet connection.



Figure 3.3. Installing RAV-Ware

Menus and Toolbar: Easily create, open or save files, find RAV systems on the network, add phonebook entries, configure regional settings and view the event log.

Connections: Lists available units connected through serial or USB ports, or on the network.

Device Toolbox: Lists common brands of auxiliary audio products (video codecs, sound cards, VCRs and amplifiers). The audio settings for these devices have been optimized for use with the RAV system.

Configuration Screen: Quickly access the configuration windows for the RAV system by clicking the icons.

Online/Offline indicator: Shows connection status of RAV-Ware(online/offline) and the name of the connected unit.

Status Indicators: Status for Communications (green = online, red = offline), Telephone In Use (red = not in use, green = in use) and Mic Mute (red = mute).

RAV-Ware connections

When you connect to the RAV unit, RAV-Ware automatically finds all RAV units connected serially or on the same subnetwork and lists them in the Connections pane.

To connect to the RAV

- 1 Double-click the RAV-Ware desktop icon. Or, select RAV-Ware from the Start menu (start/programs/rav-ware/ravware.exe).

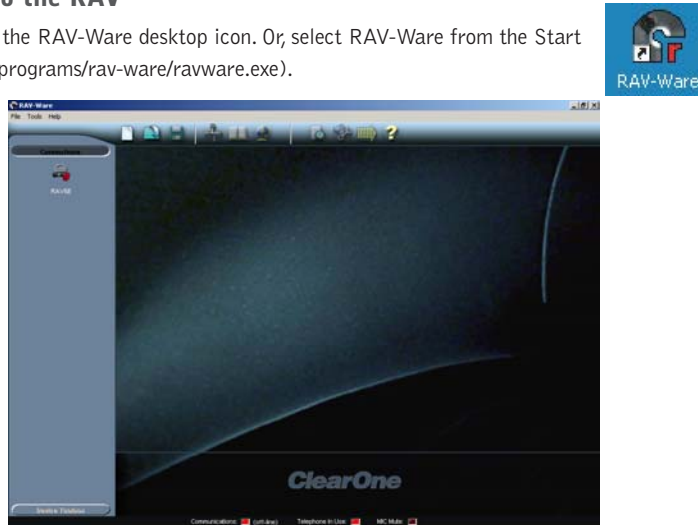

Figure 3.4. RAV-Ware units

- 2 Click the RAV icon in the Connection pane.
 - If you are connected serially, the RAV configuration window appears.
 - If you are connected through the network, you will be prompted to enter a user name and password. The default user name is **ClearOne** and the default password is **RAV**.

 **Note:** To connect to a RAV unit on a different subnetwork, use Network Find. See page 26.



Figure 3.5. Configuration window

RAV-Ware files

You can save current RAV-Ware files, create new files, edit existing files and import files using the menus and toolbar icons. When connected to a RAV unit, any changes made to a RAV-Ware file are updated immediately, but must be saved to remain permanent.

To save a file

1. From the File menu, select **Save File**.
2. Browse to the desired location and enter the name of the file.
3. Click **Save**.

 **Tip:** You can right click on the configuration window and select **Save File** to save your file. You can also select **Save As** to rename and save the file you are working on.

To create a new file

1. Click the **New File** toolbar icon.
2. Select either the RAV 600 or RAV 900 depending on your system. This will open the Configuration Screen where you can set user preferences for your RAV system.
3. Save the file.

To edit an existing file

1. Click the **Edit File** toolbar button.
2. Locate and select the file you want to edit.
3. Click **Open**.
4. Make desired changes to the file.
5. Save the file.

 **Note:** The changes will only take effect after they have been imported to a connected RAV system.

To import a file

1. Connect to a RAV unit.
2. From the File menu, select **Import**.
3. Choose your RAV file.
4. Click **Open**. The RAV unit will reboot and then update with all the file changes.

 **Tip:** You can also right-click on the configuration window and select **Import** to import a saved RAV file.



Network Find

Network connection allows you to connect to any RAV system on your network using its IP address or a unique network name. Use Network Find to access RAV units not listed in the Connections pane, but which reside on the same network.



To open the Network Find

- Click the **Network Connection** button on the toolbar.

To connect to a system on the network

- Enter the **IP address** or **name** of the RAV system to which you want to connect.
- Click **OK**.
- You will see a password prompt window. Enter the **User Name** and **Password** of the networked system. The default user name is **ClearOne** and the default password is **RAV**.
- Click **OK**. The system icon will appear in the Connection list and the Configuration screen will open.



Figure 3.6. Network Find



Figure 3.7. User Name/Password

- Note:** Once you have connected to a RAV unit using network find, a shortcut connection icon for that unit will as long as RAV can find the unit on the network. If RAV can not find the unit, the shortcut icon will be removed.

Configuring System Settings

System settings include Communication, Regional and Telephone settings.

Communication Settings

The Communication window allows you to adjust the connectivity settings of external devices that communicate with the RAV, including the network, serial or USB connections. You can connect a PTZ camera to the Camera port and use the Voice Tracking feature. You can also change the RF frequency to match the frequency of your controller or if you are experiencing interference on the current channel.

To open the Communication Settings window

- Click the **Communication** icon in the Configuration screen.



- Note:** When RAV is connected to a DHCP network, network, IP, Gateway and subnet addresses are automatically assigned. Unless you want to specify a static IP address, there is no need to configure network settings.

To create a static IP address

- Note:** Contact the network administrator for network settings.

- Create a unique network name and enter it in the **Network Name** field. (Default is ClearOne-XX where XX is the last two digits of the MAC address.)
- Clear the **Use DHCP** option and enter the **IP**, **Subnet** and **Gateway** addresses.
- Select **Use DNS** if you have a Domain Name Server and want name resolution (to use a network name) for your static IP address.
- In the IP Filters section, enter specific IP addresses that will be allowed to access the RAV system. You can specify a range of IP addresses by using zeros. For example, entering 192.168.105.0 will allow any IP addresses in the 192.168.105.1 to 192.168.105.254 range to access the RAV system.
- Click **OK**.
- Click **Yes** to save your settings.



Figure 3.8. Network settings

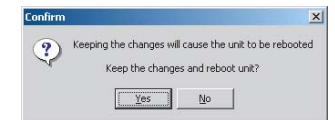

Figure 3.9. Confirm changes

To change the User Name and Password

1. Click **User/Password**.
2. Specify the **User Name**.
3. Enter the **Password**.
4. Click **OK**.

 **Note:** This option is only available when you are connected to a RAV unit.



Figure 3.10. Password

To configure the Camera port

1. Set the **Baud Rate** to match the baud rate indicated in the camera specifications.
2. Select **Flow Control** to enable hardware flow control.
3. Click **OK** to save settings and close the window.

To configure the Control port

1. Set the **Control Port Baud Rate** to match the baud rate of the PC COM port or the control device.
2. Select **Flow Control** to enable hardware flow control. (Flow Control is selected as default.)
3. Click **OK** to save settings and close the window.

 **Note:** Flow Control is the regulation of information between two devices that are connected to one another. ClearOne recommends enabling Flow Control on the RAV system.

 **Attention:** If you are connected to the RAV unit through the serial port, you will need to reboot the unit before the baud rate and flow control changes take place. If you are connected to the RAV unit through the USB port, changes are made instantly.

To change RF frequency channel

1. Click the **Frequency Setting** tab in the Regional Settings window.
2. Select a new frequency. The new frequency will be displayed.

 **Note:** The channel frequency allows the mixer to communicate with the controller. The frequency used by RAV-Ware must match the frequency used by the controller. See page 54 to set the controller frequency.

 **Attention:** If you are using the RAV 900, frequency 1 and frequency 8 are the same frequency.

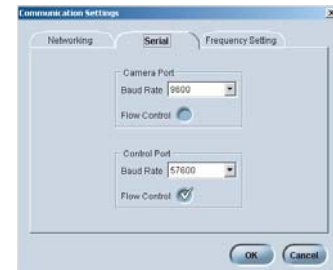

Figure 3.11. Serial settings



Figure 3.12. Frequency settings

Regional Settings

In the Regional Settings window, you can configure the date and time to ensure an accurate time stamp on log files.

To open Regional Settings

- Click the **Regional Settings** icon in the Configuration screen.



To set date and time

1. Select **Use Local Time**, if you want to use the time on your local computer.

– Or –

Clear the **Use Local Time** check box and enter the **IP address** for the time server.

2. Select **Use Daylight Savings** if your region observes daylight savings time.
3. Select your **Time Zone** and click **OK** to save settings.



Figure 3.13. Date/Time settings

Telephone Settings

In the Telephone Settings window you can set telephone preferences such as auto-answer, auto-disconnect, ringer melody and program the local number. You can also adjust the telco level control, country setting and the flash settings.

To open Telephone Settings

- Click the **Telephone Settings** button on the configuration screen.



To change telephone preferences

1. Set the system to **Auto-Answer** after 2 Rings or 4 Rings or select **Disabled** if you want to manually answer calls.
2. Select **Auto-Disconnect** if you would like RAV to disconnect when it detects loop-drop or call progress tones.
3. Select from three available ringer melodies. Click **Ringer Test** to hear selected melody.

 **Note:** This option is only available when you are connected to a RAV unit.

4. Select **Audible Connect** if you would like one tone to sound when the RAV is taken off hook and two tones to sound when the RAV is hung up.
5. Adjust ringer volume using the Ringer Level slider.
6. Enter the **Local Number** for the RAV system. The local number displays on the third line of the controller LCD.

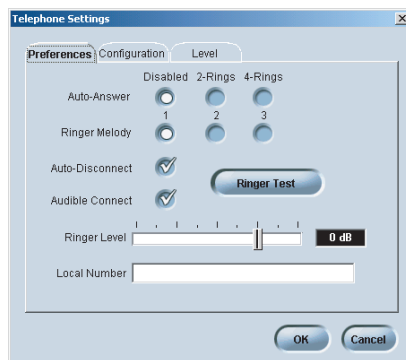

Figure 3.14. Telephone preferences

To select telephone configuration

1. Select the **Country** where the phone is being used (default is US/Canada).
2. Select **Flash** duration from the Flash Settings list. This setting is dependent on the requirements of your PBX or telephone system.

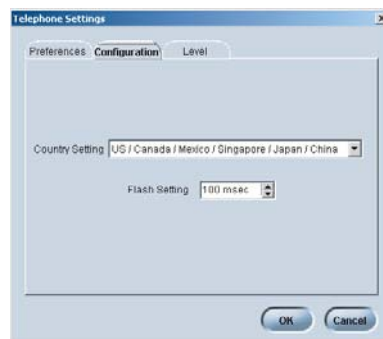

Figure 3.15. Telephone configuration

To adjust telephone level

1. Select **Auto Receive Level Control**. (The default is Off.) ClearOne recommends keeping Auto Receive Level Control selected. This feature automatically adjusts the far end audio to keep it at a constant level.
2. Use the sliders to adjust the level of the telco transmit and telco receive.

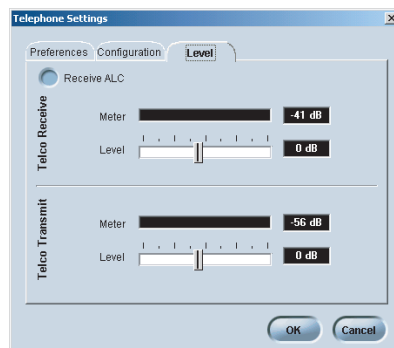

Figure 3.16. Telephone level

Customizing RAV Components

Your RAV system is pre-configured for optimal audio quality right out of the box. However, you can customize the audio and adjust volume to match user preferences. You can also change the mix of audio being sent to the far-end conference site and recording devices.

Microphones

You can adjust microphone volume and enable or disable Automatic Level Control (ALC) settings in the Microphone Settings window. Automatic Level Control automatically adjusts microphone levels to ensure participants' voices are transmitted at consistent levels regardless of whether people are speaking loudly or softly.

To access Microphone Settings

- Click the **Mic Pod** button on the configuration window.



To enable ALC

- Click the **ALC** button. The indicator will turn green when ALC is enabled.

To adjust audio level (volume)

- Using the slider, adjust the volume. The meter will display output levels.

To set Acoustic Echo Cancellation (AEC)

1. Click **Advanced**.
2. Click **AEC** to enable Acoustic Echo Cancellation. The indicator will turn green.

 **Note:** AEC prevents echo from reaching the far-end. ClearOne recommends keeping AEC enabled.

To set Noise Cancellation (NC)

1. Click **Advanced**.
2. Click **NC** to enable noise cancellation. The indicator will turn green

 **Note:** Noise Cancellation prevents ambient or background noise from being sent to the far-end. ClearOne recommends keeping NC enabled.

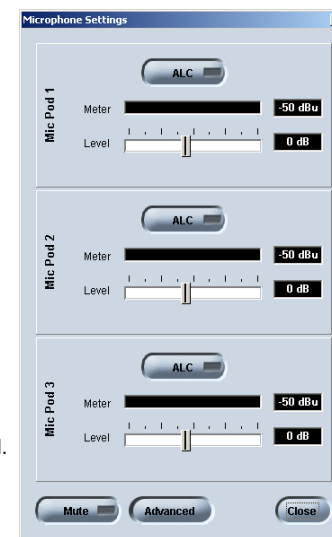

Figure 3.17. Microphone settings



Figure 3.18. Advanced settings

Loudspeakers

You can adjust your Bose loudspeaker equalization, change volume levels and enable ClearEffect in the Loudspeaker Settings window. Equalization in RAV-Ware is similar to the bass and treble adjustments on a stereo. Increasing or decreasing the low, mid and high frequencies and levels allows you to customize loudspeaker audio and provide the optimal listening experience for your users. When ClearEffect is enabled, it causes the audio coming from the telephone line to emulate wideband audio. It does this by adding high and low frequencies to the audio signal, creating a fuller sound.

To access Loudspeaker Settings

- Click the Loudspeaker button on the configuration window.



To enable ClearEffect

- Click the ClearEffect Off/On button. The indicator will turn green when ClearEffect is enabled.

To adjust equalization

- Adjust the the Low, Mid and High frequency tones using the Equalization sliders.

To adjust audio level (volume)

- Using the slider, adjust the volume. The meter will display output levels.

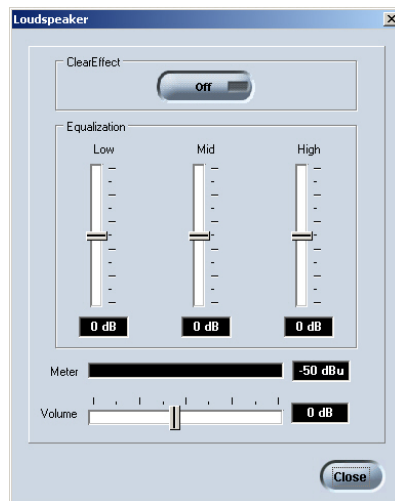

Figure 3.19. Loudspeaker settings

Mixer

The Mixer Console allows you to create audio mixes for the different outputs, adjust volume levels and view the output meters. The audio inputs are shown along the left side of the window and the audio outputs are along the top.

To open the Mixer Console

- Click the Mixer Console button.



To create a mix of audio

- Select which audio is to be included in each output mix. A check mark indicates the audio will be included in the output mix.

RAV-Ware does not give options to route microphone audio to the loudspeakers, the line input to the line output or the telephone receive to the telephone transmit. This prevents audio looping.

To adjust audio levels

- Use the sliders to adjust the audio levels for Playback, Telephone, Line In and the microphone pods.

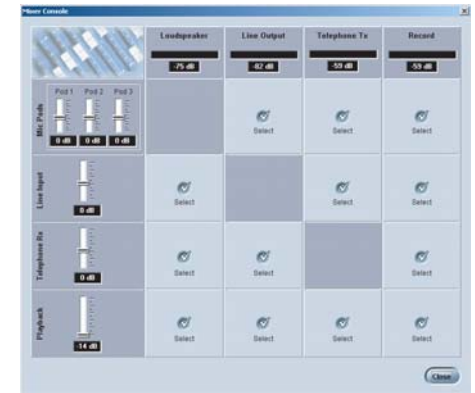

Figure 3.20. Audio Mixer

Note: You can also adjust levels by opening the configuration windows for each component. Changes made to the levels on the audio mixer window will be reflected in the configuration windows.

Effects of using an external amplifier

If you connect an external amplifier to the RAV unit on either the Line Out port or the Record Out port, the mixer console options change.

- If you place an external amplifier on the Line Output, the options to route any audio to the loudspeakers and to route the microphones to the Line Output are no longer available.
- If you place an external amplifier on Record, the options to route any audio to the loudspeakers and to route the microphones to the Record output are no longer available.



Figure 3.21. Audio Mixer with external amplifier

Line Input and Output

The RAV mixer has jacks for Line Input and Line Output that allow you to connect different auxiliary devices. You can configure audio levels for these devices through RAV-Ware. You can use devices that have preconfigured audio settings from the Device Toolbox or you can manually set the audio settings for your line in and line out devices.

Preconfigured video codecs, amplifiers and sound cards

The audio settings for many common auxiliary devices such as video codecs, VCRs, amplifiers and sound cards, have been pre-configured for optimal performance with the RAV system. Preconfigured devices are listed in the Device Toolbox and can be placed on the Line In and Line Out icons.

 **Note:** If you would like to add a device to the Device Toolbox, please refer to the Device Toolbox Editor on page 43.

To select a pre-configured line-level device

1. Click the **Device Toolbox** button to display preconfigured devices.



Figure 3.22. Line input device list

2. Click the + to expand the category that matches your device type.
3. Click the device name, hold and drag it to the configuration screen. Drop over the Line Input or Output. The label and icon will change based on the selected device.

 **Note:** Video codecs will cover both Line Input and Output. A sound card should be placed on Line Input or on both input and output for web conferencing. An amplifier is Line Output only.

Adjusting Line Input/Output settings

If your device is not listed in the Device Toolbox you can manually customize and configure the audio of your auxiliary devices in the Line Input and Line Output windows. Line input and output devices include video codecs, CD players, amplifiers and sound cards.

To access line input settings

- Open the Line Input window by clicking on the **Line Input** device icon.



To adjust equalization

- Adjust the Low, Mid and High frequency tones using the Equalization sliders.

To adjust audio level (volume)

- Using the slider, adjust the volume. The meter will display input levels.

 **Note:** To save the name and setting of your line input device, refer to the Device Toolbox Editor on page 43.

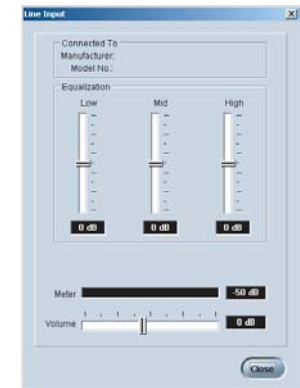

Figure 3.23. Line Input

To access line output settings

- Open the Line Output window by clicking on the **Line Output** device icon.



To adjust equalization

- Adjust the Low, Mid and High frequency tones using the Equalization sliders.

To adjust audio level (volume)

- Using the slider, adjust the volume. The meter will display input levels.

 **Note:** To save the name and setting of your line output device, refer to the Device Toolbox Editor on page 49.

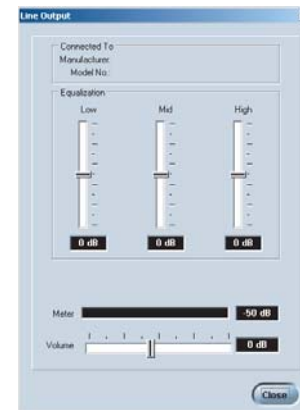

Figure 3.24. Line Output

Record and Playback

Record and Playback devices include VCRs, DVD players and sound cards, however the Record/Playback jacks are line level inputs and outputs and are not restricted to these devices. You can use devices that have preconfigured audio settings from the Device Toolbox or you can manually set the audio settings for your VCRs or DVD players.

Preconfigured record/playback devices

The audio settings for many common record/playback devices have been pre-configured for optimal performance with the RAV system. Preconfigured devices are listed in the Device Toolbox and can be placed on the Record and Playback icons.

To select a preconfigured record/playback device

1. Click the **Device Toolbox** button to display preconfigured devices.
2. Expand the category that matches the device you added.



Figure 3.25. Record/Playback device list

3. Click the device and drag it to the configuration screen. Drop over the Record or Playback icon. The label and icon will change based on the selected device.

Note: You are not limited to record and playback devices with these connectors. The Record and Playback jacks are line input and line output jacks and can be connected to video codecs, CD players and amplifiers.



To remove a device

1. Right-click on the device you want to remove.
2. Select **Clear Device**.



Adjusting Record/Playback settings

If your device is not listed in the Device Toolbox you can manually customize and configure the audio of your auxiliary devices. The Record Settings window is used to customize and configure audio being sent to recording devices that are connected to the record jack on the RAV mixer. The Playback Settings window is used to customize and configure the audio from the playback device that is connected to the Playback jack on the RAV mixer.

To open playback settings

- Open the Playback configuration window by clicking on the **Playback** device icon.



To adjust equalization

- Adjust the Low, Mid and High frequency tones using the Equalization sliders.

To enable Stereo Mix

- Select **Stereo Mix** if your playback device uses stereo inputs.

Note: RAV provides mono-only audio.

To adjust audio level (volume)

- Using the slider, adjust the volume. The meter will display input levels.

Note: To save the name and setting of your playback device, refer to the Device Toolbox Editor on page 43.

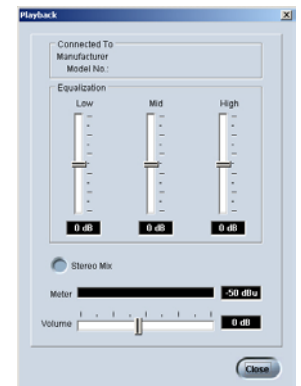

Figure 3.26. Playback

To open record settings

- Open the Record configuration window by clicking on the **Record** device icon.



To adjust equalization

- Adjust the Low, Mid and High frequency tones using the Equalization sliders.

To adjust audio level (volume)

- Using the slider, adjust the volume. The meter will display input levels.

Note: To save the name and setting of your recording device, refer to the Device Toolbox Editor on page 49.

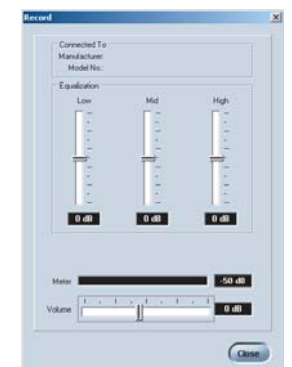



Figure 3.27. Record

Camera Controls

The RAV system provides voice tracking capabilities through VISCA control port connection to a PTZ camera.

Setting camera presets

The camera presets are programmed in RAV-Ware and assigned to each microphone pod. When a specific microphone is activated, the PTZ camera will move to the associated preset camera position. The RAV 900 Supports three camera positions and a home position. The RAV 600 supports two camera positions and a home position.

 **Note:** The PTZ camera can still be controlled manually from the camera or video codec remote control.



To open Camera Controls

- Click the **Camera Controls** button on the configuration window.

 **Note:** This option is only available when you are connected to a RAV unit and have a camera connected to the VISCA port.

To set camera presets

- Select the **Camera Control Mode**, either Sony or Canon.

- Select which camera you are programming.

- Select the **Camera Delay**.

Camera delay is the amount of time the microphone must be activated before the camera moves to the preset position and amount of time the microphone must be inactive before returning to the home position. ClearOne recommends setting the camera delay to at least two seconds to prevent the camera from changing positions at every sound.

- Using the directional arrow buttons and the **Zoom In** and **Out** buttons, position the camera for the first microphone pod.
- Click **Save Preset** under the microphone pod to assign the camera position to the mic pod.
- Repeat steps for the second and third mic pod (RAV 900 only) and home position.
- Select the **Voice Tracking System Enabled**.

 **Note:** Once you set the presets, do not switch Camera Control Mode (the camera type). This will delete all presets.

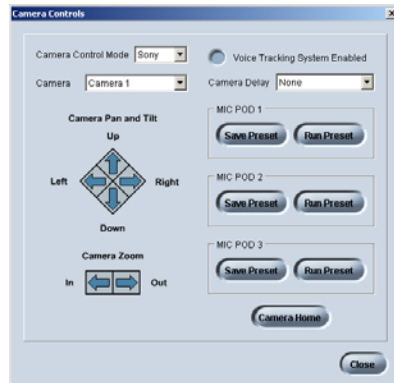

Figure 3.28. Camera Controls

To test camera presets

- Select the camera you are testing.
- Click **Run Preset** for each microphone pod to test the programming.

The camera should move to the preset position for each microphone.

Dialer and Phonebook Usage

The RAV system includes a Phonebook that stores up to 20 names and phone numbers. Phonebook entries may be entered through RAV-Ware or using the RF controller. The Dialer in RAV-Ware mimics the RF controller and may be used to make calls, mute microphones and adjust the loudspeaker volume. See pages 48-55 for information on using the RF controller.

Phonebook

RAV-Ware features a Phonebook utility which stores up to 20 phone numbers. These numbers are also assigned a speed dial number for dialing convenience through the RAV Controller. Phonebook entries are listed in alphabetical order. You can add, edit or delete entries from the Phonebook window.



To open the Phonebook

- Click the **Phonebook** button on the toolbar.

To add a Phonebook entry

- Click **New Entry**.
- Enter the **Name** and **Number**.
- Enter a **Speed Dial Number**.
- Click **Add Entry**.

To delete a Phonebook entry

- Select the entry you want to delete.
- Click **Remove**.

To edit a Phonebook entry

- Select the entry you want to edit.
- Make desired changes to the entry.
- Click **Change**.

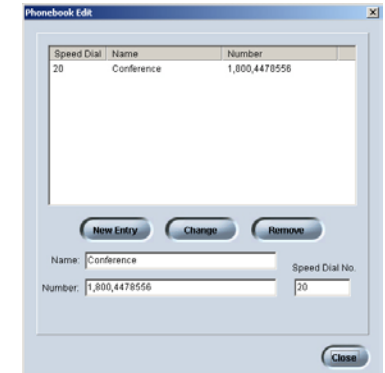

Figure 3.29. Phonebook Edit

Dialer

While most calls will be made using the RF controller, you can also manage all your calls from the Dialer in RAV-Ware. You can dial a number, redial the last dialed call, and disconnect calls. You can also use flash settings, mute the microphones and adjust loudspeaker volume.

To open the Dialer

- Click the **Dialer** icon on the configuration window.



 **Note:** This option is only available when you are connected to a RAV unit and have a telephone line connected to the LINE port on the mixer.



Figure 3.30. Dialer window

To make a call

- Click the **ON/OFF** button.
- Dial the number as you would on a standard phone. The number appears in the dialing window at the top.

 **Note:** You can also pre-dial the number and press the **ON/OFF** button to connect the call. Press and hold the pound key (#) to enter a pause in the dialing string.

 **Tip:** You can also dial using the 0-9, *, and # on your on your keyboard. The Enter key connects to and disconnects from the telephone line.

To make a call from the phonebook

- Using the mouse, select the number in the phonebook. The name and number appear in the display window.
- Click **ON/OFF** button to dial the call.

Tip: You can also double click the name in the phonebook. The phone will be taken off hook and the number dialed.

To end a call

- Click the **ON/OFF** button.

To redial

- Click the **REDIAL** button. The phone will automatically be taken off hook and the last dialed number will be called.

To send a Flash signal

- If your telephone service includes call transfer, call waiting or conference calling, you can use the Flash key. Refer to your local telephone service provider for details.

To mute/unmute

- Click the **MUTE** button to mute all microphones. The LED on the microphones will illuminate red.
- Click the **MUTE** button again to unmute all the microphones. The LED on the microphones will illuminate green.

To adjust call volume

- Use the **UP** and **DOWN** buttons to adjust the call volume to the desired level.

To return to the Configuration screen

- Click the **Switch to Flow Window** to return to the configuration screen.

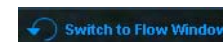

Advanced Features

The Advanced features of RAV-Ware allow you to perform system diagnostics and administrative functions.

System Checks

The System Diagnostics window allows you to check your RAV system to be sure all components of your system are connected and working properly.

To open the System Checks

- Click the **System Diagnostics** toolbar button.



Note: This option is only available when you are connected to a RAV unit.

To run System Checks

- Click the **Start** button.
If you are local (in the same room as the loudspeakers), you will hear a tone as the RAV checks all components. When the check is complete, lights will indicate the status of each component. Green indicates the component is connected and functioning. Red indicates a problem with the component.



Figure 3.31. System Checks

Event Log

The Event Log keeps record of a user selectable list of events. You select which events you want recorded and RAV-Ware keeps a log allowing you to periodically review events and make sure the system is running smoothly. You can also save the Event Log as a .txt file. Check the Event Log when there are communication errors or for other troubleshooting.

To open the Event Log

- Click the **Event Log** toolbar button.



To track events

- Select the events you would like to log.

To save an Event Log

- Click the **Save** button.
- Name the file.
- Click **Save**.

The log is saved as a .txt file.

To print an Event Log

- Click the **Print** button.
- Select the printer.
- Click **Print**.

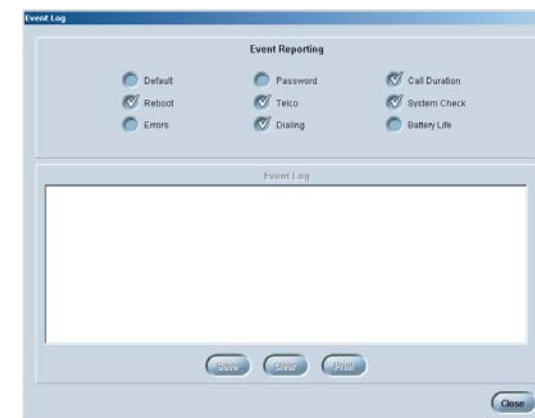

Figure 3.32. Event Log

Selection	Function
Default	Logs when the mixer settings are defaulted.
Reboot	Logs every time the RAV system reboots.
Errors	Logs internal errors. The same errors are displayed in the Error Log.
Password	Logs failed and successful access through TCP/IP or web interface
Telco	Logs when telco was enabled and disabled.
Dialing	Logs dialed numbers.
Call Duration	Logs how long each call lasts.
System Check	Logs when system checks are performed and the results of the checks.
Battery Life	Logs battery level as reported by the RF controller.

Error Messages

Whenever the RAV system encounters an error, an error icon will appear in the lower left corner of the screen. Review this log to troubleshoot problems.



To view error messages

- Double click the Error icon in the lower left corner of the RAV window.

To clear error messages

- Click Clear.

 **Note:** Errors can be tracked using the Event Log.

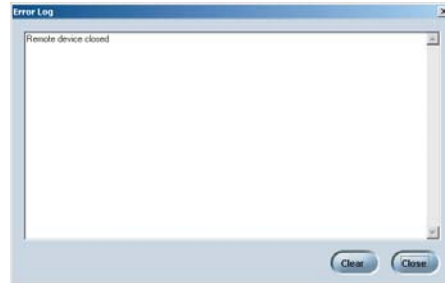



Figure 3.33. Error log

Firmware upgrades

Firmware upgrades are included with any updated RAV-Ware release. Once the RAV-Ware update has been installed, you should upgrade the firmware. Firmware can be upgraded through the network, serial or USB connection.

To open the RAV Firmware Loader

- Click the Firmware Loader icon on the toolbar.

 **Note:** This option is only available when you are connected to a RAV unit.

To upgrade RAV firmware

1. Click **File**.
2. Browse to the correct folder located in RAV-Ware firmware.
3. Click **Open**.
4. Click the **Update** button.
The File Transfer Progress bar will indicate when the firmware has been uploaded.

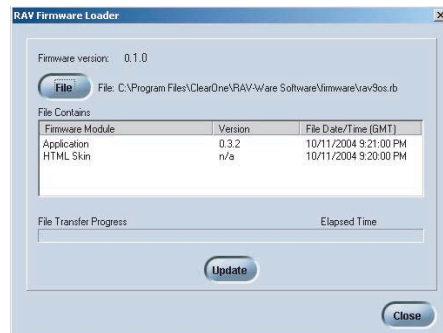

Figure 3.34. Firmware upgrades

Device Toolbox Editor

The Device Toolbox Editor allows you to add your auxiliary devices to RAV-Ware. You can add video codecs, sound cards, record/playback devices and amplifiers to customize your system and easily access these devices for future RAV installations.

To open the Device Toolbox Editor

- From the Tools menu, select **Edit Device list**

Right-click on the Device Toolbox pane and click **Device Toolbox Editor**.

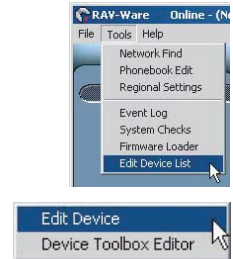

To add a device

1. Click **Add**.
2. Select the **Device Type** from the Device Type list.
3. Enter the **Name** of the Manufacturer.
4. Enter the **Model Number** of the device.
5. Enter the **Equalization** levels and the **Gain** settings.
6. Click **OK**. The new device will appear in the Toolbox Editor window and in the Device Toolbox.



Figure 3.35. Toolbox Editor

To edit a device

1. In the Device Toolbox Editor, select the device you want to modify.
2. Click **Edit**.
3. Change any information.
4. Click **OK**.

 **Tip:** You can also double click the device in the Device Toolbox pane to edit.

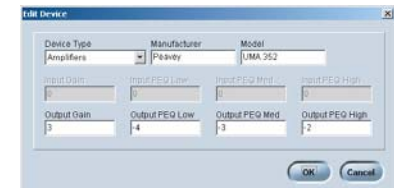

Figure 3.36. Edit device

To delete a device

1. In the device list, click the device you want to delete.
2. Click **Delete**.
3. Confirm that you want to delete the device.

Using the RAV

4

Using the Controller

Managing Calls

Most phone specific functions, such as dialing a call or adding a phonebook entry, will be managed from the controller. Phonebook and dialer actions can be done through Rav-Ware as well. See page 39 for more information.

To answer a call

 **Note:** RAV can also be set to Auto-Answer. See page 53 to enable Auto-Answer.

- Press  on the controller to answer the call. When there is an incoming call, the phone rings and the LEDs on the microphones flash.

To make a call

- Press . You will hear a dial tone.
- Dial the number as you would on a standard phone. The number appears on the LCD screen.

 **Note:** The LCD has an entry maximum of 44 characters

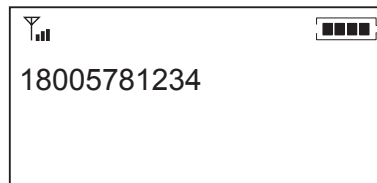



Figure 4.1. Dialing window

To pre-dial a call

- Dial a phone number.
You can press  to delete the last digit entered in the pre-dialing string.

 **Note:** The phonebook key will delete the entire dial string if you press it for two seconds. Pressing and holding the pound (#) key for 2 seconds will insert a pause into the dialing string. The duration of the pause is two seconds.

- Press  to send the call.



To end a call

 **Note:** RAV can also be set to Auto-Disconnect. See page 54 to enable Auto-Disconnect.

- Press  to disconnect the call.

To mute/unmute microphones

 **Note:** This function mutes all microphones in the room. The microphone LEDs and the mixer front panel LEDs light red when the microphones are muted.

- Press  to mute the microphones. The Microphone LEDs will light red.
- Press  again to unmute microphones. The microphone LEDs will light green.

To use speed dial

- Press and hold the assigned speed dial number on the dial pad.



Note: You can dial numbers 1-9 by pressing and holding the assigned number. To dial speed dial 10, press and hold 0.

To redial a phone number

- Press .

 **Note:** REDIAL saves the last number that was dialed. Once REDIAL is pressed, the phone will be taken off hook and the number will be dialed.

To dial a call from the Phonebook

- Press  on the controller.
- Scroll to the entry and press .
- Press  to dial the number.

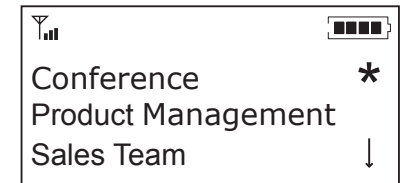

Figure 4.2. Dialing from the phonebook

To use the status key

- Press and hold  for two seconds to display the status of the RAV.

If the phone is not in use (on-hook) the LCD will display the device name, the date and time and the local number.

If the phone is in use (off-hook), the LCD will display the call duration, the date and time and the dialed number.

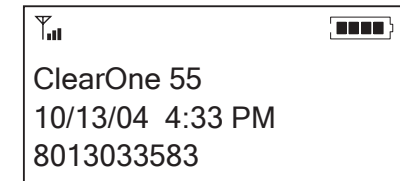

Figure 4.3. On hook status

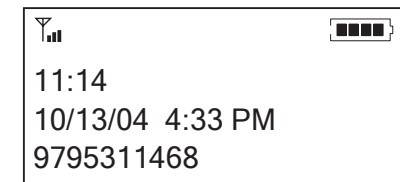





Figure 4.4. Off hook status

To send a flash signal

- Press  to use call transfer, call waiting or conference calling.

 **Note:** This setting is dependent on your PBX service or local phone service. Refer to your PBX vendor or local telephone service for details.

To adjust the speaker volume

- Press  to increase the volume.

– or –

- Press  to decrease the volume.

Programming Phone Preferences

You can manage the phonebook, adjust phone settings such as ring melody and tone and set preferences such as country codes and language through the menu options outlined below. You can also program these preferences in the RAV-Ware software. Refer to Chapter Three for more information on RAV-Ware.

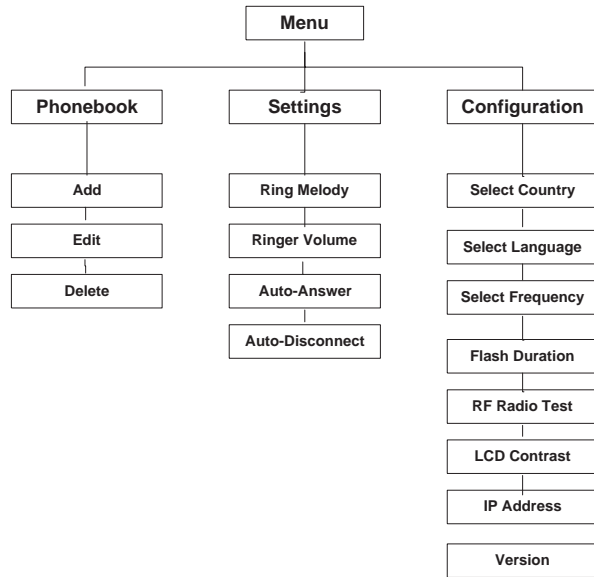

Figure 4.5. Menu tree

Accessing the menu

The main menu gives you three options: Phonebook, Settings and Configuration. An asterisk * indicates your position in the menus and a down arrow ↓ indicates that the menu continues. Once in menu mode use the arrow keys to navigate. moves the cursor to the right. is a backspace key. is a delete key or a back key that moves you to the previous screen. saves entries and moves the cursor to the next line.

To access the menu

- Press on the controller to access the RAV program menu.

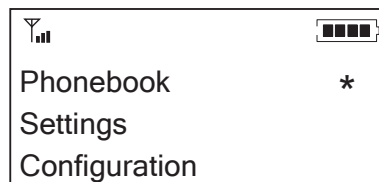

Figure 4.6. Main Menu

Using the Phonebook from the controller

The Phonebook stores up to 20 names and numbers. You can add, edit and delete any of the contacts.

To add a Phonebook entry

- Press to access the menu options.
 - Press to select Phonebook.
 - Press again to select Add.
 - Type the Name using the keypad.
- Note:** Press a keypad key repeatedly to cycle through its characters.
- Press to advance to the Number field.
 - Type the number using the keypad.

- Press to advance to the Save option.
- Press again to save the entry and return to the Phonebook menu.

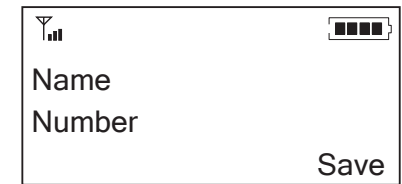

Figure 4.7 Adding a contact

- Note:** Entries added to the phonebook through the controller are assigned speed dial number 0. This means there is no speed dial associated with this number. You must use RAV-Ware to change this. See page 39 for information.

To edit a Phonebook entry

- Press to access the menu options.
- Press to select Phonebook.
- Scroll to Edit and press .
- Scroll to a desired name and press .
- Make changes to the name and number using the keypad.

- Press to advance to the Save option.
- Press again to save the changes and return to the Phonebook menu.

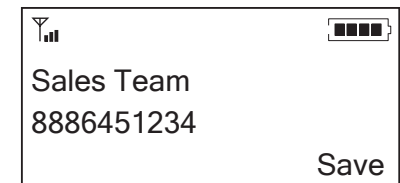

Figure 4.8. Editing a contact

To delete a Phonebook entry

- Press to access the menu options.
- Scroll to Delete and press .
- Choose the entry you want to delete.
- Press to delete the entry and return to the Phonebook menu.

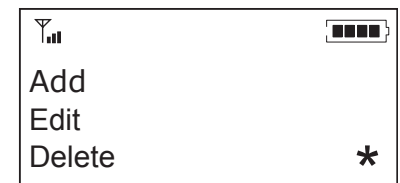



Figure 4.9. Deleting a contact

Adjusting the Settings

You can activate the auto-answer setting, activate auto-disconnect, select ringer melodies and adjust your ringer in the Settings menu.

To select a Ring Melody

1. Press **M** to access the menu options.
2. Scroll to Settings and press **M**.
3. Press **M** again to select Ringer Melody.
4. Select one of the three ringer melodies.
5. Press **M** to save the selection and return to the Settings menu.

 **Note:** Once you select a melody, you will hear it played through the speakers.

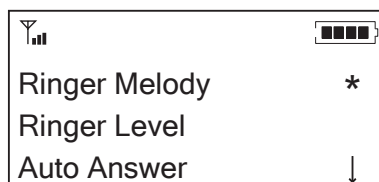

Figure 4.10. Ringer melody

To adjust the Ringer Volume

1. Press **M** to access the menu options.
2. Scroll to Settings and press **M**.
3. Scroll to Ringer Level and press **M**.
4. Use **◀** or **▶** to adjust the volume.
5. Press **M** to save and return to the Settings menu.

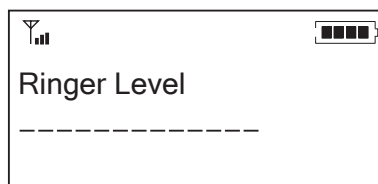



Figure 4.11. Ringer level

 **Note:** Ringer volume is indicated by a horizontal bar on the LCD screen.

To activate Auto-Answer

1. Press **M** to access the menu options.
2. Scroll to Settings and press **M**.
3. Scroll to Auto Answer and press **M**.
4. Select After 2 Rings or After 4 Rings -Or- Select Disable to deactivate the Auto Answer function.
5. Press **M** to save selection and return to the Settings menu.



Figure 4.12. Auto answer

To activate Auto-Disconnect

1. Press **M** to access the menu options.
2. Scroll to Settings and press **M**.
3. Scroll to Auto Disconnect and press **M**.
4. Select Enable or Disable.
5. Press **M** to save selection and return to the Settings menu.

 **Note:** When enabled, Auto-Disconnect will automatically hang up the phone once the other end is disconnected.

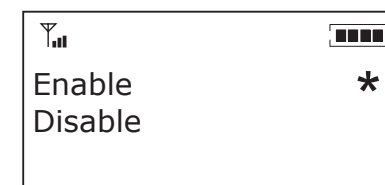

Figure 4.13. Auto disconnect

Configuration

The configuration menu provides options for selecting countries, languages and RF frequencies, as well as configuring the Flash setting.

To select a Country

1. Press **M** to access the menu options.
2. Scroll to Configuration and press **M**.
3. Press **M** again to select Country.
4. Select a country from the list of available countries.
5. Press **M** to save the country selection and return to the Configuration menu.



Figure 4.14. Select a country

 **Note:** This assigned the telco for the specific country settings.

To select a Language

1. Press **M** to access the menu options.
2. Scroll to Configuration and press **M**.
3. Scroll to Language and press **M**.
4. Select a language from the list.
5. Press **M** to save the language and return to the Configuration menu.

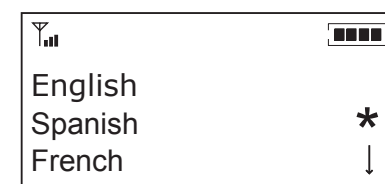



Figure 4.15. Select a language

To select a Frequency

1. Press **M** to access the menu options.
2. Scroll to Configuration and press **M**.
3. Scroll to Frequency and press **M**.
4. Choose a frequency from 1–8.
5. Press **M** to save the frequency and return to the Configuration menu.

 **Note:** The channel frequency allows the mixer to communicate with the controller. The frequency in RAV-Ware must match the RAV controller frequency. See page 28.

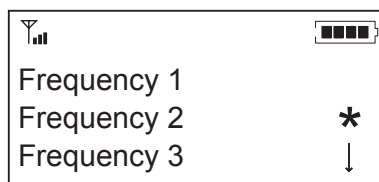



Figure 4.16. Select a frequency

 **Note:** When using the RAV 900, frequency 1 and frequency 8 are the same channel.

To enter Flash Duration

1. Press **M** to access the menu options.
2. Scroll to Configuration and press **M**.
3. Scroll to Flash Duration and press **M**.
4. Type the duration number from 50–1000.
5. Press **M** to save the duration and return to the Configuration menu.

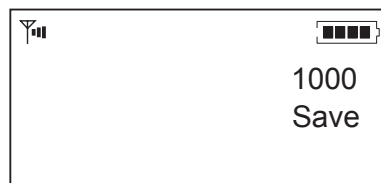



Figure 4.17. Enter flash settings

To perform RF Radio Test

1. Press **M** to access the menu options.
2. Scroll to Configuration and press **M**.
3. Scroll to RF Radio Test and press **M**.
4. Press **M** to exit and return to the Configuration menu.

 **Note:** The RAV controller will send out a radio signal and display the signal strength between the controller and the mixer. Use this feature to ensure the mixer and controller are set to the same frequency and to verify signal strength.

 **Attention:** If you are having trouble with the communication between the controller and the mixer, refer to the Troubleshooting guide for tips on improve signal strength.

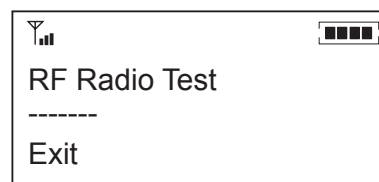

Figure 4.18 RF Radio test

To change LCD Contrast

1. Press **M** to access the menu options.
2. Scroll to Configuration and press **M**.
3. Scroll to Contrast and press **M**.
4. Scroll to the contrast from 0–3.
5. Press **M** to select the contrast and return to the Configuration menu.

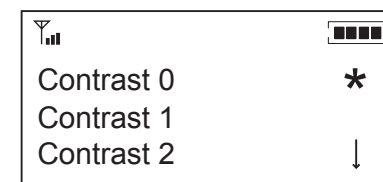

Figure 4.19 Contrast

To view the IP address

1. Press **M** to access the menu options.
2. Scroll to Configuration and press **M**.
3. Scroll to IP Address and press **M**.

 **Note:** The IP address for the RAV unit will display on the LCD

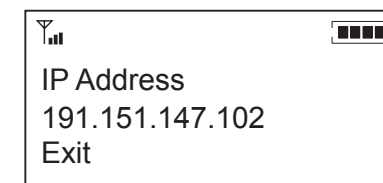

Figure 4.20 Contrast

To check the RAV Version

1. Press **M** to access the menu options.
2. Scroll to Configuration and press **M**.
3. Scroll to Version and press **M**. The version of the RAV controller firmware will display.
4. Press **M** to exit and return to the Configuration menu.

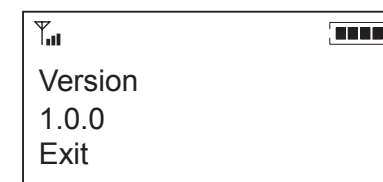

Figure 4.21 Version

Web Interface

5

Overview

Accessing the web interface

The RAV has a built-in web server that provides a remote access interface to your RAV system. However, not all programming and metering functions are available. The web interface allows you to connect to a RAV unit, run system checks, view the event log and manage calls.

To use the web interface from outside your network, your firewall must be properly configured to allow access. If you are accessing RAV from within the network, you may use the network name. The web interface uses port 80.

To connect to RAV through the web interface

1. Open a web browser and enter the IP address or Network Name of the RAV in the address bar.
2. Enter your User name and Password. The default user name is ClearOne and the default password is RAV.

Figure 5.1 Network Password

The RAV web interface opens. Navigation buttons are shown in the left channel.



Figure 5.2 RAV-Ware management system

Dial

You can make all your calls from the Dialer in the web interface. You can dial a number, redial the last dialed call, and disconnect calls. You can also use flash settings, mute the microphones and adjust volume.

To open the dialer window

- Click the Dial button in the left channel navigation.



Figure 5.3. Dialer window

To make a call

1. Click the ON/Off button to take the phone off-hook.
2. Using the number pad, dial a phone number just as you would on a phone.

 **Note:** You can also pre-dial the number and click the ON/OFF button to connect the call. Click the pound button (#) to enter a pause in the dialing string.

Tip: You can also dial using the 0-9, * and # on your keyboard. Enter connects to and disconnects from the telephone line.

To make a call from the phonebook

1. Click a number in the phonebook you want to call.
The name and number appear in the display window.
2. Click **ON/OFF** button to dial the call.

To end a call

- Click the **ON/OFF** button.

To redial

- Click the **REDIAL** button.
The phone will automatically be taken off hook and the last dialed number will be called.

To send a Flash signal

- If your telephone service includes call transfer, call waiting or conference calling, you can use the Flash key. Refer to your local telephone service for details.

To mute/unmute

1. Press the **MUTE** button to mute all microphones.
2. Press the **MUTE** button again to unmute all the microphones.

To adjust call volume

- Use the **UP** and **DOWN** volume buttons to adjust the volume to the desired level.

Event Log

The Event Log keeps record of a user selectable list of events. You select the events you want recorded in RAV-Ware. You then can download the log for review in the web interface. Check the Event Log when there are communication errors or for other troubleshooting.

To open event log

- Click the **Event Log** button in the menu pane.



Figure 5.4. Event log

To clear log

- Click the **Clear Log** button.

To download log

- Click the **Download Log** button.

System Check

The System Diagnostic window allows you to check your RAV system to be sure all parts of your system are connected and working properly.

To open the System Diagnostics

- Click the System Diagnostics button.



Figure 5.5. System Diagnostics

To run System Diagnostics

- Click the Start button.

RAV checks all components. When the check is complete, lights will indicate the status of each component. Green indicates the part is connected and functioning. Red indicates a problem with the component.

Log Out

- Click the Log Out button.

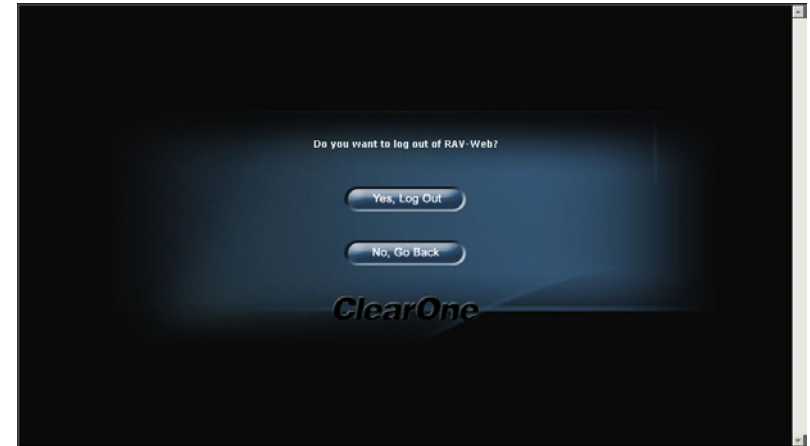

Figure 5.6. Log out

- Click Yes to log out.
- Click No to stay logged in.

Maintenance

Unplug all components before cleaning. Do not use liquid or aerosol cleaners. Use a soft, damp cloth to clean the microphones and controller.

If storing for an extended period of time, remove the batteries.

Troubleshooting

Audio

No dial tone

Check that the RH-11 cable is connected to an analog line. Make sure the phone cable is connected to the Line jack, not the Set jack. If you are connected to a digital line through a telephone handset, take the handset off the hook. Run a system diagnostic check through RAV-Ware to be sure all RAV components are working properly.

Rav does not ring

Adjust the volume of the ringer. Check that the RH-11 cable is connected. Verify that the dialed phone number is correct.

Muffled reception

Do not move the microphone pods while on a call. Move any items that might be blocking the microphones. Speak closer to the microphones.

Far-end party cannot hear

Check the connections of all audio inputs. Check the Audio Mixer in RAV-Ware to make sure the correct audio paths are selected. Adjust the volume of the audio outputs.

Short silences, echoes or clipped speech on the far end

Adjust the equalization in RAV-Ware for each component.

Adjust the volume. Watch the meters. Make sure the loudest audio causes the meters to just enter the yellow zone.

Be sure equipment is placed correctly for the best sound performance. Refer to the chapter one for basic room design guidelines.

Controller

Controller doesn't communicate to the mixer.

Be sure the frequency setting on the controller is the same as the frequency setting in RAV-Ware. Change the frequency for both to avoid frequency conflicts with other RAV systems. Perform an RF radio test to verify the signal strength between the controller and the mixer.

The RAV Controller performs best when the RAV Mixer is positioned within line of sight and with the antenna pointed up. Check the signal strength indicator in different areas of the room to find the best possible operating location. The signal strength indicator is on the LCD screen and the maximum number of bars is four.

For optimal RF connectivity, make sure the signal strength measures three or four bars in the operating location. You can also use the RF Radio Test function on the controller for a more detailed signal strength measurement.

To improve signal strength

- Verify that the mixer is within line of site
- Ensure the antenna is pointed up
- Do not install the mixer in a metal cabinet

You can also purchase a remote mount antenna to improve the signal strength when the mixer is located in a different room or an enclosed cabinet.

Cannot assign a speed dial number

Any phone numbers entered using the controller are automatically assigned a speed dial of none. Access RAV-Ware to assign speed dial numbers

Speakers

Neither speakers play

Check that the wires are properly connected. Check the audio mixer in RAV-ware to ensure the audio is routed correctly.

Bass and treble are weak

Check the equalization for the loudspeakers in RAV-Ware.

Only one speaker plays

Check the equalization for the loudspeakers in RAV-Ware. Check the wires connected to the speaker that does not play. Be sure the wires are in good condition and are firmly connected.

One speaker still does not play

Disconnect the wires from both the speaker and the mixer. Disconnect the other cord from its speaker and connect that end of the cord to the speaker that doesn't play. If the speaker still doesn't play, the problem is in the speaker. If the speaker now plays, continue checking for the source of the problem. Disconnect the same cord from the mixer. Connect it to another output. If the speaker plays, the problem is the original cord that was connected to that speaker.

General

Physical damage to RAV

All repairs must be done by a ClearOne technician. Call ClearOne technical support for more information.

Pinouts

Camera pinouts

8 Pin Mini DIN connector

Pin Number	Control	Pin Number	Control
1	RTS	5	RXD
2	CTS	6	TXD
3	TXD	7	not used
4	GND	8	not used

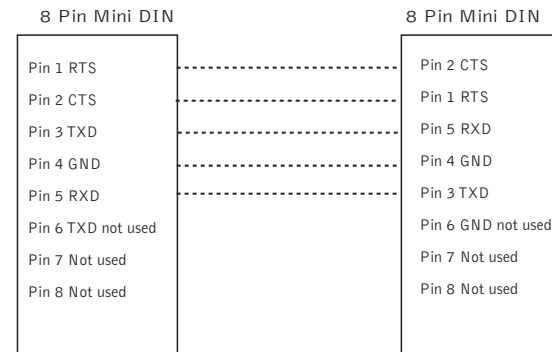

DB-9 connector

Pin Number	Control	Pin Number	Control
1	CD	6	DSR
2	RXD	7	RTS
3	TXD	8	CTS
4	DTR	9	RI

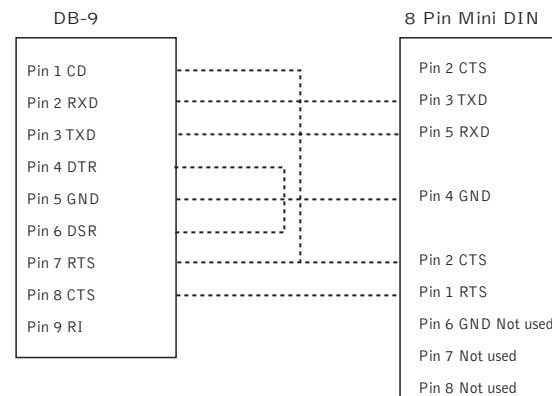
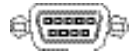

Specifications

Dimensions

Mixer (WxDxH)

17" x 7.5" x 2"
(43.2 cm x 19.1 cm x 5.1 cm)

RF Controller (WxDxH)

10.5" x 4.5" x 2.75"

Microphone Pod

Diameter 7" (17.8 cm)
Height 1.5" (3.8 cm)

Weight

Mixer 4.5 lbs (2.04 kg)
RF Controller 2.0 lbs (.91 kg)
Microphone Pod 1.1 lbs (.5 kg)

Environmental

Operating Temperature:
32° to 122° F
0° to 50° C

Power Supply

Primary Voltage: 100 to 240 VAC Auto sensing
50-60 Hz

Audio Performance

Conditions: Unless otherwise specified, all measurements are performed with a 22 Hz to 15 kHz BW limit (no weighting)

Microphone Pod

Coverage: 360 degrees
Connection: RH-45 with Cat. 5, Link In/Out Ports

Max Distance from Base Mixer:

50' (RAV 900), 75' (RAV 600)
Frequency Response: 60 Hz - 14 kHz (+/-1dB)
THD+N: < 0.08% (-45dBu input @ 1 kHz)
Sensitivity: -45 dBu
Input Level: -6 dBu for 1 kHz 94 dB SPL microphone input
Dynamic Range: > 65dB

Line Input

Connection: Unbalanced RCA
Gain: -10 dBu nominal, adjustable from -14 dB to +18 dB
Nominal Level: -10 dBu
Maximum Level: +9 dBu
Impedance: > 10 kOhm

Line Output

Connection: Unbalanced RCA
Nominal Level: -10 dBu, adjustable from -14 dB to +18 dB
Maximum Level: +9 dBu
Frequency Response: 40 Hz - 15 kHz (+/-1dB)
Dynamic Range: > 80 dB
THD+N: < 0.02% (+6 dBu input @1 kHz)

Playback/Record Input

Connection: Unbalanced RCA
Gain: -10 dBu nominal, adjustable from -14 dB to +18 dB
Nominal Level: -10 dBu
Maximum Level: +9 dBu
Impedance: > 10 kOhm

Playback/Record Output

Connection: Unbalanced RCA
Nominal Level: -10 dBu, adjustable from -14 dB to +18 dB
Maximum Level: +9 dBu
Frequency Response: 40 Hz - 15 kHz (+/-1dB)
Dynamic Range: > 80 dB
THD+N: < 0.02% (+6 dBu input @1 kHz)

Loudspeaker

Connection: Push terminals with left and right
Power: 10 Watts into 8 Ohm load
Impedance: 8 ohm
Frequency Response: 60 Hz - 15 kHz (+/-1 dB)
Dynamic Range: > 80 dB
THD+N: < 0.5% (+5 dBu line input @1 kHz)
Output Level: 90 dB SPL output @ 1 meter

Mixer

AEC tail time: 128 ms
Adaptive noise cancellation: (6 - 18 dB)
Gating: Adaptive ambient, 1st mic priority, look ahead gating, NOM attenuation,

Telephone Interface

Conditions: All measurements taken with ALC disabled.
Connection: RH-11 (Set and Line Jacks)
Tail Time: 30 ms
Frequency Response: 250 Hz to 3.3 kHz (+/-1 dB)
THD+N: < 0.2% (+7 dBu line input @1 kHz)
Dynamic Range: > 60 dB

Communication I/O

10/100 Ethernet Control Port:
RH-45 with LED indicators for link, duplex and activity status.

RS-232 Control Port:

DB9 female
9,600/19,200/38,400/57,600
(default)/115,200
baud rate: 8 bits, 1 stop, no parity
Hardware flow control on (default)/off

VISCA Camera Port:

DIN, 9600 baud, No Flow Control

USB 1.1 Configuration Port:

Slave Port

Serial Commands

The RAV 600 and RAV 900 accept serial commands through the telnet, RS-232 serial port or USB. The commands in this manual pertain only to the RAV 600 and RAV 900. RS-232 serial port protocol is 9,600, 19,200, 38,400 , 57,600 (default) or 115,200 baud; 8 bits, 1 stop bit, no parity.

Conventions

The following typographic conventions are used in this document to describe the different serial commands. Use the Command structure section and the examples as a guide when creating your serial commands.

Convention	Description
<X>	Parameters enclosed in < > indicate a mandatory parameter.
[X]	Parameters enclosed in [] indicate an optional parameter.
1-8	Parameters separated by a - indicate a range between the values.
4,7,9	Parameters separated by a , indicate a list of available values.
BAUD	Words in uppercase bold indicate command text.
<i>DEVICE</i>	Indicates the device type and device id.

Command structure

Commands can be either UPPER CASE or lower case. Also, extra spaces or tabs between arguments in text commands are allowed. Return values are always in upper case. In order for a command to be recognized by the serial port, the command must be terminated by a carriage return.

The structure of serial commands is as follows: #TYPE DEVICE COMMAND [X] [X]
 # indicates the start of a command line
 DEVICE represents the device type and device number
 COMMAND is the command text
 [X] [X] represents any additional options in the order that they appear in the command descriptions that follow
 * placed in the Type ID or Device ID fields, the command applies to all units or all devices respectively.

Example

A command to disable automatic gain control for Mic 2 on a RAV 600 device "0" will have the command line: #50 AGC 2 M 0. In this command line, 5=RAV 600, 0=unit 0, AGC=command, 2=channel, M=Mic Input group, 0=off state. If a command calls for a "null" value, leave a blank in the command line. For example, "#50 AGC 2 M" will return the current AGC state of Mic 2 on device 50.

Command responses will have a carriage return line feed.

Example: #50 AGC 2 M 0 carriage return line feed

Groups and channels

The following tables define the relationship between alpha and numeric representations. Text commands use the alpha designation and binary commands use the numeric. In addition, different groups have different allowable channel ranges.

Group	Alpha	Number	RAV 900 Channel Range	RAV 600 Channel Range
Unknown		0	N/A	N/A
Outputs	O	2	1 – 3 1 is Record Out 2 is Aux Out 3 is Speaker Out	1 – 3 1 is Record Out 2 is Aux Out 3 is Speaker Out
Microphone Pod	M	3	1 – 3	1 – 3
Line Inputs	L	7	1 – 2 1 is Record In 2 is Aux In	1 – 2 1 is Record In 2 is Aux In
Unit	U	9	0 for Unit Values 1 for Log	0
Matrix	X	11	0	0
	S	13	Phonebook	0
	N	15	2 for HTML skin 3 for Firmware 4 for Directory 5 for Firmware Data	1
Transmit	T	16	1	1
Receive	R	17	1	1
Local Camera	V	19	Sony Mode: 1–7 Canon Mode: 1–9	Sony Mode: 1–7 Canon Mode: 1–9

Type and device IDs

Type ID	Unit type	Device ID range
0x8	RAV 900	0x0
0x9	RAV 600	0x0

Meter type definitions

Alpha	Numeric	Level position for Mic Pods	Level position for Line Inputs	Level position for Outputs	Level position for Telco Transmits	Level position for Telco Receives
A	2	Maximum level of the three microphones on the pod after processing	Level after PEQ and gain	Level after PEQ and gain	Level after gain	Level after gain adjustment
R	5	Echo Return Loss	N/A	N/A	N/A	N/A
E	6	Echo Return Loss	N/A	N/A	N/A	N/A
T	7	ERL + ERLE	N/A	N/A	N/A	N/A

Serial command error codes

Error number	Text message	Explanation/Solution
1	Memory error	The box is out of internal memory. Power cycle the box.
2	No command found	A command was not found in the string.
3	Unknown command	A command was executed on a different device type that this box response can not display. The command dictionary needs to be updated.
4	Not implemented	The command is not implemented.
5	Argument error	The command had an argument that was out of range.
6	Unknown command	The command is unknown to this unit.
7	Bad checksum	The binary command's checksum is wrong.
8	Camera not responding	A preset or macro failed to program because it is too large or because its command list contained an invalid command.
11	Command too big	The binary command is too large.

RAV serial commands

Command	Function
AA	Selects/reports setting of auto answer
AARINGS	Selects/reports setting of the number of rings to auto answer
ACONN	Selects/reports status of audible connect/disconnect indication
AD	Selects/reports setting of auto disconnect
AEC	Selects/reports acoustic echo canceller setting
AECREF	Enables/disables or reports current status of AEC reference
AGC	Selects/reports AGC
BATTERYLVL	Reports battery level on remote
BAUD	Selects/reports the baud rate of the serial port
CALLDUR	Indicates how long a call has lasted
CAMBAUD	Selects/reports baud rate of camera control port
CAMCTRLMODE	Sets/reports camera control port mode
CAMFLOW	Selects/reports flow control of camera control port
CAMMOVE	Sends command to move the camera on the camera control port
CAMPRESET	Executes camera preset
CAMPRESETSET	Sets current position of camera as preset
CAMPRESETSET2	Sets/reports current camera preset
CAMPOSITION	Sets/reports current position of camera on the camera control port
CAMSWITCHLAG	Set the switch time lag for voice tracking
CAMTRACK	Selects/reports camera voice-tracking mode
CAMZOOM	Sets/reports current zoom of camera on the camera control port
CLEAREFFECT	Enables/disables or reports current status of clear effect
CLOCK	Sets/reports current time
COUNTRY	Sets/reports country for compliance.
DEFAULT	Sets the unit to default
DEVICE	Selects/reports manufacturer identification label
DIAL	Dials DTMF sequence or reports last sequence dialed
DID	Selects/reports device ID
ENETADDR	Selects/reports IP Address of the Ethernet port
ENETDHCP	Selects/reports use of DHCP of the Ethernet port/
ENETDNSA	Selects/reports DNS server IP address of the Ethernet port
ENETDNX	Selects/reports use of the DNS of the Ethernet port
ENETGATE	Selects/reports default gateway of the Ethernet port
ENETSUBN	Selects/reports subnet mask of the Ethernet port
EQ	Enables/disables or reports current status of equalization
EQSEL	Enables/disables or reports current status of equalization.
FLOW	Selects/reports the flow control of the serial port
GAIN	Changes/reports gain for a channel.
GATE	Reports gate status of microphones
GREPORT	Selects/reports gate status report frequency
HOOK	Sends a hook flash
HOOKD	Selects/reports hook flash duration

Command	Function
LABEL	Selects/reports label of specified channel or unit
LOCALNUM	Sets/reports current value of local number
LVL	Reports in, out, or processor level
LVLREPORT	Selects/reports level status
LVLREPORTEN	Enables/Disables level reporting
MANUFACTURER	Selects/reports manufacturer identification label
MICCAMPRESET	Associate a microphone with a camera preset
MTRX	Selects/reports matrix routing of an in. to out.
MUTE	Sets/reports mute status
NCSEL	Enables/Disables or reports current status of noise cancellation
PBDIAL	Dials speed dial number by name
PHONEBOOKADD	Saves entry in the phonebook
PHONEBOOKCNT	Queries number of entries in phonebook
PHONEBOOKDEL	Deletes an entry in the phonebook
PHONEBOOKREAD	Queries an entry in the phonebook
REDIAL	Redials last number called
RESET	Resets the unit
RFFREQ	Sets/reports frequency for RF link to remote.
RING	Indicates a ringing line.
RINGERLVL	Selects/reports audible ring level
RINGERSEL	Sends/reports audible ring melody
RINGertest	Plays current audible ringer melody
SILENCEPRST	Associates camera preset with silence for voice tracking
SPEEDDIAL	Dials speed dial number by speed dial number
STEREOMIX	Enables/disables or reports stereo mix status
SYSCHECKS	Initiates system checks
TE	Selects/reports hook status
TELCOLVLCtrl	Selects/reports setting of Telco TX level control
UID	Reports unit ID (read only)
VER	Reports unit version (read only)
VOLUME	Changes/reports the gain for the output channel

AA - Auto Answer Enable/ Disable

This command selects/reports the setting of auto answer.

ARGUMENT DETAILS

Name	Type	Size	Values	Units
Channel	Channel	1	See Group And Channels	
Group	Group	1	17 (R)	
Value	Unsigned Integer	2	0 = Off 1 = On 2 = Toggle (Null to query in text)	

BINARY FORM DETAILS

COMMAND ID: 28

NUMBER OF ARGUMENTS: 1

ARGUMENT FORM: <Channel><Group><Value>

TEXT FORM DETAILS

COMMAND FORM: DEVICE AA <Channel> [Value]

AARINGS - Number of Rings to Auto Answer On

This command selects/reports the setting of the number of rings to auto answer.

ARGUMENT DETAILS

Name	Type	Size	Values	Units
Channel	Channel	1	See Group And Channels	
Group	Group	1	17 (R)	
Value	Unsigned Integer	2	2 or 4 (Null to query in text)	

BINARY FORM DETAILS

COMMAND ID: 31

NUMBER OF ARGUMENTS: 1

ARGUMENT FORM: <Channel><Group><Value>

TEXT FORM DETAILS

COMMAND FORM: DEVICE AARINGS <Channel> [Value]

ACONN - Audible Connect / Disconnect Indication

This command selects/reports the status of the audible connect/disconnect indication.

ARGUMENT DETAILS

Name	Type	Size	Values	Units
Channel	Channel	1	See Group And Channels	
Group	Group	1	17 (R)	
Value	Unsigned Integer	2	0 = Off 1 = On 2 = Toggle (Null to query in text)	

BINARY FORM DETAILS

COMMAND ID: 96
 NUMBER OF ARGUMENTS: 1
 ARGUMENT FORM: <Channel><Group><Value>

TEXT FORM DETAILS

COMMAND FORM: DEVICE ACONN <Channel> [Value]

AD - Auto Disconnect Enable/ Disable

This command selects/reports the setting of auto disconnect.

ARGUMENT DETAILS

Name	Type	Size	Values	Units
Channel	Channel	1	See Group And Channels	
Group	Group	1	17 (R)	
Value	Unsigned Integer	2	0 = Off 1 = Loop Drop 2 = Call Progress 3 = Loop Drop + Call Progress (Null to query in text)	

BINARY FORM DETAILS

COMMAND ID: 29
 NUMBER OF ARGUMENTS: 1
 ARGUMENT FORM: <Channel><Group><Value>

TEXT FORM DETAILS

COMMAND FORM: DEVICE AD <Channel> [Value]

AEC - Acoustic Echo Canceller enable/ disable

This command selects/reports the setting of Acoustic Echo Canceller.

ARGUMENT DETAILS

Name	Type	Size	Values	Units
Channel	Channel	1	See Group And Channels	
Group	Group	1	3 (M)	
Value	Unsigned Integer	2	0 = Off 1 = On 2 = Toggle(Null to query in text)	

BINARY FORM DETAILS

COMMAND ID: 27
 NUMBER OF ARGUMENTS: 1
 ARGUMENT FORM: <Channel><Group><Value>

TEXT FORM DETAILS

COMMAND FORM: DEVICE AEC <Channel> [Value]

AECREF - Acoustic Echo Cancellation Reference

This command enables/disables or reports the current status of the AEC reference.

ARGUMENT DETAILS

Name	Type	Size	Values	Units
Value	Unsigned Integer	4	1 - 3 (Null to query in text)	

BINARY FORM DETAILS

COMMAND ID: 68
 NUMBER OF ARGUMENTS: 1
 ARGUMENT FORM: <Value>

TEXT FORM DETAILS

COMMAND FORM: DEVICE AECREF [Value]

AGC - Automatic Gain Control

This command selects/reports the setting of automatic gain control.

ARGUMENT DETAILS

Name	Type	Size	Values	Units
Channel	Channel	1	See Group And Channels	
Group	Group	1	3 (M)	
Value	Unsigned Integer	2	0 = Off 1 = On 2 = Toggle (Null to query in text)	

BINARY FORM DETAILS

COMMAND ID: 1
 NUMBER OF ARGUMENTS: 1
 ARGUMENT FORM: <Channel><Group><Value>

TEXT FORM DETAILS

COMMAND FORM: DEVICE AGC <Channel> <Group> [Value]

BATTERYLVL - Battery Level

This command reports the battery level on the remote. If the batteries run low, this command will automatically be sent out reporting the low indication.

ARGUMENT DETAILS

Name	Type	Size	Values	Units
Value	Unsigned Integer	4	0 = battery level unavailable 1 = Lowest 2 3 4 5 = Highest (Null to query in text.)	

BINARY FORM DETAILS

COMMAND ID: 65

NUMBER OF ARGUMENTS: 1

ARGUMENT FORM: <Value>

TEXT FORM DETAILS

COMMAND FORM: DEVICE BATTERYLVL [Value]

BAUD - Baud Rate

This command selects/reports the baud rate of the serial port.

ARGUMENT DETAILS

Name	Type	Size	Values	Units
Value	Unsigned Integer	4	9600, 19200, 38400, 57600, 115200 (Null to query in text)	

BINARY FORM DETAILS

COMMAND ID: 2

NUMBER OF ARGUMENTS: 1

ARGUMENT FORM: <Value>

TEXT FORM DETAILS

COMMAND FORM: DEVICE BAUD [Value]



Attention: If you are connected to the RAV unit through the serial port, you will need to reboot the unit before the baud rate and flow control changes take place. If you are connected to the RAV unit through the USB port, changes are made instantly.

CALLDUR - Call Duration

This command indicates how long a call has lasted. If no call is in session, this will report 0. At the time of call termination, this command will automatically be sent out reporting the duration.

ARGUMENT DETAILS

Name	Type	Size	Values	Units
Channel	Channel	1	See Group And Channels	
Group	Group	1	17 (R)	
Reserved		2	0	
Duration	String	8	String of format HR:MN:SS	

BINARY FORM DETAILS

COMMAND ID: 63

NUMBER OF ARGUMENTS: 3

ARGUMENT FORM: <Channel><Group><Reserved><Duration>

TEXT FORM DETAILS

COMMAND FORM: DEVICE CALLDUR <Channel> <Duration>

CAMBAUD - Camera Control Baud Rate

This command selects/reports the baud rate of the camera control serial port.

ARGUMENT DETAILS

Name	Type	Size	Values	Units
Value	Unsigned Integer	4	2400, 9600, 19200, 38400 (Null to query in text)	

BINARY FORM DETAILS

COMMAND ID: 60

NUMBER OF ARGUMENTS: 1

ARGUMENT FORM: <Value>

TEXT FORM DETAILS

COMMAND FORM: DEVICE CAMBAUD [Value]

CAMCTRLMODE - Camera Control Port Mode

This command sets/reports the camera control port mode.

ARGUMENT DETAILS

Name	Type	Size	Values	Units
Value	Unsigned Integer	4	0 = Sony 1 = Canon (Null to Query in Text)	

BINARY FORM DETAILS

COMMAND ID: 50

NUMBER OF ARGUMENTS: 1

ARGUMENT FORM: <Value>

TEXT FORM DETAILS

COMMAND FORM: DEVICE CAMCTRLMODE [Value]

CAMFLOW - Camera Control Flow Control

This command selects/reports the flow control of the camera control serial port on the unit. Hardware flow control is implemented using DTR and DSR.

ARGUMENT DETAILS

Name	Type	Size	Values	Units
Value	Unsigned Integer	4	0 = Off 1 = On 2 = Toggle (Null to query in text)	

BINARY FORM DETAILS

COMMAND ID: 61
NUMBER OF ARGUMENTS: 1
ARGUMENT FORM: <Value>

TEXT FORM DETAILS

COMMAND FORM: DEVICE CAMFLOW [Value]

CAMMOVE - Move the Camera

This command sends commands to move the camera on the camera control port. There is no query for this command.

ARGUMENT DETAILS

Name	Type	Size	Values	Units
Channel	Channel	1	See Group And Channels	
Group	Group	1	19 (V)	
Value	Unsigned Integer	2	0 = Stop 1 = Pan Right 2 = Pan Left 3 = Tilt Up 4 = Tilt Down 5 = Zoom In 6 = Zoom Out	

BINARY FORM DETAILS

COMMAND ID: 49
NUMBER OF ARGUMENTS: 1
ARGUMENT FORM: <Channel><Group><Value>

TEXT FORM DETAILS

COMMAND FORM: DEVICE CAMMOVE <Channel Group> [Value]

CAMPRESET - Camera Preset

Executes a camera preset. There is no query for this command.

ARGUMENT DETAILS

Name	Type	Size	Values	Units
Value	Unsigned Integer	4	1 - 10	

BINARY FORM DETAILS

COMMAND ID: 51
NUMBER OF ARGUMENTS: 1
ARGUMENT FORM: <Value>

TEXT FORM DETAILS

COMMAND FORM: DEVICE CAMPRESET [Value]

CAMPRESETSET - Camera Preset Setup

This command sets the current position of a camera as a camera preset. There is no query for this command.

ARGUMENT DETAILS

Name	Type	Size	Values	Units
Preset	Unsigned Integer	2	1 - 10	
Channel	Channel	1	See Group And Channels	
Group	Group	1	19 (V)	
Label	String	16		

BINARY FORM DETAILS

COMMAND ID: 52
NUMBER OF ARGUMENTS: 5
ARGUMENT FORM: <Preset><Channel><Group><Label>

TEXT FORM DETAILS

COMMAND FORM: DEVICE CAMPRESETSET <Preset Channel Group Label>

CAMPRESETSET2 - Camera Preset Setup 2

This command sets or reports the current camera preset.

ARGUMENT DETAILS

Name	Type	Size	Values	Units
Preset	Unsigned Integer	2	1 - 10	
Channel	Channel	1	See Group And Channels	
Group	Group	1	19 (V)	
Pan Angle	Signed Float	2	If Sony, -100 to 100. If Canon, -100 to 100. (NULL to Query in Text)	Degrees
Tilt Angle	Signed Float	2	If Sony, -25 to 25. If Canon, -30 to 30.	Degrees
Zoom Angle	Signed Float	4	If Sony, 6.6 to 65. If Canon, 3 to 47.5.	Degrees
Label	String	16		

BINARY FORM DETAILS

COMMAND ID: 56
NUMBER OF ARGUMENTS: 7
ARGUMENT FORM: <Preset><Channel><Group><Pan><Tilt><Zoom><Label>

TEXT FORM DETAILS

COMMAND FORM: DEVICE CAMPRESETSET2 <Preset>[Channel Group Pan Tilt Zoom Label]

CAMPOSITION - Camera Position

This command sets or reports the current position of the camera on the camera control port.

ARGUMENT DETAILS

Name	Type	Size	Values	Units
Channel	Channel	1	See Group And Channels	
Group	Group	1	19 (V)	
Pan Angle	Signed Float	2	If Sony, -100 to 100. If Canon, -100 to 100. (NULL to Query in Text)	Degrees
Tilt Angle	Signed Float	4	If Sony, -25 to 25. If Canon, -30 to 30.	Degrees

BINARY FORM DETAILS

COMMAND ID: 53
NUMBER OF ARGUMENTS: 2
ARGUMENT FORM: <Channel><Group><Pan Angle><Tilt Angle>

TEXT FORM DETAILS

COMMAND FORM: DEVICE CAMPOSITON <Channel Group> [Pan Tilt]

CAMSWITCHLAG - Camera Switch Time Lag

This command set the switch time lag for voice tracking.

ARGUMENT DETAILS

Name	Type	Size	Values	Units
Value	Unsigned Float	4	0.00 - 5.00	S

BINARY FORM DETAILS

COMMAND ID: 76
NUMBER OF ARGUMENTS: 1
ARGUMENT FORM: <Value>

TEXT FORM DETAILS

COMMAND FORM: DEVICE CAMSWITCHLAG [Value]

CAMTRACK - Camera Track

This command selects/reports the camera voice tracking mode.

ARGUMENT DETAILS

Name	Type	Size	Values	Units
Value	Unsigned Integer	4	0 = Off 1 = On 2 = Toggle (Null to query in text)	

BINARY FORM DETAILS

COMMAND ID: 57
NUMBER OF ARGUMENTS: 1
ARGUMENT FORM: <Value>

TEXT FORM DETAILS

COMMAND FORM: DEVICE CAMTRACK [Value]

CAMZOOM - Camera Zoom

This command sets or reports the current Zoom of the camera on the camera control port.

ARGUMENT DETAILS

Name	Type	Size	Values	Units
Channel	Channel	1	See Group And Channels	
Group	Group	1	19 (V)	
Zoom Angle	Signed Float	2	If Sony, 6.6 to 65. If Canon, 3 to 47.5. (NULL to Query in Text).	Degrees

BINARY FORM DETAILS

COMMAND ID: 54
NUMBER OF ARGUMENTS: 1
ARGUMENT FORM: <Channel><Group><Zoom Angle>

TEXT FORM DETAILS

COMMAND FORM: DEVICE CAMZOOM <Channel Group> [Zoom]

CLEAREFFECT - Clear Effect Wide Band Telco Emulation

This command enables/disables or reports the current status of the clear effect.

ARGUMENT DETAILS

Name	Type	Size	Values	Units
Channel	Channel	1	See Group And Channels	
Group	Group	1	17 (T)	
Value	Unsigned Integer	2	0 = Off 1 = On 2 = Toggle (Null to query in text)	

BINARY FORM DETAILS

COMMAND ID: 66
 NUMBER OF ARGUMENTS: 1
 ARGUMENT FORM: <Channel><Group><Value>

TEXT FORM DETAILS

COMMAND FORM: DEVICE CLEAREFFECT <Channel> [Value]

CLOCK - Clock Set

This command sets or reports the current time.

ARGUMENT DETAILS

Name	Type	Size	Values	Units
Date	Unsigned Integer	1	1 - 31	
Month	Unsigned Integer	1	1 - 12	
Year	Unsigned Integer	2	2000 - 2099 (NULL to Query in Text)	
Hours	Unsigned Integer	1	00 - 23	
Minutes	Unsigned Integer	1	00 - 59	
Seconds	Unsigned Integer	1	00 - 59	
Day of Week	Unsigned Integer	1	1 = Sunday 2 = Monday 3 = Tuesday 4 = Wednesday 5 = Thursday 6 = Friday 7 = Saturday	

BINARY FORM DETAILS

COMMAND ID: 64
 NUMBER OF ARGUMENTS: 2
 ARGUMENT FORM: <Date><Month><Year><Hours><Minutes><Seconds><Day>

TEXT FORM DETAILS

COMMAND FORM: DEVICE CLOCK [Date Month Year Hours Minutes Seconds Day]

COUNTRY - Country Selection

This command sets / reports the country for compliance.

ARGUMENT DETAILS

Name	Type	Size	Values	Units
Value	Unsigned Integer	4	1 = US / Canada 2 = Europe 3 = Mexico 4 = Australia / New Zealand 5 = South Africa 6 = Japan 7 = Brazil 8 = South Korea 9 = China 10 = Singapore 11 = Taiwan (Null to query in text)	

BINARY FORM DETAILS

COMMAND ID: 40
 NUMBER OF ARGUMENTS: 1
 ARGUMENT FORM: <Value>

TEXT FORM DETAILS

COMMAND FORM: DEVICE COUNTRY [Value]

DEFAULT - Default The Unit

Sets the unit to factory defaults. There is no query for this command.

ARGUMENT DETAILS

None

BINARY FORM DETAILS

COMMAND ID: 17
 NUMBER OF ARGUMENTS: 1
 ARGUMENT FORM: <0>

TEXT FORM DETAILS

COMMAND FORM: DEVICE DEFAULT

 **Attention:** The unit will need to be rebooted after sending the DEFAULT command.

DEVICE - Device Identification Label

This selects/reports the manufacturer identification label of the specific channel.

ARGUMENT DETAILS

Name	Type	Size	Values	Units
Channel	Channel	1	See Group And Channels	
Group	Group	1	2, 3, 7(0, M, L)	
Reserved	Unsigned Integer	2	0	
Label	String	32	1 - 32 characters CLEAR = clear the label (Null to query in text)	

BINARY FORM DETAILS

COMMAND ID: 82
NUMBER OF ARGUMENTS: 9
ARGUMENT FORM: <Channel><Group><Reserved><Value>

TEXT FORM DETAILS

COMMAND FORM: DEVICE **DEVICE** <Channel> <Group> [Value]

DIAL - DTMF Dialing

This command dials a DTMF sequence or reports back the last sequence dialed.

ARGUMENT DETAILS

Name	Type	Size	Values	Units
Channel	Channel	1	See Group And Channels	
Group	Group	1	17 (R)	
Reserved		2	0	
Number	String	44	1 - 44 Chars of '0' - '9', 'A' - 'D', '*', '#', '' (Null to query last number dialed in text)	

BINARY FORM DETAILS

COMMAND ID: 30
NUMBER OF ARGUMENTS: 12
ARGUMENT FORM: <Channel><Group><Number>

TEXT FORM DETAILS

COMMAND FORM: DEVICE **DIAL** <Channel> [Number]

DID - Device ID

This command reports the device id. This command is read only.

ARGUMENT DETAILS

Name	Type	Size	Values	Units
Value	Unsigned Integer	4	See Type And Device IDs (Null sent in text, Value returned)	

BINARY FORM DETAILS

COMMAND ID: 3
NUMBER OF ARGUMENTS: 1
ARGUMENT FORM: <Value>

ENETADDR - Ethernet port IP address

This command selects/reports the IP address of the Ethernet port on the unit.

ARGUMENT DETAILS

Name	Type	Size	Values	Units
Value	IP Address	4	(Null to query in text)	

BINARY FORM DETAILS

COMMAND ID: 21
TEXT FORM DETAILS
COMMAND FORM: DEVICE **DID** [Value]

NUMBER OF ARGUMENTS: 1
ARGUMENT FORM: <Value>

TEXT FORM DETAILS

COMMAND FORM: DEVICE **ENETADDR** [Value]

ENETDHCP - Ethernet DHCP Selection

This command selects/reports the use of DHCP of the Ethernet port on the unit.

ARGUMENT DETAILS

Name	Type	Size	Values	Units
Value	Unsigned Integer	4	0 = On 1 = Off 2 = Toggle (Null to query in text)	

BINARY FORM DETAILS

COMMAND ID: 25
NUMBER OF ARGUMENTS: 1
ARGUMENT FORM: <Value>

TEXT FORM DETAILS

COMMAND FORM: DEVICE **ENETDHCP** [Value]

ENETDNSA - Ethernet DNS Server addresses

This command selects/reports the DNS servers IP addresses of the Ethernet port on the unit.

ARGUMENT DETAILS

Name	Type	Size	Values	Units
Value	IP Address	4	(Null to query in text)	

BINARY FORM DETAILS

COMMAND ID: 24
NUMBER OF ARGUMENTS: 1
ARGUMENT FORM: <Value>

TEXT FORM DETAILS

COMMAND FORM: DEVICE **ENETDNSA** [Value]

ENETDNX - Ethernet DNS Selection

This command selects/reports the use of DNS of the Ethernet port on the unit.

ARGUMENT DETAILS

Name	Type	Size	Values	Units
Value	Unsigned Integer	4	0 = On 1 = Off 2 = Toggle (Null to query in text)	

BINARY FORM DETAILS

COMMAND ID: 26
NUMBER OF ARGUMENTS: 1
ARGUMENT FORM: <Value>

TEXT FORM DETAILS

COMMAND FORM: DEVICE ENETDNS [Value]

ENETGATE - Ethernet default Gateway address

This command selects/reports the default gateway of the Ethernet port on the unit.

ARGUMENT DETAILS

Name	Type	Size	Values	Units
Value	IP Address	4	(Null to query in text)	

BINARY FORM DETAILS

COMMAND ID: 23
NUMBER OF ARGUMENTS: 1
ARGUMENT FORM: <Value>

TEXT FORM DETAILS

COMMAND FORM: DEVICE ENETGATE [Value]

ENETSUBN - Ethernet subnet mask

This command selects/reports the Subnet mask of the Ethernet port on the unit.

ARGUMENT DETAILS

Name	Type	Size	Values	Units
Value	IP Address	4	(Null to query in text)	

BINARY FORM DETAILS

COMMAND ID: 22
NUMBER OF ARGUMENTS: 1
ARGUMENT FORM: <Value>

TEXT FORM DETAILS

COMMAND FORM: DEVICE ENETSUBN [Value]

EQ - Equalization

This command enables/disables or reports the current status of the equalization on the input or output.

ARGUMENT DETAILS

Name	Type	Size	Values	Units
Channel	Channel	1	See Group And Channels	
Group	Group	1	2, 7 (0, L)	
High Gain	Signed Float	2	-12.00 - 12.00 (Null to query in text)	
Mid Gain	Signed Float	2	-12.00 - 12.00	
Low Gain	Signed Float	2	-12.00 - 12.00	

BINARY FORM DETAILS

COMMAND ID: 67
NUMBER OF ARGUMENTS: 2
ARGUMENT FORM: <Channel><Group><High Gain><Mid Gain><Low Gain>

TEXT FORM DETAILS

COMMAND FORM: DEVICE EQ <Channel> <Group> [High Mid Low]

EQSEL - Equalization Enable

This command enables/disables or reports the current status of the equalization on the input or output.

ARGUMENT DETAILS

Name	Type	Size	Values	Units
Channel	Channel	1	See Group And Channels	
Group	Group	1	2, 7 (0, L)	
Value	Unsigned Integer	2	0 = Off 1 = On 2 = Toggle (NULL to query in text)	

BINARY FORM DETAILS

COMMAND ID: 74
NUMBER OF ARGUMENTS: 1
ARGUMENT FORM: <Channel><Group><Value>

TEXT FORM DETAILS

COMMAND FORM: DEVICE EQSEL <Channel> <Group> [Value]

FLOW - Flow Control

This command selects/reports the flow control of the serial port on the unit. Hardware flow control is implemented using DTR and DSR.

ARGUMENT DETAILS

Name	Type	Size	Values	Units
Value	Unsigned Integer	4	0 = Off 1 = On 2 = Toggle (Null to query in text)	

BINARY FORM DETAILS

COMMAND ID: 4
NUMBER OF ARGUMENTS: 1
ARGUMENT FORM: <Value>

TEXT FORM DETAILS

COMMAND FORM: DEVICE FLOW [Value]

GAIN - Gain Adjustment

This command changes or reports back the gain for a channel.

ARGUMENT DETAILS

Name	Type	Size	Values	Units
Channel	Channel	1	See Group And Channels	
Group	Group	1	2, 3, 7, 16, 17 (O, M, L, T, R)	
Value	Signed Float	2	-99.90 - 99.90 **(Null to query in text)	DB
Absol / Rel		0	A = Absolute R = Relative Null = Relative	

BINARY FORM DETAILS

COMMAND ID: 5
NUMBER OF ARGUMENTS: 1
ARGUMENT FORM: <Channel><Group><Value>

TEXT FORM DETAILS

COMMAND FORM: DEVICE GAIN <Channel> <Group> [Value] [Absol/Rel]

** Note: Values indicate entry range only. Actual internal range of the gain stage is from -14 to 18. Absolute values will be limited to the internal gain range.

GATE - Gate Status

This command reports the gate status of Mics. This command is read only.

ARGUMENT DETAILS

Name	Type	Size	Values	Units
Value	Hexadecimal	4	Bits 0 - 8 represent gate status on Mics 1 - 9 (Null sent in text, Value returned)	

BINARY FORM DETAILS

COMMAND ID: 6
NUMBER OF ARGUMENTS: 1
ARGUMENT FORM: <Value>

TEXT FORM DETAILS

COMMAND FORM: DEVICE GATE [Value]

GREPORT - Gate Report

This command selects/reports the mode of gate status reporting.

ARGUMENT DETAILS

Name	Type	Size	Values	Units
Value	Unsigned Integer	4	0 = Off 1 = On 2 = Toggle (Null to query in text)	

BINARY FORM DETAILS

COMMAND ID: 7
NUMBER OF ARGUMENTS: 1
ARGUMENT FORM: <Value>

TEXT FORM DETAILS

COMMAND FORM: DEVICE GREPORT [Value] **HOOK - Hook Flash**

This command sends a hook flash. There is no query for this command.

ARGUMENT DETAILS

Name	Type	Size	Values	Units
Channel	Channel	1	See Group And Channels	
Group	Group	1	17 (R)	
Reserved		2	0	

BINARY FORM DETAILS

COMMAND ID: 32
NUMBER OF ARGUMENTS: 1
ARGUMENT FORM: <Channel><Group><Reserved>

TEXT FORM DETAILS

COMMAND FORM: DEVICE HOOK <Channel>

HOOKD - Hook Flash Duration

This command selects/reports the hook flash duration.

ARGUMENT DETAILS

Name	Type	Size	Values	Units
Channel	Channel	1	See Group And Channels	
Group	Group	1	17 (R)	
Value	Unsigned Integer	2	50 - 1000 (Null to query in text)	Ms

BINARY FORM DETAILS

COMMAND ID: 33
NUMBER OF ARGUMENTS: 1
ARGUMENT FORM: <Channel><Group><Value>

TEXT FORM DETAILS

COMMAND FORM: DEVICE HOOKD <Channel> [Value]

LABEL - Label

This selects/reports the label of the specific channel or the unit.

ARGUMENT DETAILS

Name	Type	Size	Values	Units
Channel	Channel	1	See Group And Channels	
Group	Group	1	2, 3, 7, 9, 16, 17 (O, M, L, U, T, R)	
Reserved	Unsigned Integer	2	0	
Label	String	32	For group U, 1 - 11 characters All other, 1 - 32 characters If not group U, CLEAR = clear the label (Null to query in text)	

BINARY FORM DETAILS

COMMAND ID: 8
NUMBER OF ARGUMENTS: 9
ARGUMENT FORM: <Channel><Group><Reserved><Value>

TEXT FORM DETAILS

COMMAND FORM: DEVICE LABEL <Channel> <Group> [Value] **LOCALNUM - Local Number**

This command sets or reports back the current value of the local number.

ARGUMENT DETAILS

Name	Type	Size	Values	Units
Channel	Channel	1	See Group And Channels	
Group	Group	1	17 (R)	
Reserved		2	0	
Number	String	16	1 - 16 Chars of '0' - '9', 'A' - 'D', '*', '#', ' (Null to query in text)	

BINARY FORM DETAILS

COMMAND ID: 59
NUMBER OF ARGUMENTS: 5
ARGUMENT FORM: <Channel><Group><Number>

TEXT FORM DETAILS

COMMAND FORM: DEVICE LOCALNUM <Channel> [Number]

LVL - Level

This command reports the level of a channel. This command is read only.

ARGUMENT DETAILS

Name	Type	Size	Values	Units
Channel	Channel	1	See Group And Channels	
Group	Group	1	2, 3, 7, 16, 17(O, M, L, T, R)	
Position	Meter Type	2	See MeterTypeDefinitions	
Value	Signed Float	4	-99.99 - 99.99 (Sent with Null in text, Value returned)	DB

BINARY FORM DETAILS

COMMAND ID: 9
NUMBER OF ARGUMENTS: 2
ARGUMENT FORM: <Channel><Group><Position><Value>

TEXT FORM DETAILS

COMMAND FORM: DEVICE LVL <Channel> <Group> <Position> [Value]

LVLREPORT - Level Report

This command selects/reports the status of level reporting for the specified channel.

ARGUMENT DETAILS

Name	Type	Size	Values	Units
Channel	Channel	1	See Group And Channels	
Group	Group	1	2, 3, 7, 16, 17 (O, M, L, T, R)	
Position	Meter Type	2	See MeterTypeDefinitions	
Value	Unsigned Integer	4	0 = Off (Delete from list being reported) 1 = On (Add to list being reported) 2 = Toggle(Null to query in text)	

BINARY FORM DETAILS

COMMAND ID: 10
NUMBER OF ARGUMENTS: 2
ARGUMENT FORM: <Channel><Group><Position><Value>

TEXT FORM DETAILS

COMMAND FORM: DEVICE LVLREPORT <Channel> <Group> <Position> [Value]

Note: Level reporting for the unit must also be enabled (LVLREPORTEN).

LVLREPORTEN - Level Report Enable

Enables level reporting for the unit.

ARGUMENT DETAILS

Name	Type	Size	Values	Units
Value	Unsigned Integer	4	0 = Turn off reporting but leave current list 1 = Turn on reporting 2 = Turn off reporting and clear the list (Null to query in text)	

BINARY FORM DETAILS

COMMAND ID: 16
NUMBER OF ARGUMENTS: 1
ARGUMENT FORM: <Value>

TEXT FORM DETAILS

COMMAND FORM: DEVICE LVLREPORTEN [Value]

MANUFACTURER - Manufacturer Identification Label

This selects/reports the manufacturer identification label of the specific channel.

ARGUMENT DETAILS

Name	Type	Size	Values	Units
Channel	Channel	1	See Group And Channels	
Group	Group	1	2, 3, 7(O, M, L)	
Reserved	Unsigned Integer	2	0	
Label	String	32	1 - 32 characters CLEAR = clear the label (Null to query in text)	

BINARY FORM DETAILS

COMMAND ID: 81
NUMBER OF ARGUMENTS: 9
ARGUMENT FORM: <Channel><Group><Reserved><Value>

TEXT FORM DETAILS

COMMAND FORM: DEVICE MANUFACTURER <Channel> <Group> [Value]

MICCAMPRESET - Mic Camera Preset

This command associates a mic with a camera preset for voice tracking.

ARGUMENT DETAILS

Name	Type	Size	Values	Units
Channel	Channel	1	See Group And Channels	
Group	Group	1	3 (M)	
Value	Unsigned Integer	2	0 to Clear 1 - 10 (NULL to Query in Text)	

BINARY FORM DETAILS

COMMAND ID: 55
NUMBER OF ARGUMENTS: 1
ARGUMENT FORM: <Channel><Group><Value>

TEXT FORM DETAILS

COMMAND FORM: DEVICE MICCAMPRESET <Channel> [Value]

MTRX - Matrix Routing

This command selects/reports the matrix routing of an input to an output.

ARGUMENT DETAILS

Name	Type	Size	Values	Units
Source Channel	Channel	1	See Group And Channels	
Source Group	Group	1	3, 7, 17(M, L, R)	
Destination Channel	Channel	1	Group 3 (M) is only allowed all channels. All other groups cannot have the all channel. (See Group And Channels)	
Destination Group	Group	1	2, 16(O, T)	
Value	Unsigned Integer	4	0 = Cross point off 1 = Cross point on 2 = Toggle (Null to query in text)	

BINARY FORM DETAILS

COMMAND ID: 11
NUMBER OF ARGUMENTS: 2
ARGUMENT FORM: <Src. Ch.><Src. Gp.><Dest. Ch.><Dest. Gp.><Value>

TEXT FORM DETAILS

COMMAND FORM: DEVICE MTRX <Src. Ch.> <Src. Gp.> <Dest. Ch.> <Dest. Gp.> [Value]

MUTE - Mute

This command selects/reports the setting of mute on a channel.

ARGUMENT DETAILS

Name	Type	Size	Values	Units
Channel	Channel	1	See Group And Channels	
Group	Group	1	3 (M) (all channels only)	
Value	Unsigned Integer	2	0 = Off 1 = On 2 = Toggle (Null to query in text)	

BINARY FORM DETAILS

COMMAND ID: 12
NUMBER OF ARGUMENTS: 1
ARGUMENT FORM: <Channel><Group><Value>

TEXT FORM DETAILS

COMMAND FORM: DEVICE MUTE <Channel> <Group> [Value]

NCSEL - Noise Cancellation Select

This command enables/disables or reports the current status of noise cancellation.

ARGUMENT DETAILS

Name	Type	Size	Values	Units
Channel	Channel	1	See Group And Channels	
Group	Group	1	3,17 (M, R)	
Value	Unsigned Integer	2	0 = Off 1 = On 2 = Toggle (Null to query in text)	

BINARY FORM DETAILS

COMMAND ID: 62
NUMBER OF ARGUMENTS: 1
ARGUMENT FORM: <Channel><Group><Value>

TEXT FORM DETAILS

COMMAND FORM: DEVICE NCSEL <Channel> <Group> [Value]

PBDIAL - Dial a PB Entry by Name

This command dials a speed dial number by name. There is no query for this command.

ARGUMENT DETAILS

Name	Type	Size	Values	Units
Channel	Channel	1	See Group And Channels	
Group	Group	1	17 (R)	
Reserved	Unsigned Integer	2	0	
Label	String	16	1 - 16 chars	

BINARY FORM DETAILS

COMMAND ID: 36
NUMBER OF ARGUMENTS: 5
ARGUMENT FORM: <Channe><Group><Reserved><Label>

TEXT FORM DETAILS

COMMAND FORM: DEVICE PBDIAL <Channel> <Label>

PHONEBOOKADD - Adds an Entry to the Phonebook

This command saves an entry in the phonebook. There is no query. No two entries can share the same label. An argument error will be returned if an entry already has the name. To change an entry, you must first delete it and then add it again. If label is blank, the first 20 characters of the number will be used as the label. Number must not be blank. If an entry already exists with the assigned speed dial it will be overwritten. Speed Dial 34 is the conference number and is always stored first in the Phonebook. The rest of the entries are alphabetized base on Label.

ARGUMENT DETAILS

Name	Type	Size	Values	Units
Speed Dial	Unsigned Integer	4	0 for not assigned to a speed dial 1 - 19 20 for Conference	
Number	String	44	1 - 44 chars	
Label	String	16	'0' - '9', 'A' - 'D', '*', '#' 1 - 16 chars	

BINARY FORM DETAILS

COMMAND ID: 38
NUMBER OF ARGUMENTS: 16
ARGUMENT FORM: <ID><Number><Label>

TEXT FORM DETAILS

COMMAND FORM: DEVICE PHONEBOOKADD <ID Number Label>

PHONEBOOKCNT - Queries the Number of Entries in the Phonebook

This command queries the number of entries in the phonebook. This command is query only.

ARGUMENT DETAILS

Name	Type	Size	Values	Units
Value	Unsigned Integer	4	0 - 20	

BINARY FORM DETAILS

COMMAND ID: 78
 NUMBER OF ARGUMENTS: 1
 ARGUMENT FORM: <Value>

TEXT FORM DETAILS

COMMAND FORM: DEVICE PHONEBOOKCNT <Value>

PHONEBOOKDEL - Deletes an Entry to the Phonebook

This command deletes an entry in the phonebook. There is no query.

ARGUMENT DETAILS

Name	Type	Size	Values	Units
Label	String	16	1 - 16 chars	

BINARY FORM DETAILS

COMMAND ID: 77
 NUMBER OF ARGUMENTS: 4
 ARGUMENT FORM: <Label>

TEXT FORM DETAILS

COMMAND FORM: DEVICE PHONEBOOKDEL <Label>

PHONEBOOKREAD - Queries A Entry in the Phonebook By Index

This command queries an entry in the phonebook. This command is query only.

ARGUMENT DETAILS

Name	Type	Size	Values	Units
Index	Unsigned Integer	2	0 - 19 (Must be less than the Number of Phone Book Entries)	
Speed Dial	Unsigned Integer	2	0 for not assigned to a speed dial 1 - 1920 for Conference (NULL to query in text)	
Number	String	44	1 - 44 chars '0' - '9', 'A' - 'D', '*', '#'	
Label	String	16	1 - 16 chars	

BINARY FORM DETAILS

COMMAND ID: 79
 NUMBER OF ARGUMENTS: 16
 ARGUMENT FORM: <Index><Speed Dial><Number><Label>

TEXT FORM DETAILS

COMMAND FORM: DEVICE PHONEBOOKREAD <Index> [Speed Number Label]

REDIAL - Dial the last number again

This command redials the last number. There is no query for this command.

ARGUMENT DETAILS

Name	Type	Size	Values	Units
Channel	Channel	1	See Group And Channels	
Group	Group	1	17 (R)	
Reserved		2	0	

BINARY FORM DETAILS

COMMAND ID: 45
 NUMBER OF ARGUMENTS: 1
 ARGUMENT FORM: <Channel><Group><Reserved>

TEXT FORM DETAILS

COMMAND FORM: DEVICE REDIAL <Channel>

RESET - Reset

Resets the unit. There is no query for this command.

ARGUMENT DETAILS

None

BINARY FORM DETAILS

COMMAND ID: 20
 NUMBER OF ARGUMENTS: 1
 ARGUMENT FORM: <0>

TEXT FORM DETAILS

COMMAND FORM: DEVICE RESET

RETURN VALUES

The box is reset and the boot up message is displayed.

RFFREQ - RF Frequency Selection

This command sets / reports the frequency for the RF link to the Remote. The remote must be set to the same setting.

ARGUMENT DETAILS

Name	Type	Size	Values	Units
Value	Unsigned Integer	4	1 - 8 For Band 0, 1 = 904 MHz 2 = 907 MHz 3 = 910 MHz 4 = 913 MHz 5 = 916 MHz 6 = 919 MHz 7 = 922 MHz 8 = 926 MHz For Band 1, 1 = 868 MHz 2 = 868.333 MHz 3 = 868.667 MHz 4 = 869 MHz 5 = 869.333 MHz 6 = 869.667 MHz 7 = 870 MHz 8 = 868 MHz (Null to query in text)	

BINARY FORM DETAILS

COMMAND ID: 58
NUMBER OF ARGUMENTS: 1
ARGUMENT FORM: <Value>

TEXT FORM DETAILS

COMMAND FORM: DEVICE RFFREQ [Value]

RING - Ring Indication

This command indicates a ringing line. This command is reportable only. It cannot be queried or set.

ARGUMENT DETAILS

Name	Type	Size	Values	Units
Channel	Channel	1	See Group And Channels	
Group	Group	1	17 (R)	
Value	Unsigned Integer	2	0 = Ring cycle has stopped 1 = Ring cycle has begun	

BINARY FORM DETAILS

COMMAND ID: 34
NUMBER OF ARGUMENTS: 1
ARGUMENT FORM: <Channel><Group><Value>

TEXT FORM DETAILS

COMMAND FORM: DEVICE RING <Channel><Value>

RINGERLVL - Audible Ring Level

This command selects/reports the audible ring level. This command takes longer to execute due to RF communications with the remote controller

ARGUMENT DETAILS

Name	Type	Size	Values	Units
Channel	Channel	1	See Group And Channels	
Group	Group	1	17 (R)	
Value	Signed Float	2	-12.00 - 4.00 (dB) (Null to query in text)	

BINARY FORM DETAILS

COMMAND ID: 46
NUMBER OF ARGUMENTS: 1
ARGUMENT FORM: <Channel><Group><Value>

TEXT FORM DETAILS

COMMAND FORM: DEVICE RINGERLVL <Channel> [Value]

RINGERSEL - Audible Ring Melody Selection

This command sends/reports the audible ring melody. This command takes longer to execute due to RF communications with the remote controller

ARGUMENT DETAILS

Name	Type	Size	Values	Units
Channel	Channel	1	See Group And Channels	
Group	Group	1	17 (R)	
Value	Unsigned Integer	2	1 - 3 (Null to query in text)	

BINARY FORM DETAILS

COMMAND ID: 35
NUMBER OF ARGUMENTS: 1
ARGUMENT FORM: <Channel><Group><Value>

TEXT FORM DETAILS

COMMAND FORM: DEVICE RINGERSEL <Channel> [Value]

RINGERTEST - Audible Ring Melody Test

This command plays the current audible ringer melody. This command is executable only. There is no query.

ARGUMENT DETAILS

Name	Type	Size	Values	Units
Channel	Channel	1	See Group And Channels	
Group	Group	1	17 (R)	
Reserved	Unsigned Integer	2	0	

BINARY FORM DETAILS

COMMAND ID: 83
 NUMBER OF ARGUMENTS: 1
 ARGUMENT FORM: <Channel><Group><Reserved>

TEXT FORM DETAILS

COMMAND FORM: DEVICE RINGERTEST <Channel>

SILENCEPRST - Silence Camera Preset

This command associates a camera preset with silence for voice tracking.

ARGUMENT DETAILS

Name	Type	Size	Values	Units
Value	Unsigned Integer	4	0 to Clear 1 - 10 (NULL to Query in Text)	

BINARY FORM DETAILS

COMMAND ID: 75
 NUMBER OF ARGUMENTS: 1
 ARGUMENT FORM: <Value>

TEXT FORM DETAILS

COMMAND FORM: DEVICE SILENCEPRST [Value]

SPEEDDIAL - Speed Dialing

This command dials a speed dial number by speed dial number. There is no query for this command.

ARGUMENT DETAILS

Name	Type	Size	Values	Units
Channel	Channel	1	See Group And Channels	
Group	Group	1	17 (R)	
Value	Unsigned Integer	2	1 - 3334 for Conference	

BINARY FORM DETAILS

COMMAND ID: 37
 NUMBER OF ARGUMENTS: 1
 ARGUMENT FORM: <Channel><Group><Value>

TEXT FORM DETAILS

COMMAND FORM: DEVICE SPEEDDIAL <Channel> <Value>

STEREOMIX - Sets the Input to be a Stereo Mix

This command enables/disables or reports the stereo mix status of an input.

ARGUMENT DETAILS

Name	Type	Size	Values	Units
Channel	Channel	1	See Group And Channels	
Group	Group	1	7 (L)	
Value	Unsigned Integer	2	0 = On 1 = Off 2 = Toggle (NULL to query in text)	

BINARY FORM DETAILS

COMMAND ID: 86
 NUMBER OF ARGUMENTS: 1
 ARGUMENT FORM: <Channel><Group><Value>

TEXT FORM DETAILS

COMMAND FORM: DEVICE STEREOMIX <Channel> [Value]

SYSCHECKS - System Checks

Initiates the system checks. There is no query for this command.

ARGUMENT DETAILS

Name	Type	Size	Values	Units
System	HexadecimalInteger	4	00 - Pod 1 01 - Pod 2 02 - Pod 3 03 - Speaker 04 - Telephone 05 - Network 06 - RF Remote (not implemented) All other bits reserved	

Check Integer

BINARY FORM DETAILS

COMMAND ID: 87
 NUMBER OF ARGUMENTS: 1
 ARGUMENT FORM: <System Check>

TEXT FORM DETAILS

COMMAND FORM: DEVICE SYSCHECKS <System Check>

TE - Telco Enable

This command selects/reports the hook status.

ARGUMENT DETAILS

Name	Type	Size	Values	Units
Channel	Channel	1	See Group And Channels	
Group	Group	1	17 (R)	
Value	Unsigned Integer	2	0 = Off 1 = On 2 = Toggle (Null to query in text)	

BINARY FORM DETAILS

COMMAND ID: 39
NUMBER OF ARGUMENTS: 1
ARGUMENT FORM: <Channel><Group><Value>

TEXT FORM DETAILS

COMMAND FORM: DEVICE TE <Channel> [Value]

TELCOLVLCtrl - Telco TX Level Control Enable/ Disable

This command selects/reports the setting of Telco TX level control.

ARGUMENT DETAILS

Name	Type	Size	Values	Units
Channel	Channel	1	See Group And Channels	
Group	Group	1	17 (R)	
Value	Unsigned Integer	2	0 = Off 1 = On 2 = Toggle (Null to query in text)	

BINARY FORM DETAILS

COMMAND ID: 80
NUMBER OF ARGUMENTS: 1
ARGUMENT FORM: <Channel><Group><Value>

TEXT FORM DETAILS

COMMAND FORM: DEVICE TELCOLVLCtrl <Channel> [Value]

UID - Unit ID

This command reports the unit id. This command is read only.

ARGUMENT DETAILS

Name	Type	Size	Values	Units
Value	Hexadecimal	4	(Sent with a Null, value returned in text)	

BINARY FORM DETAILS

COMMAND ID: 13
NUMBER OF ARGUMENTS: 1
ARGUMENT FORM: <Value>

TEXT FORM DETAILS

COMMAND FORM: DEVICE UID [Value]

VER - Version

This command reports the version of the unit. This command is read only.

ARGUMENT DETAILS

Name	Type	Size	Values	Units
Value	String	8	Version of format MM.mm.rr (Sent with a Null in text, value returned)	

BINARY FORM DETAILS

COMMAND ID: 14
NUMBER OF ARGUMENTS: 2
ARGUMENT FORM: <Value>

TEXT FORM DETAILS

COMMAND FORM: DEVICE VER [Value]

VOLUME - Volume Adjustment

This command changes or reports back the gain for the output channel set as the EC reference.

ARGUMENT DETAILS

Name	Type	Size	Values	Units
Value	Signed Float	4	-99.90 - 99.90 ** (Null to query in text)	DB
Absol / Rel		0	A = Absolute R = Relative Null = Relative	

BINARY FORM DETAILS

COMMAND ID: 103
NUMBER OF ARGUMENTS: 1
ARGUMENT FORM: <Value>

TEXT FORM DETAILS

COMMAND FORM: DEVICE VOLUME [Value] [Absol/Rel]

** **Note:** Values indicate entry range only. Actual internal range of the gain stage is from -14 to 18. Absolute values will be limited to the internal gain range.

Compliance

FCC Part 15/ICES-003 Compliance

This equipment has been tested and found to comply with the limits for a Class A digital device, pursuant to Part 15 of the FCC rules and Industry Canada ICES-003. These limits are designed to provide reasonable protection against harmful interference when the equipment is operated in a commercial environment. This equipment generates, uses, and can radiate radio frequency energy and, if not installed and used in accordance with the instruction manual, may cause harmful interference to radio communications. Operation of this equipment in a residential area is likely to cause harmful interference, in which case the user will be required to correct the interference at his/her own expense.

This device complies with Part 15 of the FCC Rules. Operation is subject to the following two conditions: (1) this device may not cause harmful interference, and (2) this device must accept any interference received including interference that may cause undesired operation.

Changes or modifications not expressly approved by ClearOne Communications could void the user's authority to operate the equipment.

FCC Part 68 Compliance

US:FBIBR00BRAV Ringer Equivalence Number (REN): 0.0B(ac)

This equipment complies with Part 68 of the FCC Rules Requirements adopted by ACTA. On the mixer unit of this equipment contains, among other information, a product identifier in the format US:AAAEQ##TXXXX. If requested, this information must be provided to your telephone company.

The REN is used to determine the number of devices that may be connected to the telephone line. Excessive RENs on the telephone line may result in the devices not ringing in response to an incoming call. In most, but not all areas, the sum of the RENs should not exceed five (5.0). To be certain of the number of devices that may be connected to the line, as determined by the total RENs, contact the telephone company to obtain the maximum RENs for the calling area. The REN for this product is part of the product identifier that has the format US:AAAEQ##TXXXX. The digits represented by ## are the REN without a decimal point (e.g. 03 is a REN of 0.3).

If this equipment causes harm to the telephone network, the telephone company will notify you in advance that temporary discontinuance of service may be required. But if advance notice isn't practical, the telephone company will notify the customer as soon as possible. Also, you will be advised of your right to file a complaint with the FCC if you believe it is necessary.

The telephone company may make changes in its facilities, equipment, operations, or procedures that could affect the operation of the equipment. If this happens, the telephone company will provide advance notice in order for you to make the necessary modifications to maintain uninterrupted service.

A plug and jack used to connect this equipment to the premises wiring and telephone network must comply with the applicable FCC Part 68 Rules and Requirements adopted by the ACTA. A compliant telephone cord and modular plug is provided with this product. It is designed to be connected to a compatible modular jack that is also compliant. See installation instructions for details.

If you experience problems with this equipment, contact ClearOne Communications, 1825 Research Way, Salt Lake City, Utah 84119, or by phone at (800) 945-7730 for repair and warranty information. If the equipment is causing harm to the telephone network, the telephone company may request you disconnect the equipment until the problem is resolved.

No user serviceable parts are contained in this product. If damage or malfunction occurs, contact ClearOne Communications for instructions on its repair or return.

Connection to party line service is subject to state tariffs. Contact the state public utility commission, public service commission or corporation commission for information. This equipment cannot be used on telephone company provided coin service.

If your home has specially wired alarm equipment connected to the telephone line, ensure the installation of this equipment does not disable your alarm equipment. If you have questions about what will disable alarm equipment, consult your telephone company or a qualified installer.

Electrical Safety Advisory:

This equipment uses AC power which can be subjected to electrical surges, typically lightning transients which are very destructive to customer terminal equipment connected to AC power sources. The warranty for this equipment does not cover damage caused by electrical surge or lightning transients. To reduce the risk of this equipment becoming damaged it is suggested that the customer consider installing a surge arrester.

IC Compliance

IC: 1970A-RAV

Ringer Equivalence Number (REN): 0.0B(ac)

NOTICE: The term "IC" before the certification/registration number signifies that Industry of Canada technical specifications were met.

This certification means that the equipment meets certain telecommunications network protective operational and safety requirements. The Department does not guarantee the equipment will operate to the user's satisfaction.

The REN is used to determine the number of devices that may be connected to the telephone line. Excessive RENs on the telephone line may result in the devices not ringing in response to an incoming call. In most, but not all areas, the sum of the RENs should not exceed five (5.0). To be certain of the number of devices that may be connected to the line, as determined by the total RENs, contact the telephone company to obtain the maximum RENs for the calling area. The REN for this product is listed above.

Before installing this equipment, users should ensure that it is permissible to be connected to the facilities of the local telecommunications company. The equipment must also be installed using an acceptable method of connection. In some cases, the companies inside wiring associated with a single line individual service may be extended by means of a certified connector assembly (telephone extension cord). The customer should be aware that compliance with the above conditions may not prevent degradation of service in some situations.

Repairs to certified equipment should be made by an authorized Canadian maintenance facility designated by ClearOne Communications. Any repairs or alterations made by the user to this equipment, or equipment malfunctions, may give the telecommunications company cause to request the user to disconnect the equipment.

Users should ensure for their own protection that the electrical ground connections of the power utility, telephone lines and internal metallic water pipe system, if present, are connected together. This precaution may be particularly important in rural areas.

European Compliance

Conformity of the equipment with the guidelines below is attested by the CE mark.

EC Declaration of Conformity

Application of Council Directive(s):	1999/5/EC Radio equipment and Telecommunications Terminal Equipment (R&TTE) Directive
Manufacturer's Name:	ClearOne Communications
Manufacturer's Address:	1825 West Research Way Salt Lake City, Utah 84119 U.S.A.
Model Name:	RAV 600 & RAV 900
Model No.:	910-153-100 through 910-153-355

Standard(s) to which Conformity is declared:

89/336/EEC "Electromagnetic Compatibility (EMC) Directive":	
EN 301489-1 & EN 301489-3	ElectroMagnetic compatibility and Radio spectrum Matters (ERM); ElectroMagnetic Compatibility (EMC) standard for radio equipment and services; Part 3: Specific conditions for Short-Range Devices (SRD) operating on frequencies between 9 kHz and 40 GHz..
EN 61000-3-2:1995/A1/A2:1998	Part 3: Limits - Section 2: Limits for harmonic current emissions.
EN 61000-3-3:1995	Section 3: Limitation of voltage fluctuations and flicker in low voltage supply systems for equipment with rated current up to and including 16 A.
EN 55022: 1998 (Emissions)	Information technology equipment - Radio disturbance characteristics - Limits and methods of measurement.
EN 61000-4-2: 1995/A1:1998	Electrostatic Discharge
EN 61000-4-3: 1996/A1:1998	Radiated RF Immunity
EN 61000-4-4: 1995	Electrical Fast Transients
EN 61000-4-5: 1995	Lighting Surge
EN 61000-4-6: 1996	Conducted RF Immunity
EN 61000-4-11: 1994	Voltage Dips and Voltage Interruptions

Telecommunications Terminal Equipment:

73/23/EEC "Low Voltage Directive (LVD)":

IEC 60950-1: 2003 Safety of Information Technology Equipment, Including Electrical Business Equipment.

Radio Equipment:

EN 301 220-1 Electromagnetic compatibility and Radio Spectrum Matters (ERM); Short Range Devices (SRD); Radio equipment to be used in the 25 MHz to 1000 MHz frequency range with power levels ranging up to 500 mW; Part 1: Technical characteristics and test methods.

Telecommunications Terminal Equipment:

EN 301 437 (CTR-37) Terminal Equipment (TE); Attachment requirements for pan-European approval for connection to the analogue Public Switched Telephone Networks (PSTNs) of TE supporting the voice telephony service in which network addressing, if provided, is by means of Dual Tone Multi Frequency (DTMF) signaling.

Manufacturer



Signature

Roger J. Midgley

Full Name

Project Manager

Position

Legal Representative in Europe



Signature

Martin Offwood

Full Name

Managing Director EMEA North

Position

Table of Contents

Adjusting the Settings 56

Auto-Answer 56
Auto-Disconnect 57
Ring Melody 56
Ringer Volume 56

Basic Connections 14

Audio conferencing 14

Basic Room Design 7

loudspeaker placement 8
microphone placement 7

Calls 52

answer 52
end 52
from the Phonebook 53
make 52
pre-dial 52
redial 53
speed dial 53

Compliance 112

Configuration 57

Country 57
Flash Duration 58
Frequency 58
IP address 59
Language 57
LCD Contrast 59
RF Radio Test 58
Version 59

Connecting auxiliary devices 18

amplifiers 19
digital phones 22
DVD players 20
PTZ cameras 20
serial control 21
sound cards 19
USB control 21
VCRs 20
video codecs 18

Device Toolbox Editor 49

add a device 49
delete a device 49
edit a device 49

Dialer and Phonebook Usage 43

Dialer 44
 make a call 44
 redial 45
Phonebook 43
 add 43
 delete 43
 edit 43

Error Messages 48

view 48

Event Log 47

print 47
save 47
track events 47

Firmware upgrades 48

Maintenance 70

mute/unmute microphones 52

Network Find 30

Network information 10

Phone Preferences 54

add a Phonebook entry 55
delete a Phonebook entry 55
edit a Phonebook entry 55

Pinouts 73

RAV-Ware Components 35

Camera Controls 42
 presets 42
Line Input and Output 38
 equalization 39
 preconfigured devices 38
 volume 39
Loudspeakers 36
 ClearEffect 36
 equalization 36
 volume 36
Microphones 35
 acoustic echo cancellation 35
 ALC 35
 noise cancellation 35
 volume 35
Mixer 37
Record and Playback 40
 equalization 41
 preconfigured devices 40
 volume 41

RAV-Ware 26

Communication Settings 31
 camera port 32
 control port 32
 static IP address 31
 user name/password 32
connections 28
files 29
 edit 29
 import 29
 new 29
 save 29
install 26
overview 27
Regional Settings 33
 date/time 33
Telephone Settings 33
 Auto Receive Level Control 34
 configuration 34
 preferences 34

Serial Commands 76

Specifications 74

status key 53

System Checks 46

System Requirements 10

Troubleshooting 70

web interface 62

Accessing 62
Dial 63
Event Log 65
Log Out 67
System Check 66