



# Clemas & Co Ltd

Industrial Cleaning Equipment  
Sales - Hire - Service

## TENNANT 6100 SWEEPER OPERATOR MANUAL



**Clemas & Co.** Unit 5 Ashchurch Business Centre, Alexandra Way, Tewkesbury,  
Gloucestershire, GL20 8NB.

**Tel:** 01684 850777

**Fax:** 01684 850707

**Email:** [info@clemas.co.uk](mailto:info@clemas.co.uk)

**Web:** [www.clemas.co.uk](http://www.clemas.co.uk)

The following safety labels are mounted on the machine in the locations indicated. If these or any labels become damaged or illegible, install a new label in its place.

**BATTERY CHARGING LABEL - LOCATED IN BATTERY COMPARTMENT AND ON SEAT MOUNTING WELDMENT.**

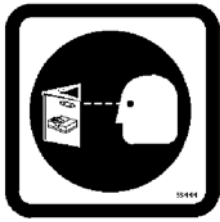

**FOR SAFETY LABEL - LOCATED ON THE SIDE OF THE OPERATOR COMPARTMENT.**

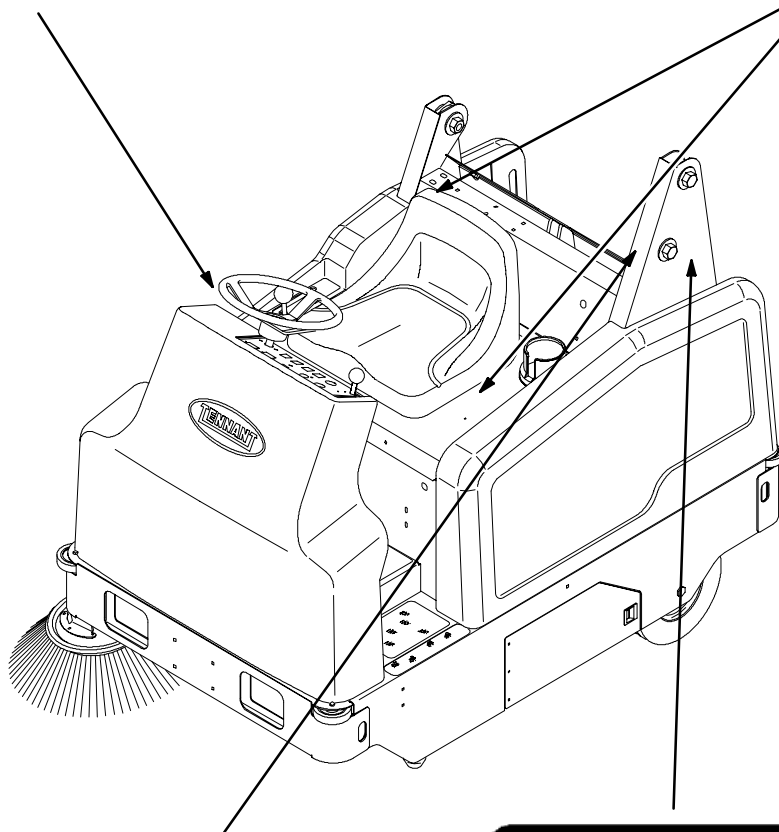

**HOPPER LIFT ARMS LABEL - LOCATED ON BOTH LIFT ARMS.**



**HOPPER SUPPORT LABEL - LOCATED ON LEFT SIDE HOPPER LIFT ARM AND BOTH SIDES OF THE HOPPER COMPARTMENT.**

### OPERATOR RESPONSIBILITY

- The operator's responsibility is to take care of the daily maintenance and checkups of the machine to keep it in good working condition. The operator must inform the service mechanic or supervisor when the maintenance intervals are required as stated in the *MAINTENANCE* section of this manual.
- Read this manual carefully before operating the machine.

**FOR SAFETY: Do not operate machine, unless operation manual is read and understood.**

- Check the machine for shipping damage. Check to make sure the machine is complete per shipping instructions.
- Keep your machine regularly maintained by following the maintenance information in this manual. We recommend taking advantage of a regularly scheduled service contract from your Tennant representative.
- Order parts and supplies directly from your authorized Tennant representative. Use the parts manual provided when ordering parts.
- After operation, follow the recommended daily and hourly procedures stated in the *MAINTENANCE CHART*.

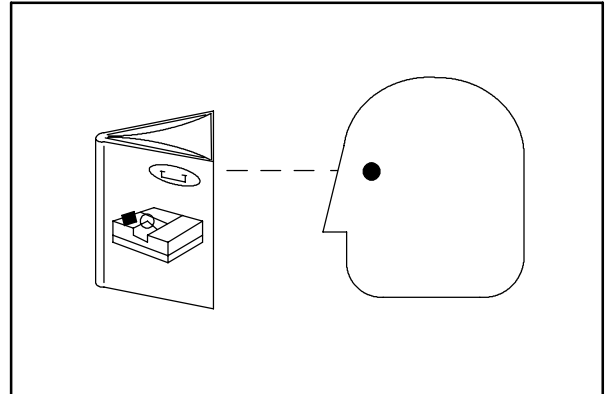

07324

## MACHINE COMPONENTS





























- A. Operator seat
- B. Steering wheel
- C. Instrument panel
- D. Side brush(es)
- E. Control pedals
- F. Hopper
- G. Hopper filter

# OPERATION

## SYMBOL DEFINITIONS

These symbols identify controls, displays, and features on the machine:

	On		Operating lights
	Off		Hazard light
	Main brush down		Start
	Main brush up		Vacuum Fan
	Circuit breaker #1		Filter shaker
	Circuit breaker #2		Main brush on
	Circuit breaker #3		Side brush down and on
	Circuit breaker #4		Side brush up and off
	Circuit breaker #5		Hopper lift
	Circuit breaker #6		Hopper lower
	Circuit breaker #7		Open hopper
	Circuit breaker #8		Close hopper
	Circuit breaker #9		Horn

## CONTROLS AND INSTRUMENTS

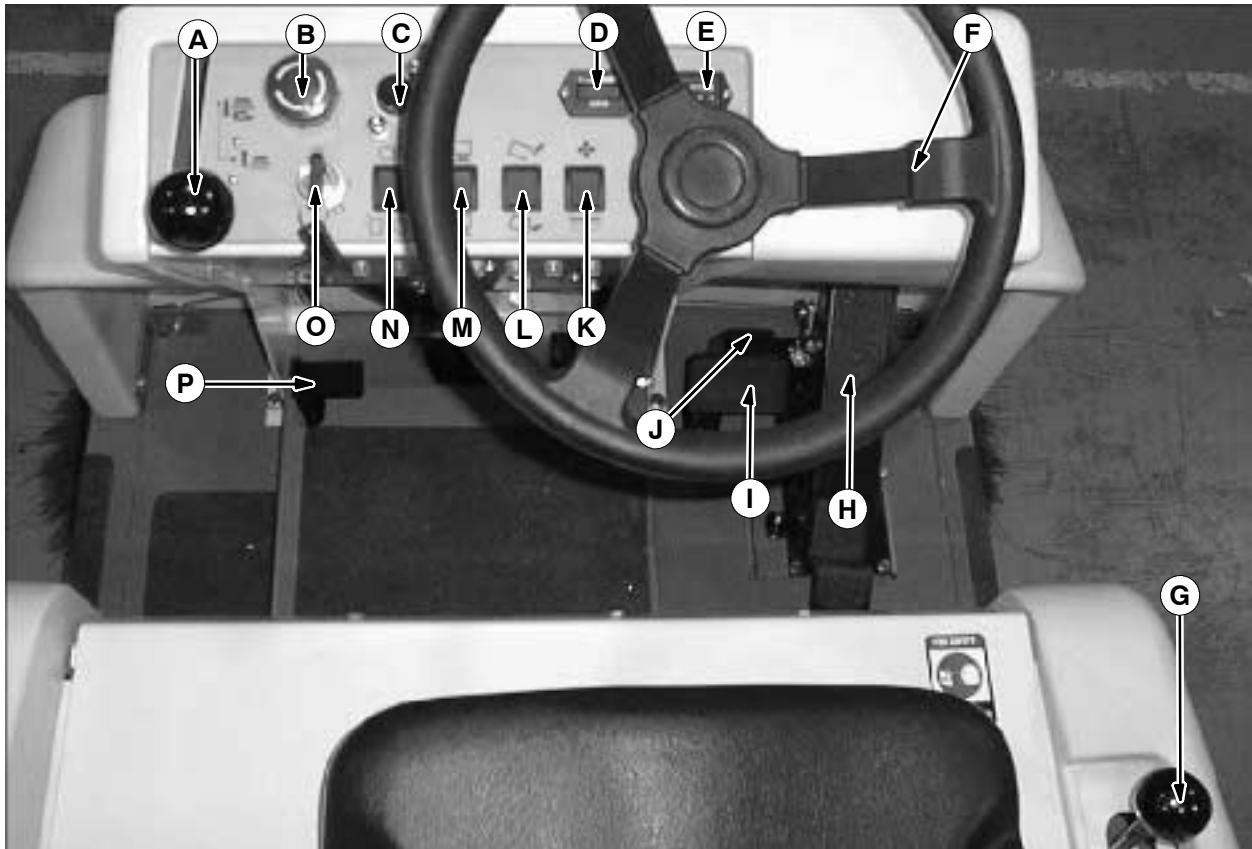

- A. Side brush(es) lever
- B. Power kill switch (option)
- C. Horn
- D. Battery discharge indicator
- E. Hourmeter
- F. Steering wheel
- G. Main brush lever
- H. Directional pedal
- I. Brake pedal
- J. Parking brake pedal
- K. Main brush, vacuum fan/filter shaker switch
- L. Hopper door switch
- M. Hopper switch
- N. Operating/Hazard light switch (option)
- O. On/Off key switch
- P. Large debris trap pedal

# OPERATION

## OPERATION OF CONTROLS

### DIRECTIONAL PEDAL

The *directional pedal* controls the direction of travel and the propelling speed of the machine. Change the speed of the machine with the pressure of your foot on the pedal; the harder you press the faster the machine travels.

Use the brake pedal to stop the machine.

Forward: Press the top of the directional pedal with the toe of your foot.

*NOTE: The machine will not travel unless the operator is sitting in the operator's seat.*

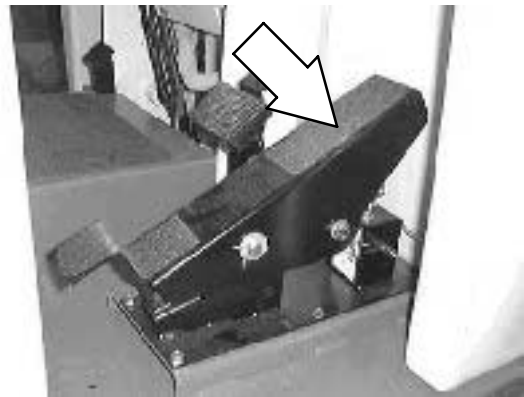

Reverse: Press the bottom of the directional pedal with the heel of your foot.

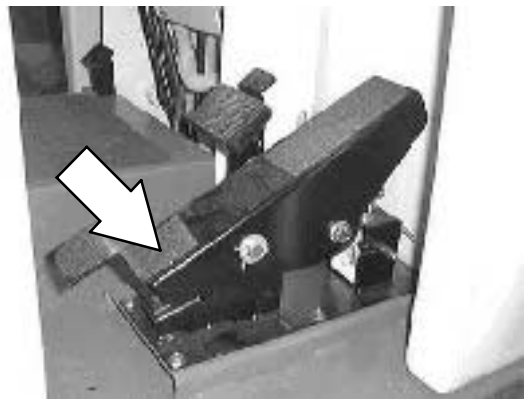

Neutral: Take your foot off the directional pedal and it will return to the **Neutral** position.

*NOTE: The machine may coast when the foot is taken off the directional pedal. Be prepared to step on the brake pedal when removing foot from directional pedal.*



**BRAKE PEDAL**

The *brake pedal* stops the machine.

Stop: Remove your foot from the directional pedal and let it return to the **Neutral** position. Step on the brake pedal to prevent the machine from rolling.

*Note: Machine may roll a slight distance when turned off. Keep foot on brake until machine stops moving.*

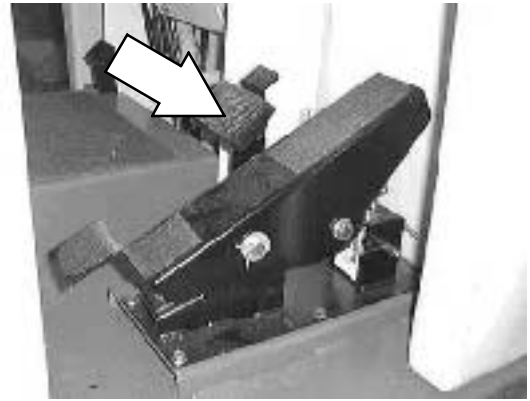
**PARKING BRAKE PEDAL**

The *parking brake pedal* sets and releases the front wheel brake.

Set: Press the brake pedal down as far as possible, then press on the parking brake with the toe portion of your foot to lock the parking brake pedal in place.

**FOR SAFETY: Before leaving or servicing machine, stop on level surface, set parking brake, turn off machine, and remove key.**

Release: Press down on the brake pedal until the parking brake releases.

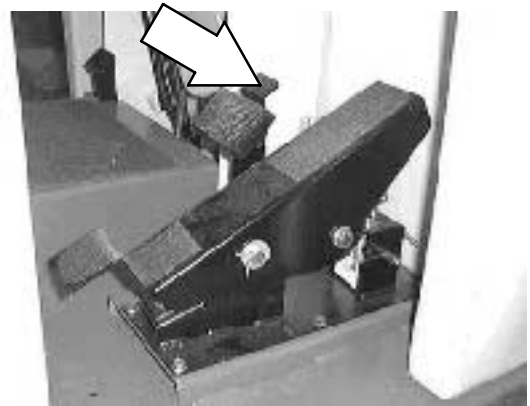
**LARGE DEBRIS TRAP PEDAL**

The *large debris trap pedal* opens the large debris flap in front of the main sweeping brush.

Open: Press on the trap pedal when sweeping up larger debris. The flap in front of the main sweeping brush will open to take in large debris.

Close: Release the pedal and the flap will close, trapping larger debris into the hopper.



## OPERATION

### MAIN BRUSH LEVER

The *main brush lever* controls the position of the main brush.

Main brush down: Pull the lever to the right and back into the **Main brush down** position.

Main brush up: Push the lever up and to the left into the **Main brush up** position.



### MAIN BRUSH/VACUUM FAN AND FILTER SHAKER SWITCH

The *main brush/vacuum fan and filter shaker switch* controls the vacuum fan, rotation of the main brush and the VCS *Vibrating Comb Shaker* system filter shaker.

Vacuum and main brush on: Press the top of the switch to the **Main brush and vacuum fan on** position.

Vacuum and main brush off: Press the switch to the **middle off** position.

Start VCS system filter shaker: **Press and hold** the bottom of the switch for eight to ten seconds.

*NOTE: Excessive heat in the hopper will cause the Thermo Sentry to shut off the main brush and vacuum fan. If this happens, stop the machine and eliminate the source of heat. Press the main brush, vacuum fan and filter shaker switch to the middle off position, then back to the on position.*



### POWER KILL SWITCH (OPTION)

The *power kill switch* halts all power to the machine.

Halt: Push the power kill switch in.

Restart: Turn off the machine power. Turn the power kill switch to the right to release the switch. Turn on the machine power.



## BATTERY DISCHARGE INDICATOR

The *battery discharge indicator* shows the charge level of the batteries. It displays the charge level when the machine is operating.

When the batteries are fully charged, the indicator on the far right is lit. As the batteries discharge, the indicator will move along the display to the left. Recharge the batteries when the indicator flashes.

*NOTE: The reading on the battery discharge indicator is not accurate when the machine is first powered on. Operate the machine a few minutes before reading the charge level of the batteries.*

*NOTE: The battery discharge indicator will not reset from the flashing indicator unless the batteries have been fully charged.*



## STEERING WHEEL

The *steering wheel* controls the machine's direction. The machine is very responsive to the steering wheel movements.

Left: Turn the steering wheel to the left.

Right: Turn the steering wheel to the right.

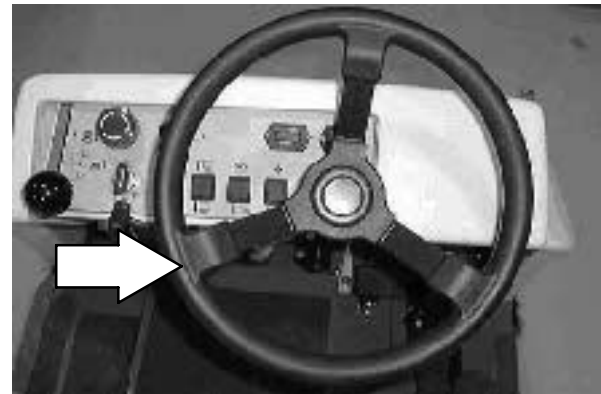

## HOURMETER

The *hourmeter* records the number of hours the machine has been operated. The hourmeter displays the number of hours in tenths of an hour. Use this information to determine machine maintenance intervals.

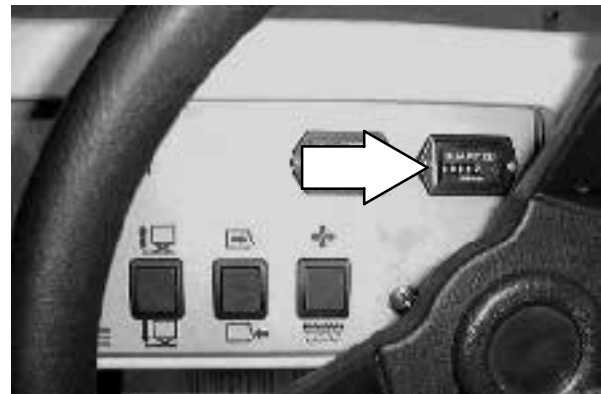

## OPERATION

### ON-OFF KEY SWITCH

The *on-off key switch* controls machine power with a key.

**FOR SAFETY: When starting machine, keep foot on brake and directional pedal in neutral.**

On: Turn the key all the way clockwise.

Off: Turn the key counterclockwise.

*NOTE: The machine will not travel unless the operator is sitting in the operator's seat.*

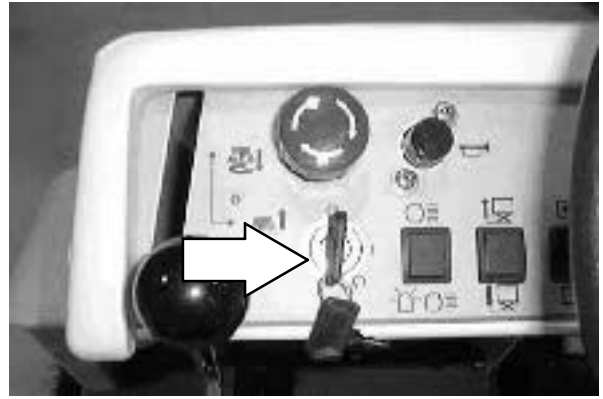

### HORN BUTTON

The *horn button* operates the horn.

Sound: Press the button.

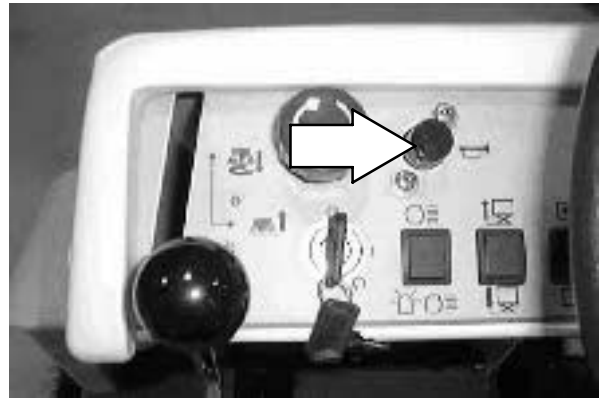

### SIDE BRUSH LEVER

The *side brush lever* controls the position and the power of both the right hand side brush and the optional left hand side brush.

Side brush down and on: Pull the lever left and forward into the **Side brush down and on** position. The brush will automatically start rotating.

Side brush(es) up and off: Pull the lever back and to the right into the **Side brush up and off** position.



**OPERATING LIGHTS SWITCH (OPTION)**

The *operating lights switch* powers on and off the headlights and taillights option.

On: Press the top of the operating lights switch.

Off: Press the switch to the middle position.

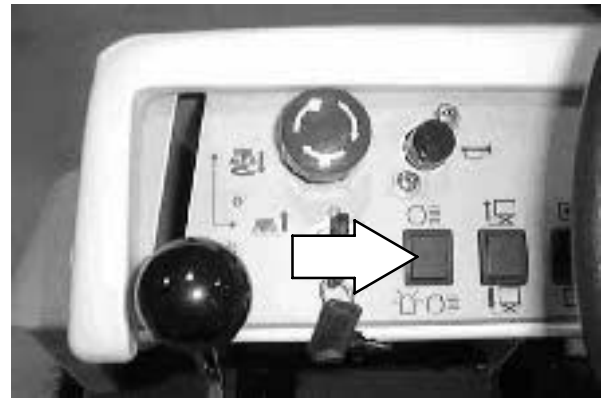
**OPERATING/HAZARD LIGHTS SWITCH (OPTION)**

The *operating/hazard lights switch* powers on and off the headlights and taillights option and the hazard light option.

Operating lights on: Press the top of the operating/hazard lights switch.

Operating/Hazard lights on: Press the bottom of the operating/hazard lights switch.

Off: Press the operating/hazard lights switch to the middle off position.

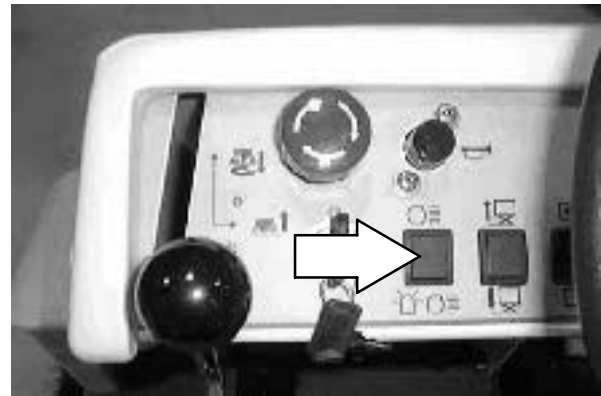

## OPERATION

### HOPPER SWITCH

The *hopper switch* raises and lowers the hopper.

Raise hopper: **Press and hold** the top of the switch until the hopper is in the desired raised position.

Hold: Release the hopper switch into the middle position.

Lower hopper: **Press and hold** the bottom of the switch until the hopper is in the desired lowered position.

 **WARNING: Brush throws debris.**  
Stop motor before lifting hopper.



### HOPPER DOOR SWITCH

The *hopper door switch* opens and closes the hopper door.

Open hopper door: **Press and hold** the top of the switch until the door is in the desired open position.

Hold: Release the hopper door switch into the middle position.

Close hopper door: **Press and hold** the bottom of the switch until the door is in the desired closed position.



**FUSES**

Fuses are one-time protection devices designed to stop the flow of current in the event of a circuit overload. Never substitute higher value fuses than specified.

The fuse is located behind the circuit breaker panel.

Fuse	Rating	Circuit Protected
FU-1	80 A	Main

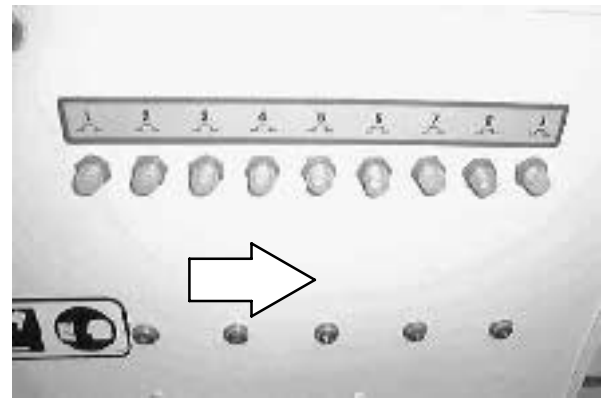

**CIRCUIT BREAKERS**

The *circuit breakers* are resettable electrical circuit protection devices. Their design stops the flow of current in the event of a circuit overload. Once a circuit breaker is tripped, it must be reset manually. Press the reset button after the breaker has cooled down. The circuit breakers will not reset until they have had a chance to cool down.

If the overload that caused the circuit breaker to trip is still there, the circuit breaker will continue to stop current flow until the problem is corrected.

Circuit breakers 1 through 9 are located above the foot pedals in the circuit breaker panel.

The chart lists the circuit breakers and the electrical components they protect.

Circuit Breaker	Rating	Circuit Protected
CB-1	15 A	Main Power
CB-2	15 A	Horn
CB-3	15 A	Side Brushes
CB-4	15 A	Hopper Door
CB-5	15 A	Oper. Lights Warning Lights
CB-6	25 A	Hopper Lift Pump
CB-7	25 A	Main Brush
CB-8	20 A	Sweep Fan Motor
CB-9	20 A	Vac Wand

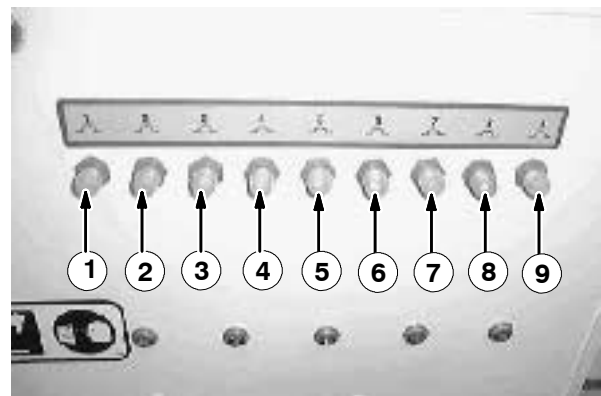

## OPERATION

### OPERATOR SEAT

The *operator seat* is a fixed back style.

**NOTE:** The *operator seat* has a safety switch that stops the machine from propelling unless the operator is sitting in the operator's seat.



### ADJUSTABLE OPERATOR SEAT (OPTION)

The *adjustable operator seat* is a fixed back style with a forward-backward adjustment.

Adjust: Pull the lever in, slide the seat backward or forward to the desired position, and release the lever.

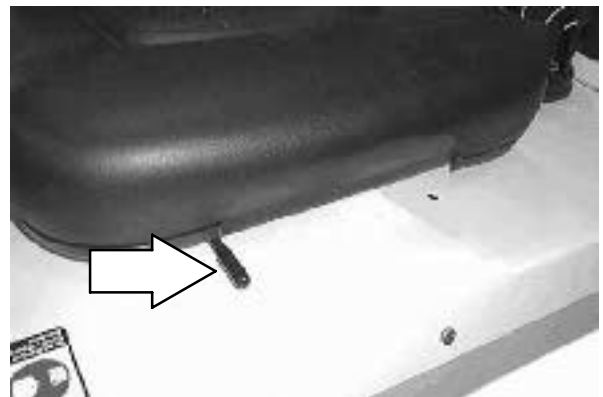

### DELUXE SUSPENSION SEAT (OPTION)

The *deluxe suspension seat* has four adjustments. The adjustments are for the lumbar support, backrest angle, operator weight adjustment and front to back adjustment.

The *lumbar adjustment knob* controls the firmness of the lumbar support.

Increase firmness: Turn knob clockwise.

Decrease firmness: Turn knob counterclockwise.



The *backrest angle knob* adjusts the angle of the backrest.

Increase angle: Turn the angle adjustment knob counterclockwise.

Decrease angle: Turn the angle adjustment knob clockwise.



The *weight adjustment knob* controls the firmness of the operator's seat.

Increase firmness: Turn the weight adjustment knob clockwise.

Decrease firmness: Turn the weight adjustment knob counterclockwise.

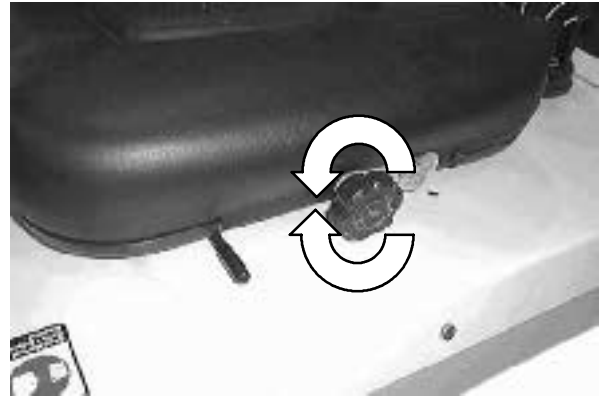

Use the gauge next to the weight adjustment knob to help determine proper seat firmness for the operator.

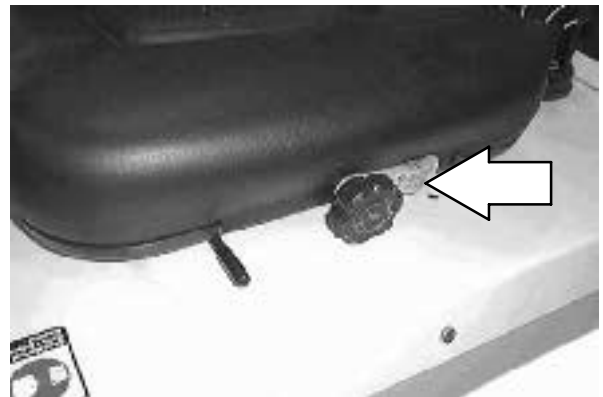

The *front-to-back adjustment lever* adjusts the seat position.

Adjust: Pull the lever out and slide the seat forward or backward to the desired position. Release the lever.

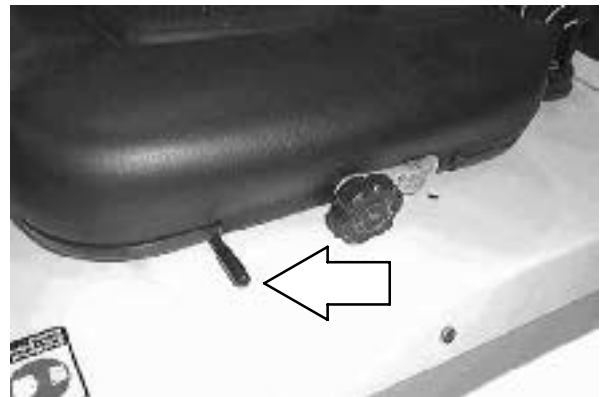

## OPERATION

### HOPPER SUPPORT BAR

The *hopper support bar* is located on the hydraulic cylinder. It is manually moved into place when the cylinder is fully extended to prevent the hopper from lowering. Lift it off the cylinder before lowering the hopper.



---

**HOW THE MACHINE WORKS**

---

The steering wheel controls the direction of machine travel. The directional pedal controls the speed and forward/reverse direction. The brake pedal slows and stops the machine.

The side brush sweeps debris into the path of the main sweeping brush. The main brush sweeps debris from the floor into the hopper. The large debris trap pedal opens and closes the large debris trap, kicking large debris into the hopper. The vacuum system pulls dust and air into the hopper through the Instant Access filter.

When sweeping is finished, clean the dust filter and empty the hopper.

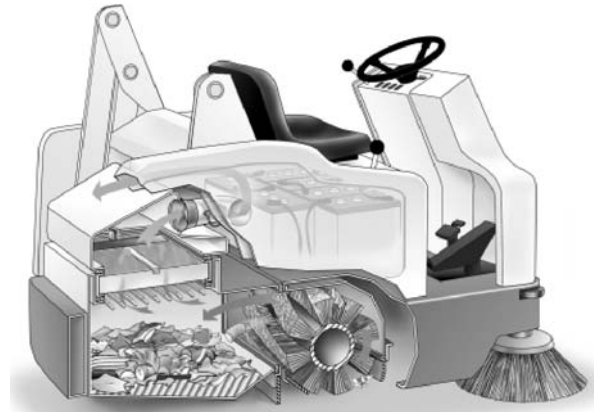

---

**PRE-OPERATION CHECKLIST**

---

- Check the hydraulic fluid level.
- Check the battery fluid and charge level.
- Check the skirts and seals for damage and wear.
- Check the condition of the sweeping brushes. Remove any string, banding, plastic wrap, or other debris wrapped around them.
- Check the sweeping brush patterns for adjustment.
- Check the condition of the hopper dust filter and seals. Clean as required.
- Check the brakes and steering for proper operation.
- Empty the debris hopper.
- Check the service records to determine maintenance requirements.

## OPERATION

### STARTING THE MACHINE

1. Sit in the operator's seat and engage the brakes with the directional pedal in neutral.

**FOR SAFETY: When starting machine, keep foot on brake and directional pedal in neutral.**

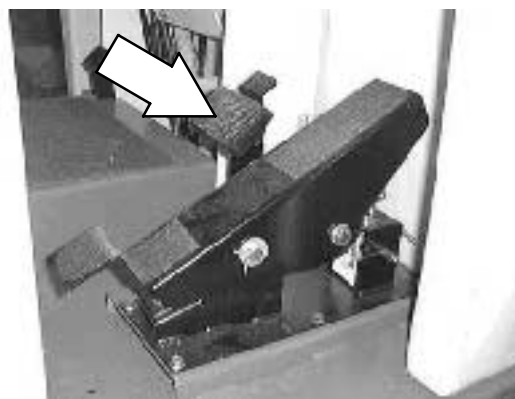

2. Turn the machine power on.

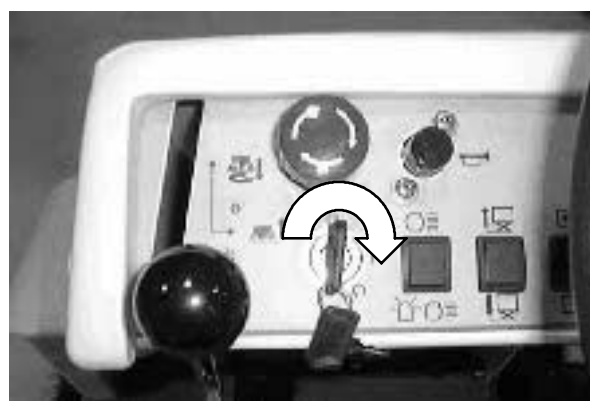

3. Release the machine parking brake.

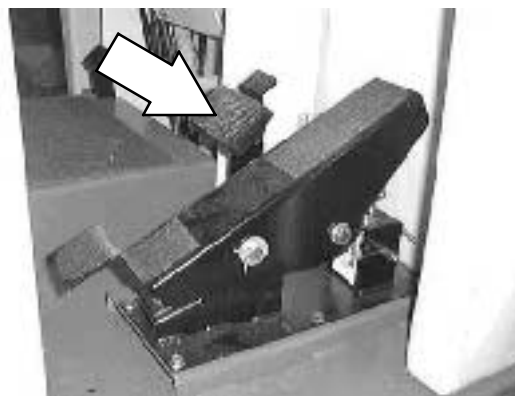

4. Drive the machine to the area to be cleaned.

*NOTE: The machine will not travel unless the operator is sitting in the operator's seat.*

---

**SWEEPING AND BRUSH INFORMATION**

---

Pick up oversized debris before sweeping. Flatten or remove bulky cartons from aisles before sweeping. Pick up pieces of wire, twine, string, etc., which could become entangled in the brush or brush plugs.

Plan the sweeping in advance. Try to arrange long runs with minimum stopping and starting. Do an entire floor or section at one time. Drive the straightest path possible. Avoid bumping into posts or scraping the sides of the machine. Overlap the brush paths.

Avoid turning the steering wheel too sharply when the machine is in motion. The machine is very responsive to the movement of the steering wheel. Avoid sudden turns, except in emergencies.

For best results, use the correct brush type for your sweeping application. The following are recommendations for main sweeping and side brush applications.

***Polypropylene 8-single row main brush*** -

Superior pick-up of sand, gravel, and paper litter. Polypropylene retains its stiffness when wet and can be used indoors or outdoors with equal performance. Not recommended for high-temperature debris.

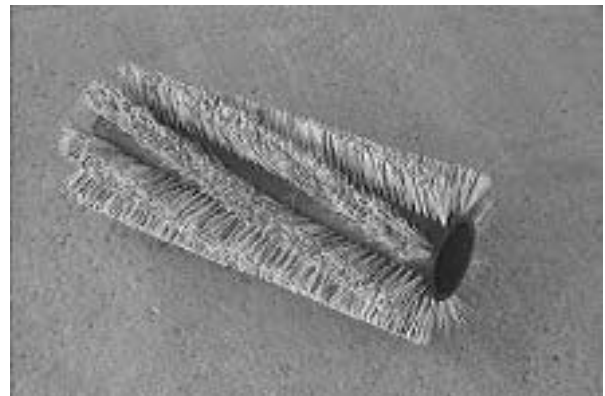

***Natural Fiber main brush*** - The natural choice for cleaning fine debris on carpet and sweeping very heavy dust and other fine particles on hard surfaces. When cleaning carpet, check brush and perma filter panel regularly for carpet debris.

***Sand Wedge main brush*** - A fine brush that handles large quantities of dust and sand with ease.



## OPERATION

---

**Side Brush (2 Row)** – A good general purpose brush for sweeping of light to medium debris in both indoor and outdoor applications. This brush is recommended when bristles may get wet.

**Side Brush (3 Row)** – Improved sweeping performance of fine materials on smooth indoor surfaces.

**Stiff Side Brush** – A longer life, general purpose brush that is recommended for rough surfaces.



---

**SWEEPING**

---

1. Press the top of the *main brush/vacuum fan and filter shaker switch* to the on position.



2. Lower the main brush with the *main brush lever*.



3. Lower and start the side brush(es) with the *side brush lever*.

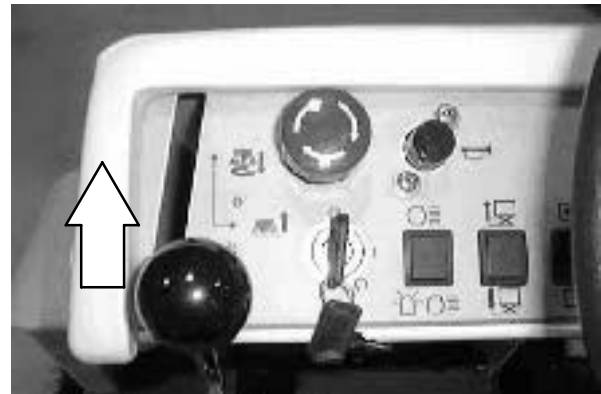

4. Begin sweeping.

## OPERATION

5. Press down on the *large debris trap pedal* when sweeping large debris.

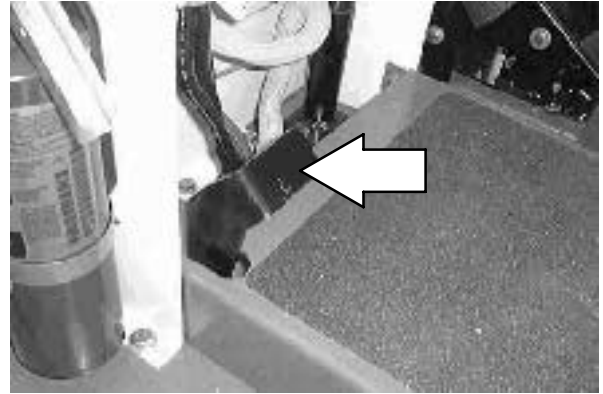

6. Release the pedal, and the flap will lower over the debris.

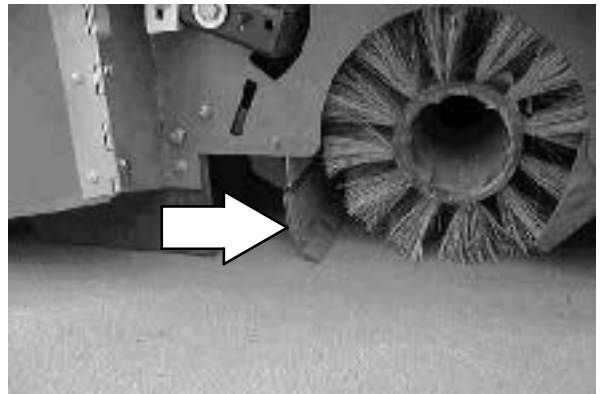

7. The flap will trap large debris back into the hopper.

---

**STOP SWEEPING**

---

1. Raise and stop the side brush(es) with the *side brush lever*.

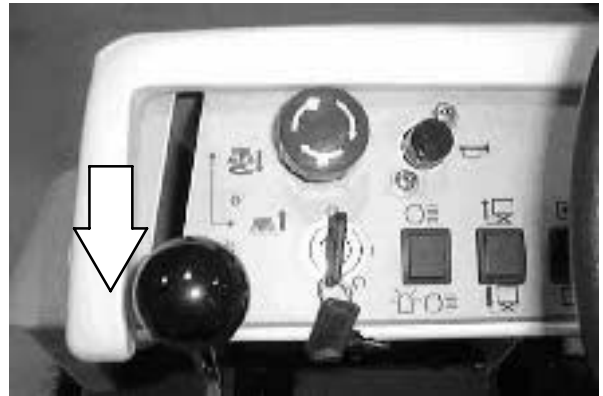

2. Raise the main brush with the *main brush lever*.



3. Press and hold the bottom of the *main brush/vacuum fan and filter shaker switch* for eight to ten seconds to start the filter shaker.



## EMPTYING THE HOPPER

1. Stop sweeping. See the STOP SWEEPING section of the manual.
2. Drive the machine to the debris site or debris container.
3. Press and hold the top of the *hopper switch* to raise the hopper to the desired height. Release the switch into the hold position.

**!** **WARNING: Lift arm pinch point. Stay clear of hopper lift arms.**



**FOR SAFETY: When using machine, make sure adequate clearance is available before raising hopper.**

*NOTE: Be aware that the minimum ceiling height needed to high dump the hopper is 2286 mm.*

4. Back the machine up to the debris container. Position the hopper over the debris container.
5. Press and hold the top of the *hopper door switch* until the hopper door is fully open. Release the switch into the hold position.

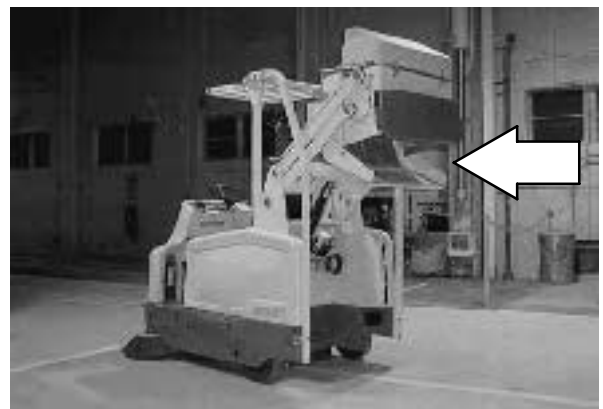
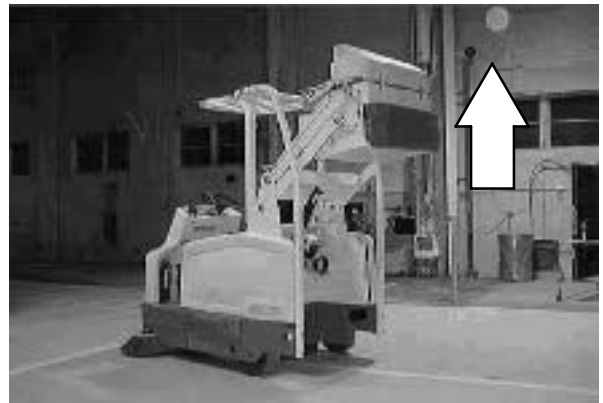

6. Press and hold the bottom of the *hopper door switch* until the door is fully closed.



7. Press and hold the bottom of the *hopper switch* until the hopper is fully lowered.

**!** **WARNING:** Lift arm pinch point. Stay clear of hopper lift arms.



### STOPPING THE MACHINE

1. Stop sweeping. See the STOP SWEEPING section of the manual.
2. Take your foot off the directional pedal. Step on the brake pedal.

*NOTE: The machine may coast for a short distance when your foot is removed from the directional pedal. Use the brake pedal to stop the machine.*

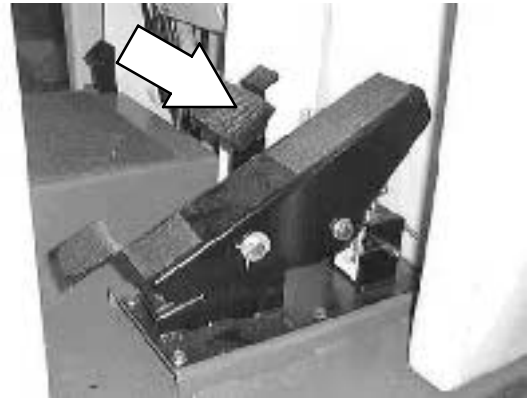

3. Set the machine parking brake.

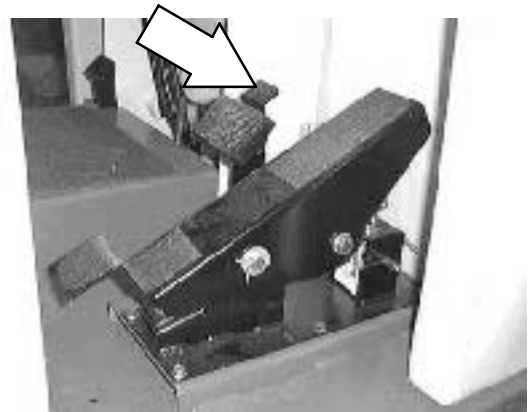

4. Turn the machine power off. Remove the switch key.

**FOR SAFETY: Before leaving or servicing machine, stop on level surface, set parking brake, turn off machine, and remove key.**



---

**POST-OPERATION CHECKLIST**

---

Check this list of items after you have finished sweeping:

- Check the hydraulic fluid level.
- Check the battery fluid and charge level.
- Check the skirts and seals for damage and wear.
- Check the condition of the sweeping brushes. Remove any string, banding, plastic wrap, or other debris wrapped around them.
- Check the sweeping brush patterns for adjustment.
- Check the condition of the hopper dust filter and seals. Clean as required.
- Check the brakes and steering for proper operation.
- Empty the debris hopper.
- Check the service records to determine maintenance requirements.

## ENGAGING HOPPER SUPPORT BAR

1. Set the machine parking brake.

**FOR SAFETY: When starting machine, keep foot on brake and directional pedal in neutral.**

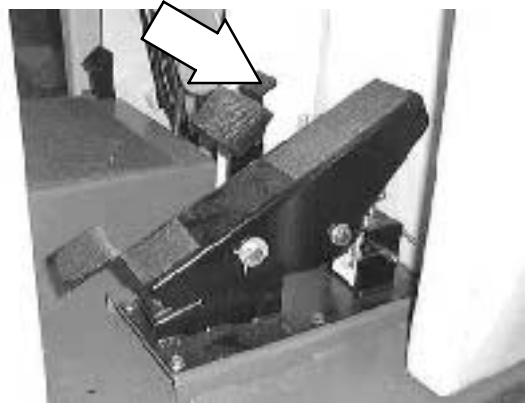

2. Turn the machine power on.

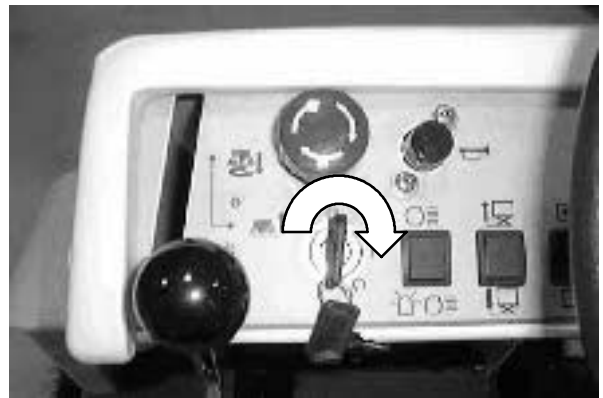

3. Press and hold the top of the hopper switch until the hopper is fully raised. Release the switch into the hold position.

**! WARNING: Lift arm pinch point. Stay clear of hopper lift arms.**

**FOR SAFETY: When using machine, make sure adequate clearance is available before raising hopper.**

*NOTE: Be aware that the minimum ceiling height needed to high dump the hopper is 2286 mm.*



4. Push the hopper support bar in place onto the support cylinder.

**!** **WARNING: Raised hopper may fall. Engage hopper support bar**

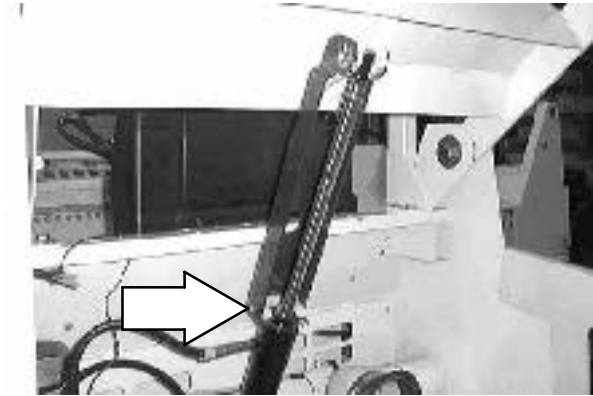

5. Slowly lower the hopper by pressing down and holding the *hopper switch* until the hopper support bar rests on the support bar stop.

**!** **WARNING: Lift arm pinch point. Stay clear of hopper lift arms.**



6. Turn the machine power off.



## OPERATION

### DISENGAGING HOPPER SUPPORT BAR

1. Turn the machine power on.

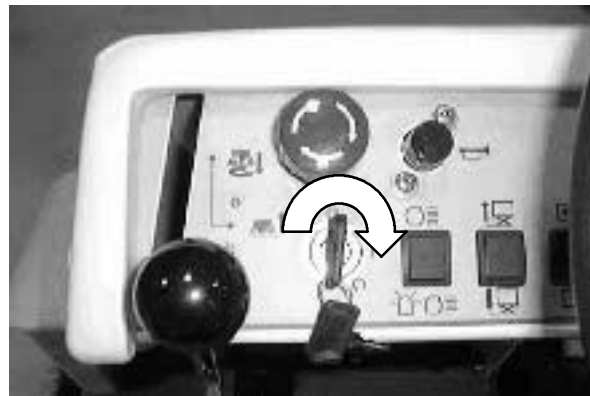

2. Raise the hopper slightly by pressing up and holding the *hopper switch*. Release the switch into the hold position.

*NOTE: Be aware that the minimum ceiling height needed to high dump the hopper is 2286 mm.*



3. Move the hopper support bar off the cylinder into the storage position.

**!** **WARNING: Lift arm pinch point. Stay clear of hopper lift arms.**

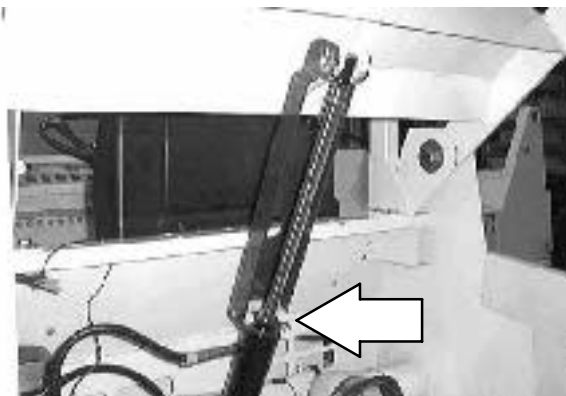

4. Press and hold the bottom of the hopper switch until the hopper is in the fully lowered position.

**!** **WARNING: Lift arm pinch point. Stay clear of hopper lift arms.**

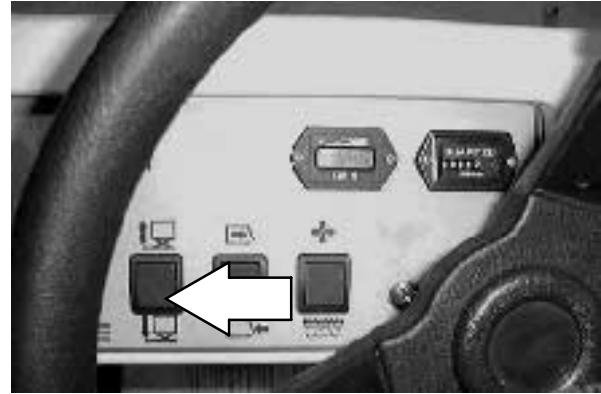

5. Turn the machine power off.

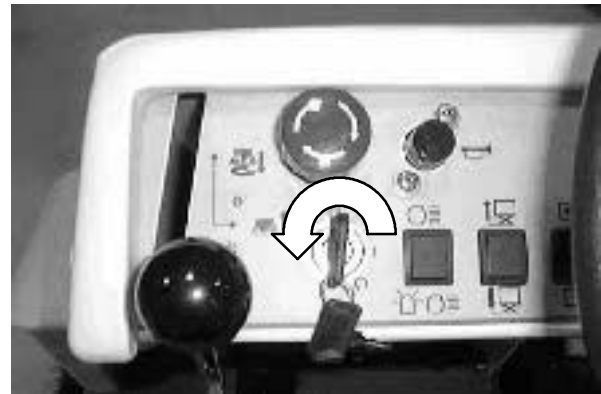

---

## OPERATION ON INCLINES

---

Drive the machine slowly on inclines. Use the brake pedal to control machine speed when descending inclines.

The maximum rated incline is 6°/11% with a full hopper and 10°/18% with an empty hopper.

**FOR SAFETY: When using machine, go slowly on inclines and slippery surfaces.**

## OPTIONS

### VACUUM WAND

The vacuum wand uses a separate vacuum system to pick-up any debris that is out of reach of the machine.



1. Turn machine on.

*NOTE: The main brush/vacuum fan and filter shaker switch does not have to be turned on for the vacuum wand system to operate.*



2. Turn the cam knob counterclockwise to release vacuum wand rod handle.



3. Wand On: Raise the vacuum wand from the storage position. The vacuum will turn on automatically.
4. Wand Off: Return the vacuum wand back to storage position and the vacuum will turn off.

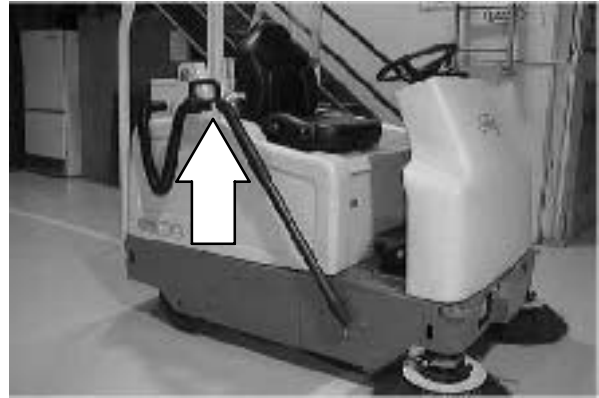

5. Turn the cam knob clockwise to secure vacuum wand rod handle.



6. Replace full vacuum bags whenever wand begins to lose power or when bags are full.



## OPERATION

### QUICK MOP

The *QuickMop* is a front end sweeping attachment that widens the machine's sweeping path.

1. Drive the machine close to QuickMop attachment.
2. Set the machine parking brake and turn the machine power off.

**FOR SAFETY: Before leaving or servicing machine, stop on level surface, set parking brake, turn off machine, and remove key.**



3. Connect the QuickMop attachment to the mounting bracket on the front of the machine.

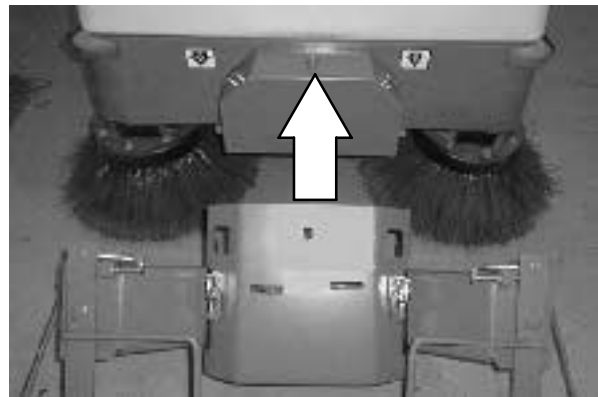

4. Fasten the latches on the front of the mounting bracket. Release the parking brake and drive to the designated area to be swept.



5. Pull the release lever to raise or lower each side of the QuickMop.

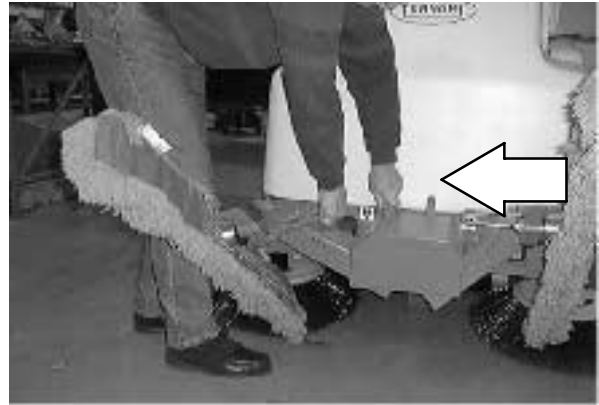

6. Turn the vacuum and brushes on, lower brushes and begin sweeping.



7. Remove and refasten the QuickMop head covers with the easy to remove snaps. Remove the head covers to rotate, shake and clean at regular intervals.

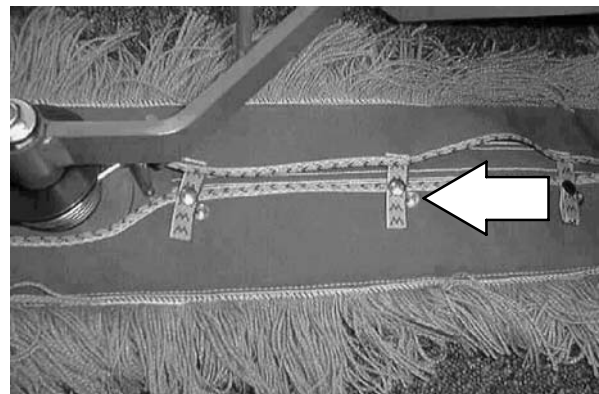

## OPERATION

### ROLLOUT BATTERY

The rollout battery allows the operator a quick and easy way to remove and replace the batteries from the machine.

1. Drive the machine to a flat, dry surface.
2. Turn the machine off and set the parking brake.

**FOR SAFETY: Before leaving or servicing machine, stop on level surface, set parking brake, turn off machine, and remove key.**

3. Lift the operator seat to access the batteries. The support arm automatically engages when the seat is lifted all the way up.
4. Unplug the machine connector from the batteries.

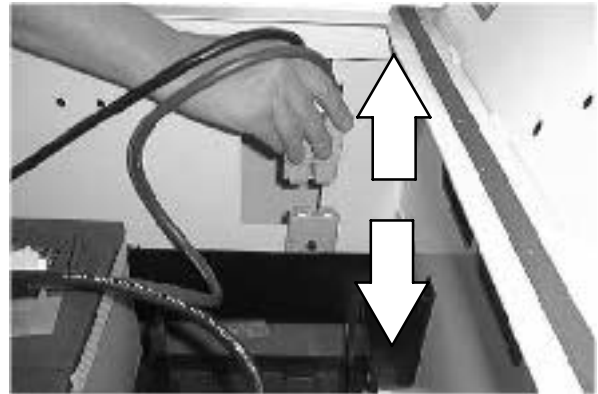

5. Remove the left side panel and push the battery cart to the left side of the machine. Line up the battery cart locks and the slots on the machine. Push the battery cart forward.

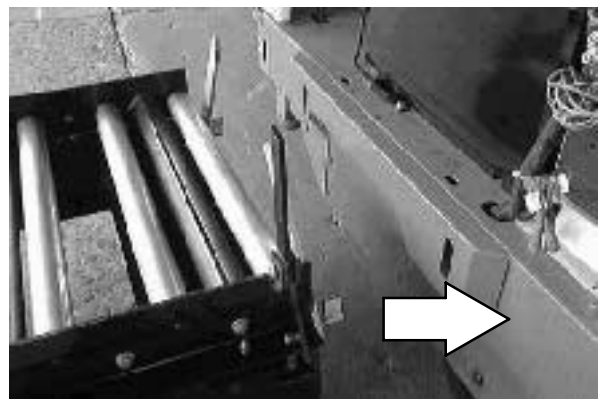

6. Lock the battery cart to the machine by pulling the battery cart locks towards the outside of the battery cart.

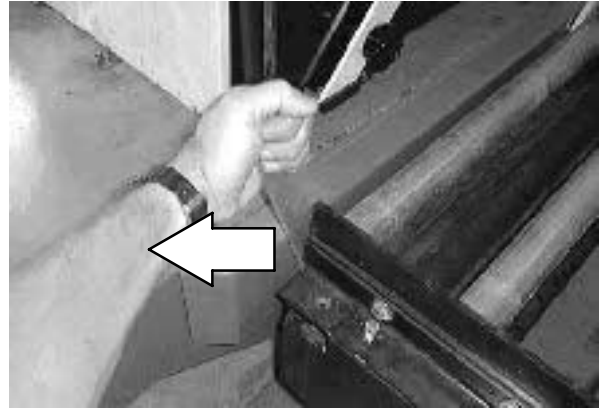

7. Set the battery cart floor lock by stepping down on the left side of the floor lock.



8. Adjust the battery cart rollers before rolling out the batteries. The battery cart rollers must be the same height as the machine battery rollers.

Raise the battery cart rollers: With a wrench, loosen the jam nut and turn the bolt clockwise. Tighten the jam nuts.

Lower the battery cart rollers: With a wrench, loosen the jam nut and turn the bolt counter-clockwise. Tighten the jam nuts.

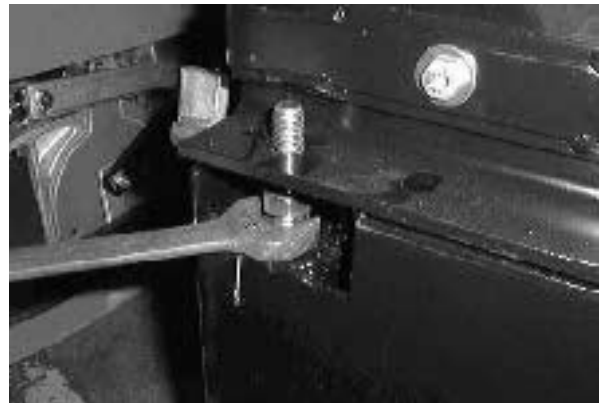

## OPERATION

9. Turn the knob on the machine's battery stop arm counterclockwise until it stops turning.



10. Raise the machine's battery stop arm all the way to the horizontal position.



11. Raise the cart's battery stop bar by pushing down on the handle.



12. Grab the battery case slot and pull the battery case onto the battery cart.



13. Lower the cart's battery stop bar by pulling up on the handle. This will keep the batteries from rolling off the cart when moving.

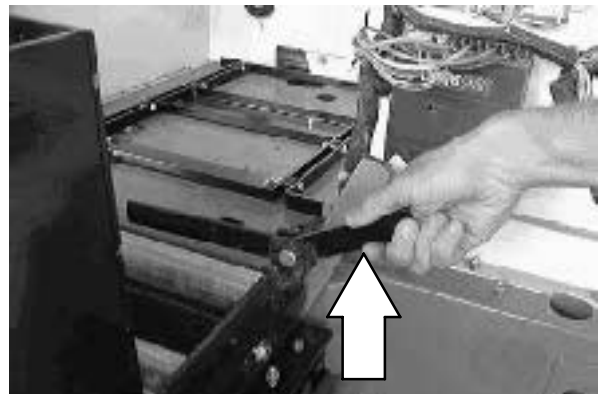

## OPERATION

14. Release the battery cart from the machine by pushing the battery cart locks towards the inside of the battery cart.

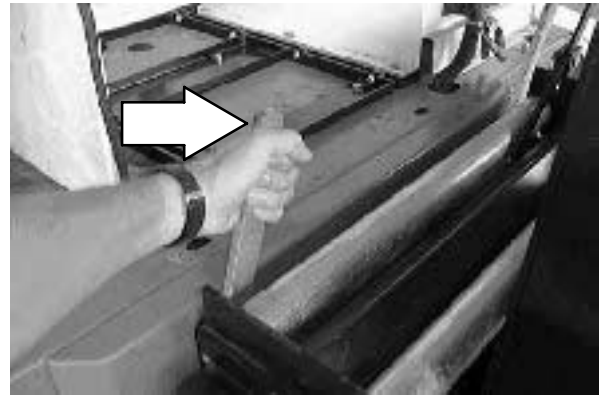

15. Release the battery cart floor lock. To release the floor lock, step down on the right side of the floor lock.

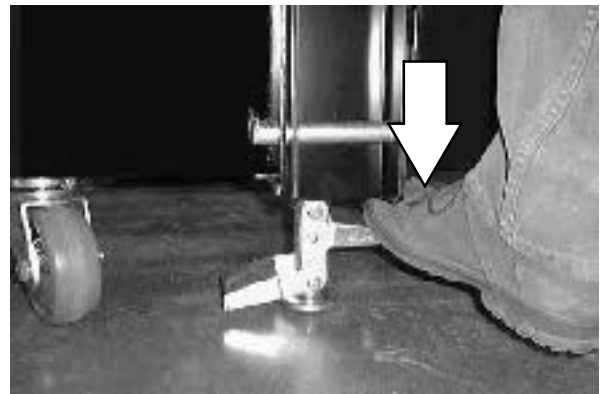

16. Pull the battery cart away from the machine.

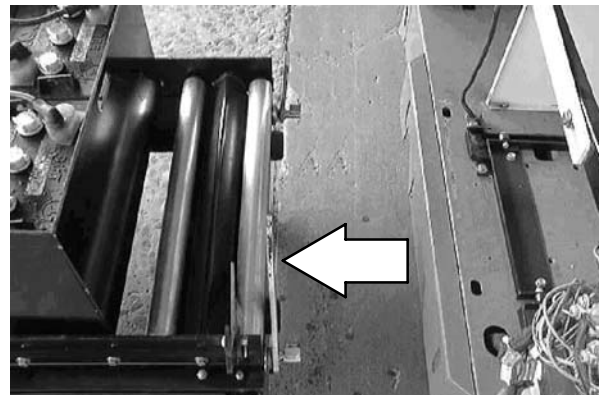

17. Reverse the previous steps to re-install the batteries in the machine.

---

**MACHINE TROUBLESHOOTING**

---

Problem	Cause	Remedy
No machine power	Power kill switch on	Turn kill switch clockwise until it pops up. Turn machine off and on
	Batteries not connected	Connect batteries to machine
Low machine power	Low battery power	Check and charge batteries
Machine does not propel	Operator not in seat	Sit in operator seat
Excessive dusting	Vacuum fan off	Press the main brush, vacuum and filter shaker switch to the on position
	Brush skirts and dust seals worn, damaged, out of adjustment	Replace or adjust brush skirts or dust seals
	Hopper dust filter clogged	Shake and/or clean or replace dust filter
	Vacuum fan failure	Contact Tennant service personnel
	Thermo Sentry tripped	Remove heat source from hopper. Restart machine.
Poor sweeping performance	Brush bristles worn	Replace brushes
	Main and/or side brushes not adjusted properly	Adjust main and/or side brushes
	Debris caught in main brush drive mechanism	Remove debris from drive mechanism
	Main brush drive failure	Contact Tennant service personnel
	Side brush drive failure	Contact Tennant service personnel
	Hopper full	Empty hopper
	Hopper lip skirts worn or damaged	Replace lip skirts
	Wrong sweeping brush	Contact Tennant representative for recommendations
	Large debris trap damaged	Repair or replace large debris trap
	Hopper dust filter clogged	Shake and/or clean or replace dust filter
	Recirculation skirt edge not folded in	Fold in skirt edge
	Recirculation flap damaged	Replace flap

**MAINTENANCE**

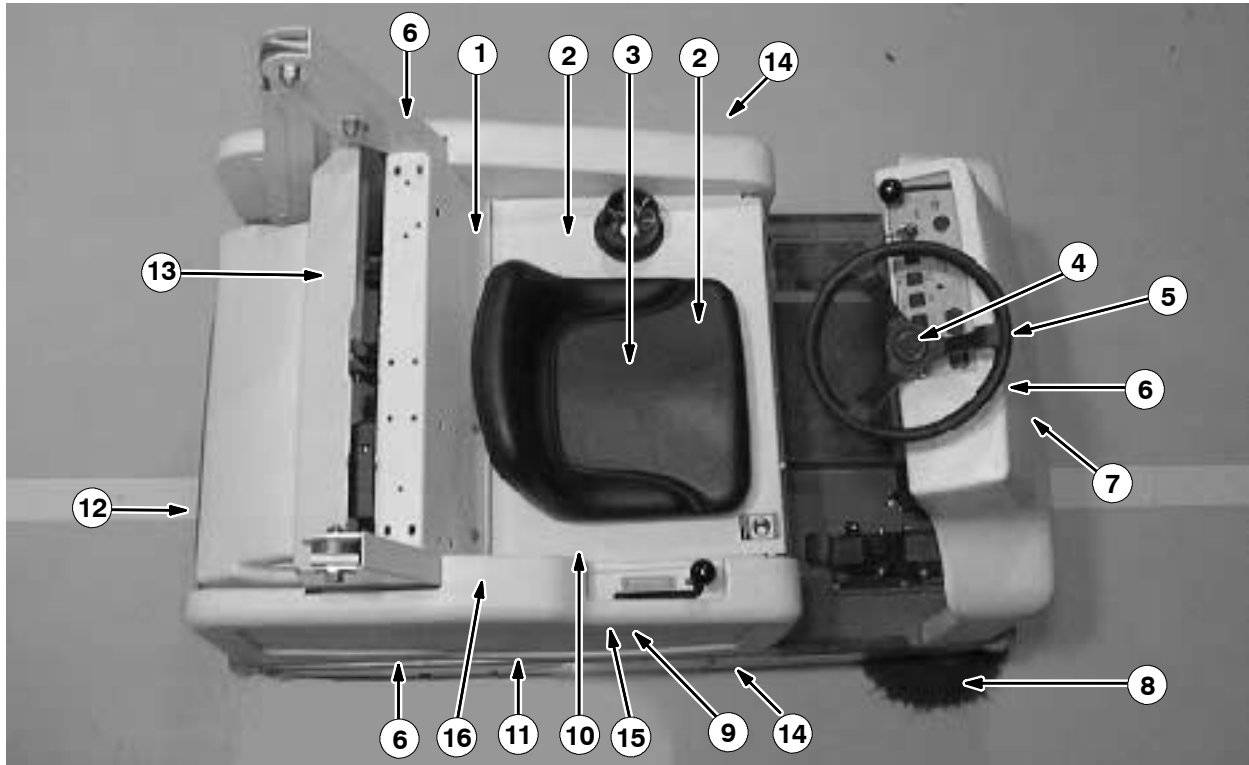

**MAINTENANCE CHART**

*NOTE: Check procedures indicated (■) after the first 50 hours of operation.*

Interval	Key	Description	Procedure	Lubricant/ Fluid	No. of Service Points
Daily	2	Brush compartment skirts	Check for damage, wear and adjustment	-	5
	14	Side skirts	Check for damage, wear and adjustment	-	2
	10	Main brush	Check for damage, wear and adjustment	-	1
				-	1
	8	Side brush(es)	Check for damage or wear	-	1
			Check brush pattern	-	1
12	Hopper dust filter	Shake	-	1	
50 Hours	10	Main brush	Rotate end-for-end	-	1
	-	QuickMop broom (Option)	Rotate or wash sweep heads	-	2
	3	Batteries	Check electrolyte level	DW	6 (3)
	-	Vacuum wand bag (Option)	Check or change vacuum bag	-	1
	-	Vacuum wand fan (Option)	Check for damage or wear	-	1

Interval	Key	Description	Procedure	Lubricant/ Fluid	No. of Service Points
100 Hours	12	Hopper dust filter	Change for damage, clean or replace	-	1
	13	Hydraulic reservoir	Check fluid level	HYDO	1
	6	Tires	Check for damage	-	3
	1	Hopper seals	Check for damage or wear	-	6
	1	Hopper filter seals	Check for damage or wear	-	2
	12	Vacuum seal	Check for damage or wear	-	1
	2	Large debris trap skirt	Check for damage or wear	-	1
	7	Steering castor pivot bearing	Lubricate and check for wear	SPL	1
	11	Vacuum fan belt	Check tension and wear	-	1
	9	Main brush belt	Check for wear	-	1
200 Hours	5	Brakes	Check and adjust travel	-	1
	4	Steering gear chain	Lubricate	EO	1
	8	Side brush(es) guard	Check for damage or wear	-	1 (2)
	3	Battery terminals and cables	■Check and clean	-	12
800 Hours	13	Hydraulic fluid reservoir	Change hydraulic fluid	HYDO	1
	13	Hydraulic hoses	Check for wear and damage	-	2
	7	Propelling motor	Check carbon brushes	-	1
	6	Rear wheels	■Check rear wheel axle torque	-	1
	15	Main brush motor	Check carbon brushes	-	1
	16	Vacuum fan motor	Check carbon brushes	-	1

**LUBRICANT/FLUID**

DW . . . . Distilled water

EO . . . . SAE 30 Engine oil

HYDO . . Tennant or approved hydraulic fluid

SPL . . . Special lubricant, Lubriplate EMB grease (TENNANT part no. 01433-1)

*NOTE: More frequent intervals may be required in extremely dusty conditions.*

## LUBRICATION

### STEERING GEAR CHAIN

The steering chain turns the front wheel as the steering wheel is turned to steer the machine. Lubricate the steering chain with SAE 30-weight engine oil and check chain tension every 200 hours of operation.

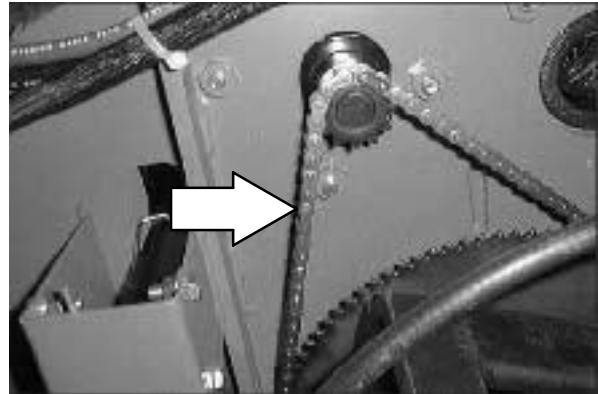

### STEERING CASTOR PIVOT BEARING

The steering castor bearing is located under the floorplate. Remove the floorplate, and lubricate the bearing with Lubriplate EMB grease (TENNANT part no 01433-1) every 100 hours.

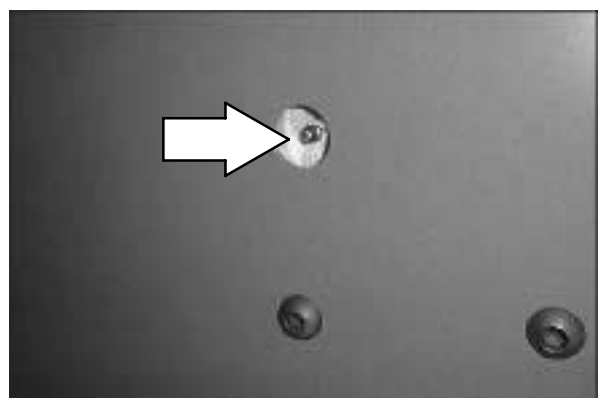
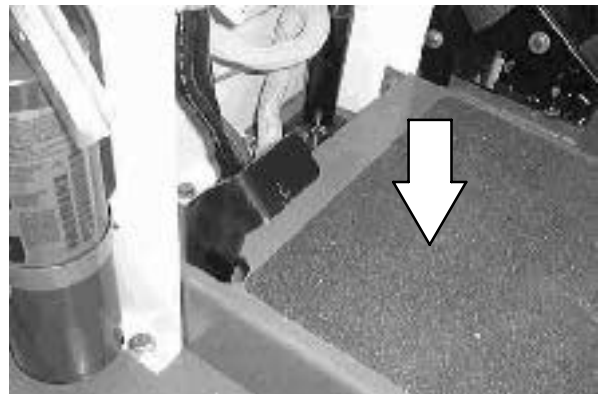

**HYDRAULICS**

**HYDRAULIC FLUID RESERVOIR**

The reservoir is located behind the debris hopper.

A filler cap is mounted on top of the reservoir.

Raise the hopper and check the hydraulic fluid level at operating temperature after every 100 hours of operation. Make sure the hopper support bar is in place before checking hydraulic fluid level. The side of the reservoir is marked with FULL and ADD levels to indicate the level of hydraulic fluid in the reservoir.

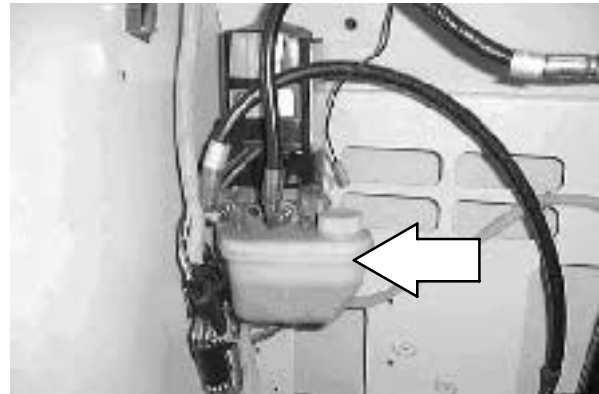

**! WARNING: Lift arm pinch point. Stay clear of hopper lift arms.**

**! WARNING: Raised hopper may fall. Engage hopper support bar**

**ATTENTION! Do not overfill the hydraulic fluid reservoir or operate the machine with a low level of hydraulic fluid in the reservoir. Damage to the machine hydraulic system may result.**

Drain and refill the hydraulic fluid reservoir with new hydraulic fluid after every 800 hours of operation.

**HYDRAULIC FLUID**

The quality and condition of the hydraulic fluid play a very important role in how well the machine operates. Tennant's hydraulic fluid is specially selected to meet the needs of Tennant machines.

Tennant's hydraulic fluid provide a longer life for the hydraulic components.

<b>Tennant hydraulic fluid</b>	
Part number	Ambient temperature
65870	below 7° C

## MAINTENANCE

If a locally available hydraulic fluid is used, make sure the specifications match Tennant hydraulic fluid specifications. Using substitute fluids can cause premature failure of hydraulic components.

**ATTENTION! Hydraulic components depend on system hydraulic fluid for internal lubrication. Malfunctions, accelerated wear, and damage will result if dirt or other contaminants enter the hydraulic system.**

### HYDRAULIC HOSES

Check the hydraulic hoses after every 800 hours of operation for wear or damage.

Fluid escaping at high pressure from a very small hole can be almost invisible, and can cause serious injuries.

See a doctor at once if injury results from escaping hydraulic fluid. Serious infection or reaction can develop if proper medical treatment is not given immediately.

**FOR SAFETY: When servicing machine, use cardboard to locate leaking hydraulic fluid under pressure.**

If you discover a fluid leak, contact your mechanic or supervisor.

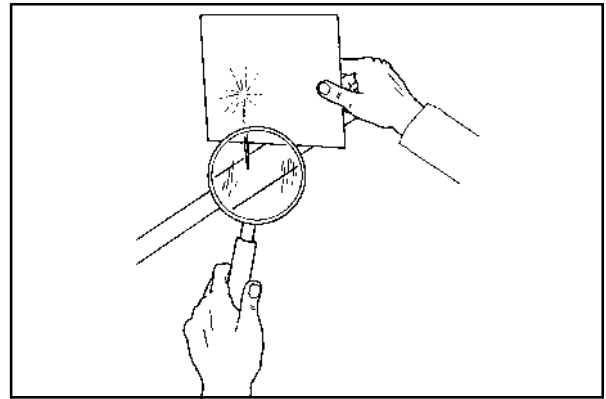

00002

**BATTERIES**

The batteries are unique in that they hold their power for long periods of time. The lifetime of the batteries is limited by the number of charges the batteries receive. To get the most life from the batteries, charge them when the last battery discharge indicator segment flashes (20% charge left). Use an automatic charger with the proper rating for the batteries.

Every 200 hours of machine operation, clean the top surface of the batteries and the terminals, and check for loose connections. Use a strong solution of baking soda and water. Brush the solution sparingly over the battery tops, terminals, and cable clamps. Do not allow any baking soda solution to enter the batteries. Use a wire brush to clean the terminal posts and the cable connectors. After cleaning, apply a coating of clear battery post protectant to the terminals and the cable connectors. Keep the tops of the batteries clean and dry.

Keep all metallic objects off the top of the batteries, which may cause a short circuit. Replace any worn or damaged wires.

Check the electrolyte level in each battery after charging, and after every 50 hours of operation. Never add acid to the batteries, only distilled water. Always keep the battery caps on, except when adding water or taking hydrometer readings.

Check the electrolyte level in each battery cell before and after charging, and after every 50 hours of operation. Do not charge the batteries unless the fluid is slightly above the battery plates. If needed, add just enough distilled water to cover the plates. Never add acid to the batteries. Do not overfill. Always keep the battery caps on, except when adding water or taking hydrometer readings.

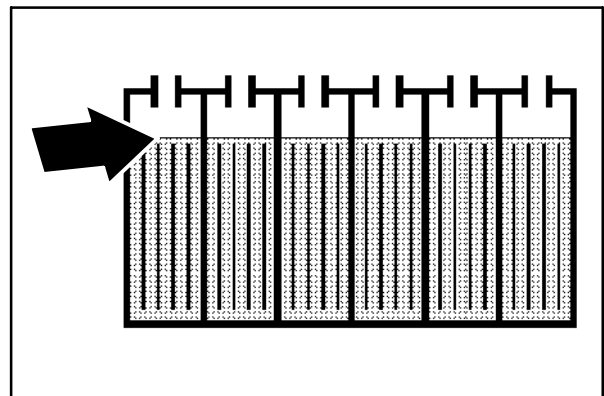

## MAINTENANCE

Measuring the specific gravity, using a hydrometer, is a way to determine the charge level and condition of the batteries. If one or more of the battery cells test lower than the other battery cells (0.050 or more), the cell is damaged, shorted, or is about to fail.

*NOTE: Do not take readings immediately after adding distilled water. If the water and acid are not thoroughly mixed, the readings may not be accurate. Check the hydrometer readings against the following chart to determine the remaining battery charge level:*

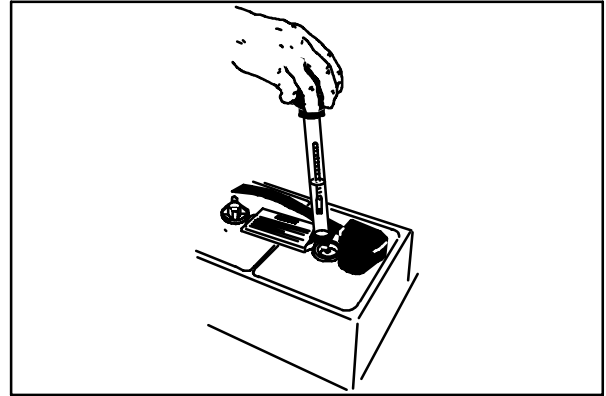

04380

SPECIFIC GRAVITY at 27° C (80° F)			
Charge Level	220A/hr Battery	235A/hr Battery	335A/hr Battery
100%	1.265	1.265	1.265
75%	1.223	1.223	1.223
50%	1.185	1.185	1.185
25%	1.148	1.148	1.148
0%	1.110	1.110	1.110

*NOTE: If the readings are taken when the battery electrolyte is any temperature other than shown, the reading must be temperature corrected. Add or subtract to the specific gravity reading 0.004, 4 points, for each 6° C (10° F) above or below 27° C (80° F).*

**CHARGING THE BATTERIES**

1. Drive the machine to a flat, dry surface in a well-ventilated area.
2. Stop the machine, set the parking brake and turn the machine power off.

**FOR SAFETY: Before leaving or servicing machine, stop on level surface, set parking brake, turn off machine, and remove key.**

3. Open the seat support.
4. Check the water level in all the battery cells.

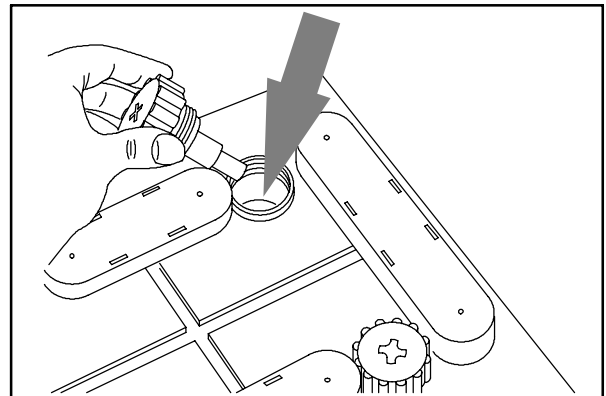

08247

5. If the level is low, add just enough distilled water to cover the plates. **DO NOT OVERFILL.** The batteries can overflow during charging due to expansion.

*NOTE: Make sure the battery caps are in place while charging.*

**FOR SAFETY: When maintaining or servicing machine, avoid contact with battery acid.**

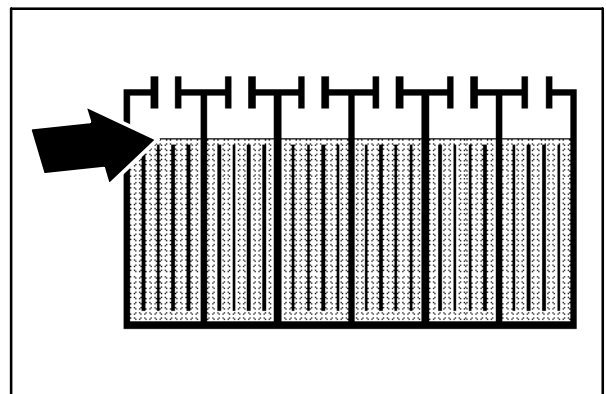

## MAINTENANCE

6. Unplug the battery connector from the machine connector.

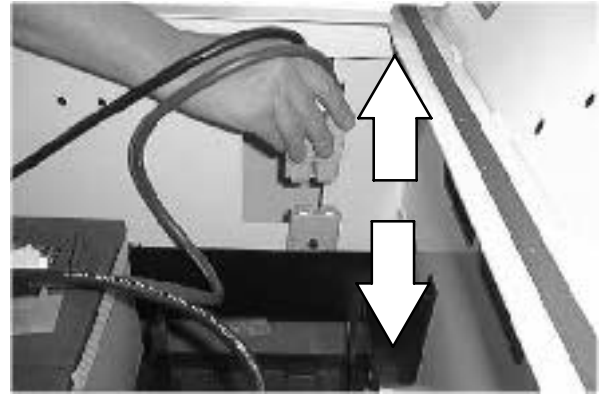

7. Plug the charger connector into the battery connector.

**⚠ WARNING: Batteries emit hydrogen gas. Explosion or fire can result. Keep sparks and open flame away. Keep covers open when charging.**

*NOTE: If the red "ABNORMAL CYCLE" lamp lights when the batteries are plugged into the TENNANT charger, this indicates that something is wrong with the battery. The charger can not charge the battery when this happens.*

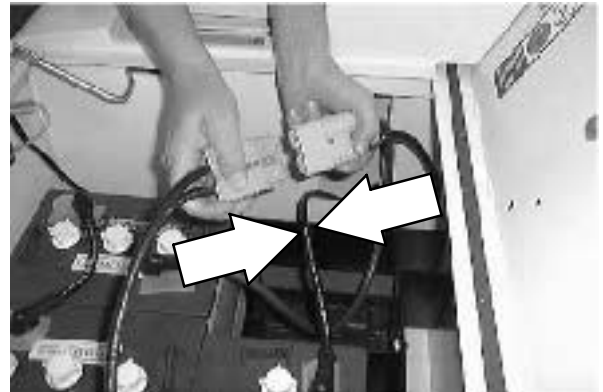

8. The Tennant charger will start automatically. When the batteries are fully charged, the Tennant charger will automatically turn off.

*NOTE: Use a charger with the proper rating for the batteries to prevent damage to the batteries or reduce the battery life.*

*NOTE: If the charger needs to be disconnected from the machine before the batteries are fully charged and the charger has not automatically shut off, turn off the charger before disconnecting it.*



9. After the charger has turned off, unplug the charger connector from the battery connector on the machine.

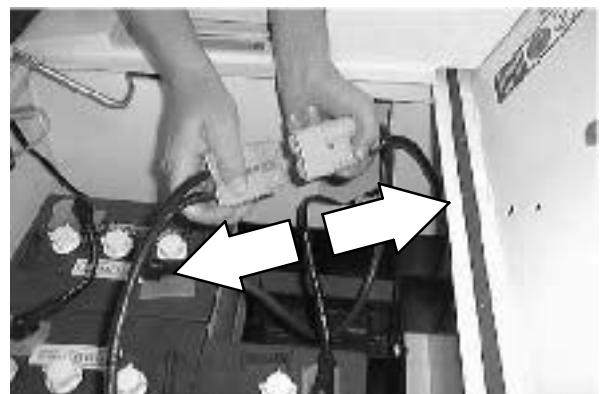

10. Reconnect the battery connector to the machine connector.
11. Check the electrolyte level in each battery cell after charging. If needed, add just enough distilled water to raise the electrolyte level up to about 12mm (0.4 in) below the bottom of the sight tubes.  
  
**FOR SAFETY: When maintaining or servicing machine, avoid contact with battery acid.**
12. Close the seat support.

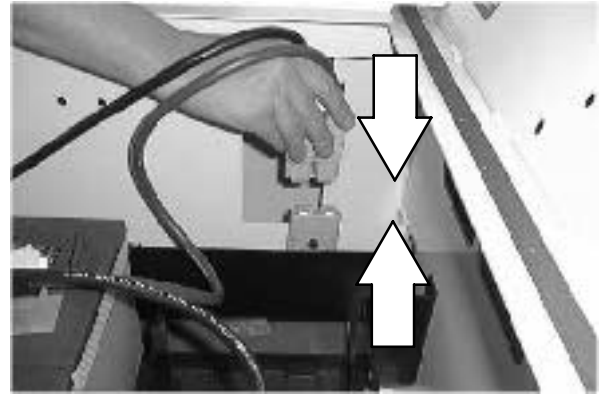

---

## **BELTS AND CHAINS**

---

### **VACUUM FAN BELT**

The vacuum fan belt drives the vacuum system. Check the belt for wear and tension after every 100 hours of operation.

The correct tension is when the belt deflects 12.7 mm from a force of 17 kg at belt midpoint.

**FOR SAFETY: When servicing machine, avoid moving parts. Do not wear loose jackets, shirts or sleeves when working on machine.**

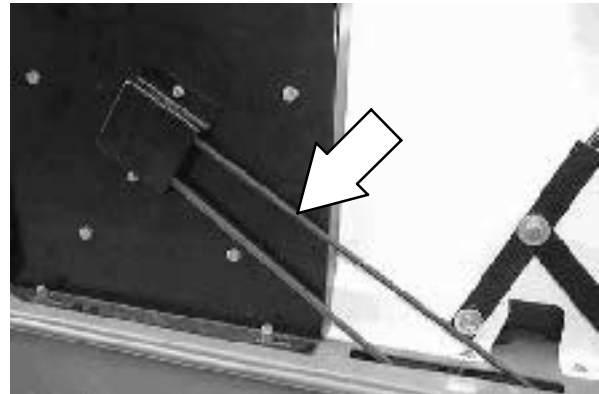

### **MAIN BRUSH BELT**

The main brush belt drives the main brush. Check the main brush belt for wear and tension after every 100 hours of operation.

Set the tension with the top sheave. The correct tension on the belt is when the top sheave is putting 6 kg of pressure on the main brush belt.

**FOR SAFETY: When servicing machine, avoid moving parts. Do not wear loose jackets, shirts or sleeves when working on machine.**

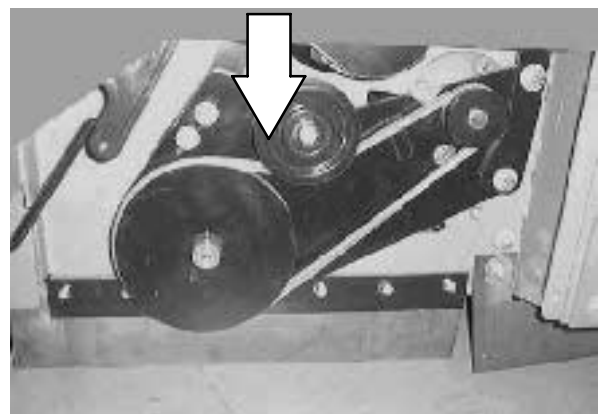

## MAINTENANCE

### STEERING GEAR CHAIN

The steering chain turns the front wheel as the steering wheel is turned to steer the machine. Lubricate the steering chain with SAE 30-weight engine oil after every 200 hours of operation.

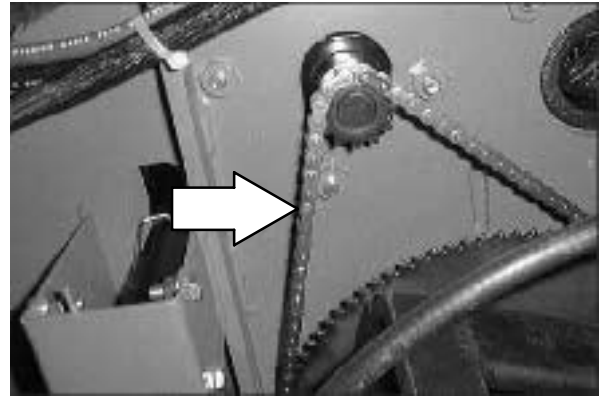

### STATIC DRAG CHAIN

The static drag chain prevents the buildup of static electricity in the machine. The chain is attached to the machine by a rear main brush skirt retaining bolt.

Make sure the chain is touching the floor at all times.

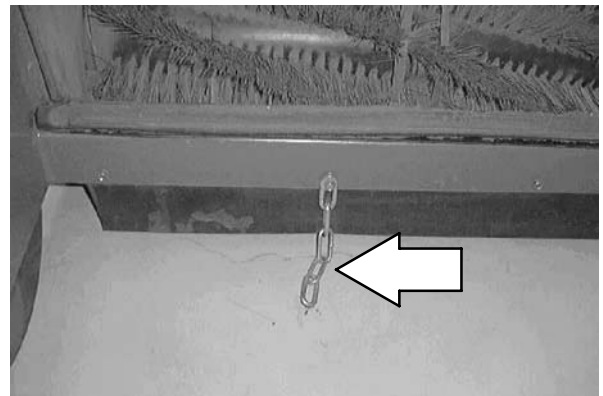

**DEBRIS HOPPER**

**HOPPER DUST FILTER**

The hopper filter filters the air pulled up from the hopper. The dust filter is equipped with a shaker to remove the accumulated dust particles. The dust filter shaker is operated by the main brush, vacuum and filter shaker switch.

Shake the dust filter before emptying the hopper and at the end of every work shift. Check and clean or replace the dust filter after every 100 hours of operation.

To clean the dust filter, use one of the following methods:

- **SHAKING** – Press and hold the main brush, vacuum and filter shaker switch to the **Filter shaker** position.
- **TAPPING** – Remove the filter and tap the filter gently on a flat surface with the dirty side down. Do not damage the edges of the filter element and seals, or the filter will not seat properly in the filter frame.
- **AIR** – Always wear eye protection when using compressed air. Blow air through the dust filter opposite the direction of the arrows. Never use more than 690 kPa (100 psi) of air pressure and never closer than 50 mm (2 in) away from the filter. This may be done with the dust filter in the machine.

**FOR SAFETY: When servicing machine, wear eye and ear protection if using pressurized air or water.**

- **WATER** – Rinse the synthetic filter with a low pressure garden hose through the dust filter opposite the direction of the arrows. The standard dust filter can also be rinsed, but the filter will degrade with each rinsing and should be replaced after rinsing five times.

*NOTE: Be sure the dust filter is completely dry before reinstalling it in the machine.*



## MAINTENANCE

### REMOVING HOPPER DUST FILTER

1. Stop the machine, set the parking brake and turn the machine power off.

**FOR SAFETY: Before leaving or servicing machine, stop on level surface, set parking brake, turn off machine, and remove key.**

2. Unlatch and remove hopper cover.

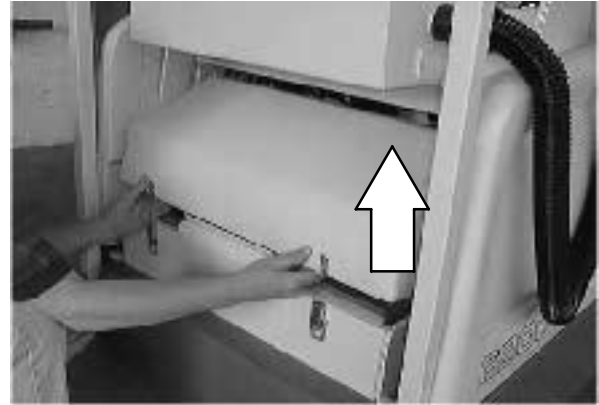

3. Unplug the filter shaker from the main harness.

*NOTE: Carefully pull the wires apart from the bodies of the plugs. Do not unplug the connections from the shaking mechanism. Do not pull on the wires. Damage could occur to the wires or the shaking mechanism.*

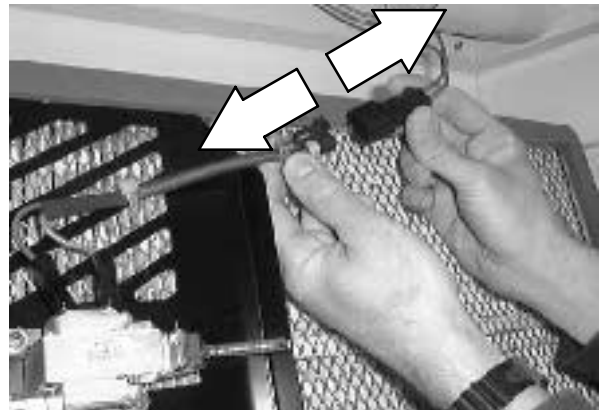

4. Lift dust filter element out of hopper.



5. Lift the VCS system filter shaker off of the filter.

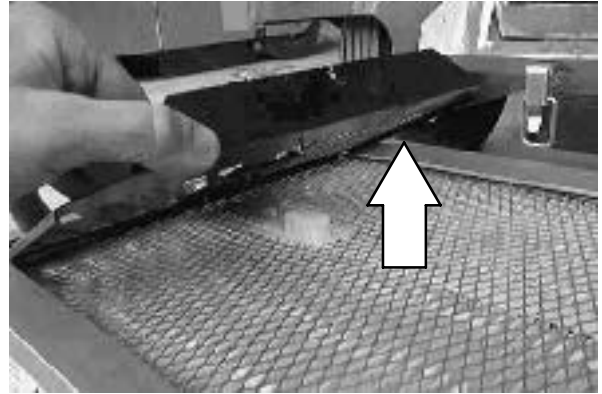

6. Clean or discard the Instant Access filter as required.

7. Place the VCS system filter shaker onto the new or cleaned filter. Use care to insert the shaking pin into the filter comb correctly.

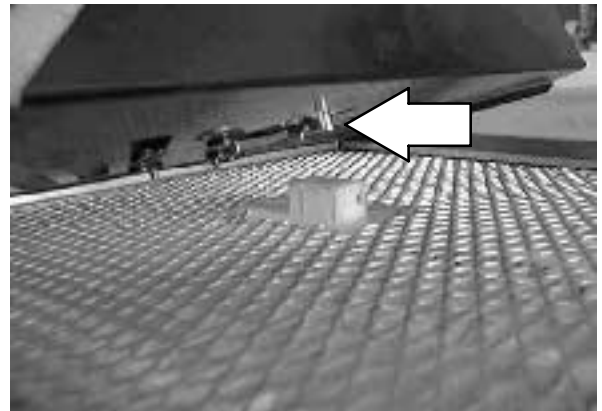

8. Place the edges of the shaker firmly between the filter and the filter seal.

*NOTE: When installed properly, the shaker plate cannot move in either front-to-back or side-to-side directions. If the shaker is loose, it will not function properly.*

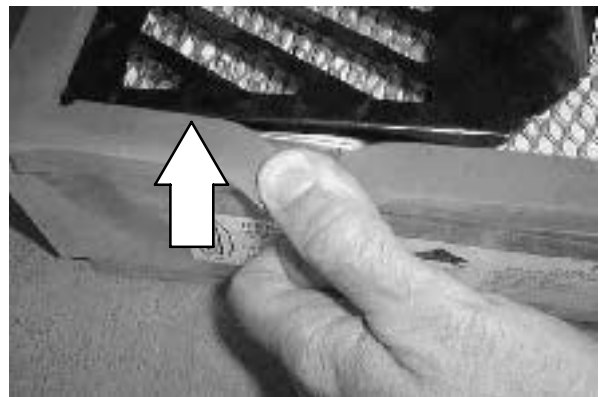

## MAINTENANCE

9. The filter shaker should lay flat against the filter. Check to make sure the comb tab is not caught below the filter shaker plate.

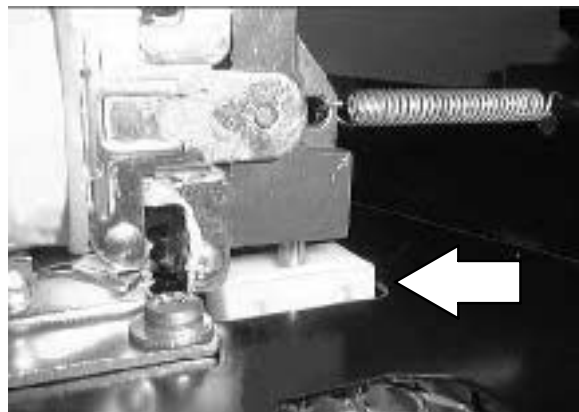

10. Check the shaker selenoid gap with the end of the shipping tab. The gap should be the same width as the tab. If it is not, loosen the mounting screws, adjust the gap by repositioning the shaker selenoid, then retighten the screws.

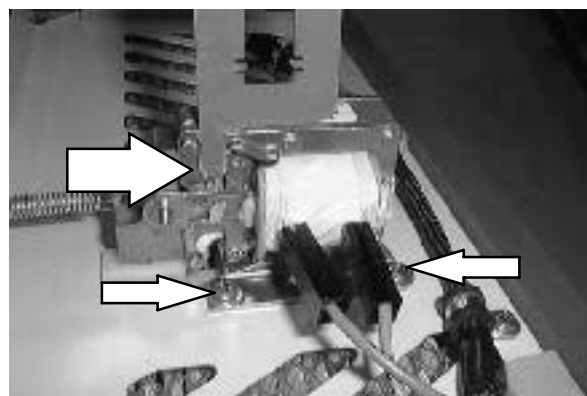

11. Return the filter back to the machine.



12. Reconnect the main harness to the shaker mechanism.

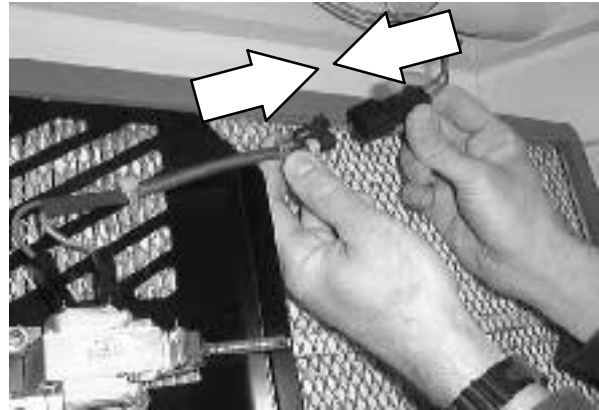

13. Check the dust filter seals.

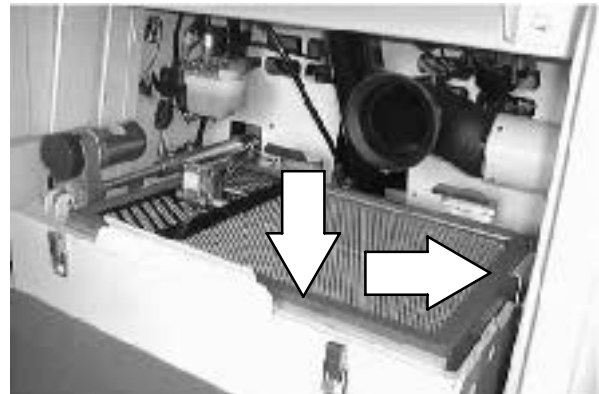

14. Replace hopper cover and secure with latches.

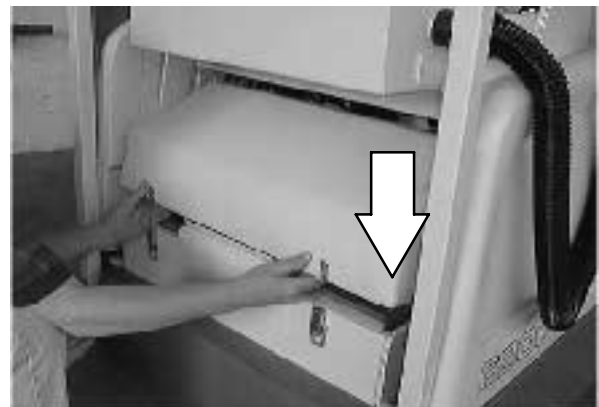

### **THERMO SENTRY**

The Thermo Sentry is located above the debris hopper.

If a fire ignites in the hopper, the Thermo Sentry will shut off the main brush and the vacuum fan. If this occurs, drive the machine to a safe location, open the hopper and eliminate the source of heat. Turn the machine off and back on to reset the Thermo Sentry.



## BRUSHES

### MAIN BRUSH

The main brush is cylindrical and spans the width of the machine, sweeping debris into the hopper.

Check the brush daily for wear or damage. Remove any string or wire tangled on the main brush, main brush drive hub, or main brush idler hub.

Check the main brush pattern weekly. The pattern should be 50 to 75 mm wide with the main brush in the lowered position.

Rotate the main brush end-for-end after every 50 hours of operation for maximum brush life and best sweeping performance.

Sweeping performance often becomes less effective as the bristle length is worn. Replace the main brush when the remaining bristles measure between 40 mm (1-1/2 in) and 50 mm (2 in) in length.

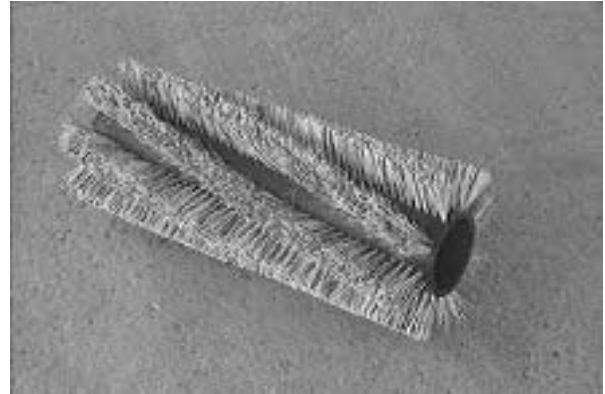

### REPLACING MAIN BRUSH

1. Stop the machine, set the parking brake and turn the machine power off.

**FOR SAFETY: Before leaving or servicing machine, stop on level surface, set parking brake, turn off machine, and remove key.**

2. Open the left side main brush access door.

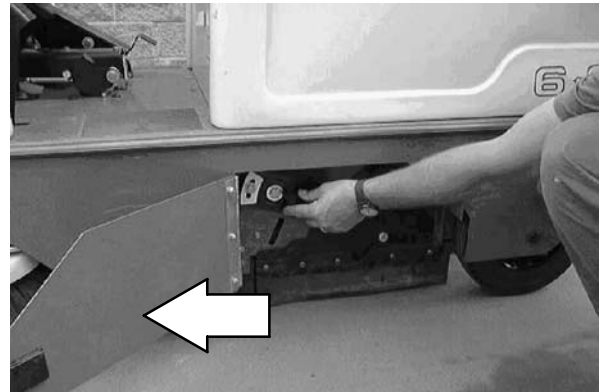

3. Loosen the idler arm mounting knob and three other side skirt mounting knobs. Remove the brush idler arm assembly.



4. Grasp the main brush; pull it off the brush drive plug and out of the main brush compartment.
5. Put the new or rotated end-for-end main brush on the floor next to the access door.
6. Slide the main brush onto the drive plug. Rotate the brush until it engages the drive plug, and push it all the way onto the plug.



7. Check that the recirculation skirt is tucked in behind the frame.
8. Slide the main brush idler arm plug onto the main brush.

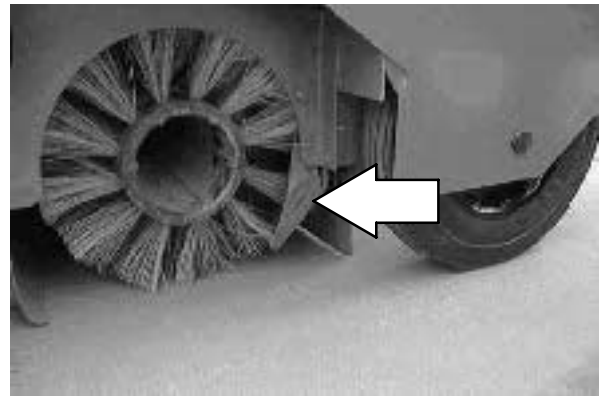

9. Secure the idler arm on the bolts. Hand tighten the mounting knobs.
10. Close the main brush access door.

### CHECKING AND ADJUSTING MAIN BRUSH PATTERN

1. Apply chalk, or some other material that will not blow away easily, to a smooth, level floor.
2. Raise the side brush and main brush and position the main brush over the chalked area.
3. Start and lower the main brush for 15 to 20 seconds while keeping a foot on the brakes to keep the machine from moving.

*NOTE: If chalk or other material is not available, allow the brushes to spin on the floor for two minutes. A polish mark will remain on the floor.*

4. Raise the main brush.
5. Drive the machine off the test area.

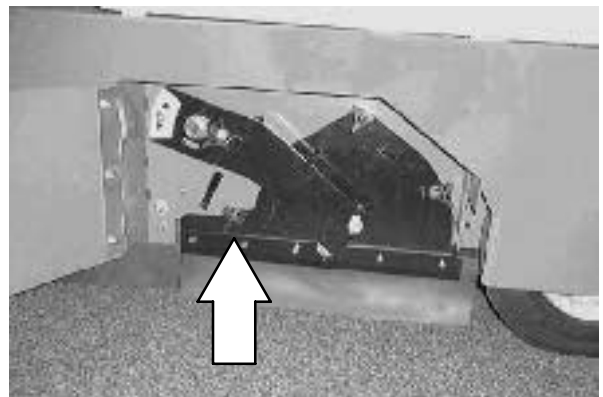

## MAINTENANCE

6. Observe the width of the brush pattern. The proper brush pattern width is 50 to 75 mm.

The brush taper is factory set and should not need adjustment unless parts of the brush system have been replaced.

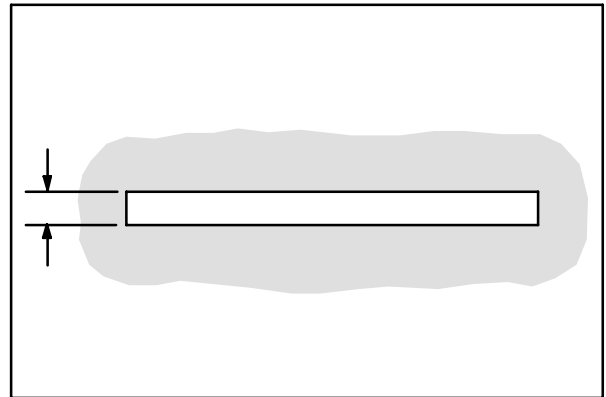

00582

If the main brush pattern is tapered, more than 15 mm on one end than the other, adjust the taper as follows:

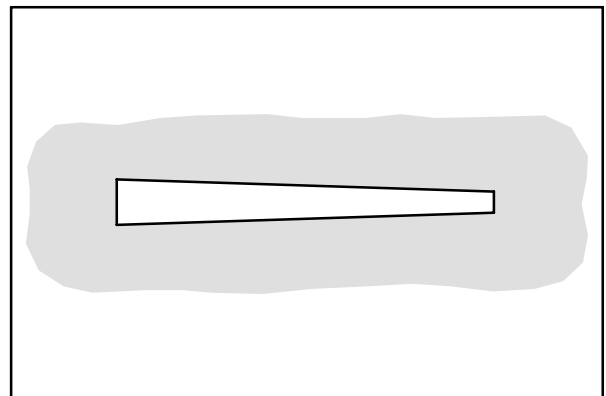

00601

- A. Loosen the brush shaft bearing bracket mounting bolt and the idler arm securing head.

- B. Allow the brush to operate and float into position for approximately 30 seconds.

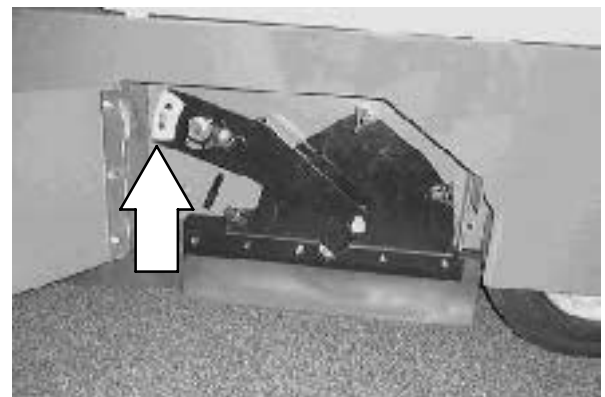

- C. Tighten the adjustment bolt and idler arm securing knob.
- D. Check the main brush pattern and readjust as necessary.

**SIDE BRUSH**

The side brush sweeps debris along edges into the path of the main brush.

Check the brush daily for wear or damage. Remove any string or wire found tangled on the side brush or side brush drive hub.

Check the side brush pattern daily. The side brush bristles should contact the floor in a 10 o'clock to 3 o'clock pattern when the brush is in motion.

The side brush should be replaced when it no longer sweeps effectively for your application. A guideline length is when the remaining bristles measure 50 mm in length. You may need to replace the side brush sooner if you are sweeping light litter or use a brush with shorter bristles if you are sweeping heavy debris.

Adjust the side brush pattern by loosening the hex screw located above the side brush pulley. Move the pulley mount bracket up or down to achieve the proper side brush pattern. Retighten the hex screw.

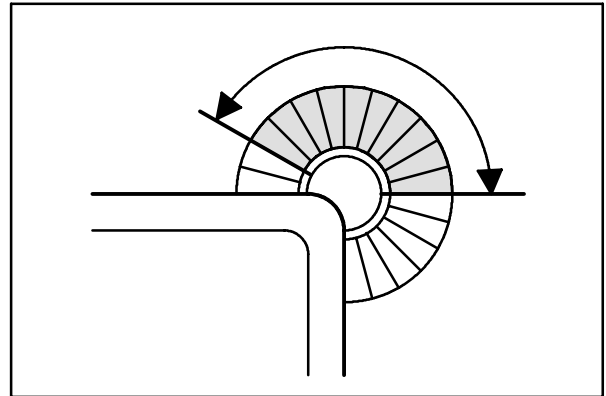

350327

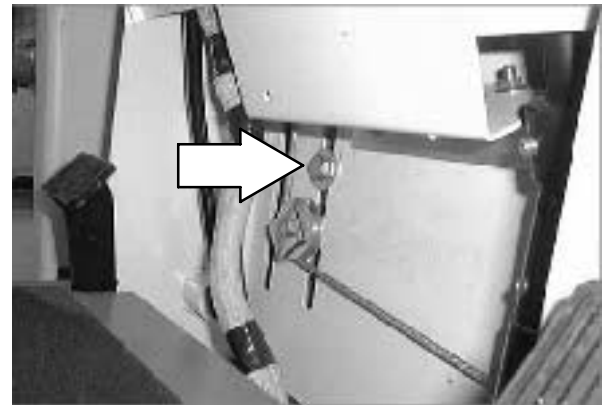

## MAINTENANCE

### REPLACING SIDE BRUSH

1. Stop the machine, set the parking brake and turn the machine power off.

**FOR SAFETY: Before leaving or servicing machine, stop on level surface, set parking brake, turn off machine, and remove key.**

2. Remove the side brush retaining pin from the side brush drive shaft by pulling the pin keeper off over the end of the pin.
3. Slide the side brush off the side brush drive shaft.
4. Slide the new side brush onto the side brush drive shaft.
5. Insert the side brush retaining pin through the side brush hub and shaft.
6. Secure the pin by clipping the pin keeper over the end of the pin.



### SIDE BRUSH GUARD

Check the side brush guard for damage or wear every 200 hours of operation. Replace the guard when it becomes worn.



---

**SKIRTS AND SEALS**

---

**SIDE SKIRTS**

The side skirts are located on both sides of the machine in front of the main brush compartment. The side skirts should clear the floor up to 5 mm.

Check the skirts for damage, wear and adjustment daily.

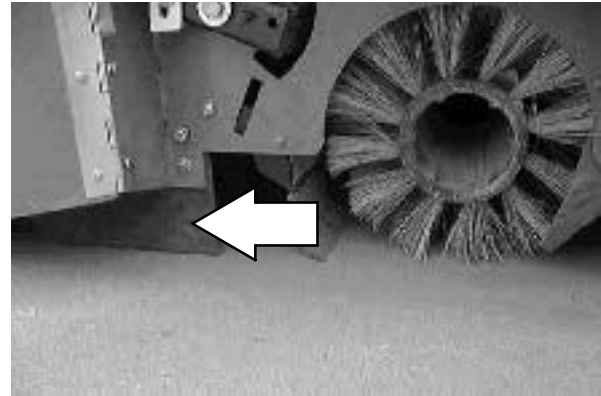
**LARGE DEBRIS TRAP SKIRT**

The large debris trap skirt is located along the front of the main brush. This skirt is raised and lowered by the large debris trap pedal, allowing larger debris to be trapped and swept up into the hopper.

Check the skirt for damage and wear daily.

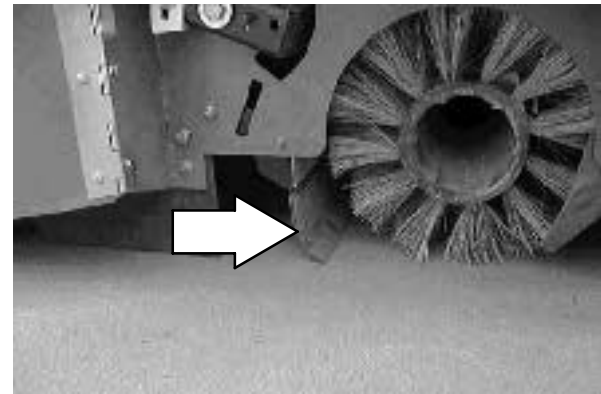
**SIDE RECIRCULATION SKIRTS**

The side recirculation skirts are located on both sides of the main brush compartment. The side recirculation skirts should clear the floor up to 5 mm.

Check the skirts for damage, wear and adjustment daily.

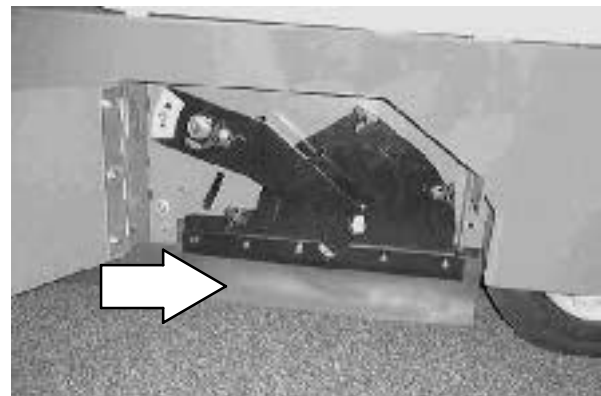

### REAR SKIRTS

The two rear skirts are located on the bottom rear of the main brush compartment. The vertical skirt should clear the floor up to 5 mm. The rear recirculation skirt requires no adjustment.

Check the skirts for damage, wear and adjustment daily.

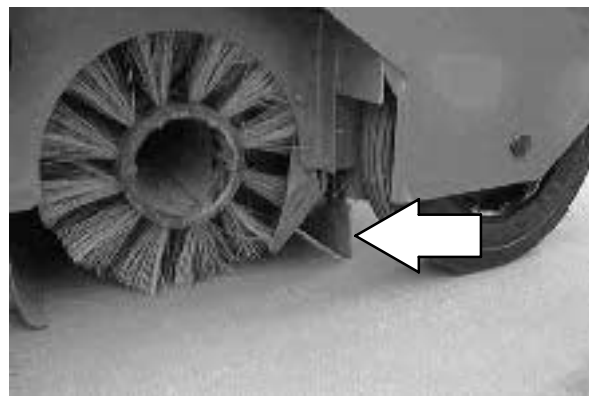

*NOTE: The rear recirculation skirt must be folded in between the brush and the machine frame before the brush door is mounted for the machine to work properly.*

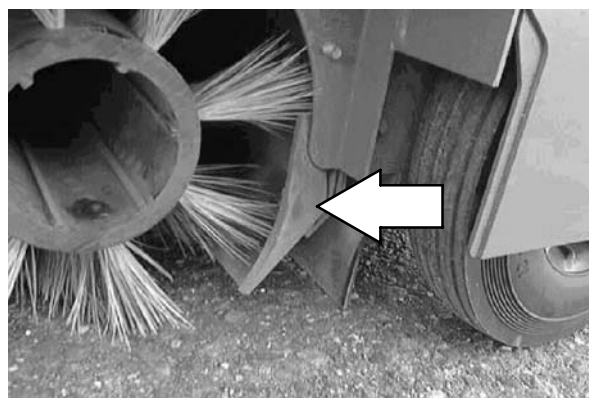
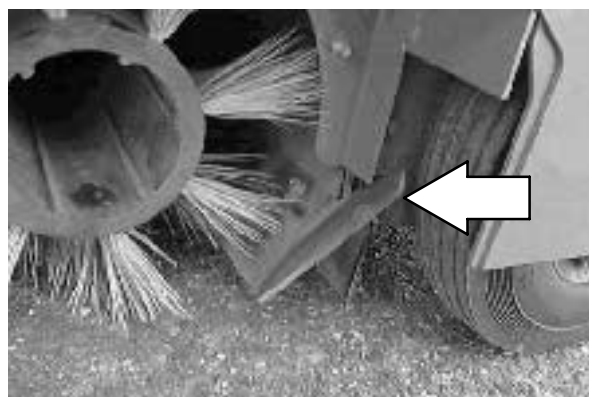

**HOPPER SEALS**

The hopper seals are located around the edge of the opening between the main brush and the hopper. The hopper rests against the seals when the hopper is in the closed position.

Check the seals for wear or damage after every 100 hours of operation.

 **WARNING: Raised hopper may fall.**  
Engage hopper support bar.

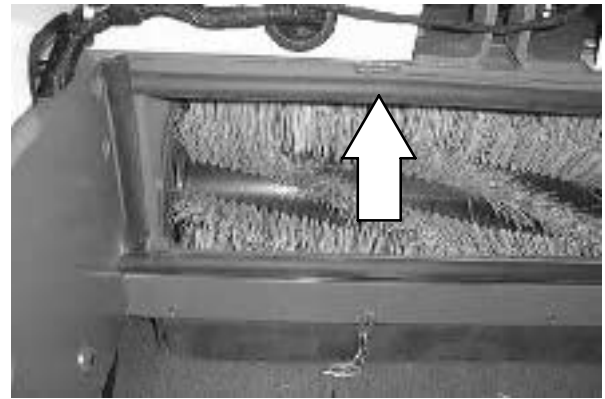
**HOPPER DOOR SEAL**

The hopper door seal is located on the bottom of the hopper and seals the hopper door when the hopper door is closed.

Check the seal for wear or damage after every 100 hours of operation.

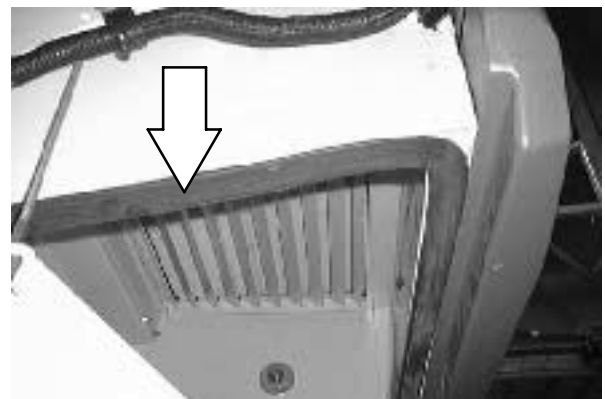
**HOPPER LIP SEAL**

The hopper lip seal is located on the inside of the rear lip of the hopper door and seals the inside lip of the hopper door with the hopper.

Check the seal for wear or damage after every 100 hours of operation.



## MAINTENANCE

### VACUUM SEAL

The vacuum seal is located behind the debris hopper and seals with the hopper filter cover when the hopper is in the lowered position.

Check the seal for wear or damage after every 100 hours of operation.

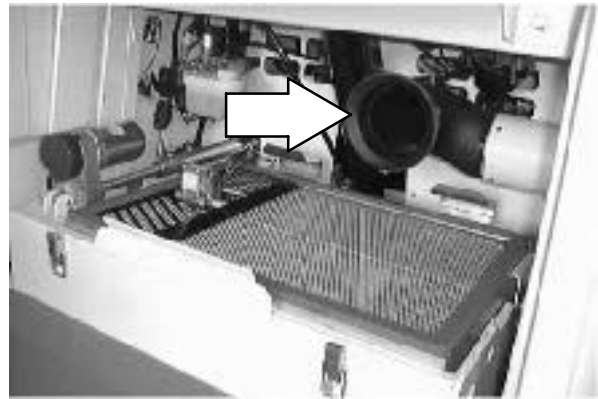

### HOPPER FILTER SEALS

The hopper filter seals are located along the outside edge of the top and the bottom of the hopper filter. The hopper filter seals seal the hopper filter in between the hopper baffle plate and the hopper filter cover when the hopper filter cover is latched down in the proper operating position.

Check the seals for wear or damage after every 100 hours of operation.

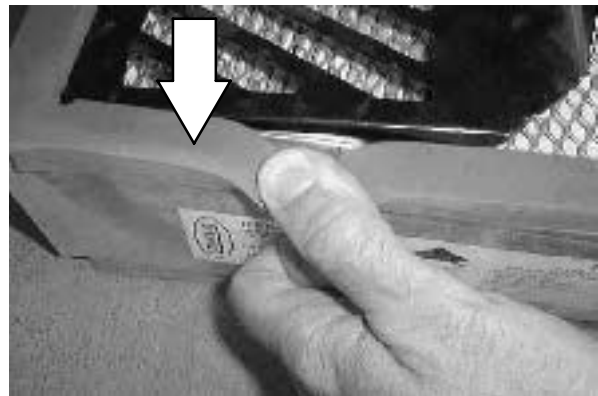

---

**BRAKES AND TIRES**

---

**BRAKES**

The mechanical brake is located on the front wheel. The brake is operated by the brake foot pedal, connecting rods and cable.

Check the brake adjustment after every 200 hours of operation. If the brake does not respond well to pressure on the brake pedal, you may need to adjust the brake.

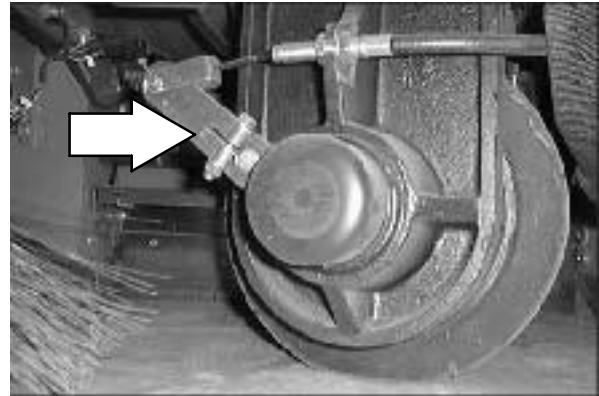

Adjust brake cable tension with cable nuts and brake lever.

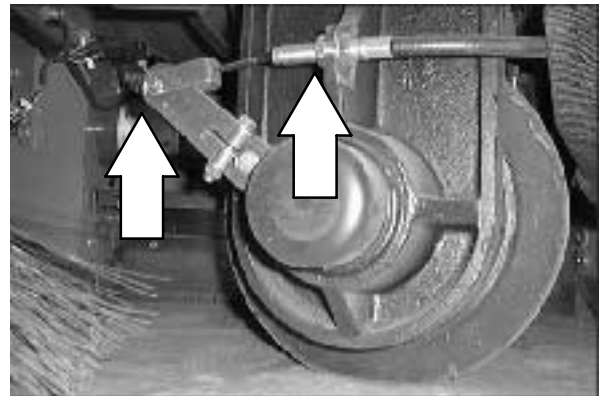

## MAINTENANCE

---

### TIRES

The tires on the machine are solid. Check the tires after every 100 hours of operation for damage.

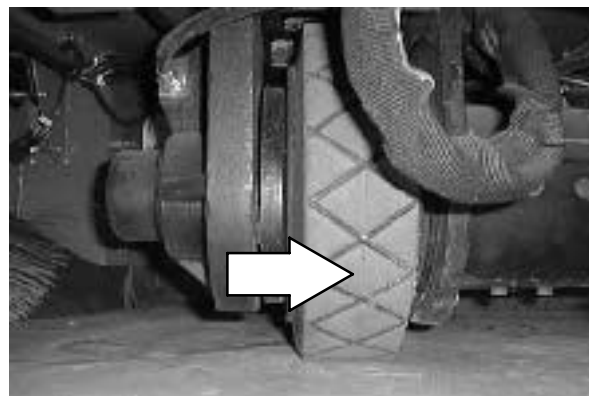

Check the torque on the rear wheel axles every 800 hours of operation. The proper torque on rear wheel axle is 22.4-28 Nm (16-20 ft lbs).

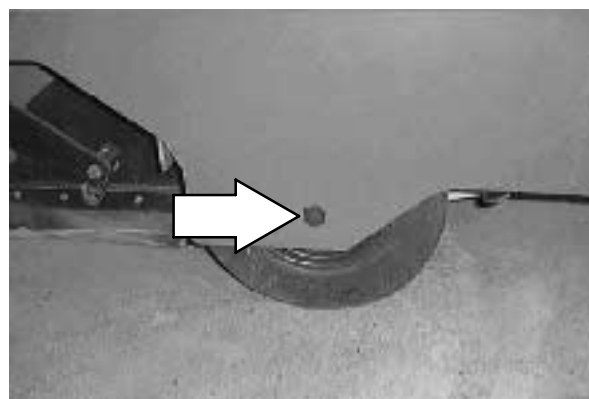

---

### ELECTRIC MOTORS

---

The carbon brushes on the propelling, vacuum fan, and brush motors should be inspected every 800 hours of operation.

**PUSHING, TOWING, AND TRANSPORTING THE MACHINE**

**PUSHING OR TOWING THE MACHINE**

If the machine becomes disabled, it can be pushed or towed from the front or rear, but it is easier and more stable to tow from the front end.

Only push or tow the machine for a *very short distance* and do not exceed 3.2 kp/h (2 mph). It is NOT intended to be pushed or towed for a long distance or at a high speed.

**ATTENTION! Do not push or tow machine for a long distance or damage may occur to the propelling system.**

**TRANSPORTING THE MACHINE**

1. Position the front of the machine at the loading edge of the truck or trailer.

**FOR SAFETY: Use truck or trailer that will support the weight of the machine.**

*NOTE: Empty the hopper before transporting the machine.*

2. If the loading surface is not horizontal or is higher than 380 mm (15 in) from the ground, use a winch to load machine.

If the loading surface is horizontal AND is 380 mm (15 in) or less from the ground, the machine may be driven onto the truck or trailer.



3. To winch the machine onto the truck or trailer, attach the winching chains to the front tie down located in the front of the machine frame.

**FOR SAFETY: When loading machine onto truck or trailer, use winch. Do not drive the machine onto the truck or trailer unless the loading surface is horizontal AND is 380 mm (15 in) or less from the ground.**

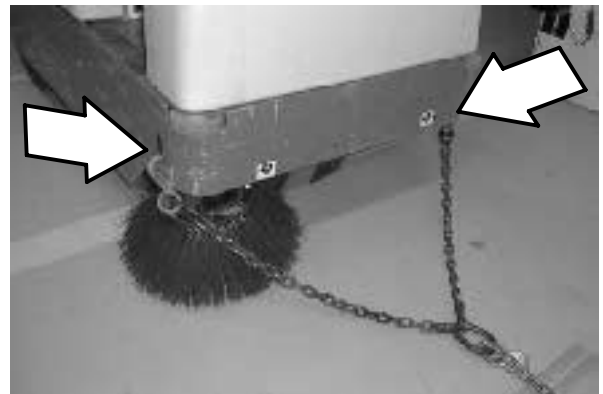

## MAINTENANCE

4. Position the machine onto the truck or trailer as far as possible. If the machine starts to veer off the centerline of the truck or trailer, stop and turn the steering wheel to center the machine.
5. Set the parking brake and block the machine tires. Tie down the machine to the truck or trailer before transporting.

The front tie-down locations are the holes in the front of the machine frame.

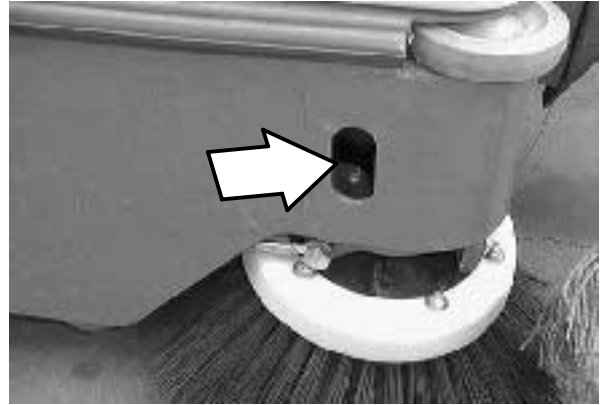

The rear tie-down locations are the holes in the sides of the machine frame near the rear bumper.



6. If the loading surface is not horizontal or is higher than 380 mm (15 in) from the ground, use a winch to unload machine.

If the loading surface is horizontal AND is 380 mm (15 in) or less from the ground, the machine may be driven off the truck or trailer.

**FOR SAFETY: When unloading machine off truck or trailer, use winch. Do not drive the machine off the truck or trailer unless the loading surface is horizontal AND 380 mm (15 in) or less from the ground.**

---

**MACHINE JACKING**

---

Empty the hopper before jacking the machine. You can jack up the machine for service at the designated locations. Use a hoist or jack that will support the weight of the machine. Always stop the machine on a flat, level surface and block the tires before jacking up the machine.

**FOR SAFETY: Before leaving or servicing machine, stop on level surface, set parking brake, turn off machine, and remove key.**

The front jacking locations are on the flat bottom edge of the front of the machine frame.

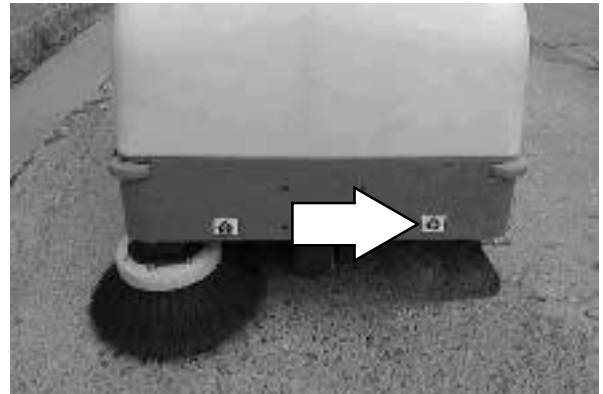

The rear jacking locations are on the corners of the rear frame.

**FOR SAFETY: When servicing machine, block machine tires before jacking up machine.**

**FOR SAFETY: When servicing machine, jack up machine at designated locations only. Block machine up with jack stands.**



---

**STORING MACHINE**

---

Before storing the machine for an extended time, the machine needs to be serviced to lessen the chance of rust, sludge, and other undesirable deposits from forming. Contact Tennant service personnel

**SPECIFICATIONS**

**GENERAL MACHINE DIMENSIONS/CAPACITIES**

Item	Dimension/capacity
Length	1955 mm
Width	1070 mm
Width w/side brush	1117 mm
Height	1435 mm
Height with overhead guard	2045 mm
Track	94 mm
Wheelbase	97 mm
Main sweeping brush diameter	203 mm
Main sweeping brush length	710 mm
Side brush diameter	520 mm
Sweeping path width	710 mm
Sweeping path width with one side brush	1070 mm
Sweeping path width with two side brushes	1397 mm
Main sweeping brush pattern width	65 mm
Hopper weight capacity	135 kg
Hopper volume capacity	125 L
Dust filter area	4.5 sq m
Ceiling height minimum dumping clearance	2286 mm
Sound level continuous	68 ± 1 dB(A)
Sound level peak	80 ± 1 dB(C)
Vibration level does not exceed	2.5 m/s <sup>2</sup>
GVWR	923 kg

**GENERAL MACHINE PERFORMANCE**

Item	Measure
Maximum forward speed	10.0 km/h
Maximum reverse speed	4.8 km/h
Minimum aisle turn	2095 mm
Minimum turning radius, left	1400 mm
Minimum turning radius, right	1400 mm
Maximum rated incline with empty hopper	10°/18%
Maximum rated incline with full hopper	6°/11%

**POWER TYPE**

Type	Quantity	Volts	Ah Rating	Weight
Batteries	6	6	220 @ hr rate	177 kg
	6	6	235 @ hr rate	177 kg
	6	6	335 @ hr rate	310 kg

Type	Use	VDC	Kw (hp)
Electric Motors	Propelling	36	1.1 Kw
	Scrub brush (main)	36	0.67 Kw
	Vacuum fan	36	0.60 Kw

Type	VDC	A	Hz	Phase	VAC
Charger	36	20	60	1	240

**STEERING**

Type	Power source	Emergency steering
Front wheel, manual controlled	Manual steering	Manual

**HYDRAULIC SYSTEM**

System	Capacity	Fluid Type
Hydraulic reservoir	.53 L	TENNANT part no. 65870
Hydraulic total	1.4 L	

**BRAKING SYSTEM**

Type	Operation
Service brakes	Mechanical disc brake (1), one front wheel, cable actuated
Parking brake	Utilizes service brakes, cable actuated

**TIRES**

Location	Type	Size
Front (1)	Solid	101 x 305 mm
Rear (2)	Solid	90 x 305 mm

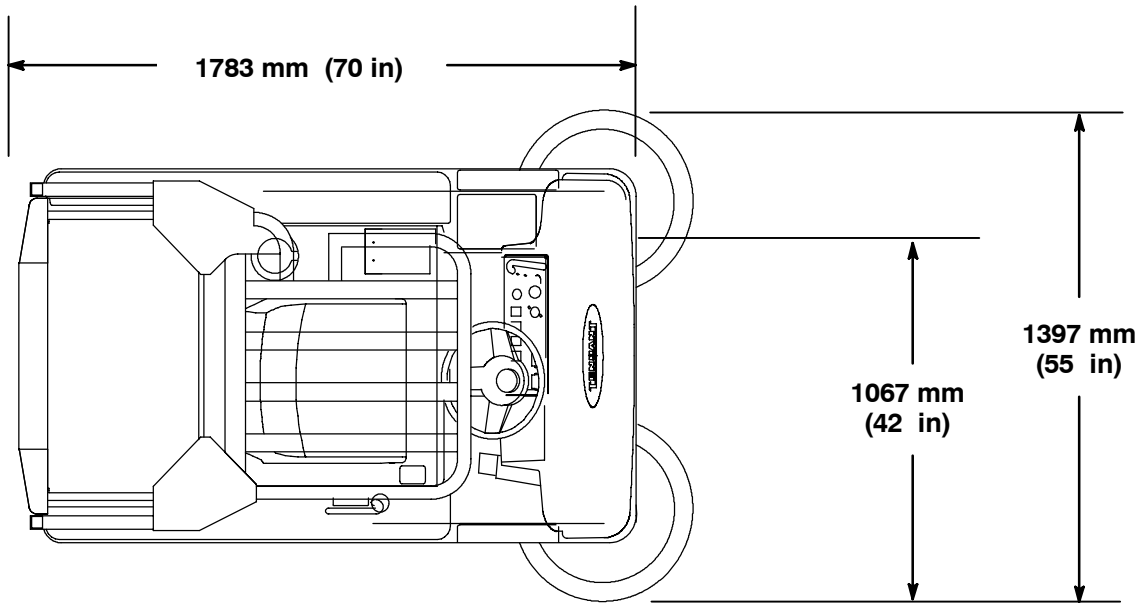

**TOP VIEW**

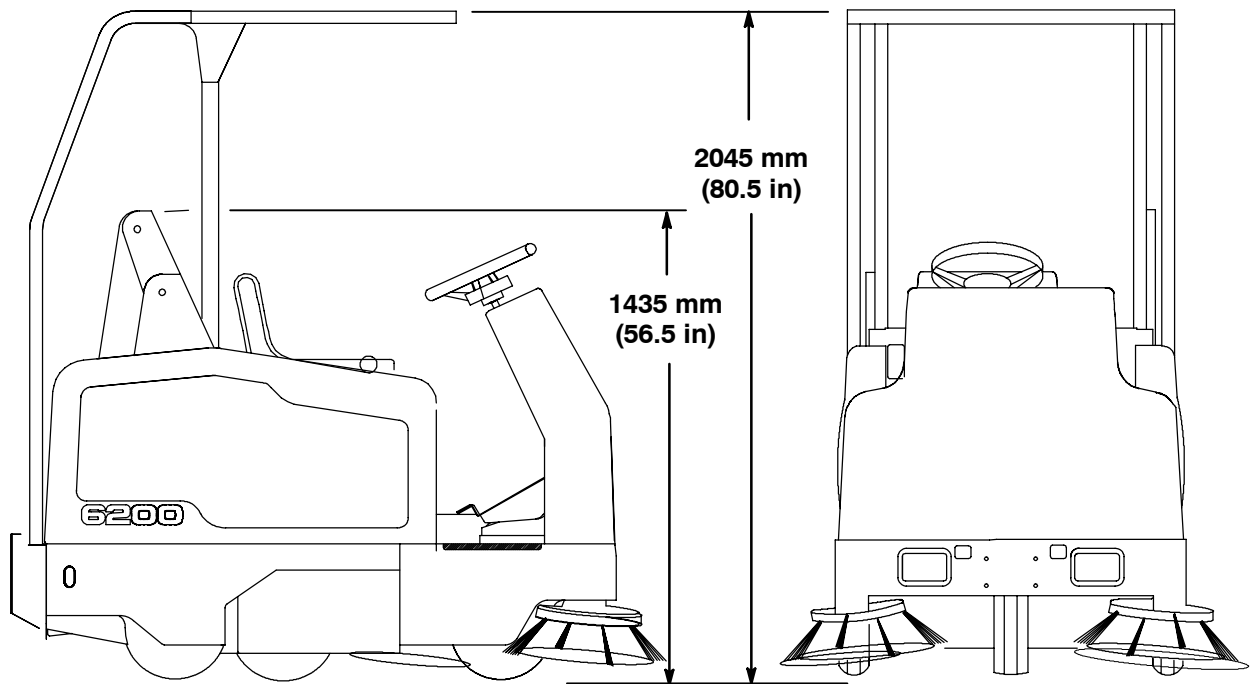

**SIDE VIEW**

**FRONT VIEW**

**MACHINE DIMENSIONS**

352945