

DCS 500 Thyristor Power Converters for DC Drive Systems 25 to 5150 A

Operating Instructions DCS 500B / DCF 500B DCP 500B



How the DCS 500 Documentation System works

Description of the converter

Volume II D
System Description
DCS 500B
3ADW000066

Volume III
Technical Data
3ADW000054

Volume IV D
Operating Instructions
DCS 500B
3ADW000055

DCS 500B **Operating Instructions** (documentation in hand) including information and advice to commission the drive. If three phase DCF 500B field supply units are needed please use the same documents as for DCS 500B armature converters.

As additional documentation is available:

The **System description** describes the functionality of DCS 500 converter units as well as the cooperation of all single components belonging to a complete drive system.

DCS 500 **Technical Data** giving information about all direct technical data for components used inside and outside the converter module.

The above mentioned documents are usually delivered together with all ordered converter units of the DCS 500 family and represent the basic knowledge which is essential for all users of this product.

Supplementary documentation

Volume II D1
System Description
DCA 500B
3ADW000148

DCA 500 **System description** for standard cubicles equipped with DC drives.

Volume V D2
Application Blocks
DCS 500B
3ADW000048

Volume V D1
SW Description
DCS 500B
3ADW000078

For those, who want to reprogram or adapt the software of their drive a detailed comprehensive description of the **software structure** of the drive as well as of all available **function blocks** can be delivered. This documentation is only available as data file in English language.

As separate document for service engineers a DCS 500 **Service Manual** can be ordered .

Volume VII A
Technical Guide
DCS
3ADW000163

Volume VI A
Service Manual
DCS 500(B)/600
3ADW000093

Engineering and design people for drive systems can get a separate collection of information with regard to installation, sizing, fusing etc. of DC drives called "**Technical guide**".

Thyristor Power Converters

Series

DCS 500B / DCF 500B

DCP 500B

25 to 5150 A

OPERATING INSTRUCTIONS

Code: 3ADW 000 055 R0401 Rev D

DCS_OI_E_D.DOC

EFFECTIVE: Oct. 30th, 2002
SUPERSEDES: Rev C Sept. 14th, 2001

Safety Instructions

Overview

This chapter contains safety instructions which must be complied with during installation, operation and maintenance of the power converters series **DCS 500B / DCF 500B or DCP 500B**. If these instructions are not complied with, this may result in injuries (perhaps even with fatal) or in damage to the power converter, the motor and the driven machine. Before starting with any work whatsoever at or with this unit, you must read the information given in this chapter.

Warnings

Warnings provide information on states which if the specified procedure for the state concerned is not meticulously complied with may result in a serious error, in major damage to the unit, in injury to persons and even in death.

They are identified by the following symbols:

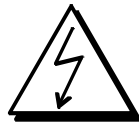

Danger: High Voltage! This symbol warns you of high voltages which may result in injuries to persons and/or damage to equipment. Where appropriate, the text printed adjacent to this symbol describes how risks of this kind may be avoided.

- All electrical installation and maintenance work on the thyristor power converter must be carried out by properly qualified staff who have been thoroughly trained in electrical engineering.
- The thyristor power converter and its adjacent units must be properly earthed by qualified professionals.
- You must NEVER perform any work on the thyristor power converter while it is still switched on. First switch the unit off, use a measuring instrument to make absolutely sure that the power converter has really been de-energized, and only then you may start with the work concerned.
- Due to external control circuits, there may be dangerously high voltages present at the thyristor power converter even after the line voltage has been switched off. So always work at the unit with appropriate caution! Non-compliance with these instructions may result in injury (or even death!).



General warning: this symbol warns you of non-electrical risks and dangers which may result in serious or even fatal injury to persons and/or in damage to equipment. Where appropriate, the text printed adjacent to this symbol describes how risks of this kind may be avoided.

- When thyristor power converters are in use, the electric motors, power transmission elements and the driven machines are working in an extended operating range, which means they have to cope with a relatively high loading.
- You should have made sure that all units, devices and appliances used are actually suitable for this higher loading.
- If you have to operate the thyristor power converter at a rated motor voltage and/or a rated motor current significantly below the figures stated in the thyristor power converter's output data, you must take appropriate precautionary measures to protect the unit against overspeed, overload, breakage, etc., by modifying the software or hardware appropriately.
- For insulation testing, you must disconnect all cables from the thyristor power converter. You should avoid operating your unit at values other than the rated data. Non-compliance with these instructions may cause lasting damage to the thyristor power converter.
- The thyristor power converter possesses a number of automatic reset functions. When these functions are executed, the unit will be reset after an error and will then resume operation. These functions should not be used if other units and devices are not suitable for an operating mode of this kind, or if their use might entail dangerous situations.



Warning of electrostatic discharge: this symbol warns you against electrostatic discharges which may damage the unit. Where appropriate, the text printed next to this symbol describes how a risk of this kind may be avoided.

Notes

Notes supply information on states requiring particular attention, or indicate that additional information is available on a specific topic. For this purpose, the following symbols are used:

CAUTION! **Cautions** are designed to draw your attention to a particular state of affairs.

Note A **note** contains or refers you to additional information available on the particular topic concerned.

Mains connection

You can use a switch disconnecter (with fuses) in the power supply of the thyristor power converter to disconnect the electrical components of the unit from the power supply for installation and maintenance work. The type of disconnecter used must be a switch disconnecter as per EN 60947-3, Class B, so as to comply with EU regulations, or a circuit-breaker type which switches off the load circuit by means of an auxiliary contact causing the breaker's main contacts to open. The mains disconnecter must be locked in its "OPEN" position during any installation and maintenance work.

EMERGENCY STOP buttons

EMERGENCY STOP buttons must be installed at each control desk and at all other control panels requiring an emergency stop function. Pressing the STOP button on the CDP 31x control panel of the thyristor power converter will neither cause an emergency motor stop, nor will the drive be disconnected from any dangerous potential.

Intended use

The operating instructions cannot take into consideration every possible case of configuration, operation or maintenance. Thus, they mainly give such advice only, which is required by qualified personnel for normal operation of the machines and devices in industrial installations.

If in special cases the electrical machines and devices are intended for use in non-industrial installations - which may require stricter safety regulations (e.g. protection against contact by children or similar) -, these additional safety measures for the installation must be provided by the customer during assembly.

Contents

IV A OPERATING INSTRUCTIONS

Safety Instructions

Chapter 1 - Introduction

How to use this manual	1-1
Contents of this manual.....	1-1
Target group	1-1
Associated publications.....	1-1
Incoming inspection.....	1-2
Storage and transport.....	1-2
Rating plate	1-2

Chapter 2 - Start-Up Instructions

General notes	2-1
2.1 Preparatory work	2-5
2.2 Scaling intra-unit signals.....	2-6
2.3 Presetting the field supply unit.....	2-8
2.4 Adjusting the current controller.....	2-10
2.5 Speed feedback balancing	2-12
2.6 Balancing the field supply unit and the e.m.f. controller	2-14
2.7 Balancing the speed controller, plus fine-balancing the e.m.f. and the current contr.	2-20
2.8 Matching the thyristor power converter unit to the system conditions concerned	2-21
2.9 Presetting the 3-phase field supply unit DCF 50xB	2-22

Chapter 3 - Handling of Control Panel CDP 31x

3.1 Overview.....	3-1
Panel Link	3-1
Mounting the Panel.....	3-1
3.2 Start Mode	3-2
3.3 Panel Functions.....	3-3
Actual Signal Display Mode	3-3
Parameter Mode	3-4
Function Mode	3-4
Drive Mode.....	3-5
3.4 Pin/Parameter Selecting and Changing of Value	3-5
3.5 Saving of the Parameters to backup memory	3-7
3.6 FAULT RESETTING (RESET)	3-8
3.7 EMERGENCY STOP RESETTING (RESET).....	3-8
3.8 Fault History Display.....	3-9
3.9 Uploading and Downloading of Parameters (UPLOAD/DOWNLOAD).....	3-10
3.10 Setting of the Display Contrast.....	3-12
3.11 Full Name of output pins.....	3-12
3.12 Selecting output pins	3-13
3.13 Drive Mode	3-14
3.14 Running the Drive.....	3-15
Operational Command Keys.....	3-15

Running the DC- Drive from the CDP31x	3-15
3.15 Speed Reference Setting for the Drive.....	3-16
Chapter 4 - Signals and Troubleshooting	
4.1 Display of status, alarm and fault signals	4-1
Categories of signals and possibilities of display.....	4-1
4.2 General messages	4-2
4.3 Starting errors (E).....	4-2
4.4 Fault Signals (F).....	4-3
4.5 Alarm Signals (A)	4-12
4.6 Status Signals	4-17
Appendix A - Connection diagrams	
Connection diagram 1	A-1
Connection diagram 2	A-2

Chapter 1 - Introduction

How to use this manual The purpose of these operating instructions is to provide detailed information on how to start up a thyristor power converter from the **DCS 500B** or **DCP 500B** series.

Note: If it is not mentioned explicitly all details given in these Operating Instructions will be valid for both, series **DCS 500B / DCF 500B** and series **DCP 500B**!

Contents of this manual **Chapter 1 - Introduction**
It describes how to use this manual and the boundary conditions applying.

Chapter 2 - Start-Up Instructions

We recommend working your way through the Start-Up Instructions step by step, since in this way you will get to perform all important parameter setting routines.

Chapter 3 - How to Handle the Control and Display Panel

This chapter describes how to operate the CDP 31x control and display panel.

Chapter 4 - Signals and Troubleshooting

This chapter describes the available signals and possibilities of display with **DCS 500B** and **DCP 500B**. As far as fault signals are concerned there will be indicated measures (actions) to be taken for troubleshooting.

Target group This manual is designed to help those responsible for planning, installing, starting up and servicing the thyristor power converter. These people should possess

- basic knowledge of physics and electrical engineering, electrical wiring principles, components and symbols used in electrical engineering, and
- basic experience with DC drives and products.

Associated publications The **DCS 500B / DCF 500B** or **DCP 500B** documentation includes the following:

- *System Description DCS 500B / DCF 500B*
- *System Description DCP 500B*
- *Technical Data DCS 500B / DCF 500B, DCP 500B*
- *Operating Instructions* (this document)

Incoming inspection

After opening this package, you should check whether it contains the following items:

- DCS 500B / DCF 500B or DCP 500B thyristor power converter in the configuration ordered
- DCS 500B / DCF 500B or DCP 500B publications
- Accessories, including manuals if ordered
- Final test report

Check the consignment for any signs of damage. If you find any, please contact the insurance company or the supplier.

Check the particulars given on the unit's rating plate to make sure prior to installation and start-up that you have received the correct unit type and unit version.

If the consignment is incomplete or contains any incorrect items, please contact the supplier.

CAUTION! The thyristor power converter weighs quite a lot and should therefore not be held by the front cover. Please put the unit down only on its back (sizes C1/C2/A5). Always use care when handling the unit, so as to avoid injuries or damage.

Storage and transport

If the unit had been in storage prior to installation or is transported to another location, care must be taken to ensure that the environmental conditions are complied with (see "*System Descriptions DCS 500B / DCF 500B or DCP 500B*").

Rating plate

For purposes of identification, each thyristor power converter is fitted with rating plates, stating the type code and the serial number, which serve for each unit's individual identification.

The type code contains information on the characteristics and the configuration of the unit. The first three digits of the serial number refer to the year and week of manufacture. The last digits complete the serial number so as to preclude two units receiving the same type code and the same serial number.

The 112xx group provides information on the unit's software configuration.

The technical data and specifications are valid as of going to press. ABB reserves the right to make subsequent alterations.

If you have any questions concerning your drive system, please contact your local ABB agent.

Chapter 2 - Start-Up Instructions

General notes

CAUTION: it is absolutely essential that the applicable accident prevention regulations be observed by the user (in this context, please also read the chapter entitled "Safety Instructions")!

How this chapter is structured

For better understanding the individual steps of start-up work are distinguished by

a) frames **without** any additional marking on the left side:

⇒ **These steps of start-up work must always be performed (= mandatory start-up work)!**

Example:



522 = GERMAN [Only with the SDCS-CON-2 control board & the CDP 312 panel!]
Activates German texts on the display

b) frames **with** marking on the left side („columns“ shaded in grey):

⇒ **These steps of start-up work have to be performed only when the condition stated** (as heading) **applies to the selected drive configuration!** After this work has been completed, the **mandatory start-up work** has to be continued.

Example:

Only when connection diagram 1 (Appendix A) is being used!



906 = 12502
Function „EMERGENCY STOP“ de-activated

Recommended motor voltages and field voltages

- Motor voltage U_A when the following units are used
DCS 501B / DCP 501B: $U_{Amax} = \text{Line voltage} * 1.16$ (2- quadrant unit)
DCS 502B / DCP 502B: $U_{Amax} = \text{Line voltage} * 1.05$ (4- quadrant unit)
- Field voltage U_F (= max. output voltage) when the following is being used
SDCS-FEX-1: $U_F = \text{Line voltage} * 0.9$
If there is a divergence of more than 10 % between the field supply unit's output voltage and the rated field voltage U_{Frated} stated on the motor's rating plate, then the connecting voltage U_N should be reduced, using a matching transformer or a series resistor R_v :
 $R_v = (0.9 * U_N - U_F) / I_F$ $I_F = \text{Rated field current}$
(Note: also suitable for fine-balancing the maximum motor voltage)
- Field voltage U_F when the following is being used
SDCS-FEX-2 /
DCF 503 / DCF 504: $U_F = \text{Line voltage} * 0.6 \dots 0.8$
- Field voltage U_F when the following is being used
DCF 501B / DCF 502B: $U_F = \text{Line voltage} * 0.5 \dots 1.1$
Maximally possible output voltage U_{Amax} using
DCF 501B / DCF 502B: $U_F = \text{Line voltage} * 1.35$

Phase sequence when connecting to the mains / Potential isolation

No special phase sequence required for the main connections U1, V1 and W1!

Phase coordination between electronics section and power section not necessary!

For potential isolation and for avoiding ground loops, an isolating transformer should be installed upstream when an oscilloscope is being used.

Preventing unintended operating states / Shutting the drive down

CAUTION! As laid down in DIN 57100 Part 727 / VDE 0100 Part 727 (Preventing unintended operating states), shutting the drive down by means of the signals at the binary inputs DIx is **not** sufficient in itself as the sole measure involved for avoiding unintended operating states or shutting the drive down in the event of danger!

Range of application for the Start-Up Instructions

The Start-Up Instructions are referenced to the **parameter settings** in their as-delivered condition (default values) and to the **unit wiring** as shown in connection diagram 1 or 2 (see *Appendix A*). In both circuit variants, the binary inputs DI5, DI7 and DI8 can be used. They will cause the reactions at the drive as described below. The symbols stated in this context will be repeatedly used further on in the text.

Method of functioning of the binary inputs DI5, DI7 and DI8

- **Binary input DI5; designation EM STOP**



In operation, DI5 must be set to logical "1". If it is set to "0", the alarm signal A 102 will appear. The drive will react in accordance with the function set at Parameter 917 (shutdown with ramp, with torque limit/current limit, with controller blocking and coasting). Once ramp-down has been completed (speed feedback below n_{min}), the output is reset for controlling the line contactor. After that, the EM STOP input should be set back to "1", the alarm message acknowledged, and the ON/OFF input likewise be set to "0". After that, the drive can be started anew.

- **Binary input DI7; designation ON/OFF**

For connecting the drive to the mains, DI7 must be set to logical "1". If there are no ongoing faults, the outputs for controlling the contactors for the armature circuit and the field circuit will be activated. If DI7 is set to "0", the controllers will be blocked internally and the outputs reset after a time-delay.

The function which can be set with Parameter 915 (inputs DI7 and DI8 for switching the contactors) will only be operative when the drive has been wired as shown in connection diagram 2.



Symbols for switching the electronics or the power section ON and OFF

	- Switch ON electronics - Switch ON power	X6: 7 \Rightarrow „1“ signal (K20 in connection example)	(input ON / OFF)
	- Switch OFF electronics - Switch OFF power	X6: 7 \Rightarrow „0“ signal (K20 in connection example)	(input ON / OFF)

- **Binary input DI8; designation RUN**

For starting the drive, DI8 must be set to logical „1“. This enables the reference at the REF_SEL and RAMP GENERATOR blocks, as well as the controllers. If DI8 is set to "0", the drive will react in accordance with the function set at Parameter 916 (shut-down with ramp, with torque limit/current limit, with controller block and coasting). Once ramp-down has been completed (speed feedback below n_{min}), the reference is kept at zero, and the controllers blocked after a time-delay; the drive is torqueless.

Symbols for enabling / disabling the reference

	- ENABLE reference	X6: 8 \Rightarrow „1“ signal (K21 in connection example)	(input RUN)
	- DISABLE reference	X6: 8 \Rightarrow „0“ signal (K21 in connection example)	(input RUN)

System-dependent planning

If you want the drive to react with a function other than that of Parameter 916 or 917, you have to parameterize the unit accordingly, by connecting one of the inputs or an additional one with a control pin, e.g. at the ramp-function generator.

- Example 1:

Operational ramp-up and ramp-down in the event of reference changes with the same ramp times, shutdown via RUN with a different time.

Solution:

use second parameter set ramp times; set time at DECEL2;
establish connection from P 1707 to P 10716.

- Example 2:

Implementing an EMERGENCY SHUTDOWN or EMERGENCY STOP function.

Solution:

this function stipulated in various regulations must always be planned in dependence on the system involved! A basic distinction must be made here between electrical and mechanical risks. Since one signal at one input is not sufficient (see above), at least one other switch-off option must be created, e.g. by means of a relay directly switching input DI5 to "0". This is how the power converter attempts (in accordance with P 917), to defuse the dangerous situation. A dropout-delay contact of the relay will then switch the power off. If the delay is small or does not match the function selected for P 917, then certain operating states (regeneration) may, due to laws of physics, result in the unit fuses tripping, and in extreme cases in thyristor defects.

Symbol for altering parameters or for establishing new connections

	Enter at keyboard	e.g. 1204 = 10000	Assign the value of 10000 to Parameter 1204
-----------------------------------------------------------------------------------	-------------------	-------------------	---------------------------------------------

Symbol for displaying parameter values or connections

	Display		
-----------------------------------------------------------------------------------	---------	--	--

Symbol for measuring physical variables

	Measure		
-----------------------------------------------------------------------------------	---------	--	--

2.1 Preparatory work

Check the unit for damage in transit or other damage.

Install and wire unit; connect all inputs and outputs required.
Proceed in the same way for the field supply unit as well.

Check whether protective measures, earthing, screening, etc. have been taken in accordance with the system conditions involved.

Check the rated value of the supply voltage for the electronics and the fan:

- matching transformer necessary when:
 - electronics supply is not equal to 115 V/230 V
 - single-phase-fan supply is not equal to 230 V
 - three-phase-fan supply is not within the range of 400 V 690 V.

Check the rated value of the supply voltage for the armature-circuit converter's power section; the particulars given on the rating plate must be \geq than the rated line voltage.
If this condition is not satisfied, then the following applies:

- use an isolating transformer, or
- use a suitable unit.

Check the rated value of the supply voltage for the field supply unit.
(Particulars on rating plate \geq rated line voltage?
Is an auxiliary transformer or perhaps a series resistor necessary?)

Check the wiring, fusing, the cross-sectional areas of the cables.

Provide an option for switching binary inputs X6: 7 and X6: 8.

Check the system's EMERGENCY STOP for proper functioning! Set the system-side monitoring functions, and activate them. Check whether auxiliaries, such as motor fans or unit fans, function properly; while doing this, also check for correct direction of rotation and voltage level as well!

2.2 Scaling intra-unit signals

Make sure that the existing electronics supply voltage has been set on the SDCS-POW-1 power supply board as well, using the SW1 switch.
 If an encoder is being used as the speed feedback device, make sure that the correct supply voltage has been set on the boards
 SDCS-POW-1: ⇒ X3: / X4: / X5: SDCS-IOB-3: ⇒ S4



Switch on the power supply to the electronics section.



The display of Panel CDP 31x
 may show the following
 information:

DCS 500
**** WARNING ****
+Emergency stop



522 = GERMAN [Only with the SDCS-CON-2 control board & the CDP 312 panel!]

Activates German texts on the display

501 = Rated motor voltage

This is used to scale those parameters referring to the rated motor voltage, such as field crossover point or maximum speed with e.m.f. control.

502 = Rated motor current

This is used to scale those parameters referring to the rated motor current, such as current limitation or torque limitation.

507 = Rated line voltage

This is used to scale those parameters referring to the line voltage, such as line undervoltage.

Only when connection diagram 1 (Appendix A) is being used!



906 = 12502

„Emergency Stop“ de-activated

910 = 10908

No check-back signal from unit fan necessary

911 = 10908

No acknowledge signal from motor fan necessary

Set this only for units with a rated current ≥ 2050A!



517 = Rated power converter current

Enter numerical value from rating plate here

518 = Rated power converter supply voltage

Enter numerical value from rating plate here

519 = 45 Grad Celsius

Temperature monitoring of power section

520 = 4 ⇒ Size C4 has been selected

Coding for unit type

521 = 1 : Single bridge (2-Q) converter ⇒ on rating plate: DCS 501 xxxx

4 : Double bridge (4-Q) converter ⇒ on rating plate: DCS 502 xxxx

Coding for power section (bridge) type

Set this only for units of the DCP 500 series!



517 = Rated power converter current

Enter numerical value from rating plate here

518 = 500 V (fixed!); rated power converter voltage

Enter numerical value 500 V here

519 = Temperature monitoring of power section

Enter value as indicated in the table „Technical Data“ here

520 = 4 ⇒ Size C4 has been selected

Coding for unit type

521 = 1 : Single bridge (2-Q) converter ⇒ on rating plate: DCP 501 xxxx

4 : Double bridge (4-Q) converter ⇒ on rating plate: DCP 502 xxxx

Coding for power section (bridge) type

507 = Rated line voltage;

Enter: Rated line voltage $U_{\text{ratedline}}$ in V * 1.05

Example: $U_{\text{ratedline}} = 400 \text{ V}$; entry for Parameter 507 ⇒ 420

CAUTION: Display of the line voltage feedback value is 5 % too high!
Switching thresholds referenced to the line voltage, however, are correct!

CAUTION! Please don't forget!



11202 = SAVE MOT1 SET

Save the altered values in the non-volatile memory!

Resetting the warning either by:

briefly setting ("H" level) binary input X6:6

or

switching the electronics voltage supply OFF and ON again.

2.3 Presetting the field supply unit

Make sure that existing supply voltages for power section, field supply unit (field exciter) and field winding, fan, etc. match the rated data of the components used.



Switch ON power.



DANGER: System components now energized!

Please wait a few moments. During this time, the unit compares the phase sequence set in the parameter with that obtaining at the power section.
 If the unit outputs the "Phase sequence fault of power section" signal (**F 38**):

- switch off unit completely and disconnect from the mains, interchange two phases at the input, and start again from the beginning of this chapter.

or

- enter: **506 = R-T-S** and then acknowledge fault signal.

Unit will automatically adapt to phase sequence; this signal is to be interpreted as information to the effect that the fans' direction of rotation may be wrong for size-C4 units.

Only for uncontrolled field supply with SDCS-FEX-1!



505 = 1 Panel display: **DIODE FIELD EXCIT**



Check field current and field voltage by measuring them.



Switch OFF power!



11202 = SAVE MOT1 SET
 Save the altered values in the non-volatile memory!
Continue with Chapter 2.4

Only for controlled field supply with SDCS-FEX-2 or DCF 503/DCF 504!



505 = 2 Panel display: **FEX2 OR FEX3**
503 = Rated motor field current
 Scales all parameters referenced to the motor field current, such as field current limitation or field current monitoring
1305 = Field current for "Under-excitation" signal



Check field current and field voltage by measuring them; if necessary, correct field current with **503**.

Only for armature-circuit power converters with SDCS-CON-2 control board & CDP 312 panel!



1201 = 5

Panel display: **FEX2/3 AUTOTUNING**

Activates the field current controller's auto-tuning function.

Action has been completed when **NOT ACTIVATED** is shown on the display.



Switch OFF power!



11202 = SAVE MOT1 SET

Save the altered values in the non-volatile memory!

➤ **Continue with Chapter 2.4**

Only for controlled field supply with DCF 501B or DCF 502B !



505 = 2

Panel display: **FEX2 OR FEX3**

503 = Rated motor field current

Scales all parameters referenced to the motor field current, such as field current limitation or field current monitoring.

If field current is above 150A, multiply the value by 0.1 and use this number (problem: upper limit of P503 / P504) ; the reference transferred to the DCF 500B is always 100% independent of this setting; by doing so all indications on the panel CDP312 can be corrected quite easily by multiplying by 10

1305 = Field current for "Under-excitation" signal



Switch OFF power!



11202 = SAVE MOT1 SET

Save the altered values in the non-volatile memory!

Before adjustment of the armature-circuit power converter is continued (Chapters 2.4 etc.),

First perform the start-up routine for the **DCF 501B or DCF 502B** field supply unit (Chapter 2.9) and

then: continue with Chapter 2.4

2.4 Adjusting the current controller

Make sure that static current limitation Bridge 1 (2307) and Bridge 2 (2308; with 4Q-unit) have been set to the same value; values of all parameters for current reference limitation must be greater than 20 %; conditions have been satisfied if default setting has been taken as starting point; setting to maximally required motor current is recommended.



Drive must not turn! Do not preset an external reference!
1201 = 3 Panel display: **ARM. AUTOTUNING**
 Activate the current controller's auto-tuning function.
Start the next two steps within the next 20 seconds!



Switch ON power.
 **DANGER:** System components now energized!



Start drive.



When the display shows **NOT ACTIVATED** (action correctly completed), stop drive; it may happen that the unit runs armature-circuit current since e.m.f. control is active; n_{min} - signal (**2201**) \Rightarrow value too small.



Switch OFF power!

If the unit aborts the auto-tuning routine with a fault signal, then eliminate cause of this as far as possible (supply, switching sequence, etc.; see also description for **11201**), then repeat the above points, or continue with next point.



Read out values of:
407 = 408 = 409 = 410 = 411 =

Only if the unit aborts the auto-tuning routine with a fault signal *FIELD REMOVAL* ?!



505 = 0 Panel display: **NO FIELD EXCITER**
11202 = SAVE MOT1 SET
 Save the altered values in the non-volatile memory!



Switch OFF power supply to the electronics section!
 If the **SDCS-FEX-1** field supply is being used:
 make sure that **no** field current is flowing, e.g.
 by removing the supply fuses!



Switch the electronics section's power supply on again!



Drive must not turn! Do not preset an external reference!
1201 = 3 Panel display: **ARM. AUTOTUNING**
 Activate the current controller's auto-tuning function.
Start the next two steps within the next 20 seconds!



Switch ON power.
 **DANGER:** System components now energized!



Start drive.



When the display shows **NOT ACTIVATED** (action correctly completed), stop drive; it may happen that the unit runs armature-circuit current since e.m.f. control is active; n_{\min} - signal (**2201**) \Rightarrow value too small.



Switch OFF power!



Read out values of:
407 = 408 = 409 = 410 = 411 =



Use values of **409** and **410** from the first auto-tuning routine.
 Re-activate the field unit used by entering:
 a) **505 = 1** Panel display: **DIODE FIELD EXCIT**
 and install the supply fuses removed before!
or
 b) **505 = 2** Panel display: **FEX2 OR FEX3**

CAUTION! Please don't forget!



11202 = SAVE MOT1 SET
 Save the altered values in the non-volatile memory!

2.5 Speed feedback balancing

E.M.F. control active?
2102 = 5 Panel display: **EMF SPEED ACT**
 Field weakening mode not selected?
1001 = 0 Panel display: **CONSTANT FIELD**



2103 = Desired speed / or motor rating plate
 Scale speed control circuit to maximum speed.
1701 = 12516
 Activates internal reference value; drive will use 20 sec for ramp-up/-down time.
12516 = 2000
 Set internal reference value to 10 %.
CAUTION: Value will not be saved with **SAVE MOT1 SET!**



Switch ON power.
 **DANGER:** System components now energized!



Start drive.
 Drive should run up to 10 % of the rated voltage.

Only when an analog tacho is being used!



Connect measuring instrument to:
 - to **X3: 1... 3** or **X1: 1... 3**
 + to **X3: 4** or **X1: 4**
 Check to make sure that the tacho voltage does not exceed the input voltage range selected with maximum speed.
 Turn Potentiometer **R9**, **R48** or **R2716** to minimum (left-hand stop). The measured value must have a positive sign; if necessary interchange tacho cables.



Switch OFF power, thus stopping the drive; drive coasts.



101 = 3 Panel display: **TACHO VOLT. +/-10**
 Activates the analog input for the speed feedback value.
2102 = 4 Panel display: **ANALOG TACHO**
 Analog tacho is used for speed control.



Switch ON power; start drive.
 **DANGER:** System components now energized!
 Drive should run up to 10 % of the rated voltage.

Use **R9**, **R48** or **R2716** to set the tacho voltage to 10 % of the maximum tacho voltage.

Only when an encoder (pulse encoder) is being used!**12104 = Content of pulse counter**

If the shape of the curve corresponds to the diagram below, this means the wiring is correct and the pulses will be correctly evaluated [see also documentation entitled „*Technical Data*“, Chapter I/O boards].

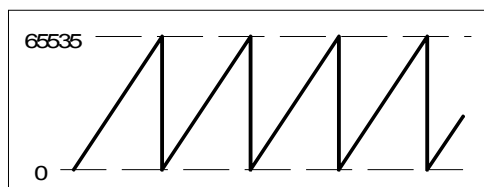

Fig.: Curve shape of the encoder's pulse counter for sense of rotation "forwards"



Switch OFF power, thus stopping the drive; drive coasts.

**2101 = No. of encoder pulses**

As specified on the encoder's rating plate

2102 = 3 Panel display: **ENCODER A+-, B+-**

Encoder is used for speed control.



Switch ON power; start drive.



DANGER: System components now energized!



Drive should run at 10 % of the desired speed;
if possible, check with manual tacho.

Only when the e.m.f. signal is being used as speed feedback!

Drive should run at 10 % of the desired speed;
if possible, check with manual tacho.



Switch OFF power, thus stopping the drive; drive coasts.

CAUTION! Please don't forget!**11202 = SAVE MOT1 SET**

Save the altered values in the non-volatile memory!

2.6 Balancing the field supply unit and the e.m.f. controller

When matching the field supply unit to the system conditions, differences in the procedures adopted must be taken into account; these different procedures result from the operating mode used. **Only the work of that section has to be performed which deals with the operating mode actually used in your system!**

- Constant field current control ⇒ Section **2.6.1**
- Field weakening control with setting range smaller than 1 : 1.5 ⇒ Section **2.6.2**
- Field weakening control with setting range larger than 1 : 1.5 ⇒ Section **2.6.3**

2.6.1 Constant field current control



Switch ON power; start drive.



DANGER: System components now energized!
Drive should run up to 10 % of the speed.



12516 = increase slowly!

Internal reference value is increased; scaling: 20000 corresp. to 100 % speed or motor voltage, defined with **P 501**.

Measure motor voltage with the **U ARM AC** signal by changing between **MODE ACT** and **PAR**; with a value set with **P 501**, it must remain constant, or must not exceed this value if **12516** = 20000.

The motor voltage must not exceed the recommended motor voltage; see *General notes* at the beginning of this chapter.



Measure speed with manual tacho;
check rated speed when an analog tacho is being used;
if necessary, correct with **R9**, **R48** or **R2716**.



12516 = 0



Switch OFF power, thus stopping the drive!

↪ **Continue with Chapter 2.7**

2.6.2 Field weakening control with setting range < 1 : 1.5**CAUTION: Not permitted when Chapter 2.5 was quit with e.m.f. control!**

1001 = 1 Panel display: **EMF, NO FIELD REV**
 Field weakening function activated
1012 = Speed at field weakening point as per motor rating plate



Switch ON power; start drive.



DANGER: System components now energized!
 Drive should run at 10 % of the maximum speed.



12516 = increase slowly!

Internal reference value is increased; Scaling: 20000 corresp. to 100% speed.
 Measure motor voltage with the **U ARM AC** signal by changing between **MODE ACT** and **PAR**; with a value set with **P 501**, it must remain constant, or must not exceed this value if **12516 = 20000**.

Check that field is being weakened.

Do not exceed the maximum motor speed permitted. When an analog tacho is being used, the display at the CDP 31x panel is not yet necessarily correct.

The motor voltage must not exceed the recommended motor voltage; see *General notes* at the beginning of this chapter.

If the field is not being properly weakened, or not being weakened at all, perform the work of section "*Field weakening control with setting range larger than 1 : 1.5*"!



Measure speed with manual tacho;
 check rated speed when an analog tacho is being used;
 if necessary, correct with **R9, R48** or **R2716**.



12516 = 0



Switch OFF power, thus stopping the drive!



CAUTION! Please don't forget!

11202 = SAVE MOT1 SET

Save the altered values in the non-volatile memory!



Continue with Chapter 2.7

2.6.3 Field weakening control with setting range > 1 : 1.5

CAUTION: Not permitted when Chapter 2.5 was quit with e.m.f. control!

Only when unit is fitted with an SDCS-CON-1 control board!

If the field time constant is known, e.g. from the motor data sheet!



1308 = leave as it is; if appropriate vary between 1...5.

P-gain of the field current controller

1309 = Enter value of field time constant, if necessary increase by factor 1...2.

I-gain of the field current controller

If possible, check controller behaviour with oscilloscope or CMT tool

11202 = SAVE MOT1 SET

Save the altered values in the non-volatile memory!

If the field time constant is not known!



1201 = 7 Panel display: **FEXC2/3 MAN. TUNIN**

Drive Mode: manual balancing of the field current controller

1204 = 4095

1205 = 1000

Ref. value jumps of field current between 25 % and 100 % with POT1 and POT2

11209 = 3

Change between POT1 and POT2 activated

12516 = 0



Switch ON power.



DANGER: System components now energized!



1308 = Match P-gain to field circuit.

1309 = Match I-gain to field circuit.

Oscillograph field current feedback via D/A output, or if one is to hand, use CMT tool to depict it via the TRENDING menu and Parameter **11302**.

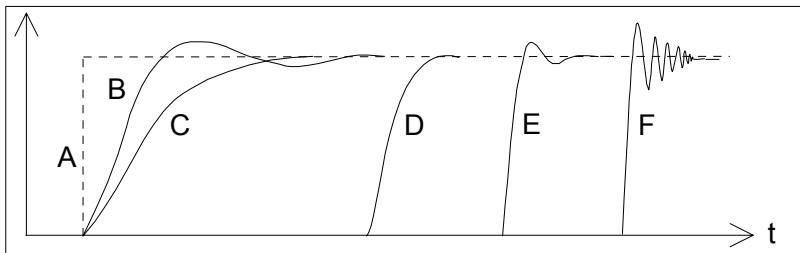

Fig.: Transient response of controller

A: reference value jump

B: undercompensated; reset time and P-gain too small

C: undercompensated; P-gain too small

D: normal

E: slightly overcompensated; when a higher dynamic response is required

F: overcompensated; short reset time and a high P-gain



Switch OFF power!



1201 = 0 Panel display: **NOT ACTIVATED**
11202 = SAVE MOT1 SET
 Save the altered values in the non-volatile memory!

When unit is fitted either with an SDCS-CON-1 or SDCS-CON-2 control board!



1001 = 1 Panel display: **EMF, NO FIELD REV**
 Field weakening activated.
1002 = 12522
 Links up a settable parameter as the flux reference value.
1004 = 12502
 Activates the linked-up parameter.
1009 = 0
1010 = 0
 e.m.f. controller switched off.
1012 = Speed at field weakening point as per motor rating plate
1013 = 40,0
1014 = 70,0
1015 = 90,0
 Linear characteristic of field
12522 = 4095
 Flux reference value set to 100 % corresponding to 4095.
12516 = 2000
 Set internal reference value to 10 %.



Switch ON power; start drive.



DANGER: System components now energized!
 Drive should run at 10 %.



The next steps serve to determine the motor's field characteristic. For this purpose, the internal reference is used to set a speed n which is within the motor's basic speed range and can be easily converted into 90 %, 70 % and 40 %.

Example: if n is selected so as to produce a motor voltage of 300 V, then 90 % will correspond to 270 V, 70 % to 210 V and 40 % to 120 V.

12516 = increase slowly until a motor voltage is produced which can be easily converted.

Note: Measure motor voltage with the **U ARM AC** signal
 (change between **ACT** and **PAR**).

Scaling of **12516**: 20000 corresponds to 100 % speed.



12522 = decrease so that motor voltage is 90 %.

Flux and thus the field current as well are reduced.

How to proceed:

1. decrease **12522** (in steps of 100 at a time)
2. press **ACT**, read off motor voltage
3. press **PAR** and correct **12522** if necessary (then continue with 2.)

Read out and note down value of:

11003 = (will later be entered in **1015**)



12522 = decrease so that motor voltage is 70%.

Flux and thus the field current as well are reduced.

Proceed as described in (1. / 2. / 3.) above!

Read out and note down value of:

11003 = (will later be entered in **1014**)



12522 = decrease so that motor voltage is 40%.

Flux and thus the field current as well are reduced.

Proceed as described in (1. / 2. / 3.) above!

Read out and note down value of:

11003 = (will later be entered in **1013**)



12522 = 4095

12516 = 0

Internal reference value equal to zero.



Switch OFF power, thus stopping the drive!



1002 = 12512

1004 = 0

1009 = 10%

1010 = - 99%

As-delivered values (default values) for all 4 parameters restored.

1015 = equal to the 1st value of **11003**

1014 = equal to the 2nd value of **11003**

1013 = equal to the 3rd value of **11003**

Linearization function matched to field circuit.



501 = 90 % of the rated motor voltage.

1012 = 90 % of the value on the motor rating plate.

This measure serves to provide a greater safety margin for the motor voltage during start-up.

Only if analog tacho is used as speed feedback!

Switch ON power; start drive.

**DANGER:** System components now energized!**12516 = increase slowly up to 20000 (=100 % speed).**Check motor voltage; if value has been set with **501**, motor voltage must remain constant, or must not exceed this value.Measure speed with manual tacho; balance maximum speed with **R9**, **R48** or **R2716**.**12516 = 0**

Switch OFF power, thus stopping the drive!

CAUTION! Please don't forget!**11202 = SAVE MOT1 SET**

Save the altered values in the non-volatile memory!

2.7 Balancing the speed controller, plus fine-balancing the e.m.f. and the current controllers



1701 = 11206

Change between POT1 and POT2 activated.

Extremely reduce the **ramp-up time**, depending on the system conditions:

1708 = 0,1 s

1709 = 0,1 s

Adjusting the potentiometers for speed controller balancing:

During acceleration/ braking, the drive should reach the current limitation, if necessary increase the value of POT1.

Scaling of **1204** and **1205** \Rightarrow 20 000 corresponds to 100 % speed.

1204 (POT1) = 10%...20% max. speed

1205 (POT2) = 0

1206 (PERIOD) = Adapt as necessary.



Switch ON power; start drive.



DANGER: System components now energized!

Drive should run at speed values corresponding to POT1 and „0“.



For assessing control quality, the Fig. entitled "Transient response of controller" (\Rightarrow section 2.6.3) can be used.

For this purpose, the following parameters at the speed controller must be adapted:

2014 = desired response (behaviour) of controller

2018 = desired response (behaviour) of controller

Only when fine-balancing of the e.m.f. controller is wanted!
((Necessary when work as per section 2.6.3. has been performed))

Only when fine-balancing of the current controller is wanted!



For assessing control quality, the Fig. entitled "Transient response of controller" (\Rightarrow section 2.6.3) can be used.

- If **fine-balancing of the current controller** is wanted, the settings for the software potentiometers can be retained.

The following parameters at the current controller must be adapted:

407 = desired response (behaviour) of controller

408 = desired response (behaviour) of controller

- If **fine-balancing of the e.m.f. controller** is wanted, potentiometers' settings must be adapted:

1204 (POT1) approx. 10 % smaller than speed at field weakening point

1205 (POT2) ca. 10% greater than speed at field weakening point

The following parameters at the e.m.f. controller must be adapted:

1007 = desired response (behaviour) of controller

1008 = desired response (behaviour) of controller.



1204 = 0
1205 = 0



Switch OFF power, thus stopping the drive!



1701 = 11903
501 = Rated motor voltage set in Chapter 2.2.
1012 = Speed at rated motor voltage

CAUTION! Please don't forget!



11202 = SAVE MOT1 SET
Save the altered values in the non-volatile memory!

2.8 Matching the thyristor power converter unit to the system conditions concerned

- Ramp function generator
- Binary inputs and outputs

- Limit-value messages
- Additional functions

2.9 Presetting the 3-phase field supply unit DCF 50xB

This is a new functionality available for the first time with software version S21.232. When commissioning a drive consisting of a DCS converter for the armature supply and a DCF converter for the field please try to make sure both converters will be equipped with at least this software version.

Make sure that existing supply voltages for power section, field supply unit (field exciter) and field winding, fan, etc. match the rated data of the components used.



402 = 11303

field current reference received from the DCS 500B via FEX-link connected to current controller

405 = 1 Panel display: **CURR_REF**

input P402 via CURR_REF activated

409 = 0

current controller without feedforward function

420 = 2 or 3 Panel display: **METHOD 2 ALARM** or **METHOD 2 FAULT**

current ripple monitoring based on method 2; in case a current bubble is missing an alarm or fault is generated

421 = 25.0

threshold for current ripple monitoring = 25%

501 = Rated motor voltage

keep it to default; if set to lower values adapt the current controller to avoid over voltage faults

502 = Rated motor current

set this parameter to the motor's nominal field current

507 = Rated line voltage

Used to scale parameters referring to the line voltage, such as line undervoltage.

901 = 10916

902 = 10916

no need for an external start command for the field converter; when the start command is given to the DCS 500B feeding the armature, this converter automatically starts and controls the DCF 500B

906 = 12502

emergency stop command disabled

907 = 10917

no need for an external reset command for the field converter; when an error occurred either in the field or the armature converter the fault can be reset by the reset command connected and given to the DCS 500B; it is internally transferred to the DCF 500B

911 = 10908

input motor fan acknowledge deactivated

1215 = 4 Panel display: **FEXLINK NODE 1**

DCF field mode, DCF 506 is monitored, FEX-link in use and DCF 500B is node 1

1216 = 10703

digital input 2 used to monitor the motor fan at a DCS 500B is now used to monitor the DCF 506 overvoltage protection

1217 = 0 or 1 Panel display: **OVP ALARM** or **OVP ALARM**

alarm or fault indication / reaction, if DCF 506 has triggered

3601 = 15

only at DCF 502B; bridge reversal delayed to app. 50ms

3602 = 15

only at DCF 502B; in worst case bridge change over will take place when time of 3601 has elapsed plus app. 50ms

3603 = 600

only at DCF 502B; time delay of about 2s for F65 error message (reversal fault); timer is started, when reference is reversed; time has to be higher than time of P3601 + P3602 + time, needed to decrease the current to zero + safety margin

11202 = SAVE MOT1 SET

Save the altered values in the non-volatile memory!

According to the connection diagram there is no dedicated input prepared to switch on and start the field converter. Nevertheless there are two possibilities to control the converter:

- using the CDP 312 control panel and local mode; this gives access to the switch on / off function / start / stop function / reset function
- using the armature converter's input / outputs

*Make sure the **Emergency Stop Function** mentioned at the beginning of this chapter is working*

Make sure, no reference is active (DCS 500B not switched on)

**1215 = 2**

Panel display: **STAND ALONE**

current controller set to STAND ALONE for high inductive load



Switch ON power.



DANGER: System components now energized!

Please wait a few moments. During this time, the unit compares the phase sequence set in the parameter with that obtaining at the power section.

If the unit outputs the "Phase sequence fault of power section" signal (**F 38**):

- switch off unit completely and disconnect from the mains, interchange two phases at the input, and start again from the beginning of this chapter.

or

- enter: **506 = R-T-S** and then acknowledge fault signal.

Unit will automatically adapt to phase sequence; this signal is to be interpreted as information to the effect that the fans' direction of rotation may be wrong for size-C4 units.



Start drive.

**1201 = 5**

Panel display: **FEX2/3 AUTOTUNING**

FEX2/3 AUTOTUNING is selected; when pressing the enter button the converter will directly start running field current!



When the display shows **NOT ACTIVATED** (action correctly completed):
Stop drive



Switch OFF power!

In case the autotuning failed:

1201 = 4 Panel display: **ARM. MAN. TUNING**
ARM.MAN_TUNING, if the FEX2/3 autotuning failed; activate the reference via parameter 11209 and set the parameters of the square wave function generator; then adapt the current controller to get the behaviour shown at curve D chapter 2.6.3 in this manual



1215 = 4 Panel display: **FEXLINK NODE 1**
DCF mode FEXLINK NODE1 via FEX-link activated
11202 = SAVE MOT1 SET
Save the altered values in the non-volatile memory!

The DCS converter in DCF-mode (parameter 1215=1 or higher) will not accept a start command, if an alarm or fault is still active (an A or F indication on the 7-segment display). To ensure a correct function afterwards, please make sure the reasons for any type of alarm or fault is no longer present.

 **Continue with Chapter 2.4**

Chapter 3 - Handling of Control Panel CDP 31x

3.1 Overview

The Control and Display Panel [Control Panel] is used for parameter setting, for feedback value measuring and for drive control with series **DCS 500B / DCF 500B** and **DCP 500B** thyristor power converters. This device is available in different versions depending on the type of unit and software to be used:

Units with software **S 21.1xx** ⇒ **CDP 310 or CDP 311**
(recommended: **CDP 311**)

Units with software **S 21.2xx** ⇒ **CDP 312**

Hereinafter **CDP 31x** will be used as a common type designation for the above mentioned versions of Control Panel. Differences between the versions which have to be taken into account with particular functions will be indicated separately!

Panel Link

The **CDP 310/311** Control Panel is connected to the drive via CDI-300 communication bus. This communication bus, which is based on the RS485 standard, is a common bus protocol for ABB Drives products.

MODBUS is used as communication bus connecting the **CDP 312** Control Panel to the drive. This Control Panel combined with a Software version S 21.2xx onwards makes it possible to show the texts on the LCD in different languages.

The selection of language is performed by parameter **[P 522]**.

Note: The display texts as shown in this chapter correspond to the default setting of **[P 522]** (⇒ English)!

Mounting the Panel

The CDP 31x Control Panel can be handled in three different ways:

- Direct mounting on the thyristor power converter; the CDP 31x is plugged into the moulded part of the cover of the converter and connected via an adaptor of approx. 45 mm.
- Mounting on the door of the switchgear cabinet using an assembly kit equipped with a connection cable.
- Use of Panel as remote control device with a connection cable.

3.2 Start Mode

Note: The CDP 31x can be connected to the drive without disconnecting the auxiliary power !

When connected and power is applied to the electronics, the display of the CDP 31x shows:

- software version of the Control Panel
- ID number of the CDP 31x and number of drives connected to the link.

```
CDP310 PANEL
ID-NUMBER      31
TOTAL 1 DRIVES
```

Display with **CDP 310 / CDP 311**

```
DCS 500
ID-NUMBER      1
```

Display with **CDP 312**

After two seconds the display will clear, and the actual signals of the selected drive will appear.

The following message is displayed if the CDP 31x is not able to communicate with the drive:

```
**FAULT**
NO COMMUNICATION
```

```
NO COMMUNICATION [x]
```

[x]

- 1 The CDP is not active for 10 s
- 2 The drive is not active for 10 s
- 3 No data set received for 2 s
- 4 Bus administrator is offline

- The drive is not present on the link. This is the case if the drive stops communicating.
- The link does not operate because of a hardware malfunction or a cabling fault.

Action: Disconnect the CDP 31x and connect it again to the drive. By this means the CDP 31x will be forced to the Start Mode another time!

3.3 Panel Functions

The CDP 31x has four different keypad modes:

- **Actual Signal Display Mode (ACT)**
- **Parameter Mode (PAR)**
- **Function Mode (FUNC)**
- **Drive Mode (DRIVE)** for further extensions

Actual Signal Display Mode



This keypad mode will show, depending on the drive's history:

- Actual Signals
- Faults
- Fault History Logger

If the ACT-key is pressed immediately after initialization this table is displayed. If no panel-key is touched for more than one minute the Actual Signal Display will appear automatically, except when Status display or speed reference setting is active. (see chapter 3.13 and 3.15)

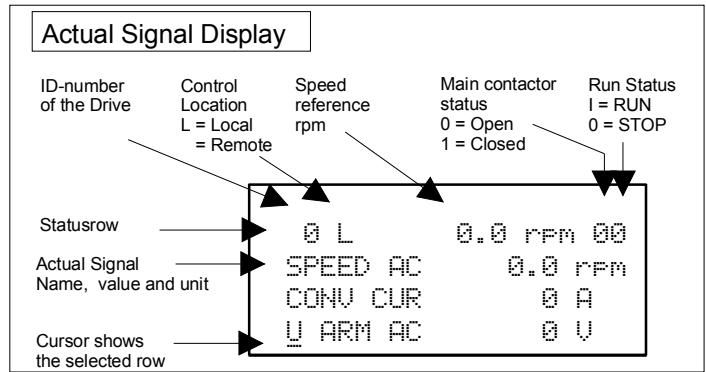

If a fault is effective in the drive, the Fault Display will appear automatically. This will happen with all other modes as well, except the Drive Mode is active.

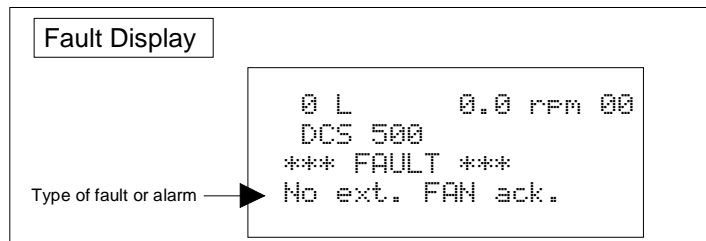

To select Fault History Display see chapter 3.8

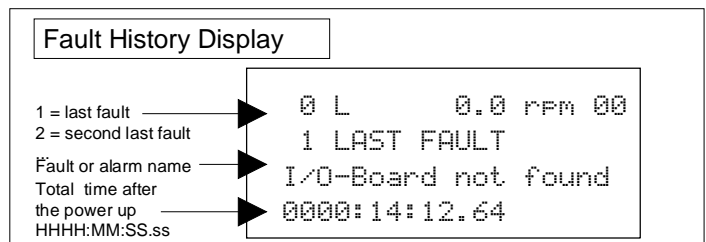

Parameter Mode



The Parameter Mode is used for:

- change the structure in the firmware
- show signals and their actual status
- show and change values of parameters, if they are not write-protected.

When the Parameter mode is entered parameter **101** appears after initialization, otherwise the selected parameter is shown.

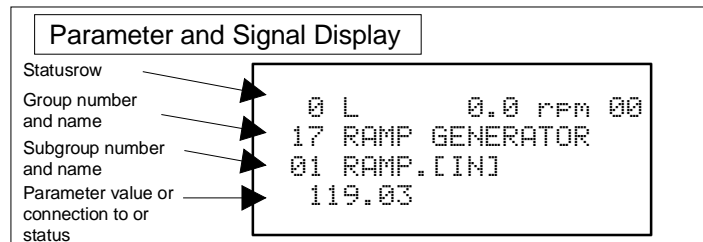

All function blocks are characterised by inputs and outputs with numbers. These inputs and outputs can be subdivided into two categories:

- **Pins** for designating connections
- **Parameters** for setting values, such as ramp-up / ramp-down time, controller's gain, reference values, etc.

If a write-protected pin or parameter is selected, the following warning will be displayed.

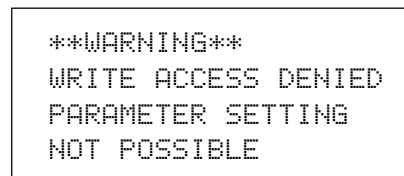

Function Mode



The Function mode is used for special functions, such as:

- Parameter **UPLOAD** from drive to CDP 31x
- Parameter **DOWNLOAD** from CDP 31x to drive
- CDP 31x display contrast setting

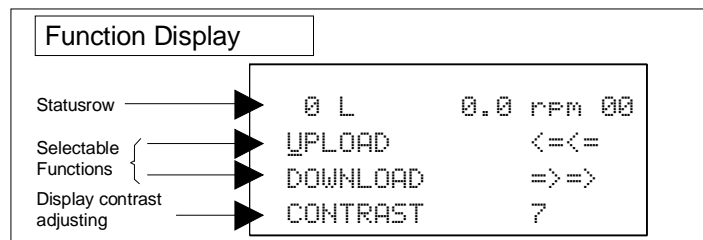

Drive Mode



Drive mode is used to check the configuration. The display will show the type and ID-number of the drive to whom the **CDP 31x** is connected to.

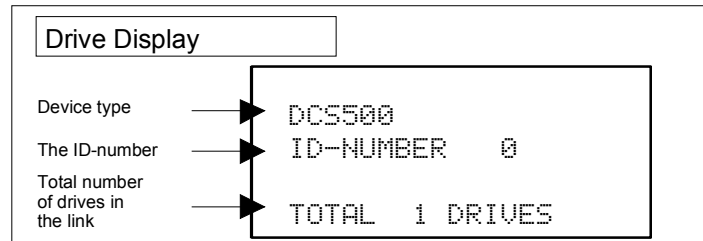

Display with **CDP 310 / CDP 311**

The factory-adjusted (default) values of the ID-numbers for the CDP and the drive depend on the specific CDP type:

CDP 310 / CDP 311 ⇒ ID = **31** with DCS 500 ⇒ ID = **0**
 CDP 312 ⇒ ID = **0** with DCS 500B ⇒ ID = **1**

Caution: These values should not be changed!

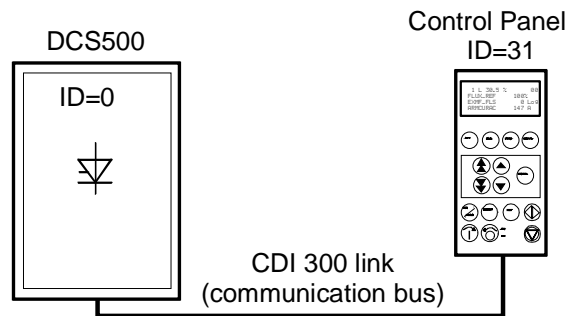

Factory-adjusted (default) values for **CDP 310 / CDP 311** with DCS 500







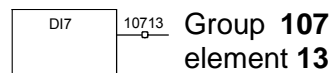

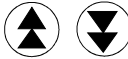
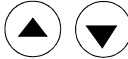

3.4 Pin/Parameter Selecting and Changing of Value

For input / parameter selection, the following applies:













- Ignore the two right-hand digits; the remaining digits are the group and to be selected
- The two right-hand digits are the element and to be selected



The selection can be done with the control panel CDP312, using the keys ▲ / ▼ for the group and the keys ◀ / ▶ for the element or a PC-based tool program CMT/DCS500B



Step	Function	Press key	Display after key is pressed
1.	To enter the Parameter Mode Selection		<pre> 0 L 0.0 rpm 00 17 RAMP GENERATOR 01 RAMP.[IN] 119.03 </pre>
2.	To select another group. While holding the key down, only the group number and name is displayed. When the key is released, number, name and value of the first pin/ parameter in the group are displayed.		<pre> 0 L 0.0 rpm 00 21 SPEED MEASUREMEN </pre> <hr/> <pre> 0 L 0.0 rpm 00 21 SPEED MEASUREMEN 01 TACHOPULS NR 2048 </pre>
3.	To select a element. While holding the key down, only the element number and name, representing a pin/ parameter, is displayed. When the key is released the value of the element is also displayed.		<pre> 0 L 0.0 rpm 00 21 SPEED MEASUREMEN 02 SPEED MEAS MODE </pre> <hr/> <pre> 0 L 0.0 rpm 00 21 SPEED MEASUREMEN 02 SPEED MEAS MODE EMF SPEED ACT </pre>
4.	To enter the Pin/Parameter Setting Mode.		<pre> 0 L 0.0 rpm 00 21 SPEED MEASUREMEN 02 SPEED MEAS MODE [EMF SPEED ACT] </pre>
5a.	To change the Parameter value: (slow change) (fast change)	 	<pre> 0 L 0.0 rpm 00 21 SPEED MEASUREMEN 02 SPEED MEAS MODE [ANALOG TACHO] </pre>
5b.	To change the Pin connection at first: (group number) ---> then: (element number) ---> of the target.	 	<pre> 0 L 0.0 rpm 00 2 ANALOG OUTPUTS 05 AO2.[IN] [105.02] </pre>
6a.	To send the new value to the drive.		<pre> 0 L 0.0 rpm 00 21 SPEED MEASUREMEN 02 SPEED MEAS MODE ANALOG TACHO </pre>
6b.	To cancel the new setting and keep the original value press any key before pressing ENTER. The selected Keypad Mode is entered.	   	<pre> 0 L 0.0 rpm 00 21 SPEED MEASUREMEN 02 SPEED MEAS MODE EMF SPEED ACT </pre>

3.5 Saving of the Parameters to backup memory



Step	Function	Press key	Display after key is pressed
1.	To enter the Parameter Mode Selection		<pre> 0 L 0.0 rpm 00 2 ANALOG OUTPUTS 05 A02.[IN] 105.01 </pre>
2.	Select group 112. While holding the arrow down, only the group name is displayed. When the key is released, number, name and value of the first parameter in the group is displayed.	 	<pre> 0 L 0.0 rpm 00 112 MAINTENANCE </pre> <pre> 0 L 0.0 rpm 00 112 MAINTENANCE 01 COMMIS STAT NOT ACTIVATED </pre>
3.	Select signal number 02 from group 112. While holding the arrow down, only the signal name and number are displayed. When the key is released the value is also displayed.	 	<pre> 0 L 0.0 rpm 00 112 MAINTENANCE 02 BACKUPSTOREMODE </pre> <pre> 0 L 0.0 rpm 00 112 MAINTENANCE 02 BACKUPSTOREMODE NONE </pre>
4.	Press ENTER to select BACKUPSTOREMODE.		<pre> 0 L 0.0 rpm 00 112 MAINTENANCE 02 BACKUPSTOREMODE [NONE] </pre>
5.	Saving of changed values. Select Set1 (SAVE MOT1 SET) or Set2 (SAVE MOT2 SET).	 	<pre> 0 L 0.0 rpm 00 112 MAINTENANCE 02 BACKUPSTOREMODE [SAVE MOT1 SET] </pre>
6a.	Confirmation of the saving. Saving procedure is completed when NONE is displayed.		<pre> 0 L 0.0 rpm 00 112 MAINTENANCE 02 BACKUPSTOREMODE ERASING... </pre>
6b.	To cancel the saving and keep the original value press any key before pressing ENTER. The selected Keypad Mode is entered.	   	<pre> 0 L 0.0 rpm 00 112 MAINTENANCE 02 BACKUPSTOREMODE NONE </pre>

3.6 FAULT RESETTING (RESET)

FAULT resetting and EMERGENCY STOP resetting (RESET) can only be performed via the **CDP 31x** if LOCAL is active. If drive is in REMOTE, please check whether LOCAL is a critical condition. If not activate LOCAL, reset the fault and activate REMOTE again.









Step	Function	Press key	Display after key is pressed
1.	To enter the Actual Signal Display Mode		<pre> 0 L 0.0 rpm 00 DCS500 *** FAULT *** I/O-Board not found </pre>
2.	To RESET the FAULT		<pre> 0 L 0.0 rpm 00 SPC:OUT 0.0 % CONV CUR 0 A U ARM AC 0 U </pre>

3.7 EMERGENCY STOP RESETTING (RESET)

Step	Function	Press key	Display after key is pressed
1.	If EMERGENCY STOP is activated, the control panel will show the following ALARM		<pre> 0 L 0.0 rpm 00 DCS500 ** WARNING ** +Emergency stop </pre>
2.	To enter the Fault History Display	 	<pre> 0 L 0.0 rpm 00 1 LAST FAULT +Emergency stop xxxx!xx!xx.xx </pre>
3.	To RESET the ALARM		<pre> 0 L 0.0 rpm 00 1 LAST FAULT -Emergency stop xxxx!xx!xx.xx </pre>

3.8 Fault History Display

Up to 100 faults are stored time related and displayed together with the time they appeared after electronics supply switched on.

Step	Function	Press key	Display after key is pressed
1.	To enter the Actual Signal Display Mode		<pre> 0 L 0.0 rpm 00 SPC:OUT 0.0 % CONV CUR 0 A U ARM AC 0 V </pre>
2.	To enter the Fault History Display. These keys also scroll the screen from Actual Signal Display to Fault Display , to Fault History Display back to Actual Signal Display .	 	<pre> 0 L 0.0 rpm 00 1 LAST FAULT +Type code changed xxxx!xx!xx.xx </pre>
3.	To select newer (UP) or older fault (DOWN). To clear a fault from the Fault History Buffer The previous fault is displayed. Drive condition identical to 3.6 and 3.7	  	<pre> 0 L 0.0 rpm 00 2 LAST FAULT Armature overvoltage xxxx!xx!xx.xx </pre> <pre> 0 L 0.0 rpm 00 1 LAST FAULT Reset xxxx!xx!xx.xx </pre>
4.	To return to the Actual Signal Display Mode .	 	<pre> 0 L 0.0 rpm 00 SPC:OUT 0.0 % CONV CUR 0 A U ARM AC 0 V </pre>

3.9 Uploading and Downloading of Parameters (UPLOAD/DOWNLOAD)

CAUTION! The drive must be in standstill condition with given STOP command (controllers blocked, power section disconnected from the network) when **UPLOAD/DOWNLOAD** function is selected.

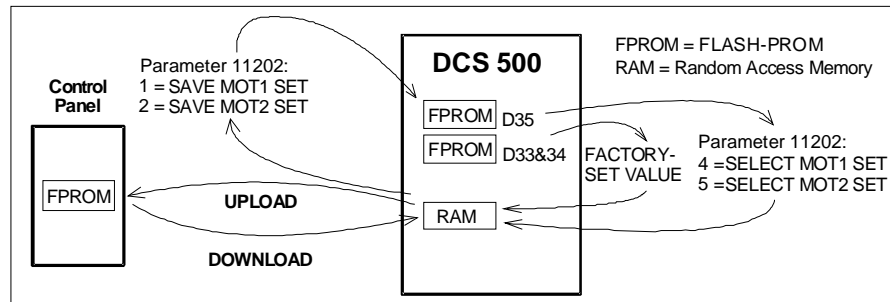

If one or both of these functions have been performed additional actions may be needed. For example **BACKUPSTOREMODE** should be selected for saving the values to the backup memory, if a **DOWNLOAD** had taken place.

UPLOAD will copy all parameters and connections, which are different to default, from the **RAM** memory of the drive to the **FEPROM** memory of the Control Panel CDP 31x.

Before a **DOWNLOAD** is started the factory-set values (default values) should be available within the drive's **RAM** memory. Factory-set values are always available in control board memory and they can be called by means of **BACKUPSTOREMODE** parameter **11202** [FACTORY_SET_VALUE] or by means of **S2** switch on the control board SDCS-CON-x.

The **DOWNLOAD** will copy all values stored in the **FEPROM** memory of the CDP 31x to the **RAM** memory of the drive. Downloaded parameters should be saved to the **FEPROM** memory of the control board **SDCS-CON-x**. See chapter 3.5 "Saving of Parameters to backup memory".

Note: For reasons of safety the **DOWNLOAD** function will only operate if „**LOCAL** mode“ of the Control Panel CDP 31x is selected!

Depending on the drive's condition and the status of the commissioning, **UPLOAD** has to take place before **DOWNLOAD**, otherwise a warning may be displayed:

```

**WARNING**
NOT UPLOADED
DOWNLOADING
NOT POSSIBLE
    
```

The drive must be in stopped state during the **DOWNLOAD** process, otherwise the following warning is displayed.



```

**WARNING**
DRIVE IS RUNNING
DOWNLOADING
NOT POSSIBLE
    
```





The drive that receives the **downloaded** parameters must have a compatible software version to the drive from which the parameters were **uploaded**. Otherwise the panel will display a warning:

```

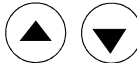

**WARNING**
DRIVE UNCOMPATIBLE
DOWNLOADING
NOT POSSIBLE
    
```

Step	Function	Press key	Display after key is pressed
1.	To enter the Function Mode		<pre> 0 L 0.0 rpm 00 UPLOAD <= <= DOWNLOAD => => CONTRAST 7 </pre>
2.	To select a function.		<pre> 0 L 0.0 rpm 00 UPLOAD <= <= DOWNLOAD => => CONTRAST 7 </pre>
3.	To activate the selected function.		<pre> 0 L 0.0 rpm 00 => => => => => => DOWNLOAD </pre>
4.	Loading complete.		<pre> 0 L 0.0 rpm 00 SPC:OUT 0.0 % CONV CUR 0 A U ARM AC 0 V </pre>

3.10 Setting of the Display Contrast

Step	Function	Press key	Display after key is pressed
1.	To enter the Function Mode .		<pre> 0 L 0.0 rpm 00 UPLOAD <= <= DOWNLOAD => => CONTRAST 7 </pre>
2.	To select a function.		<pre> 0 L 0.0 rpm 00 UPLOAD <= <= DOWNLOAD => => CONTRAST 7 </pre>
3.	To enter contrast setting function.		<pre> 0 L 0.0 rpm 00 CONTRAST [7] </pre>
4.	To set the contrast. (1...7)		<pre> 0 L 0.0 rpm 00 CONTRAST [4] </pre>
5.	To accept the selected value.		<pre> 0 L 0.0 rpm 00 CONTRAST 4 </pre>

3.11 Full Name of output pins

Step	Function	Press key	Display after key is pressed
1.	To display the full name of the three actual signals press key and hold		<pre> 0 L 0.0 rpm 00 SPEED ACT FILT CONV CURR ACT U ARM ACT </pre>
2.	To return to the Actual Signal Display Mode release key.		<pre> 0 L 0.0 rpm 00 SPEED AC 0.0 rpm CONV CUR 0 A U ARM AC 0 V </pre>





3.12 Selecting output pins

Note for CDP 310 / CDP 311:

Newly selected actual signals will be used for display until the electronics power supply is switched OFF.

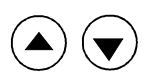
Note for CDP 312:

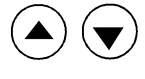



If there is a need for permanent display of the newly selected pin (e.g. after having switched OFF and ON again the electronics power supply), **BACKUPSTOREMODE** (see chapter 3.5) should be performed in order to save the values to the backup memory before switching OFF the electronics power supply.

Step	Function	Press key	Display after key is pressed
1.	To enter the Actual Signal Display Mode		<pre>0 L 0.0 rpm 00 SPEED AC 0.0 rpm CONV CUR 0 A U ARM AC 0 U</pre>
2.	To select the desired line.		<pre>0 L 0.0 rpm 00 SPEED ACT FILT CONV CURR ACT U ARM ACT</pre>
3.	To get acces to the desired line.		<pre>0 L 0.0 rpm 00 121 SPEED MEASUREMEN 03 SPEED ACT FILT 0.0 rpm</pre>
4.	To select a different group.		<pre>0 L 0.0 rpm 00 120 SPEED CONTROLLER 01 ERR:OUT 0.0 rpm</pre>
5.	To select a element.		<pre>0 L 0.0 rpm 00 120 SPEED CONTROLLER 04 SPC:OUT 0.0 %</pre>
6.	To accept the selection and to return to the Actual Signal Display Mode.		<pre>0 L 0.0 rpm 00 SPC:OUT 0.0 % CONV CUR 0 A U ARM AC 0 U</pre>

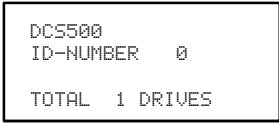
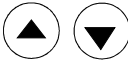
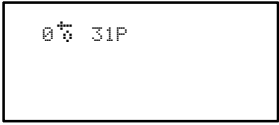
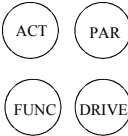
3.13 Drive Mode

Display of the ID-number for the Drive and for the Control Panel CDP 31x as well as display of the status (**Status Display**)

Step	Function	Press key	Display after key is pressed
1.	To enter the Drive Mode		
2.	To select the Status Display (see table below).		
3.	To cancel the Drive Mode . The selected Keypad Mode is entered.		

Symbol	Status Display
	Stopped, main contactor ON (closed)
	Stopped, main contactor OFF (open)
	Running, main contactor ON (closed)
	Control Panel CDP 31x
	Alarm or fault signalling effective in the drive

3.14 Running the Drive





Operational Command Keys

Operational commands can be given from the Control Panel CDP31x every time when the status row is displayed. Operational commands include START and STOP of the the drive, controlling the main contactor and adjusting the reference.

CAUTION! To be able to give operational commands from the CDP31x, the selected control location must be the Control Panel. The control location can be changed by means of **LOC/REM** key to **LOCAL** mode.

If **LOC** is activated some of the binary inputs are no longer functioning.

Take care that the drive is engineered to allow operation with **LOCAL** mode.

Control Panel Key	Name of Key	Function
	LOCAL / REMOTE	To select LOCAL (= CDP31x) or REMOTE (= ext. control system) operation.
	START	Starts the drive, when in LOCAL mode.
	STOP	Stops the drive, when in LOCAL mode.
	ON	Main contactor closing control, when in LOCAL mode.
	OFF	Main contactor opening control, when in LOCAL mode.



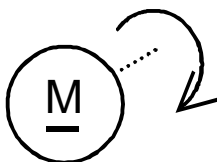









Running the DC-Drive from the CDP31x



Ensure safety before you start the drive test!

- Select LOCAL mode (**LOCAL** = CDP31x) by pressing LOC/REMOTE key.
- Close (switch on) the main contactor by pressing the **ON** key
- Start the drive by pressing the **START** key. Motor will now accelerate to the value of the reference.
- Direction of rotation can be changed by giving the opposite polarity reference value in case of 4Q drive.
- Stop the drive by pressing the **STOP** key. Motor will decelerate to zero speed. (depending on the STOP MODE)
- Finally open (switch off) the main contactor by pressing the **OFF** key.

3.15 Speed Reference Setting for the Drive

Step	Function	Press key	Display after key is pressed
1.	Press one of these keys to get the status row displayed.	  	<pre> 0 L 0.0 rpm 00 SPEED AC 0.0 rpm CONV CUR 0 A U ARM AC 0 V </pre>
2.	To enter the Reference Setting Mode		<pre> 0 L [0.0 rpm] 00 SPEED AC 0.0 rpm CONV CUR 0 A U ARM AC 0 V </pre>
3.	To change the reference: (slow change) (fast change)	   	<pre> 0 L [219.0 rpm] 00 SPEED AC 0.0 rpm CONV CUR 0 A U ARM AC 0 V </pre>
4.	To exit the Reference Setting Mode . The selected Keypad Mode is entered.	   	<pre> 0 L 219.0 rpm 00 SPEED AC 0.0 rpm CONV CUR 0 A U ARM AC 0 V </pre>

Chapter 4 - Signals and Troubleshooting

4.1 Display of status, alarm and fault signals

Categories of signals and possibilities of display

The signals (messages) to be available for thyristor power converters series **DCS 500B / DCF 500B** or **DCP 500** are subdivided into five categories:

	General messages
	Starting errors
F	Fault signals
A	Alarm signals
[112 . .]	Status signals through parameters

A seven segment display on the control board SDCS-CON-x of the thyristor power converters series DCS 500B / DCF 500B or DCP 500 is used to show general messages, starting errors, fault and alarm signals. The signals (messages) are displayed as codes. If the codes consist of several parts, the characters/individual digits will be indicated for 0.7 sec one after the other, e.g.:

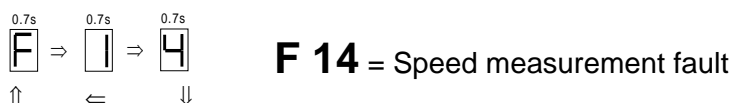

In addition to this the DCS 500B DCF 500B or DCP 500 combined with the LCD of the control panel CDP 31x will be able to show the fault and alarm signals as well as the status signals (selected by signal numbers **[112 . .]**) as clear text.

Note: The languages to be available for display as text depend on the type of Control Panel and the Software version (⇒ Chapter „Handling of Control Panel CDP 31x“).

For subsequent evaluation via binary outputs or serial interfaces the 16 bit informations **FAULT WORD1 [11101]**, **FAULT WORD2 [11102]** and **FAULT WORD3 [11103]** as well as **ALARM WORD1 [11104]**, **ALARM WORD2 [11105]** and **ALARM WORD3 [11106]** contain several fault and alarm signals as a binary code.

Each fault and alarm signal is coded as an individual error code to the **LATEST FAULT [11106]** and **LATEST ALARM [11107]**.

4.2 General messages

The general messages will only be shown on the seven segment display of the control board SDCS-CON-x.

Code seven segm. display	Text on LCD of control panel CDP 31x	Definition	–	Remark
8	Not available	Program is not running	–	(1)
.	Not available	Normal situation, no fault / no alarm signal	–	
L	Not available	Indication while loading another firmware into the drive	–	

- (1) Units should be switched off and on electrically; if fault occurs again, the PCBs SDCS-POW-1 and SDCS-CON-x have to be checked and if necessary to be changed.

4.3 Starting errors (E)

The starting errors will only be shown on the seven segment display of the control board SDCS-CON-x.

With starting errors it will not be possible to start the drive.

Code seven segm. display	Text on LCD of control panel CDP 31x	Definition	–	Remark
E1	Not available	ROM memory test error	–	(1)
E2	Not available	RAM memory test error	–	(1)
E3	Not available	No TC-link board (not valid for software version S21.1xx)	–	
E4	Not available	Communic. board SDCS-COM-x faulty	–	(2)
E5	Not available	No control program in memory	–	(3)
E6	Not available	ASIC not O.K.	–	(1)
E7	Not available	Parameter FLASH identity test failed	–	(1)

- (1) Units should be switched off and on electrically; if fault occurs again, the PCBs SDCS-POW-1 and SDCS-CON-x have to be checked and if necessary to be changed.
 (2) Check communication board, plug in correctly and if necessary change the board.
 (3) Load firmware once more.

4.4 Fault Signals (F)

The fault signals will be shown on the seven segment display of the control board SDCS-CON-x as codes **F . .** as well as on the LCD of the control panel CDP 31x as clear text.

All fault signals - with the exception of **F 17**, **F 18** and **F 44** - can be reset (after elimination of the faults); **F 20** would be self resetting, if the communication had been re-established before.

For resetting (RESET) of fault signals the following steps are required:

- Switching off the commands ON/OFF and RUN
- Elimination of the faults
- Fault acknowledgement, i.e. resetting (RESET)
 - a) as described for CDP 31x
 - or b) by short-time setting of the command RESET to high (logical one) via a binary input (default setting = D16).
- Depending on the application conditions generate the commands ON/OFF and RUN once more.

The fault signals will result in switching off the signal **[10910]** resp. in stopping the drive (installation-dependent).

If a fault occurs, there will be three different possibilities of reaction (see column "Remark" in the fault list):

- (1) *Fault will switch off the signals energizing the main contactor, the field contactor and the fan contactor.*
- (2) *Fault will switch off the signals energizing the main contactor and the field contactor.*
- (3) *Fault will switch off at least the signal energizing the main contactor.*

Code seven segm. display	Text on LCD of control panel CDP 31x	Definition / Action	Status signal (FAULT_WORD_1/2)		Remark
F 1	Auxil. undervoltage	Auxiliary voltage fault Try to reset. Check internal auxiliary voltages; if fault persists, change SDCS-CON-x and/ or SDCS-POW 1 board (if required).	11101	bit 0	(1)
F 2	Overcurrent	Overcurrent Check: - Motor, load and armature cabling for faults or blocking condition; - Parameter setting of current control circuit/torque limitation; - Parameter [P 512] (overcurrent detection).	11101	bit 1	(3)

Code seven segm. display	Text on LCD of control panel CDP 31x	Definition / Action	Status signal (FAULT_WORD_1/2)		Remark
F 3	Conv.fan curr.fault	<p>Current converter fan not within limits The current of the converter's cooling fan is measured via the option board PW1002/3. Check: - Fan supply, fan current; - Setting of PW1002, SET_MAX_BR_TEMP [P519] and CONV_TEMP_DELAY [P527] - Direction of rotation, fan components, air inlet</p>	11103	bit 11	(1) S21.232 and higher
F 4	Converter overtemp.	<p>Overtemperature power section Check: - Fan supply, direction of rotation, fan components, air inlet and ambient temperature; - Inadmissible load cycle?</p>	11101	bit 3	(2)
F 5	Earth fault	<p>Earth fault (ΣI differs from zero) Disconnect the mains and verify zero voltage in armature and field circuits. Make insulation test for the complete installation. Check sum current transformer; if necessary, change transformer and SDCS-IOB-3 board.</p>	11101	bit 4	(1)
F 6	Motor 1 overtemp.	<p>Overtemperature of MOTOR 1 Check: - Temperature sensor and its cabling; - Motor cooling or sizing; - Inputs for temperature sensor on board SDCS-IOB-3; - Parameter setting MOT1.TEMP_FAULT_L [P 1403] correct? Note: It will only be possible to reset this fault signal when the motor temperature has fallen below the threshold which is valid for the \Rightarrow alarm signal A 103; the signal will also be evaluated while the mains contactor is de-energized (open).</p>	11101	bit 5	(2)
F 7	Motor 1 overload	<p>Overload of MOTOR 1 (Thermal model 1) Check: - Motor temperature (let motor cool down and restart); - Motor ratings and parameters of thermal model; - Motor sizing or load cycle.</p>	11101	bit 6	(2)

Code seven segm. display	Text on LCD of control panel CDP 31x	Definition / Action	Status signal (FAULT_WORD_1/2)		Remark
F 8	Current rise fault	<p>Actual current changed faster than allowed The rate of current change is monitored. Check: - Setting of current reference slope [P406] and CURRENT_RISE_MAX [P418]; Level and setting of line voltage and motor voltage; setting of current controller</p>	11103	bit 10	(2) S21.232 and higher
F 14	Speed meas. fault	<p>Speed feedback (measurement) fault Check: - Incremental encoder and connection cable, encoder power supply (feedback might be too low); - Tacho polarity and voltage (does a total mismatch exist?) - Electronic boards SDCS-CON-x, SDCS-IOB-3, SDCS-POW 1; - Connection converter – armature circuit open? - Correct setting for selection of speed feedback monitoring?</p>	11102	bit 5	(3)
F 17	Type coding fault	<p>(Converter) Type coding fault SDCS-PIN-xx board not connected to board SDCS-CON-x or SDCS-PIN-xx not coded. Check: - Flat cables X12 and X13 O.K.? - Faulty coding on SDCS-PIN-xx? - Correct coding of unit size C4? Note: This fault signal will be shown, if jumper S2 (on board SDCS-CON-x) is in position 1–2 while switching ON the electronics supply. In that case select BACKUP-STOREMODE [11202], save the parameter set, switch OFF the electronics, reset jumper S2 and switch ON the electronics again.</p>	11102	bit 8	(1) Can not be reset
F 18	Backup read fault	<p>Backup read fault (Parameter saving fault) Cause: Wrong or missing checksum, data error while writing or reading. Note: Try again BACKUP-STORE-MODE; for that purpose - Move jumper S2 (on board SDCS-CON-x) to Pos. 1–2 with electronics supply switched OFF; - Switch ON electronics again; - Select BACKUPSTOREMODE [11202]; - Save default parameter set; - Switch OFF electronics; - Reset jumper S2 to its original position; - Switch ON electronics again. If display shows F 18 once again, change SDCS-CON-x board!</p>	11102	bit 9	(1) Can not be reset

Code seven segm. display	Text on LCD of control panel CDP 31x	Definition / Action	Status signal (FAULT_WORD_1/2)		Remark
F 20	Local & disconnected	<p>No communication between CDP 31x/CMT and DCS 500B / DCF 500B or DCP 500B in local control mode (LOCAL)</p> <p>Check: - Connection cable between CDP 31x – DCS 500 / DCP 500 (unplug connection cable from CDP 31x and plug in again); - Communication board SNAT 6xx and appropriate programm O.K.? - Local mode terminated when panel/PC was removed?</p>	11102	bit 11	(1) Self re-setting
F 21	Ext.Overvolt.Fault	<p>Overvoltage protection DCF 506 has acted</p> <p>There was an overvoltage condition in the DC circuit of the field supply, which had been limited by the activation of a free wheeling circuit.</p> <p>Check: - Power wiring of the field supply - Control logic according to wiring example? - Does PP_DI_OVP [1216] has been connected to a binary input? - Setting of OVP_SELECT [1217] correct? (see Alarm 121)</p>	11103	bit 12	(1) S21.232 and higher
F 23	Motor stalled	<p>Motor stalled</p> <p>While starting the motor the current exceeded the value of parameter [P 2207] for a time longer than parameter [P 2208] and the speed feedback value was below parameter [P 2206].</p> <p>Check: - Motor stalled? - Load changed during start? - Correct field current? - Current/torque limitation; - Parameter settings [P 22xx].</p>	11102	bit 14	(3)
F 27	Motor 2 overload	<p>Overload of MOTOR 2 (Thermal model 2). {see Fault Code F 7}</p>	11101	bit 9	(2)

Code seven segm. display	Text on LCD of control panel CDP 31x	Definition / Action	Status signal (FAULT_WORD_1/2)		Remark
F 28	Armature over-voltage	Armature (DC circuit) overvoltage Check: - Setting of param. [P 511] suitable for the system configuration? - Setting of field current and actual value as well as the complete field supply (FIELD EXCITER); - Was the motor accelerated by the load? - Speed scaling; - Armature voltage feedback; - Connections between SDCS-CON-x and SDCS-PIN boards; - Coding of voltage evaluation on SDCS-PIN-xx board.	11101	bit 2	(1)
F 29	Mains undervoltage	Mains supply undervoltage (AC); setting via parameter [P 509] Check: - Does the supply voltage exist? - Did the mains contactor close? - Setting of voltage feedback coding (voltage scaling) correct? - Connections between SDCS-CON-x and SDCS-PIN-xx boards; - Coding of voltage evaluation on SDCS-PIN-xx board.	11101	bit 11	(3)
F 30	Mains overvoltage	Mains supply overvoltage (AC) Mains voltage > 130% of nominal value for longer than 10s. Fault tracing see Fault Code F 29.	11101	bit 12	(1)
F 31	Not in synchronism	Synchronization fault (of mains) Check: - Mains supply, fuses etc.; - Mains voltage and stability.	11101	bit 13	(3)
F 32	Field ex.1 overcurr	FIELD EXCITER 1 (field supply 1) overcurrent Check: - Parameters of FIELD EXCITER 1; - Connections of field exciter as well as insulation level of cable and of field winding.	11101	bit 14	(1)
F 33	Field ex.1 comerror	FIELD EXCITER 1 communication error Check: - Flat cable connections X14: or cable X16: between SDCS-CON-x board and field exciter; - Auxil. voltage for ext. field exciter.	11101	bit 15	(1)

Code seven segm. display	Text on LCD of control panel CDP 31x	Definition / Action	Status signal (FAULT_WORD_1/2)		Remark
F 34	Arm. curent ripple	Armature current ripple One or several thyristors carry no current. Check: - Current feedback with oscilloscope (6 pulses within one cycle visible?) - Branch fuses, thyristor gate connection; gate-cathode resistance. - Sensitivity of monitoring function: set CUR_RIPPLE_LIM [421] (depending on methode; see A 137)	11102	bit 0	(3) modified in S21.232
F 35	Field ex.2 overcurr	FIELD EXCITER 2 (field supply 2) overcurrent {See Fault Code F 32}	11102	bit 1	(1)
F 36	Field ex.2 comerror	FIELD EXCITER 2 communication error {See Fault Code F 33}	11102	bit 2	(1)
F 37	Motor overspeed	Motor overspeed Speed feedback higher than parameter [P 2204]. Check: - Scaling of speed controller loop; - Drive speed; - Field reference values; - Speed feedback and connection of speed feedback; - Was the motor accelerated by the load?	11102	bit 15	(3)
F 38	Phase sequence fault	Phase sequence fault of power section Change supply phase sequency or make correction with parameter [P 506]. Attention: Direction of rotation of 3-phase fan correct?	11102	bit 3	(3)
F 39	No field ack.	No field acknowledge from FIELD EXCITER This message is either caused by the field exciter's missing „ready for operation“ signal (1) or the field current being lower than the threshold (2). Reasons for (1): - field supply not in synchronism, or - electronic power supply for the field unit not within permissible limits - power supply for the field unit not within permissible limits Reasons for (2): - field supply unit is broken - field reversal took too long time - field current lower than threshold because	11102	bit 4	(1)

Code seven segm. display	Text on LCD of control panel CDP 31x	Definition / Action	Status signal (FAULT_WORD_1/2)		Remark
		field weakening range too big / threshold too high Check: - Do selection parameters match the field exciter (field supply)? - Field exciter, it's supply, cable and field winding; - Take this error message at the data logger as a trigger condition and record signals 11302 and 11203 - Status/level of acknowledge signal.			
F 40	No ext. FAN ack.	No acknowledge from FAN of motor Check: - Was input for acknowledge signal (parameter [P 911]) used? - Contactor circuit/supply for fan of motor; - Status of binary inputs/outputs (DI/DO) on SDCS-IOB-1/2 board.	11102	bit 6	(1)
F 41	No main cont. ack.	Missing main contactor acknowledge Check: - Switch-ON/-OFF sequence correct? - Status of binary input DI for acknowledge signal and of ACK MAIN CONT ([P 912]) after main contactor is closed; - Status of binary output DO resp. of auxiliary contactor (relay) closing the main contactor after ON/OFF command.	11102	bit 7	(3)
F 42	Field ex.1 not OK	FIELD EXCITER 1 (field supply 1) status is not O.K. A fault was found during self-diagnosis of field exciter {see [11203] } Check: - Field exciter operation; change the unit, if necessary.	11102	bit 12	(1)
F 43	Field ex.2 not OK	FIELD EXCITER 2 (field supply 2) status is not O.K. {See Fault Code F 42 }	11102	bit 13	(1)

Code seven segm. display	Text on LCD of control panel CDP 31x	Definition / Action	Status signal (FAULT_WORD_1/2)		Remark
F 44	I/O-Board not found	<p>Missing input/output (I/O-) boards IOB1/2x/3/IOE1</p> <p>The existance of the boards had been recognized by the software and something happened to the board or the cable.</p> <p>Check: - Is +/- 10 V supply available? - Flat cable connections between SDCS-CON-x and SDCS-IOB-1/2x/3/IOE1</p>	11101	bit 7	(1) Can not be reset
F 48	Motor 2 overtemp.	<p>Overtemperature of MOTOR 2</p> <p>Check: - Parameter setting MOT2 TEMP_FAULT_L [P 1603] correct? {See Fault Code F 6}</p>	11101	bit 8	(2)
F 50	No C FAN ack	<p>No CONVERTER FAN supply acknowledge</p> <p>Depending on type of unit (size):</p> <p>Size C4 ⇒ Fault signal F 50 Sizes C1/C2/A5 ⇒ Alarm signal A 126</p> <p>Check: - Was input for acknowledge signal (parameter [P 910]) used? {See Fault Code F 40}.</p>	11102	bit 10	(2)
F 52	No BRAKE ack	<p>No BRAKE acknowledge</p> <p>Check: - Was parameter [P 304] used? - Cabling and limit switches.</p>	11101	bit 10	(2)
F 60	Fieldbus Timeout	<p>Serial interface (communication bus) is not O.K.</p> <p>Check: - Does a field bus module selected via parameter [P 4001] exist? - Communication between control system and module Nxxx-0x O.K.? No or incomplete telegrams? - Communication between module Nxxx-0x and thyristor power converter O.K.? - Correct setting of the time interval between two telegrams via parameter [P 921]?</p>	11103	bit 13	—/(3) Depends on [P 920]

Code seven segm. display	Text on LCD of control panel CDP 31x	Definition / Action	Status signal (FAULT_WORD_1/2)		Remark
F 65	Reversal Fault	<p>Reversal of direction of current is not O.K. The reversal of the direction of current was not correct.</p> <p>Check: - External cabling between both thyristor power converters; - Correct plugging in of flat cable X18:?</p>	11103	bit 15	(3)
F 66	Current Difference	<p>Current feedback difference (deviation) between Master and Slave Drive</p> <p>There is a current feedback difference (deviation) between Master and Slave Drive (in twelve pulse configuration).</p> <p>Check: - Parameter settings [P 3606] and [P 3605]; - Power-circuit cabling; - Symmetry of control logic and scaling of signals exchanged between Master and Slave Drive.</p>	11103	bit 14	(3)

4.5 Alarm Signals (A)

The alarm signals will be shown on the seven segment display of the control board SDCS-CON-x as codes A . . as well as on the LCD of the control panel CDP 31x as plain text. Alarm signals will only be displayed, if there is no fault signal active.

The alarm signals - with the exception of **A 101** and **A 102** - will **not** result in switching off the signal 10910 resp. in stopping the drive.

Code seven segm. display	Text on LCD of control panel CDP 31x	Definition / Possible source	Signal number (ALARM_WORD_1/2)		Remark
A 101	Start inhibition	Alarm Start Inhibition Pin 908 (START_INHIBIT) is set to logical "1"; drive cannot be switched ON. When pin is set to logical "0", the alarm signal will be reset.	11104	bit 0	
A 102	Emergency stop	Alarm EMERGENCY STOP Pin 906 has a logical "0" level; for signal reset, see introductory remarks in Chapter 4.4 "Fault Signals" and Chapter 3.7 "EMERGENCY STOP RESETTING".	11104	bit 1	
A 103	Motor 1 temp. alarm	Alarm Overtemperature MOTOR 1 Check: - Parameter setting MOT1.TEMP_ALARM_L [P 1402] correct? See also Fault Code F 6 .	11104	bit 2	
A 104	Motor 1 overl.alarm	Alarm Overload MOTOR 1 (Thermal Model 1) Check: - See Fault Code F 7 .	11104	bit 3	
A 105	Conv. overtemp. alarm	Alarm Overtemperature Power Section This signal will already appear at approx. 10 °C below the shutdown temperature applying for Fault Signal F 4 (see P 10512). Check: - See Fault Code F 4 .	11104	bit 4	
A 106	Current reg blocked	Alarm Current Regulator/Controller blocked Pin 404 (BLOCK) is set to logical "1". When pin is set to logical "0", the alarm signal will be reset.	11104	bit 5	

Code seven segm. display	Text on LCD of control panel CDP 31x	Definition / Possible source	Signal number (ALARM_WORD_1/2)		Remark
A 108	RAM-backup failed	Alarm No Battery Backup Function for RAM Capacitor for RAM backup has discharged (perhaps unit has been stored for too long without the electronics voltage switched on?); load capacitor by leaving unit electronics switched on for a lengthy period.	11104	bit 7	
A 110	System restart	Alarm System Restart Signal is filed in fault memory (fault logger), but not displayed at the unit or the LC-Display of the CDP 31x.			
A 118	Mains underv.alarm	Alarm Mains Undervoltage (AC) Setting of undervoltage monitoring with Parameter [P 508] Check: - See also Fault Code F 29.	11104	bit 10	
A 120	Arm.curr.dev.alarm	Alarm Armature Current Deviation If the current reference [P 10405] deviates from the current feedback for more than 5 sec by more than 20 %, referenced to the rated current, this signal will be outputted.	11104	bit 13	
A 121	Ext.Overvolt.Alarm	Overvoltage protection DCF 506 has acted There was an overvoltage condition in the DC circuit of the field supply, which had been limited by the activation of a free wheeling circuit. Check: - Power wiring of the field supply - Control logic according to wiring example? - Does PP_DI_OVP [1216] has been connected to a binary input? - Setting of OVP_SELECT [1217] correct? (see Fault 121)	11105	bit 6	S21.232 and higher
A 123	Motor 2 temp. alarm	Alarm Overtemperature MOTOR 2 Check: - Parameter setting MOT2.TEMP_ALARM_L [P 1602] correct? See also Fault Code F 6.	11104	bit 8	
A 124	Motor 2 overl alarm	Alarm Overload MOTOR 2 (Thermal Model 2) Check: - See Fault Code F 7.	11104	bit 9	
A 126	Conv.FAN ack.alarm	Alarm No (Thyristor Power) Converter FAN Acknowledge Check: - See Fault Code F 50.	11104	bit 12	

Code seven segm. display	Text on LCD of control panel CDP 31x	Definition / Possible source	Signal number		Remark
			(ALARM_WORD_1/2)		
A 127	Ext. FAN ack.alarm	Alarm No Acknowledge from External FAN (of Motor) Check: - See Fault Code F 40 .	11104	bit 15	
A 128	Panel disconnected	Alarm No Communication with (Control) Panel CDP 31x No communication is possible with the control Panel CDP 31x in REMOTE mode; the alarm signal will disappear once communication is in order again.	11105	bit 0	
A 129	Type code changed	Alarm Type Code (Hardware Code of Thyristor Power Converter) changed Unit type code stored in memory differs from the hardware coding. Check: - New control board SDCS-CON-x? - Control board SDCS-CON-x / SDCS-PIN-xx board interchanged? Action: - Save values in non-volatile memory using BACKUPSTORE-MODE [11202]; see also Alarm Code A 130 .	11105	bit 1	
A 130	Init values read,S2	Alarm Initialization Values read into RAM Default values have been loaded into the RAM, e.g. using Jumper S2 . Signal will then often appear in conjunction with Alarm Code A 129 ; but will not always be shown on the unit's seven-segment display, though it will always be entered in the Fault Logger.	11105	bit 2	
A 132	Param set 2 missing	Alarm Valid Parameter Set 2 missing Check: - Has - before activation of Parameter Set 2 (over [P 913] or [P 11202]) - the content of the RAM been saved over [P 11202], Value 5 (SELECT_MOT2_SET) in Motor Set 2?	11105	bit 3	

Code seven segm. display	Text on LCD of control panel CDP 31x	Definition / Possible source	Signal number		Remark
			(ALARM_WORD_1/2)		
A 134	Backup not allowed	Alarm Change of Parameter Set not allowed Signal will appear when an attempt has been made to change from Motor Set 1 to Motor Set 2 or vice versa, e.g. while the motor shaft is turning or the line contactor is switched on.	11105	bit 4	
A 136	Write backup alarm	Alarm Write Backup of Values in Non-Volatile Memory failed The attempt to save values in non-volatile memory has failed; parameter memory could not be erased. Check: - Is Jumper S3 enabling the save routine?	11105	bit 5	
A 137	Arm. current ripple	Armature current ripple One or several thyristors carry no current. Check: - Current feedback with oscilloscope (6 pulses within one cycle visible?) - Branch fuses, thyristor gate connection; gate-cathode resistance. - Sensitivity of monitoring function: set CUR_RIPPLE_LIM [421] (depending on the methode; see F34)	11105	bit 9	Can not be re-set
A 138	Init values read	Alarm Initialization Values read Default values have been loaded, using Parameter [P 11202], Value 3 (FACTORY_SET_VALUE); signal may only be entered in the Fault Logger.	—	—	
A 140	Auto-reclosing	Auto-Reclosing (Self-Restart) This alarm indicates when self-restart is performed. During that time the alarms F29, F31, F39 and F41 are suppressed. This function is started when the line voltage drops below the alarm or error threshold, when not in synchronism, no field or no line contactor acknowledgement and with PWR_LOSS_MODE [9.19] = enable and PWR_DOWN_TIME [5.10] greater than zero.	11105	bit 8	modified in S21.232

Code seven segm. display	Text on LCD of control panel CDP 31x	Definition / Possible source	Signal number (ALARM_WORD_1/2)		Remark
A 143	Macro change failed	<p>Alarm Change from Macro x to Macro y has failed</p> <p>At Macro x, macro-specific links or function blocks have been changed in comparison to the as-delivered status. The value of the macro selection parameter has then also been changed.</p> <p>Notes on how to proceed when:</p> <ol style="list-style-type: none"> 1. "selection parameter has been unintentionally altered" <ul style="list-style-type: none"> - Set parameter to old value; - Execute BACKUPSTOREMODE; - Switch electronics supply OFF and then ON again. 2. "Macro x is be removed in its entirety" <ul style="list-style-type: none"> - Move jumper S2 (on SDCS-CON-x) to Position 1–2 with electronics supply switched OFF; - Switch ON electronics; - Select BACKUPSTOREMODE [11202]; - Save default parameter set; - Switch OFF electronics; - Reset jumper S2 to its original position; - Switch ON electronics again. 	11105	Bit 7	S21.226 and higher

4.6 Status Signals

The status of drive functions (autotuning of controllers; saving values) is shown by status signals named 11201 and 11202. The status of the first and / or the second field exciter, the torque control sequencing and the current controller is shown by the signals 11203 to 11205.

In case of a drive function, which is started by setting a parameter to a defined value the status is indicated automatically on the LCD display of the panel CDP 31x in plain text. The indication will show the result directly or will cross-reference to the final location.

The status of the field exciter(s), torque control and current controller is updated regularly by the converter software and can be checked if one of the three signals is selected.

Depending on the tool in use (CDP 31x or CMT tool) the plain text or a number appears on the display / screen. This number represents a code which is equivalent to the plain text for signal 11201; for all others it's a binary coded decimal number (the 16 bit word with the binary value for each signals is transferred to decimal).

Parameter	Code / bit	Text on LCD of control panel CDP 31x	Definition / explication of the signal	Remark
11201	--	----	COMMIS_STAT: Result from a drive function. Gives feedback status information when the DRIVEMODE parameter (1201) was used to start a drive function.	
	0	NOT ACTIVATED	selected function successfully worked out	
	1	RUN COMMAND ?	see code 53	
	2	FEXC SEL ?	wrong FEX selection	
	3	FEXC RDY OPER=0	FEX1 / 2 or DCF 503/4 not ready for operation	
	4	FEXC OK=0	field supply not o.k.; see error message on the display of the converter	
	5	FIELD ON=0	FEX1 / 2 or DCF 503/4 not switched on	
	6	IF NOT IN 95–105%	field current not within 95% 105%	
	7	NOT O.K.AFTER 20s	drive was not released by hardware within 20s	
	8	reserved	up to 34	
	35	CANNOT AUTOTUNE	cannot autotune the armature current controller	
	36	reserved	up to 48	
	49	IF AT START ?	Field current does not reach reference within 10s, when the selftuning is started	

Parameter	Code / bit	Text on LCD of control panel CDP 31x	Definition / explication of the signal	Remark
11201	--	----	Gives feedback status information when the DRIVEMODE parameter (1201) was used to start the drive function 3, 5 or 6 (autotuning).	
	50	OHMIC LOAD ?	Ohmic load not determined	
	51	I ACT FEEDBACK ?	Current feedback is less than current reference during measurement of armature resistance. Current limits are lower than the limit for continuous current flow or lower than 20%.	
	52	CURRENT CURVE ?	Bad current curve. Fuse blown,thyristor not firing or no motor load	
	53	RUN COMMAND ?	Wrong starting conditions. The drive is running when the autotuning is started or run command is not given within 20 s after start of autotuning	
	54	TOO HIGH SPEED ?	Too high speed during autotuning .Speed greater than 1% or EMF greater than 15%.	
	55	INDUCTANCE ?	Inductance cannot be determined. Fuse blown, thyristor not firing or no motor load	
	56	CONT CURR LIM ?	Limit for continuous current flow cannot be determined	
	57	FIELD REMOVAL ?	The field removal takes longer time than 10 s	
	58	STOP COMMAND ?	Current regulator blocking or stop command appears during autotuning	
	59	MUST BE LOCAL	Drive is not in local mode	
	60	CANNOT AUTOTUNE	cannot autotune the field current controller	
	61	ILL START COND.	illegal start condition for field autotuning	
11202	--	----	BACKUPSTOREMODE: Status of this mode. This is used to give commands to parameter handling function in the drive	
	0	NONE		
	1	SAVE MOT1 SET	Save motor set 1	
	2	SAVE MOT2 SET	Save motor set 2	
	3	FACTORY SET VAL.	Load factory values	
	4	SELECT MOT1 SET	Load motor set 1	
	5	SELECT MOT2 SET	Load motor set 2	

Parameter	Code / bit	Text on LCD of control panel CDP 31x	Definition / explication of the signal	Remark
	6	READ APPL BLOCKS	Load application; if additional function blocks are activated and saved via SAVE MOTx SET and modified afterwards without saving the configuration before the last modification (the one directly after the last SAVE action) can be activated	
11202	--	----	While the command is executing the value of BACKUPSTOREMODE will show what is happening or the reason for error if the command fails	
	7	ERASE ERROR	Error during erasing of parameter flash	
	8	ERASING...	Erasing the parameter flash	
	9	PROGRAM ERROR	Error during programing of parameter flash	
	10	PROGRAMMING...	Programing the parameter flash	
	11	WRONG FLASH TYPE	Verification error	
	12	READING...	Reading the parameter flash	
	13	READ ERROR	Error during reading of parameter flash	
	14	reserved		
	15	VERSION ERROR	Bad type of parameter flash	
	16	reserved		
	17	SIZE ERROR	Bad size of parameter flash	
11203	--	----	FEXC_STATUS: Status of the field exciters 1 and 2	
	00	(FEXC1_RDY_OPER)	0 = not ready for operation; AC-voltage missing	
	01	(FEXC1_OK)	0 = self diagnostic failed or power failure in FEX 1	
	02	(EXC2_RDY_OPER)	0 = not ready for operation; AC-voltage missing	
	03	(EXC2_OK)	0 = self diagnostic failed or power failure in FEX 2	
	04	(ACK_FEXC1_ON)	1 = motor 1 field OK	
	05	(ACK_FEXC2_ON)	1 = motor 2 field OK	
	06	(FIELD_HEAT_ON)	1 = motor heating function active	
	07	(FIELD1_REV_ACK	direction of the field 0 = forward, 1 = reverse	
	08	(ACK_CSC_ON)	1 = on-command accepted by sequence control	
	09	(ACK_FEXC_ON)	1 = motor field OK	
	10	(FIELD_REF_ON)	1 = field current reference released	
	11	(FIELD1_CURR_MIN_L)	1 = motor 1 field current above min level	

Parameter	Code / bit	Text on LCD of control panel CDP 31x	Definition / explication of the signal	Remark
	12	(FIELD2_CURR_MIN_L)	1 = motor 2 field current above min level	
11204	--	----	TC_STATUS: Status of the torque control sequencing	
	00	(RDY ON)	1 = ready for closing contractor	
	01	(MAIN CONT ON)	1 = command to close contractor	
	02	(RDY RUNNING)	1 = ready for run command	
	03	(RUNNING)	1 = command to release controllers	
	04	(TC_RDY_REF)	1 = ready for reference	
	05	(TC_FIELD_CHANGE)	1 = field reversal is active	
	06	(CONTINUOUS_CURR)	1 = armature current is discontinuous	
11205	--	----	BC: Status of the current regulator. If the value of BC is zero, everything is OK. Otherwise different bits of BC will indicate the reason for blocking the current regulator	
	00	-----	Overcurrent	
	01	-----	Freewheeling unit was fired	
	02	-----	field reversal	
	03	-----	supply system undervoltage	
	04	-----	12Puls only: fault 65 and 66 occurred	
	05	-----	12Puls only: signal via cable X18	
	06	-----	supply system overvoltage	
	07	-----	type code error	
	08	-----	suppression of controller at regulator change-over	
	09	-----	processor overload	
	10	-----	thyristor diagnostic running	
	11	-----	-----	
	12	-----	primary (AC) or secondary (48Vdc) power failure	
	13	-----	synchronization signal missing	
	14	-----	pulse firing section not in synchronism	
	15	-----	not released	

Appendix A - Connection diagrams

Connection diagram 1

For detailed information see
System description DCS 500B / DCF 500B.

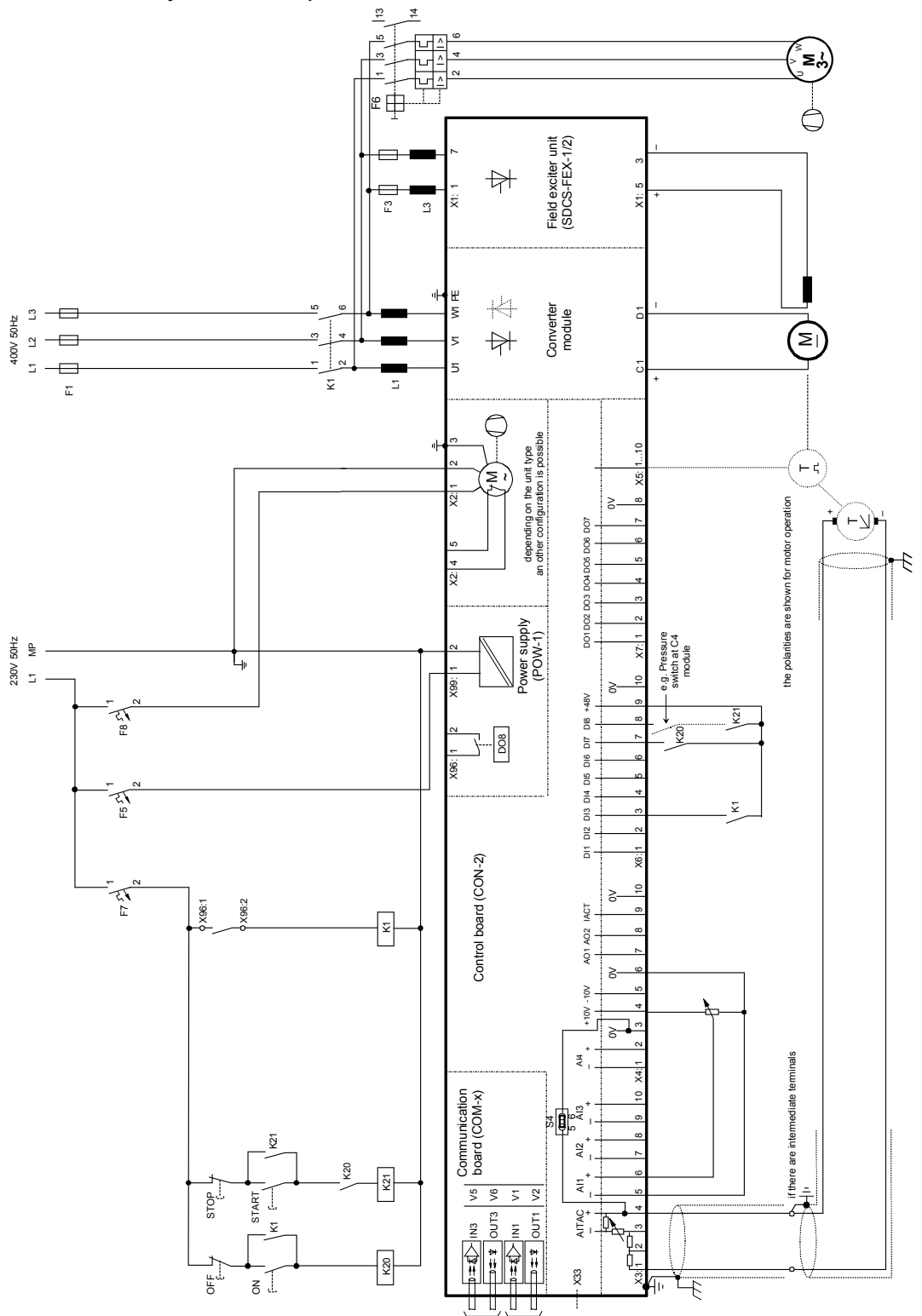

Connection diagram 2

For detailed information see
System description DCS 500B / DCF 500B.





ABB Automation Products GmbH
Postfach 1180
Lampertheim • GERMANY
Tel: +49 (0) 62 06-5 03-0
Fax: +49 (0) 62 06-5 03-6 09
www.abb.com/dc

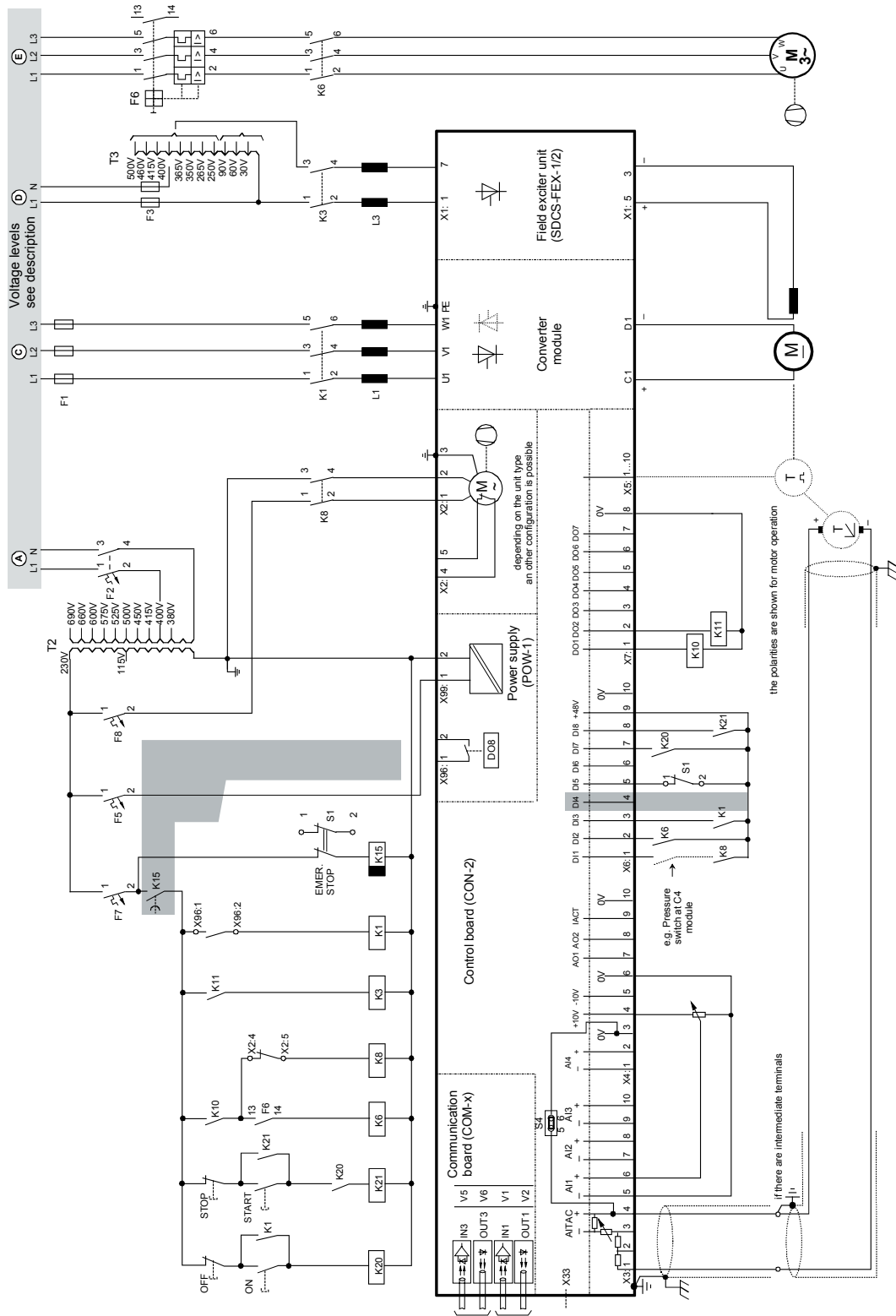

055R0401A2440000

Ident. No.: 3ADW 000 055 R0401 Rev D
09_01