

INSTALLATION GUIDE

DEC-31.-2013

● SYSTEM INTRODUCTION

The Locator system includes the following components:

Locator (LT-49): The Locator receives 433 MHZ signal sent from WTR and transmits the signal in 912 MHZ to Repeater (RPN-99) or Base Unit (BUN-152).

Repeater (RPN-99): (Optional) The Repeater is an optional device used to relay signal sent from Locator with same Group number and System ID in 912 MHZ.

Base Unit (BUN-152): The Base Unit receives the signals sent from Locator or Repeater in 912 MHZ and forward the signal to PSTN Dialer via RS232 connection

● SYSTEM OPERATION DIAGRAM

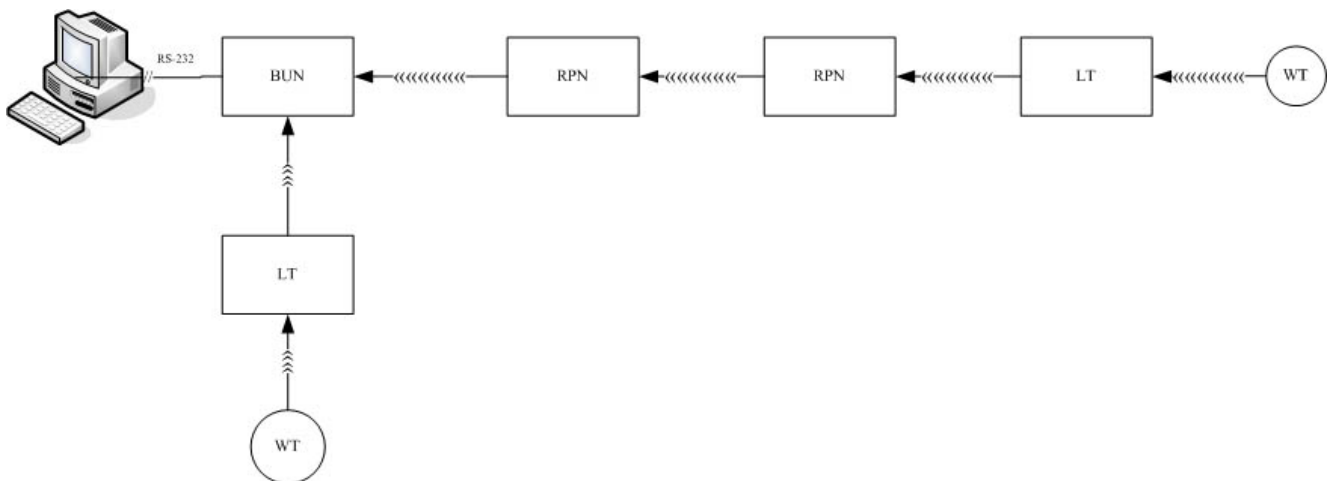

● SYSTEM CAPABILITY:

- Each system can have maximum of 4096 LT-49 and 4096 RPN-99.
- Each Locator and Repeater has its own ID Code set by a 12-pin Dip Switch.
- The frequency hopping technology is adopted in the communication between Locator, Repeater and BUN-152.
- There are three groups of hopping frequency bands are available. Each group contains 25 channels:
GROUP 1: 906.26 ~ 914.90 MHZ, 25 channels
GROUP 2: 906.38 ~ 915.02 MHZ, 25 channels
GROUP 3: 906.50 ~ 915.14 MHZ, 25 channels
- Make sure the distance between BUN-152, RPN-99 and LT-49 is greater than 5 meters. If the distance is too close, the signal may interfere with each other.

BUN-152 Base Unit

● Front View of BUN-152:



LED:

- On: AC Power Supplied
- Flashes: Receiving signal transmission from Locator or Repeater

ANTENNA connector (TNC connector):

- The two connectors for Antenna is used to improve signal reception. During the installation, be sure to put both Antennas upwards and then screw it towards the TNC connector.

● Rear View:

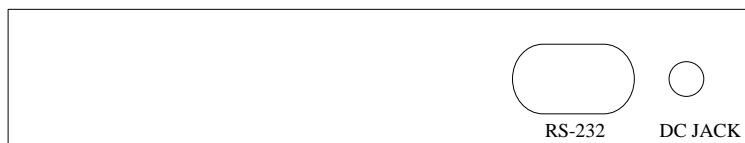

DC JACK: For connecting to 12V 500mA Power Adaptor

RS-232 CONNECTOR: Connects the RS-232 cable to PSTN Dialer.

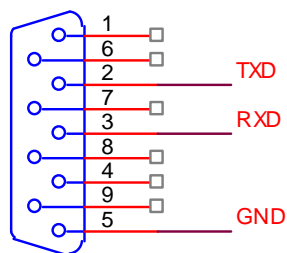

Pin2: TXD

Pin3: RXD

Pin5: GOUND

Pin 1,4,5,6,7,8,9 : No Connection.

● Interior View:

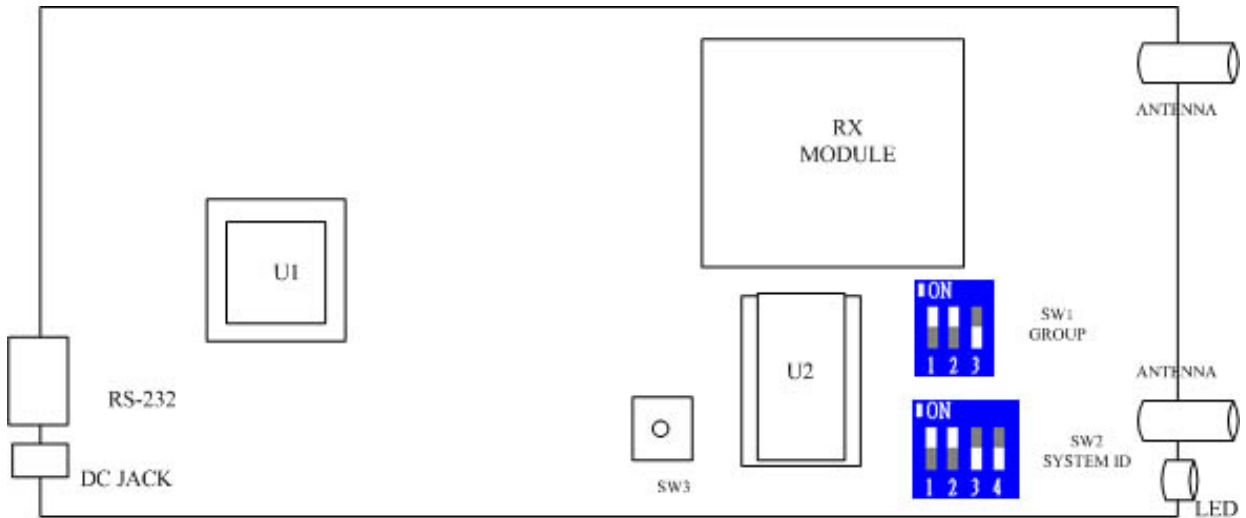

SW1: The SW1 switch block contains 3 dip switches for setting Group Frequency. Slide the SW1 up (On position) with SW2 & SW3 down (Off position), to select Group1 frequency band. Likewise, slide SW2 or SW3 up (On) with others, down (Off), Group2 or Group3 is selected accordingly.

SW1	SW2	SW3	Group
On	Off	Off	Group1
Off	On	Off	Group2
Off	Off	On	Group3



GROUP 1 frequency: 906.26 ~ 914.90 MHZ, 25 channels with spacing of 360KHZ between each channel.

GROUP 2 frequency: 906.38 ~ 915.02 MHZ, with spacing of 360KHZ between each channel.

GROUP 3 frequency: 906.50 ~ 915.14 MHZ, with spacing of 360KHZ between each channel.

SW2: The SW1 switch block contains 4 dip switches for setting the Base Unit's System ID Code, there are total of 16 SYSTEM ID combinations for use from 0 to 15. The Base Station's System ID setting must be identical to

<EXAMPLE>



<NOTE>

☞ **Group and System ID setting must be identical for Base Station and all Locator and Repeaters.**

LT-49 Locator

● Front View:

LED 1 (Green/Red):

Green On: AC Power supplied.

Green Flash: AC Power disconnected

Red On: Low Battery

LED 2 (Red):

Red Flash: Receiving signal from WTR

LED 3 (Red):

Red Flash: Transmitting signal

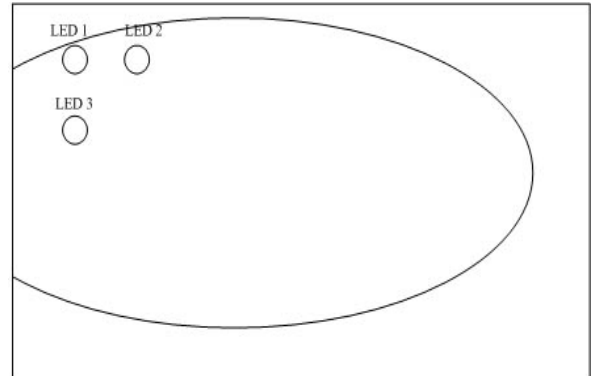

● Rear View (Lid removed):

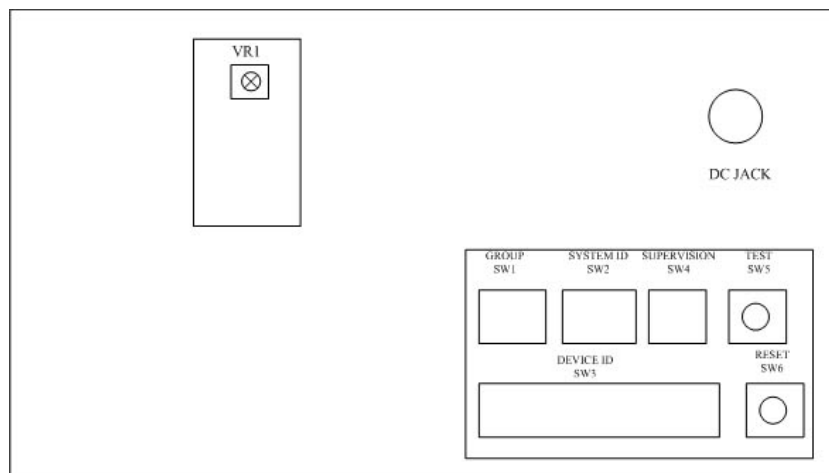

DC JACK: For connecting DC 15V 1.2A Power Adaptor.

VR1 : For adjusting the Locator's 433MHZ receiver sensitivity. Turn the switch clockwise to increase radio reception range for WTR. Turn the switch counter-clock wise to decrease the radio range.

SW1 : For setting the Group number, please refer to the section "BUN-152". **The Locator's Group Number must be identical to the Base Station Group Number.**

SW2 : For setting the system ID code, please refer to the section "BUN-152". **The Locator's System ID must be identical to the Base Station System ID.**

SW 3 : A 12-pin dip switch block to set the "Unit ID Number".

Each Locator should be assigned an unique ID Number for the Base Station to distinguish from which locator the signal was transmitted.

There are a total of $2^{12} = 4096$ combinations for a maximum of 4096 Locators to be used in one system.

<EXAMPLE>

The following examples show you how the “Unit ID” is set (B represents for Binary, H for Hex and the last numbers represents for Decimal):

UP=1 , DOWN =0

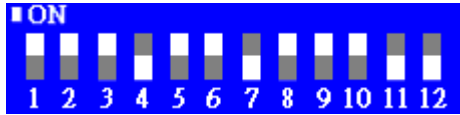

UNIT ID=000100100011B=0123H = 291

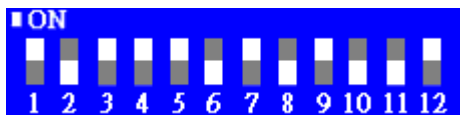

UNIT ID=010001010110B=0456H = 1110

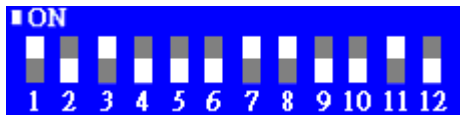

UNIT ID=010111001101B=05CDH = 1485

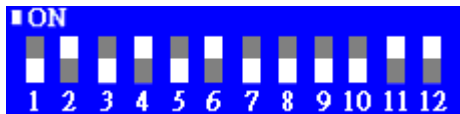

UNIT ID=101010111100B=0ABCH = 2748

SW4: A 3-pin dip switch block to set the “supervision period”. 8 options are available as shown in table below:

SW1	SW2	SW3	Supervision Period
Off	Off	Off	Disable
Off	Off	On	1 hour
Off	On	Off	2 hours
Off	On	On	3 hours
On	Off	Off	4 hours
On	Off	On	8 hours
On	On	Off	10 hours
On	On	On	12 hours

<EXAMPLE>

If a 2-hour supervision period is set (SW1-off, SW2-On, SW3-off), the RPN-99 will send the “supervision” signal every 2 hours.

SW 5 : TEST button.

When it is pressed, RPN-99 will automatically sends out a Test signal. It can be used for Range Test.

SW 6: RESET button.

Pressing the button, the RPN-99 will do a power-on Reset and send a “power-on check-in” signal.

● **Power Supply**

- A DC 15V, 1.2A power adaptor is used to power the Locator.
- A 1600mAh x 8 Ni-mh rechargeable battery is used as a back-up power. It takes approximately 72 hours to fully charge the battery.

● **Mounting the Locator**

- A mounting bracket is included in the Locator package for wall mounting.
 1. Use the two holes in the mounting bracket as a template, drill two holes on the place of desired installation and insert wall plugs if required.
 2. Screw the mounting bracket onto drilled hole.
 3. Hook the Locator on the bracket.

● **Tamper protection**

- The Locator also features “Tamper protection” after hanging on the mounting bracket, any attempt to remove it from the mounting bracket will trigger the tamper switch and the RPN-99 will transmit the “Tamper active” signal accordingly.

● **Queue Buffer**

- The Locator has a Queue Buffer to store up to 12 signals to be transmitted.
- During transmission, the Locator takes the data from the Queue Buffer one-by-one following First-in-First-out algorithm.
- If a signal received already exists in the Queue Buffer, this signal will be ignored.
- When the Queue Buffer is full, any signal received will be ignored.
- The data being transmitted will be put into another “Time-out Buffer” and a 10-sec timer will start counting. If a signal received is already in the “Time-out Buffer”, this signal will also be ignored.

- **Changing the Dip Switch setting**

- The Locator checks the Dip Switch setting only when power is supplied. Be sure to set the appropriate “Group Number”, “System ID” & “Unit ID” before power it on.
- If it is necessary to change the Dip Switch setting after power on. Press the “Reset” button to do the power on Reset, otherwise the change will be ignored.

Repeater RPN-99

● Front View:

LED 1 (Green/Red):

Green On: AC Power supplied.

Green Flash: AC Power disconnected

Red On: Low Battery

LED 2 (Red):

Red Flash: Receiving signal from Locator or other Repeater

LED 3 (Red):

Red Flash: Transmitting signal

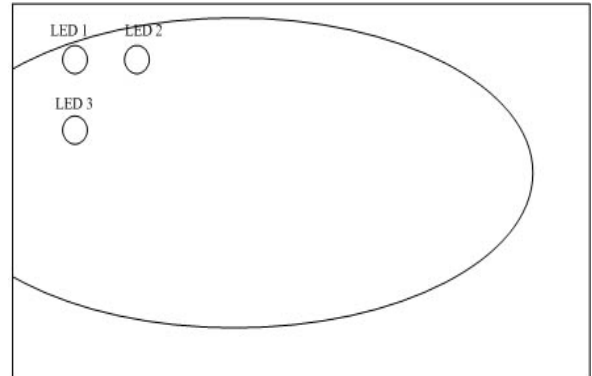

● Rear View (Lid removed):

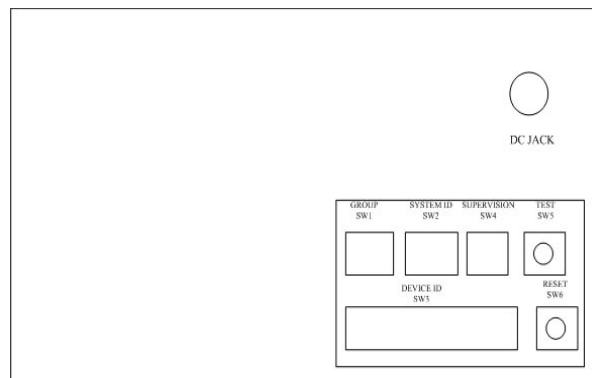

DC JACK: For connecting DC 15V 1.2A Power Adaptor.

SW 1 : For setting the Group number, please refer to the section “BUN-152”. **The Repeater’s Group Number must be identical to the Base Station Group Number.**

SW 2 : For setting the system ID code, please refer to the section “BUN-152”. **The Repeater’s System ID must be identical to the Base Station System ID.**

SW 3 : A 12-pin dip switch block to set the “Unit ID Number”. Refer to Locator section for setting detail.

SW 4 : A 3-pin dip switch block to set the “supervision period”. Refer to Locator section for setting detail.

SW 5 : TEST button. Refer to Locator section for detail.

SW 6 : RESET button. Refer to Locator section for detail.

Refer to Locator section for Repeater operation guideline.

Specification Radio Frequency

1) BUN-152/RPN-99/LT-49 (900M Channels):

Frequency Hopping: Each group has a total of 25 channels.

There are 3 groups in total. Its frequency is as followed:

Group1: 906.26 ~ 914.90MHZ

Group2: 906.38 ~ 915.02MHZ

Group3: 906.50 ~ 915.14MHZ

Modulation: FM

Frequency deviation: 11.7KHZ

Data speed: 9.6K

Sensitivity: -102dBm

Band Width: 20KHZ

Channel separation: 360KHZ

Output Power: 28dBm

Frequency Tolerance: +/- 3ppm

Antenna: Dual antenna for receiver to avoid signal fading and dark spot separate antenna for transmitter.

Communication method: full Duplex, Transmission and receiving are able to be carried on simultaneously.

Range: Over 3 KM in open space.

2) 433.92MHZ Channel

Frequency: 433.92MHZ +/- 100KHZ

Modulation: AM (100%)

Sensitivity: -117dBm

Distance of Receiving range: 6 ~ 100 Meter (adjustable)

Communication method: Full duplex.

Federal Communication Commission Interference Statement

This equipment has been tested and found to comply with the limits for a Class B digital device, pursuant to Part 15 of the FCC Rules. These limits are designed to provide reasonable protection against harmful interference in a residential installation.

This equipment generates, uses and can radiate radio frequency energy and, if not installed and used in accordance with the instructions, may cause harmful interference to radio communications. However, there is no guarantee that interference will not occur in a particular installation. If this equipment does cause harmful interference to radio or television reception, which can be determined by turning the equipment off and on, the user is encouraged to try to correct the interference by one of the following measures:

- . Reorient or relocate the receiving antenna.
- . Increase the separation between the equipment and receiver.
- . Connect the equipment into an outlet on a circuit different from that to which the receiver is connected.
- . Consult the dealer or an experienced radio/TV technician for help.

FCC Caution: To assure continued compliance, any changes or modifications not expressly approved by the party responsible for compliance could void the user's authority to operate this equipment. (Example - use only shielded interface cables when connecting to computer or peripheral devices).

FCC Radiation Exposure Statement

This equipment complies with FCC RF radiation exposure limits set forth for an uncontrolled environment. This equipment should be installed and operated with a minimum distance of 20 centimeters between the radiator and your body.

This transmitter must not be co-located or operating in conjunction with any other antenna or transmitter.

The antennas used for this transmitter must be installed to provide a separation distance of at least 20 cm from all persons and must not be co-located or operating in conjunction with any other antenna or transmitter.

This device complies with Part 15 of the FCC Rules. Operation is subject to the following two conditions:

- (1) This device may not cause harmful interference, and
- (2) This device must accept any interference received, including interference that may cause undesired operation.