

Cobra[®]

microTALK[®]

Owner's Manual

For more information or to
order any of our products,
please visit our website:

www.cobra.com

TWO-WAY RADIO MODEL
CXT1095 FLT

Printed in China
Part No. 490-932-P
English
Version A

Nothing Comes Close to a Cobra[®]

Nothing Comes Close to a Cobra[®]



Introduction

Making Life Easier and Safer

Staying in touch with your family and friends is convenient and easy when using your microTALK[®] radio. Some of the many uses you will discover include: Communicating with others while hiking, biking, and working; keeping track of family and friends at a crowded public event; checking with travel companions in another car; talking with neighbors; arranging meeting spots with others while shopping at the mall.

Belt Clip



Secure your microTALK[®] radio while on the go.

Carrying your microTALK[®] radio with you is easy when using the belt clip or optional wrist strap.

The belt clip easily attaches to your belt, purse, or backpack.

Customer Assistance



For Assistance in the U.S.A.

In this user's manual, you should find all the information you need to operate your microTALK[®] radio. If you require further assistance after reading this manual, Cobra Electronics offers the following customer assistance services:

Automated Help Desk

English only. 24 hours a day, 7 days a week 773-889-3087 (phone).

Customer Assistance Operators

English and Spanish. 8:00 a.m. to 5:30 p.m. Central Time, Monday through Friday (except holidays) 773-889-3087 (phone).

Questions

English and Spanish. Faxes can be received at 773-622-2269 (fax).

Technical Assistance

English only. www.cobra.com (on-line: Frequently Asked Questions).
English and Spanish. productinfo@cobra.com (e-mail).

**For Assistance Outside the U.S.A.
Contact Your Local Dealer**

©2013 Cobra Electronics Corporation
6500 West Cortland Street
Chicago, Illinois 60707 USA
www.cobra.com

A1

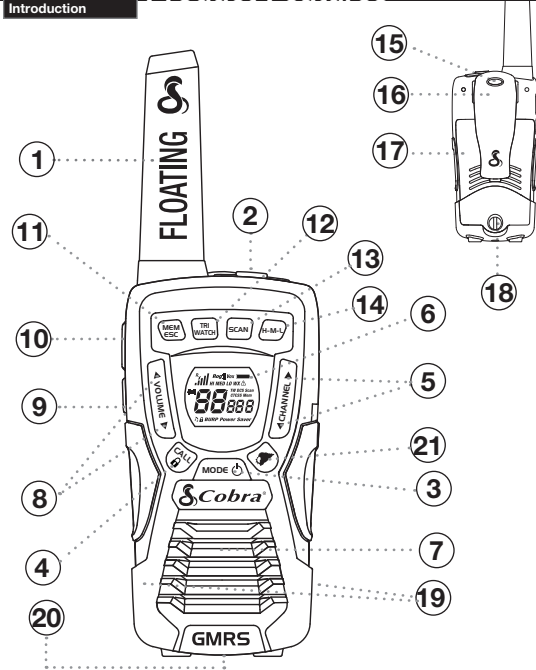

1. Antenna
2. External Speaker/
Microphone/ USB Charge Jack
3. Mode/Power Button
4. Call/Lock Button
5. Channel Up/Down
Buttons
6. Backlit LCD Display
7. Speaker/Microphone
8. Volume Up/Down Buttons
9. LED Light Button
10. Talk Button
11. Memory/Escape Button
12. Tri-Watch Button
13. Scan Button
14. Hi/Med/Lo Button
15. Wrist Strap Connection
16. Belt Clip
17. Battery Compartment
18. Battery Door Screws (2)
19. Rubberized Grips
20. LED Flashlight
21. Weather Button

A2

Features

- 22 Channels
Seven shared with FRS/GMRS, seven FRS only, eight GMRS only.
- 10 Channel Weather Radio
- Weather Alert
- 121 Privacy Codes
(38 CTCSS codes/
83 DCS codes)
- Hands-Free Operation (VOX)
- VibrAlert®
Silent Paging
- Tri-Watch
- Scan
Channels,
privacy codes
- Backlit LCD Display
- LED Flashlight
- Call Alert
Five selectable
tones
- Button Lock
- Speaker/
Microphone/
Charge Jack
- Roger Beep
Selectable On/Off
- Battery/Power Saver
- Keystroke Tones
- Battery Level Indicator
- Low Battery
Audible Alert
- Auto Squelch
- Belt Clip

A3

Backlit LCD Display

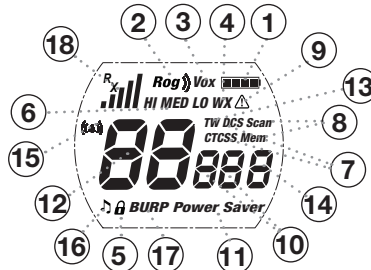

1. Battery Level Indicator
2. Roger Beep Icon
3. VOX Icon
4. Weather Icon
5. Lock Icon
6. Hi/Med/Low Power Icon
7. DCS/CTCSS Icons
8. Scan/Memory Icon
9. Weather Alert Icon
10. DCS/CTCSS Privacy Code Numbers
11. Power Saver Icon
12. Channel Numbers
13. Receive/Transmit Icon
14. Memory Channel Number
15. VibrAlert® / Call Alert Icon
16. Key Tone Icon
17. BURP Icon
18. Signal Strength Meter



Important FCC Licensing Information

This radio operates on General Mobile Radio Service (GMRS) frequencies which require a Federal Communications Commission (FCC) license. See page 19 for licensing and other related information.

Limited One-Year Warranty on Radio(s)

For Products Purchased in the U.S.A.

Cobra Electronics Corporation warrants that its Cobra microTALK® radios and the component parts thereof, will be free of defects in workmanship and materials for a period of one year from the date of first consumer purchase. This warranty may be enforced by the first consumer purchaser, provided that the product is utilized within the U.S.A.

Cobra will, without charge, repair or replace, at its option, defective microTALK® radios, products or component parts upon delivery to the Cobra Factory Service department, accompanied by proof of the date of first consumer purchase, such as a duplicated copy of a sales receipt.

You must pay any initial shipping charges required to ship the product for warranty service, but the return charges will be at Cobra's expense, if the product is repaired or replaced under warranty. This warranty gives you specific legal rights, and you may also have other rights which may vary from state to state.

Exclusions: This limited warranty does not apply: 1) To any product damaged by accident; 2) In the event of misuse or abuse of the product or as a result of unauthorized alterations or repairs; 3) If the serial number has been altered, defaced, or removed; 4) If the owner of the product resides outside the U.S.A.

All implied warranties, including warranties of merchantability and fitness for a particular purpose are limited in duration to the length of this warranty. Cobra shall not be liable for any incidental, consequential or other damages; including, without limitation, damages resulting from loss of use or cost of installation.

Some states do not allow limitations on how long an implied warranty lasts and/or do not allow the exclusion or limitation of incidental or consequential damages, so the above limitations may not apply to you.

For Products Purchased Outside the U.S.A.

Please contact your local dealer for warranty information.

90-Day Warranty on Rechargeable Batteries

For products purchased in the U.S.A. and Canada.

Trademark Acknowledgement

Cobra®, microTALK®, Nothing Comes Close to a Cobra®, VibrAlert® and the snake design are registered trademarks of Cobra Electronics Corporation, USA. Cobra Electronics Corporation™ is a trademark of Cobra Electronics Corporation, USA.

22

Caring for Your microTALK® Radio

Your microTALK® radio will give you years of trouble-free service if cared for properly. Handle the radio gently. Keep the radio away from dust. Avoid exposure to extreme temperatures.

Installing Batteries

To install or replace batteries:

Remove Belt Clip



1. Remove belt clip by releasing belt clip latch and sliding clip up.
2. Remove the two top and bottom screws on the back of the radio to remove the battery compartment cover.

Insert Batteries



3. Insert the supplied three AA rechargeable batteries or non-rechargeable alkaline batteries. Position batteries according to polarity markings.
4. Replace battery compartment cover and belt clip.
 - Do not attempt to charge alkaline batteries.
 - Do not mix old and new batteries.
 - Do not mix alkaline, standard (carbon-zinc), or rechargeable (Ni-Cd, Ni-MH, etc.) batteries.
- Use only the NiMH batteries rated 1000 mAh supplied by Cobra with this product.

Radio Charger Jack



To charge batteries in radio:

1. Check to see that the batteries have been inserted properly.
2. Insert the cable into the charge jack located at the top of the radio.
3. Plug the cable into USB power source.

Use only the supplied rechargeable batteries and charger for recharging your Cobra microTALK radio.

Cobra recommends your radio is turned off while being charged.

Non-rechargeable alkaline batteries can also be used in your radio.

It normally takes about 15 hours to fully charge batteries.



This radio floats with included NiMH battery. It may not float with some AA batteries.

Nothing Comes Close to a Cobra®

1



For charging microTALK radio(s) in desktop charger:

1. Insert radio(s) into desktop charger as shown.
2. Insert the micro-USB cable into jack on back of charger.
3. Plug the cable into USB-compatible power port. For pluggable equipment, the socket-outlet shall be installed near the equipment and shall be easily accessible.

If charging light is not **on**, check position of radio. Radio should be upright. The charge indicator light will stay **on** as long as the radio is in the charging well, and the light will go off when the charging is complete.

Note: To charge a single radio, you can bypass the desktop charger and simply insert the micro-USB's connector directly into the charge jack located on the top of the radio.

The radio will display flashing battery icon while charging.

Cobra recommends your radio be turned **off** while being charged.

Non-rechargeable alkaline batteries can also be used in your radio.

Quick Start

1. Press and hold the **Mode/Power** button to turn **on** your radio.
2. Press the **Channel Up** or **Channel Down** button to select a channel.



Both radios must be tuned to the same channel/privacy code to communicate.

3. Press and hold the **Talk** button while speaking into the microphone.
4. When finished talking, release the **Talk** button and listen for a response.

Turning on Your microTALK® Radio

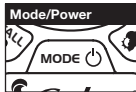

Press and hold the **Mode/Power** button until you hear a series of audible tones indicating the radio is **on**.

Your microTALK® radio is now in **Standby** mode, ready to receive transmissions. The radio is always in **Standby** mode except when the **Talk**, **Call** or **Mode/Power** buttons are pressed.

2

Battery Low

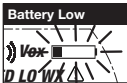

When battery power is low, the final bar in the **Battery Low** icon will blink and an audible tone will sound twice before the radio shuts off. Your batteries should be replaced or recharged, if using rechargeable batteries.



The radio will display flashing battery icon while charging.

Auto Battery Save

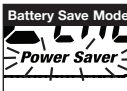

If there are no transmissions within 10 seconds, the radio will automatically switch to **Battery Save** mode and the **Power Saver** icon will flash in the display. This will not affect the radio's ability to receive incoming transmissions.

Communicating with Another Person



Two Inches (5 cm) from Mouth



1. Press and hold the **Talk** button.
2. With the microphone about two inches (5 cm) from your mouth, speak in a normal voice.
3. Release the **Talk** button when you are finished talking and listen for a response.

You cannot receive incoming calls while pressing the **Talk** button.



Both radios must be tuned to the same channel/privacy code to communicate.

To Select a Channel

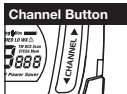

With the radio **on**, select any of the 22 channels by pressing the **Channel Up** or **Channel Down** button.



Both radios must be tuned to the same channel to communicate.

Channels 1 through 7 are shared with FRS/ GMRS. Channels 8 through 14 are FRS only. Channels 15 through 22 are GMRS only.



See **page 19** for FRS/GMRS frequency allocations and compatibility charts.

Nothing Comes Close to a Cobra® 3

Listening for a Response

Listening



Release the **Talk** button to receive incoming transmissions. Your microTALK® radio is always in **Standby** mode while the **Talk** or **Call** buttons are not pressed.

To Adjust Volume

Volume Button



Press the **Volume Up** or **Volume Down** button.

A double beep sound is used to indicate the minimum and maximum volume levels (1 through 8).

Volume Level



Call Button

Call Button



Press and release the **Call** button.

The other person will hear a two second call tone. This tone is used only to establish voice communications.



See page 13 on how to select between ten call tone settings.

LED Flashlight

LED Flashlight



Press and release the **LED flashlight** button below the **TALK** button to use the LED flashlight located at the bottom of the radio.

Auto Squelch/Maximum Range

Your microTALK® radio will automatically shut **off** weak transmissions and unwanted noise due to terrain, conditions or if you've reached your **Maximum Range** limit.

Lock Function

Lock Button



The **Lock** function locks the **Channel Up**, **Channel Down**, **Volume Up**, **Volume Down** and **Mode/Power** buttons to prevent accidental operation.

To turn the lock on or off:

– Press and hold the **Call/Lock** button for two seconds.

Lock Icon



A double beep sound is used to confirm your lock **on** or **off** request. When in **Lock** mode, the **Lock** icon will be displayed.

microTALK® Range

Your range will vary depending on terrain and conditions.

Maximum Range



In flat, open country your radio will operate at maximum range.

Buildings and foliage in the path of the signal can reduce the range of the radio.

Reduced Range



Dense foliage and hilly terrain will further reduce the range of the radio.

On FRS Channels 8 through 14, your radio automatically switches to low power, which will limit the range the radio can communicate.

Reduced Range



Scrolling Through the Mode Function

By scrolling through the **Mode** function, you will be able to select or turn **on** preferred features of your microTALK® radio. When scrolling through the **Mode** function, your radio features will be displayed in the same predetermined order:

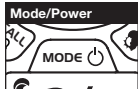

- Set CTCSS Privacy Codes
- Set DCS Privacy Codes
- Set Hi-Mid-Low Power
- Set Vox On/Off
- Set Vox Sensitivity
- Set Call Tones 1-10
- Set VibrAlert On/Off
- Set Roger Beep On/Off
- ▼ Set Key Tones On/Off

Privacy Codes

Your microTALK radio incorporates two advanced coded squelch systems that can help to reduce interference from other users on any given channel. CTCSS (Continuous Tone Coded Squelch System) provides 38 privacy codes and DCS (Digitally Coded Squelch) provides 83 privacy codes. This provides a total of 121 **Privacy Codes**. Either system can be used on all channels, but both systems cannot be used on the same channel at the same time.



To successfully communicate using a privacy code, both the sending and receiving radios must be tuned to the same channel and to the same privacy code system (CTCSS or DCS) and privacy code number. Each channel will remember the last privacy code system and number you select.



The privacy code 00 is not a privacy code, but allows all signals to be heard on a channel that is set to 00 on both the CTCSS and DCS systems.

Set CTCSS Privacy Codes

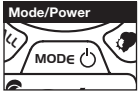

To select a CTCSS privacy code:

1. After selecting a channel, press the **Mode/Power** button until the **CTCSS** icon appears and the small numbers next to the channel number flash on the display.



If DCS is turned **on** at the channel selected, the display will flash the CTCSS icon and "OFF." To switch from DCS to CTCSS, press the **Channel Up** or **Channel Down** button while the display is flashing "OFF." The display will then show the small numbers flashing and you will then be able to proceed to step 2.

2. Press using the **Channel Up** or **Channel Down** button to select a privacy code. You can hold the **Up** or **Down** button for fast advance.
3. When your desired CTCSS privacy code is displayed, choose one of the following:
 - a. Press the **Mode/Power** button to enter the new setting and proceed to other functions.
 - b. Press **Talk** or **Call/Lock** button to enter the new setting and return to **Standby** mode.
 - c. Do not press any buttons for 15 seconds to enter the new setting and return to **Standby** mode.

Set DCS Privacy Codes

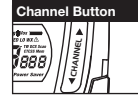
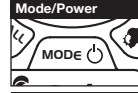

To select a DCS privacy code:

1. After selecting a channel, press the **Mode/Power** button until the **DCS** icon appears and the small numbers flash on the display (01 through 83).



If CTCSS is turned **on** at the channel selected, the display will flash the DCS icon and "OFF." To switch from CTCSS to DCS, press the **Channel Up** or **Channel Down** button while the display is flashing "OFF." The display will then show the small numbers flashing and you will then be able to proceed to step 2.

2. Press using the **Channel Up** or **Channel Down** button to select a DCS privacy code. You can hold the **Up** or **Down** button for fast advance.
3. When DCS privacy code is displayed, choose one of the following:
 - a. Press the **Mode/Power** button to enter the new setting and proceed to other functions.
 - b. Press **Talk** or **Call/Lock** button to enter the new setting and return to **Standby** mode.
 - c. Do not press any buttons for 15 seconds to enter the new setting and return to **Standby** mode.

Voice Activated Transmit (VOX)

In **VOX** mode, your microTALK® radio can be used “hands-free,” automatically transmitting when you speak. You can set the **VOX** sensitivity level to fit the volume of your voice and avoid transmissions triggered by background noise.

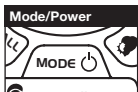

To turn VOX mode on or off:

1. Press the **Mode/Power** button until the **VOX** icon flashes on the display. The current **On** or **Off** setting is displayed.
2. Press the **Channel Up** or **Channel Down** button to turn **VOX On** or **Off**.
3. Choose one of the following:
 - a. Press the **Mode/Power** button to enter the new setting and proceed to other functions.
 - b. Press **Talk** or **Call/Lock** button to enter the new setting and return to **Standby** mode.
 - c. Do not press any buttons for 15 seconds to enter the new setting and return to **Standby** mode.



To set VOX sensitivity:

1. Press the **Mode/Power** button until the **VOX** icon flashes and the current sensitivity level is displayed.

The current VOX sensitivity level is displayed with letters “L” and a Number 1 through 5, with Number 5 being the most sensitive level and Number 1 being the least sensitive level.

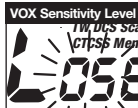
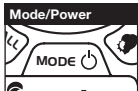

2. Press the **Channel Up** or **Channel Down** button to change the setting.
3. Choose one of the following:
 - a. Press the **Mode/Power** button to enter the new setting and proceed to other functions.
 - b. Press **Talk** or **Call/Lock** button to enter the new setting and return to **Standby** mode.
 - c. Do not press any buttons for 15 seconds to enter the new setting and return to **Standby** mode.



10 Memory Locations

Your microTALK radio has **10 Memory Locations** for storing your most frequently used channels and channel/privacy code combinations. These **Memory Locations** can be selected individually or can be scanned.

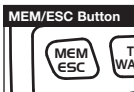

To program a memory location:

1. Press the **MEM/ESC** button. **Memory** icon and the **Memory Location** show on the display.
2. Press the **Channel Up** or **Channel Down** button to select the memory location (0 through 9).

If a location has been programmed before, its associated channel/privacy code will be shown on the display.

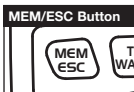

3. Press the **MEM/ESC** button to enter a new memory location or edit an already programmed memory location.
4. Press the **Channel Up** or **Channel Down** button to select the memory location.
5. Press the **MEM/ESC** button. The channel numbers will flash on the display.
6. Press the **Channel Up** or **Channel Down** button to select a channel (1 through 22).
7. Press the **MEM/ESC** button. The **CTCSS** icon and privacy code numbers will flash on the display.
8. Choose one of the following:
 - a. Press the **Channel Up** or **Channel Down** button to select a CTCSS privacy code (01 through 38) for the channel.
 - b. Press the **MEM/ESC** button to switch from CTCSS to DCS. The DCS icon and privacy code numbers will flash on the display. The **Channel Up** or **Channel Down** button can then be used to select a DCS privacy code (01 through 83) for the channel.





If “cF” flashes in place of the privacy code numbers, a privacy code is already set in the opposite (CTCSS or DCS) system. Press the **Channel Up** or **Channel Down** button to cancel the opposite code and select a privacy code from the active system for the selected channel.

9. Choose one of the following:
 - a. Press the **MEM/ESC** button to enter the channel/privacy code in the selected memory location. Radio then proceeds to next memory location, which will blink.
 - b. Press and hold the **MEM/ESC** button to save the current state of the Set Memory Function and return to **Standby mode**.

To recall a stored memory channel location:

1. Press the **MEM/ESC** button until the **Memory** icon and the memory location number flash on the display.
2. Press the **Channel Up** or **Channel Down** button to select a memory location (0 through 9).

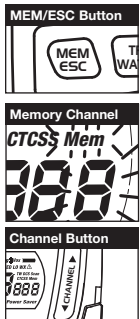

If a location has been programmed before, its associated channel/privacy code will be shown on the display.

3. Press and hold the **MEM/ESC** button to return to **Standby mode** on the selected memory location.



A memory location can be reprogrammed at any time it is displayed. Press the **MEM/ESC** button to begin.

Ten Call Tone Settings

You can choose between ten different **Call Tone Settings** to transmit a call alert.

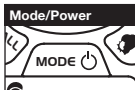

To change a call tone setting:

1. Press the **Mode/Power** button until the letter “C” and the current call tone number (01 through 10) is displayed. The current call tone will sound for three seconds.
2. Press the **Channel Up** or **Channel Down** button to hear the other call tone settings.
3. Choose one of the following:
 - a. Press the **Mode/Power** button to enter the new setting and proceed to other functions.
 - b. Press **Talk** or **Call/Lock** button to enter the new setting and return to **Standby mode**.
 - c. Do not press any buttons for 15 seconds to enter the new setting and return to **Standby mode**.

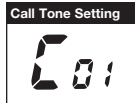

VibrAlert® and Call Alert

Your microTALK® radio can alert you to incoming signals by sounding an audible call tone, by vibrating silently or both.

To change call settings:

1. Press the **Mode** button until the **Call Setting** icon flashes on the display. The current setting (“01” vibrate + ring, “02” ring only) is displayed.
2. Press the **Channel Up** or **Channel Down** button to change the call setting.
3. Choose one of the following:
 - a. Press the **Mode** button to enter the new setting and proceed to other functions.
 - b. Press **Talk** or **Call/Lock** button to enter the new setting and return to **Standby mode**.
 - c. Do not press any buttons for 15 seconds to enter the new setting and return to **Standby mode**.



Roger Beep Confirmation Tone

Your listener will hear an audible tone when you release the **Talk** button. This alerts the other party that you are finished talking and it is OK for them to speak.

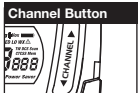
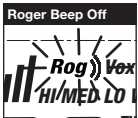
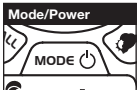

To turn roger beep on or off:

1. Press the **Mode/Power** button until the **Roger Beep** icon flashes. The current **on** or **off** setting is displayed.
2. Press the **Channel Up** or **Channel Down** button to select roger beep **on** or **off**.
3. Choose one of the following:
 - a. Press the **Mode/Power** button to enter the new setting and proceed to other functions.
 - b. Press **Talk** or **Call/Lock** button to enter the new setting and return to **Standby** mode.
 - c. Do not press any buttons for 15 seconds to enter the new setting and return to **Standby** mode.

Key Tone On/Off

When **Key Tone** is **On**, an audible tone will sound each time a button is pressed.

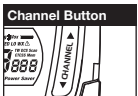
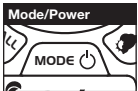

To turn key tone on or off:

1. Current key tone status **On/Off** will flash.
2. Press the **Channel Up** or **Channel Down** button to select key tone **on** or **off**.
3. Choose one of the following:
 - a. Press the **Mode/Power** button to enter the new setting and proceed to other functions.
 - b. Press **Talk** or **Call/Lock** button to enter the new setting and return to **Standby** mode.
 - c. Do not press any buttons for 15 seconds to enter the new setting and return to **Standby** mode.

Channel Scan

Your microTALK® radio can automatically scan channels.

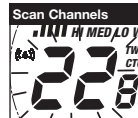
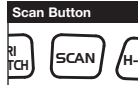

To scan channels:

1. Press and release the **Scan** button until the **Scan** icon and the channel numbers appear on the display.
2. Press and hold the **Scan** button to begin scanning channels.

 The radio ignores specific privacy codes while scanning channels.

The **Scan** icon will continue to be displayed when scan is **on**. Your radio will continue to scan all channels and stop if an incoming transmission is detected. Your radio will remain on that channel for 10 seconds.

During scanning (while receiving an incoming transmission), you can choose from the following:

- a. Press and hold the **Talk** button to communicate on that channel. Your radio will remain on that channel and return to **Standby** mode.
- b. Press the **Channel Up** or **Channel Down** button to resume scanning channels.
- c. Press and hold the **Scan** button to return to **Standby**.

Privacy Code Scan

Your microTALK radio can automatically scan the **Privacy Codes** (either CTCSS 01 through 38 or DCS 01 through 83) within one channel. Only one set of privacy codes (CTCSS or DCS) can be scanned at a time.



To scan privacy codes:

1. While in **Standby** mode, press and release the **Scan** button twice (CTCSS) or three times (DCS) until the CTCSS or DCS icon and numbers are flashing.
2. Press and hold the **Scan** button to begin scanning privacy codes within the selected channel.



The **Scan** icon will continue to be displayed when privacy code scan is **on**. Your radio will continue to scan privacy codes and stop as an incoming transmission is detected. Your radio will remain on that channel/privacy code for 10 seconds.

During scanning (while receiving an incoming transmission), you can choose from the following:

- a. Press the **Mode/Power** button to enter the new setting and proceed to other functions.
- b. Press **Talk** or **Call/Lock** button to enter the new setting and return to **Standby** mode.
- c. Do not press any buttons for 15 seconds to enter the new setting and return to **Standby** mode.

NOAA* All Hazards Radio Channels

You can use your microTALK radio to listen to **NOAA All Hazards Radio** channels transmitting in your area.



To listen to All Hazards Radio channels:

1. Press the **Weather** button until the **All Hazards Radio** icon and the currently selected All Hazards Radio channel are displayed.
2. Use the **Channel Up** or **Channel Down** button to change **All Hazards Radio** channels.
3. The **All Hazards Radio** icon will continue to be displayed when **All Hazards Radio** is **on**.
4. To exit **All Hazards Radio**, press and hold the **Weather** button until **On** or **Off** is displayed.



*National Oceanographic and Atmospheric Administration

Weather (WX) Alert Mode

Turning **On** the **Weather Alert** function will allow your radio to automatically receive NOAA weather signals and warnings from designated weather broadcast stations. If the radio is turned **ON**, it will alert to Weather and other emergency alerts broadcast by NOAA.



This feature is set to **OFF** by default.



Make sure the strongest Weather channel is selected for your area using the channel selection in the previous menu.



To turn Weather Alert On or Off:

1. Press the **Weather/Lock** button until the Weather Alert icon flashes on the display. The current **On** or **Off** setting is displayed.
2. Press the **Channel Up** and **Channel Down** button to turn Weather Alert **On** or **Off**.
3. Press and hold the **Weather/Lock** button again to save the new setting and exit the **Weather Alert Mode** and return to **Standby** mode.





Tri-Watch Set-up

To Program or Edit the Tri-Watch Channels:



1. Press and hold the **TRI-WATCH** button from **GMRS Standby** mode for two (2) seconds to activate **Tri-Watch Setup** mode. The **MEM** icon on the display will turn **ON**.



2. Press **Channel Up** or **Channel Down** button to select the desired **Tri-Watch** channel.



3. Press and release **TRI-WATCH** button to confirm entry.
4. Repeat steps 2 and 3 to program the remaining additional **Tri-Watch** memory channel.
5. After programming both **Tri-Watch** memory channels the radio will immediately engage **Tri-Watch** mode.

Using Tri-Watch:



1. From **GMRS Standby** mode, press the **TRI-WATCH** button. The **TW** will appear in the display along with the three channels stored in the **Tri-Watch** memory.
2. The radio will scan through the three (3) **Tri-Watch** memory channels.



3. A signal on any one (1) of the three (3) channels will stop the scan for 10 seconds to allow you to listen to the traffic on that location.



- After the **Tri-Watch** scan stops to monitor a channel, as long as you do not press any buttons within 10 seconds, your radio will automatically resume scanning the **Tri-Watch** channels

4. Press **Channel Up** or **Channel Down** button to resume scanning the **Tri-Watch** channels or to change the scan direction.
5. To **EXIT** the **Tri-Watch** scan, press the **TRI-WATCH** button again, and the radio will return to **GMRS Standby** mode.



General Specifications

FRS/GMRS Frequency Allocation and Compatibility

Important: Please note that Cobra GMRS models with 15 Channels may designate different channel numbers for the same frequency. For example, a Cobra 15 Channel GMRS model would need to be tuned to Channel 11 in order to communicate with a 22 Channel GMRS tuned to Channel 15. Please refer to the chart below for channel/ frequency number compatibility.

A = Channel No. for 22 Channel FRS/GMRS Models

B = Channel No. for 15 Channel GMRS Models

C = Type of Radio Service

D = Frequency in MHz

E = Power Output

A	B	C	D	E
1	1	FRS/GMRS	462.5625	High
2	2	FRS/GMRS	462.5875	High
3	3	FRS/GMRS	462.6125	High
4	4	FRS/GMRS	462.6375	High
5	5	FRS/GMRS	462.6625	High
6	6	FRS/GMRS	462.6875	High
7	7	FRS/GMRS	462.7125	High
8		FRS	467.5625	Low
9		FRS	467.5875	Low
10		FRS	467.6125	Low
11		FRS	467.6375	Low
12		FRS	467.6625	Low
13		FRS	467.6875	Low
14		FRS	467.7125	Low
15	11	GMRS	462.5500	High
16	8	GMRS	462.5750	High
17	12	GMRS	462.6000	High
18	9	GMRS	462.6250	High
19	13	GMRS	462.6500	High
20	10	GMRS	462.6750	High
21	14	GMRS	462.7000	High
22	15	GMRS	462.7250	High



IMPORTANT NOTICE: FCC LICENSE REQUIRED

This two-way radio operates on GMRS (General Mobile Radio Service) frequencies which require an FCC (Federal Communications Commission) license. A user must be licensed prior to operating on Channels 1 through 7 on high power or 15 through 22, which comprise the GMRS channels of this radio. Serious penalties could result for unlicensed use of GMRS channels, in violation of FCC rules. Operation of this radio is subject to additional rules specified in 47 C.F.R. Part 95.

Licensed users will be issued a call sign by the FCC, which should be used for station identification when operating this radio. GMRS users should also cooperate by engaging in permissible transmissions only, avoiding channel interference with other GMRS users, and being prudent with the length of their transmission time.

For licensing information and application forms, please call the FCC Hotline at 800-418-FORM. Request form #159 and form #605. Questions regarding the license application should be directed to the FCC at 888-CALL-FCC. Additional information is available on the FCC's website at www.fcc.gov.

Channel 1 through 7 on low power and channels 8 through 14 comprise the FRS (Family Radio Service). No license is required to operate on the FRS.

WARNING: Changes or modifications to this unit not expressly approved by the party responsible for compliance could void the user's authority to operate the equipment."

NOTE: This equipment has been tested and found to comply with the limits for a Class B digital device, pursuant to Part 15 of the FCC Rules. These limits are designed to provide reasonable protection against harmful interference in a residential installation. This equipment generates, uses and can radiate radio frequency energy and, if not installed and used in accordance with the instructions, may cause harmful interference to radio communications.

However, there is no guarantee that interference will not occur in a particular installation. If this equipment does cause harmful interference to radio or television reception, which can be determined by turning the equipment off and on, the user is encouraged to try to correct the interference by one or more of the following measures:

- Reorient or relocate the receiving antenna.
- Increase the separation between the equipment and receiver.
- Connect the equipment into an outlet on a circuit different from that to which the receiver is connected.
- Consult the dealer or an experienced radio/TV technician for help.

Safety Information for microTALK Radios

Your wireless handheld portable transceiver contains a low power transmitter. When the talk button is pushed, it sends out radio frequency (RF) signals. The device is authorized to operate at a duty factor not to exceed 50%. In August 1996, the Federal Communications Commissions (FCC) adopted RF exposure guidelines with safety levels for handheld wireless devices.

Important

FCC RF Exposure Requirements: For body-worn operation, this radio has been tested and meets the FCC RF exposure guidelines when used with Cobra accessories supplied or designated for this product. Use of other accessories may not ensure compliance with FCC RF exposure guidelines. Use only the supplied antenna. Unauthorized antennas, modifications or attachments could damage the transmitter and may violate FCC regulations.

Normal Position

Hold the transmitter approximately 2 inches from your face and speak in a normal voice, with the antenna pointed up and away.

MODEL CX1095:

This device complies with part 15 of the FCC Rules. Operation is subject to the following two conditions: 1) This device may not cause harmful interference, and 2) this device must accept any interference received, including interference that may cause undesired operation.

FCC Warnings: Replacement or substitution of transistors, regular diodes or other parts of a unique nature, with parts other than those recommended by Cobra may cause a violation of the technical regulations of part 95 of the FCC rules, or violation of type acceptance requirements of part 2 of the rules.

Product Service Questions

For any questions about operating or installing this new Cobra product, or if parts are missing...**PLEASE CALL COBRA FIRST...**do not return this product to the store. See customer assistance on page A1.

For Products Purchased in the U.S.A.

If your product should require factory service, please call Cobra first before sending your radio. This will ensure the fastest turn-around time on your repair. You may be asked to send your radio to the Cobra factory. It will be necessary to furnish the following to have the product serviced and returned.

- 1) For warranty repair include a copy of the original sales receipt. If you send the original receipt, it cannot be returned.
- 2) Send the entire product.
- 3) Enclose a detailed description of the problem along with the name and address of where the product is to be returned.
- 4) Pack radio securely to prevent damage in transit. If possible, use the original packing material.
- 5) Ship prepaid and insured by way of a traceable carrier such as United Parcel Service (UPS) or Priority Mail to avoid loss in transit to Cobra Factory Service:
Cobra Electronics Corporation
6500 West Cortland Street
Chicago, Illinois 60707 U.S.A.
- 6) If the radio is under warranty, it will be repaired or exchanged depending on the model.

Please allow approximately three to four weeks before contacting Cobra for status. If the radio is out of warranty, a letter will automatically be sent informing you of the repair charge or replacement charge. If you have any questions, please call 773-889-3087 for assistance.

For Products Purchased Outside the U.S.A.

Please contact your local dealer for product service information.