

# Cobra® HH 37 ST

# Cobra®

Cobra Electronics Corporation  
6500 West Cortland Street  
Chicago, IL 60707

## If You Think You Need Service

For technical assistance, please call our Automated Help Desk which can assist you by answering the most frequently asked questions about Cobra products.

(773) 889-3087

24 hours a day, 7 days a week.

A Consumer Service Representative can be reached through this same number 8:00 am - 8:00 pm, Monday through Friday, CST.

Technical assistance is also available on-line in the Frequently Asked Questions (FAQ) section at [www.cobraelec.com](http://www.cobraelec.com) or by e-mail to [productinfo@cobraelec.com](mailto:productinfo@cobraelec.com)

## If you think you need service call 1.773.889.3087

*"If your product should require factory service please call Cobra first before sending your unit in. This will ensure the fastest turn-around time on your repair."*

You may be asked to send your unit to the Cobra factory. It will be necessary to furnish the following in order to have the product serviced and returned.

1. For Warranty Repair include some form of proof-of-purchase, such as a mechanical reproduction or carbon or a sales receipt. If you send the original receipt it cannot be returned.
2. Send the entire product.
3. Enclose a description of what is happening with the unit. Include a typed or clearly print name and address of where the unit is to be returned.
4. Pack unit securely to prevent damage in transit. If possible, use the original packing material.
5. Ship prepaid and insured by way of a traceable carrier such as United Parcel Service (UPS) or First Class Mail: to avoid loss in transit to: Cobra Factory Service, Cobra Electronics Corporation, 6500 W. Cortland St., Chicago, IL 60707.
6. If the unit is in warranty, upon receipt of your unit it will either be repaired or exchanged depending on the model. Please allow approximately 3 to 4 weeks before contacting us for status. If the unit is out of warranty a letter will automatically be sent informing you of the repair charge or replacement charge. If you have any questions, please call 1.773.889.3087 for assistance.

Cobra Electronics Corp © 1998  
Printed in Thailand  
Part No. 480-270-P-001

Operating Instructions  
for your Cobra HH 37 ST

## Citizens Band 2-Way Handheld CB Radio

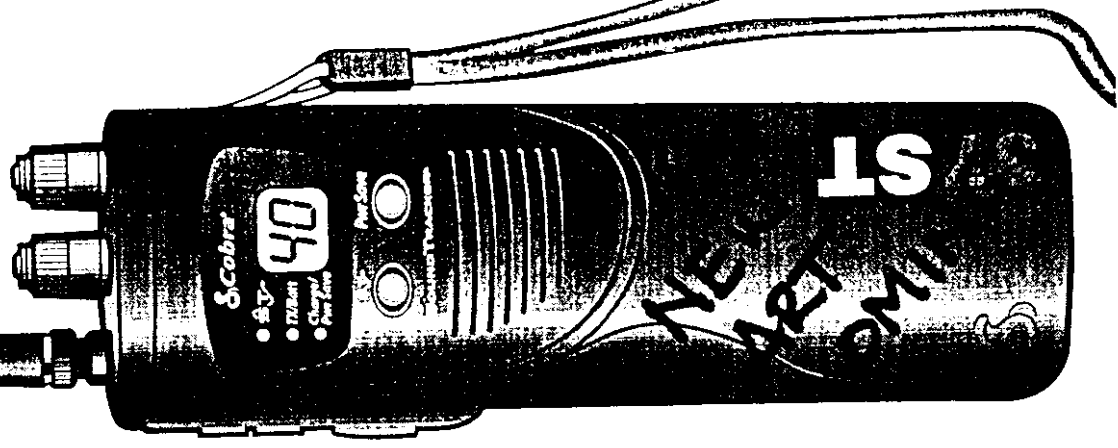

IN 4/14/98  
X

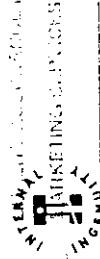

"Ingenious Products for Easier Communication."

# The CB Story

The Citizens Band lies between the shortwave broadcast and 10-meter Amateur radio bands and was established by law in 1949. The Class D two-way communications service was opened in 1959.

## FCC Regulations

FCC regulations permit only "transmissions" (one party to another) rather than "broadcasts" (to a wide audience). Advertising is not allowed on CB Channels because it is considered "broadcasting."

## FCC Warnings

Replacement or substitution of transistors, regular diodes or other parts of a unique nature, with parts other than those recommended by Cobra, may cause a violation of the technical regulations of Part 95 of the FCC Rules, or violation of Type Acceptance requirements of Part 2 of the Rules.

Citizens Band (CB) Radio operators are not required to obtain an FCC license to operate their CB equipment or provide station identification.

Nevertheless, an operator of a CB radio station is still required to comply with the communications act and with the rules of CB Radio Operation.

## What's Included with Your HH 37 ST

1. High Efficiency Antenna
2. Removable Belt Clip
3. Wrist Strap
4. 13.8 Volt Cigarette Lighter Plug

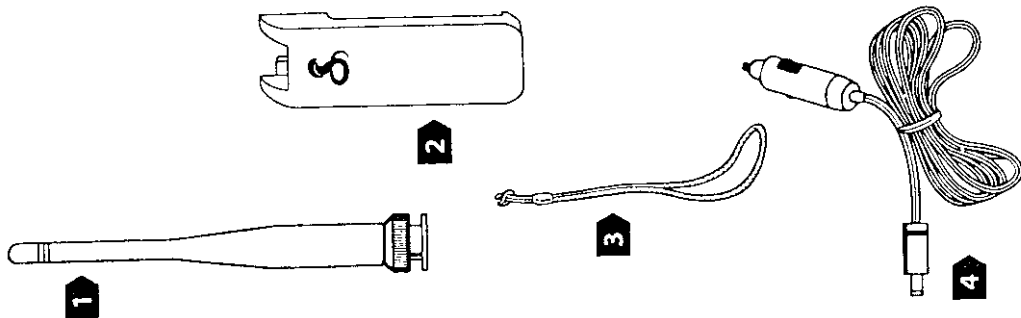

1. BNC Antenna Connector
2. Squelch Control
3. On/Off Volume Control
4. Removable Belt Clip
5. External Speaker Jack
6. External Microphone Jack
7. 12 Volt DC Power Jack
8. NiCad Battery Charge Jack
9. Channel Up/Down Key
10. PTT (Push To Talk) Key
11. Battery Chamber
12. LED Channel Display
13. SoundTracker™ Key
14. Power Save Key
15. Microphone
16. SoundTracker™ LED
17. TX (transmit)/ Batt (battery low) LED
18. Battery Charge/ Power Save LED

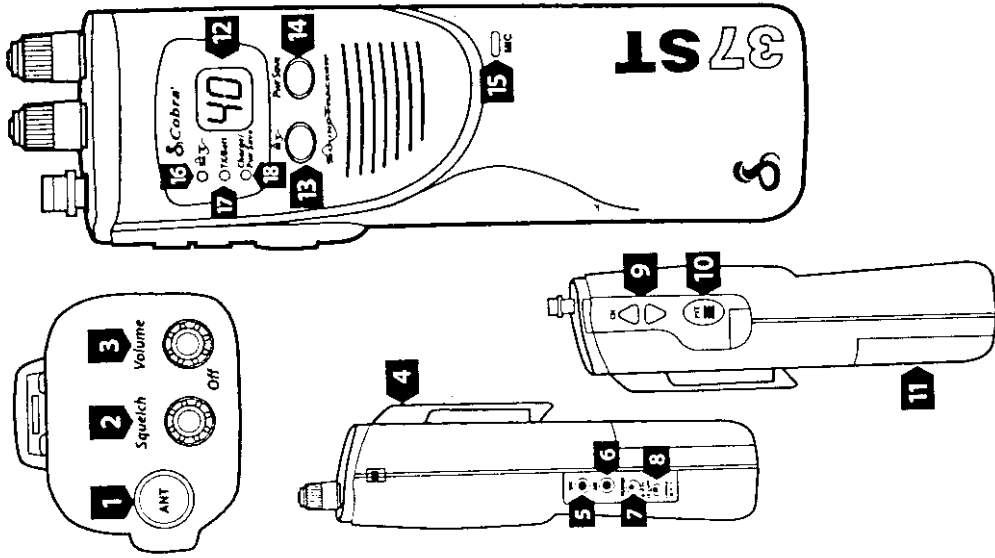

Thank you for purchasing the Cobra HH 37 ST handheld CB. Properly used, this Cobra product will give you many years of reliable service.

### SoundTracker™

"Cuts noise coming in...strengthens signals going out."

This Patent pending technology dramatically improves transmission and reception of CB signals.

The revolutionary SoundTracker™ System reconfigures the transmission signal which allows it to be transferred more efficiently through cluttered airwaves.

At the same time, it significantly reduces the amount of static on all incoming CB signals.

The end result is a cleaner, clearer sounding reception of signals and a more powerful transmission which dramatically improves CB communications.

### Customer Support

Should you encounter any problems with the product or not understand its many features, please refer to this owner's manual. If, after referring to the manual, you still need help, call Cobra Customer Service at 773.889.3087.

**Cobra Customer Service**  
Live operators are available  
M-F 8:00 am - 8:00 pm CST at  
773.889.3087

Automated Technical Assistance  
available 24 hours a day, seven  
days a week. E-mail questions to  
productinfo@cobraelec.com

Cobra on the World Wide Web.  
Frequently Asked Questions (FAQ)  
can be found on-line at:  
www.cobraelec.com

# How to Use Your Cobra HH 37 ST

<b>Contents</b>	
<b>Features</b> .....	1
<b>The CB Story</b> .....	A1
FCC Regulations	
FCC Warnings	
Included Accessories	
<b>Controls &amp; Indicators</b> .....	A2
<b>Our Thanks to You</b> .....	A3
SoundTracker™	
Customer Support	
<b>Operating Your HH 37 ST</b>	
Antenna.....	2
Belt Clip.....	3
Battery Installation.....	3
Turning on Your CB.....	4
Setting Squelch.....	4
Selecting a Channel.....	6
LED Display.....	7
Transmit/Receive.....	8
SoundTracker™ System.....	10
In Vehicle Use.....	14
Power Save.....	14
External Speaker/Microphone.....	15
<b>How Your CB Can Serve You</b> .....	16
A Few Rules You Should Know.....	16
Channel 9 Emergency Messages.....	16
CB 10 Codes.....	18
Frequency Ranges.....	20
HH 37 ST Specifications.....	21
Warranty Information.....	22
<b>Optional Accessories</b> .....	23
Order Form.....	24
<b>If You Think You Need Service</b> .....	Back Cover

## Features of This Product

- SoundTracker™ System
- 40 CB Channels
- Full 4 Watt RF Power
- High/Low Power Save Switch
- LED Channel Display
- High Efficiency Flexible Antenna
- External Speaker/Microphone Jack
- NiCad Battery Charge Jack
- BNC Antenna Connector

Attach Antenna

- 1 Insert.

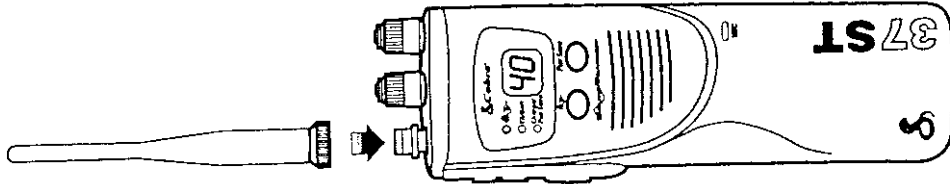

- 2 Turn clockwise.

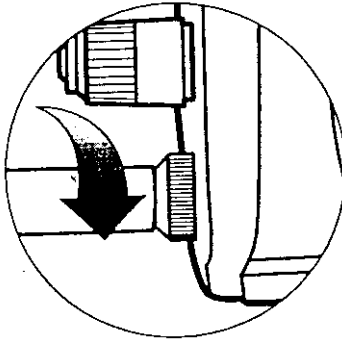

Attach Belt Clip

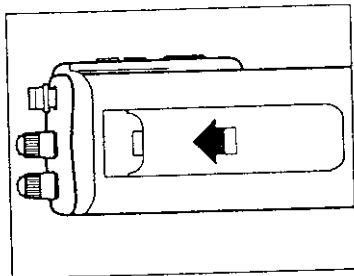

- 1 Slide belt clip up on rails of base. Push clip up until tab locks.

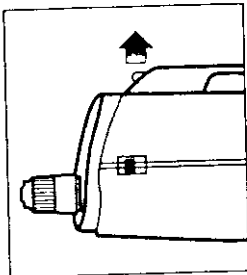

- 2 To remove belt clip, lift tab out and slide belt clip down and off base.

Note

Clip slides up to attach and slides down to remove.

Install Batteries

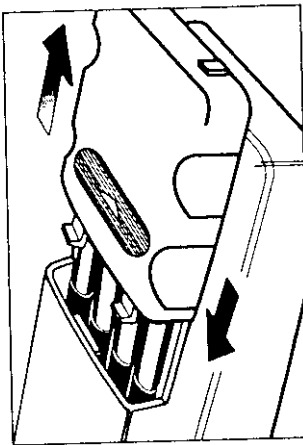

- 1 Remove battery chamber cover.
- 2 Install batteries by polarity markings.
- 3 Replace cover.

Battery Installation

Note

Ignoring polarity markings can cause damage to both the unit and the batteries.

The HH 37 ST requires 9 "AA" alkaline or NiCad batteries (not included with the unit).

When batteries are low or need charging the TX/Bat LED will remain on. Replace alkaline batteries and/or recharge NiCad batteries.

# Operation

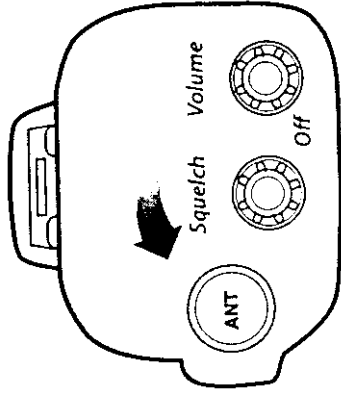
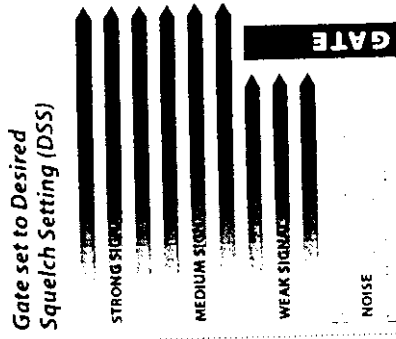
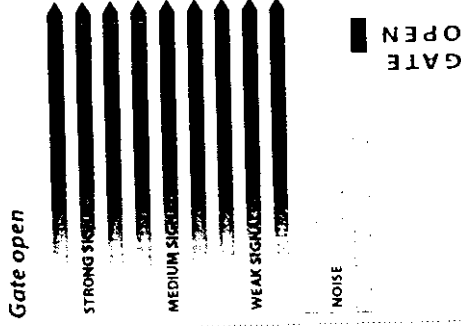

3 Fully counter-clockwise opens the "gate" and all signals enter.

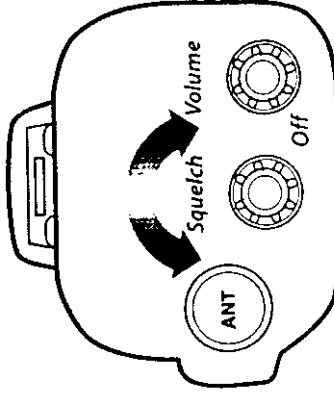

4 To achieve the Desired Squelch Setting (DSS), turn the Squelch control counter-clockwise until you hear noise. Now turn the control clockwise just until the noise stops. This is the DSS setting and only strong signals will enter.

**Turning On**  
Rotate ON - OFF Volume Control clockwise.

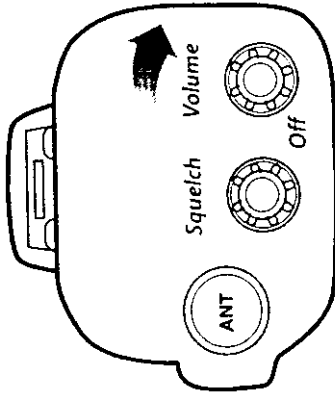

## Setting Squelch

Squelch is the "control gate" for incoming signals.

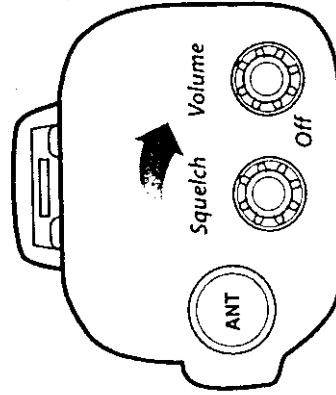

- 1 Turn volume all the way up.
- 2 Fully clockwise closes the "gate," allowing no incoming signals.

# Operation

## Turning On

## Setting Squelch

### Gate closed

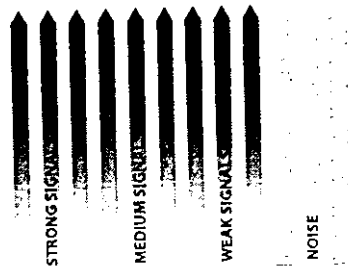

Select Channel

**Note**  
For quick advance, push and hold arrow key(s).

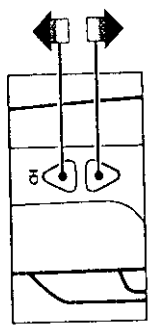

**Note**  
When switching from one channel to another, squelch will need to be reset. See Setting Squelch on page 4.

Select Channel

- 1 Turn power ON.
- 2 For higher channel, push UP arrow key.
- 3 For lower channel, push DOWN arrow key.

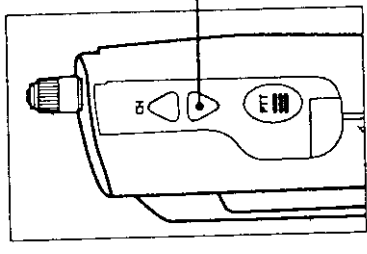
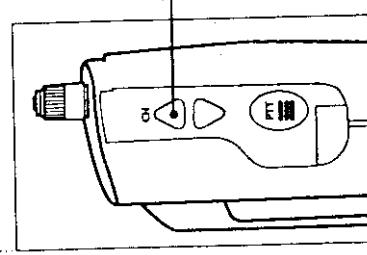

LED Display

All needed information is displayed.

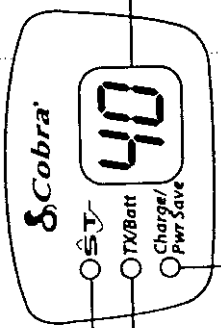
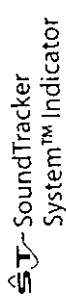

○ TX/Batt Indicator  
TX = Transmit  
Batt = Low Battery

○ Charge/Pwr Save Indicator  
Charge = NiCad batteries are charging  
Power Save Indicator = Unit is in power save mode

**Note**  
TX/Batt LED will illuminate red when:

1. The PTT button is pushed and held (transmitting).
  2. Batteries are low or need recharging.
- When Power Save button is pushed, the Charge/Pwr Save LED will illuminate red.

When charging NiCad batteries (with charger plugged in) the Charge/Pwr Save LED will also illuminate red.

Transmit/Receive

Transmit/Receive

Note

While PTT button is depressed you cannot receive transmissions.

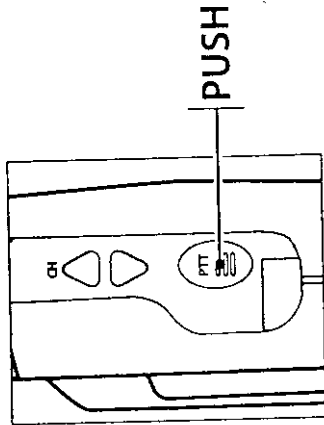

1 To transmit, push PTT button.

2 Hold mic from 2 inches from mouth. Speak in a normal voice.

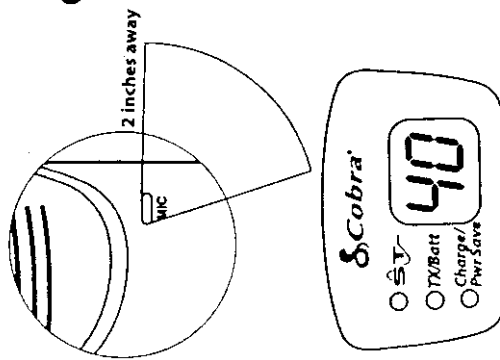

5 TX/Batt will illuminate red and Channel will be displayed.

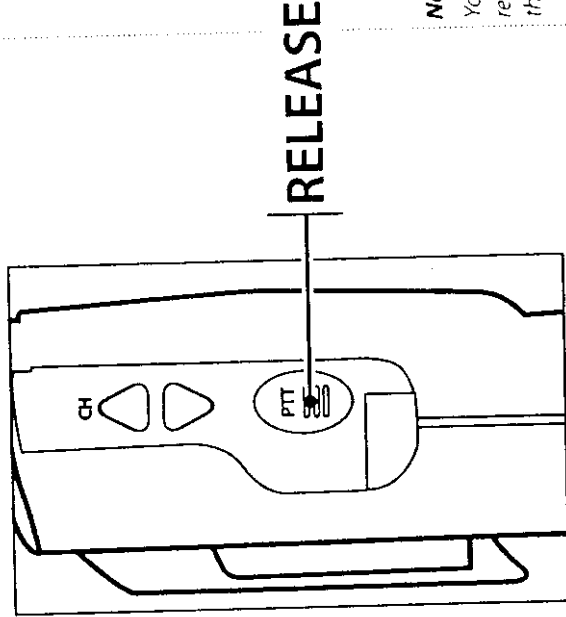

4 Release PTT button to receive incoming transmissions.

Note

Your HH 37 ST is always ready to receive incoming signals when the PTT button is released.





**Note**

SoundTracker™ gives you clearer, cleaner reception to improve CB communications while on the air.

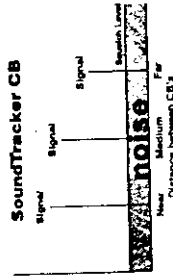
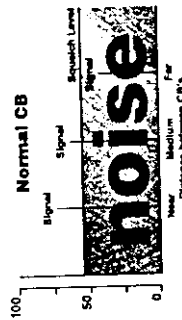

**The SoundTracker™ System**

While previous systems only "blanket out" or limit noise in higher sound frequencies, the revolutionary new SoundTracker™ System actually reduces noise while leaving the signal intact in the reception mode. In the transmission mode, it actually strengthens the signal, providing you with a significant reduction in noise on reception and transmission.

Sound clarity is measured by the ratio of the signal level to the noise level. The higher the signal-to-noise ratio, the better the sound.

**How SoundTracker™ Works**

*On Reception - "Cuts noise coming in"*

With a normal CB, distant signals fall below the squelch level and are unintelligible. With a SoundTracker™ CB, the noise level is cut up to 90%, which increases the signal-to-noise ratio and dramatically improves signal clarity. This also allows you to significantly reduce the squelch level, which greatly expands your listening range.

*On Transmission - "Strengthens signals going out"*

A SoundTracker™ CB strengthens the transmit signal by more effectively using the available RF power output of the CB. The result is improved transmission signal clarity and an expanded transmission range.

**Activating SoundTracker™**

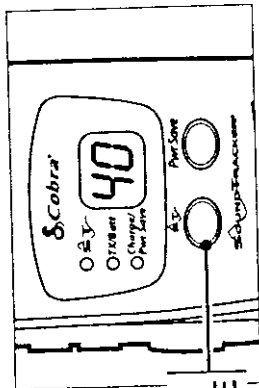

**PUSH & RELEASE**

➊ Push and release the ST key.

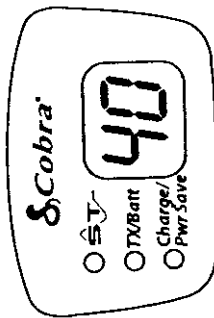

➋ The SoundTracker™ LED will illuminate red.

**Activating SoundTracker™**

**Note**

This engages the SoundTracker™ system and reduces the noise level.

### Testing SoundTracker™

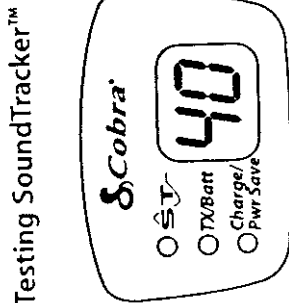

1 Select any unused channel on your CB.

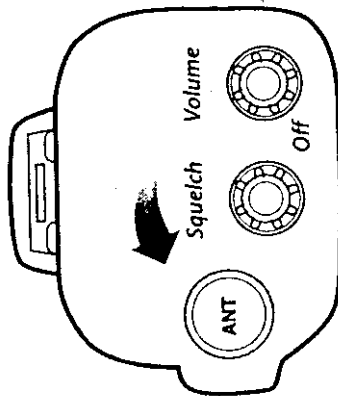

2 Fully counter-clockwise opens the "gate" and all signals enter. Turn the knob until it stops.

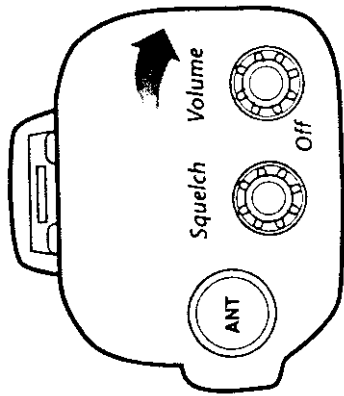

3 Turn the volume up louder than your normal listening level.

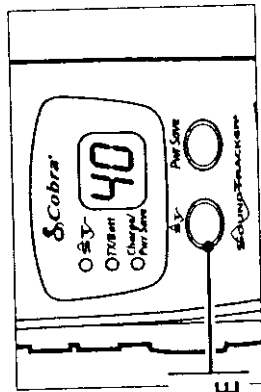

**PUSH & RELEASE**

4 Push and release the ST button.

The SOUNDTracker™ LED will illuminate red.  
\*Notice the significant reduction in noise.

To disengage SoundTracker™ push and release ST button again.

### Note

Different terrains and environments will effect the SoundTracker™ System's performance.

External Speaker/  
Microphone

External Speaker/Microphone

Your HH 37 ST can be fitted with an external speaker/microphone, freeing your hands for other tasks (like driving!).

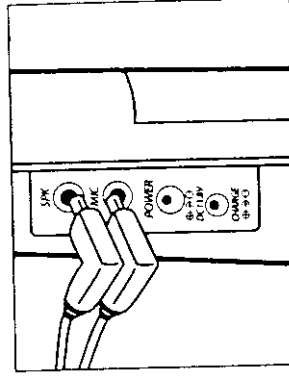

1 Locate SPK/MIC markings on side of unit. Insert cord jacks in appropriate receptacles.

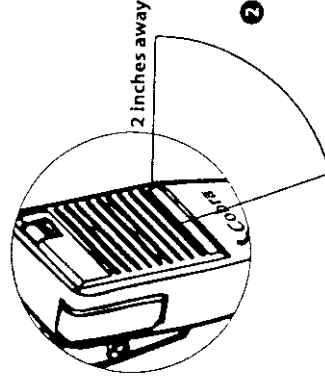

2 Hold mic about 2 inches from mouth. Speak in a normal voice.

Note

External speaker/microphone is not included with this unit. See accessories on page 23 for available options.

In Vehicle Use

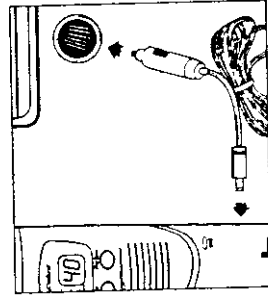

The HH 37 ST can be connected to your cigarette lighter with the provided adapter. This power connection does not charge the batteries.

Power Save

Reduces the power to 1 watt. This does not decrease the ability to receive but does reduce the transmitting range.

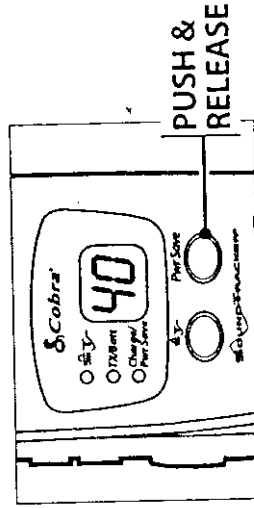

1 Push and release PWR Save button.

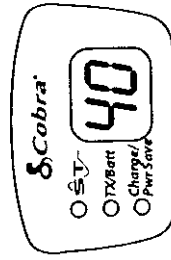

2 Power Save LED will illuminate.

Note

Due to the characteristics of CB transmissions, it is necessary to use an external car roof antenna and a BNC adapter to receive optimal performance while in your vehicle. See Accessories section on page 23.

Note

DC/Power Cord is provided.

The FCC gives these examples of permitted and prohibited messages for channel 9. These are only guidelines and not all-inclusive:

**Permitted**

Permitted	Example Message
Yes	"Tornado sighted six miles north of town."
No	"Post number 10. No tornado sighted."
Yes	"Out of gas on I-95 at mile marker 211."
No	"Out of gas in my driveway."
Yes	"Four car accident on I-94 at Exit 11. Send police and ambulance."
No	"Traffic moving smoothly on I-94."
Yes	"Weather Bureau has issued thunderstorm warning. Bring sailboat into port."
No	"Attention motorists. Weather Bureau advises snow tomorrow will accumulate 4 to 6 inches."
Yes	"Fire in building at 539 Main, Evanston."
No	"Halloween patrol number 3. All quiet."

- Warn of traffic problems
- Provide weather and road data
- Provide help in event of an emergency
- Provide direct contact with home or office
- Assist police by reporting erratic drivers
- Get "local information" to find destination
- Communicate with family and friends
- Suggest spots to eat and sleep
- Keep you alert while traveling

**A Few Rules You Should Know**

- Conversations cannot last more than 5 minutes with another station. A one minute break is required to let others use the channel.
- You cannot blast others off the air by use of illegally amplified transmitters or illegally high antennas.
- You cannot use CB to promote illegal activities.
- Profanity is not allowed.
- You may not transmit music with a CB.
- Selling of merchandise and/or services is prohibited.

**Channel 9 Emergency Messages**

**Note**

If no response on channel 9, try channels 19 or 14.

**1. Set to channel 9 for emergencies**

Be sure antenna is properly connected.

**2. CB Distress Data**

When transmitting an emergency, you should request a "REACT BASE" and provide the CB distress data (called CLIP):

- C** all Sign *Identify yourself.*
- L** ocation *Be exact.*
- I** njuries *Number, Type, Trapped?*
- P** roblem *Give details and help needed.*

Transmit **CLIP** repeatedly so any monitor can assist.

CB 10-Codes

CB 10-Codes

Citizen Bands have adopted the "10-CODES" for standard questions and answers. These codes provide quick and easy communication, especially in noisy areas. Following are some of the more common codes and meanings:

Code	Meaning
10-1	Receiving poorly
10-2	Receiving well
10-3	Stop transmitting
10-4	OK, message received
10-5	Relay message
10-6	Busy, stand by
10-7	Out of service, leaving
10-8	In service, subject to call
10-9	Repeat message
10-10	Transmission completed standing by
10-11	Talking too rapidly
10-12	Visitors present
10-13	Advise weather/roads
10-16	Make pick up at
10-17	Urgent business
10-18	Anything for us?
10-19	Return to base
10-20	My location is
10-21	Call by phone
10-22	Report in person to
10-23	Stand by
10-24	Completed last assignment
10-25	Can you contact
10-26	Disregard last info
10-27	Moving to channel
10-28	Identify your station

Code	Meaning
10-29	Time is up for contact
10-30	Does not conform to FCC rules
10-33	Emergency traffic
10-34	Trouble at this station
10-35	Confidential information
10-36	Correct time is
10-37	Wrecker needed at
10-38	Ambulance needed
10-39	Message delivered
10-41	Turn to channel
10-42	Traffic accident at
10-43	Traffic tie up at
10-44	Have a message for
10-45	All units within range please report
10-50	Break channel
10-60	What is next message number?
10-62	Unable to copy. Use phone
10-63	Net directed to
10-64	Net clear
10-65	Awaiting your next message/assignment
10-67	All units comply
10-70	Fire at
10-71	Proceed, transmission in sequence
10-77	Negative contact
10-81	Reserve hotel room for
10-82	Reserve room for
10-85	My address is
10-91	Talk closer to mic
10-93	Check my frequency on this channel
10-94	Give me a long count
10-99	Mission completed, all units secure
10-200	Police needed at



# Limited Two Year Warranty



**Cobra Electronics Corporation**

6500 West Cortland Street  
Chicago, Illinois 60707

COBRA ELECTRONICS CORPORATION warrants that its COBRA CB Radios, and the component parts thereof, will be free of defects in workmanship and materials for period of two (2) years from the date of first consumer purchase. This warranty may be enforced by the first consumer purchaser, provided that the product is utilized within the U.S.A.

COBRA will, without charge, repair or replace, at its option, defective CB radios, products or component parts upon delivery to the COBRA factory Service Department; accompanied by proof of the date of first consumer purchase, such as a duplicated copy of a sales receipt.

You must pay any initial shipping charges required to ship the product for warranty service, but the return charges will be at Cobra's expense, if the product is repaired or replaced under warranty.

**Exclusions:** This limited warranty does not apply; 1) to any product damaged by accident; 2) in the event of misuse or abuse of the product or as a result of unauthorized alterations or repairs; 3) if the serial number has been altered, defaced or removed; 4) if the owner of the product resides outside the U.S.A.

All implied warranties, including warranties of merchantability and fitness for a particular purpose are limited in duration to the length of this warranty. COBRA shall not be liable for any incidental, consequential or other damages; including, without limitation, damages resulting from loss of use or cost of installation.

Some states do not allow limitations on how long an implied warranty lasts and/or do not allow the exclusion or limitation of incidental or consequential damages, so the above limitations may not apply to you.

# Optional Accessories

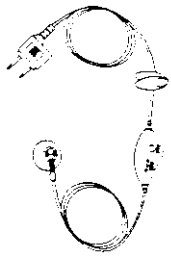

**Ear Bud Mic with PTT**

Integrated speaker/mic adapter that fits in your ear. Includes shirt clip.  
MA-1BM \$29.95



**Vox Mic**

VOX (Voice adapter)alk MA-VOX

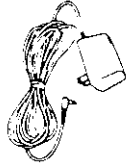

**120 V A/C Wall Charger with Plug**

Charges the 8 Cell Ni-Cad battery cartridge (see CA-45B).  
CA-25 \$10.00

*Don't should I delete this?*



**SO239 Antenna Adapter**

Connection of the 45 WX-51 island antennas \$5.95

**Can Find These Fine**

**Sorties At Your Local**

**a CB Dealer**

**wish, you can order**

**ly from Cobra.**

**by phone**

**773.889.3087**

**1 from the main menu)**

**8 a.m.-8 p.m. M-F CST.**

**Order by mail or fax**

**Please fill out order form**

**on next page, and mail/fax**

**directly to Cobra.**



**Replacement Belt Clip**

HA-8C \$3.90

# Accessory Order Form

Item #	Description	Cost Ea.	Qty.	Amount
MA-EBM	Ear Bud Mic	\$29.95		
MA-VOX	Vox Mic	\$47.95		
717 001 N 001	(1) Ni-Cad Rechargeable Battery Cell	\$3.95		
HA-BC	Replacement Belt Clip	\$3.90		
CA-25	120V A/C Wall Charger with Plug	\$10.00		
CA-40	Lapel Microphone	\$25.95		
CA-41	Long Range Antenna	\$25.95		
ATW-400	Magnetic Mount Weather Antenna	\$27.95		
CA-43	BNC/SO239 Antenna Adapter	\$5.95		
Subtotal				
(Tax if applicable)				\$4.00
Shipping/handling				
<b>Total</b>				

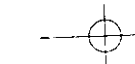

Prices subject to change without notice.

**Tax Table**

Illinois residents add 7%  
 Cook Co. residents add 7.5% (7.75% total)  
 Chicago residents add 1% (8.75% total)  
 Indiana residents add 5%  
 Michigan residents add 4%  
 Minnesota residents add 5%  
 Ohio residents add 5%  
 Wisconsin residents add 5%

For credit card orders fill out order form and fax to: 1.773.622.2269 or call 1.773.889.3087 (Press 1 from the main menu) 8:00 am - 8:00 pm, M-F, CST.

Make check or money order (no stamps) payable to: Cobra Accessories Dept. 6500 West Cartland St. Chicago, IL 60707

Please print clearly

Name \_\_\_\_\_  
 Address (No P.O. Box) \_\_\_\_\_  
 City \_\_\_\_\_ State \_\_\_\_\_  
 Zip \_\_\_\_\_  
 Telephone (\_\_\_\_) \_\_\_\_\_  
 Credit Card No. \_\_\_\_\_ Exp. Date \_\_\_\_\_  
 Customer Signature \_\_\_\_\_  
 Circle One: Visa MasterCard Discover

Allow 4 to 6 weeks for delivery. Offer valid in Continental U.S. only

