

COBY®

DVD-233



Compact Progressive Scan DVD Player



Instruction Manual

Please read this manual carefully before operation.

PRECAUTIONS

	CAUTION WARNING: SHOCK HAZARD. DO NOT OPEN. AVIS: RISQUE DE CHOC ELECTRIQUE. NE PAS OUVRIR	
CAUTION: TO REDUCE THE RISK OF FIRE AND ELECTRIC SHOCK, DO NOT REMOVE THE COVER (OR BACK) OF THE UNIT. REFER SERVICING ONLY TO QUALIFIED SERVICE PERSONNEL.		

For Customer Use:

Enter below the serial number that is located on the bottom of the unit. Retain this information for future reference.

Model No. _____ DVD-233 _____

Serial No. _____



The lightning flash with arrowhead symbol within an equilateral triangle is intended to alert the user to the presence of uninsulated "dangerous voltage" within the product's enclosure that may be of sufficient magnitude to constitute a risk of electric shock.



The exclamation point within an equilateral triangle is intended to alert the user to the presence of important operation and servicing instructions in the literature accompanying the appliance.

WARNING:

To prevent fire or shock hazard, do not expose this device to rain or moisture. Dangerous high voltage is present inside the enclosure. Do not open the cabinet.

CAUTION:

This Digital Video Disc player employs a laser system. To prevent direct exposure to the laser beam, do not try to open the enclosure or defeat the safety interlocks. When open and the interlocks are defeated, visible laser radiation is present.

Use of controls, adjustments, or performance of procedures other than those specified herein may result in hazardous radiation exposure. **DO NOT STARE INTO THE BEAM.**

FCC Notice:

This equipment has been tested and found to comply with the limits for a Class B digital device pursuant with the FCC Rules, Part 15. These limits are designed to provide reasonable protection against harmful interference in a residential installation. This equipment generates, uses, and can radiate radio frequency energy, and if not installed and used in accordance with the instructions may cause harmful interference to radio communication.

CAUTION:

To prevent electric shock, match wide blade of plug to wide slot of outlet and fully insert.

NOTICE:

This product incorporates copyright protection technology that is protected by U.S. patents and other intellectual property rights. Use of this copyright protection technology must be authorized by Macrovision, and is intended for home and other limited viewing uses only unless otherwise authorized by Macrovision. Reverse engineering or disassembly is prohibited.

Manufactured under license from Dolby Laboratories. Dolby and the double-D symbol are trademarks of Dolby Laboratories. Confidential Unpublished Works.
© 1992-1997 Dolby Laboratories. All rights reserved.



This player has built-in copyright protection technology that prevents copying from a DVD disc to any media.

If a video recorder is connected to the player, the video output image will be distorted during recording.



For recycling or disposal information about this product, please contact your local authorities or the Electronics Industries Alliance:
www.eiae.org.

IMPORTANT SAFETY INSTRUCTIONS

1. **Read Instructions:** All the safety and operating instructions should be read before the product is operated.
2. **Retain Instructions:** The safety and operating instructions should be retained for future reference.
3. **Heed Warnings:** All warnings on the product and in the operating instructions should be adhered to.
4. **Follow Instructions:** All operating and usage instructions should be followed.
5. **Cleaning:** Unplug this product from the wall outlet before cleaning. Do not use liquid cleaners or aerosol cleaners. Use a damp cloth for cleaning.
6. **Attachments:** Use only attachments recommended by the manufacturer. Use of other attachments may be hazardous.
7. **Water and Moisture:** Do not use this product near water (e.g., near a bath tub, washbowl, kitchen sink, laundry tub, in wet basements, or near a swimming pool and the like).
8. **Accessories:** Do not place this product on an unstable cart, stand, tripod, bracket, or table. Use only with carts, stands, tripods, brackets, or tables recommended by the manufacturer or sold with the product. Any mounting of the product should follow the manufacturer's instructions and should use a mounting accessory recommended by the manufacturer.
9. A product and cart combination should be moved with care. Quick stops, excessive force, and uneven surfaces may cause the product and cart combination to overturn.
10. **Ventilation:** Slots and openings in the cabinet are provided for ventilation to ensure reliable operation of the product and to protect it from overheating. These openings should never be blocked by placing the product on a bed, sofa, rug, or other similar surface. This product should not be placed in a built-in installation such as a bookcase or rack unless proper ventilation is provided or the manufacturer instructions have been adhered to.
11. **Power Sources:** This product should be operated only from the type of power source indicated on the rating label. If you are not sure of the type of power supply to your home, consult your product dealer or local power company. For products intended to operate from battery power or other sources, refer to the operating instructions.
12. **Grounding or Polarization:** This product may be equipped with a polarized alternating-current line plug that has one blade wider than the other. This plug will only fit into the power outlet in one direction. This is a safety feature. If you are unable to insert the plug fully into the outlet, try reversing the direction of the plug. If the plug should still fail to fit, contact an electrician to replace the obsolete outlet. Do not defeat the safety purpose of the polarized plug.
13. **Power-Cord Protection:** Power supply cords should be routed so that they are not likely to be walked on or pinched by items placed upon or against them, paying particular attention to cords at plugs, convenience receptacles, and at the point which they exit from the product.
14. **Protective Attachment Plug:** The product may be equipped with an attachment plug with overload protection. This is a safety feature. See the operating instructions for replacement or directions to reset the protective device. If replacement of the plug is required, be sure the service technician has used a replacement plug that has the same overload protection as the original plug as specified by the manufacturer.



IMPORTANT SAFETY INSTRUCTIONS

15. **Outdoor Antenna Grounding:** If an outside antenna is connected to the product, be sure the antenna system is grounded so as to provide some protection against voltage surges and built-up static charges. Article 810 of the National Electrical Code, ANS/NFPA 70 provides information with regard to proper grounding of the mast and supporting structure, grounding of the lead-in wire to an antenna-discharge unit, size of grounding conductors, location of antenna-discharge unit, connection to grounding electrodes, and requirements for the grounding electrode (see figure).

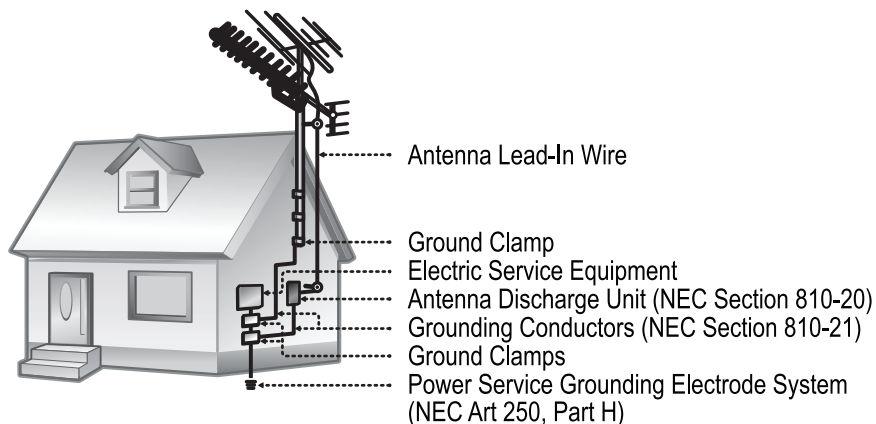

16. **Lightning:** For added protection for this product, unplug it from the wall outlet and disconnect the antenna or cable system during a lightning storm or when it is left unattended and unused for long periods of time. This will prevent damage to the product due to lightning or power-line surges.
17. **Power Lines:** An outside antenna system should not be located in the vicinity of overhead power lines or other electric light or power circuits, or where it can fall into such power lines or circuits. When installing an outside antenna system, extreme care should be taken to keep from touching such power lines or circuits, as contact with them might be fatal.
18. **Overloading:** Do not overload wall outlets, extension cords, or integral convenience receptacles as this can result in a risk of fire or electric shock.
19. **Object and Liquid Entry:** Never push objects of any kind into this product through openings as they may touch dangerous voltage points or short-out parts that could result in a fire or electric shock. Never spill liquid of any kind on the product.
20. **Servicing:** Do not attempt to service this product yourself as opening or removing covers may expose you to dangerous voltage or other hazards. Refer all servicing to qualified service personnel.
21. **Damage Requiring Service:** Unplug this product from the wall outlet and refer servicing to qualified service personnel under the following conditions: a) when the power-supply or plug is damaged; b) if liquid has been spilled or if objects have fallen into the product; c) if the product has been exposed to rain or water; d) if the product does not operate normally by following the operating instructions. Adjust only those controls that are covered by the operating

IMPORTANT SAFETY INSTRUCTIONS

instructions as improper adjustment of other controls may result in damage and will often require extensive work by a qualified technician to restore the product to its normal operation; e) if the product has been dropped or damaged in any way; f) when the product exhibits a distinct change in performance—this indicates a need for service.

22. **Replacement Parts:** When replacement parts are required, be sure that your service technician has used replacement parts specified by the manufacturer or have the same characteristics as the original part. Unauthorized substitutions may result in fire, electric shock, or other hazards.
23. **Safety Check:** Upon completion of any service or repairs to this product, ask the service technician to perform safety checks to ensure that the product is in proper operating condition.
24. **Wall or Ceiling Mounting:** The product should be mounted to a wall or ceiling only as recommended by the manufacturer.
25. **Heat:** The product should be situated away from heat sources such as radiators, heat registers, stoves, or other products (including amplifiers) that produce heat. Read these instructions carefully. Keep these instructions for future reference.

TABLE OF CONTENTS

PRECAUTIONS	2
IMPORTANT SAFETY INSTRUCTIONS	3
TABLE OF CONTENTS	6
ABOUT OPTICAL DISCS	8
Disc Requirements	8
DVD Features	8
DVD Region Codes	9
Disc Care and Maintenance	9
Handling a Disc	9
Cleaning a Disc	9
FEATURES	10
GETTING STARTED	11
DVD-233 at a Glance	11
Front Panel	11
Rear Panel	11
Remote Control	12
Overview of Audio/Video Connections	14
Standard Television Connection at a Glance	15
Progressive Scan Video (480p) Connection	15
Stereo (2-Channel) Audio Connection with Amplifier	16
Digital Audio (Surround) Connection with Digital Decoding Amplifier	16
Power Supply	17
Power Management	17
BASIC OPERATIONS	18
Basic Playback	18
Play/Pause/Stop	18
Previous/Next (Skip)	18
Forward/Reverse (Search)	18
Slow	19
Menu Navigation	19
Numeric Keypad	19
Adjusting the Volume	19
Disc Error Messages	19
PLAYER FUNCTIONS	21
Menu / Title	21
Setup	21
On-Screen Display	21
Repeat Mode	21
Repeat A-B Mode	22
Multi-Angle/Subtitle/Audio	22
Zoom	22
Program/Random	22
DVD Program Mode	23
CD Program Mode	23



TABLE OF CONTENTS

SETUP	24
Language Settings.....	24
Display Settings.....	24
Audio Settings.....	25
Parental Settings.....	25
SPECIFICATIONS	26
TROUBLESHOOTING	27

ABOUT OPTICAL DISCS

Disc Requirements





This DVD player supports playback of the following discs.

Type	Disc Mark	Content Type	Disc Size	Max. Playback Time
DVD-Video Discs		Audio + Video (moving picture)	12 cm	133 min (SS-SL)
				242 min (SS-DL)
				266 min (DS-SL)
				484 min (DS-DL)
Audio Compact Discs (CDs)		Audio	12 cm	74 min
JPEG CDs	--	Still Picture	12 cm	--

This unit can play back CD-R and CD-RW discs that contain audio titles or JPEG picture files. Discs not listed above are not supported by this unit (e.g., PC CD-ROM, CD-Extra, CD-G, CD-I, etc.)

DVD Features

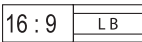
Each DVD disc contains features that may vary depending upon the production of the disc. Some of the icons you may see that represent these features are shown below.

	Number of Audio Tracks
	Number of Subtitles
	Angle Indicator
	Screen Format (Aspect Ratio)
	Zoom



Some of the DVD features enabled by this player depend on how the DVD was produced. Some features may not be enabled if the disc does not support the feature, or it may require special settings. Check the features printed on the DVD package or follow the instructions found on the disc's on-screen menu.

ABOUT OPTICAL DISCS

DVD Region Codes

DVD discs and DVD players are manufactured under a compulsory worldwide agreement, the DVD Regional Code System. DVD players will only operate with DVD discs encoded with the same corresponding Regional Code.

Region Code	Region
1	Canada, USA
2	Europe (including Poland, Romania, Czech Republic), Japan, Middle East (including Saudi Arabia, Egypt, Iran, South Africa)
3	East Asia (including Hong Kong, Taiwan, South Korea), Southeast Asia
4	Australia, Caribbean, Central America, South America, Mexico, New Zealand
5	Africa, the former Soviet Union, India, North Korea, Pakistan, Turkmenistan
6	China

Disc Care and Maintenance

Optical discs (DVDs, CDs) contain high-density compressed data and need proper handling.

Handling a Disc

- Hold a DVD/CD by its edges. Avoid touching the recorded side of the disc. To remove a DVD/CD from its storage case, press down on the center retention mechanism of the case and lift the disc out.
- Do not subject discs to prolonged exposure to direct sunlight, high humidity, or high temperatures.
- Do not bend or press discs.
- To reduce the risk of scratches, always put discs back in their case after use. Store discs vertically in a cabinet.
- Do not place stickers or labels on either side of a disc.



Cleaning a Disc

Use a dry, soft cloth to wipe off any fingerprints and dusts from the playing surface of the disc. Wipe in a straight line radially from the center to the outside edge of the disc. Small dust particles and light stains will not affect playback quality.



Never use chemicals such as record sprays, anti-static sprays, benzene, or thinners to clean a disc. Doing so will damage the surface of the disc permanently.

FEATURES

- Progressive Scan DVD Player
- Compact and Slim Design
- DVD, DVD±R/RW, CD, CD-R/RW, and JPEG Compatible
- Dolby Digital Decoder
- Digital and Analog AV Outputs for Home Theater Use
- NTSC/PAL Compatible
- Convenient On-Screen Display
- Multiple Language, Subtitle, and Camera Angle Support
- Picture Zoom Function
- Parental Lock Control
- 100-240V Automatic Power Switching

GETTING STARTED

DVD-233 at a Glance

Front Panel

1. Power Button
2. Power Indicator
3. Disc Tray
4. Open/Close Button
5. Remote Sensor Button
6. Previous/Reverse Button
7. Next/Forward Button
8. Stop Button
9. Play/Pause Button

Rear Panel

10. AC Power Cord
11. 2.1-Channel Audio Out:
L (Left Channel)
R (Right Channel)
12. Coaxial Digital Audio Out
13. Component Video Out
(Progressive Scan - 480p)
14. Composite Video Out
(Interlaced - 480i)
15. S-Video Out
(Interlaced - 480i)

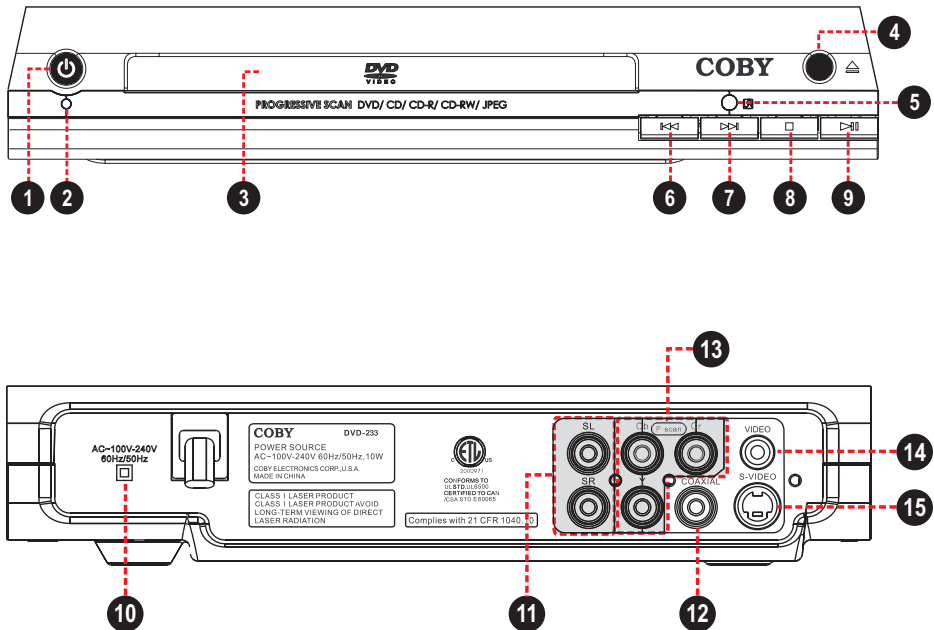

GETTING STARTED

Remote Control

1. Power/Standby
2. Title
3. Subtitle
4. Menu PBC
5. Audio
6. Mute
7. Program
8. Setup
9. Navigation Keypad
10. Slow
11. Play/Pause
12. Stop
13. Prev/Rev
14. Next/Fwd
15. Step
16. Volume + / -
17. Progressive Scan
18. Zoom
19. Repeat A-B
20. Repeat
21. Clear
22. Numeric Keypad
23. Open/Close
24. On-Screen Display
25. Angle

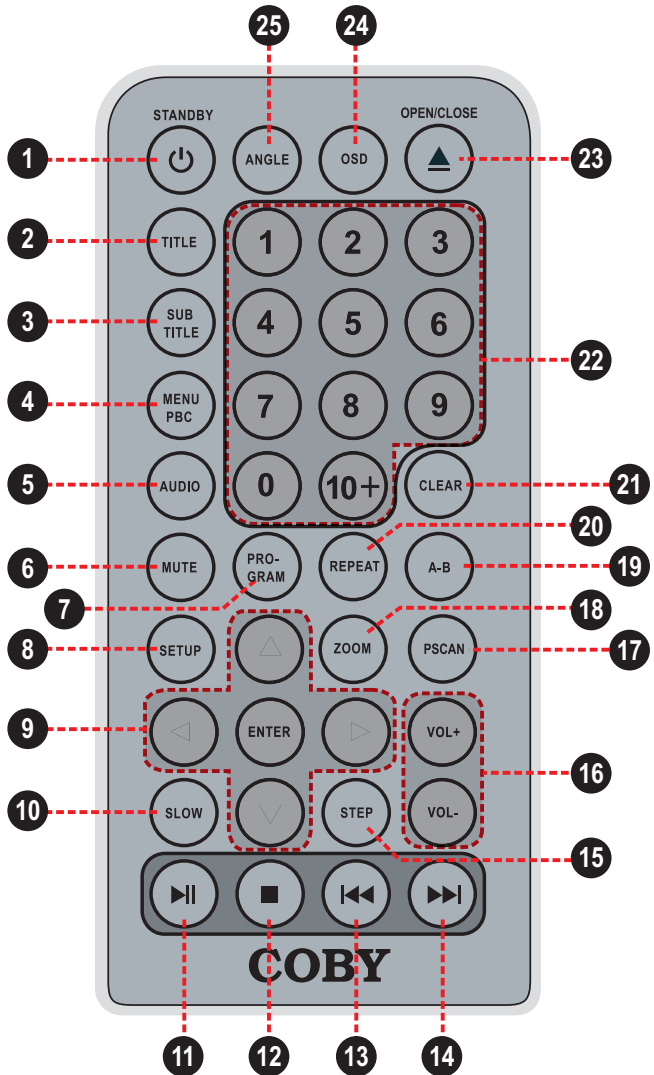

The remote control transmits a directional infrared beam. Be sure to aim the remote control directly at the infrared remote sensor. The sensor may not be able to receive signals properly if the sensor is covered, if there is a large object between the remote control and the sensor, or if it is exposed to direct sunlight or a strong artificial light (e.g., fluorescent or strobe lights). In this case, change the direction of the light or reposition the unit to avoid direct lighting.

GETTING STARTED

Remote Control Battery Installation

- Refer to the diagram. Remove the battery compartment cover located on the rear of the remote control. Insert batteries, making sure to match their polarities (+/-) to the markings on the inside of the compartment. Replace the cover.
- To use the remote, point it at the remote sensor of the player. Operate the remote within 15 feet of the sensor and at an angle of +/- 60 degrees.
- Batteries in the remote will last for approximately 1 year. Replace the batteries if the remote control does not work. Do not mix old with new batteries, or different types of batteries.
- Remove the batteries from the remote if it will not be used for a long period of time.

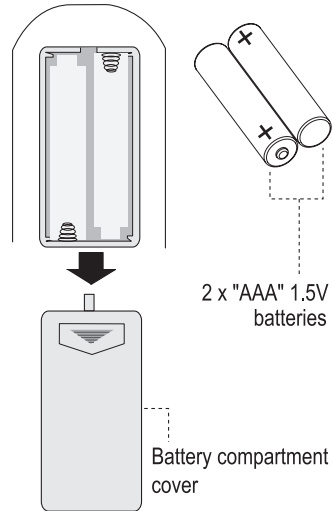

The batteries used in the remote control may present a fire or chemical burn if mis-treated. Do not recharge, disassemble, incinerate, or heat the battery (~212°F).

Keep batteries away from children.

GETTING STARTED

Overview of Audio/Video Connections

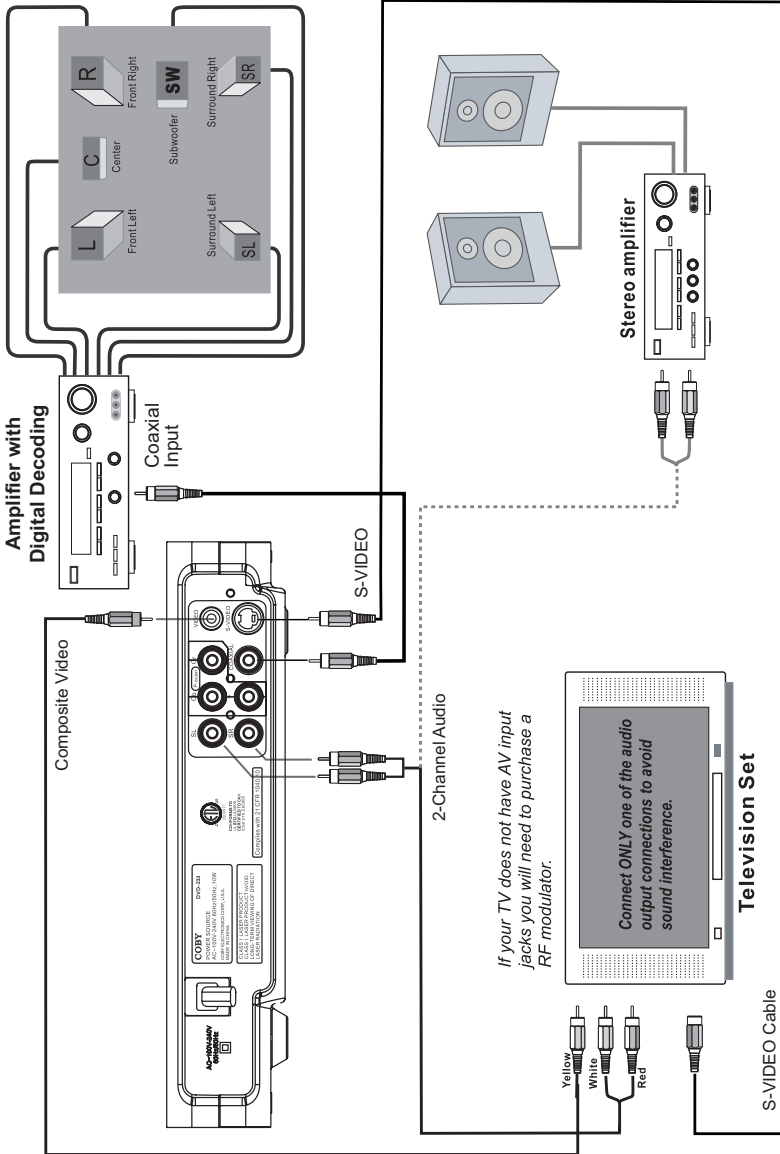

GETTING STARTED

Standard Television Connection at a Glance

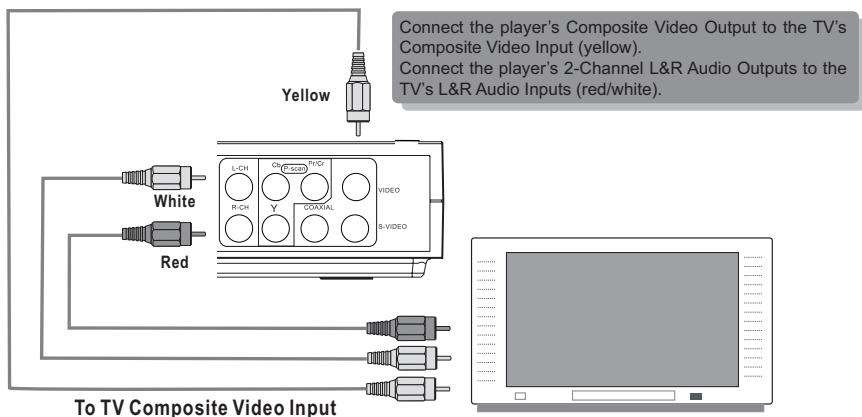

Progressive Scan Video (480p) Connection

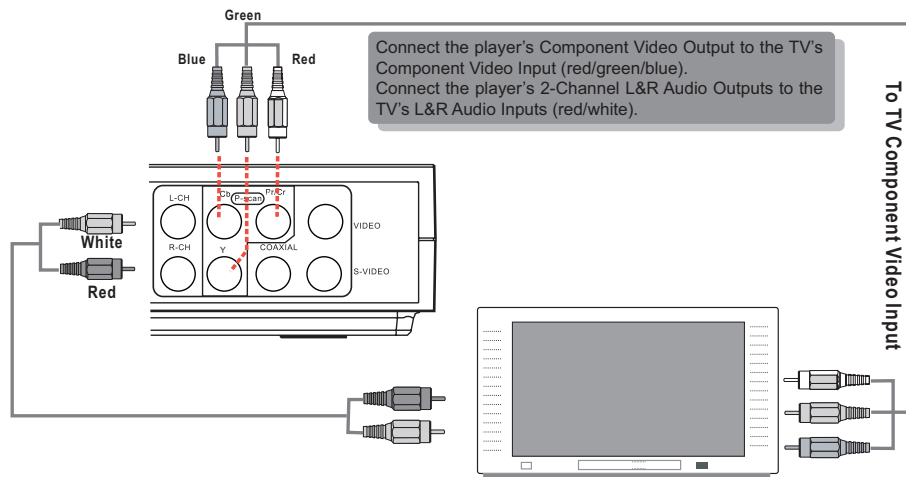

- 1 The player is equipped with composite AV outputs at the rear panel (yellow/red/white). Your TV will require at least one set of AV inputs. The supplied AV patch cord will connect your player's AV output to your TV's inputs.
- 2 The player is equipped with 2-channel stereo or 5.1-channel surround sound outputs on the rear panel. For stereo or surround sound, a Stereo TV or Surround AV receiver is necessary. For Mono TVs, you can connect either the Left or Right stereo audio output to the Mono TV's audio input.
- 3 Depending on the brand of your TV, you may need to press a button labeled "Line", "Input", or "Video/TV" in order to set your TV to the correct input line. This will switch the TV from broadcast reception mode to on of the AV input signals. (Some TVs may have more than one AV input line.)

GETTING STARTED

Stereo (2-Channel) Audio Connection with Amplifier

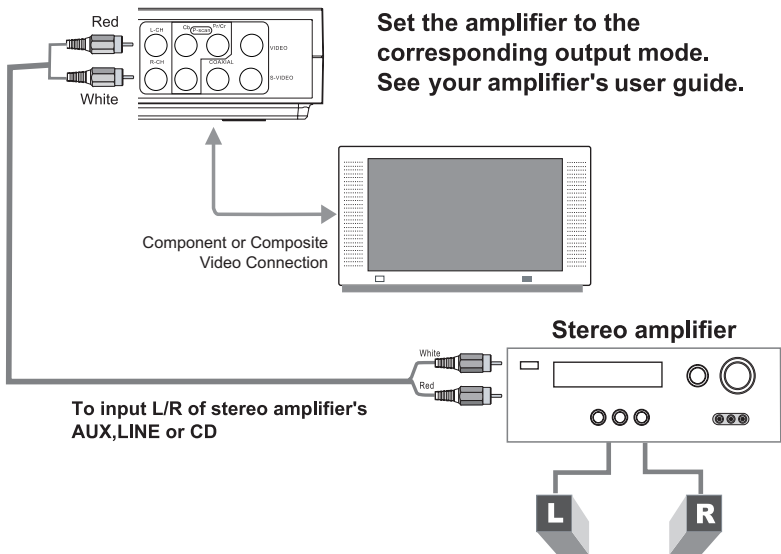

Digital Audio (Surround) Connection with Digital Decoding Amplifier

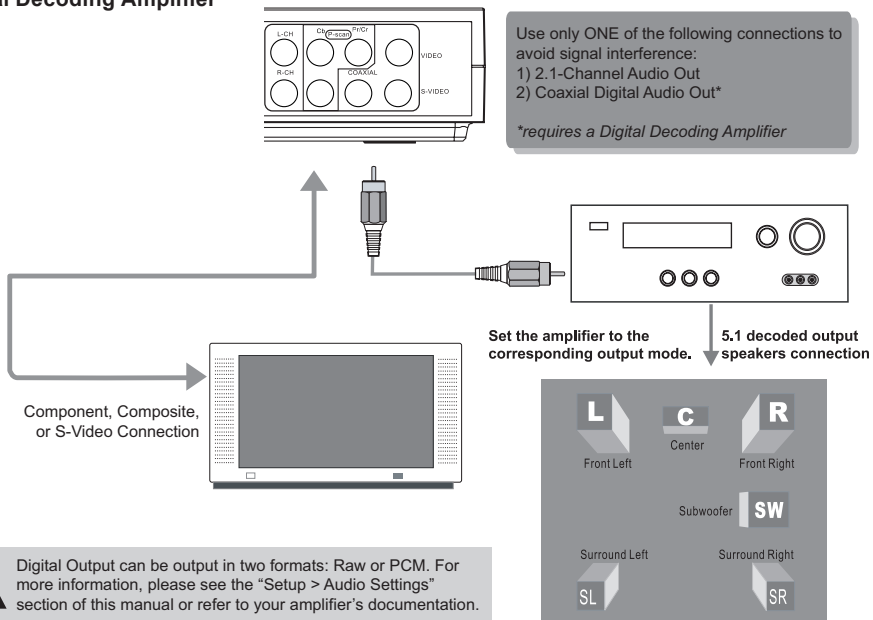

 Digital Output can be output in two formats: Raw or PCM. For more information, please see the "Setup > Audio Settings" section of this manual or refer to your amplifier's documentation.

GETTING STARTED

Power Supply

This unit should be used with 100-240V 50/60Hz AC wall outlets, only. Complete all system connections first before connecting the power.



Do not connect the power plug to a power outlet other than that which is indicated here and on the label as this may result in the risk of fire or electric shock.

Do not handle the power plug with wet hands. Doing so may cause electric shock.

Power Management







If the player will not be in use for a long period of time, set the Power Switch to the OFF position, unplug the player, and remove the batteries from the remote control.

BASIC OPERATIONS



Basic Playback

1. Prepare the connections and power supply.
Set the Power Switch to the ON position to turn the player on.
2. Select the video line.
Set your TV to display the video line connection that corresponds to your DVD player (e.g., AV1, AV2, S-Video, Component, DVD, etc.) The DVD output will be displayed on the TV screen when the proper line has been selected.
3. Load a disc.
Press the Open/Close button to open the disc tray. Insert a disc with the label-side up. Press the Open/Close button again to close the disc tray.
 - If a single-sided disc is inserted upside-down, the player will display "NO DISC" or "BAD DISC".
4. Start playback.
Press PLAY to start playback.
 - Some discs may start playing automatically or display a DVD menu specific to the disc. If a menu appears, use the NAVIGATION keys to select a desired feature or option and then press ENTER to confirm.



Play/Pause/Stop

- Press  to play the disc for the first time.
- Press  during playback to pause. Press  again to resume playback.
- Press  during playback to stop the disc ("Pre-Stop"). Press  to resume playback at the time-point at which the disc was stopped.
- Press  when the disc is "Pre-Stopped" to stop playback completely. (When  is pressed, the disc will start playing from the beginning.)



Previous/Next (Skip)

- Press  to skip to the next track (DVD, CD, etc).
- Press  to return to the previous track (DVD, CD, etc).

Forward/Reverse (Search)

- Press and hold  to fast forward through the current track. Continue holding  to change the rate of forward playback.

Normal → x2 → x4 → x8 → x16 → x32

- Press and hold  to reverse through the current track. Continue holding  to change the rate of reverse playback.

Normal → x2 → x4 → x8 → x16 → x32

BASIC OPERATIONS

Slow

- Press SLOW for slow-motion playback. Each successive press of SLOW will change the rate of slow-motion playback. Press  to resume normal playback.

Normal → x1/2 → x1/4 → x1/8 → x1/16 → x1/32

Press STEP frame-by-frame playback. Each successive press of STEP will advance the video one frame. Press  to resume normal playback.



Audio will be muted during fast-forward, fast-reverse, and slow-motion playback.

Menu Navigation

To navigate DVD disc menus or the player's setup menus:

- Press the NAVIGATION keys (arrows) to select a desired feature or option in the menu.
- Press ENTER to confirm a selection in the menu.
 - For some menu options, you may be able to use the numeric keypad to input data.
- Press  to cancel an entry.

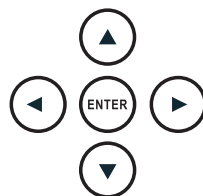

Numeric Keypad

- Use the numeric keypad to skip directly to a DVD chapter or CD track. (Some discs may not allow direct access function.)
- Use the numeric keypad to input numeric data in menu option fields when possible.

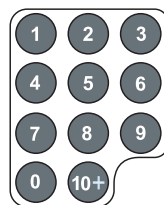

Adjusting the Volume

- Press VOL+ or VOL- to adjust your player's volume level output.

Disc Error Messages

The following messages will be displayed on-screen if there is a problem with the format of the loaded disc.

- **WRONG REGIONAL DISC.** The region code of the disc does not match the player's region code (Region 1).
- **WRONG PASSWORD.** The parental rating level of the disc is higher than the parental rating level setting of the player. The player will not play the disc.
- **WRONG DISC.** The player is equipped with automatic disc quality detection software. If the player detects a disc that is damaged or has a format problem, it may play the disc at a lower quality or stop play completely, depending on how damaged the disc is.

BASIC OPERATIONS

- **DTS Discs:** This player does not have a built-in DTS decoder.
 - Connect to a digital amplifier using a Digital Audio Connection (optical or coaxial) to enjoy DTS audio discs.
 - Select Dolby 5.1 or 2-Channel Stereo Downmix instead of the DTS setting.



DVD disc production quality may vary; some discs may deviate from the industry standard. Some incorrectly-formatted discs may still play, however, the playback and operational quality of the disc may be substandard.

PLAYER FUNCTIONS

Menu / Title

- Press the MENU/PBC key during DVD playback to return to the disc's Main menu.
- Press the TITLE key during DVD playback to return to the disc's Title menu.

Setup

Press the SETUP key to enter the player's setup menu. Enter the Setup menu to adjust the player's internal settings; please see the SETUP section for more details.

On-Screen Display

The On-Screen Display (OSD) indicator is a user-friendly interface designed to display playback type status. The OSD indicator will display information based on the type of disc that has been loaded (i.e., DVD or CD).

Press the OSD key once to show time information on-screen; press it twice to show status information on-screen; press it a third time to exit the on-screen display mode. The on-screen display will disappear automatically if another function key is pressed.

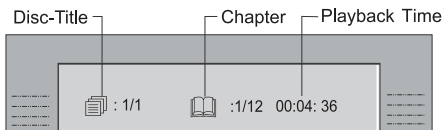

① **OSD Time Info: DVD**

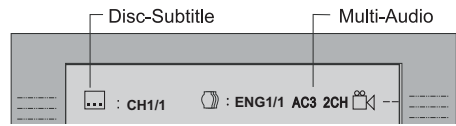

② **OSD Status Info: DVD**

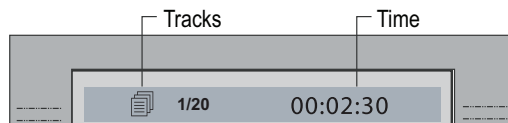

① **OSD Time Info: CD**

Repeat Mode

Press REPEAT to change the repeat mode of the player. Each successive press of REPEAT will change the mode as follows:

	DVD Mode	CD Mode
REPEAT x1	Repeat Title	Repeat Track
REPEAT x2	Repeat Chapter	Repeat Disc
REPEAT x3	Repeat Off	Repeat Off

Note:

Some DVD discs do not allow Repeat mode.

PLAYER FUNCTIONS

Repeat A-B Mode

To repeat a specific section of a disc (play on a loop):

1. Press A-B to set the desired start point ("A") of the section to be repeated.
2. Press A-B again to set the desired end point ("B") of the section to be repeated.
3. The section "A-B" will now play repeatedly as a loop. Press A-B again to resume normal playback.

Multi-Angle/Subtitle/Audio

- During playback of a DVD that has been mastered with multiple angles, press ANGLE to view the available alternate camera angles. (A DVD may have up to 9 selectable angles.)
- During playback of a DVD that has been mastered with subtitles, press SUBTITLE to view the available subtitle tracks. (A DVD may have up to 32 selectable subtitles.)
- During playback of a DVD that has been mastered with alternate language/audio tracks, press AUDIO to hear the alternate tracks. (A DVD may have up to 8 selectable audio tracks.)

Zoom

Press ZOOM to change the magnification level of the picture.

- During DVD playback, each successive press of ZOOM will change the level of magnification to: Zoom x2, Zoom x4, Normal.
- During JPEG CD playback, each successive press of ZOOM will change the level of magnification to: 25%, 50%, 100%, 150%, 200%.

When the magnification level is greater than Normal/100%, use the NAVIGATION keys to pan around the magnified picture.

When the magnification level is equal to 100%, use the NAVIGATION keys to rotate the picture.

Note: *The picture quality will decrease as the zoom level (magnification) increases.*

Program/Random

To play tracks in random order, press PROGRAM twice to display "Random" and then press ENTER to confirm.

To create a custom sequence of tracks to be played, press PROGRAM three times to display "PROGRAM" and then press ENTER to confirm.

(Program mode is available only when the player is in NAVIGATE OFF mode. Press the PBC key to set the player to NAVIGATE OFF mode.)

Note:

Use the numeric keypad to input numbers directly to the fields. Use the navigation keys to move between entry fields.

PLAYER FUNCTIONS

DVD Program Mode

- Load a DVD and enter Program mode.
- Use the navigation keys to select a field.
 - Use the numeric keypad to enter track numbers in the left “Trk” columns (or press CLEAR to delete).
 - Use the numeric keypad to enter chapter numbers in the right “Chp” columns (or press CLEAR to delete).
- To start over, use the navigation keys to select “Clear All” to delete all Track/Chapter selections.
- To play your programmed selections, use the navigation keys to select “Play” or press PROGRAM to cancel.



CD Program Mode

- Load a CD and enter Program mode.
- Use the navigation keys to select a field.
 - The left column designates the program order number.
 - Use the numeric keypad to enter track numbers in the right “Trk” columns (or press CLEAR to delete).
- To start over, use the navigation keys to select “Clear All” to delete all Track selections.
- To play your programmed selections, use the navigation keys to select “Play” or press PROGRAM to cancel.

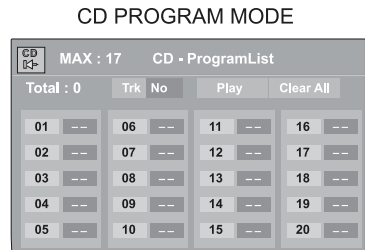

SETUP

Enter Setup mode to adjust the various internal settings of the player. Make sure the player has been completely stopped before entering Setup mode.

1. Press **SETUP** to enter Setup mode.
2. Use the **NAVIGATION** keys to select a desired item.
3. Press **ENTER** to confirm a selection.
4. Press **SETUP** to exit Setup mode (or select **EXIT** and press **ENTER**).

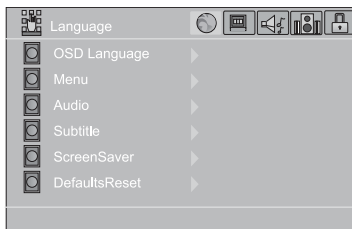

Language Settings

Use the **NAVIGATION** keys to highlight the desired language selection and press **ENTER** to confirm.

Item	Description	Default Setting
OSD	Sets the language of the player's on-screen display.	English
Menu	Sets the default menu language of loaded DVDs.	English
Audio	Sets the default language audio track of loaded DVDs.	English
Subtitle	Sets the default subtitle track of loaded DVDs.	English
Screen Saver	The screensaver prevents burn-in damage to the player's screen.	On
Defaults Reset	Resets all settings to their factory-default state.	

Display Settings

Use the **NAVIGATION** keys to highlight the desired display selection and press **ENTER** to confirm.

Item	Description	Default Setting
Aspect Ratio	Sets the aspect ratio of the display. 4:3 is used with standard television displays; 16:9 is used with widescreen television displays.	4:3L-Box (Letterbox)
TV Type	Sets the player's Video Out signal type. Set this to correspond with your TV's Video System type. NTSC is the standard used in North America.	NTSC
Video Out	Sets your player's video output mode. Set this to correspond with the type of connection used with your TV. S-Video+CVBS: S-Video or Composite Video P-Scan: Component Video (Progressive Scan) YUV: Component Video	S-Video+CVBS

SETUP

Audio Settings

Use the NAVIGATION keys to highlight the desired audio selection and press ENTER to confirm.

Item	Description	Default Setting
SPDIF Digital	Sets the digital audio output signal type (PCM, RAW, OFF). For use with digital decoding receivers (see your receiver's manual for more information).	RAW
Channel Output	Sets the audio channel mix mode (LT/RT, Stereo).	Stereo

Parental Settings

Use the NAVIGATION keys to highlight the desired parental selection and press ENTER to confirm.

Item	Description	Default Setting
Password	You must input the four-digit password to access the Parental settings. The initial password is 8888.	
Change Password	Enter the old password, the new password, and then the new password again to verify and change the Parental Settings password. Restoring the player's default settings will not reset the password. DO NOT FORGET THE PASSWORD; this password cannot be reset.	
Rating Level	Sets the maturity rating level of the player. The player will not play any discs rated higher than this setting. There are eight rating levels. Level 1 will restrict playback to discs suitable for people of all ages. Level 8 will allow playback of all discs, including those suitable for adults only.	8

SPECIFICATIONS

Display Type	On-Screen
Disc Support	DVD, DVD±R/RW, CD, CD-R/RW, JPEG
Video Output	Component Video (Progressive Scan) S-Video Composite Video
Audio Output	Coaxial Digital Audio RCA 2-Channel Stereo Audio
Digital Audio Decoders	Dolby Digital
Video System	NTSC/PAL
Power	AC 100-240V 20W (max)
Unit Dimensions	

Specifications and manual are subject to change without notice.

233SS

TROUBLESHOOTING

If you have a problem with this player, please read the troubleshooting guide below and check our website at www.cobyusa.com for Frequently Asked Questions (FAQs) and firmware updates. If these resources do not resolve the problem, please contact Technical Support.

COBY Electronics Technical Support

56-65 Rust Street
Maspeth, NY 11378

Hours: 8:00 AM–11:00 PM EST, seven days a week.

Email: techsupport@cobyusa.com

Phone: 718-416-3197, 800-681-2629, or 800-727-3592

Web: www.cobyusa.com

There is no power to the device.

- Ensure that the Power Switch on the main unit is physically set to the ON position.
- Ensure that the AC adapter cord is securely connected to the player and the proper wall outlet.

The device will not play the disc.

- Ensure that a supported disc is loaded in the player label-side up.
- Ensure that the disc's rating level does not exceed the player's parental rating level.
- Ensure that the disc is not damaged or too dirty. Clean the disc or try another disc.
- Moisture may have condensed inside the player. Remove the disc and leave the player on for 1-2 hours and then try again.

There is no picture.

- Ensure that the TV set has been powered on and is set to the correct AV mode.
- Ensure that the connections between the player and the TV are secure and correct.
- Check if the connection cables are damaged.
- Restore the player to its factory-default settings: open the disc tray, and then press PROGRAM and ZOOM together.

The picture is noisy or distorted.

- The disc may be damaged or dirty. Clean the disc or try another one.
- Reset your TV's color system.
- Ensure that the player is connected directly to the TV (and not through a VCR, cable box, satellite receiver, etc.)

The picture is not full-screen.

- Change the aspect ratio setting of your player from the Setup menu.
- Select a different aspect ratio option from the DVD disc menu.

TROUBLESHOOTING

There is no sound or distorted sound.

- Ensure that the TV and amplifier have been turned on and properly set up.
- Ensure that the TV and amplifier connections are secure and correct.
- Try a different Audio track of the DVD by pressing AUDIO.
- Ensure that the MUTE function of the TV, Amplifier, or Player is not engaged.

The remote control doesn't work.

- Ensure that the Power Switch has been physically set to the ON position.
- Ensure that there are no obstacles between the remote and the player.
- Point the remote at the remote sensor on the main unit.
- Ensure that the batteries in the remote retain a charge and have been installed correctly.
- Try replacing the remote's batteries.

The player has malfunctioned.

- Unplug the player. After 30 minutes, plug in and power on the player -- the restore function should reset the player.

NOTES

NOTES

NOTES

COBY Electronics Corp.

56-65 Rust Street
Maspeth, NY 11378

www.cobyusa.com
www.ecoby.com