

COBY®

TFT LCD Widescreen Television

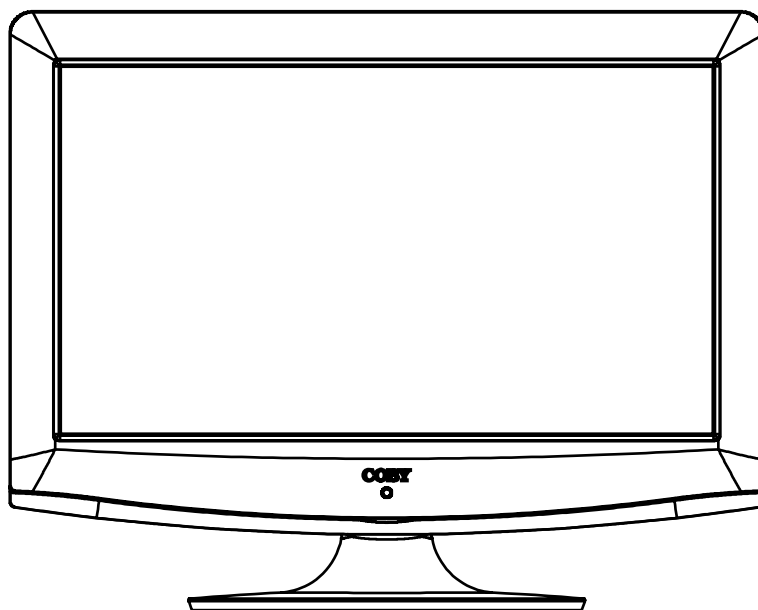

Instruction Manual

TFTV1525

Please read this manual carefully before connection and use

Precautions

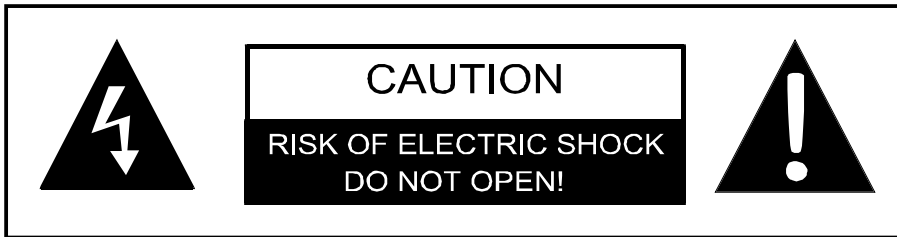

WARNING:
TO REDUCE THE RISK OF FIRE OR ELECTRIC SHOCK, DO NOT EXPOSE THIS APPLIANCE TO RAIN OR MOISTURE.



The lightning flash with arrowhead symbol, within an equilateral triangle, is intended to alert the user to the presence of uninsulated "dangerous voltage" within the product's enclosure that may be of sufficient magnitude to constitute a risk of electric to persons.



The exclamation point within an equilateral triangle is intended to alert the user to the presence of important operating and maintenance (servicing) instructions in the literature accompanying the appliance.

For Customer Use:
Enter below the serial number that is located on the rear of the unit. Retain this information for future reference.

Model No. TF-TV 1525 _____

Serial No. _____

Caution:

These servicing instructions are for use by qualified service personnel only. To reduce the risk of electric shock, do not perform any servicing other than that contained in the operating instructions unless you are qualified to do so. Refer to manual for servicing instructions.

Power Supply:

Connect one end of the supplied power cord to the power jack on the unit rear panel and the other end to the AC100-240V wall outlet. If the unit will not be used for a long time, disconnect the plug from the outlet.

Power Management:

- Before plugging the power cord into the AC outlet, make sure that all the connections have been properly made.
- If the unit will not be used for a long period of time, disconnect the power and remove the batteries from the remote.

Precautions

FCC Statement:

This device complies with Part 15 of the FCC Rules. Operation is subject to the following two conditions:

- This device may not cause harmful interference, and
- This device must accept any interference received, including interference that may cause undesired operation.

Note:

This equipment has been tested and found to comply with the limits for Class B digital devices, pursuant to Part 15 of the FCC rules. These limits are designed to provide reasonable protection against harmful interference in a residential installation. This equipment generates, uses and can radiate radio frequency energy and, if not installed and used in accordance with the instructions, may cause harmful interference to radio communications. However, there is no guarantee that interference will not occur in a particular installation. If this equipment does cause harmful interference to radio or television reception, which can be determined by turning the equipment off and on, the user is encouraged to try to correct the interference by one or more of the following measures:

- Reorient or relocate the receiving antenna.
- Increase the separation between the equipment and receiver.
- Connect the equipment into an outlet on a circuit different from that to which the receiver is connected.
- Consult the dealer or an experienced radio/TV technician for help

Use of shielded cable is required to comply with Class B limits in Subpart B of Part 15 of the FCC rules. Do not make any changes or modifications to the equipment unless otherwise specified in the manual. If such changes or modifications should be made, you could be required to stop operation of the equipment.

LCD Information

The LCD panel used in this television contains millions of thin film transistors that have been manufactured using a high-technology process to deliver a crisp, clear, and detailed picture. Occasionally, a few of these transistors may become stuck or non-active; please note that this does not affect the performance of the television.

Copyright Protection

Unauthorized copying, broadcasting, public performance, and lending of disks are prohibited. This product incorporates copyright protection technology that is protected by method claims of certain U.S. patents and other intellectual property rights owned by Macrovision Corporation and other rights owners. Use of this copyright protection technology must be authorized by Macrovision Corporation, and is intended for home and other limited viewing uses only unless otherwise authorized by Macrovision Corporation. Reverse engineering or disassembly is prohibited.

Important Safety Instructions

1. **Read Instructions:** All the safety and operating instructions should be read before the product is operated.
2. **Retain Instructions:** The safety and operating instructions should be retained for future reference.
3. **Heed Warnings:** All warnings on the product and in the operating instructions should be adhered to.
4. **Follow Instructions:** All operating and usage instructions should be followed.
5. **Cleaning:** Unplug this product from the wall outlet before cleaning. Do not use liquid cleaners or aerosol cleaners. Use a damp cloth for cleaning.
6. **Attachments:** Use only attachments recommended by the manufacturer. Use of other attachments may be hazardous.
7. **Water and Moisture:** Do not use this product near water (e.g., near a bath tub, washbowl, kitchen sink, laundry tub, in wet basements, or near a swimming pool and the like).
8. **Accessories:** Do not place this product on an unstable cart, stand, tripod, bracket, or table. Use only with carts, stands, tripods, brackets, or tables recommended by the manufacturer or sold with the product. Any mounting of the product should follow the manufacturer's instructions and should use a mounting accessory recommended by the manufacturer.
9. A product and cart combination should be moved with care. Quick stops, excessive force, and uneven surfaces may cause the product and cart combination to overturn.
10. **Ventilation:** Slots and openings in the cabinet are provided for ventilation to ensure reliable operation of the product and to protect it from overheating. These openings should never be blocked by placing the product on a bed, sofa, rug, or other similar surface. This product should not be placed in a built-in installation such as a bookcase or rack unless proper ventilation is provided or the manufacturer instructions have been adhered to.
11. **Power Sources:** This product should be operated only from the type of power source indicated on the rating label. If you are not sure of the type of power supply to your home, consult your product dealer or local power company. For products intended to operate from battery power or other sources, refer to the operating instructions.
12. **Grounding or Polarization:** This product may be equipped with a polarized alternating-current line plug that has one blade wider than the other. This plug will only fit into the power outlet in one direction. This is a safety feature. If you are unable to insert the plug fully into the outlet, try reversing the direction of the plug. If the plug should still fail to fit, contact an electrician to replace the obsolete outlet. Do not defeat the safety purpose of the polarized plug.
13. **Power-Cord Protection:** Power supply cords should be routed so that they are not likely to be walked on or pinched by items placed upon or against them, paying particular attention to cords at plugs, convenience receptacles, and at the point which they exit from the product.
14. **Protective Attachment Plug:** The product may be equipped with an attachment plug with overload protection. This is a safety feature. See the operating instructions for replacement or directions to reset the protective device. If replacement of the plug is required, be sure the service technician has used a replacement plug that has the same overload protection as the original plug as specified by the manufacturer.
15. **Lightning:** For added protection for this product, unplug it from the wall outlet and disconnect the antenna or cable system during a lightning storm or when it is left unattended and unused for long periods of time. This will prevent damage to the product due to lightning or power-line surges.
16. **Power Lines:** An outside antenna system should not be located in the vicinity of overhead power lines or other electric light or power circuits, or where it can fall into such power lines or circuits. When installing an outside antenna system, extreme care should be taken to keep from touching such power lines or circuits, as contact with them might be fatal.
17. **Overloading:** Do not overload wall outlets, extension cords, or integral convenience receptacles as this can result in a risk of fire or electric shock.
18. **Object and Liquid Entry:** Never push objects of any kind into this product through openings as they may touch dangerous voltage points or short-out parts that could result in a fire or electric shock. Never spill liquid of any kind on the product.
19. **Servicing:** Do not attempt to service this product yourself as opening or removing covers may expose you to dangerous voltage or other hazards. Refer all servicing to qualified service personnel.



Important Safety Instructions

20. **Damage Requiring Service:** Unplug this product from the wall outlet and refer servicing to qualified service personnel under the following conditions: a) when the power-supply or plug is damaged; b) if liquid has been spilled or if objects have fallen into the product; c) if the product has been exposed to rain or water; d) if the product does not operate normally by following the operating instructions. Adjust only those controls that are covered by the operating instructions as improper adjustment of other controls may result in damage and will often require extensive work by a qualified technician to restore the product to its normal operation; e) if the product has been dropped or damaged in any way; f) when the product exhibits a distinct change in performance—this indicates a need for service.
21. **Replacement Parts:** When replacement parts are required, be sure that your service technician has used replacement parts specified by the manufacturer or have the same characteristics as the original part. Unauthorized substitutions may result in fire, electric shock, or other hazards.
22. **Safety Check:** Upon completion of any service or repairs to this product, ask the service technician to perform safety checks to ensure that the product is in proper operating condition.
23. **Wall or Ceiling Mounting:** The product should be mounted to a wall or ceiling only as recommended by the manufacturer.
24. **Heat:** The product should be situated away from heat sources such as radiators, heat registers, stoves, or other products (including amplifiers) that produce heat.
25. **Outdoor Antenna Grounding:** If an outside antenna is connected to the product, be sure the antenna system is grounded so as to provide some protection against voltage surges and built-up static charges. Article 810 of the National Electrical Code, ANS/NFPA 70 provides information with regard to proper grounding of the mast and supporting structure, grounding of the lead-in wire to an antenna-discharge unit, size of grounding conductors, location of antenna-discharge unit, connection to grounding electrodes, and requirements for the grounding electrode (see figure).

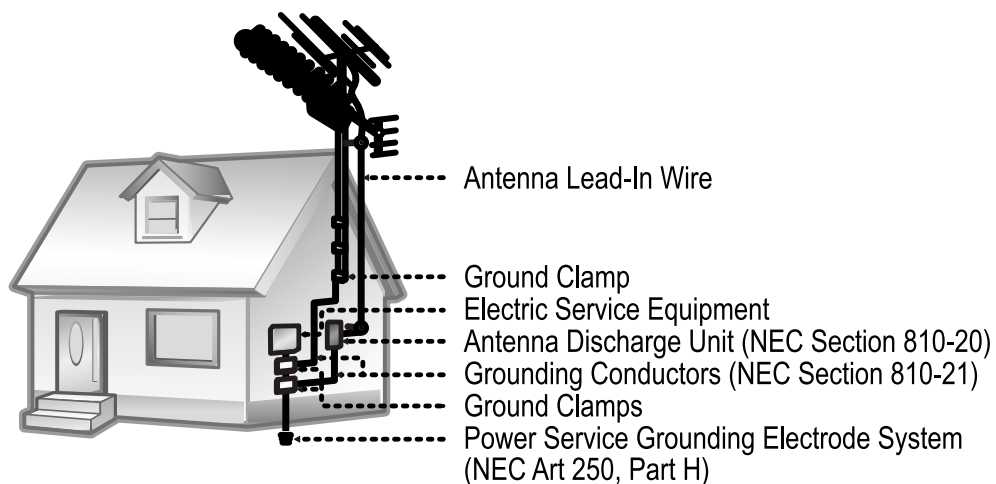

Table of Contents

Table Of Contents

Precautions

Important Safety Instructions

Main Feature-----	1
Package Contents-----	2
Unit View-----	3
Remote Control -----	4
Cable Connections-----	6
TV Function-----	8
AV Function-----	12
PC Function-----	13
Troubleshooting -----	14
Specifications -----	15

Main Features

This product incorporates the LCD display and the TV receiver in one system.

Multiple Mode

TV
AV
S-VIDEO
COMPONENT
HDMI
VGA

High Quality Property

High Resolution

Adopt an MPEG2 decoding format to achieve horizontal resolution more than 500 lines.

Superior sound

Built-in Dolby Digital decoder to output high quality sound effects.

Screen

Support the picture size of a normal screen (4:3) and a wide screen (16:9)

LCD (Liquid Crystal Display)

Designed with color TFT liquid crystal display clearly shows the data.

NOTE: It is normal for a TFT screen to experience some light or dark spots appearing on the LCD screen.

Package Contents

Please make sure the following items are included with your LCD TV/monitor. If any item is missing, contact your dealer.

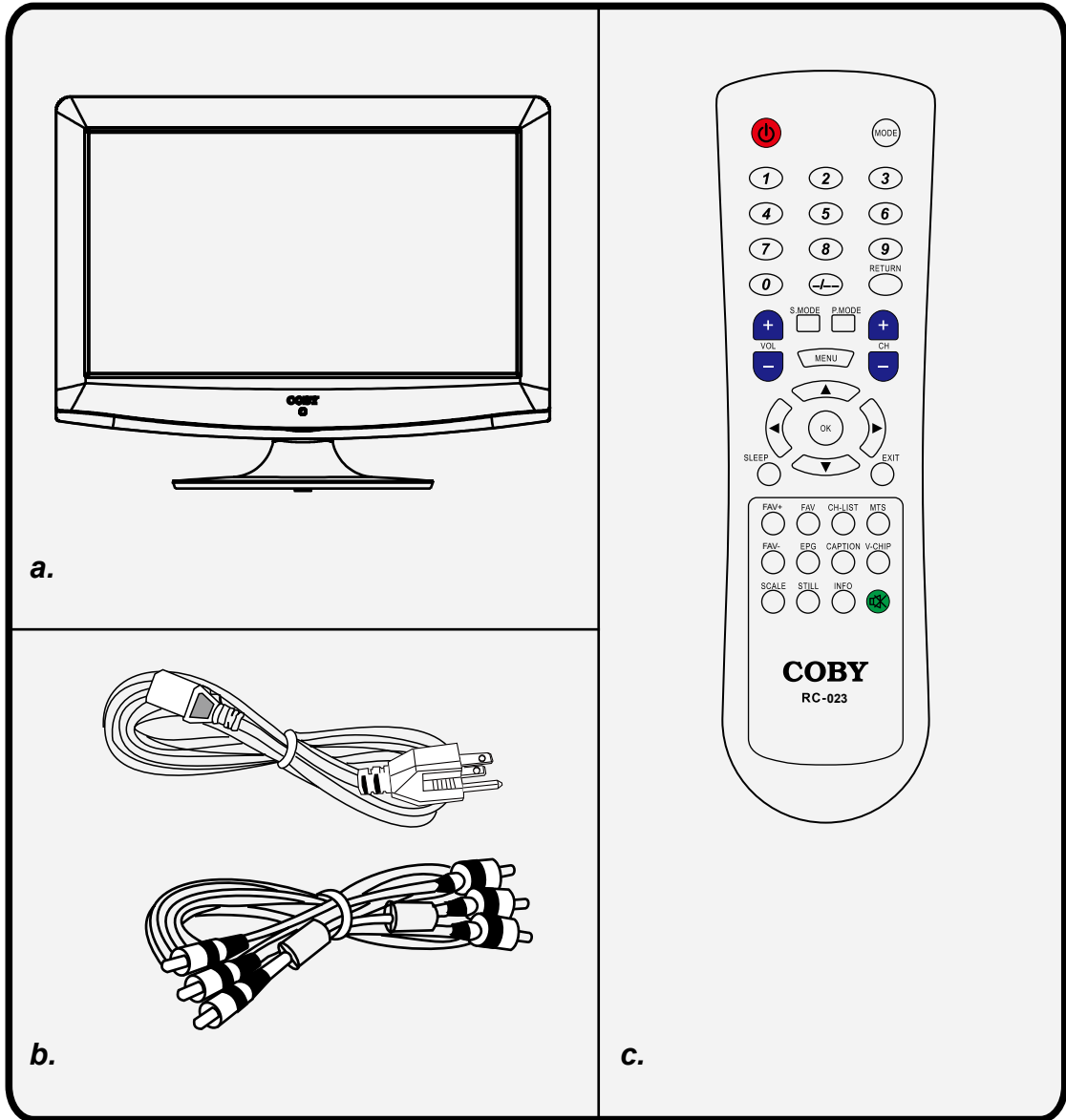

a, Main Unit

b, Power Cord & RCA Cable

c, Remote Control Unit

Unit View

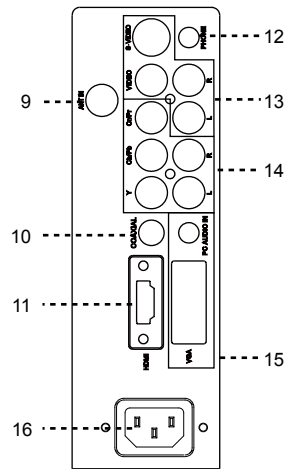
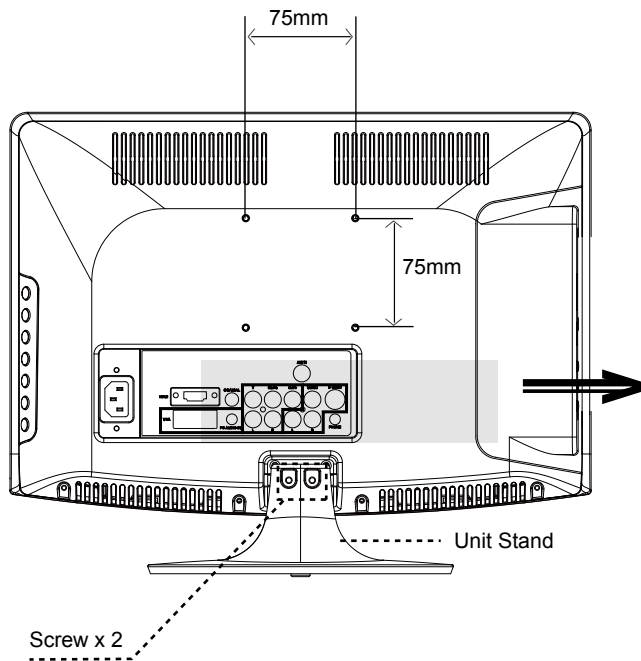
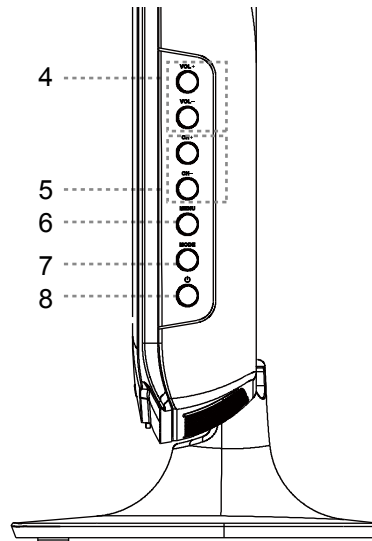
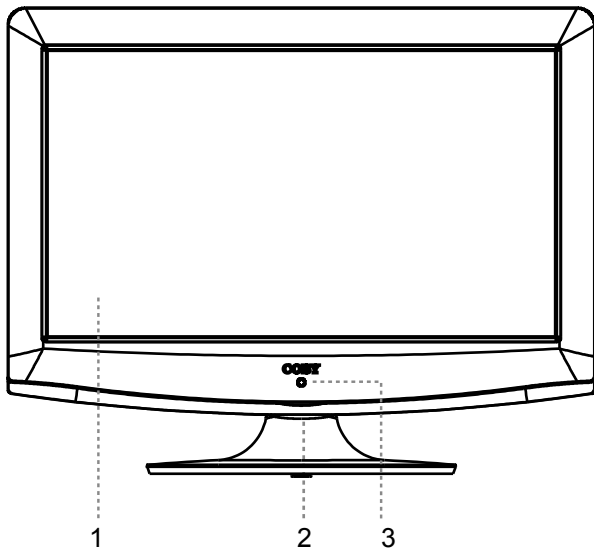

- | | | | |
|--------------------|----------|----------------------|-------------------------|
| 1. TFT SCREEN | 5. CH-/+ | 9. ANTENNA JACK | 13. VIDEO/S-VIDEO INPUT |
| 2. POWER INDICATOR | 6. MENU | 10. COAXIAL | 14. COMPONENT INPUT |
| 3. REMOTE SENSOR | 7. MODE | 11. HDMI | 15. VGA INPUT |
| 4. VOLUME-/+ | 8. POWER | 12. HEADPHONE OUTPUT | 16. POWER JACK |

Wall Mounting - Attach the TV case to the wall

- Release screws and take apart the unit case and the unit stand.
- Use the VESA standard mountings to fix the unit on the wall. Take care when mounting, it may cause damage or serious injury should it fall from its mountings. See the Specification page for VESA information.

Remote Control

Remote Control Drawing

1. POWER button
Press to turn the power on/off.
2. Numeric Keypad
Press to input data.
3. S.Mode
Press to select the audio mode.
4. VOLUME +/- button
Press to adjust the sound level.
5. MENU button
Press to show the system menu.
6. Sleep button
Press to access the sleep timer.
7. FAV + button
Press to skip the favorite channels forward.
8. FAV button
Press to display the favorite channel list.
9. FAV - button
Press to skip the favorite channels backward.
10. EPG button
Access the Electronic Program Guide.
11. SCALE button
Adjust the display effect.
12. STILL button
Press to freeze the picture.
13. MODE button
Press to select the working mode.
14. RETURN button
Press to return to the previously viewed channel.
15. P.Mode
Select the picture mode.
16. CHANNEL +/--button
Press to skip channels.
17. Direction &OK
While working with the system menu, press the direction buttons to move the cursor and press OK to confirm settings.
18. EXIT button
Press to exit the system menu.
19. MTS button
Set the ATV audio mode or the DTV audio language.
20. CH-LIST
Press to display the channel list.
21. V-CHIP
Access the LOCK menu.
22. CAPTION
Select the closed caption mode. (CC Off, CC On, CC On Mute)
23. MUTE button
Press to muffle/release sound.
24. INFO
Press to show the current working information.

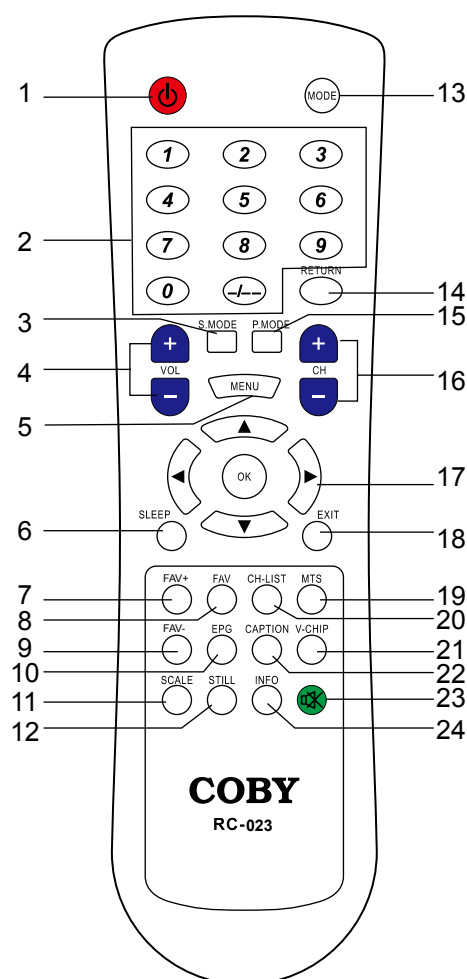

Remote Control

Remote Control

Preparation

- Remove the battery compartment cover located on the rear of the remote control. Insert 2 x “AAA” batteries, making sure to match their polarities (+/-) to the markings on the inside of the compartment. Replace the cover.
- Batteries in the remote will last for approximately 6 months under the normal use. Replace the batteries if the remote control does not work. Do not mix old with new batteries, or different types of batteries.
- Remove the batteries from the remote if it will not be used for a long period of time.

Warnings:

The battery used in this device may present a fire or chemical burn if mistreated. Do not recharge, disassemble, incinerate, or heat the battery (~212°F).

Keep batteries away from children.

Using the Remote Control

To use the remote, point it at the remote sensor of the player. Operate the remote within 20 feet of the sensor and at an angle of ± 30 degrees.

The operating distance may vary depending on the brightness around.

Notes:

1. Do not point bright lights directly at the remote control sensor.
2. Do not place objects between the remote control unit and the remote control sensor.
3. Do not use this remote control unit while simultaneously operating the remote control unit of any other equipment.

Cable Connections

Figure. Cable connections

Antenna/Power Connection

1. Connect TV RF sources to the antenna port. TV RF signals include: receiving antenna/CATV net. You can use 75 Ohm coaxial cable to connect outdoor antenna.
2. Insert one end of the supplied power cord to the player's power jack and the other end to the 110-240V AC wall outlet.

VGA Input - PC Connection

The VGA port of the TV is capable of accepting high-definition signals from computers with a VGA output jack. When used as a computer monitor, connect the VGA jack and the PC Audio In jack with a 15-Pin D-Sub cable and a 3.5mm stereo audio cable.

Coaxial Output - Digital Audio Output Connector

When MPEG audio or Dolby Digital audio is played, Dolby Digital bitstream or MPEG audio bitstream is sent to the player's digital audio output connector. When the player is connected to a Dolby or MPEG audio decoder via this output socket, you can enjoy theater-quality audio in your home. An optical audio cable is required when a Dolby Digital decoder or MPEG audio decoder is used.

Phone Connection

Be sure that your unit is set at a low volume level before connecting the earphone. Increase the volume gradually for your comfortable listening.

CAUTION:

Hearing experts advise against the constant use of personal stereos played at high volume. Constant high volume use can lead to hearing loss. If you experience ringing in the ears or hearing loss, discontinue use and seek medical advise.

HDMI Input - AV Signal Input

HDMI (High Definition Multimedia Interface) is a new type of connection that transmits digital audio and video signals simultaneously over a single cable. A HDMI cable is required for the HDMI connection.

These HDMI input connectors are capable of receiving video at resolutions up to 1080p (1080-progressive).

Set the unit into the relative input mode to enable the signal pass.

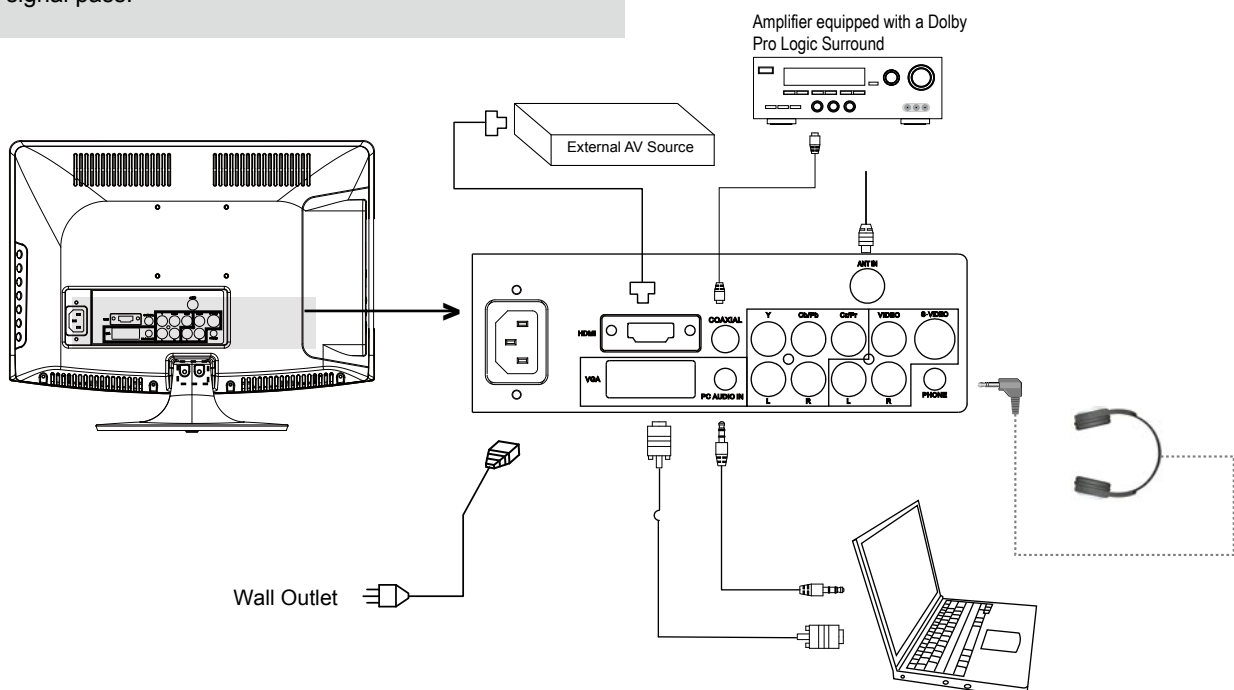

Cable Connections

Component Input (Y Cb/Pb Cr/Pr)

The component port is capable of accepting high-definition signals from standard video sources. (e.g., cable/satellite boxes, DVD players, VCRs, etc.)

1. Connect the Y/Pb/Pr port by the component cable to input the video signal.
2. Connect "R" "L" port by the supplied AV cable to input the audio signal. The red/white plug of the AV cable is for the audio connection and the yellow plug for the video connection.

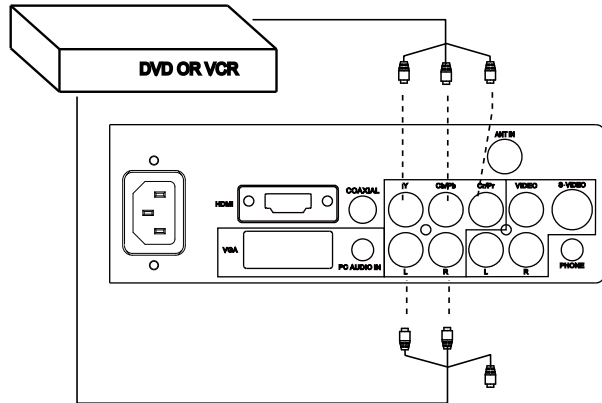

S-Video Input

The S-Video port is capable of accepting signals from standard video sources. (e.g., cable/satellite boxes, DVD players, VCRs, etc.)

1. Connect the S-Video port by the S-Video cable to input the video signal.
2. Connect the AUDIO-L/R port by the supplied AV cable to input the audio signal.

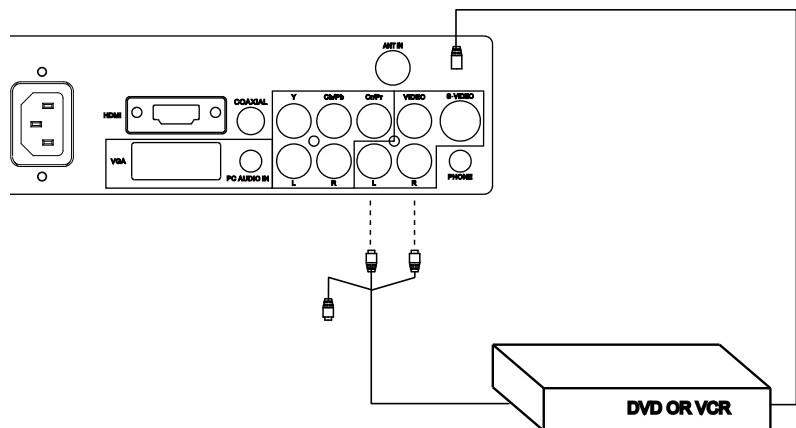

RCA Input

The CVBS port is capable of accepting signals from standard video sources (e.g., cable/satellite boxes, DVD players, VCRs, etc.)

1. Connect the VIDEO port with the yellow plug of the supplied AV cable.
2. Connect the L/R port with the red & white plug of the supplied AV cable to input the audio signal.

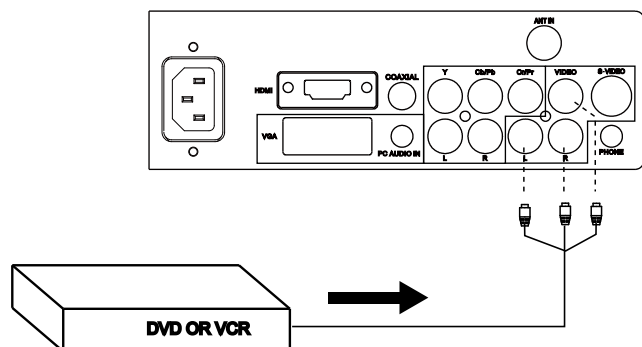

NOTE:

We supply the AV cable and the power cord with this product.

The white/red plug of the AV cable is for the audio connection and the yellow plug for the video connection.

The white/red plug of the AV cable can also be used separately to input the audio signal in the S-video/Component connection.

NOTE:

1. Be sure to have all necessary connections properly done before connect the power supply.
2. When input the AV signal, refer to the manual of the external sources as well.

TV Function

TV Function

Preparations

1. Connect the cables.(Refer to the "Cable Connections" section for details).
2. Press the POWER button to turn on the player.
3. Press the MODE button to select the TV signal mode.
4. Press the CH+/- buttons to skip channels. Or you can press the number buttons to input channels directly. For initial use, you need to scan channels under the Channel Menu. See the "Channel Menu" section for details.

TV Setup Menu

Various features can be preset through the TV setup menu.

- Press MENU to display the setup menu, TV setup menu consists of PICTURE, AUDIO, TIME, SETUP, LOCK as well as CHANNEL.
- Press the left/right direction button to select the desired submenu, press OK to enter.

While working with the menu,

1. Press the up/down direction button to select the option.
2. Press the left/right direction button to adjust.
3. Press MENU to exit/back up menu.



Picture Menu

ITEM	DESCRIPTION
Picture Mode	Setup the picture mode (Personal, Standard, Dynamic, Soft).
Contrast	Adjust the display contrast
Brightness	Adjust the display brightness
Color	Adjust the display color
Tint	Adjust the display tint
Sharpness	Adjust the image sharpness
Color Mode	Set the color mode (Normal, Warm, Cool).

TV Function

Audio Menu

ITEM	DESCRIPTION
Sound Mode	Set the sound mode. (Standard, Music, Movie, Sports, Personal)
Bass	Adjust the bass.
Treble	Adjust the treble.
Balance	Adjust the sound balance.
Surround	Set the audio surround effect on/off.
AVC	Set AVC on/off.
Audio	Set the audio language.

Time Menu

ITEM	DESCRIPTION
Sleep Timer	The unit will shut down automatically on the Sleep Time. The available option is 5/10/15/30/45/60/90/120/180/240 min, Off. The count down would start immediately after setting. You can access this function by repeatedly pressing the SLEEP button on the remote also. To check the timer left, press the SLEEP button on the remote once. To cancel the sleep timer, set the timer to Off.
Time Zone	Set the DTV time zone. (Pacific, Alaska, Hawaii, Eastern, Central, Mountain)
Daylight Saving Time	Set the DTV daylight saving function on/off.
Clock	Display the DTV clock information.

TV Function

Setup Menu

ITEM	DESCRIPTION
Menu Language	Set the menu language.
Transparency	Set the transparency on/off.
Zoom Mode	Set the screen effect. (4:3, Cinema, Normal, 16:9)
Noise Reduction	Adjust the screen noise appearance. (Weak, Middle, Strong, Off)
Closed Caption	Press the right direction button to access the Closed Caption menu. There are four options listed under the Closed Caption menu. CC Mode - Set the CC mode. (Off, On, CC On Mute) Basic Selection - Set the basic CC type. (CC1~4, Text 1~4) Advanced Selection - Set the advanced CC type for DTV. (Service 1~6) Option -Press the right direction button to enter Option. Under the option menu, set Mode as Custom to edit the DTV CC type to your own liking.
DLC	Set DLC on/off
Restore Default	Set the player to the factory default.

Lock Menu

ITEM	DESCRIPTION
Enter	You are required to enter the 4-digit password to access the Lock menu. The initial password is 0000.
Change Password	To change the password, input the old password - - > input the new password- - >verify again. Please remember the password since the player's reset function would not revert the password.
System Lock	Set the system lock function on/off. Set the lock function On to access the parental control setup.
US	Setup the US parental control. TV(TV Rating) - Y, Y7, G, PG, 14, MA. Press the direction buttons to move between options, press OK to set block. To release, press OK again. MPAA(Movie Rating) - PG-13, R, NC-17, X, N/A, G, PG) Press the left/right direction button to set the movie rating.
Canada	Setup the Canada parental control Canada English - G, PG, 14+, 18+, E, C, C8+. Canada French - E, G, 8ans+, 13ans+, 16ans+, 18ans+.
RRT Setting	Set the rating region table.
Reset RRT	Restore RRT to the default.

TV Function

Channel Menu

ITEM	DESCRIPTION
Air/Cable	Setup the antenna type as Air or Cable.
Auto Scan	Search channels automatically. Select this option, press the right button to start searching, press MENU to stop. When use Cable system, you need to select the cable system first from AUTO, STD, IRC and HRC before scanning.
Favorite	Make the favorite channels collection. Select this option, press the right direction button to access the Favorite List. In the Favorite List, press the up/down direction button to select the desired channel. Press OK to set it as a favorite channel. To release, press OK again. Press the left/right button to turn pages in the FAV list.
Show/Hide	Hide the unwanted channels. Select this option, press the right direction button to access the Show/Hide menu. In the Show/Hide menu, press the up/down direction button to select the channel, press OK to hide the channel, press OK again to release. Press the left/right button to turn pages in the Show/Hide list.
Channel No	Press the left/right direction button to select the channel.
Channel Label	Edit the channel label. 1. Select the channel you want to put a label. You can use the Channel No option or directly locate the channel by the number button/CH+/- button. 2. Select "Channel Label", press the right direction button to show the edit menu. In the menu, press the left/right direction button to move left/right, press the up/down direction button to change characters.
DTV Signal	Display the DTV signal intensity.

AV Function

AV Function

The player's AV input function enables the user to view programs from external input sources.

1. Connect the external AV signal source. Refer to the "Cable Connection" section for details
2. Press the MODE button to select the relevant AV mode (AV, S-Video, Component, HDMI)

AV Setup Menu

Various features can be preset through the AV menu.

- Press the MENU button to display the AV menu. AV setup menu consists of PICTURE, AUDIO, TIME, SETUP as well as LOCK.
- Press the left/right direction button to select the desired sub-menu, press OK to enter.

While working with the menu

1. Press the up/down direction buttons to select the desired item.
2. Press the left/right direction button to adjust.
3. Press MENU to exit/back up the menu.



NOTE: Please see the TV section for menu descriptions

PC Function

PC Function

You can use the unit's TFT LCD as your computer's monitor.

1. Shut down both units and connect the VGA jack and PC Audio In jack. See the "Cable Connection" section.
2. Turn on the units and press the MODE button to select VGA

PC Setup Menu

Various features can be preset through the PC menu.

- Press the MENU button to display the PC menu. PC setup menu consists of PICTURE, AUDIO, TIME as well as SETUP.
- Press the left/right direction button to select the desired sub-menu, press OK to enter.

While working with the menu

1. Press the up/down direction buttons to select the desired item.
2. Press the left/right direction button to adjust.
3. Press MENU to exit/back up the menu.

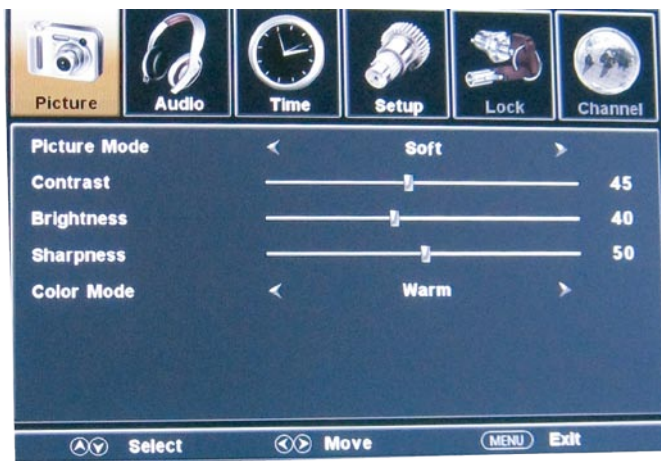

NOTE: Please see the TV section for menu descriptions

Adjust the PC Screen

Upon switching to the PC mode, the monitor will be automatically regulated for a proper functioning. If the result is not up to your expectation, please perform the following steps to adjust the screen manually .

1. Enter the "Advanced" sub-menu from the SETUP menu, select "Auto" and press the left/right direction button to adjust the monitor automatically.
2. Or if you still have problem with the monitor after, adjust "H-Pos", "V-Pos", "Clock" as well as "Phase" accordingly under the SETUP menu.

Trouble Shooting

If you have a problem with this device, please read the troubleshooting guide section and check our website at www.cobyusa.com for Frequently Asked Questions (FAQs) and firmware updates. If these resources do not resolve the problem, please contact Technical Support.

Address

COBY Electronics Technical Support
 56-65 Rust Street
 Maspeth, NY 11378

Email

techsupport@cobyusa.com

Web

www.cobyusa.com

Phone

800-727-3592: Weekdays 8:30AM -9:00PM EST
 Saturdays 9:00AM -5:30PM EST
 718-416-3197: Weekdays 8:00AM -5:30PM EST

Symptom	Check and Action
No Power	<ul style="list-style-type: none"> • Make sure the unit has been powered on manually. • Check if the power cord has been properly connected to the power outlet. • Check if the main power has been switched on.
No Picture	<ul style="list-style-type: none"> • Try another TV channel • Check if the system connection is proper and secure. • Check if the connection cables are damaged.
No Sound	<ul style="list-style-type: none"> • Increase the volume. • Check if the MUTE function of the unit has been activated. • Check if the sound system has been properly set. • Check if the AV audio signal input cable has been connected properly.
Color Distorted	<ul style="list-style-type: none"> • Reset the color system of the unit. • Check if the system has been properly connected. • Check if the AV video signal input cable is connected properly.
Picture and Sound are interfered	<ul style="list-style-type: none"> • Check if the system has been properly connected. • If using antenna, adjust the antenna.
Remote Control does not work	<ul style="list-style-type: none"> • Make sure the POWER button on the unit has been turned on manually. • Remove the obstacles between the remote control and the player. • Point the remote control towards the remote sensor on the player. • Check if the batteries of the remote control have been loaded with correct polarities. • Replace the batteries of the remote control.
Malfunction	<ul style="list-style-type: none"> • Should the player develop a malfunction, unplug the player for 30 minutes. After that, power on the player and the restore function should reset the player.

Specification

TFTV 1524

TFT Panel Characteristic	Active Area	15.6"
	Resolution	1366X768
	Display Color	6-bit, 262.144 colors
	Pixel Pitch	0.252(H) x 0.252(V)
TV Charactoristic	TV System	ATSC/NTSC
	Antenna Impedance	75Ω
Standard	Power Consumption	100-240V 50/60Hz
		On Working 40W(Max)
		Speaker 2x(4Ω,3W)
	Operating Temperature Range	0°c-40°c
	Dimension	378X133X334 MM
	Wall Mounting	VESA M4 75X75 MM

P/N:
Specifications and manual are subject to change without prior notice.