

USER MANUAL

NORTH AMERICA: ENGLISH

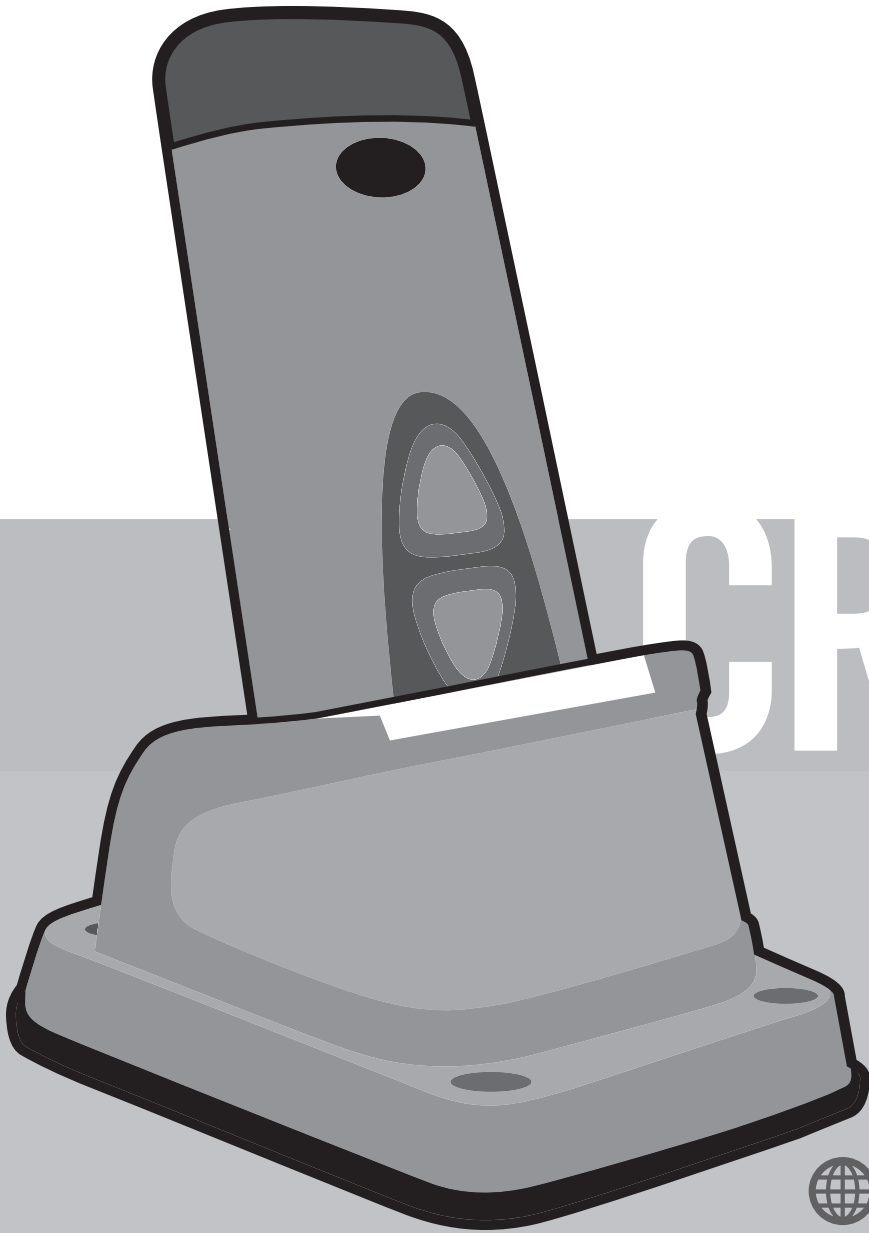

CR2300

MANUAL VERSION 04
RELEASE DATE: JULY 2014



www.codecorp.com



Configuration Guide



[YouTube.com/codecorporation](https://www.youtube.com/codecorporation)

code
ADVANCED BARCODE READERS

Statement of Agency Compliance



The Code Reader™ 2300 (CR2300) has been tested for compliance with FCC regulations and was found to be compliant with all applicable FCC Rules and Regulations.

IMPORTANT NOTE: To comply with FCC RF exposure compliance requirements, this device must not be co-located or operate in conjunction with any other antenna or transmitter.



CAUTION: Changes or modifications not expressly approved by the party responsible for compliance could void the user's authority to operate the equipment.

The CR2300 has been tested for compliance to CE standards and guidelines and was found to conform to applicable CE standards, specifically the EMC requirements EN 55024, ESD EN 61000-4-2, Radiated RF Immunity EN 61000-4-3, ENV 50204, EFT EN 61000-4-4, Conducted RF Immunity EN 61000-4-6, EN 55022, Class B Radiated Emissions, and Class B Conducted Emissions.



The CR2300 has been tested and certified in compliance with the Technical Regulations Conformity Certification of Specified Radio Equipment (ordinance of MPT N°.37. 1981), Article 2, Paragraph 1, Item 19.

Code voids product warranty if the hard case has been opened or tampered with in any way.

The CR2300 meets all safety and quality standards in accordance to EN 60950-1:2006/A11:2009/A1:2010.

CR2300 CodeXML® Modem FCC, Industry Canada and ICES Compliance

FCC

This device complies with part 15 of the FCC Rules. Operation is subject to the following two conditions: (1) This device may not cause harmful interference, and (2) this device must accept any interference received, including interference that may cause undesired operation.

NOTE: This equipment has been tested and found to comply with the limits for a Class B digital device, pursuant to part 15 of the FCC Rules. These limits are designed to provide reasonable protection against harmful interference in a residential installation. This equipment generates, uses and can radiate radio frequency energy and, if not installed and used in accordance with the instructions, may cause harmful interference to radio communications. However, there is no guarantee that interference will not occur in a particular installation.

If this equipment does cause harmful interference to radio or television reception, which can be determined by turning the equipment off and on, the user is encouraged to try to correct the interference by one or more of the following measures:

- Reorient or relocate the receiving antenna.
- Increase the separation between the equipment and receiver.
- Connect the equipment into an outlet on a circuit different from that to which the receiver is connected.
- Consult the dealer or an experienced radio/TV technician for help.

FCC Radiation Exposure Statement:

This equipment complies with FCC radiation exposure limits set forth for an uncontrolled environment. This equipment should be installed and operated with minimum distance 20cm between the radiator and your body.

Industry Canada

This device complies with Industry Canada licence-exempt RSS standard(s). Operation is subject to the following two conditions: (1) this device may not cause interference, and (2) this device must accept any interference, including interference that may cause undesired operation of the device.

Le présent appareil est conforme aux CNR d'Industrie Canada applicables aux appareils radio exempts de licence. L'exploitation est autorisée aux deux conditions suivantes : (1) l'appareil ne doit pas produire de brouillage, et (2) l'utilisateur de l'appareil doit accepter tout brouillage radioélectrique subi, même si le brouillage est susceptible d'en compromettre le fonctionnement.

This Class B digital apparatus complies with Canadian ICES-003.

Cet appareil numérique de la classe B est conforme à la norme NMB-003 du Canada.

Important Note:

Radiation Exposure Statement:

This equipment complies with IC radiation exposure limits set forth for an uncontrolled environment. This equipment should be installed and operated with minimum distance 20cm between the radiator and your body.

Note Importante: (Pour l'utilisation de dispositifs mobiles)

Declaration d'exposition aux radiations:

Cet équipement est conforme aux limites d'exposition aux rayonnements IC établies pour un environnement non contrôlé. Cet équipement doit être installé et utilisé avec un minimum de 20 cm de distance entre la source de rayonnement et votre corps.



Code Reader™ 2300 User Manual

Copyright © 2014 Code Corporation.

All Rights Reserved.

The software described in this manual may only be used in accordance with the terms of its license agreement.

No part of this publication may be reproduced in any form or by any means without written permission from Code Corporation. This includes electronic or mechanical means such as photocopying or recording in information storage and retrieval systems.

NO WARRANTY. This technical documentation is provided AS-IS. Further, the documentation does not represent a commitment on the part of Code Corporation. Code Corporation does not warrant that it is accurate, complete or error free. Any use of the technical documentation is at the risk of the user. Code Corporation reserves the right to make changes in specifications and other information contained in this document without prior notice, and the reader should in all cases consult Code Corporation to determine whether any such changes have been made. Code Corporation shall not be liable for technical or editorial errors or omissions contained herein; nor for incidental or consequential damages resulting from the furnishing, performance, or use of this material. Code Corporation does not assume any product liability arising out of or in connection with the application or use of any product or application described herein.

NO LICENSE. No license is granted, either by implication, estoppel, or otherwise under any intellectual property rights of Code Corporation. Any use of hardware, software and/or technology of Code Corporation is governed by its own agreement.

The following are trademarks or registered trademarks of Code Corporation:

CodeXML®, Maker, QuickMaker, CodeXML® Maker, CodeXML® Maker Pro, CodeXML® Router, CodeXML® Client SDK, CodeXML® Filter, HyperPage, CodeTrack, GoCard, GoWeb, ShortCode, GoCode®, Code Router, QuickConnect Code, Rule Runner®, Cortex®, CortexRM, CortexMobile, Code, Code Reader, CortexAG, CortexStudio, CortexTools, Affinity®, CortexDecoder, CortexJPOS, and CortexOPOS.

All other product names mentioned in this manual may be trademarks of their respective companies and are hereby acknowledged.

The software and/or products of Code Corporation include inventions that are patented or that are the subject of patents pending. U.S. Patents: 6997387, 6942152, 7014113, 7070091, 7097099, 7353999, 7519239, 7621453, 8001550, 8011584.

The Code Reader software uses the Mozilla SpiderMonkey JavaScript engine, which is distributed under the terms of the Mozilla Public License Version 1.1. The Code Reader software is based in part on the work of the Independent JPEG Group.

Code Corporation, 12393 S. Gateway Park Place, Ste. 600, Draper, Utah 84020

www.codecorp.com

Table of Contents

1.0 - Included Items	5
2.0 - Set Up.....	6
3.0 - Battery Installation and Removal	6
4.0 - Fuel Gauge Battery Status Indicator.....	6
5.0 - Charging the CR2300	7
6.0 - Powering On/Off the Reader	7
7.0 - Scanning	7
8.0 - Establishing a Bluetooth Connection.....	8
9.0 - Transmitting Batch Data via Bluetooth Communication	9
10.0 - Transmitting Batch Data via USB Communication	9
11.0 - Wired Communication via USB Downloader Mode	10
12.0 - Reader Feedback	10
13.0 - Reading Ranges.....	11
14.0 - Symbologies Defaulted On	11
15.0 - Symbologies Defaulted Off.....	11
16.0 - Reader ID and Firmware Version.....	12
17.0 - CR2300 Dimensions.....	12
18.0 - Charging Station Dimensions	13
19.0 - CR2300 Maintenance	13
20.0 - Warranty	14

1.0 - Included if Ordered

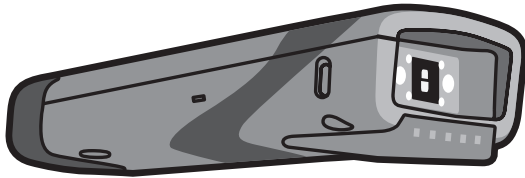

CR2300
(Model #: CR2321)



USB 2.0 Cable

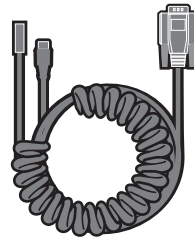

RS232 Cable

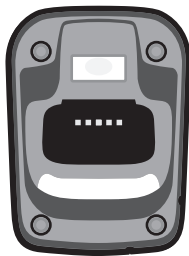

Charging Station

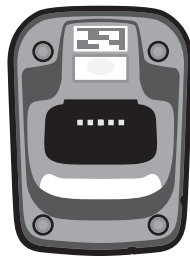

Charging Station with Embedded CodeXML® Modem

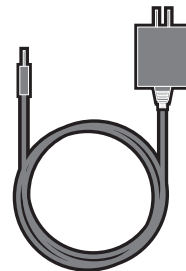
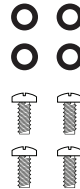

5VDC Power Supply

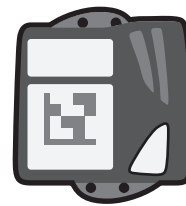

CodeXML® M3 Modem

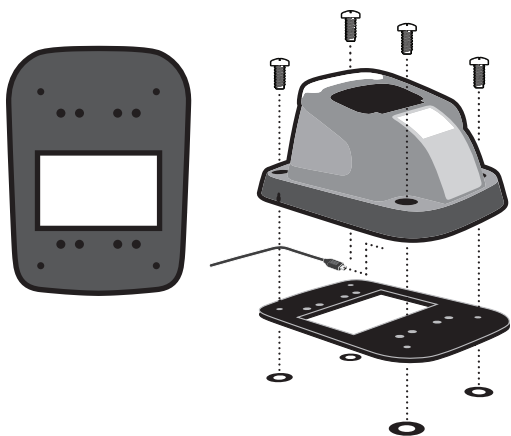

Battery Cartridge

2.0 - Set Up

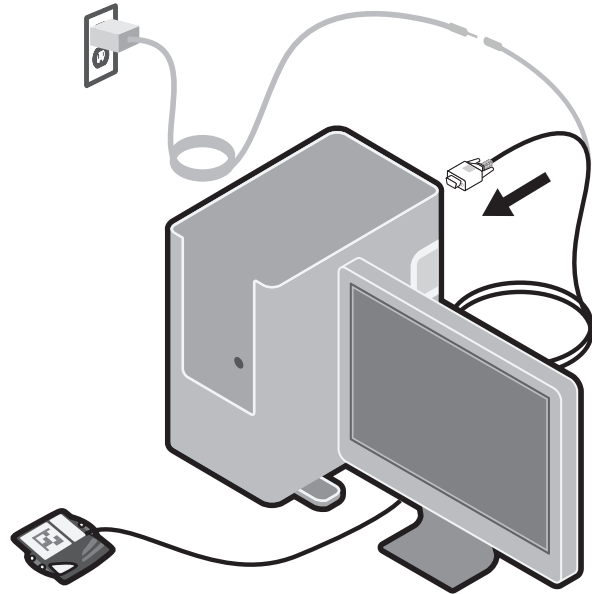
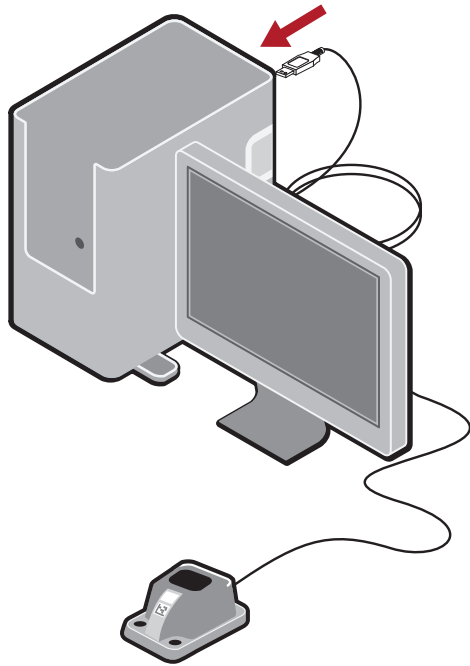

3.0 - Battery Installation and Removal

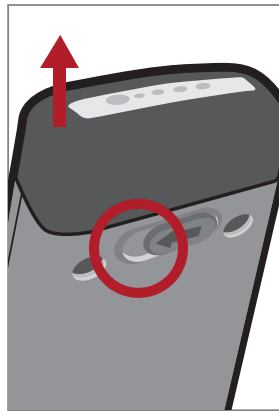
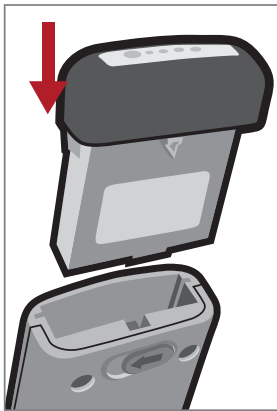

4.0 - Fuel Gauge Battery Status Indicator

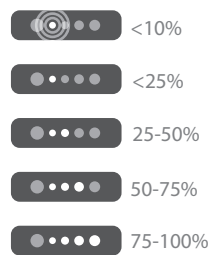
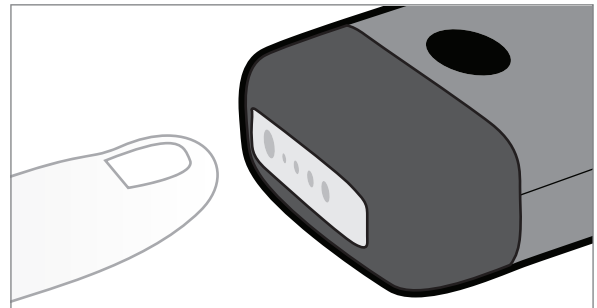

Completely charge before initial use.

5.0 - Charging the CR2300

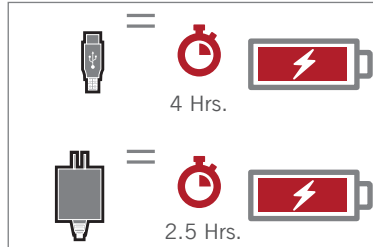
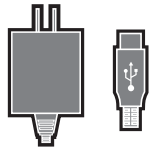
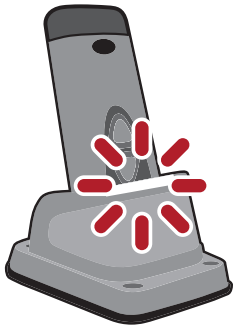

6.0 - Powering On/Off the Reader

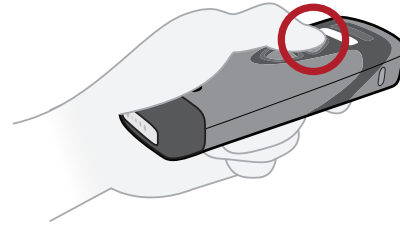

- ① 
1 Sec.
- ② 
- ③ 
1x

7.0 - Scanning

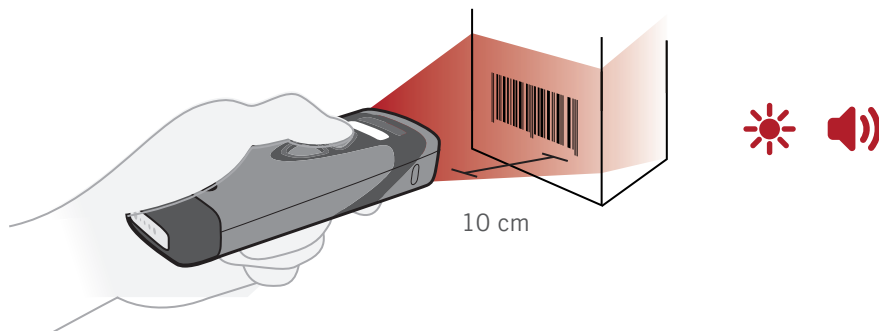

8.0 - Establishing a Bluetooth Connection

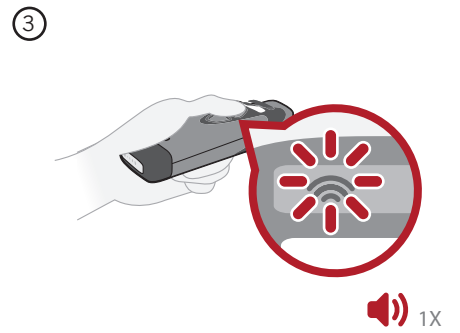
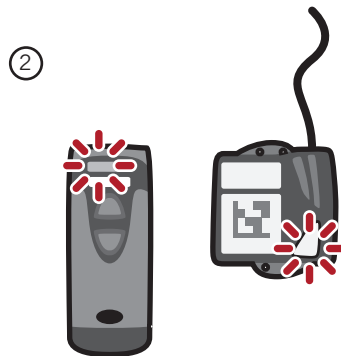
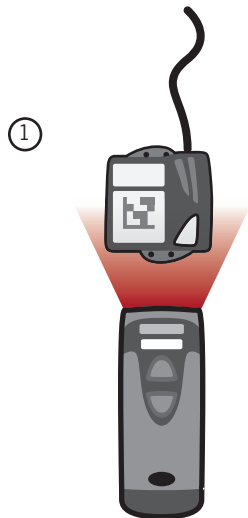
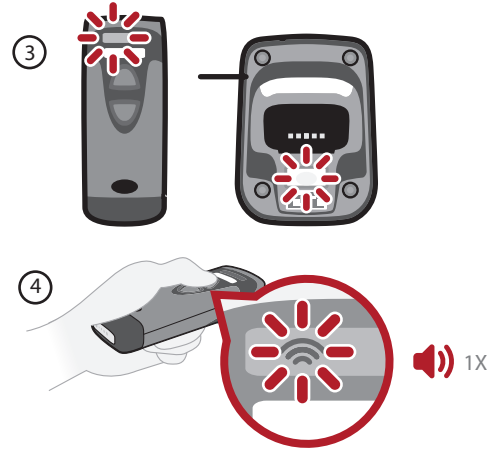
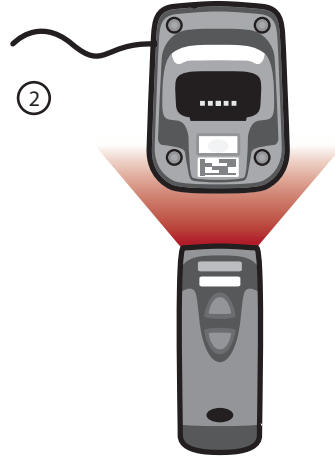
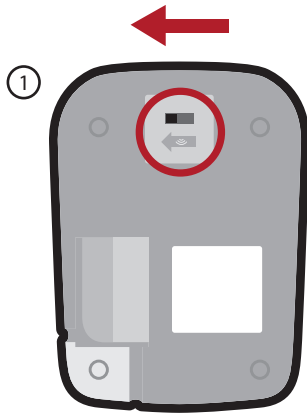

9.0 - Transmitting Batch Data via Bluetooth Communication

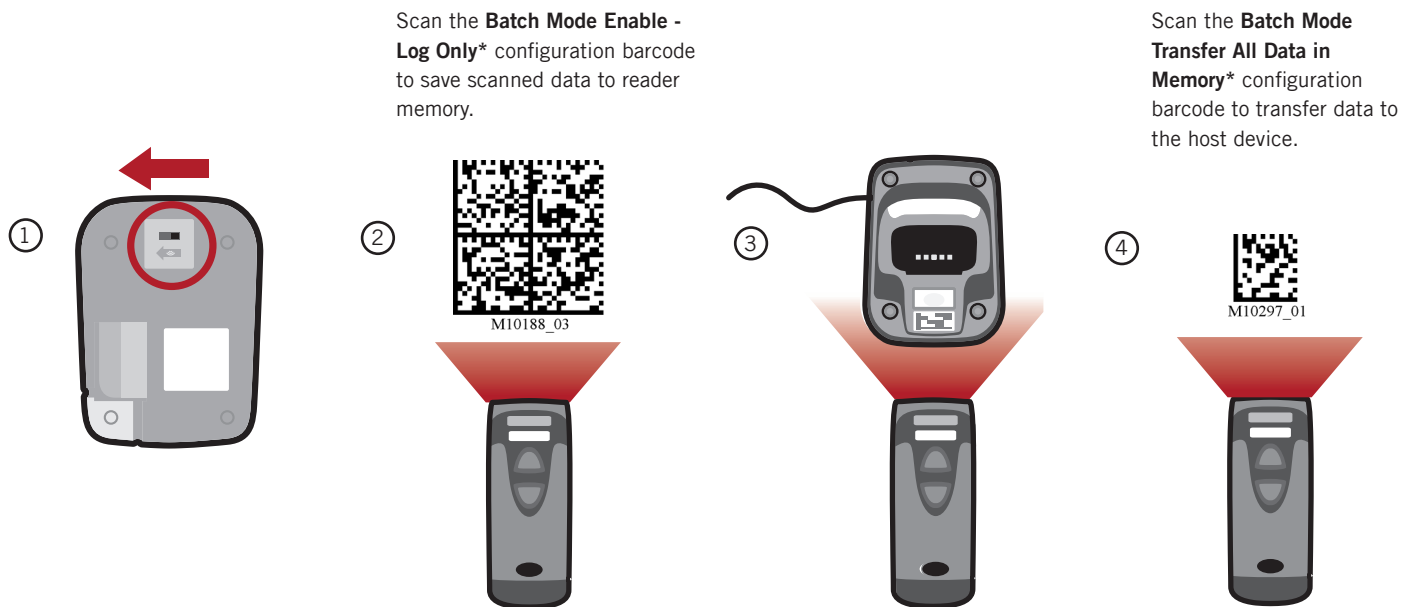

* Additional Batch Mode and Communication configuration options are available in the CR2300 Configuration Guide located at www.codecorp.com/files.php

10.0 - Transmitting Batch Data via USB Communication

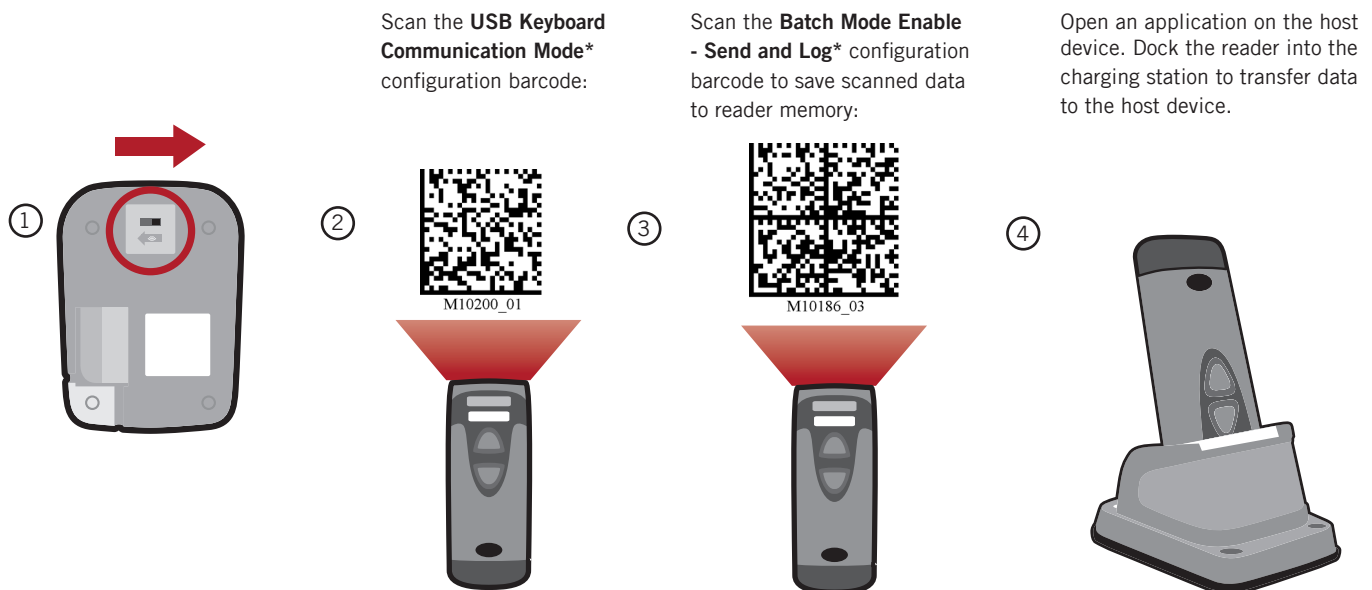





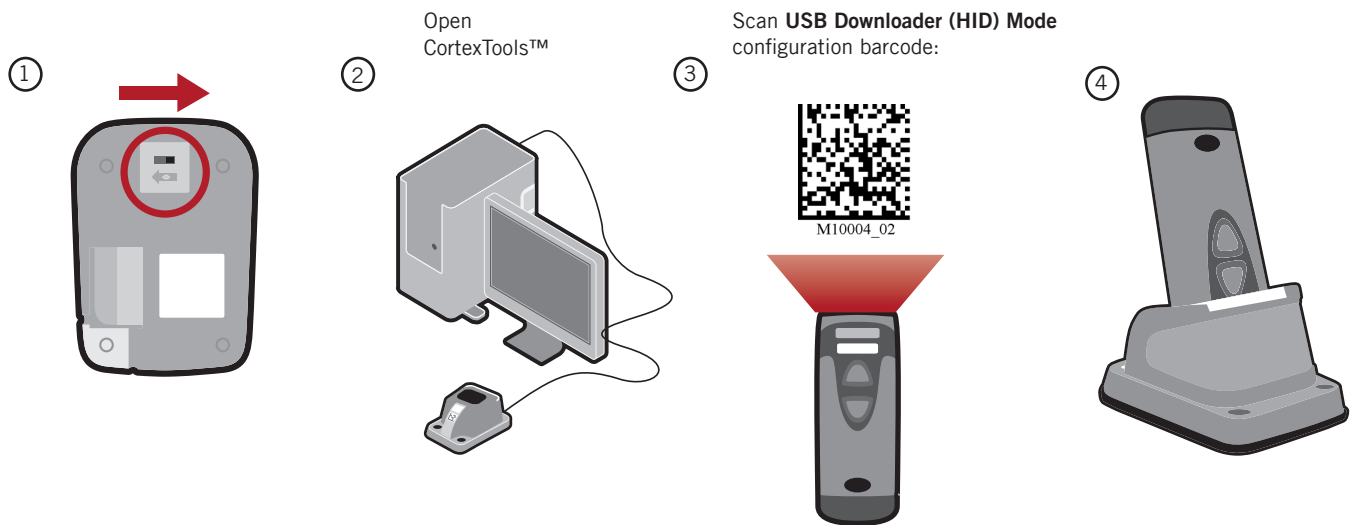









* Additional Batch Mode and Communication configuration options are available in the CR2300 Configuration Guide located at www.codecorp.com/files.php

11.0 - Wired Communication via USB Downloader Mode



12.0 - Reader Feedback

Scenario	LEDs on Reader	Sound
CR2300 Successfully Powers Up	 All LEDs Flash	 1X
CR2300 Successfully Connects with Host	 Wireless Icon Flashes	 1X
CR2300 Unsuccessfully Connects with Host	-	 3X
Successful Decode and Data Transfer	 Good Read Indicator will Flash	 1X
Unsuccessful Decode and Data Transfer	-	 3X
Configuration Code Successfully Decoded and Processed	 Good Read Indicator will Flash	 2X
Configuration Code Unsuccessfully Decoded and Processed	-	 4X
Batch Mode Enabled and No Data is Stored	- Batch Icon Off	-
Batch Mode Enabled and Data Stored	 Batch Icon Remains Solid	-
Memory Space for Batching is Full	 Batch Icon Flashes 5 Times a Second	-
Batch Mode Enabled, Data Stored, and Reader is in Sleep Mode	 Batch Icon Flashes Once Every 10 Seconds	-

13.0 - Reading Ranges

CR2300 Performance		
Test Barcode	Min Inches (mm)	Max Inches (mm)
4 mil Code 39	1.6" (40 mm)	3.1" (78 mm)
7.5 mil Code 39	1.3" (34 mm)	7.2" (182 mm)
9.5 mil Code 128	0.6" (15 mm)	8.3" (212 mm)
10.5 mil UPC	0.8" (20 mm)	9.0" (228 mm)
13 mil UPC	1.1" (28 mm)	11.0" (280 mm)
5 mil Data Matrix	1.7" (43 mm)	3.0" (76 mm)
6.3 mil Data Matrix	1.3" (33 mm)	4.1" (104 mm)
10 mil Data Matrix	0.8" (20 mm)	6.5" (165 mm)
20.8 mil Data Matrix	1.1" (28 mm)	13.5" (343 mm)

Note: All samples were high quality barcodes and were read along a physical center line at a 10° angle. Default AGC settings were used. Accuracy= +/- 10%.

14.0 - Symbologies Defaulted On

The following are symbologies that have a default of ON. To turn symbologies on or off, scan the symbology barcodes located in the CR2300 Configuration Guide located on our website at <http://www.codecorp.com>.

Aztec	All GS1 DataBar
Codabar	Interleaved 2 of 5
Code 39	PDF417
Code 93	QR Code
Code 128	UPC/EAN/UPC-E
Data Matrix	
Data Matrix Rectangle	

15.0 - Symbologies Defaulted Off

The following are symbologies that have a default of OFF. To turn symbologies on or off, scan the symbology barcodes located in the CR2300 Configuration Guide located on our website at <http://www.codecorp.com>.

Codablock F	Micro PDF417
Code 11	MSI Plessey
Code 32	NEC 2 of 5
Composite	Pharmacode
Data Matrix Inverse	Plessey
Han Xin Code	Straight 2 of 5
Hong Kong 2 of 5	Telepen
IATA 2 of 5	Trioptic
Maxicode	Postal Codes
Matrix 2 of 5	



18.0 - Charging Station Dimensions

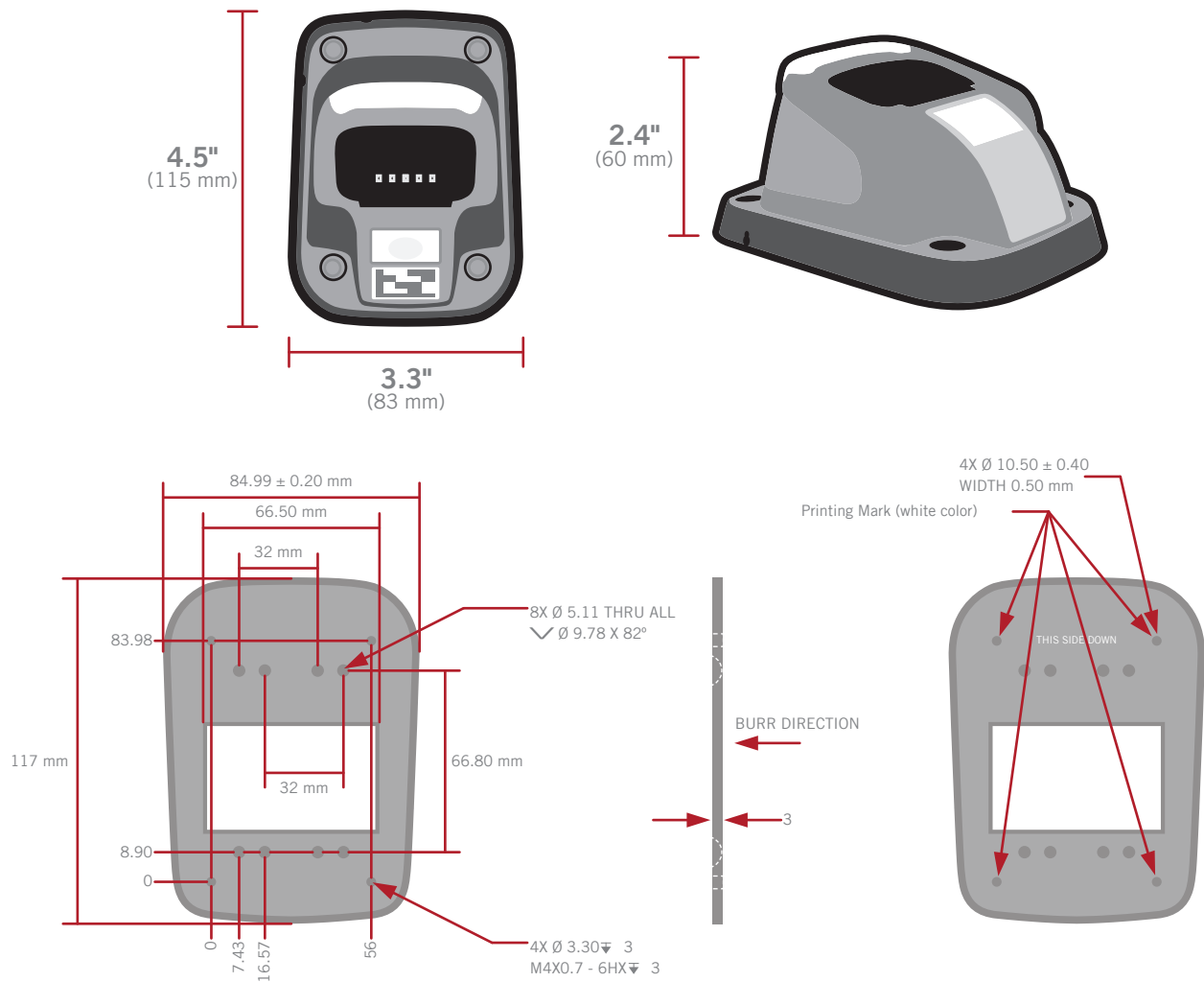

19.0 - CR2300 Maintenance

The CR2300 device needs only a minimum of maintenance to operate. A few tips are given below for maintenance suggestions.

Cleaning the CR2300 Window

CR2300 window should be clean to allow the best performance of the device. The window is the clear plastic piece inside the head of the reader. Do not touch the window. Your CR2300 uses CMOS technology that is much like a digital camera. A dirty window may stop the CR2300 from reading barcodes.

If the window becomes dirty, clean it with a soft, non-abrasive cloth or a facial tissue (no lotions or additives) that has been moistened with water. A mild detergent may be used to clean the window, but the window should be wiped with a water moistened cloth or tissue after using the detergent.

Technical Support and Returns

For returns or technical support visit www.codecorp.com/codesupport.php.

20.0 - Warranty*

The CR2300 carries a one year limited warranty as described herein. Charging Stations, Modems and Batteries carry a one year limited warranty. Cables and Power Supplies carry a 30 day limited warranty.

Limited Warranty. Code warrants each Code product against defects in materials and workmanship under normal use for the Warranty Coverage Term applicable to the product as described at www.codecorp.com/legal/warranty/term.php. If a hardware defect arises and a valid warranty claim is received by Code during the Warranty Coverage Term, Code will either: i) repair a hardware defect at no charge, using new parts or parts equivalent to new in performance and reliability; ii) replace the Code product with a product that is new or refurbished product with equivalent functionality and performance, which may include replacing a product that is no longer available with a newer model product; or ii) in the case of failure with any software, including embedded software included in any Code product, provide a patch, update, or other work around. All replaced products become the property of Code. All warranty claims must be made using Code's RMA process.

Exclusions. This warranty does not apply to: i) cosmetic damage, including but not limited to scratches, dents, and broken plastic; ii) damage resulting from use with non-Code products or peripherals, including batteries, power supplies, cables, and docking station/cradles; iii) damage resulting from accident, abuse, misuse, flood, fire or other external causes, including damage caused by unusual physical or electrical stress, immersion in fluids or exposure to cleaning products not approved by Code, puncture, crushing, and incorrect voltage or polarity; iv) damage resulting from services performed by anyone other than a Code authorized repair facility; v) any product that has been modified or altered; vi) any product on which the Code serial number has been removed or defaced. If a Code Product is returned under a warranty claim and Code determines, in Code's sole discretion, that the warranty remedies do not apply, Code will contact Customer to arrange either: i) repair or replace the Product; or ii) return the Product to Customer, in each case at Customer's expense.

Non Warranty Repairs. Code warrants its repair/replacement services for ninety (90) days from the date of shipment of the repaired/replacement product to the Customer. This warranty applies to repairs and replacements for: i) damage excluded from the limited warranty described above; and ii) Code Products on which the limited warranty described above has expired (or will expire within such ninety (90) day warranty period). For repaired product this warranty covers only the parts that were replaced during the repair and the labor associated with such parts.

No Extension of Term of Coverage. Product that is repaired or replaced, or for which a software patch, update, or other work around is provided, assumes the remaining warranty of the original Code Product and does not extend the duration of the original warranty period.

Software and Data. Code is not responsible for backing up or restoring any of software, data, or configuration settings, or reinstalling any of the foregoing on products repaired or replaced under this limited warranty.

Shipping and Turn Around Time. The estimated RMA turn-around time from receipt at Code's facility to shipment of the repaired or replaced product to Customer is ten (10) business days. An expedited turn-around time may apply to products covered under certain CodeOne Service Plans. Customer is responsible for shipping and insurance charges for shipping Code Product to Code's designated RMA facility and repaired or replaced product is returned with shipping and insurance paid by Code. Customer is responsible for all applicable taxes, duties, and similar charges.

Transfer. If a customer sells a covered Code Product during the Warranty Coverage Term, then that coverage may be transferred to the new owner by written notification from the original owner to Code Corporation at:

CodeOne Service Center
12393 South Gateway Park Place, Suite 600
Draper, UT 84020 USA

Limitation on Liability. Code's performance as described herein shall be Code's entire liability, and the Customer's sole remedy, resulting from any defective Code product. Any claim that Code has failed to perform its warranty obligations as described herein must be made within six (6) months of the alleged failure. Code's maximum liability related to its performance, or failure to perform, as described herein shall be limited to the amount paid by Customer for the Code product that is subject to the claim. In no event will either party be liable for any lost profits, lost savings, incidental damage, or other economic consequential damages. This is true even if the other party is advised of the possibility of such damages.

EXCEPT AS MAY BE OTHERWISE PROVIDED BY APPLICABLE LAW, THE LIMITED WARRANTIES DESCRIBE HEREIN REPRESENT THE ONLY WARRANTIES CODE MAKES WITH RESPECT TO ANY PRODUCT. CODE DISCLAIMS ALL OTHER WARRANTIES, WHETHER EXPRESSED OR IMPLIED, ORAL OR WRITTEN, INCLUDING WITHOUT LIMITATION IMPLIED WARRANTIES OF MERCHANTABILITY, FITNESS FOR A PARTICULAR PURPOSE AND NON-INFRINGEMENT.

THE REMEDIES DESCRIBED HEREIN REPRESENT CUSTOMER'S EXCLUSIVE REMEDY, AND CODE'S ENTIRE RESPONSIBILITY, RESULTING FROM ANY DEFECTIVE CODE PRODUCT.

CODE SHALL NOT BE LIABLE TO CUSTOMER (OR TO ANY PERSON OR ENTITY CLAIMING THROUGH CUSTOMER) FOR LOST PROFITS, LOSS OF DATA, DAMAGE TO ANY EQUIPMENT WITH WHICH THE CODE PRODUCT INTERFACES (INCLUDING ANY MOBILE TELEPHONE, PDA, OR OTHER COMPUTING DEVICES), OR FOR ANY SPECIAL, INCIDENTAL, INDIRECT, CONSEQUENTIAL OR EXEMPLARY DAMAGES ARISING OUT OF OR IN ANY MANNER CONNECTED WITH THE PRODUCT, REGARDLESS OF THE FORM OF ACTION AND WHETHER OR NOT CODE HAS BEEN INFORMED OF, OR OTHERWISE MIGHT HAVE ANTICIPATED, THE POSSIBILITY OF SUCH DAMAGES.

*Warranty periods are North America specific.