

# manual

## strada mp

Progressive control of water flow and pressure via a mechanical internal valve, thus allowing controlled pre-infusion.

La Marzocco's classic paddle interface, manually operated by the Barista.

With dedicated coffee boilers and pressure gauges for each brew group, the Barista benefits by having real time coffee boiler pressure throughout the extraction.



**la marzocco**

handmade in florence

# strada mp

Operating Manual V2.0 - 10/2016  
MAN.8.1.01



**la marzocco**

handmade in florence

## Chapters

1. General Warnings and Safety Specifications	page 3	La Marzocco S.r.l.
2. Definition of Available Models	page 7	Via La Torre 14/H Località La Torre
3. Installation	page 10	50038 Scarperia e San Piero (Firenze) - ITALIA
4. Machine Operation and Coffee Preparation	page 18	<a href="http://www.lamarzocco.com">www.lamarzocco.com</a> <a href="mailto:info@lamarzocco.com">info@lamarzocco.com</a>
5. Dispensing Steam and Hot Water	page 21	T: +39 055 849 191 F: +39 055 849 1990
6. Maintenance and Periodic Cleaning Operations	page 22	
7. De-commissioning and Demolition	page 25	
8. Mandatory Maintenance and Check-up Operations	page 26	
9. Software Programming Guide	page 27	

certifications available:



## 1. General Warnings and Safety Specifications

**WARNING**

This machine is for professional use only and should be installed in locations where its use and maintenance is restricted to trained personnel. Children are forbidden to operate or play with the machine.

**WARNING**

The Coffee machine must be placed in a horizontal position on a counter higher than 80 cm from the ground.

**WARNING**

This machine is not suitable for outdoor use. Jets of water should not be used to clean the machine, nor should it be placed where water jets are used.

**WARNING**

As already mentioned in the preceding notes, the manufacturer shall not be held responsible for damage to objects, animals and/or people whenever the machine has not been installed according to the instructions contained in this manual, and is not used to do what it was designed for (i.e. preparing coffee and hot drinks).

### 1) Important safeguards

- The weighted sound pressure level of the machine is lower than 70dBA.
- Use, cleaning and maintenance of this coffee machine are realized by people (including children more than 8

years of age) with reduced physical, sensory or mental capabilities, or lack of experience and knowledge, as long as they have been given supervision or instructions concerning the use of the appliance by a person responsible for their safety and if they understand dangers.

- Children should be supervised to ensure that they do not play with the appliance.
  - Keep the appliance and its cord out of the reach of children less than 8 years of age.
- 2) This operating manual is an integral and essential part of the product and

must be supplied to users. Users are asked to read the enclosed warnings and cautions carefully, as they provide valuable information concerning safety during installation, operation and maintenance. This manual must be kept in a safe place and be available for consultation to new and experienced users alike.

3) Ensure product's integrity by inspecting the packaging, making sure it presents no signs of damage which might have affected the enclosed machine.

4) Check the machine's integrity after having carefully removed the packaging.

**Note: In case of doubt, do not go on any further and contact your dealer or retailer immediately. They will send out specialized personnel**

**authorized to perform service on the espresso machine.**

5) Packaging (boxes, plastic bags, foam parts and whatever else) must not be left around within easy reach of children, due to the potential danger it represents, nor be discarded in the environment.

6) Check to see that data on the rating plate corresponds to those of the main electrical supply which the machine will be hooked up to.

7) The equipment must be installed to comply with the applicable federal, state or local electrical and plumbing codes. The installation also must comply to the manufacturer's instructions, and must be performed by qualified and authorized personnel.

8) Incorrect installation may cause for injury/damages to people, animals or objects, for which the manufacturer shall not be held responsible.

9) Safe electrical operation of this device will be achieved only when the connection to the power outlet has been completed correctly and in observance of all local, national, and international electrical codes and safety regulations, and particularly by grounding the unit. Make sure grounding has been done properly as it represents a fundamental safety requirement. Ensure qualified personnel check such connection.

10) Furthermore, you must ensure that the capacity of the available electrical system

is suitable for the maximum power consumption indicated on the espresso machine.

**11)** We do not recommend using adapters, multiple plugs and/or extension cords. If you cannot avoid using them, make sure that they are exclusively of the kind which conforms to local, national, and international electrical codes and safety regulations, being careful not to exceed the power and current ratings indicated on such adapters and extension cords.

**12)** This device must be used exclusively for the functions it has been designed and built for. Any other application is inappropriate and dangerous.  
**The manufacturer shall not be held responsible for any damages caused by improper and/or irrational use.**

**This machine should not be installed in kitchens.**

**13)** Using any electrical device requires that certain fundamental rules be observed. In particular:

- do not touch the device with wet or humid hands and feet;
- do not use the device while having no shoes on your feet;
- do not use extension cords in bath or shower rooms;
- do not unplug the device from the power outlet by pulling on the power supply cable;
- do not expose the device to atmospheric agents (rain, sun, etc.);
- do not allow children or untrained people to use this device;
- do not clean the control

panel with a wet cloth since it is not watertight.

**14)** Before carrying out any maintenance and/or cleaning operations, turn the main switch, which is located on the front left of the machine, to the “0” or “OFF” position, and disconnect the machine from the electrical network by unplugging the cord or by switching off the relative circuit breaker. For any cleaning operation, follow exclusively the instructions contained in this manual.

**15)** In case the machine is operating in a faulty manner or breaks down, disconnect it from the electrical network (as described in the preceding point) and close the water supply valve. Do not attempt to repair it. Contact a qualified

and authorized professional to perform any repair. Any repairs must be performed exclusively by the manufacturer or by an authorized centre using only original parts. Non compliance with the above could compromise the safe operation of the machine.

**16) You should plan to make use of an omnipolar connector during installation, as required by local, national, and international electrical codes and regulations.**

**17) In order to avoid dangerous overheating problems, it is recommended that the power supply cable be fully unfurled.**

**18) Do not obstruct air intake and exhaust grilles and, in particular, do not cover the cup warmer tray with cloths or other items.**

**19) The machine's power supply cable must not be replaced by users. In case the power supply cable becomes damaged, shut off the machine and disconnect the machine from the electrical network by switching off the relative circuit breaker and close off the water supply; to replace the power supply cord, contact qualified professionals exclusively.**

**20) Common Dimensions, Weights, and Features**

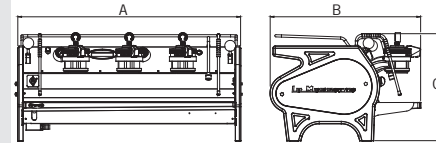

STRADA MP	2 groups	3 groups
A [mm]	800	1000
B [mm]	675	675
C [mm]	475	475
WEIGHT [kg]	70	91

## 2. Definition of Available Models

This operating manual refers exclusively to the following models, of our own manufacture:  
STRADA, Model MP 3 groups

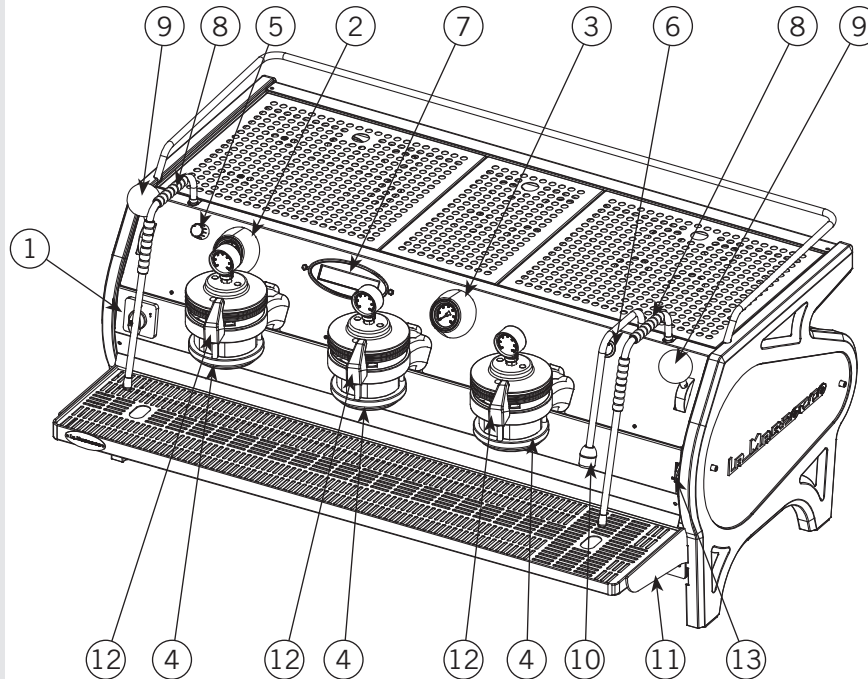

### Legend

- 1** Main Switch
- 2** Pressure Gauge (steam boiler)
- 3** Pressure Gauge (coffee boiler)
- 4** Brew Groups
- 5** Encoder
- 6** Tea Water Button
- 7** Digital Display
- 8** Steam Wand
- 9** Steam Wand Lever
- 10** Hot Water Wand
- 11** Removable Drain Tray
- 12** Manual Brew Paddle Lever
- 13** Hot Water Mix Valve

For additional information on electronics, keypads, and software programming, please see the section entitled Software Programming your Espresso Machine.

**Fig. 1 - Model MP with 2 or 3 groups**

### 1) General Description

The machine is built in 2 and 3 coffee group versions and is essentially composed of the following parts:

- Steam Boiler (produces steam and hot water);
- Coffee (“saturated”) boiler;
- Brewing groups;
- Exterior Cover;
- Water pump.

### 2) Description of the various parts

#### • Steam Boiler

The Steam Boiler consists of a cylindrical tank, of varying length according to the number of coffee groups, which is made of AISI 300 series stainless steel. Each unit is subjected to a hydraulic test, at a pressure of 6 bar, and has an operating pressure of 1.3-1.5 bar. The following is a list of effective volumes and power ratings according to the number of groups installed:

2 groups	8,2 liters	3000 Watts
3 groups	11,8 liters	4000 Watts

Covers are welded at either end of the cylindrical tank and on one of them there is a housing for the water heating element, which allows the steam boiler to reach operating pressure within approximately 25 minutes. Operating pressure is

maintained by temperature probe. The steam boiler has various fittings used for safety devices, for supplying hot water and steam, and for the heating element.

Composed of AISI 300 series stainless steel tube. Heating is accomplished through an immersion-type plated heating element.

- Operating pressure of 1.3-1.5 bar, controlled automatically through a pressure switch or a temperature probe, adjusted to open the heating element supply circuit at 1.5 bar and close it at 1.3 bar.
- The pressure is displayed by means of a pressure gauge with a scale of 0 to 2 bar.
- Safety device, based on an expansion type mechanical valve, with counter-acting spring adjusted to 1.8 bar.
- Testing: hydraulic test at 4.5 bar performed on ready-to-use small boilers, at our factory.

#### • Coffee Boiler

The Coffee Boiler consists of a cylindrical tank made of AISI 300 series stainless steel. One each group (hot water generator for brewing coffee).

Each unit is subject to a hydraulic test, at a pressure of 18 bar, and has an operating pressure of 9 bar. The following

is a list of effective volume and power ratings according to the number of groups installed:

2 groups	2 x 1,3 liters	2 x 800 Watts
3 groups	3 x 1,3 liters	3 x 800 Watts

Covers are installed at either end of the cylindrical tank and on one of them there is housing for the water heating elements. The temperature of the coffee boiler is maintained by an electronic temperature controller (PID capable) with an accuracy of 0.2°C. The brewing groups are installed on the boiler.

Composed of an AISI 300 series stainless steel tube. Heating is accomplished through an immersion-type plated heating element.

- Operating temperature 95°C (adjustable), controlled automatically by an electronic temperature controller with an accuracy of 0.2 °C. Operating pressure of 9 bar, developed mechanically by a special positive-displacement pump which is activated automatically every time coffee is brewed.
- Pressure is displayed through a pressure gauge with a scale from 0 to 15 bar.
- Safety device, based on an expansion type mechanical valve, with counteracting spring adjusted to 13.5 bar.



- **Testing:** Hydraulic test at 18 bar performed on ready-to-use small boilers, at our factory.

- **Brewing groups**

They consist of a precision casting made of stainless steel. The brewing group accepts the portafilter used to hold the ground coffee; the espresso flows through the brewing group, through the portafilter basket, through the portafilter spout, and into the cup(s) after the brewing button has been pressed.

- **Exterior cover**

The exterior consists of painted and stainless sheet steel panels. To provide good aesthetics, to optimize ergonomics for the operator and to reduce the chance of damage to a minimum.

- **Water pump**

The rotary vane pump, is installed on the water supply tubing and is set up to operate anytime the coffee groups are activated, and through an autofill system whenever the water boiler needs to be replenished.

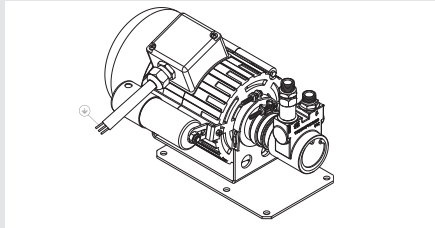

### 3. Installation

MODEL/SERIES	GROUP	V/Hz	RATED POWER (W)	RATED INPUT (A)	COFFEE BOILER WATTAGE	STEAM BOILER WATTAGE	TOTAL WATTAGE	POWER CORD SIZE (mm <sup>2</sup> )
STRADA MP	2GR	AC220-240V/60Hz AC208-240/60Hz AC380/50Hz	4600	20-22 23 12	1600	3000	4600	SEE ELECTRICAL CONNECTIONS FOR DETAILS
	3GR	AC220-240V/60Hz AC208-240/60Hz AC380/50Hz	6400	25-29 30,5 16	2400	4000	6400	

<p><b>POWER CORD:</b></p> <p><b>3 X WIRES 220V</b> 1 X BLUE (NEUTRAL) 1 X BROWN (PHASE) 1 X YELLOW &amp; GREEN (GROUND)</p> 	<p><b>5 X WIRES 380V</b> 1 X BROWN (PHASE) 1 X BLUE (NEUTRAL) 1 X GRAY (PHASE) 1 X YELLOW &amp; GREEN (GROUND) 1 X BLACK (PHASE)</p> 	<p><b>WARNING</b></p> <p>THE DETAILS ON THE LEFT DESCRIBE HOW TO CONNECT EACH WIRE TO THE PLUG. RESPECT ALSO THE LOCAL SAFETY REGULATIONS.</p>
---	--	--

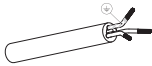
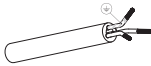

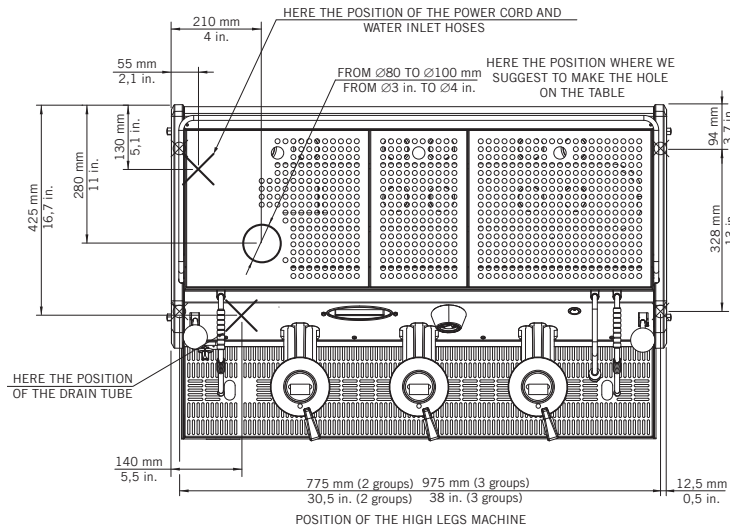
**WARNING**

The machine is intended to be permanently connected to fixed wiring, and it is mandatory that a residual current device (RCD) with a rated residual operating current not exceeding 30mA is installed.

Fig. 2 - Installation guide

**▲ WARNING ▲**

The Coffee Boiler and Steam Boiler contain water at elevated temperature. Water temperature over 125°F / 52°C can cause severe burns instantly or death from scalding (Coffee Boiler 207°F/97°C - Steam Boiler 256°F / 124°C)

**▲ WARNING ▲**

At each installation, the machine should be equipped with a new set of tubes for plumbing and related gaskets.

**▲ WARNING ▲**

Water pressure supply must be between 2 and 6 bar if sufficient pressure is not available we suggest that an additional water supply system is used.

**▲ WARNING ▲**

Hazardous voltage disconnect from power supply before servicing.

**▲ WARNING ▲**

Before making any electrical connections make sure that the two strain relief connectors are firmly secured to the body of the machine in order to prevent inadvertent stress on the power cables.

**▲ WARNING ▲**

The motor pump must be situated close to the machine in an accessible place for maintenance but not for accidental interference and where there is an optimal air circulation.

**▲ WARNING ▲**

Replace fuses with the same size, type and rating F1 = 2A, 250V

**▲ WARNING ▲**

- U.S.A. and CANADA only - Do not connect to a circuit operating at more than 150V to ground on each leg.

**▲ WARNING ▲**

The manufacturer declines any responsibility for any event leading to liability suits whenever grounding has not been completed according to current local, national, and international regulations and electrical codes, or other electrical parts have been connected improperly.

**WARNING**  
This machine should not be installed in kitchens.

**WARNING**  
This appliance is not intended for use by persons (including children) with reduced physical, sensory or mental capabilities, or with lack of experience and knowledge, unless they have been given supervision or instruction concerning the use of the appliance by a person responsible for their safety.

**WARNING**  
This machine is not suitable for outdoor use. Jets of water should not be used to clean the machine, nor should it be placed where water jets are used.

**WARNING**  
In order to prevent cracks or leakage: do not store or install the Coffee machine in places where in boiler or hydraulicsystem to freeze.

**Note:**

- The drinking water mains valve and the circuit breakers for the electrical system need to be located in the most convenient position for the operator to access them easily and quickly.
- The machine should be placed on a flat counter and must be placed in settings with the following temperatures:  
Minimum room temperature: 5°C/41°F  
Maximum room temperature: 32°C/89°F
- If the machine has been temporarily housed in settings with a room temperature of less 0°C/32°F, the machine must be placed in a warmer environment in order to gradually defrost the hydraulic system prior to use.
- Water pressure supply must be between 2 and 6 bar.
- This machine complies with the standard 61000-3-11, the impedance at the supply interface must be  $Z_{max} = 0.11 \Omega$ .

### 1) Installation guide

For best results, STRADA needs a minimum flow of water in input of 100 l/h and a pressure of 2.5 bar.

Installations that do not meet these requirements will cause a shorter life of the pump and may cause a high noise level during coffee brewing.

If the pressure and flow are not adequate, air bubbles may develop within the gears. This is called cavitation. Cavitation can impair the performance of the espresso machine.

If the incoming water of the espresso machine falls outside the recommended parameters, it is necessary to carry out one of the following installations:

#### Pressure lower than 9 bar Flow rate lower than 100 l/h

Installation with the rotary pump immediately after the water treatment system, upstream of the tee.

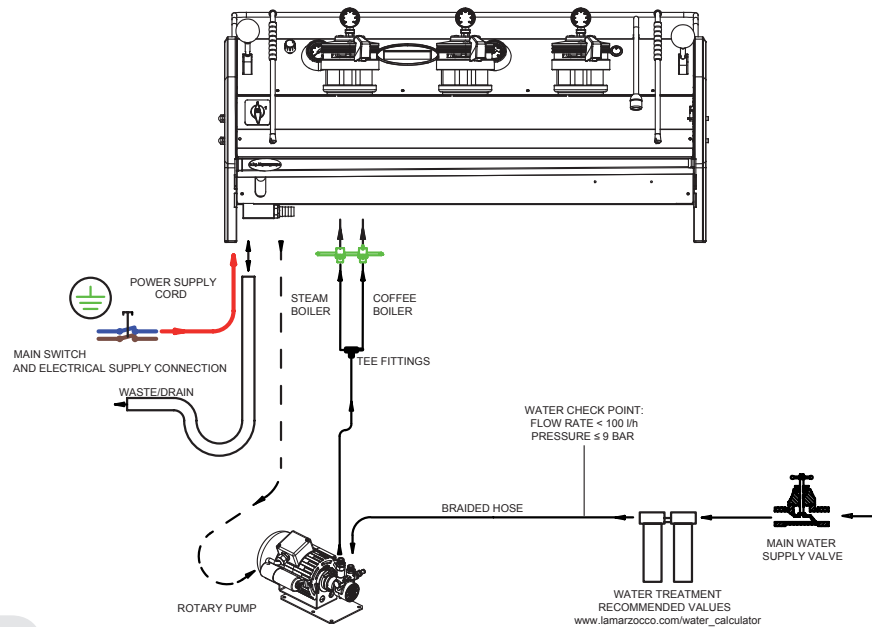
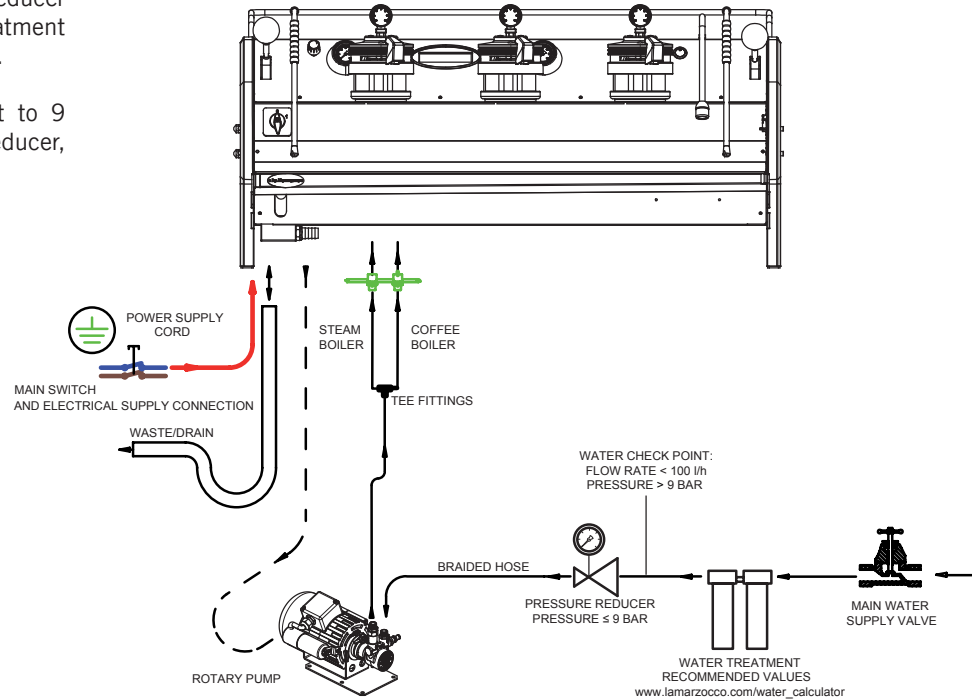

Fig. 3 - Installation guide - type 1

**Pressure higher than 9 bar**  
**Flow rate lower than 100 l/h**

Installation of the pressure reducer immediately after the water treatment system, upstream of the rotary pump.

Installation of the rotary pump (set to 9 bar) immediately after the pressure reducer, upstream of the tee.



**Fig. 4 - Installation guide - type 2**

## 2) Accessories

Check the package to make sure that the following accessories are included:

- a number of 1-dose and 2-dose portafilters corresponding to the number of groups;
- replacement 1-dose and 2-dose filters (one of each);
- 1 tamper;
- 1 blind filter;
- cleaning detergent, for the groups;
- 3 stainless steel braided hoses for water connections;
- 1,5 mt of reinforced plastic tubing for drainage;
- 1 hose clamp;
- 1 TEE Fitting.

In order to proceed with installation, it is necessary that the following are available:

- Pipes carrying drinking water with a 3/8" G (BSP) end connection; (3/8" Compression for USA and Canada)
- Electrical Supply according to the specification of the espresso machine purchased:
- Single/Three phase 220VAC - 50/60 Hz electrical connection with ground, protected socket and approved interlock switch
- Single phase 200VAC - 50/60 Hz electrical connection with ground, protected socket and approved interlock switch

- Three-phase, 380VAC - 50 Hz electrical connection with neutral + ground, near the bench on which the machine is installed and terminating in a suitable protected fivepole socket equipped with an approved interlock switch
- Waste water drain system.

## 3) Water test kit

In order to enable you to check if your water supply is within the suggested ranges, La Marzocco machines will be equipped with two units of a quick water test kit (see image below) including 6 test-strips and instruction cards.

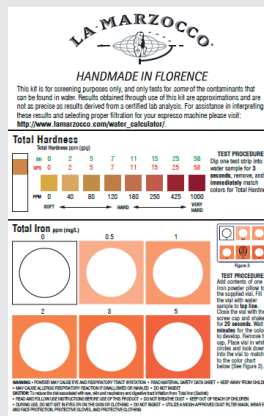

The parameters that you can measure are Total Hardness, Total Iron, Free Chlorine,

Total Chlorine, pH & Total Alkalinity, Chlorides.

Ideally, you should perform a test on the water BEFORE the water treatment system and again AFTER the water system in order to verify if this is actually matching our suggested ranges.

Once the test has been performed, learn which treatment system is most appropriate for your particular water supply by filling out the online water calculator on our website: LA MARZOCCO WATER CALCULATOR ([http://www.lamarzocco.com/water\\_calculator/](http://www.lamarzocco.com/water_calculator/)).

## 4) Water supply connection

In order to connect the machine up to the water mains proceed according to the indications given in the chapter about Installation and in compliance with any local/national safety standards of the location in which the machine is being installed.

To guarantee a correct and safe functioning of the machine and to maintain an adequate performance level and a high quality of the beverages being brewed it is important that the incoming water be of a hardness greater than 7°f (70ppm, 4°d) and less than 10°f (100ppm, 6°d), pH should be between 6.5 and 8.5 and the quantity of chlorides be less than 50mg/l . Respecting these values allows the machine to operate at maximum

efficiency. If these parameters are not present, a specific filtration device should be installed, while always adhering to the local national standards in place regarding potable water.

Then connect the inlet of the water filter/softener (if present) to the drinking water supply using one of the supplied stainless steel braided hoses. Before connecting the filter to the water pump, flush the water supply line and the filtration system in order to eliminate any residual particles which could otherwise get stuck in taps or valves thus preventing them from working properly. Connect the water supply connection of the espresso machine to the water pump outlet using one of the supplied stainless steel braided hoses. Then connect the water pump inlet to the water filter/softener outlet (if present).

**Note:** The water pump is a differential pressure volumetric pump and has been designed to be used exclusively with cold water. Make sure that water is always present while the pump is operating, otherwise air can be introduced into the brew boiler causing an undesirable condition and the pump can be damaged.

## 5) Electrical connections

### a) Power supply cord

This is the main power supply cable that provides power to the entire espresso machine. There are different types of cable based upon the electrical requirements of the espresso machine purchased:

- 200/220VAC 1 Phase 3-core cable with 4/6/10mm<sup>2</sup> cross section or AWG 12/10/8 for 2,3 4 group versions, secured to espresso machine via a strain relief connector
- 220VAC 3 Phase 4-core cable with 4 mm<sup>2</sup> cross section for 2 , 3 and 4 group versions, secured to espresso machine via a strain relief connector
- 380 VAC 3 Phase 5-core cable with 2.5mm<sup>2</sup> cross section for 2, 3 and 4 group versions, secured to espresso machine via a strain relief connector.

### b) Water pump motor power cord

This is the power supply for the water pump motor. The internal electronics will switch the pump motor on when needed.

- 3-core cable with 1.5 mm<sup>2</sup> cross section or 3-core AWG 16 (for UL version) secured to espresso machine via a strain relief connector.

### c) Quick connection between the water pump and the espresso coffee machine

The electrical connection must be made through the use of the connectors, as shown in the following figures:

- View of the connectors;

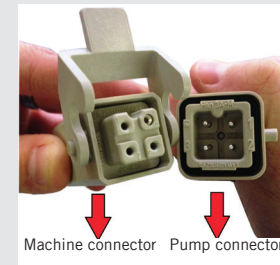

- Cable connection;

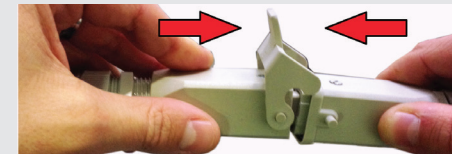

- Cable tightening;

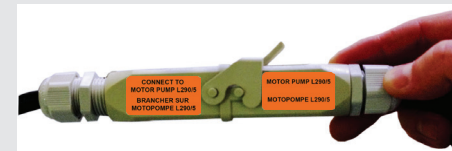



### 6) Waste water drain connection

The espresso machine drain is to be connected by means of the included reinforced plastic tubing. Connect one end of the reinforced plastic tubing to the drain hose connection on the left side of the espresso machine, secure with included hose clamp. Connect the other end to a suitable waste water collection system.

In case such a system is not available, drained liquids may be collected in a suitable bucket and any necessary drain pipe extensions shall be made using steel-lined PVC tubing and suitable hose clamps.

Water specifications table

		Min.	Max.
T.D.S.	ppm	90	150
Total Hardness	ppm	70	100
Total Iron (Fe <sup>+2</sup> /Fe <sup>+3</sup> )	ppm	0	0,02
Free Chlorine (Cl <sub>2</sub> )	ppm	0	0,05
Total Chlorine (Cl <sub>2</sub> )	ppm	0	0,1
pH	value	6,5	8,5
Alkalinity	ppm	40	80
Chloride (Cl <sup>-</sup> )	ppm	not more	50

**N.B.:** Test water quality (the warranty is void if water parameters are not within the range specified in the section "installation")

## 4. Machine Operation and Coffee Preparation

### CAUTION

Never remove the filter holder when water is being delivered. This operation can be extremely dangerous since the high pressure built-up inside the blind filter would spray out hot and slightly caustic water, which may cause severe burns. The Coffee Boiler contains water at elevated temperature. Water temperature over 125°F / 52°C can cause severe burns instantly or death from scalding.

### WARNING

The machine must not be dipped in, nor splashed with, water in order to clean it. For cleaning operations, please follow the instructions listed below very carefully.

### WARNING

This machine is designed only for preparing coffee and hot drinks.

#### IMPORTANT

To improve the flavor of the espresso, the temperature of the water in the coffee boiler and therefore of the groups may eventually be raised or lowered via the digital display (please consult the Software Programming Manual for detailed instructions).

#### 1) Starting the Espresso Machine

##### Filling the Boilers with Water:

Once the installation procedures have been completed, it is necessary to fill the boiler tanks with water. Complete the following procedure to properly fill the boiler tanks:

##### • Coffee Boiler

The water flows inside the coffee boilers directly, as soon as the water system and water filter/softener valves are opened.

Since the inflow of water will compress the air in the boiler, it will be necessary to remove or “bleed” the air from the coffee boilers. All air must be removed in order to completely “saturate” the coffee boiler/group assemblies.

To remove the air from the boiler, or “bleed

the groups”, it will be necessary to remove the plastic cap and the handle from the top of the group.

Loosen the bleed screws one at a time to allow air to escape until water flows from below the screw head. Tighten the screw to stop the water from flowing. Over tightening can cause damage to the sealing washer and the group cover. Repeat this procedure on all groups.

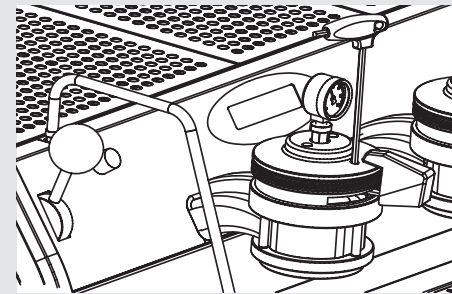

##### • Steam Boiler

Turn the main switch to position “1” or ON, then push the encoder knob for three seconds and the automatic steam boiler level function will be switched on, activating the auto-fill solenoid valve and the motor pump. This will fill the steam boiler to a predetermined level and will shut off when full.

**Note:** Air inside the steam boiler may build up pressure (which may be detected through the pressure gauge).

Once the pump stops, check the display, the message “Coffee Boiler Filled?” should be displayed. Push the Encoder Knob to confirm that the preceding procedures are complete.

The installation is now complete and the espresso machine should be heating to operating temperatures.

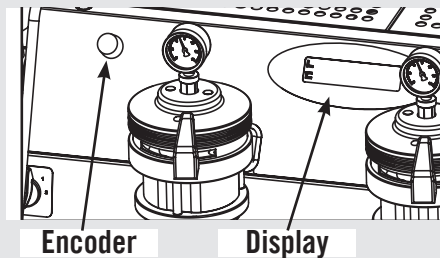

## 2) Waiting for the Espresso Machine to Heat to Operating Temperature

During this time, it may happen that the pointer of the coffee boiler pressure reaches as high as 14-15 bar.

This may happen anytime that the heating element is in the “on” condition. In this case, it is necessary to adjust the expansion valve in such a way that the pressure never exceeds 11-12 bar. In normal operating conditions, the coffee boiler pressure gauges can read anywhere from 0-12 bar. When brewing, the pressure should be set

to 9 bar.

When the steam boiler reaches operating temperature, the light on the Tea dispense button will switch on.

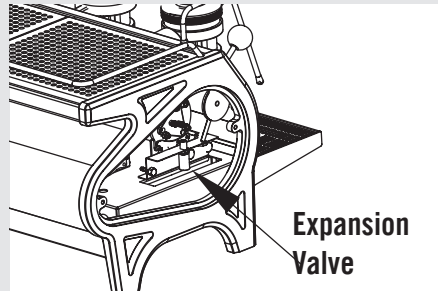

## 3) Installing the Portafilters

Install the portafilter(s) by inserting them into the group and rotate the handle from left to right. When the portafilters are inserted properly, you can press any of the brew buttons to start the flow of water through the portafilter. You should allow hot water to pass through the portafilter(s) for a few seconds each time, in order to pre-heat the portafilter.

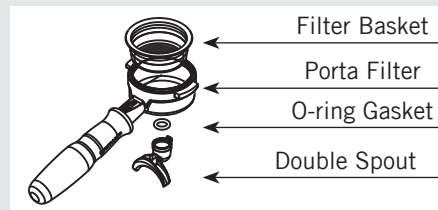

**Note:** It is important to leave the portafilters installed in the espresso machine when not in use. The portafilter must remain heated for the brew process to function correctly.

## 4) Brewing Coffee with/out Pre-Infusion

It is now possible to remove one of the portafilters to make an espresso beverage. Place some ground coffee in the filter itself: 1 dose (approximately 7 g) for the small filter, 2 doses (approximately 14 g) for the larger filter.

Press down on the ground coffee with the supplied tamper and install the filter holder to the bottom of the group. Move the paddle to begin the brewing process. Mechanically control water and pressure flow through an internal valve to obtain superior cup quality traditionally achieved with “lever” machines. Manual pre-infusion allows you to bring out different flavor components which affect the balance and body of the shot, and produce rounder, softer espresso that highlights brightness, sweetness and delicacies note.



**Note:** Some baristas suggest flushing the group with water to remove remaining coffee oil or particles. Some flush after every shot. Experimentation and practice is suggested to establish the best possible procedure for brewing coffee.

#### **5) General Notes for Coffee Preparation**

The portafilters must remain heated since they are partially isolated from the group due to the rubber gasket between them. This can be accomplished by leaving the portafilters installed on the machine when not in use. The portafilters may also be actively heated. This procedure may be carried out by activating one of the brew buttons to flush hot water through the portafilter then turning off the water flow.

Other than the type of coffee blend being used, naturally, the size of the coffee granules is extremely important in the preparation of a good cup of coffee. Ideal grinding can be determined by making various coffees using the amount of ground coffee that you would normally use for each cup (we recommend at least 6g). The most suitable grinding allows coffee to flow gradually from the filter holder spout - neither too slowly, nor too quickly. A general rule is that a double dose should dispense approximately 2 fluid oz. of espresso in approximately 25 seconds.

## 5. Dispensing Steam and Hot Water

### 1) Steaming milk or other liquids

In order to allow for any condensed water in the wand to be released ALWAYS allow some steam to be discharged by turning on the valve before inserting the steam wand into the pitcher of liquid to be heated.

Dip one of the 2 steam wands (part 8, page 7) which are connected to the steam valve, into the liquid to be heated, turn the steam knob gradually until steam comes out at the end of the wand.

The steam will transfer heat to the liquid raising its temperature up to boiling point. Be careful not to allow liquid to overflow in order to avoid severe burns.

In order to prevent the heated liquid from being sucked back into the steam boiler it is recommended before using the wand that you purge the steam valve and steam wand by opening the valve for a few seconds to allow steam to escape to the atmosphere from the end of the steam wand. Failure to do so can cause the heated liquid to transfer from the heated liquid container to the steam boiler

(via vacuum created from cooling parts). This condition is undesirable and can cause contamination in the steam boiler. After use remember to purge the wand by opening the steam valve for a few seconds, and then clean the outside of the wand itself with an appropriate cloth.

In order to prepare milk for making cappuccino with the right amount of foam, go through the following steps:

- After purging the steam wand place the container half-full of milk underneath, carefully open the steam valve and raise the container so as to bring the wand end to a point just below the surface of the milk; at this point, move the container up and down just enough to dip the nozzle end in and out of the milk until you get the right amount of foam, bring the temperature of the milk almost up to 149/158°F or 65/70°C. You can then pour this milk into a cup containing warm espresso and you will end up with a fresh cup of cappuccino.

### 2) Preparing tea and other hot drinks.

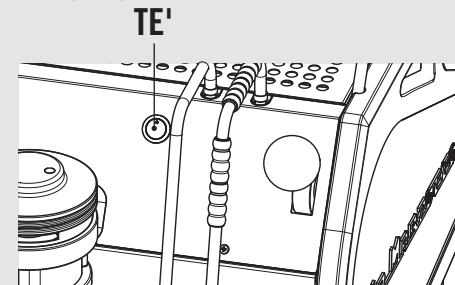

You may dispense hot water by using the fixed nozzle (part 10, page 7). To dispense hot water, press the tea water button.

This button commands hot water delivery. The temperature of the water may be adjusted by adjusting the mixing valve.

## 6. Maintenance and Periodic Cleaning Operations

**▲ WARNING ▲**

Jets of water should not be used to clean the machine, nor should it be placed where water jets are used.

**▲ WARNING ▲**

This machine is for professional use only and should be installed in locations where its use and maintenance is restricted to trained personnel.

**▲ WARNING ▲**

The machine is intended to be permanently connected to fixed wiring, and it is mandatory that a residual current device (RCD) with a rated residual operating current not exceeding 30mA is installed.

**▲ WARNING ▲**

The machine must be installed so that qualified technical personnel can easily access it for eventual maintenance.

**▲ WARNING ▲**

The machine must not be dipped in, nor splashed with, water in order to clean it. For cleaning operations, please follow the instructions listed below very carefully.

**▲ WARNING ▲**

Do not remove the filter holder while relative group is brewing hot liquids.  
The Coffee Boiler contains water at elevated temperature. Water temperature over 125°F / 52°C can cause severe burns instantly or death from scalding.

**▲ WARNING ▲**

In order to prevent cracks or leakage: do not store or install the coffee machine in places where temperature may cause water in boiler or hydraulic system to freeze.

**▲ WARNING ▲**

If the above-mentioned instructions are not adhered to the manufacturer cannot be held responsible for damage to persons or things.

### 1) Cleaning groups and drain wells

- Put a tablespoon of detergent powder for coffee machines into the blind filter, supplied with the machine, and tighten it onto the group you want to clean by using a normal filter holder.

- Turn the Paddle Valve on and off approximately 10 times (10 seconds intervals) on each group.
- Rinse the group using a normal filter by running hot water through it several times.

### 2) Cleaning filters

- Put 2 or 3 teaspoons of detergent powder for coffee machines in about 1/2 a litre of water inside a heat-resistant container and boil.
- Dip filters in the boiled solution and leave them fully submerged for about 30 minutes.
- Rinse thoroughly with clean water and run hot water through one group several times with the filters in place.
- Make one cup of coffee and discard in order to remove any unpleasant flavor.

### 3) Cleaning filter holders (portafilters)

Using the proper cleaning tool (brush) wash the filter holders under hot water, a neutral detergent may also be used. For extraordinary cleaning see the Portafilter Manual.

### 4) Cleaning the drain collector

Remove the drain tray grill at least twice a week and clean, pull out the water drain collector and clean it thoroughly. Inspect and clean also the drain box and remove any leftover grounds.

### 5) Cleaning the body

Wipe the stainless steel surfaces with a soft, non abrasive cloth in the direction of the glazing marks, if any. Do not use any alcohol or solvents whatsoever on painted or imprinted parts in order not to damage them.

### 6) Cleaning the hot water and steam nozzles

Steam nozzles must be cleaned immediately after use with a damp cloth and by producing a short burst of steam so as to prevent the formation of deposits inside the nozzles themselves, which may alter the flavor of other drinks to be heated. Hot water nozzles must be cleaned periodically with a damp cloth.

### 7) Cleaning the diffuser screen

- Due to filter holder discharge operations (subsequent to coffee brewing), a certain amount of coffee grounds may slowly build-up on and obstruct, even partially, the diffuser screen. To clean it, you must first remove it by unscrewing the diffuser screw.

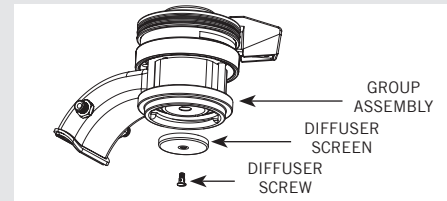

- Put 2 or 3 teaspoons of cleaning detergent for coffee machines in about 1/2 a litre of water inside a heat-resistant container and boil.
- Place the diffuser screen(s) and diffuser screw(s) in the solution and leave them fully submerged for about 30 minutes. Rinse thoroughly with clean water. Install and run hot water through each group several times with the screen installed.

### 8) Water Filter/Softener

Please see the documentation accompanying the water filter/softener for proper operating and cleaning instructions.

If the machine has not been used for more than 8 hours or, in any case, after long periods of being idle, in order to use the machine to its full potential it is necessary to perform some cleaning cycles before brewing beverages as follows:

- **Groups:** with the portafilters engaged in the groups brew water through each for at least two minutes
- **Steam:** Being careful to avoid burns, turn on each steam wand for at least one

minute.

- **Hot water:** Turn on the hot water valve for the time necessary to allow the following quantities of water to be brewed:
  - At least 1 liter for a 1/2 group machine
  - At least 2 liters for a 3 group machine
- **Steam boiler draining:** to activate this function you need to access the programming menu (see p. 41). Yearly, we recommend to fully drain the steam boiler by means of the specific drain cock located on the side of the boiler or under the boiler.

#### 9) Depressurize the steam boiler

Press and hold the encoder knob to set the espresso machine to “OFF”, then push down the steam lever in order to depressurize the steam boiler.

#### **IMPORTANT**

If the machine has not been used for more than 8 hours or, in any case, after long periods of being idle, in order to use the machine to its full potential it is necessary to perform some cleaning cycles before brewing beverages as follows:

- Groups: with the portafilters engaged in the groups brew water through each for at least two minutes
- Being careful to avoid burns, turn on each steam wand for at least one minute.
- Turn on the hot water valve for the time necessary to allow the following quantities of water to be brewed:

At least 1 liter for a 1/2 group machine

At least 2 liters for a 3 group machine

If the machine is not going to be used for long periods of time, it is advisable to follow these safety indications:

- Disconnect the machine from the water mains or interrupt the water connection via a mains tap.
- Disconnect the machine from the electrical mains.



## 7. De-commissioning and Demolition

### 1) De-commissioning and demolition

Start by setting the main switch to the “0” or OFF position.

#### Disconnecting from the power outlet

Disconnect the espresso machine from the electrical network by switching off the associated circuit breaker or circuit protection device. Remove the power supply cord from the power connection. Remove the Pump Motor Power Cord from the water pump motor.

#### Disconnecting from the water system

Shut off the water supply by closing the specific tap located upstream of the water filter/softener inlet. Disconnect the water pipe at the water filter/softener inlet. Remove the hose connecting the espresso

machine to the water pump. Remove the reinforced plastic tubing on the drain connection.

At this point, the machine may be removed from the bar, being very careful not to drop it or squash your fingers.

The machine is made out of various materials and therefore, if you do not intend to put it back in service, it must be taken to a special disposal company which will select the materials which can be recycled and discard the others.

Current regulations make it illegal to discard such machine by leaving it on public grounds or on any private property.

#### Recycling notice: Warning for the protection of the environment.

Used Electrical and electronic waste contains hazardous but also valuable and scarce materials which should be recovered and recycled properly. We kindly ask that you contribute to the protection of the environment and natural resources by delivering used equipment to the relevant recycling locations if such locations are available in your country.



## 8. Mandatory Maintenance and Check-up Operations

---

These operations are in addition to the Maintenance and Periodic Cleaning Operations as specified in Chapter 6.

The following maintenance and check-up operations should be carried out by a qualified technician.

The time required for the periodic maintenance is determined by the quantity of daily work and/or coffee consumption.

**N.B. These periodic maintenance operations are not covered by warranty.**

### EVERY THREE/FOUR MONTHS

- Replace group gaskets
- Replace diffuser screens
- Clean auto-fill probe
- Check vacuum breaker for proper operation
- Inspect water inlet valve
- Inspect drain system for leaks or clogs
- Check flow rate for each group
- Check brew temperature
- Check that brew pressure is at correct
- Check all switches for proper operation
- Check/note water hardness (Water quality must be within the range of parameters specified in the chapter on Installation, otherwise warranty is voided)
- Check filter basket condition

---

### EVERY YEAR (in addition to the above)

- Replace portafilter baskets
- Inspect group valve plungers
- Inspect vacuum breaker
- Inspect expansion valve
- Inspect electrical wiring condition
- Inspect boilers safety switches
- Replace over-pressure valve (safety valve)
- Accurate control of the tightness at 2,4Nm of each cable on the terminal block.
- Disassembly and lubrication of the components of the MP valve

---

### EVERY 3 YEARS (in addition to the above)

- Check the condition of the inside of boilers and if necessary rinse out with a proper cleaning product allowed for food and beverage appliances.

## 9. Software Programming Guide

### Programming Introduction

Digital Display	page 28
Programming Encoder	page 29
Start Up Procedures	page 30
Shut Down Procedures	page 31
Tea Dose	page 32
Accessing Programming Mode	page 33

### “Barista” Programming

Coffee Boiler	page 34
Cup Warmer	page 35
Dose Counter	page 36
Clock Adjust	page 37
Auto ON/OFF	page 38

### “Technical” Programming

Language	page 39
Open Valve	page 40
Drain Steam Boiler	page 41
Safety Valve	page 42
Coffee Boiler	page 43
Temperature Measurement Units	page 44
Dose Counter	page 45
Filter Alarm	page 46
Steam Boiler	page 47
Tea Brewing	page 49
Coffee Boiler	page 50
Steam Boiler Temperature	page 52
Cup Warmer	page 53
Dose Counter	page 54
Clock Adjust	page 55
Auto ON/OFF	page 56

## Programming Introduction

### Description

- This espresso machine has a CPU and many configurable settings.
- Additionally, there are many feedback controls employed in this espresso machine to troubleshoot problems should they occur.
- The following is a brief introduction to the controls and display and how they interact with the operator.

## Digital Display

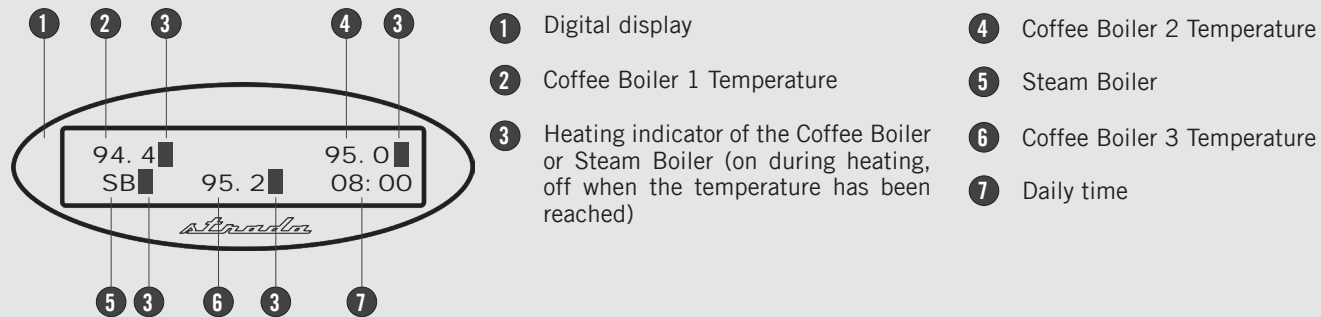

The digital display is a backlit display capable of displaying 2 lines of 16 characters. The display enables the operator to interact with the espresso machine to visibly change parameter values. The display also provides valuable information to the operator.

There are several warnings that can be displayed to alert the operator of an unusual condition or a fault. Additionally, simple messages are displayed alerting the operator that an action has been started or that a process needs to begin.

## Programming Encoder

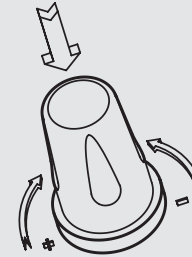
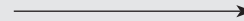
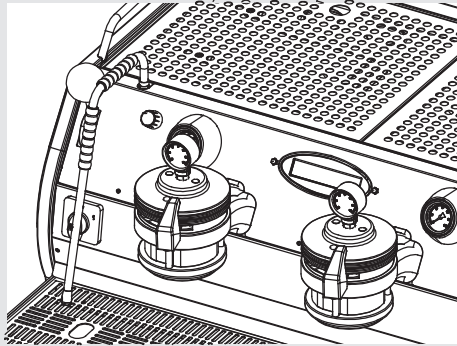

The encoder knob is always located on the left of group one. By turning it to the right it is possible to increase the value. By turning it left, it is possible to decrease the value and by pushing it down, it is possible to scroll through the software menu, enter functions or confirm first installation.

It is possible to turn on/off the Strada coffee machine by pushing and holding the Encoder knob for 3 seconds.

## Start Up Procedures

### Turning the Espresso Machine On

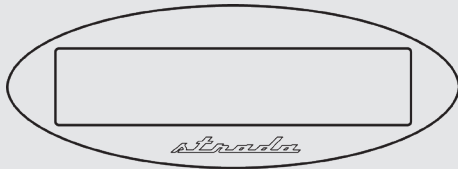





#### Description

The following is the procedure for turning on the power to the espresso machine.

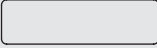
- Please follow the procedures carefully to avoid any damage to the espresso machine.

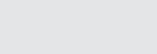
- Proceed checking for water connection to the espresso machine.
- Proceed making sure you have filled the boilers.

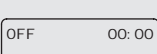
Display	Operating Procedure
	Turn the Main Switch to the ON position. (ON=1, OFF=Ø)
	<b>1</b> 
	<b>2</b> The message at left will be displayed briefly. This message indicates the revision level of the software installed in this espresso machine.
	<b>3</b> Press and hold the Encoder Knob for 3 seconds.
	<b>4</b> The espresso machine is now ON and information concerning the boiler and heating elements will appear.

**WARNING**
  
**HAZARDOUS VOLTAGE DISCONNECT FROM POWER SUPPLY BEFORE SERVICING**

## Shut Down Procedures

### Turning the Espresso Machine Off

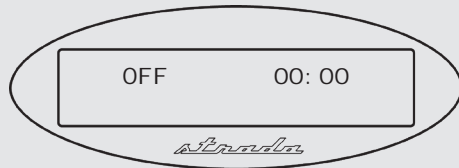

#### Description

The following is the procedure for turning off power to the espresso machine.

- Please follow the procedures carefully to avoid any damage to the espresso machine.

- This machine has two off settings. One setting turns off all of the components in the espresso machine and the other turns off power to the complete espresso machine.

Display	Operating Procedure
<div data-bbox="213 708 366 751"> <p>94.4    95.1 SB   95.2   00:00</p> </div> <div data-bbox="213 780 366 823"> <p>OFF    00:00</p> </div> <div data-bbox="213 935 366 979"> <p> </p> </div>	<ol style="list-style-type: none"> <li data-bbox="398 646 1218 672">1 The following is the procedure for safely turning off the espresso machine.</li> <li data-bbox="398 718 1342 744">2 Press and hold the Encoder Knob for 3 seconds. The display changes to the following:</li> <li data-bbox="398 786 1113 813">3 This is the OFF setting used in the normal operating conditions.  During servicing or other conditions that warrant it, the main switch should be turned to the OFF position.  The espresso machine is off and display should be blank. It is important to follow this procedure when turning off the machine. Failure to do so can damage the electronics.</li> <li data-bbox="398 944 416 971">4</li> </ol> <div data-bbox="816 984 1188 1067"> <p>The diagrams show the encoder knob in four states: 1. Position 0 with a '0' above and '1' to the right. 2. Position 1 with a '0' above and '1' to the right. 3. Position OFF ON with 'OFF' above and 'ON' to the right. 4. Position OFF ON with 'OFF' above and 'ON' to the right.</p> </div>

**WARNING**  
HAZARDOUS VOLTAGE DISCONNECT FROM POWER  
SUPPLY BEFORE SERVICING

## Programming Tea Dose

### Tea Dose

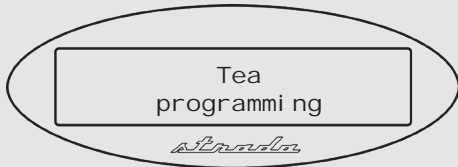

### Description

- This parameter allows the operator to program the amount of water (brewing amount) for the tea button.

Display	Operating Procedure
<p>94.4      95.1 SB 95.2   00:00</p>	<p><b>1</b> When the espresso machine is turned on, press and hold the tea button (item 6, page 7). After about 10 seconds the following screen is displayed.</p>
<p>Tea programm ing</p>	<p><b>2</b> To set the brewing time, press the tea button to start, and then press it again to stop when the desired dose is achieved.</p>



## Accessing Programming Mode

### Programming Mode

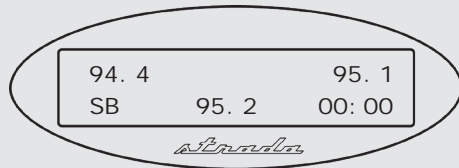



### Description

- To change the values of any parameter the operator must first enter into the programming mode.
- There are two levels within the programming mode that allow the programming of specific parameters.
- The two programming levels are as follows:
- **Barista Programming** - The parameters contained within this level are ones the operator can change to affect the

quality of the espresso.

No password is required for access.

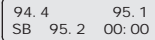
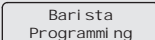
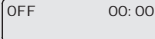
- **Technical Programming** - The parameters contained within this level are ones the operator can change to affect the performance of the espresso machine. These parameters are set in the factory and their adjustment requires the intervention of a service technician La Marzocco recommends that no changes are made at this level. The Technician Password is required for access.

Display	Operating Procedure
 	<p style="text-align: center;"><b>“Barista” Programming Level</b></p> <ol style="list-style-type: none"> <li>1 While the espresso machine is ON, press and hold the Encoder Knob. After approximately 10 seconds the following display appears.</li> <li>2 This is the “Barista” programming level. To set the coffee boilers, to enable/disable the resistance of the cup warmer if present, and etc..</li> <li>3 To exit the programming mode, scroll the menu, using the the Encoder Knob.</li> </ol>
 	<p style="text-align: center;"><b>“Technical” Programming Level</b></p> <ol style="list-style-type: none"> <li>1 While the espresso machine is OFF, press and hold the Encoder Knob. After approximately 10 seconds the following display appears.</li> <li>2 This is the “Technical” programming level. Using the Encoder Knob to move between the available parameters, press the Encoder Knob to confirm.</li> </ol> <p><b>Note:</b> You must scroll to the menu to exit the programming mode.</p>

## “Barista” Programming

### Coffee Boiler

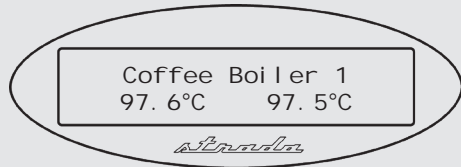

### Description

- This parameter allows the operator to program the coffee boiler temperature. Each group can have a different programming.

Display	Operating Procedure
	<b>1</b> While the espresso machine is ON, press and hold the Encoder Knob. After approximately 10 seconds the following display appears.
	<b>2</b> Releasing the Encoder Knob the following display appears.
	<b>3</b> Rotate the Encoder Knob to set the desired temperature, press the Encoder Knob to confirm the value. Continue with the programming of the other parameters.
	<b>4</b> To exit the programming mode, scroll the menu, using the the Encoder Knob.



### DANGER



**THE COFFE BOILER CONTAINS WATER AT ELEVATED TEMPERATURES. WATER TEMPERATURE OVER 52°C CAN CAUSE SEVERE BURNS INSTANTLY OR DEATH FROM SCALDING.**

## “Barista” Programming

### Cup Warmer



### Description

- This parameter allows the technician to enable or disable the cups heating function.
- This function is displayed only on the models of espresso machine equipped with this accessory.

Display	Operating Procedure
<div style="border: 1px solid black; padding: 2px; width: fit-content;">           94.4      95.1            SB 95.2   00:00         </div>	<b>1</b> While the espresso machine is ON, press and hold the Encoder Knob. After approximately 10 seconds the following display appears.
<div style="border: 1px solid black; padding: 2px; width: fit-content; text-align: center;">           Barista            Programmi ng         </div>	<b>2</b> Releasing the Encoder Knob the following display appears.
<div style="border: 1px solid black; padding: 2px; width: fit-content;">           Coffee Boiler 1            97.6°C      97.5°C         </div>	<b>3</b> Press the Encoder Knob until the following display appears.
<div style="border: 1px solid black; padding: 2px; width: fit-content; text-align: center;">           Cup heating            ON         </div>	<b>4</b> Rotate the Encoder Knob to select ON or OFF, press the Encoder Knob to confirm the option and continue with the programming of the other parameters.
<div style="border: 1px solid black; padding: 2px; width: fit-content;">           94.4      95.1            SB 95.2   00:00         </div>	<b>5</b> To exit the programming mode, scroll the menu, using the the Encoder Knob.

## “Barista” Programming

### Coffee Dose Counter

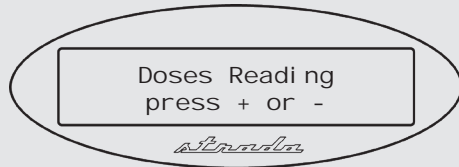

### Description

- This parameter allows the operator to view the quantity of coffee and tea doses.
- This parameter displays different values:
  - Coffee doses for each group;
  - Tea doses.

Display	Operating Procedure
	<b>1</b> When the espresso machine is turned on, press and hold the Encoder Knob. After about 10 seconds the following screen is displayed.
	<b>2</b> Releasing the Encoder Knob the following display appears.
	<b>3</b> Press the Encoder Knob until the following display appears.
	<b>4</b> Rotate the Encoder Knob to display the doses of each group and of the tea.
	<b>5</b> To exit the programming mode, scroll the menu, using the the Encoder Knob.

## “Barista” Programming

### Clock Adjust

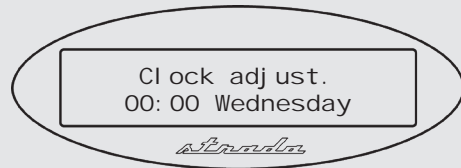

### Description

- This parameter allows the user to set the time of day and the day of the week.
- This parameter is used to display time and is also used by the “Auto On/Off” parameter.
- There are 3 changeable values within this parameter:
  - Hour;
  - Minute;
  - Day of week.

Display	Operating Procedure
	<b>1</b> When the espresso machine is turned on, press and hold the Encoder Knob. After about 10 seconds the following screen is displayed.
	<b>2</b> Releasing the Encoder Knob the following display appears.
	<b>3</b> Press the Encoder Knob until the following display appears.
	<b>4</b> The first value will blink, use the Encoder Knob to set the clock and continue with the programming of the other parameters, press the Encoder Knob to confirm the value.
	<b>5</b> To exit the programming mode, scroll the menu, using the the Encoder Knob.

## “Barista” Programming

### Auto ON/OFF

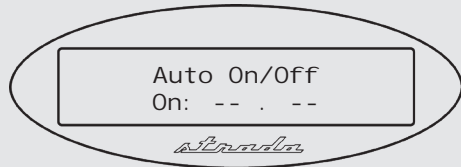

### Description

- This parameter allows the technician to program the espresso machine to turn on at a preset time and turn off at a preset time.
- This feature also allows the espresso machine to remain in the off condition for one closed day.

Display	Operating Procedure
<div style="border: 1px solid black; padding: 2px; width: fit-content;">                     94.4      95.1                      SB 95.2   00:00                 </div>	<b>1</b> While the espresso machine is OFF, press and hold the Encoder Knob. After approximately 10 seconds the following display appears.
<div style="border: 1px solid black; padding: 2px; width: fit-content; text-align: center;">                     Barista                      Programmi ng                 </div>	<b>2</b> Releasing the Encoder Knob the following display appears.
<div style="border: 1px solid black; padding: 2px; width: fit-content;">                     Coffee Boiler 1                      97.6°C      97.5°C                 </div>	<b>3</b> Press the Encoder Knob until the following display appears.
<div style="border: 1px solid black; padding: 2px; width: fit-content;">                     Auto On/Off                      On: ---                 </div>	<b>4</b> If the parameter is not set the espresso machine will be always turn on, move with the Encoder Knob o set the desired time, press the Encoder Knob to confirm the value and continue with the programming of the other parameters. Repeat this operation to set the other parameters.
<div style="border: 1px solid black; padding: 2px; width: fit-content;">                     Auto On/Off                      Off: ---                 </div>	
<div style="border: 1px solid black; padding: 2px; width: fit-content; text-align: center;">                     Closed On                      -----                 </div>	
<div style="border: 1px solid black; padding: 2px; width: fit-content;">                     94.4      95.1                      SB 95.2   00:00                 </div>	<b>5</b> To exit the programming mode, scroll the menu, using the the Encoder Knob.

### Language

### Description

- This parameter allows the technician to change the language of the display.



Display	Operating Procedure
	<b>1</b> While the espresso machine is OFF, press and hold the Encoder Knob. After approximately 10 seconds the following display appears.
	<b>2</b> Releasing the Encoder Knob the following display appears.
	<b>3</b> Rotate the Encoder Knob to select a language, press the Encoder Knob to confirm the option.
	<b>4</b> To exit the programming mode, scroll the menu, using the the Encoder Knob.

## “Technical” Programming

### Open Valve



### Description

- This parameter allows the service staff to enable/disable the opening of the hot water valve.
- This parameter allows steam boiler depressurization.

Display	Operating Procedure
	<b>1</b> When the espresso machine is turned off, press and hold the Encoder Knob. After about 10 seconds the following screen is displayed.
	<b>2</b> Releasing the Encoder Knob the following display appears.
	<b>3</b> Press the Encoder Knob until the following display appears.
	<b>4</b> Rotate the Encoder Knob to select ENABLED or DI SABLED, press the Encoder Knob to confirm the option.
	<b>5</b> To exit the programming mode, scroll the menu, using the the Encoder Knob.



## “Technical” Programming

### Drain Steam Boiler

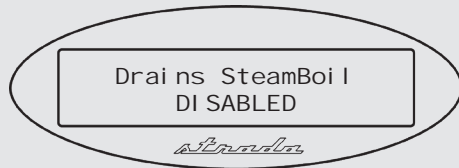

#### Description

- This parameter enables the technician to enable/disable the steam boiler draining.
- This parameter allows the service staff to renew or “regenerate” the water contained inside the steam boiler, discharging about one half of the water contained in the boiler.
- This procedure is recommended in case the machine should remain inactive for more than 8 hours and in any case at least on a weekly basis.

Display	Operating Procedure
	<b>1</b> When the espresso machine is turned off, press and hold the Encoder Knob. After about 10 seconds the following screen is displayed.
	<b>2</b> Releasing the Encoder Knob the following display appears.
	<b>3</b> Press the Encoder Knob until the following display appears.
	<b>4</b> Rotate the Encoder Knob to select ENABLED or DI SABLED, press the Encoder Knob to confirm the option.
	<b>5</b> To exit the programming mode, scroll the menu, using the the Encoder Knob.

## “Technical” Programming



### Safety Valve

TEST SAFETY VALV  
DI SABLED

*Starbucks*

### Description

- This parameter allows the service staff to enable/disable the safety valve test.
- This parameter allows to bring the steam boiler temperature to 140°C, thus triggering the safety valve. Once the valve has triggered disable the function.
- Should the safety valve fail to trigger within approximately one minute of the temperature reaching 140°C, disable the function and replace the valve.
- Only qualified technicians can perform this operation.

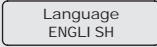
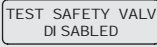
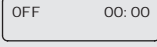
Display	Operating Procedure
	<b>1</b> When the espresso machine is turned off, press and hold the Encoder Knob. After about 10 seconds the following screen is displayed.
	<b>2</b> Releasing the Encoder Knob the following display appears.
	<b>3</b> Press the Encoder Knob until the following display appears.
	<b>4</b> Rotate the Encoder Knob to select 122. 0°C or DI SABLED, press the Encoder Knob to confirm the option.
	<b>5</b> To exit the programming mode, scroll the menu, using the the Encoder Knob.

## “Technical” Programming

### Coffee Boiler

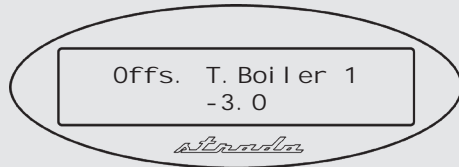

#### Description

- To properly calibrate the temperature of any espresso machine it is important to measure the temperature of the water exiting the group by means of an external temperature measuring device. The difference of the display temperature and the measured temperature may be compensated by use of the “Offs. T.Boiler” parameter.
- The OFFSET parameter is used to calibrate the coffee boiler temperature system to ensure the display temperature

accurately represents the temperature of the water exiting the group head.

- This parameter is preset at the factory based upon initial tests of this espresso machine.
- It is not recommended that this number is changed. Changes to this parameter can cause unexpected results.
- It is important to write down this value before making changes to be sure you can return to the factory programming if unexpected results occur. Each machine may have a different value as it is set individually.

Display	Operating Procedure
	<b>1</b> While the espresso machine is OFF, press and hold the Encoder Knob. After approximately 10 seconds the following display appears.
	<b>2</b> Releasing the Encoder Knob the following display appears.
	<b>3</b> Press the Encoder Knob until the following display appears.
	<b>4</b> Use the Encoder Knob to reach the value that you want to set, press the Encoder Knob to continue with the programming of the other parameters. In the case of espresso machine with 3 groups you can set the offset also on the coffee boiler 2 and 3.
	<b>5</b> To exit the programming mode, scroll the menu, using the the Encoder Knob.

## “Technical” Programming

### Temperature Measurement Units

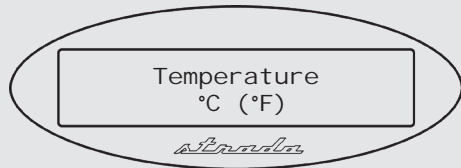

#### Description

- This parameter allows the technician to change the temperature display from degrees Celsius to degrees Fahrenheit and vice versa.

Display	Operating Procedure
	<b>1</b> While the espresso machine is OFF, press and hold the Encoder Knob. After approximately 10 seconds the following display appears.
	<b>2</b> Releasing the Encoder Knob the following display appears.
	<b>3</b> Press the Encoder Knob until the following display appears.
	<b>4</b> Rotate the Encoder Knob to select the option, press the Encoder Knob to confirm the option.
	<b>5</b> To exit the programming mode, scroll the menu, using the the Encoder Knob.

### Coffee Dose Counter

#### Description

- This parameter allows the technician to review the total coffee doses.

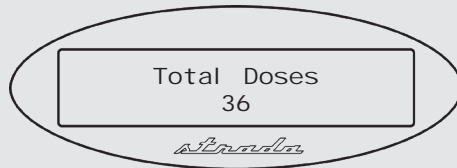

Display	Operating Procedure
	<b>1</b> While the espresso machine is OFF, press and hold the Encoder Knob. After approximately 10 seconds the following display appears.
	<b>2</b> Releasing the Encoder Knob the following display appears.
	<b>3</b> Press the Encoder Knob until the following display appears.
	<b>4</b> This parameter displays the total coffee doses of the espresso machine.
	<b>5</b> To exit the programming mode, scroll the menu, using the the Encoder Knob.

## “Technical” Programming

### Filter Alarm



### Description

- This parameter enables the technician to program an alarm that will alert the user about the need for maintenance or replacement of the water filter.
- Once the set volume has been reached, the error message “Filter Alarm” will be displayed.

Display	Operating Procedure
	<b>1</b> While the espresso machine is OFF, press and hold the Encoder Knob. After approximately 10 seconds the following display appears.
	<b>2</b> Releasing the Encoder Knob the following display appears.
	<b>3</b> Press the Encoder Knob until the following display appears.
	<b>4</b> Use the Encoder Knob to reach the value that you want to set 364 GIORNI or DI SABLED, press the Encoder Knob to continue with the programming of the other parameters.
	<b>5</b> To exit the programming mode, scroll the menu, using the the Encoder Knob.

## “Technical” Programming

### Steam Boiler

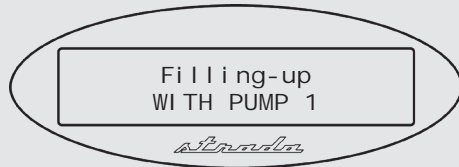

### Description

- The parameter filling WITH PUMP allows the technician to select the activation of the water pump during the automatic filling cycle of the service boiler.
- Only under unusual circumstances would the option of “WITHOUT PUMP” be chosen.
- The electronics installed in this espresso machine give priority to the brew boiler for pressure. The activation of the

auto-fill cycle during the brewing process can reduce the overall dispensing pressure in the brew boiler.

- During the auto-fill cycle, if a brew cycle is chosen, the auto-fill cycle is delayed until all brew cycles are complete.

Display	Operating Procedure
	<b>1</b> While the espresso machine is OFF, press and hold the Encoder Knob. After approximately 10 seconds the following display appears.
	<b>2</b> Releasing the Encoder Knob the following display appears.
	<b>3</b> Press the Encoder Knob until the following display appears.
	<b>4</b> Move the Encoder Knob to select WITH PUMP 1, WITH PUMP 2 or WITHOUT PUMP, press the Encoder Knob to confirm the option.
	<b>5</b> To exit the programming mode, scroll the menu, using the the Encoder Knob.



### DANGER



**THE COFFE BOILER CONTAINS WATER AT ELEVATED TEMPERATURES. WATER TEMPERATURE OVER 52°C CAN CAUSE SEVERE BURNS INSTANTLY OR DEATH FROM SCALDING.**

## “Technical” Programming

### Steam Boiler

Duri ngCoffeeDi sp  
Enabl e Fi l l i ngUp

*Starbucks*

### Description

- This parameter allows the technician to enable or disable tauto-fill cycle function during the brewing process.

Display	Operating Procedure
OFF 00:00	<b>1</b> While the espresso machine is OFF, press and hold the Encoder Knob. After approximately 10 seconds the following display appears.
OFF 00:00 Techni cal	<b>2</b> Releasing the Encoder Knob the following display appears.
Language ENGLI SH	<b>3</b> Press the Encoder Knob until the following display appears.
Duri ngCoffeeDi sp Enabl e Fi l l i ngUp	<b>4</b> Rotate the Encoder Knob to select Enabl e Fi l l i ngUp or Di sabl e Fi l l i ngUp, press the Encoder Knob to confirm the option.
OFF 00:00	<b>5</b> To exit the programming mode, scroll the menu, using the the Encoder Knob.

**⚠ DANGER ⚠**  
**THE COFFE BOILER CONTAINS WATER AT ELEVATED TEMPERATURES. WATER TEMPERATURE OVER 52°C CAN CAUSE SEVERE BURNS INSTANTLY OR DEATH FROM SCALDING.**



## “Technical” Programming

### Tea Brewing

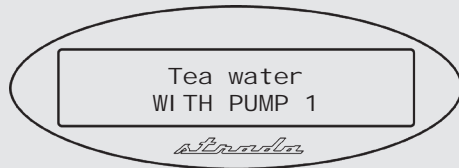

### Description

- This parameter allows the technician to select the type of the tea brewing WITH PUMP 1, WITH PUMP 2 or WITHOUT PUMP.
- Only under unusual circumstances would the option of “WITHOUT PUMP” be chosen.
- The electronics installed in this espresso machine give priority to the brew

boiler for pressure. The activation of the auto-fill cycle during the brewing process can reduce the overall dispensing pressure in the brew boiler.

- During the auto-fill cycle, if a brew cycle is chosen, the auto-fill cycle is delayed until all brew cycles are complete.

Display	Operating Procedure
	<b>1</b> While the espresso machine is OFF, press and hold the Encoder Knob. After approximately 10 seconds the following display appears.
	<b>2</b> Releasing the Encoder Knob the following display appears.
	<b>3</b> Press the Encoder Knob until the following display appears.
	<b>4</b> Rotate the Encoder Knob to select WI TH PUMP 1, WI TH PUMP 2 e WI THOUT PUMP, press the Encoder Knob to confirm the option.
	<b>5</b> To exit the programming mode, scroll the menu, using the the Encoder Knob.

## “Technical” Programming

### Coffee Boiler

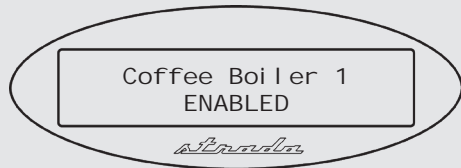

### Description

- This parameter allows the operator to enable/disable the coffee boiler.

Display	Operating Procedure
	<b>1</b> While the espresso machine is OFF, press and hold the Encoder Knob. After approximately 10 seconds the following display appears.
	<b>2</b> Releasing the Encoder Knob the following display appears.
	<b>3</b> Press the Encoder Knob until the following display appears.
	<b>4</b> Rotate the Encoder Knob to select ENABLED or DI SABLED, press the Encoder Knob to confirm the option and continue with the programming of the other parameters. Continue with the programming of the other parameters.
	<b>5</b> To exit the programming mode, scroll the menu, using the the Encoder Knob.



### DANGER



**THE COFFE BOILER CONTAINS WATER AT ELEVATED TEMPERATURES. WATER TEMPERATURE OVER 52°C CAN CAUSE SEVERE BURNS INSTANTLY OR DEATH FROM SCALDING.**

### Coffee Boiler

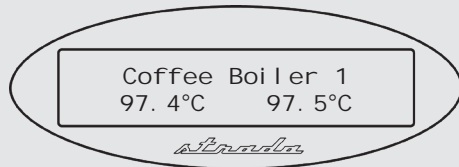

### Description

- This parameter allows the technician to program the steam boiler temperature. Each machine may have a different value as it is set individually.

Display	Operating Procedure
	<b>1</b> While the espresso machine is OFF, press and hold the Encoder Knob. After approximately 10 seconds the following display appears.
	<b>2</b> Releasing the Encoder Knob the following display appears.
	<b>3</b> Press the Encoder Knob until the following display appears.
	<b>4</b> Rotate the Encoder Knob to set the desired temperature, press the Encoder Knob to confirm the value and continue with the programming of the other parameters. In the case of espresso machine with 3 groups you can set the temperature also on the coffee boiler 2 and 3.
	<b>5</b> To exit the programming mode, scroll the menu, using the the Encoder Knob.



### DANGER



**THE COFFE BOILER CONTAINS WATER AT ELEVATED TEMPERATURES. WATER TEMPERATURE OVER 52°C CAN CAUSE SEVERE BURNS INSTANTLY OR DEATH FROM SCALDING.**

## “Technical” Programming

### Steam Boiler Temp.

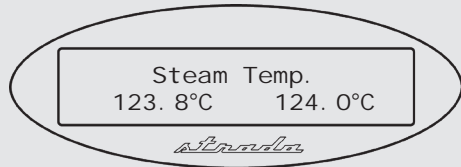

### Description

- This parameter allows the operator to program the steam boiler temperature.
- The maximum permitted value for the temperature setting is 129°C.

Display	Operating Procedure
	<b>1</b> While the espresso machine is OFF, press and hold the Encoder Knob. After approximately 10 seconds the following display appears.
	<b>2</b> Releasing the Encoder Knob the following display appears.
	<b>3</b> Press the Encoder Knob until the following display appears.
	<b>4</b> Rotate the Encoder Knob to set the desired temperature, press the Encoder Knob to confirm the value.
	<b>5</b> To exit the programming mode, scroll the menu, using the the Encoder Knob.

**⚠ DANGER ⚠**  
**THE COFFE BOILER CONTAINS WATER AT ELEVATED TEMPERATURES. WATER TEMPERATURE OVER 52°C CAN CAUSE SEVERE BURNS INSTANTLY OR DEATH FROM SCALDING.**

## “Technical” Programming

### Cup Warmer



#### Description

- This parameter allows the technician to enable or disable the cups heating function.
- This function is displayed only on the models of espresso machine equipped with this accessory.

Display	Operating Procedure
	<b>1</b> While the espresso machine is OFF, press and hold the Encoder Knob. After approximately 10 seconds the following display appears.
	<b>2</b> Releasing the Encoder Knob the following display appears.
	<b>3</b> Press the Encoder Knob until the following display appears.
	<b>4</b> Rotate the Encoder Knob to select ON or OFF, press the Encoder Knob to confirm the option and continue with the programming of the other parameters.
	<b>5</b> To exit the programming mode, scroll the menu, using the the Encoder Knob.

## “Technical” Programming

### Coffee Dose Counter

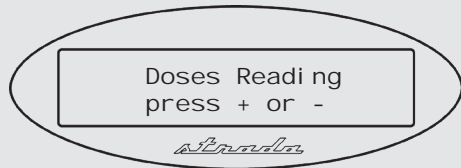

### Description

- This parameter allows the operator to view the quantity of coffee and tea doses.
- This parameter displays different values:
  - Coffee doses for each group;
  - Tea doses.

Display	Operating Procedure
	<b>1</b> When the espresso machine is turned off, press and hold the Encoder Knob. After about 10 seconds the following screen is displayed.
	<b>2</b> Releasing the Encoder Knob the following display appears.
	<b>3</b> Press the Encoder Knob until the following display appears.
	<b>4</b> Rotate the Encoder Knob to display the doses of each group and of the tea.
	<b>5</b> To exit the programming mode, scroll the menu, using the the Encoder Knob.

### Clock Adjust

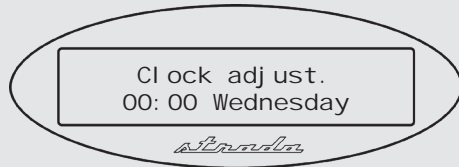

### Description

- This parameter allows the user to set the time of day and the day of the week.
- This parameter is used to display time and is also used by the “Auto On/Off” parameter.
- There are 3 changeable values within this parameter:
  - Hour;
  - Minute;
  - Day of week.

Display	Operating Procedure
	<b>1</b> While the espresso machine is OFF, press and hold the Encoder Knob. After approximately 10 seconds the following display appears.
	<b>2</b> Releasing the Encoder Knob the following display appears.
	<b>3</b> Press the Encoder Knob until the following display appears.
	<b>4</b> The first value will blink, use the Encoder Knob to set the clock and continue with the programming of the other parameters, press the Encoder Knob to confirm the value.
	<b>5</b> To exit the programming mode, scroll the menu, using the the Encoder Knob.

## “Technical” Programming

### Auto ON/OFF

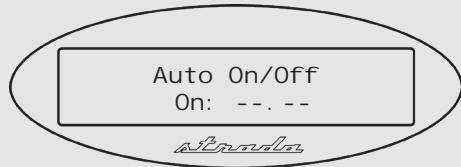

### Description

- This parameter allows the technician to program the espresso machine to turn on at a preset time and turn off at a preset time.
- This feature also allows the espresso machine to remain in the off condition for one closed day.

Display	Operating Procedure
	<b>1</b> While the espresso machine is OFF, press and hold the Encoder Knob. After approximately 10 seconds the following display appears.
	<b>2</b> Releasing the Encoder Knob the following display appears.
	<b>3</b> Press the Encoder Knob until the following display appears.
	<b>4</b> If the parameter is not set the espresso machine will be always turn on, move with the Encoder Knob to set the desired time, press the Encoder Knob to confirm the value and continue with the programming of the other parameters. Repeat this operation to set the other parameters.
	<b>5</b> To exit the programming mode, scroll the menu, using the the Encoder Knob.





