



# TENT SETUP INSTRUCTIONS

MODEL 2000004559

## Before you begin

Read all instructions before set up.

- Select a level site clear of rocks, branches, and other hard or sharp objects, to install your tent.

**⚠ WARNING: Keep clear of overhead power lines.**

- Do not set up your tent under trees because of potential lightning strikes or falling tree limbs in inclement weather.
- Secure with all stakes and guylines provided to prevent property damage or personal injury.
- For best results in windy conditions, position narrow end of tent into the wind.
- Enlist the help of at least one other person to assist you when it is time to assemble the tent.

## Pole Descriptions

Description	Qty.	Pole Repair Kit	Pole Replacement Kit
Main Body Pole (black, longest)	2	5010000540	5010000548
Vestibule Pole (black, long)	1	5010000540	5010000548
Rainfly Pole (grey, short)	1	5010000539	5010000549

## 1 Layout & Positioning of Tent and Poles

- Layout and position the tent with door facing desired direction. (Fig. 1)
- Stake down tent corners first through the stake rings. (Fig. 2)
- Keep the floor taut.
- Stake down the remainder of the stake rings.
- Assemble all poles by unfolding and interlocking the shock-corded pole sections.
- Insert the body poles into the pole sleeves.

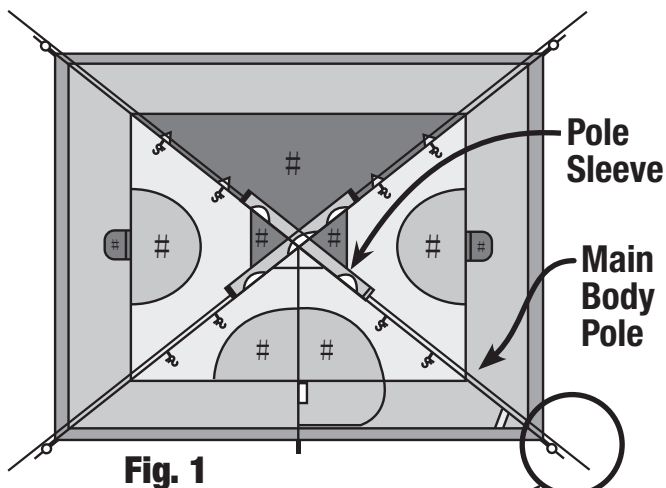

Fig. 1

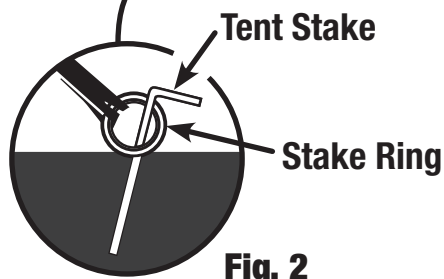

Fig. 2

## 2 Connect Poles to Tent

- Insert one pin into one end of the pole. (Fig. 3 and 4)
- Go to opposite end of pole and carefully insert the pin into the other pole end. (Fig. 4)
- Repeat for all poles.

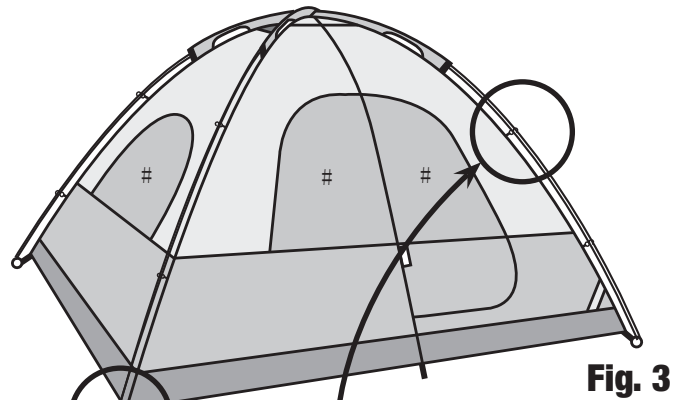

Fig. 3

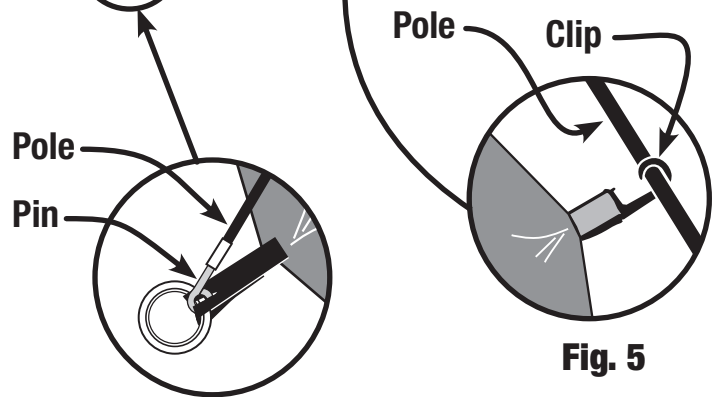

Fig. 5

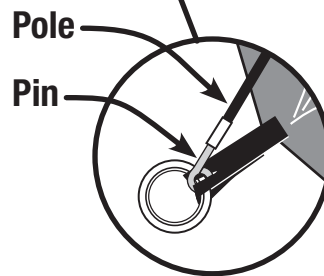

Fig. 4

## 3 Attach Tent to Body Poles Using Clips

- Attach clips along the edges of tent to body poles. (Fig. 5)
- Make any adjustments to the tent stakes, if needed.

## 4 Attach Rainfly

- Insert vestibule pole into pole sleeve located on underside of rainfly. (Fig. 6)
- Attach rainfly pole to underside of rainfly with straps and insert the tips of the rainfly pole into the pockets on underside of rainfly. (Fig. 6 & 7)
- Drape rainfly over tent. (Fig. 8)
- Secure rainfly with straps located on the underside of rainfly. (Fig. 9)
- Insert one pin into one end of the vestibule pole. (Fig. 10)
- Attach and stake out guylines. (Fig. 8)

HINT: During setup, keep door zipped to keep proper tension on fabric.

(continued on other side)

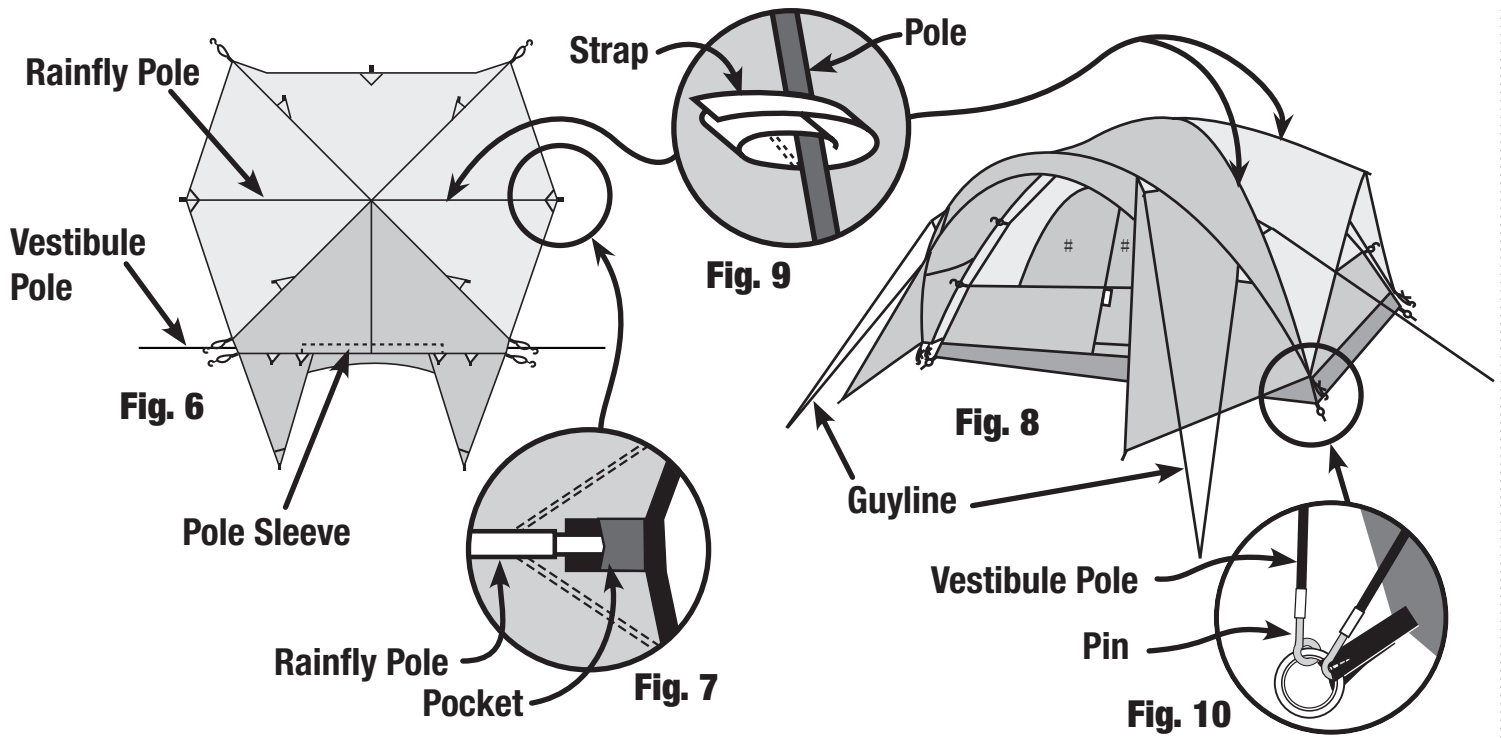

## 5 Electrical Cord Access

**NOTE:** Use only UL approved cords rated for outdoor usage. (Fig. 11)

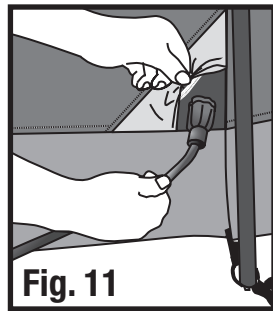

Fig. 11

## 6 To Store

1. All poles and stakes must be placed in the storage bag to prevent damage to the fabric items placed in the carry case.
2. Make sure tent is clean and dry before placing in carry case.
3. Remove rainfly, spread out on floor of tent, then unzip door & vents before taking tent down for storage.
4. Neatly fold tent to width of pole storage bag, place on tent, roll tightly, and place in carry case.
5. Store in a clean, dry area.

## Things You Should Know:

- Under certain conditions (cold weather, high humidity, etc.) condensation will form on the inside of your tent. Condensation is caused by water vapor from your breath, perspiration, or any wet clothing inside the tent. It is **NOT LEAKAGE** through the tent fabric. It can be minimized by removing wet clothing from your tent and by providing good ventilation through the tent.
- Tree limbs, tree sap, bird droppings, or moisture steadily dripping off tree limbs can cause damage to the tent fabric and its coating resulting in leaks or loss of flame-resistant properties.
- Never store tent, even for a short period of time, without drying it thoroughly and brushing off caked dirt. Do not pack stakes or poles inside your tent. Use a separate storage bag.
- Stakes should be removed by pulling on the stake itself. **NEVER PULL ON THE TENT TO REMOVE STAKES AS THIS COULD RESULT IN PROPERTY DAMAGE OR PERSONAL INJURY.**
- Tent poles should not be left telescoped together during storage.
- Do not leave your tent set-up for weeks at a time. Be aware that exposure to ultraviolet rays from the sun can seriously damage material and/or cause it to become discolored.

**⚠ WARNING:** Keep all flame and heat sources away from this tent fabric.

This tent meets the flammability requirements of CPAI-84. The fabric may burn if left in continuous contact with any flame source. The application of any foreign substance to the tent fabric may render the flame-resistant properties ineffective.



The Coleman Company, Inc. • 3600 North Hydraulic • Wichita, Kansas 67219  
1-800-835-3278 in the United States • www.coleman.com

MADE IN CHINA • PRINTED IN CHINA

© 2009 The Coleman Company, Inc. All rights reserved.  
Coleman®, , and are registered trademarks of  
The Coleman Company, Inc.