



Charcoal Grill

Use, Care & Assembly Manual

Model 9956 Series

ASSEMBLER/INSTALLER:
Leave these instructions with the consumer.

CONSUMER/USER:
Read all instructions and keep in a safe place for future reference.

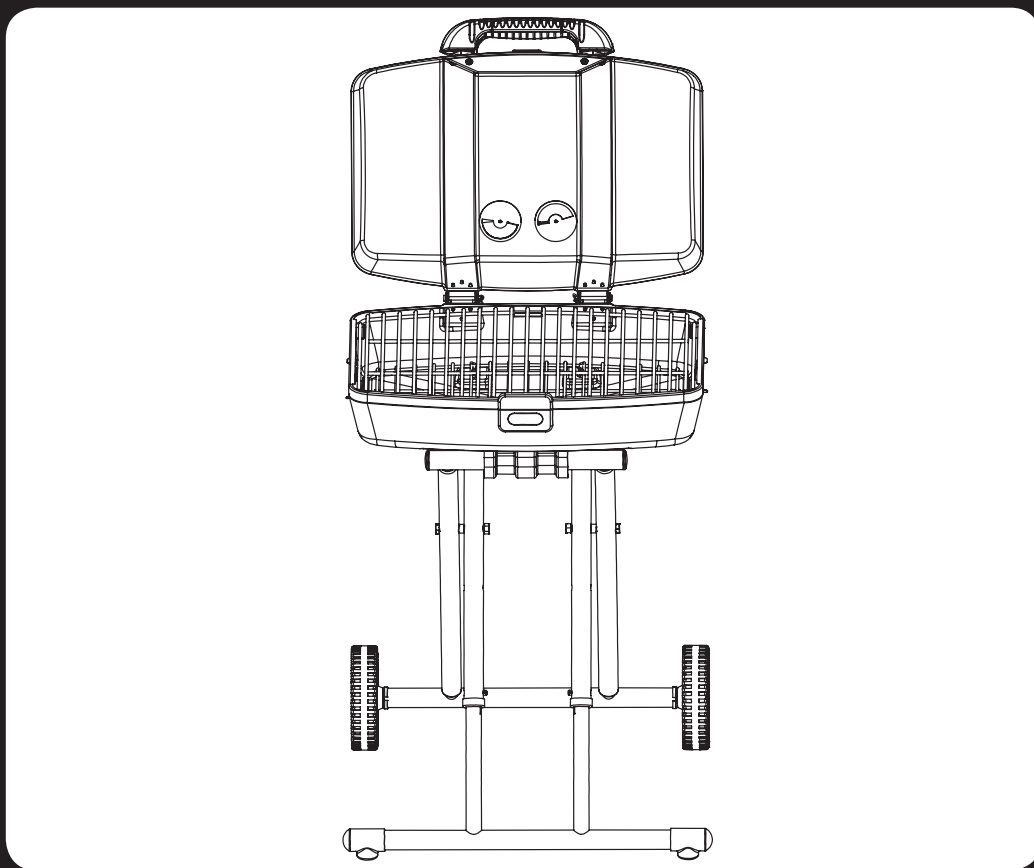

www.coleman.com

For Outdoor Use Only

IMPORTANT

Read this manual carefully before assembling, using or servicing this grill. Keep this manual for future reference. If you have questions about assembly, operation, servicing or repair of this grill, please call Coleman at 1-800-835-3278 or TDD: 1-316-832-8707. In Canada call 1-800-387-6161.

Contents

Contents.....	1
Introduction.....	1
General Safety Information.....	1
Assemble Grill.....	1
Instructions for Use.....	2
Charcoal Ash Cleaning.....	2
Grilling Tips and Hints.....	3
Cooking Methods.....	3
Care, Maintenance and Cleaning.....	3
Moving and Storage.....	3
Replacement Parts List — 9956 Series.....	6
Warranty.....	7

Introduction

Follow these instructions for assembly and read carefully, particularly the safety statements. The safety alert symbol,  is a universally recognized symbol used to identify safety information about hazards that can result in personal injury. When this symbol is used you should pay very close attention to what is written. Review these instructions before beginning assembly or using your grill.

General Safety Information

DANGER

FOLLOW INSTRUCTIONS AND WARNINGS TO AVOID FIRE, SERIOUS INJURY OR DEATH.

- Outdoor use only. Never use in enclosed area. Use in unventilated areas can cause death.
- Keep away from all combustible materials including gasoline and other flammable liquids and vapors.
- Read & follow all warnings on charcoal package.
- Use on a level, noncombustible surface only. Keep away from house, garage, balconies, or eave overhangs.
- Keep out of the reach of children.
- Exercise the same care you would with an open fire.
- Never leave unit unattended when hot or in use.
- Completely extinguish fire before leaving.
- Use gloves when handling or moving. Ashes can remain warm for a long time after extinguishing.
- Dispose of cold ashes properly.
- Do not modify in any way or use with parts not expressly approved by Coleman.

Contact local authorities regarding possible burn restrictions before using product.

WARNING



BURN HAZARD

- Unit is hot when being used. Use care when servicing.
- Keep out of reach of children.

WARNING

Combustion by-products produced when using this product contain chemicals known to the State of California to cause cancer, birth defects, or other reproductive harm.

Assemble Grill

For use only with charcoal.

IMPORTANT: Remove all packing material prior to assembly/use.

Assemble Wheels and Towing Handle

- Remove grill, wheels, legs and handle from packaging.
- Inspect all packing and remove all parts.
- See carton for parts included with your unit.
- Assemble wheels to grill base. Attach each wheel to axle using one bolt and one washer. (Fig. 1 and Fig. 2)

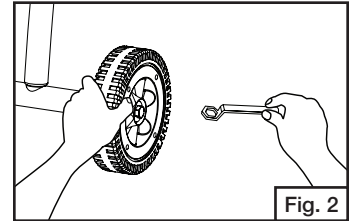
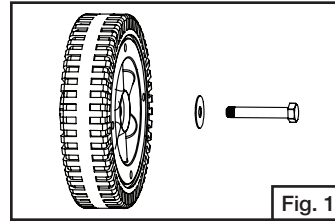

NOTE: Wrench not provided.



- Telescope the extending tubes to the towing handle. Press buttons on towing handle and push in until they lock into place. (Fig. 3)

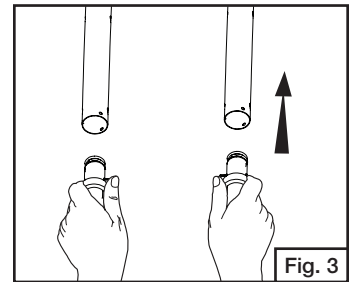

- Cap the ends of the extending tubes with provided bushings. (Fig. 4)

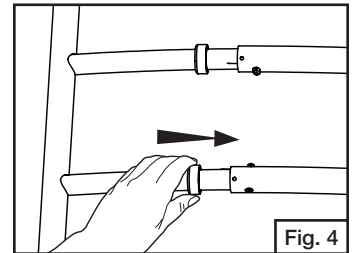

- Interlock the towing handle and the grill stand with pivot bolts, spacers and nuts. (Fig. 5)

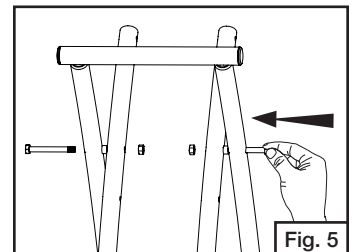

- Attach ends of towing handle to grill with pivot bolts & nuts. (Fig. 6)

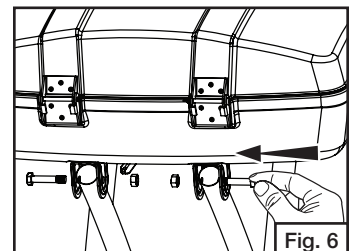

- Once handle is locked in position, the grill can easily be moved to any location in your campsite or backyard. (Fig. 7)

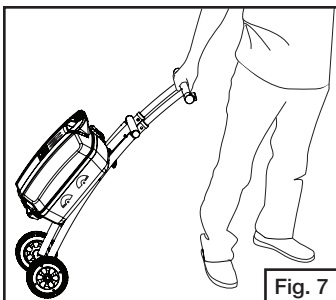

Set up the Grill

- Place foot on towing handle, grasp lid handle and lift until stand is fully extended. (Fig. 8)

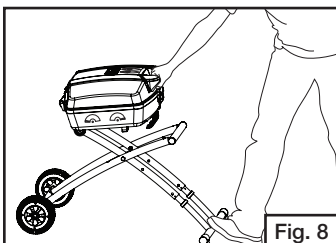

- Continue to pull lid handle toward you until stand is fully extended. (Fig. 9)

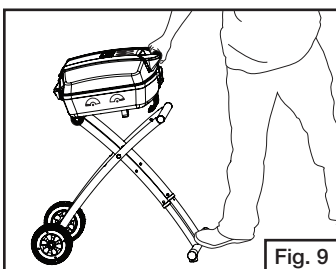

- Lower grill and slide grill back until leg extensions lock into brackets on bottom of grill stand. (Fig. 10, Fig. 11, and Fig. 12)

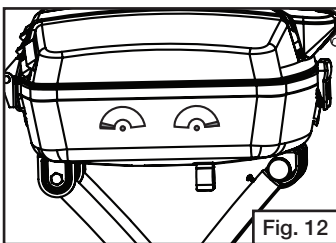
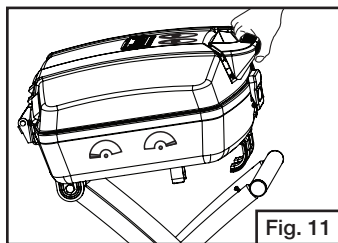
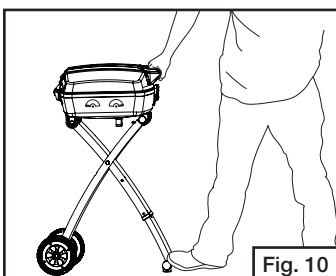

- Place charcoal grate in base, and put charcoal on it. (Fig. 14)

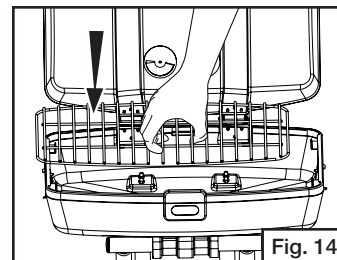

- Place cooking grate. (Fig. 15)

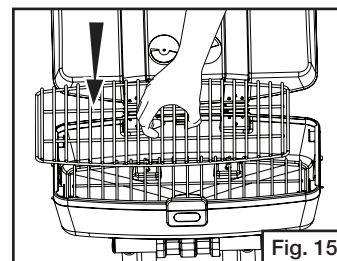

Match Lighting

- Strike and place the burning long wooden match through the spaces in the grill grate. (Fig. 16)

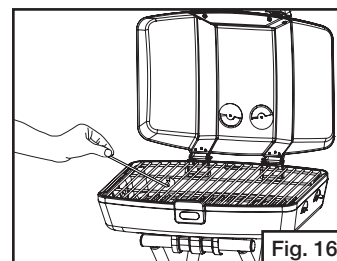

- When there's a need to cook with lid closed, observe the food from lid vent plates. (Fig. 17)
- Adjust flame with case vent plates on both sides of the grill. (Fig. 18)

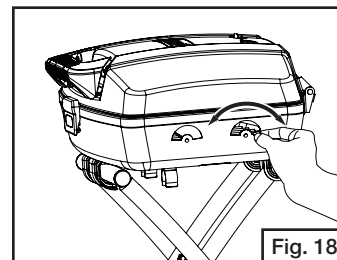
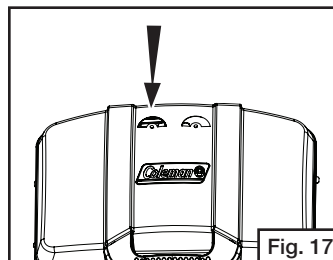

Charcoal Ash Cleaning

⚠ CAUTION

All cleaning and maintenance should be done only when the grill is cool.

- Place foot on towing handle, grasp lid handle and lift until stand is fully folded. (Fig. 19, and Fig. 20)

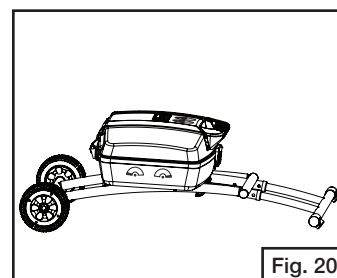
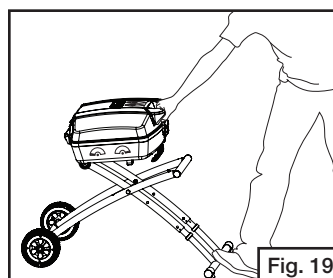

Instructions for Use

- To open lid, unlatch handle cover and lift up. (Fig. 13)

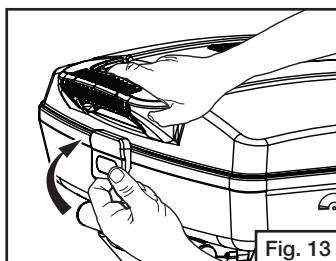

- Remove cooking grate and charcoal grate.

(Fig. 21 and Fig. 22)

NOTE: It is advisable to wear a glove to prevent injury or burns.

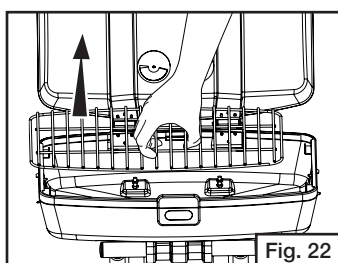
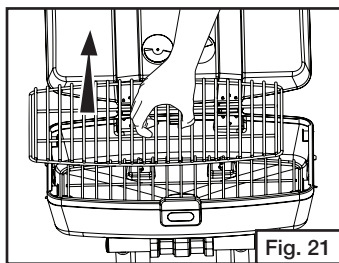

- Slant grill toward one side to empty ashes.

(Fig. 23)
NOTE: Dispose of cold ashes properly.

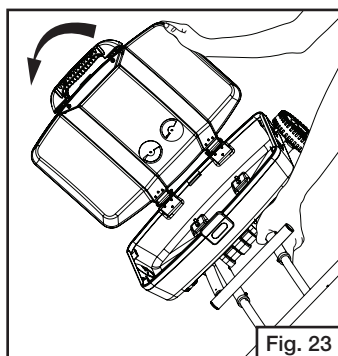

Grilling Tips and Hints

Safe Grill Operation

- NEVER leave cooking food unattended. Continually observing the food will help in maintaining an even temperature, conserve flame, improve the food's flavor and lessen flare-ups.
- To open the grill lid, slowly lift the handle to avoid burning in case of a grease fire flare-up.
- DO NOT expose any part of your body directly above the cooking area.

Food Preparation Hints

Your grill can cook a variety of foods. For best results, follow these instructions:

- Trim excess fat from meat and poultry. Slash any remaining fat to stop curling, but take care not to cut the meat.
- Frozen meat and poultry should be thawed prior to cooking.
- Frozen fish and vegetables will cook without thawing.
- Salt food after cooking to help prevent drying out the food.
- Brush naturally lean meats with cooking oil or margarine.
- Cook small pieces of tender foods in foil or on special delicate-food cooking grate (see the section titled "Cooking Methods").
- Apply barbecue, tomato or sugar-based sauces no sooner than the last 10 minutes of cooking.
- Turn food with tongs or a spatula; piercing food (especially meat), tends to dry it out.

Cooking Methods

- The heat source is directly below the food.
- Use for browning meat or cooking hot dogs and hamburgers, but check food frequently.
- Use for skillet and stir-fry cooking, but limit the amount of oil and heat to be used.
- Cook roasts, turkey or duck on low heat. Place meat with water in a foil pan with a corrugated bottom. Replenish water as needed.

Care, Maintenance and Cleaning

⚠ CAUTION

All cleaning and maintenance should be done only when the grill is cool.

Suggested Cleaning Materials:

- Mild dishwashing liquid detergent • Hot water
- Wire brush • Paper clip • Nylon cleaning pad
- Soft brass-bristled brush • Putty knife • Scraper

Component Cleaning:

- **COOKING GRATE:** Clean cooking grate with mild soap and hot water. Remove stubborn residue with a mild cleanser or scrub brush. DO NOT use a commercial oven cleaner.
- **GRILL INTERIOR:** Remove grate. Scrape side with tools and remove excess grease and cooking residue.

Moving and Storage

Moving the grill:

- DO NOT move the grill while it is lit or hot, or with objects on the cooking surface.
- Collapse the grill before moving.

Steps to follow before storing grill:

- Clean the grill.
- Cover the grill for protection from dust & cobwebs. Grill covers may be purchased from a grill dealer or manufacturer.

ATTN: DEPT 586

PRODUCT REGISTRATION DEPARTMENT
PO BOX 2931
WICHITA, KS 67201



Please
Place
First-Class
Stamp
Here

Please do not send other
correspondence to the address below.

PLEASE FOLD AND SEAL WITH TAPE. DO NOT STAPLE.

Coleman® Grill Registration Card



IMPORTANT!

COMPLETE THE ATTACHED REGISTRATION CARD AND RETURN WITHIN 10 DAYS TO RECEIVE THESE IMPORTANT BENEFITS:

- ▶ **PROTECT YOUR PRODUCT:**
We will keep the model number and date of purchase of your new Coleman® product on file to help you refer to this information in the event of an insurance claim such as fire or theft.
- ▶ **PROMOTE BETTER PRODUCTS:**
We value your input. Your responses will help us develop products designed to best meet your needs.

CONGRATULATIONS ON YOUR NEW COLEMAN® GRILL PURCHASE!

If you have any questions about your product, please call Coleman customer service at 1-800-835-3278.
For easier/faster registration, please go to the product registration section of our Coleman Web site at www.coleman.com.

1. Mr. 2. Mrs. 3. Ms. 4. Miss.

First Name: _____ Initial: _____ Last Name: _____

 Address (Number and Street): _____ Apt #: _____

 City: _____ State: _____ Zip: _____

 Phone #: _____

2. Date of Purchase: _____/_____/_____ 3. Purchase Price: \$_____.00 (Excluding Tax)
Month Day Year 1. Regular Price 2. Sale Price 3. Don't Know

4. Store where purchased: _____

5. Product Model Number: _____

6. Can Coleman contact you with promotional information or updates about Coleman® products?
 1. Yes, Please contact me. 2. No, Thanks

7. E-mail Address: _____

The following questions are not required to register your product, but will greatly assist us in understanding your needs and building better performing products.

8. Which factors most influenced your purchase?
 (Please check all that apply.)

- | | |
|---|---|
| 1) <input type="checkbox"/> Received as a gift | 8) <input type="checkbox"/> Magazine |
| 2) <input type="checkbox"/> Brand | 9) <input type="checkbox"/> In Store Display/Sign |
| 3) <input type="checkbox"/> Price | 10) <input type="checkbox"/> Packaging |
| 4) <input type="checkbox"/> Style | 11) <input type="checkbox"/> Size |
| 5) <input type="checkbox"/> Recommendation from Store Salesperson | 12) <input type="checkbox"/> Weight |
| 6) <input type="checkbox"/> Recommendation from Friend | 13) <input type="checkbox"/> Ease of Use |
| 7) <input type="checkbox"/> Television | 14) <input type="checkbox"/> Other Features |
| | 15) <input type="checkbox"/> Other |

9. Which of these best describes this purchase?
 (Please check all that apply.)

- 1) Received as a gift
 2) First of this type of product owned
 3) Addition to Coleman® products
 4) Replaced old Coleman® product
 5) Replaced another brand product
 6) Purchase in addition to another brand

10. Do you participate in any of the following activities?
 (Please check all that apply.)

- | | |
|--|--|
| 1) <input type="checkbox"/> Tent Camping | 10) <input type="checkbox"/> Barbequing |
| 2) <input type="checkbox"/> RV Camping | 11) <input type="checkbox"/> Rock Climbing |
| 3) <input type="checkbox"/> Hiking/Backpacking | 12) <input type="checkbox"/> Bicycling |
| 4) <input type="checkbox"/> Fishing | 13) <input type="checkbox"/> Leisure Walking |
| 5) <input type="checkbox"/> Boating | 14) <input type="checkbox"/> Canoeing |
| 6) <input type="checkbox"/> Going to the Beach | 15) <input type="checkbox"/> Kayaking |
| 7) <input type="checkbox"/> Tailgating | 16) <input type="checkbox"/> Entertaining |
| 8) <input type="checkbox"/> Picnicking | 17) <input type="checkbox"/> Backyard Entertaining |
| 9) <input type="checkbox"/> Hunting | 18) <input type="checkbox"/> Attend Auto Racing |

11. What other brands did you consider?:

19. What grill feature influenced the purchase of your Coleman® grill? (Please check all that apply.)

- | | | |
|---|---|--|
| 1) <input type="checkbox"/> Amount of BTU's for cooking | 7) <input type="checkbox"/> Side burner (if applies) | 13) <input type="checkbox"/> Size of the grill (available cooking square inches) |
| 2) <input type="checkbox"/> Cart design | 8) <input type="checkbox"/> Steamer/Fryer/Warmer (if applies) | 14) <input type="checkbox"/> Integrated storage cabinet |
| 3) <input type="checkbox"/> Flame control cooking system | 9) <input type="checkbox"/> Side table design | 15) <input type="checkbox"/> Price |
| 4) <input type="checkbox"/> Power burner | 10) <input type="checkbox"/> Color of the grill (not including stainless steel) | 16) <input type="checkbox"/> Rotisserie (if applies) |
| 5) <input type="checkbox"/> Stainless steel material (if applies) | 11) <input type="checkbox"/> Warming racks | 17) <input type="checkbox"/> Other |
| 6) <input type="checkbox"/> Porcelain or stainless steel cooking grates | 12) <input type="checkbox"/> Dependable igniter | |

12. Date of Your Birth: _____/_____/_____
Month Day Year

13. For your primary residence, do you:
 1. Own 2. Rent

14. Education: (Check only one.)

- 1) High school diploma
 2) Some college
 3) College degree
 4) Some graduate school
 5) Graduate degree

15. Marital Status:

1. Single 2. Married

16. Number of people in household: _____

17. Number of kids in household under 18 years of age: _____

18. Which best describes your family income?

- 1) Under \$15,000
 2) \$15,000 - \$24,999
 3) \$25,000 - \$34,999
 4) \$35,000 - \$49,999
 5) \$50,000 - \$74,999
 6) \$75,000 - \$99,999
 7) \$100,000 - \$149,999
 8) Over \$150,000

Thank you for filling out this questionnaire. Your answers are important to us. Please check here [] if you prefer not to learn more about Coleman® Outdoor Cooking Products or obtain information on new interesting opportunities from other companies.

Replacement Parts List – 9956 Series

1	2000008436	Cooking Grate and Charcoal Grate
2	9949-2401	Wheel Assy
3	5010000975	Lid Handle Assy

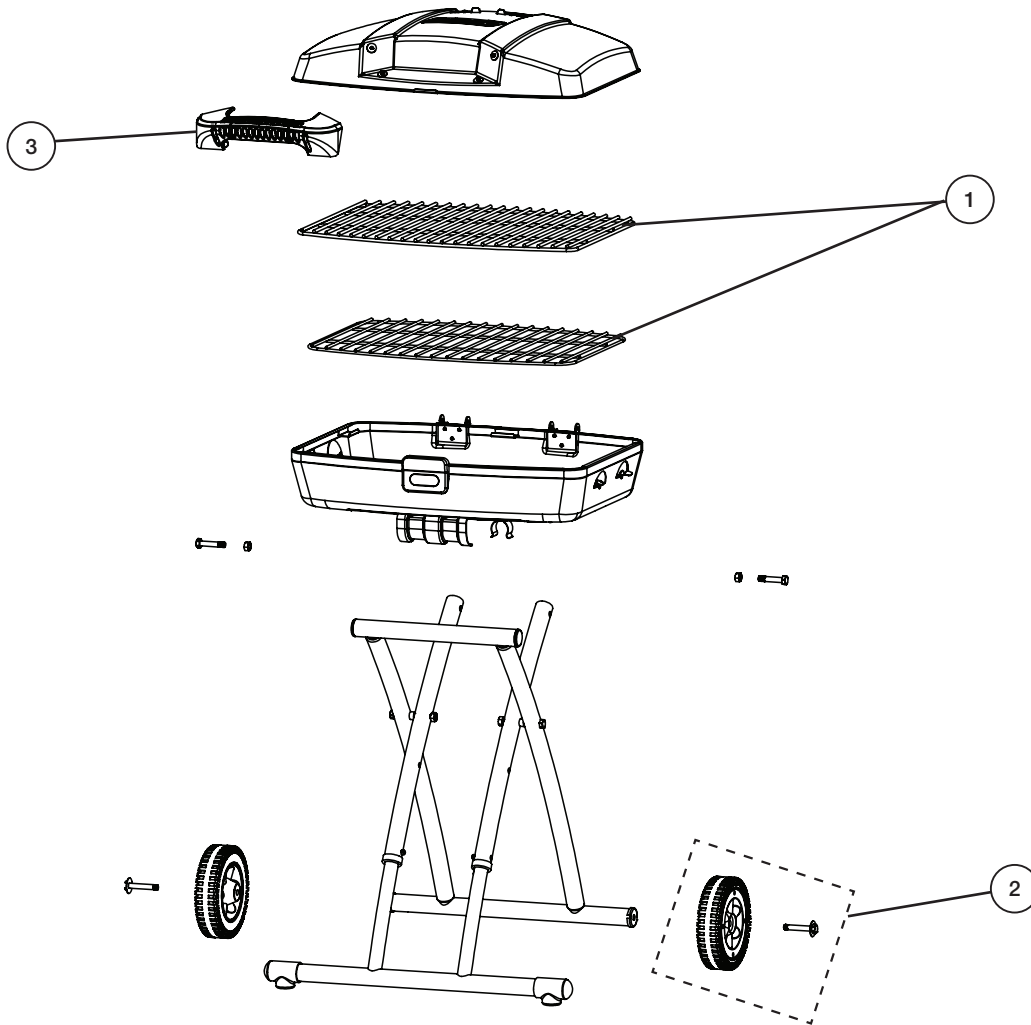

Limited One Year Warranty

The Coleman Company, Inc. ("Coleman") warrants that for a period of one (1) year from the date of original retail purchase, this product will be free from defects in material and workmanship. Coleman, at its option, will repair or replace this product or any component of the product found to be defective during the warranty period. Replacement will be made with a new or remanufactured product or component. If the product is no longer available, replacement may be made with a similar product of equal or greater value. This is your exclusive warranty.

This warranty is valid for the original retail purchaser from the date of initial retail purchase and is not transferable. Keep the original sales receipt. Proof of purchase is required to obtain warranty performance. Coleman dealers, service centers, or retail stores selling Coleman® products do not have the right to alter, modify or in any way change the terms and conditions of this warranty.

What This Warranty Does Not Cover

This warranty does not cover normal wear of parts, parts that are not genuine Coleman® parts, or damage resulting from any of the following: negligent use or misuse of the product; commercial use of the product; use contrary to the operating instructions; disassembly, repair or alteration by anyone other than Coleman or an authorized service center. Further, the warranty does not cover Acts of God, such as fire, flood, hurricanes and tornadoes. Warranty void if damage to the product results from the use of a part other than a genuine Coleman® part.

COLEMAN SHALL NOT BE LIABLE FOR DEFECTS THAT ARE CAUSED BY THE USE OF UNAUTHORIZED PARTS OR SERVICE. COLEMAN SHALL NOT BE LIABLE FOR ANY INCIDENTAL OR CONSEQUENTIAL DAMAGES CAUSED BY THE BREACH OF ANY EXPRESS OR IMPLIED WARRANTY OR CONDITIONS. EXCEPT TO THE EXTENT PROHIBITED BY APPLICABLE LAW, ANY IMPLIED WARRANTY OF MERCHANTABILITY OR FITNESS FOR A PARTICULAR PURPOSE IS LIMITED IN DURATION TO THE DURATION OF THE ABOVE WARRANTY OR CONDITIONS. SOME STATES, PROVINCES, OR JURISDICTIONS DO NOT ALLOW THE EXCLUSION OR LIMITATION OF INCIDENTAL OR CONSEQUENTIAL DAMAGES OR LIMITATIONS ON HOW LONG AN IMPLIED WARRANTY LASTS, SO THE ABOVE LIMITATIONS OR EXCLUSION MAY NOT APPLY TO YOU. THIS WARRANTY GIVES YOU SPECIFIC LEGAL RIGHTS, AND YOU MAY ALSO HAVE OTHER RIGHTS THAT VARY FROM STATE TO STATE OR PROVINCE TO PROVINCE.

How to Obtain Warranty Service

Take the product to an authorized Coleman service center. You can find the nearest authorized Coleman service center by visiting www.coleman.com or calling 1-800-835-3278 or TDD 1-316-832-8707 in the United States or 1-800-387-6161 in Canada. If a service center is not conveniently located, attach to the product a tag that includes your name, address, daytime telephone number and description of the problem. Include a copy of the original sales receipt. Carefully package the product and send either by courier or insured mail with shipping and insurance prepaid to:

For products purchased in the United States:

The Coleman Company, Inc.
3600 North Hydraulic
Wichita, KS 67219 U.S.A.

For products purchased in Canada:

Sunbeam Corporation (Canada) Limited
DBA Jarden Consumer Solutions
20B Hereford Street
Brampton, ON L6Y 0M1

The costs of transporting the product to Coleman or an authorized service center for warranty service is the responsibility of the purchaser.

DO NOT RETURN THIS PRODUCT TO THE PLACE OF PURCHASE.

If you have any questions regarding this warranty please call 1-800-835-3278 or TDD 1-316-832-8707 in the United States or 1-800-387-6161 in Canada.

For Warranty, Service and Parts:



Locate your model number and serial number on the label found on the grill.



The Coleman Company, Inc. • 3600 North Hydraulic • Wichita, KS 67219 U.S.A.

1-800-835-3278 • TDD: 1-316-832-8707

© 2010 The Coleman Company, Inc. All rights reserved.

Coleman®, , and  are registered trademarks of The Coleman Company, Inc.