



Event Grill 9995A Series

INSTRUCTIONS FOR USE

© 2004 The Coleman Company, Inc.
www.coleman.com



IMPORTANT

Read this manual carefully before assembling, using or servicing this grill. Keep this manual for future reference. If you have questions about assembly, operation, servicing or repair of this grill, please call Coleman at 1-800-835-3278 or TDD: 316-832-8707.

The handling, storage and transportation of gas cylinders must be in accordance with ANSI/NFPA 58, Storage and Handling of Liquefied Gases, or CSA B149.1, Natural Gas and Propane Installation Code.

The owner shall post in a prominent location instructions to be followed in the event the user smells gas. This information shall be obtained by consulting the local gas supplier.

- 9-volt Battery included
- 20# L.P. gas cylinders not included

For Outdoor Use Only



GAS BARBECUE
ANSI Z83.11 • CSA 1.8 (2002)
FOOD SERVICE EQUIPMENT

Contents

General Safety Information	2-3
General Installation	3
Portable L.P. Gas Barbecue Cylinders	4
L.P. Gas Cylinder	4-5
Hose and Regulator	5
Transporting the Cylinder	5-6
Filling and Purging Type 1 L.P. Gas Cylinders	6
Purging and Evacuating Devices for L.P. Gas Cylinders with Type 1 Cylinder Valves	6
To Set up	7-8
Leak Testing	8
Fixing a Fuel Leak	9
Start-up Check List	9
Lighting the Grill	9-10
Tear Down/Clean	10-11
General Use and Correct Burner Flames	12
Cleaning the Venturi	12
Storage	13
Maintenance	13
Things You Should Know	13
Troubleshooting	13
Replacement Parts List	14
Warranty	16

WARNING: Improper installation, adjustment, alteration, service or maintenance can cause property damage, injury or death. Read the installation, operating and maintenance instructions thoroughly before installing or servicing this equipment.

General Safety Information

This manual contains important information about the assembly, operation and maintenance of this product and system. General safety information is presented in these first few pages and is also located throughout the manual. Particular attention should be paid to information accompanied by the safety alert symbols: “**▲ DANGER**”, “**▲ WARNING**”, “**▲ CAUTION**”.

Keep this manual for future reference and to educate new users of this product. This manual should be read in conjunction with the labeling on the product.

Safety precautions are essential when any mechanical or propane fueled equipment is involved. These precautions are necessary when using, storing, and servicing. Using this equipment with the respect and caution demanded will reduce the possibilities of personal injury or property damage.

The following symbols shown below are used extensively throughout this manual. Always heed these precautions, as they are essential when using any mechanical or fueled equipment.

▲ DANGER

DANGER indicates an imminently hazardous situation which, if not avoided, will result in death or serious injury.

▲ WARNING

WARNING indicates a potentially hazardous situation which, if not avoided, could result in death or serious injury.

▲ CAUTION

CAUTION indicates a potentially hazardous situation which, if not avoided, may result in minor or moderate personal injury, or property damage.

FOR YOUR SAFETY

If you smell gas:

1. Shut off gas to the appliance.
2. Extinguish any open flame.
3. Open lid.
4. If odor continues, immediately call your gas supplier or your fire department.
5. NEVER use Natural Gas in a unit designed for Liquid Propane (L.P.) Gas.

FOR YOUR SAFETY

1. Do not store or use gasoline or other flammable vapors and liquids in the vicinity of this or any other appliance.
2. An L.P. cylinder not connected for use shall NOT be stored in the vicinity of this or any other appliance.

▲ WARNING

Combustion by-products produced when using this product contain chemicals known to the State of California to cause cancer, birth defects, or other reproductive harm.

▲ DANGER

- FOR OUTDOOR USE ONLY. NEVER operate grill in enclosed areas, as this could lead to gas accumulating from a leak, causing an explosion or a carbon monoxide buildup which could result in injury or death. DO NOT use in garages, breezeways, sheds or any enclosed area. (Fig. 1)
- NOT FOR USE BY CHILDREN. (Fig. 2)
- If these instructions are ignored, a hazardous fire or explosion could result in physical injury, death or property damage!

▲ WARNING

- DO NOT move grill while it is operating or hot. (Fig. 3)
- Keep outdoor cooking gas appliance area clear and free from combustible materials, gasoline and other flammable vapors and liquids. (Fig. 4)

▲ WARNING

- NEVER place more than 15 pounds on a side table or a side burner. DO NOT lean on grill. (Fig. 5)
- NEVER use charcoal briquettes or lighter fluid in a gas grill. (Fig. 6)
- Grill is hot when in use; to avoid burns, DO NOT touch any hot grill surface. Keep children and pets away from hot grill. (Fig. 7)
- NEVER leave the grill unattended while it is in use. (Fig. 8)
- It is your responsibility to assemble, install, operate and care for your gas grill properly.
- DO NOT vent propane vapor from the cylinder before taking it to be refilled.
- DO NOT use gas grill indoors or store any propane cylinder(s) indoors, including in the garage, breezeways, sheds or enclosed areas.
- Under some circumstances, propane may lose the distinctive odor that was added. Keep the service valve closed and plugged or capped (as recommended by the manufacturer) when the cylinder is not connected to the appliance, including “empty” cylinders. Other strong odors may hide or mask the odor of propane. Colds, allergies, sinus congestion, and the use of tobacco, alcohol or drugs may impair your ability to detect the odor of propane.

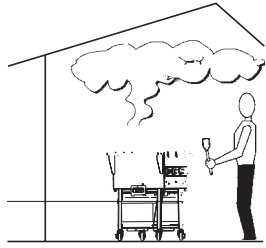

Portable L.P. Gas Barbecue Cylinders

⚠ WARNING

A liquid propane tank, not connected for use with this gas barbecue, shall not be stored in the vicinity of this or any other appliance.

Liquefied Petroleum gas (abbreviated L.P. gas or propane), is highly flammable. It becomes liquid when stored under high pressure inside a cylinder and vaporizes when released. L.P. gas is heavier than air and tends to collect in low areas. It is important that there are no leaking connections on your gas grill that could cause a fire or explosion (see "LEAK TESTING", Pg. 8).

Portable LP gas grills require a fuel delivery system which is comprised of a valve [A], a hose [B], a regulator [C] with vent holes [G], an L.P. gas supply cylinder [D], a Type 1 coupling nut [E] and a Type 1 cylinder valve [F]. (Fig. 10). Illustration in Fig. 10 is for description purposes only. The valve assembly for this grill is of a different configuration.

Protect regulator assembly vent holes [G] from freezing rain, rain, snow and water. See Fig. 10 for vent locations.

⚠ WARNING

Your new barbecue grill is equipped with a Type 1 coupling nut [E]. DO NOT attempt to connect to any other L.P. cylinder not equipped with a mating Type 1 cylinder valve [F]. This grill is not to be used with any other cylinder connection device.

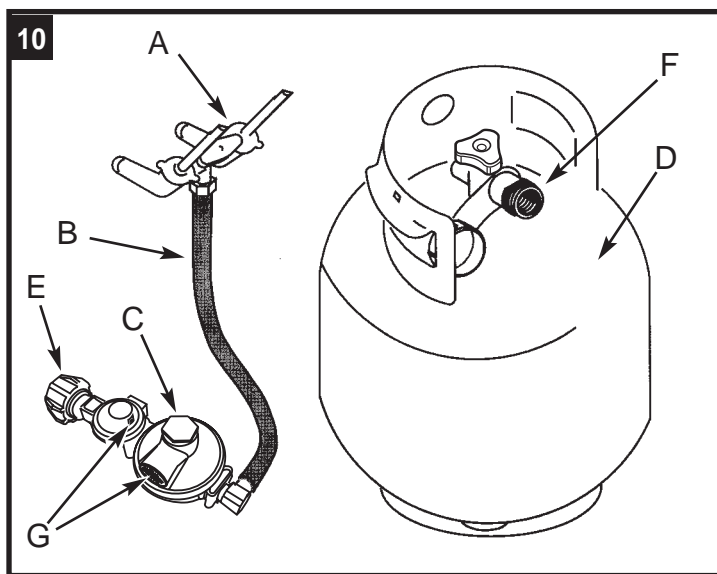

L.P. Gas Cylinder

⚠ DANGER

- DO NOT insert any foreign objects into the valve outlet. You may damage the valve. A damaged valve can cause a leak, which could result in explosion, fire, severe personal injury or death.

⚠ WARNING

- If the grill is not in use, the gas must be turned off at the supply cylinder(s).
- Cylinders must be stored outdoors out of the reach of children and must not be stored in a building, garage or any other enclosed area. (Fig. 11)

Cylinder Specifications

- Any L.P. gas supply cylinder used with this grill must be approximately 12 inches diameter and 18 inches high. The maximum fuel capacity is 80% and is approximately 20 pounds of propane.
- The maximum weight of a properly filled cylinder will be approximately 38 pounds (47.7 lbs. nominal water capacity).
- The L.P. cylinder must have a shut-off valve terminating in a Type 1 L.P. gas cylinder valve outlet (see item [F], Fig. 10, pg. 4).

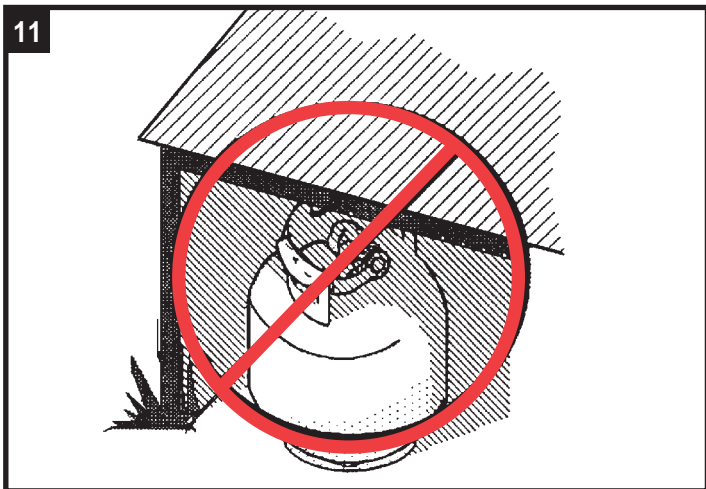

- A Type 1 compatible cylinder with a Type 1 cylinder valve has a back-check valve which does not permit gas flow, until a positive seal has been obtained.
- The cylinder must be arranged for vapor withdrawal. It must also include a collar to protect the cylinder valve. A safety relief device having direct communication with the vapor space of cylinder must be provided. This will expel high pressure gas if the cylinder is overfilled or overheated which could result in fire or explosion.
- All L.P. gas cylinders used with this appliance shall be constructed and marked in accordance with the specifications for L.P. gas cylinders of the U. S. Department of Transportation (DOT) or the National Standard of Canada, CAN/CSA-B339, Cylinders, Spheres and Tubes for Transportation of Dangerous Goods; and Commission, as applicable; and shall be provided with a listed overfilling prevention device.
- Read labels on the L.P. Gas Supply Cylinder.
- New cylinders are always shipped empty for safety.
- Allow only qualified L.P. gas dealers to fill or repair your L.P. gas supply cylinder.
- Inform the gas dealer if it is a new or used cylinder to be filled.
- Caution the gas dealer not to overfill cylinder.
- After filling, have the gas dealer check for leaks and to see that the relief valve remains free to function.

! CAUTION

Have the gas dealer weigh cylinder after filling to ensure that the cylinder is not overfilled.

The Type 1 connection system has the following features:

1. The system will not allow gas to flow until a positive connection has been made.
NOTE: The cylinder control valve must be turned off before any connection is made or removed.
2. The system has a thermal element that will shut off the flow of gas in the event of a fire.
3. The system has a flow limiting device which, when activated, will limit the flow of gas to 10 cubic feet per hour.
4. NEVER use grill without leak testing this connection.

! WARNING

- **DO NOT attempt to adjust the regulator as this could create a situation causing personal injury or property damage.**

The pressure regulator and hose assembly with the Type 1 fitting supplied with the appliance must be used. Do not use another hose and regulator assembly other than the one supplied with the grill or a Coleman replacement pressure regulator assembly. The pressure regulator and hose assembly provided is factory set at an outlet pressure of 11 inches water column (1/2 psi).

- Keep the small vent hole in the regulator clean of dirt and debris (see item [G], Fig. 10, pg. 4).
- Consult your L.P. gas dealer if you think the regulator is not working properly.

! WARNING

During assembly of grill and when attaching or replacing the L.P. gas cylinder, insure that the gas supply hose is free of kinks and/or damage and is at least 3" away from hot surfaces such as the grill housing.

Transporting the Cylinder

- Transport only one cylinder at a time.
- Transport cylinder in an upright and secure manner with a control valve turned off and the cap in place.
- DO NOT transport cylinder in passenger compartment, unless you have an open window ventilation.
- DO NOT leave cylinder in direct sunlight or in a high heat area such as a closed car trunk. High heat areas could cause the relief valve to vent gas.
- Use a cylinder cap on cylinder valve outlet during transport and when the cylinder is not connected to grill.
- Keep cylinder valve closed when not in use.
- Take the cylinder directly home after it has been filled.

Handle

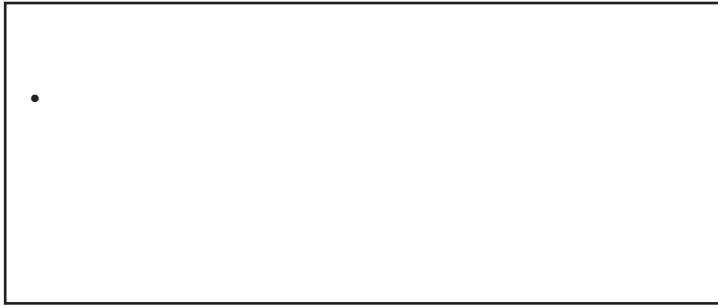

12

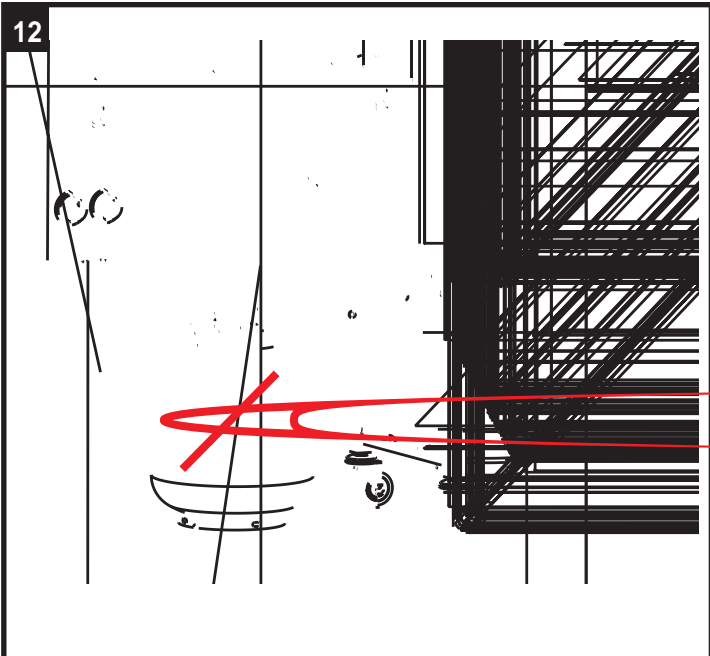

13

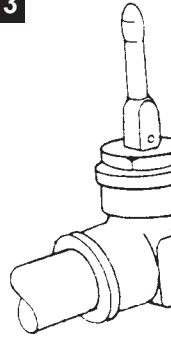

CGA-510 POL

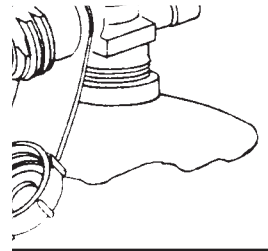

**Purging ar
Gas Cylin**

After purging or
POL plug into th
vent the back-cl
cap and strap a
knob before rett
For proper purg
In the US:
Cylinders", and
Procedures for

**Devices for L.P.
1 Cylinder Valves**

the customer.
to:
A #130, "Recommended

Purging

14



Step 1

- Carefully read and follow the instructions for proper setup & use of your Coleman® Event Grill.



- See replacement parts list for parts identification.

Step 2

- Unlock Grill Legs as shown.



- Carefully lower both Left and Right Grill Legs into the locked position.



Step 4

- Unlock both Left and Right Lower Tank Mounts.

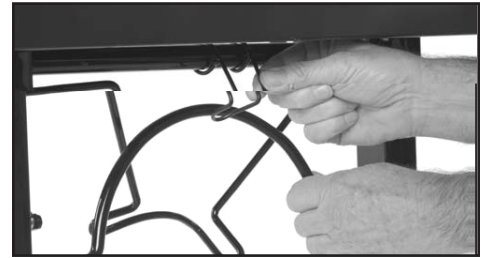

- Place a 20 lb. propane cylinder in both Lower Tank Mounts and secure as shown. For easier installation, place the tank with the collar opening toward the grill, lower the upper tank support, then rotate the tank to engage the upper tank support.



- NOTE:** Grill may be operated with only one cylinder.

- Remove both Regulators from bottom of grill.

■

To Set Up continued

Step 6

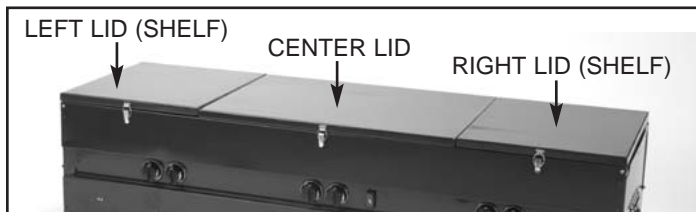

- Unlock Right Side Lid.
- NOTE:** Undo latches on front and back of lid.
- Release flaps to form Right Side Shelf.

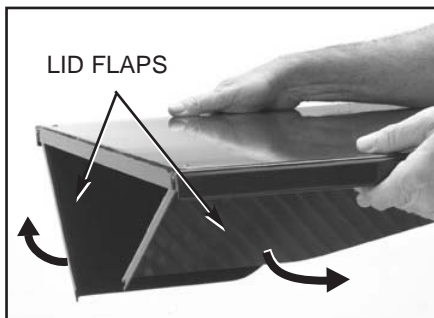

IMPORTANT: Always remove Lids in this order:

- Right Lid first.
- Left Lid second.
- Center Lid last.

- Carefully insert Shelf Lip on Right Side Shelf into Top Channel, while at the same time making sure the Notches on the side Flaps fit into the Flanges on the grill body.

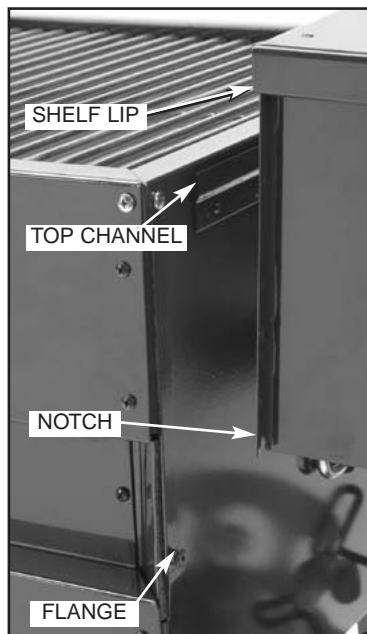
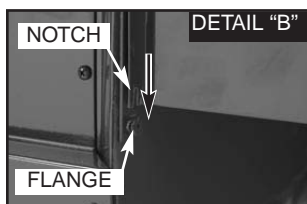
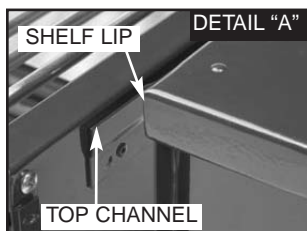

- Repeat the same order for attaching the Left Side Shelf as you did on the Right Side Shelf.
- Remove Center Lid and set aside until ready for storage of the grill.

To Set Up continued

Step 7

- Install two Grease Pans from front as shown.

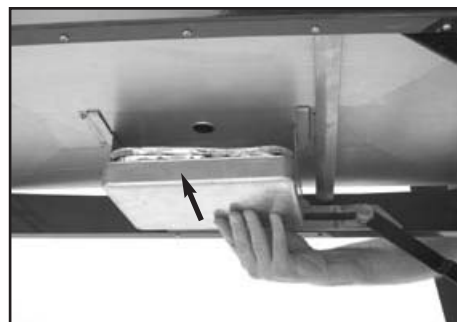

Step 8

- Install 9-Volt Battery with positive (+) terminal as shown on Igniter Module.

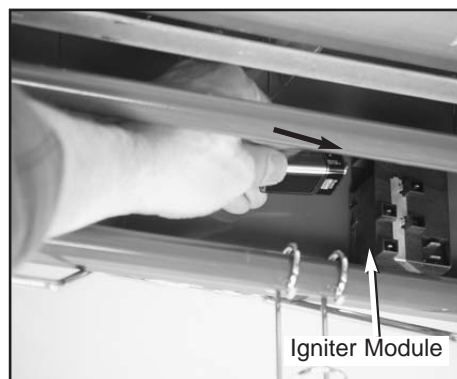

Leak Testing

⚠ DANGER

To PREVENT FIRE OR EXPLOSION HAZARD:

- NO SMOKING. DO NOT use or permit sources of ignition in the area while doing a leak test.
- Perform leak tests outdoors only.
- NEVER perform a leak test with fire or flame.

How to Check for Leaks

1. Make a soapy solution of equal parts mild liquid dishwashing detergent and water.
2. Turn off all burner control knobs.
3. Turn on fuel supply. Turn cylinder valve knob counterclockwise (right to left) one rotation.
4. Apply soap solution to connections indicated with arrows in Fig. 15. If bubbles appear at these areas, a leak is indicated.

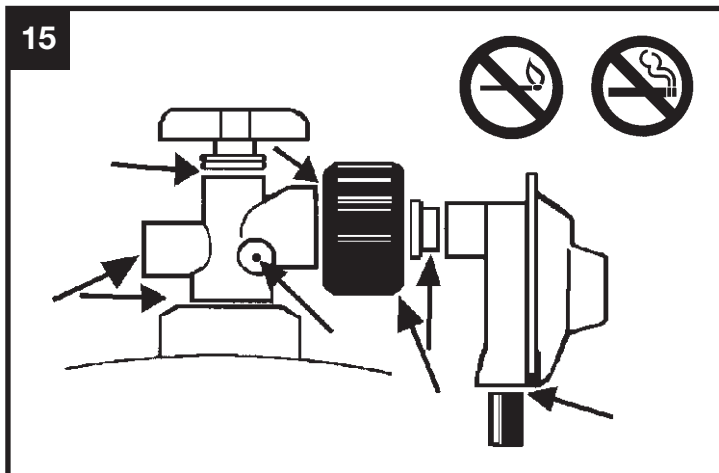

Fixing a Fuel Leak

If you detect a leak:

1. Turn off the fuel supply. Push in and turn on control knobs to release pressure in hose, then return the control knobs to OFF.
2. Wash off soapy solutions with cold water and towel dry.
3. Stop a leak by tightening the loose joint, or by replacing the faulty part with a replacement part recommended by Coleman. DO NOT attempt to repair the cylinder valve if it should become damaged; the cylinder MUST be replaced.
4. If you are unable to stop a leak, shut off the gas supply at the cylinder valve. Remove the cylinder from the grill. Call a gas appliance serviceman or L.P. gas dealer. DO NOT use grill until the leak is corrected.

When to test for leaks:

1. Perform a leak test each time the gas supply cylinder is connected to the regulator. Leak test anytime a part of the gas system is replaced.
2. Perform a leak test at least once each year whether the L.P. gas supply cylinder has been disconnected or not.
3. Have a dealer check the cylinder for deterioration after 12 years, according to DOT regulations. Immediately replace cylinder if any deterioration is found

⚠ CAUTION

Inspect the gas supply hoses before each use. If there are cuts, damage, excessive abrasion or wear, replace the hoses prior to operating the appliance. During assembly of grill and when attaching or replacing the L. P. gas cylinder, insure that all gas supply hoses are free of kinks and/or damage and are at least 3" away from hot surfaces such as the grill housing. Use only hose replacements specified in the parts list.

Start-Up Check List

⚠ WARNING

Failure to follow these safety steps before using grill each time could result in a fire that could be hazardous to you, your appliance or property. It is especially important to observe these steps after the grill has been stored, moved or cleaned.

- 1. Inspect the gas supply hoses before each use. Hoses can be burned or chafed if they are routed improperly. See that hoses have no kinks, sharp bends or tension. Insure that hoses are at least 3 inches away from any hot surface. If it is evident that there is excessive abrasion or wear, or the hose is cut, it must be replaced prior to the grill being put into operation.
- 2. Use only the gas specified.
- 3. Keep the grill on a level surface and lock the castors.
- 4. Keep grease pans empty at start up.
- 5. Do not use charcoal or lighting fluid.

Lighting the Grill

⚠ WARNING

THE FOLLOWING RULES MUST ALWAYS BE FOLLOWED IN THIS ORDER :

1. Check that the Burner Control Knobs are turned to "OFF"
2. Turn on fuel supply. For an L.P. gas cylinder, turn the top cylinder valve knob counterclockwise to open.
3. DO NOT stand with head or arms over grill.

⚠ WARNING

This procedure MUST be performed OUTDOORS only! Be sure L.P. cylinder valve is closed. Attach to Grill. Read and follow directions on the cylinder and fuel hose safety tags.

⚠ CAUTION

In the connection process, the grill side of the connection will seal on the back-check in the valve, resulting in a slight resistance. The connection requires about one-half to three-quarters additional turn to complete the connection. To disconnect, turn counterclockwise. Tighten by hand only. DO NOT use tools.

Step 1

- Make sure Burner Valves are in OFF position.



NOTE: Follow this Lighting Procedure to light Burners on one side of the grill then repeat to light the Burners on the other side of the grill.

Step 2

- Turn on fuel supply on righthand L.P. gas cylinder.

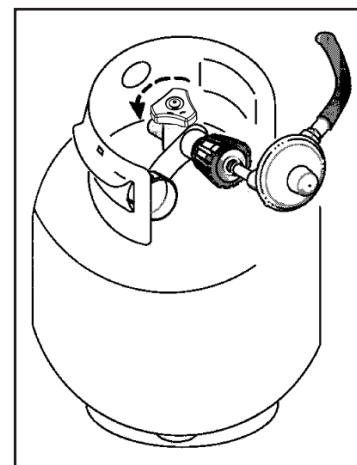

Lighting the Grill continued

Step 3

- Turn Righthand Burner Valve to "High."
 - Press Igniter Button to light.
 - NOTE:** If the flame doesn't immediately light, turn off control knob and wait five minutes for gas to clear.
 - Repeat steps 1 through 3.
 - If the burner does not light on second try, turn off knob and try match-lighting the burner.
 - Repeat steps 2 and 3 for Lefthand L.P. gas cylinder and Lefthand Burner.
- NOTE:** You must push Igniter Button to ignite the second side of the grill.



- All Burner Valves can be adjusted from "Low" to "High."

Match Lighting

- Use a LONG wooden match or the match extension provided. Make sure all burner controls are off except one being lighted.
- Insert a match in the holder end of the extension, strike the match and place the match near the burner from above.
- Turn on BURNER CONTROL KNOB while holding match near burner.
- You must use another match to ignite the second side of the grill.

Tear Down/Clean

Step 1

- Make sure Burner Valves are in OFF position.
- Allow unit to cool completely.



Step 2

- Turn off fuel supply on both L.P. gas cylinders.

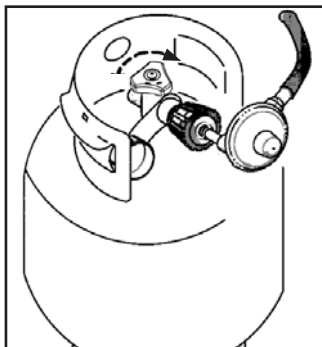

Tear Down/Clean continued

Step 3

- Remove Regulators from Propane Cylinder Connection.

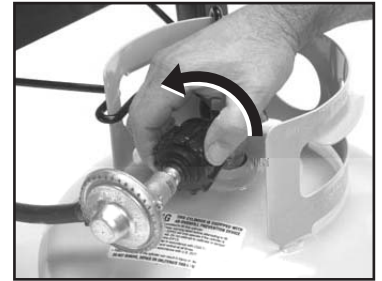

Step 4

- Remove Grease Pans. Slide out from front of grill to clean or install new aluminum liners in Grease Pans.

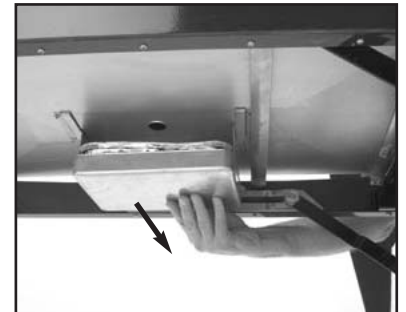

Step 5

- Unlock tab as shown.
- Slide out Grease Tray.
- Clean thoroughly before storing grill.

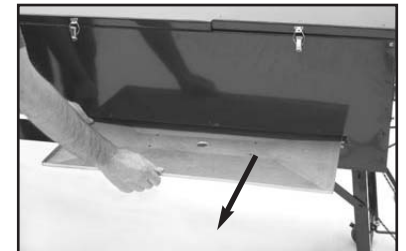

- Slide Grease Tray back into position under grill and lock tab.



Step 6

- Center Lid goes on first.



Step 7

- Lift up on Right Side Shelf to remove from grill and fold in flaps as shown.

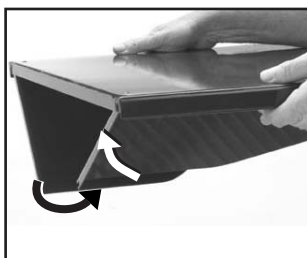
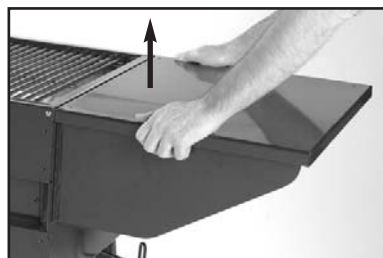

Step 8

- Place folded up Right Lid (Shelf) on grill.

IMPORTANT: Make sure Lid fits into Channel on Center Lid.

- Repeat to store Left Lid (Shelf).
- Be sure to replace all three lids after use.

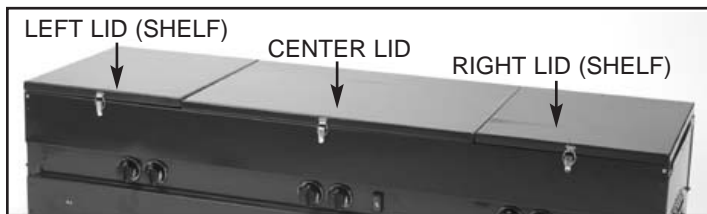
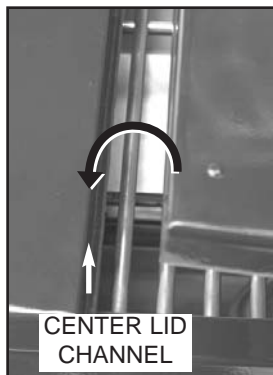

Step 9

- Remove 20 lb. L.P. gas cylinders from Lower Tank Mounts. For easier removal, rotate the tank out of the upper tank support, then remove the tank from the lower support. Secure the Tank Mounts as shown.

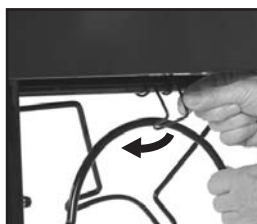

Step 10

- Remove Leg Brace.

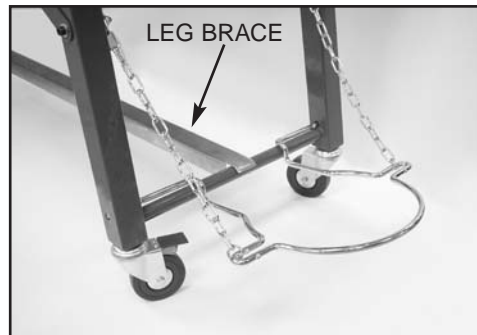

Step 11

CAUTION

Because of its size and weight, it is recommended that there are at least two (2) people available to raise legs to the storage position.

- To raise Legs, pull out on Braces while depressing the Catches to unlock.

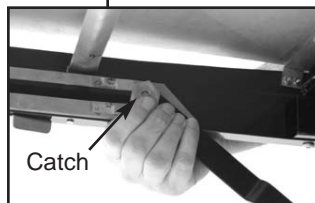

- Raise Legs to storage position.
- Lock Grill Legs as shown.



General Use and Correct Burner Flames

⚠ WARNING

- Keep grill area clean and free from combustible materials, gasoline and other flammable vapors, liquids, and spare L.P. cylinders.
- DO NOT obstruct the flow of combustion and ventilation air.
- Keep the ventilation opening(s) of the L.P. cylinder enclosure free and clear of debris.
- A barbecue grill becomes hot during use. DO NOT touch grates, or cooking surfaces.
- Be sure to tighten all hardware (screws, nuts, bolts, etc.) at least once a year or each grilling season.

Condition The Grill

- Before using the grill for the first time or after storage, operate grill 15 minutes on high setting, with lid removed, to burn away oil.
- Once the oil has burned away, check the burner flame per next step.

The Burner Flame

- Keep the cooking surfaces in place.
- Observe the burner's flame from above, through the grates.
- Flames should appear similar to the good flame shown in Fig. 17 and as follows:
- A good flame should be blue with yellow tip.
- Some yellow tips on flames up to 1" in length are acceptable as long as no carbon or soot deposits appear.
- If flames are excessively yellow and irregular, the oil residue may not be completely burned off, or the venturi may be clogged or may not be properly positioned over the orifices. Allow grill to cool before repositioning venturi over valve and orifices.
- Grills that have been in use for a while sometimes begin to show more yellow flame. A build-up of food deposits, fats or cooking seasonings can cause yellowing flames.

Storage

- Disconnect regulator from cylinder. If stored indoors, detach and leave cylinder outdoors.
- Store propane tank in safe manner. Refer to Chapter 5 of *Standard for Storage and Handling of Liquefied Gases*, ANSI/NFPA 58. Follow all local codes. Always store propane tanks outdoors.
- Store grill in a dry, clean and safe place.

- For long-term storage, clean and dry all grill parts before storing. This will keep the unit clean and ready for the next season.

Maintenance

WARNING



• BURN HAZARD

- Do not touch or attempt any maintenance on grill for at least one hour after use.
- Make sure all controls are off and propane tank has been removed before doing maintenance.

To enjoy years of outstanding performance from your grill, perform the following maintenance activities on a regular basis:

- Keep exterior surfaces clean.
- Use warm soapy water for cleaning. Never use flammable or abrasive cleaning agents.

- Airflow must be unobstructed. Keep controls, burner and circulating air passages clean. Signs of possible blockage include:
 - Gas odor
 - Grill makes popping noises
 - Smoky flame.
- Carbon deposits may create a fire hazard. Clean burner with warm soapy water if any carbon deposits develop.
- If the grill has been left uncovered and is wet from rain, snow, yard sprinklers, etc., allow to dry (at least 30 minutes prior to use).
- NOTE: In a salt-air environment (such as near an ocean), corrosion occurs more quickly than normal. Frequently check for corroded areas and repair them promptly.
- For more complicated maintenance or to obtain repairs, please contact The Coleman Company, Inc.

Things You Should Know

1. It is unsafe and illegal in some places to store or use propane cylinders of greater than 1.14 kg (2.5 lbs) water capacity (approximately 1 lb. propane) in occupied enclosures.
2. If not completely satisfied with the performance of this product, please call one of the numbers listed on the cover of this manual.
3. Cool weather prevents proper vaporization of propane inside the tanks. For best results, do not use below 32° F (0°C).

Troubleshooting

Problem	Possible Cause	Solution
Burner won't light	Gas pressure is low.	Cylinder is empty. Replace cylinder.
	Air in gas line.	Burner may take up to one minute to light after a propane cylinder has been connected.
	Igniter is wet.	Light the grill with a match.
Burner won't stay lit	Dust and/or dirt built up around burner	Clean dirt and/or dust from around burner.
Burner flame is low	Gas pressure is low	Replace cylinder.
	Outdoor temperature is less than 40° F and tank is less than 1/4 full.	Use a full cylinder.
	Fuel flow is restricted.	Check burner and orifices for blockage. Adjust control knob to full ON position.
Improper Flame (Flame should be blue with hint of yellow on tips)	Fuel flow is restricted. Excessive yellow flames.	Check burner, orifices and venturi for blockage (bugs, dirt, cobwebs).

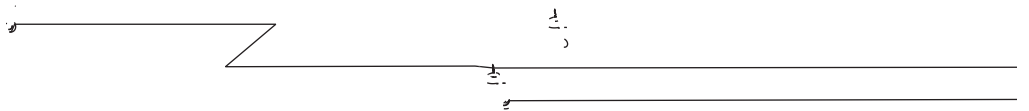

Coleman Limited One-Year Warranty

The Coleman Company, Inc. ("Coleman") warrants that for a period of one year from the date of original retail purchase, this product will be free from defects in material and workmanship. Coleman, at its option, will repair or replace this product or any component of the product found to be defective during the warranty period. Replacement will be made with a new or remanufactured product or component. If the product is no longer available, replacement may be made with a similar product of equal or greater value. This is your exclusive warranty.

This warranty is valid for the original retail purchaser from the date of initial retail purchase and is not transferable. Keep the original sales receipt. Proof of purchase is required to obtain warranty performance. Coleman dealers, service centers, or retail stores selling Coleman products do not have the right to alter, modify or in any way change the terms and conditions of this warranty.

This warranty does not cover normal wear of parts or damage resulting from any of the following: negligent use or misuse of the product, use on improper voltage or current, use contrary to the operating instructions, disassembly, repair or alteration by anyone other than Coleman or an authorized service center. Further, the warranty does not cover Acts of God, such as fire, flood, hurricanes and tornadoes.

COLEMAN SHALL NOT BE LIABLE FOR ANY INCIDENTAL OR CONSEQUENTIAL DAMAGES CAUSED BY THE BREACH OF ANY EXPRESS OR IMPLIED WARRANTY OR CONDITIONS. SOME STATES, PROVINCES OR JURISDICTIONS DO NOT ALLOW THE EXCLUSION OR THE LIMITATION OF INCIDENTAL OR CONSEQUENTIAL DAMAGES, SO THE ABOVE LIMITATION OR EXCLUSION MAY NOT APPLY TO YOU. EXCEPT TO THE EXTENT PROHIBITED BY APPLICABLE LAW, ANY IMPLIED WARRANTY OF MERCHANTABILITY OR FITNESS FOR A PARTICULAR PURPOSE IS LIMITED IN DURATION TO THE DURATION OF THE ABOVE WARRANTY OR CONDITIONS. SOME STATES, PROVINCES OR JURISDICTIONS DO NOT ALLOW LIMITATIONS ON HOW LONG AN IMPLIED WARRANTY LASTS, SO THE ABOVE LIMITATIONS MAY NOT APPLY TO YOU. This warranty gives you specific legal rights, and you may also have other rights that vary from state to state or province to province.

HOW TO OBTAIN WARRANTY SERVICE

Take the product to an authorized Coleman service center. You can find the nearest authorized Coleman service center by calling 1-800-835-3278 or TDD 316-832-8707 in the United States. If a service center is not conveniently located, attach to the product a tag that includes your name, address, daytime telephone number and description of the problem. Include a copy of the original sales receipt. Carefully package the product and send either by UPS or Parcel Post **insured** with **shipping** and **insurance** prepaid to:

For products purchased in the United States:
The Coleman Company, Inc.
3600 North Hydraulic
Wichita, KS 67219

Do not mail products with fuel in tanks, or with disposable propane cylinders.

DO NOT RETURN THIS PRODUCT TO THE PLACE OF PURCHASE.

If you have any questions regarding this warranty please call 1-800-835-3278 or TDD 316-832-8707 in the United States.

The Coleman Company, Inc.
3600 N. Hydraulic
Wichita, KS 67219 U.S.A.
1-800-835-3278
TDD: 316-832-8707
www.coleman.com



The Coleman Company, Inc. • 3600 N. Hydraulic • Wichita, KS 67219 U.S.A.
1-800-835-3278 • TDD: 316-832-8707

©2004 The Coleman Company, Inc. All rights reserved.

Coleman® and  are registered trademarks of The Coleman Company, Inc.