



Operation Manual

Linear servomotor AL2xxx

Air and water-cooled options

Version: 6.2
Date: 2018-09-21

BECKHOFF

Table of contents

1 Foreword	5
1.1 Notes on the documentation.....	5
1.2 Documentation issue status	6
1.3 Intended use.....	7
2 Guidelines and Standards	8
2.1 EC declaration of conformity	8
3 For your safety.....	9
3.1 Staff qualification	9
3.2 Description of symbols	10
3.3 Notes on the AL2xxx linear motors.....	11
4 Handling	14
4.1 Transport	14
4.2 Storage	14
4.3 Maintenance / Cleaning.....	15
4.4 Disposal.....	15
5 Product identification.....	16
5.1 AL2xxx scope of delivery	16
5.2 AL2xxx name plate	16
5.3 AL2xxx type key	16
6 Technical description.....	17
6.1 Design of the motors	17
6.2 General technical data.....	17
6.2.1 Power derating.....	17
6.3 Standard features	18
6.3.1 Coil unit, primary part (N/S)	18
6.3.2 Magnetic plate, secondary part.....	18
6.3.3 Magnetic Encoder System (MES) (optional).....	19
6.4 Additional equipment	19
6.4.1 Servo drive and feedback system.....	20
7 Mechanical installation	21
7.1 Important notes.....	21
7.2 Order of assembly of the work unit.....	22
7.3 Assembling the magnetic plates	23
7.3.1 Inserting the locating pins	23
7.3.2 Attachment of the magnetic plates	24
7.3.3 Coil unit and magnetic plate	24
7.4 Coupling of linear servomotors.....	25
7.4.1 Temperature sensor	25
7.4.2 Layout of the motors	25
7.4.3 Calculation of the offset	26
7.4.4 Layout of the wiring.....	26
7.4.5 Positions of the phase lines	27
7.4.6 Minimum distance between the motors	29

7.5	Dismantling sequence	30
8	Electrical installation.....	31
8.1	Important notes.....	31
8.2	Connection of motors	32
8.2.1	Single conductors	32
8.2.2	M23 connector for power supply and D-Sub connector for temperatur contact	33
8.3	Connection with pre-assembled cables and connector box AL225x	34
8.3.1	AX5000 connection diagram with MES and Sin/Cos encoder without zero pulse.....	35
8.3.2	AX5000 connection diagram for AL2xxx and absolute value encoder	36
8.3.3	AX5000 connection diagram for AL2xxx and Sin/Cos encoder with zero pulse	37
8.3.4	AX5000 connection diagram for AL2xxx and TTL encoder with zero pulse	38
8.4	Temperature sensor	39
8.4.1	PTC specification.....	39
8.4.2	KTY Specification	39
8.5	Polarity test.....	40
9	Installation of the water cooling.....	41
9.1	General.....	41
9.2	Requirements	41
9.3	Installation of the water cooling connections	42
9.3.1	AL2xxx.....	42
9.3.2	AL28xx-1 water-cooled	42
9.4	Connecting the hoses.....	43
10	Commissioning.....	44
10.1	Important notes.....	44
10.2	General commissioning	44
10.2.1	Parameterisation.....	44
10.2.2	Commissioning	45
10.2.3	Optimising the control settings.....	45
10.3	Troubleshooting.....	46
11	Technical data.....	47
11.1	Term definitions	47
11.2	AL20xx.....	48
11.2.1	Dimensional drawing, AL20xx and AL21xx	50
11.3	AL24xx.....	51
11.3.1	Dimensional drawing, AL24xx and AL25xx	52
11.4	AL28xx-0 air-cooled.....	53
11.4.1	Dimensional drawing, AL28xx-0 air-cooled and AL29xx	54
11.5	AL28xx-1 water-cooled.....	55
11.5.1	Dimensional drawing, AL28xx-1 water-cooled and AL29xx.....	56
11.6	Calculation of the brake resistor	57
12	Support and Service.....	58

1 Foreword

1.1 Notes on the documentation

This description is only intended for the use of trained specialists in control and automation engineering who are familiar with the applicable national standards.

It is essential that the documentation and the following notes and explanations are followed when installing and commissioning the components.

It is the duty of the technical personnel to use the documentation published at the respective time of each installation and commissioning.

The responsible staff must ensure that the application or use of the products described satisfy all the requirements for safety, including all the relevant laws, regulations, guidelines and standards.

Disclaimer

The documentation has been prepared with care. The products described are, however, constantly under development.

We reserve the right to revise and change the documentation at any time and without prior announcement. No claims for the modification of products that have already been supplied may be made on the basis of the data, diagrams and descriptions in this documentation.

Trademarks

Beckhoff®, TwinCAT®, EtherCAT®, Safety over EtherCAT®, TwinSAFE®, XFC® and XTS® are registered trademarks of and licensed by Beckhoff Automation GmbH.

Other designations used in this publication may be trademarks whose use by third parties for their own purposes could violate the rights of the owners.

Patent Pending

The EtherCAT Technology is covered, including but not limited to the following patent applications and patents:

EP1590927, EP1789857, DE102004044764, DE102007017835

with corresponding applications or registrations in various other countries.

The TwinCAT Technology is covered, including but not limited to the following patent applications and patents:

EP0851348, US6167425 with corresponding applications or registrations in various other countries.

EtherCAT 

EtherCAT® is registered trademark and patented technology, licensed by Beckhoff Automation GmbH, Germany

Copyright

© Beckhoff Automation GmbH & Co. KG, Germany.

The reproduction, distribution and utilization of this document as well as the communication of its contents to others without express authorization are prohibited.

Offenders will be held liable for the payment of damages. All rights reserved in the event of the grant of a patent, utility model or design.

1.2 Documentation issue status

Origin of the document

This documentation was originally written in German. All other languages are derived from the German original.

Product features

Only the product features specified in the current user documentation are valid. Further information given on the product pages of the Beckhoff homepage, in emails or in other publications is not authoritative.

Issue	Comment
6.2	<p>Chapter revision: Technical data AL20xx 11.2; Technical data AL24xx 11.3; Technical data AL28xx-0 air-cooled 11.4; AL28xx-1 water-cooled 11.5</p> <p>Removed Chapter: M23 connector for power supply and temperature contact 8.2.3</p>
6.1	<p>Chapter revision: EC declaration of conformity 2.1; AL2xxx name plate 5.2; AL2xxx type key 5.3; Connection of motors with 8.2 Connection diagrams for AL2xxx 8.3.1 – 8.3.4; Technical data AL2418 11.3</p> <p>New chapter: M23 connector for power supply and temperature contact 8.2.3</p>
6.0	Complete revision
5.8	<p>Chapter revision: Technical data 10.2 – 10.5</p>
5.7	<p>Chapter revision: Disposal 4.5</p>
5.6	<p>Chapter revision: EC Declaration of Conformity 2.1; Technical data 11</p>
5.5	<p>Chapter revision: 1.0 Foreword; 3.0 Safety</p>
5.4	<p>Chapter revision: Documented motors; 6.3.3; 7.4.2; 8.2.2; 8.4.2; 11.2; 11.3; 11.4; 11.5; 11.5.1</p>
5.3	<p>Chapter revision: 11.2; 11.3; 11.4; 11.5</p>
5.2	<p>Chapter revision 8.2 became 8.3; 3.2</p> <p>New chapter 8.2; 8.2.1; 8.2.2</p>
5.1	<p>Chapter revision Documented motors - chapter; 3.2; 11; 11.1: 11.2; 11.3; 11.4; 11.5</p>
5.0	<p>Chapter revision Documented motors - chapter; 1.2; 2.1; 3.2; 4.2; 4.3; 4.5; 6.3.2; 6.3.3; 7; 7.3; 7.3.2; 7.4.6; 7.5; 8.2.1; 8.2.2; 8.2.3; 8.2.4; 8.3.2; 9.3.1;10; 10.2.3; 10.3; 11; 11.1; 11.2; 11.2.1; 11.4; 11.5.1; 11.6</p> <p>Complete revision</p>

1.3 Intended use

Linear servo motors from the AL2xxx series are intended exclusively for driving handling devices, textile machines, machine tools, packaging machines and similar machines that place high demands on the dynamics.

The linear motors are installed exclusively as components in electrical systems or machines and may only be put into operation as integrated components of the plant or machine.

The thermal protection contact incorporated in the motor windings must be analyzed and monitored.

WARNING

Caution - Risk of injury!

Basically, electronic devices are not fail-safe. The machine manufacturer is responsible for ensuring that the connected motors and the machine are brought into a safe state in the event of a fault in the drive system.

The linear motors may be operated **only** under the environmental and operating conditions [► 17] defined in this documentation.

Improper use

Beckhoff linear motors from the AL2xxx series are not suitable for use in the following areas:

- in ATEX zones without a suitable housing
- in areas with aggressive environments (e.g. aggressive gases or chemicals)

The relevant standards and directives for EMC interference emissions must be complied with in residential areas.

2 Guidelines and Standards

CAUTION

Personal injuries!

Linear servomotors from the AL2xxx series are **not** products within the meaning of the EU machinery directive. Operation of the linear servomotors in machines or systems is only permitted once the machine or system manufacturers has provided evidence of CE conformity of the complete machine or system.

2.1 EC declaration of conformity

Provision of EU Declaration of Conformity:

Beckhoff Automation GmbH & Co. KG will be glad to provide you with EU declarations of conformity and manufacturer's declarations for all products upon request to info@beckhoff.com.

3 For your safety

Read the section on safety and heed the notices to protect yourself against personal injury and material damages.

Limitation of liability

The entire components of the Beckhoff AL2xxx linear motors are delivered in certain hardware and software configurations according to the application requirements. Unauthorized modifications to the hardware and/or software configurations other than those described in the documentation are not permitted, and nullify the liability of Beckhoff Automation GmbH & Co. KG.

In addition, the following actions are excluded from the liability of Beckhoff Automation GmbH & Co. KG:

- Failure to comply with this documentation
- [Improper use \[► 7\]](#)
- Untrained personnel
- Use of unauthorized spare parts

3.1 Staff qualification

All depicted work to be done on the Beckhoff software and hardware, and in particular on the AL2xxx linear motors, may be carried out only by technical personnel with knowledge of control and automation technology.

The technical personnel must have knowledge of drive technology and electrical systems and must also know how to work safely on electrical equipment and machines.

This also includes:

- production planning and
- securing of the working environment (e.g. securing the control cabinet against being switched on again).

The technical personnel must be familiar with the current and necessary standards and directives for the automation and drive environment.

3.2 Description of symbols

In this documentation the following symbols are used with an accompanying safety instruction or note. The safety instructions must be read carefully and followed without fail!

Symbols that warn of personal injury:

DANGER

Serious risk of injury!

This is an extremely dangerous situation. Disregarding the safety notice will lead to serious permanent injuries or even death.

WARNING

Risk of injury!

This is a dangerous situation. Disregarding the safety notice may lead to serious injuries.

CAUTION

Personal injuries!

This is a dangerous situation. Disregarding the safety notice may lead to minor injuries.

Symbols that warn of damage to property or equipment:

NOTE

Warning of damage to property or the environment!

This notice indicates disturbances in the operational procedure that could damage the product or the environment.

Symbols indicating further information or tips:

Tip or pointer!



This notice provides important information that will be of assistance in dealing with the product or software. There is no immediate danger to product, people or environment.



UL note!

This symbol indicates important information regarding UL certification.

3.3 Notes on the AL2xxx linear motors

The notes are intended to avert danger and to provide instructions on the handling of the AL2xxx linear motors. They must be followed during installation, commissioning, production, troubleshooting, maintenance and trial or test assemblies.

The linear motors from the AL2xxx series cannot run as stand-alone devices. They must always be installed in a machine or system. After installation the additional documentation and safety instructions provided by the machine manufacturer must be read and followed.

DANGER

Danger to life due to high voltage on the DC link capacitors of the servo drive AX8000!

The DC link capacitors RB+ and RB- and the test contacts DC+ and DC- on the **supply, axis and option modules** can carry life-threatening voltages of $\geq 875 V_{DC}$.

Take the following measures to avert danger:

- After disconnecting the servo drive from the mains supply, wait until the voltage has fallen below 50 V_{DC} . Only then is it safe to work.
- Measure the voltage on the test contacts properly.
- Secure the work area properly and wear the PPE.

DANGER

Deadly danger due to high voltage on the DC link capacitors of the AX5000 servo drive!

Due to the DC link capacitors, the DC link terminal points "ZK+ and ZK- (DC+ and DC-)" and "RB+ and RB-" may be subject to dangerous voltages of up to $875V_{DC}$, even after the servo drive was disconnected from the mains supply.

Take the following measures to avert danger:

- **Wait:**
 - **5** minutes in the case of the AX5101 - AX5125 and AX520x
 - **15** minutes in the case of the AX5140/AX5160/AX5172
 - **30** minutes in the case of the AX5190/AX5191
 - **45** minutes in the case of the AX5192/AX5193
- after disconnecting the servo drive from the mains supply. It is only safe to work after the voltage has dropped below 50 V.
- Measure the voltage on the test contacts properly.
 - Secure the working area properly and wear the PPE.

CAUTION

Proper connection of the protective earth conductor!

Protective earth systems must be connected when installing electrical systems and components.

Please observe the following notes when installing the protective earth conductor:

- Make sure that the protective earth conductor has been firmly connected.
- Disconnect the servo drive and all electrical components from the mains supply. Secure the control cabinet and the devices against being switched on again.
- Wear PPE.

⚠ WARNING**Risk of severe burns due to hot surfaces on the linear motor!**

During the operation of the system the surface temperature of the linear motors can reach $\geq 50^{\circ}\text{C}$. There is an acute risk of sustaining burns to parts of the body and limbs.

Take the following measures to avert danger:

- Do not touch any components (housing, etc.) shortly after or during operation.
- Wait until all components have cooled sufficiently. At least 15 minutes.
- Check the surface temperature with a thermometer.
- **DO NOT** wear work gloves with a rubber coating. These can fuse with the skin on account of the high temperature and cause serious injuries.

● Notes on the operation of the AL2xxx linear motors:**i**

- Read this manual carefully and completely before using the linear motor. Notify the responsible sales office immediately if any passages are not understandable. Do not work on the linear motor.
- Adhere without fail to the climatic conditions for the installation. Further information can be found in the [Technical data \[▶ 47\]](#) and [Mechanical installation \[▶ 21\]](#) sections.

NOTE**High temperatures can damage the magnets!**

Do not expose the magnets to temperatures $\geq 70^{\circ}\text{C}$. This can lead to demagnetization.

●
i**Deadly danger due to the magnetic fields of the linear motor!**

The AL2xxx linear motors are equipped with permanent magnets in the magnetic plate. Strong magnetic fields are present here. In the power-off state, the magnetic field strength of the motors results exclusively from the magnetic fields of the secondary part.

There is a particular danger for:

people fitted with cardiac pacemakers
(The cardiac pacemaker can be switched to test mode and thus cause a cardiac arrest!)

People with implanted defibrillators
(The defibrillators can be rendered inoperative by the magnetic field!)

NOTE**Loss of data due to magnetic fields!**

- Magnetic data storage devices
- Chip cards with magnetic strips and
- Electronic devices can be demagnetized by magnetic fields.

There is a risk of the loss of data.

The objects listed above and loose-lying ferromagnetic objects may **not** be brought any closer than **1 m** to the magnetic plates.

The requirements in BGV B 11 applying to magnetic fields and the national regulations applicable in other countries must be observed.

⚠ CAUTION**Risk of crushing and injury due to magnets!**

The AL2xxx linear motors are equipped with permanent magnets in the magnetic plate. (Crushing) injuries may be sustained during commissioning due to magnetic attractive forces.

Take the following measures to avert danger:

- Move the magnetic components slowly towards one another.
- Wear PPE for all work on the magnets!
- Avoid shocks or jerky contact between magnets. This could lead to splintering and eye injuries. Wear safety goggles.
- Make sure that there are no ferromagnetic tools or materials nearby in your working environment. These could be attracted by the magnetic field and cause injuries to body parts.

● Notes on the transport of magnetic material!

i Please observe the IATA regulation 953 when transporting magnetic material. The AL2xxx magnetic plates fall below the limit values and may be dispatched.

4 Handling

4.1 Transport

NOTE

Short-circuit due to moisture in the AL2xxx linear motors!

Condensation may form when transporting in cold weather or in the case of extreme temperature differences:

- Make sure that no moisture condenses inside the linear motor packaging (bedewing). Equalize the room temperature slowly. Only switch the linear motor on when it is completely dry.

Despite the sturdy construction, the components are sensitive to strong vibrations and impacts.

During transport, protect the product against:

- high mechanical stress
- large temperature fluctuations (max. 20 K/hour)
- excessively high humidity (max. relative humidity 95%, non-condensing)

For the dispatch, use proper packaging that meets the requirements specified in this chapter for the transport of the linear motors. This could also be the manufacturer's original packaging.

Since linear motors contain electrostatically sensitive components that can be damaged by improper treatment:

- Avoid electrostatic charging before you touch the device or components directly.
- Avoid contact with highly insulating materials (synthetic fibers, plastic film etc.).
- Place the servo drive on a conductive surface.
- If the packaging is damaged, inspect the linear motor and any accessories for visible damage. Inform the transport company and, if necessary, the manufacturer.

Packaging

Motor type	Max. stacking height
AL2xxx	8

4.2 Storage

- The linear motor and accessories may not be stored outdoors. The storage space must be adequately ventilated and dry.
- The devices may only be stored in the manufacturer's original packaging.
- Climate category: 2K3 according to EN 60721
- Storage temperature: -25°C to +55°C, max. fluctuation 20 K/hour
- Air humidity: relative humidity max. 95%, non-condensing
- Storage time: without limitation

4.3 Maintenance / Cleaning

- Maintenance and cleaning only by qualified personnel.
- Opening the motor invalidates the warranty.
- Clean the housing with isopropanol or similar.

NOTE

Destruction of the linear servomotor

Never immerse or spray the linear servomotor.

Proper functioning of the bearings and buffers, and guidance of the movable lines, must all be tested.

4.4 Disposal

In accordance with the WEEE 2012/19/EU Directives we take old devices and accessories back for professional disposal, provided the transport costs are taken over by the sender.

Send the devices with the note "For disposal" to:

Beckhoff Automation GmbH & Co. KG
Huelshorstweg 20
D-33415 Verl

5 Product identification

5.1 AL2xxx scope of delivery

Please check that the delivery includes the following items:

- Motor from the AL2xxx series
- Type plate

5.2 AL2xxx name plate

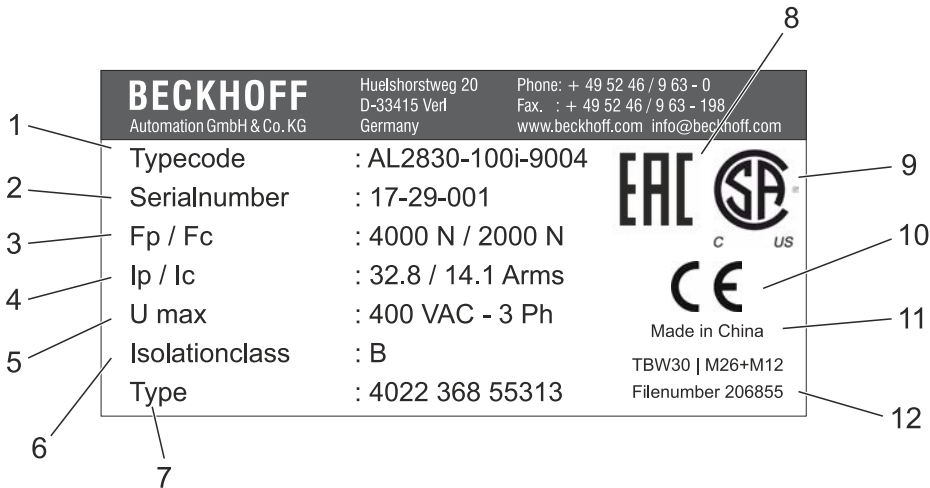

Pos. - No.	Description
1	Type of the linear motor
2	Serial number
3	Peak force
4	Peak current
5	Max. Voltage
6	Insulation class
7	Type code
8	EAC mark of conformity
9	CSA mark of conformity
10	CE mark of conformity
11	Country of manufacture
12	File number

5.3 AL2xxx type key

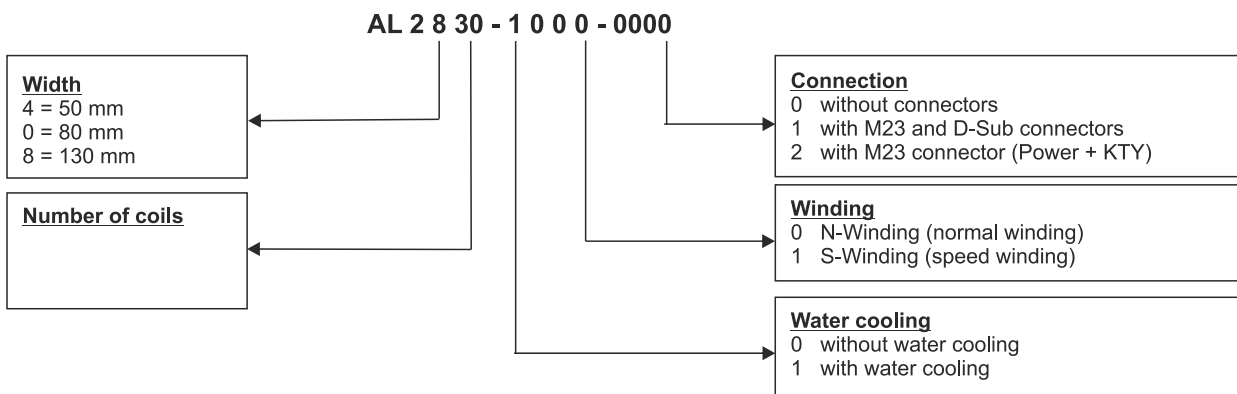

6 Technical description

6.1 Design of the motors

The linear servomotors from the AL2xxx series are brushless three-phase motors for high-quality servo applications. In conjunction with our digital servo drives they are particularly suitable for positioning tasks in industrial robots, machine tools, transfer lines, handling equipment, textile machines, packaging machines, etc. with high requirements for dynamics and stability. The motors from the AL2xxx series are intended to be operated exclusively by a digital servo drive with speed and torque control.

The linear servomotors are equipped with permanent magnets in the magnetic plate. This advanced neodymium magnetic material makes a significant contribution to the motors' exceptional dynamic properties. A three-phase coil unit supplied by the servo drive is housed in the coil unit. The motor has no brushes; the commutation being implemented electronically in the servo drive.

Furthermore, a feedback system is necessary for operation. The suitable feedback system must be selected on the basis of the application requirements. Dynamics, speed, contamination levels, resolution and the servo drive must be considered (see also the section entitled Magnetic Encoder System (MES) (optional) [▶ 19]).

6.2 General technical data

Ambient and operating conditions	
Climate category	3K3 according to EN 60721
Ambient temperature (at rated values)	+5 - +40 °C for installation altitudes up to 1000 m amsl → see section entitled <u>Power derating</u> [▶ 17]
Permissible humidity (at rated values)	95% relative humidity, non-condensing
Installation altitude (currents and torques)	At installation altitudes of 1000 m or higher above sea level and an ambient temperature of 40 °C → see section entitled <u>Power derating</u> [▶ 17]
Technical data	→ See section entitled <u>Technical data</u> [▶ 47]

6.2.1 Power derating

Ambient temperature

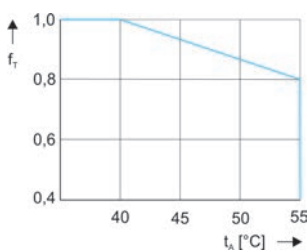

f_T = Temperature utilization factor
 t_A = Ambient temperature °C

Installation altitude

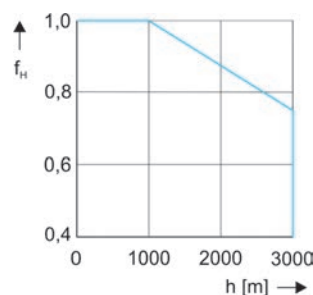

f_H = Altitude utilization factor
 h = Altitude in meters

Calculation of the power data when exceeding the specified temperature limit > 40 °C:

$$F_{CA_red} = F_{CA} \times f_T$$

Calculation of the power data when exceeding the specified installation altitude ≥ 1000 m:

$$F_{CA_red} = F_{CA} \times f_H$$

Calculation of the power data when exceeding the specified limits:

Ambient temperature > 40 °C and installation altitude ≥ 1000 m

$$F_{CA_red} = F_{CA} \times f_T \times f_H$$

6.3 Standard features

Machine concept

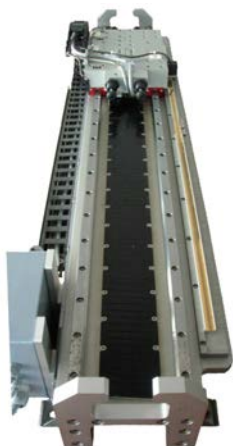

The AL2xxx linear servomotor series from Beckhoff is not a self-contained system. It includes various components such as a coil unit and magnetic plates and must be integrated into a complete machine concept or a complete working unit.

The size and shape of the carrier frame, the design of the carriage, the type of rail and type of bearings, and the kind of buffer used depend on the application. The carrier frame and the carriage must be designed such that an air gap is created between the coil unit and the magnetic plate.

6.3.1 Coil unit, primary part (N/S)

Winding types

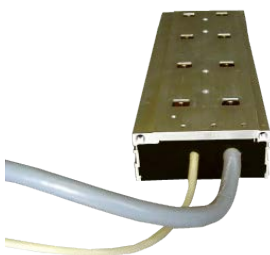

The N-type (normal winding) represents the preferred type. The S-type (speed winding) has a higher maximum speed and a higher current consumption. The dimensions of the N-type and S-type do not differ.

6.3.2 Magnetic plate, secondary part

Magnetic plates are available in various lengths and can be combined with one another as desired within a series. Different series require magnetic plates with different widths.

Magnetic plate without transport plate



Magnetic plate with transport plate



In the delivery condition the magnetic plates are covered by a transport plate. It reduces the magnetic field and thus enables simple mounting and dismounting.

Specifications and dimensional drawings can be found in the chapter: [Technical data](#) [▶ 47]

6.3.3 Magnetic Encoder System (MES) (optional)

The Magnetic Encoder System (MES) **AL2200-000y** is a position measuring system. It has an accuracy of 0.1 mm and works directly on the magnetic plates. There are no further measuring scales. Fastening takes place on the carriage.

Description of the position measuring system

The MES works absolute within the pole distance (24 mm) and semi-absolute over the entire track. The distance to the coil part is not relevant. The commutation angle is determined once during commissioning. The wake & shake at the start of the machine is thus dispensed with. Homing can be carried out if an absolute synchronization is desired.

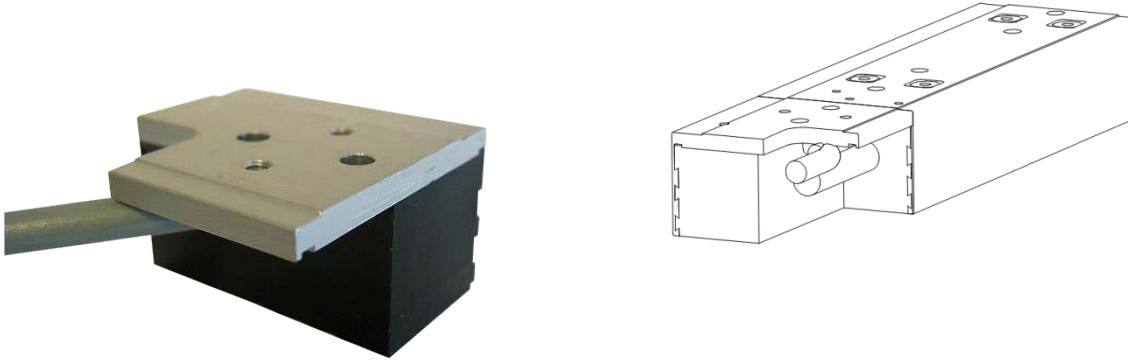

i Documentation for the Magnetic Encoder System (MES)!

Further information on the Magnetic Encoder System (MES) can be found on the Beckhoff homepage under: [MES Feedback Documentation](#) or in the Beckhoff Online Information System.

6.4 Additional equipment

You require further components for the proper installation of your linear servomotor.

These are not included in the scope of delivery.

Screws and locating pins



The screws and locating pins are needed to position and fasten the coil unit to the carriage, and also the magnetic plates to the carrier frame.

Attribute	AL20xx	AL24xx	AL28xx
Screws for magnetic plates (stainless)	M5x10, DIN7984	M5x10, DIN7984	M5x16, EN ISO 4762
Screws for coil unit (steel); Length depends on the thickness of the carriage	M5, EN ISO 4762	M4, EN ISO 4762	M5, EN ISO 4762
Locating pins (stainless)	5h8		

6.4.1 Servo drive and feedback system

The following components are required for the construction of a complete linear axis and its operation:

- Servo drive, e.g.: AX5xxx from Beckhoff Automation GmbH.
- Graduated rule and linear displacement transducer or the MES feedback system without graduated rule
- Cables and plugs
- Guides
- Mechanical support / machine bed

7 Mechanical installation

7.1 Important notes

Installation of the machine bed must be complete before installing the linear motor components. The rails must be mounted on the machine bed and aligned. The carriage must be equipped with bearings, dampers and the required lines so that the proper movement of the carriage over the track is ensured.

WARNING

Damage due to uncontrolled magnetic attractive forces

The sequence specified in this introduction for the installation must be followed. A different sequence can give rise to dangerous situations, and can lead to damage resulting from uncontrolled magnetic attraction.

● Damage due to faulty water cooling unit



If a water cooling unit is to be used, read please the section entitled Installation of the water cooling [▶ 41].

● Deadly danger due to the magnetic fields of the linear motor!



The AL2xxx linear motors are equipped with permanent magnets in the magnetic plate. Strong magnetic fields are present here. In the power-off state, the magnetic field strength of the motors results exclusively from the magnetic fields of the secondary part.

There is a particular danger for:

people fitted with cardiac pacemakers
(The cardiac pacemaker can be switched to test mode and thus cause a cardiac arrest!)

People with implanted defibrillators
(The defibrillators can be rendered inoperative by the magnetic field!)

NOTE

Loss of data due to magnetic fields!

- Magnetic data storage devices
- Chip cards with magnetic strips and
- Electronic devices can be demagnetized by magnetic fields.

There is a risk of the loss of data.

The objects listed above and loose-lying ferromagnetic objects may **not** be brought any closer than **1 m** to the magnetic plates.

The requirements in BGV B 11 applying to magnetic fields and the national regulations applicable in other countries must be observed.

CAUTION

Damage due to a magnetic field that is not neutralized

Use the magnetic plates only when they are covered by the protective plates that reduce the magnetic field.

CAUTION

Damage during dismantling due to the magnetic field

Make sure that the magnetic plates are fastened in your machine before removing the protective plates.

Put the protective plates back onto the magnetic plates before dismantling them.

Do not bring any soft-magnetic objects (iron) closer than 10 cm to the magnetic side of the magnetic plates.

7.2 Order of assembly of the work unit

Fastening the coil unit

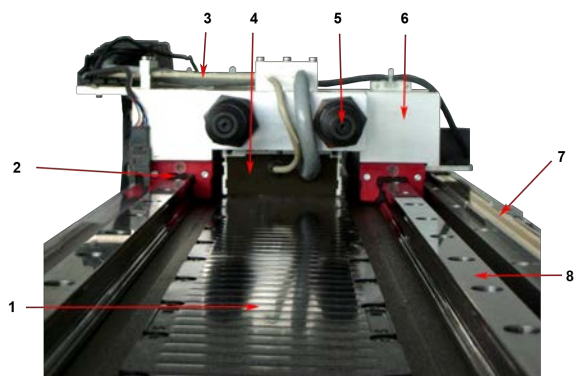

Observe the following notes before beginning assembly. Deviations from flatness of the surface on which the coil unit will rest must be less than 0.1 mm. The coil unit must be assembled parallel to the magnetic plate. Parallelism must be closer than 0.20 mm. The sides of the coil unit, or the round holes in the supporting surface, can be used for this purpose. Locating pins can be inserted into the round holes. Lateral positioning of the coil unit with respect to the magnetic plates is not particularly critical. A tolerance of up to ±0.5 mm is acceptable.

Item no.	Explanation	Item no.	Explanation
1	Magnetic plate	5	Buffers
2	Bearing	6	Carriage
3	Cabling	7	Graduated rule
4	Coil unit	8	Rail

Please note the following comments and information:

● Order of tightening the screws:

i Fasten the screws in a crisscross pattern, so that the resulting forces are distributed evenly.

NOTE

The coil unit can be damaged by incorrect screwing!

Using screws that are too long for the coil unit can cause damage that is not immediately visible, and give rise to dangerous situations.

Check:

- the screw length
- the screw height after the installation.

Screws for the coil unit	AL20xx	AL24xx	AL28xx
Screw (steel)	M5	M4	M5
Depth in the coil unit	Min: 4 mm Max: 5mm	Min: 4 mm Max: 5 mm	Min: 4.5 mm Max: 6.5 mm
Tightening torque	3.0 – 5.0 Nm	2.0 – 3.0 Nm	3.0 – 5.0 Nm

● Distance of the water cooling connections:

i Note that the connections for the water cooling can extend up to 1 mm beyond the dimensions of the coil part. Ensure that enough clearance is maintained, or else use a spacer plate at least 1 mm thick. See also the section entitled [Installation of the water cooling \[► 41\]](#) (additional installation instructions / water cooling).

7.3 Assembling the magnetic plates

Fastening the magnetic plates

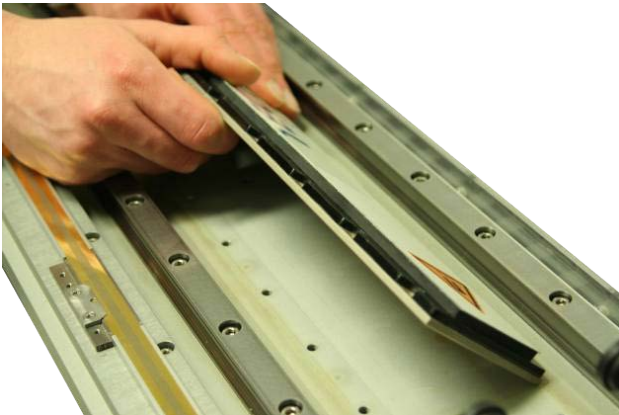

The textured side of the plate is the magnetic side. The magnetic plates exert a strong attractive force on all ferromagnetic metals such as iron. These forces cannot be controlled with the hands. They can cause serious injuries.

7.3.1 Inserting the locating pins

⚠ CAUTION

The linear motor can be damaged by unwanted movements of the carriage!

If the carriage is already mounted, move it to one end of the track and secure it to prevent unwanted movements.

● Dimensioning the locating pins:

i The locating pins may not extend any more than 3.3 mm above the machine bed.

Inserting the locating pins in the magnetic plate

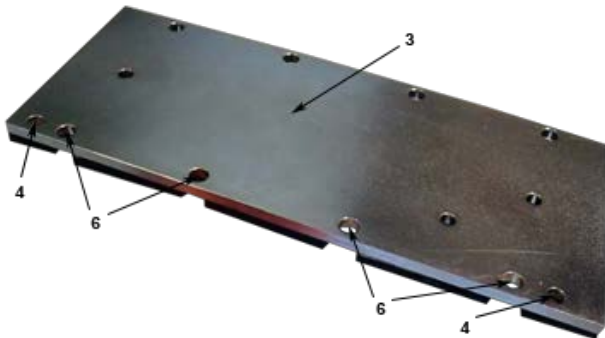

Proceed as follows:

- Manufacture the positioning holes (2) in the machine bed (1) analogous to the 5 mm positioning holes (4) in the magnetic plate (3).
- Insert the locating pins (2) into the positioning holes (2) in the machine bed (1).
- Manufacture the tapped holes (5) analogous to the mounting holes (6) in the magnetic plate (3).

Assembling the magnetic plate

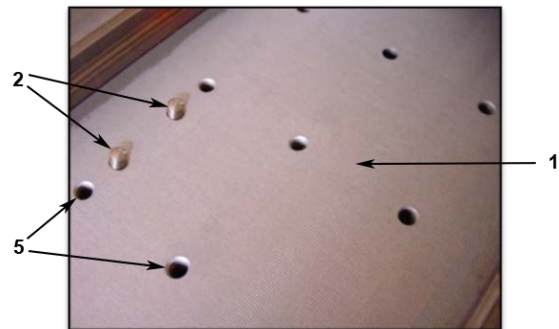

Proceed as follows:

- Cleanse the locating surface of dust and particles.
- Mount the magnetic plate on the locating surface of the track.

7.3.2 Attachment of the magnetic plates

Fastening the magnetic plate to the machine bed Removing the protective plates

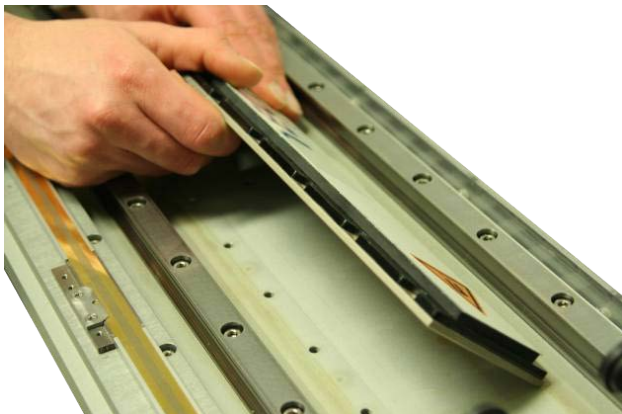

Proceed as follows:

- Align all the magnetic plates in the same direction.
Example:
All magnetic plates must be attached in such a way that the positioning holes point to the right upper corner.
- Fasten the magnetic plate to the machine bed. The minimum screw-in depth should be 6.5 mm. The tightening torque is 2.5 to 3.5 Nm.
- The other magnetic plates can now be assembled in a same way.

Proceed as follows:

- Remove all protective plates.
- Check that the carriage can move smoothly and without hindrance over the magnetic plates.
- The alignment of the magnetic plates should be checked if there are significant variations in the force when moving from one magnetic plate to the next.

● Alignment of the magnetic plates:

i Adjacent plates must attract one another. If they repel one another, they are wrongly aligned.

7.3.3 Coil unit and magnetic plate

In the case of the motors from the AL2000 and AL2400 series, observe the offset of the coil unit to the magnetic plate. The AL2800-0 series lines up flush with the magnetic plate on one side. The installation position of the respective motor is to be taken from the relevant dimensional drawings.

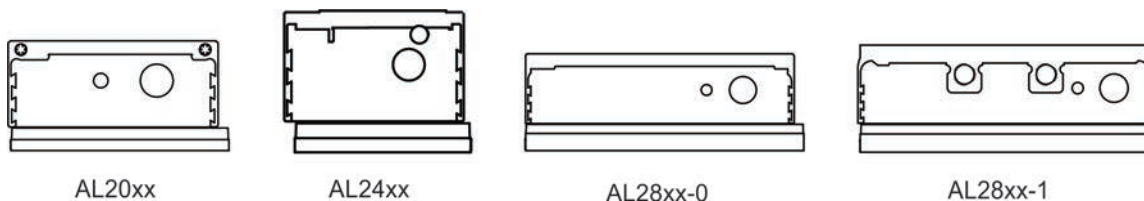

By taking into consideration the mounting height, an air gap of ≤ 0.5 mm results between the coil unit and the magnetic plate. With this air gap the motor reliably achieves its rated performance.

7.4 Coupling of linear servomotors

Linear servomotors can be connected with one another in order to act together on a magnetic track. The forces of the motors are added together. The motors are connected in parallel to the controller, which leads to a higher total current. Motors of the same type can always be connected to one another. Motors of different types but from the same series can be connected together if their power constants are equal.

7.4.1 Temperature sensor

Use the temperature sensor of the motor which has the poorest cooling and which will thus have the higher temperature development.

7.4.2 Layout of the motors

The motor windings have a fixed distance to one another that depends on the series. In the case of the AL2xxx series this is 16 mm. If linear servomotors are coupled with one another, there must be a multiple of this winding distance between the windings of the connected motors as well.

Phase repetition = 3 x winding distance = 3 x 16 mm = 48 mm

Example 1 with AL2006 and AL2012

In example 1 the connecting cables of the motors point in different directions. This enables the minimum distance between the linear servomotors.

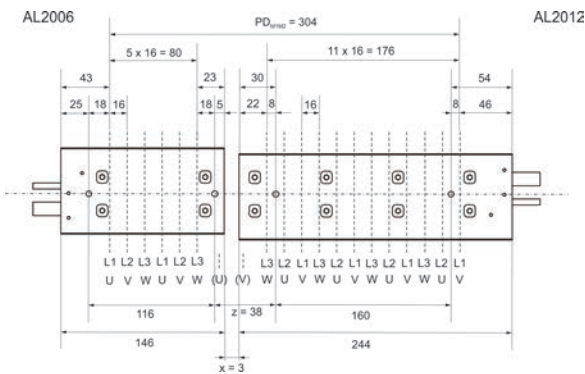

PD_{M1M2} = phase distance "Phase L1 / Motor 1" to "Phase L1 / Motor 2"
 x = Housing clearance
 z = Distance of the locating pin holes

Example 2 with AL2006 and AL2012

In example 2 the connecting cables point in the same direction. In this layout the minimum bending radius of the motor cable must be observed.

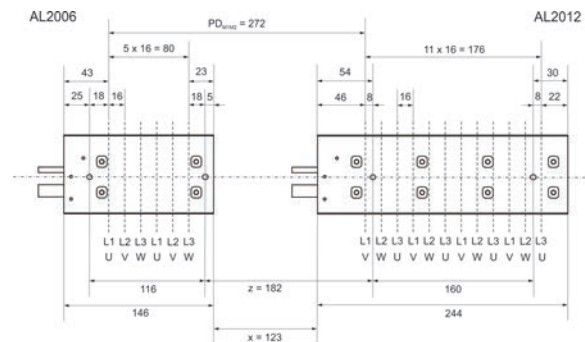

PD_{M1M2} = phase distance "Phase L1 / Motor 1" to "Phase L1 / Motor 2"
 x = Housing clearance
 z = Distance between the mounting holes

7.4.3 Calculation of the offset

The wiring must be done according to the layout of the coil units. The offset must be determined in order to do this. The offset specifies the number of coils by which the rotary field is shifted in the second motor. The wiring of the motors can be determined with the help of the offset and the table in the section entitled Layout of the wiring [▶ 26].

The offset is calculated using the following equation:

$$\text{Offset} = (PD_{M1M2} / 16) \text{ MOD } 3$$

Calculation of the offset for example 1:

$$\begin{aligned} \text{Offset} &= (304 / 16) \text{ MOD } 3 \\ &= 19 \text{ MOD } 3 = 1 \end{aligned}$$

Calculation of the offset for example 2:

$$\begin{aligned} \text{Offset} &= (272 / 16) \text{ MOD } 3 \\ &= 17 \text{ MOD } 3 = 2 \end{aligned}$$

7.4.4 Layout of the wiring

Using the offset calculated in the previous section, the wiring of the coupled motors can be done on the basis of the following table. For each case the table shows how the phases of motor 1 (L1, L2, L3) are connected to the phases of motor 2 (L1', L2', L3').

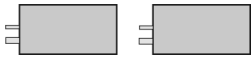
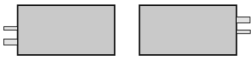
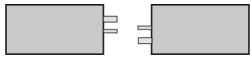
	Cables of the motors point in the same direction	Cables of the motors point outwards	Cables of the motors point inwards
			
Offset = 0	L1/L1' L2/L2' L3/L3'	L1/L1' L2/L3' L3/L2'	L1/L1' L2/L3' L3/L2'
Offset = 1	L1/L3' L2/L1' L3/L2'	L1/L2' L2/L1' L3/L3'	L1/L3' L2/L2' L3/L1'
Offset = 2	L1/L2' L2/L3' L3/L1'	L1/L3' L2/L2' L3/L1'	L1/L2' L2/L1' L3/L3'

7.4.5 Positions of the phase lines

7.4.5.1 Phase lines AL20xx

Modell	m	n
AL2003	41	25
AL2006	43	23
AL2009	43	23
AL2012	46	22
AL2015	43	23
AL2018	43,5	20,5
AL2024	46	22

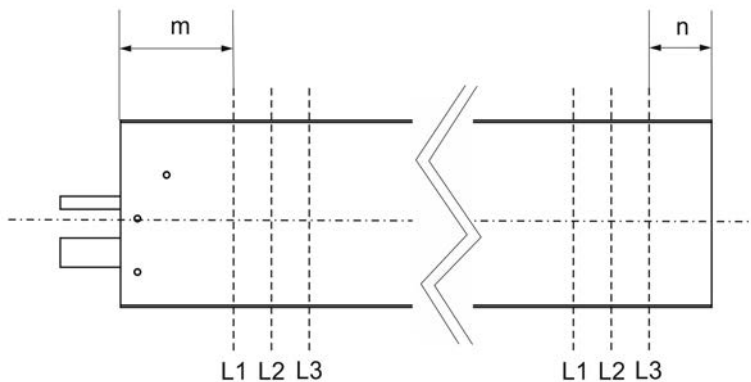

7.4.5.2 Phase lines AL24xx

Modell	m	n
AL2403	36	25
AL2406	40	23
AL2412	43	22

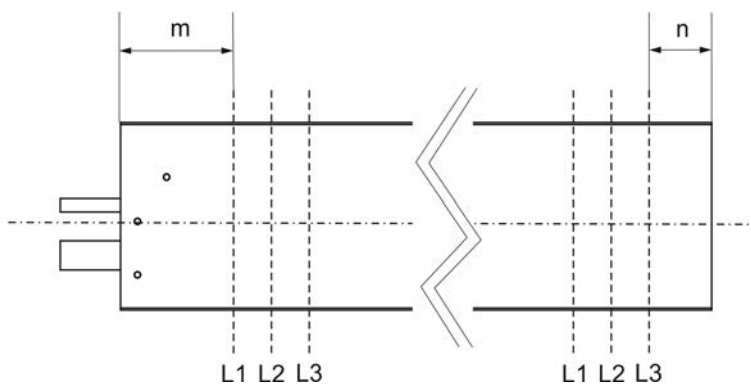

7.4.5.3 Phase lines AL28xx-0 air-cooled

Modell	m	n
AL2812-0	46	22
AL2815-0	43	23
AL2830-0	43	23

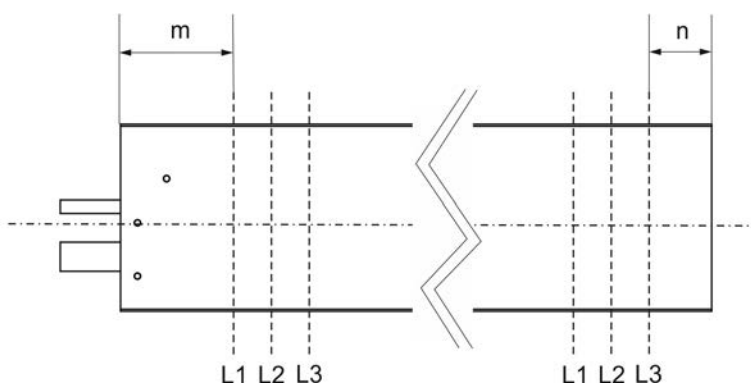

7.4.5.4 Phase lines AL28xx-1 water-cooled

Modell	m	n
AL2830-1	56	28
AL2845-1	56	28

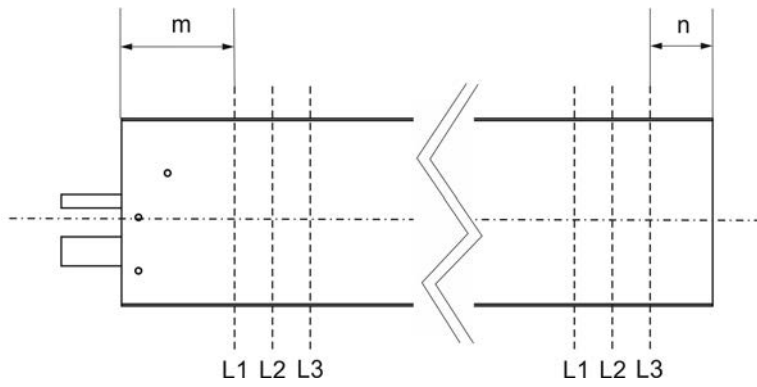

7.4.6 Minimum distance between the motors

a) Motor cables pointing away from each other

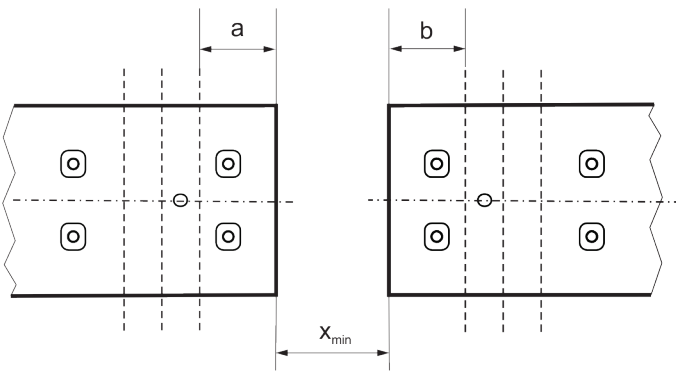

$$n' = (a + b) / 16$$

$$n = n' \text{ aufgerundet / rounded up}$$

b) Motor cables pointing in the same direction

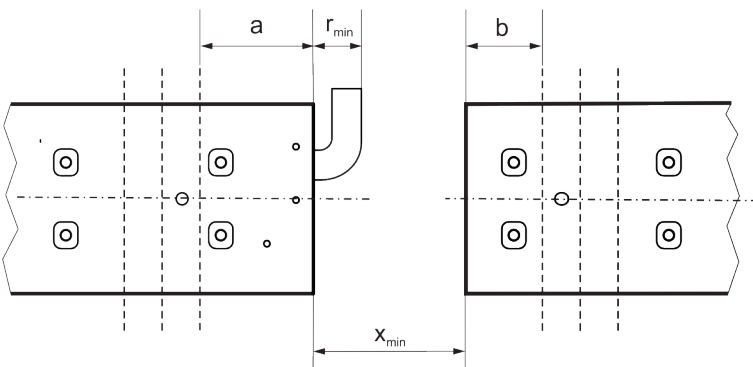

$$n' = (a + b + r_{min}) / 16$$

$$n = n' \text{ aufgerundet / rounded up}$$

c) Motor cables pointing towards each other

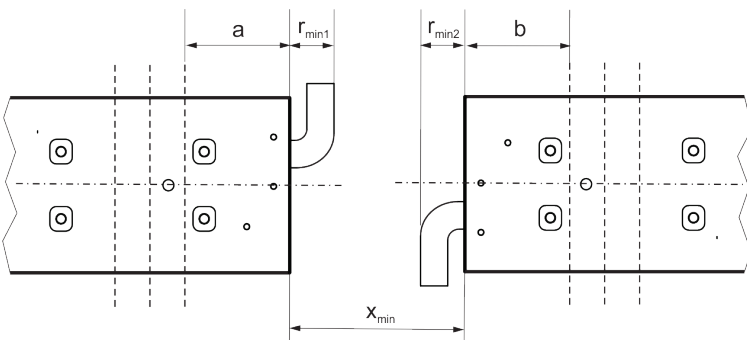

$$n' = (a + b + r_{min1} + r_{min2}) / 16$$

$$n = n' \text{ aufgerundet / rounded up}$$

x_{min} = minimum distance between the motors

$x_{min} = n * 16 - a - b$ n' = auxiliary variable

n = multiple of the phase spacing

a = distance between phase line and housing wall of motor 1 (see previous page)

b = distance between phase line and housing wall of motor 2 (see previous page)

r_{min} = Minimum bending radius of the motor cable (see section entitled [Technical data](#) | 47|)

Calculation for example a):	Calculation for example c):
(AL2006 and AL2012 motor)	(AL2006 and AL2012 motor)
$n' = (23 \text{ mm} + 22 \text{ mm}) / 16 \text{ mm} = 2.81$	$n' = (43 \text{ mm} + 46 \text{ mm} + 96 \text{ mm} + 96 \text{ mm}) / 16 \text{ mm} = 17.56$
$n = 3$ (rounded up)	$n = 18$ (rounded up)
$x_{min} = 3 * 16\text{mm} - 23\text{mm} - 22\text{mm} = 3\text{mm}$	$x_{min} = 18 * 16\text{mm} - 43\text{mm} - 46\text{mm} = 199\text{mm}$

7.5 Dismantling sequence

WARNING

Damage due to uncontrolled magnetic attractive forces

The dismantling sequence given in these instructions must be followed. A different sequence can give rise to dangerous situations, and can lead to damage resulting from uncontrolled magnetic attraction.

Dismantling sequence:

1. Check that there is no voltage and secure against being switched on again.
2. Disconnect the electrical cables.
3. Disconnect the hoses of the water cooling unit (if installed).
4. Move the carriage to one side. Secure the carriage in such a way as to prevent unwanted movement.
5. Cover each magnetic plate that needs to be removed with a neutralizing protective plate.
6. Remove one or more magnetic plates. The distance between the magnetic plates and the coil unit or other exposed ferromagnetic parts should be no less than 10 cm.
7. Move the carriage to the other side. Secure the carriage in such a way as to prevent unwanted movement.
8. Cover each magnetic plate that needs to be removed with a neutralizing protective plate.
9. Remove the remaining magnetic plates.
10. Remove the coil unit from the carriage.

8 Electrical installation

8.1 Important notes

DANGER

Serious risk of injury through electric shock!

- Only staff qualified and trained in electrical engineering are allowed to wire up the motor.
- Check the assignment of the servo drive and servomotor. Compare the rated voltage and the rated current of the devices.
- Always make sure that the motors are de-energized during assembly and wiring, i.e. no voltage may be switched on for any piece of equipment which is to be connected. Ensure that the control cabinet remains turned off (barrier, warning signs etc.). The individual voltages will only be turned on again during commissioning.
- Never undo the electrical connections to the motor when it is live. Control and power leads may be live, even if the motor is not running.

NOTE

Smooth operation

- Ensure that there the servo drive and the motor are earthed properly. See below for further information regarding EMC shielding and earthing. Earth the mounting plate and motor housing. Information about the connection method can be found in the section entitled [Connection with pre-assembled cables and connector box AL225x \[▶ 34\]](#)
- Use only cables approved by Beckhoff for the operation of the AL2xxx.
- Route the power and encoder cables as separately as possible from one another (separation > 20 cm). This will improve the immunity of the system to electromagnetic interference.
- Route all cables with an adequate cross-sectional area according to EN 60204. The recommended cross-sectional areas can be found in the technical data.
- Wiring:
 - ⇒ Connect the feedback cable
 - ⇒ Connect the motor cables
 - ⇒ Shielding at both ends (shield terminal or EMC plug)

NOTE

HF interference

The ground symbol , which you will find in the circuit diagrams, indicates that you must provide an electrical connection, with as large a surface area as possible, between the unit indicated and the mounting plate in the control cabinet. This connection is to suppress HF interference and must not be confused with the PE (protective earth) symbol (protective measure according to EN 60204).

8.2 Connection of motors

8.2.1 Single conductors

If the motors are ordered with single conductors, any connector can be assembled. The assignment of the signals to the conductors is given in the tables below.

Power



Line	Signal
3	U
Green/Yellow	PE
1	W
2	V
Weave	Shield

Temperature contact

Line	Signal
White	PTC
Green	KTY
Brown	PTC
Yellow	KTY
Weave	Shield

8.2.2 M23 connector for power supply and D-Sub connector for temperatur contact

Motors with connection plugs

Power supply	Temperature contact
	
ZS4000-2040	ZS4000-2030

Power connector

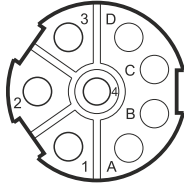
Contact	Signal	Connector M23 (8-poles)
1	U	
2	PE	
3	W	
4	V	
Case	Shield	

Temperature contact

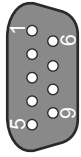
Contact	Signal	D-Sub Connector (9-poles)
5	KTY	
9	KTY	
2	PTC	
6	PTC	
Case	Shield	

8.3 Connection with pre-assembled cables and connector box AL225x

Beckhoff offers preassembled motor and feedback cables for safe, faster and flawless installation of the motors. Beckhoff cables have been tested with regard to the materials, shielding and connectors used. They ensure proper functioning and compliance with statutory regulations such as EMC, UL etc. The use of other cables may lead to unexpected interference and invalidate the warranty.

- Carry out the wiring in accordance with the valid standards and regulations.
- Only use our preassembled shielded cables for the power and feedback connections. Incorrectly installed shielding inevitably leads to EMC interference.
- Cables that move during the operation of the linear servomotor are always to be regarded as wearing parts. It is advisable to install these with the help of a plug connector between the moved cable and the motor cable of the coil unit such that simple replacement is ensured. The minimum bending radius of the respective cable is to be taken from the corresponding data sheets.
- Detailed specifications of the cables can be found on our homepage under [Download](#)→ [Documentation](#)→ [Drive Technology](#)→ [Cables](#).

8.3.1 AX5000 connection diagram with MES and Sin/Cos encoder without zero pulse

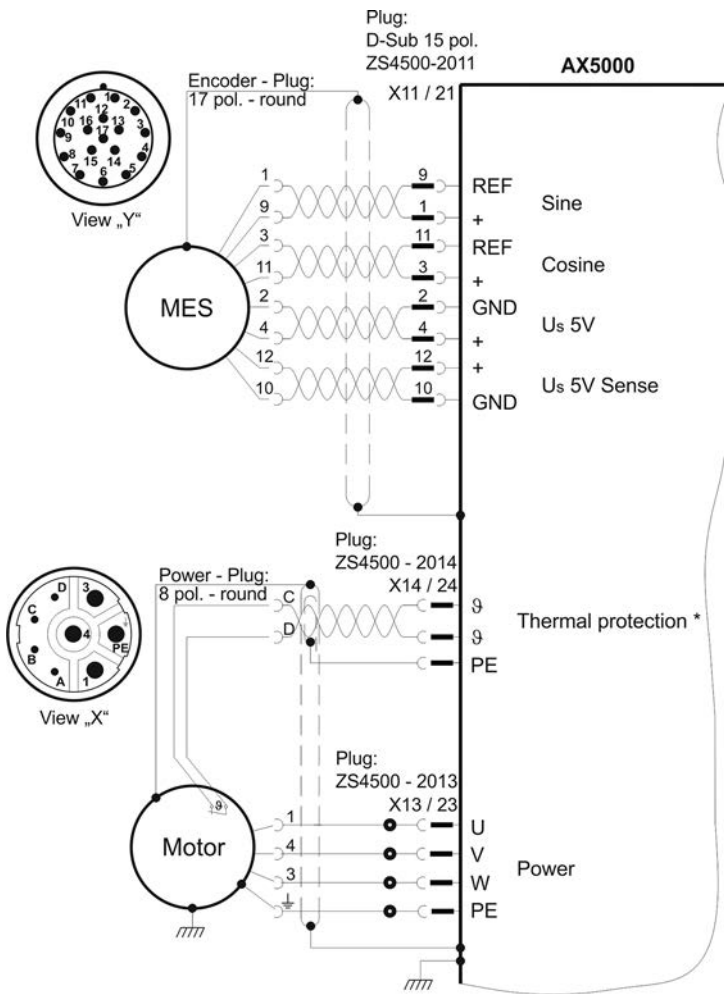

* If no ConnectorBox is used, the ZK4540-0020-xxxx thermal protection contact cable is additionally required. This is to be connected to X14 / 24.

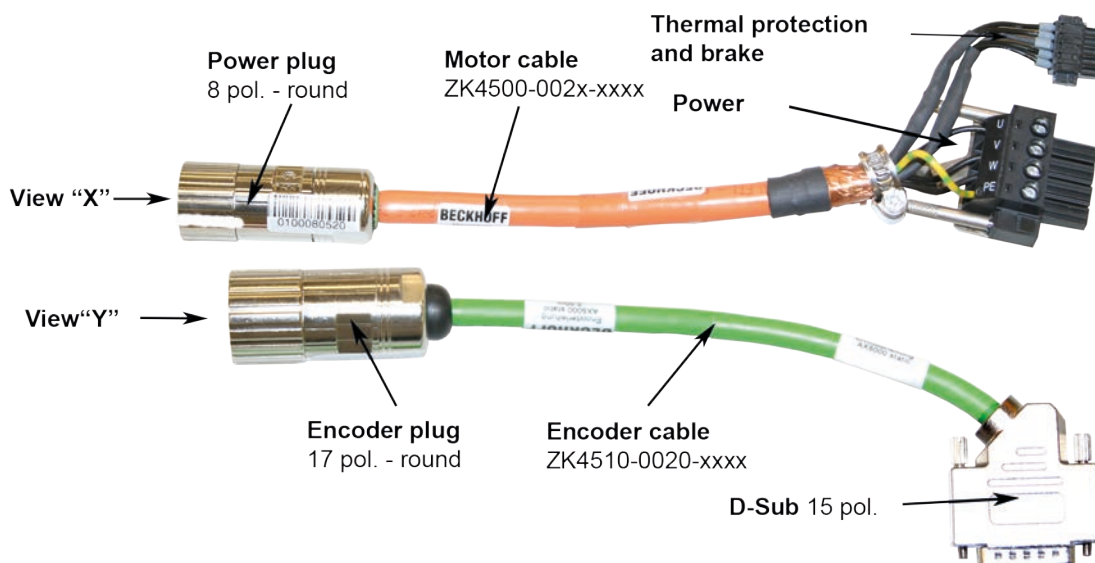

8.3.2 AX5000 connection diagram for AL2xxx and absolute value encoder

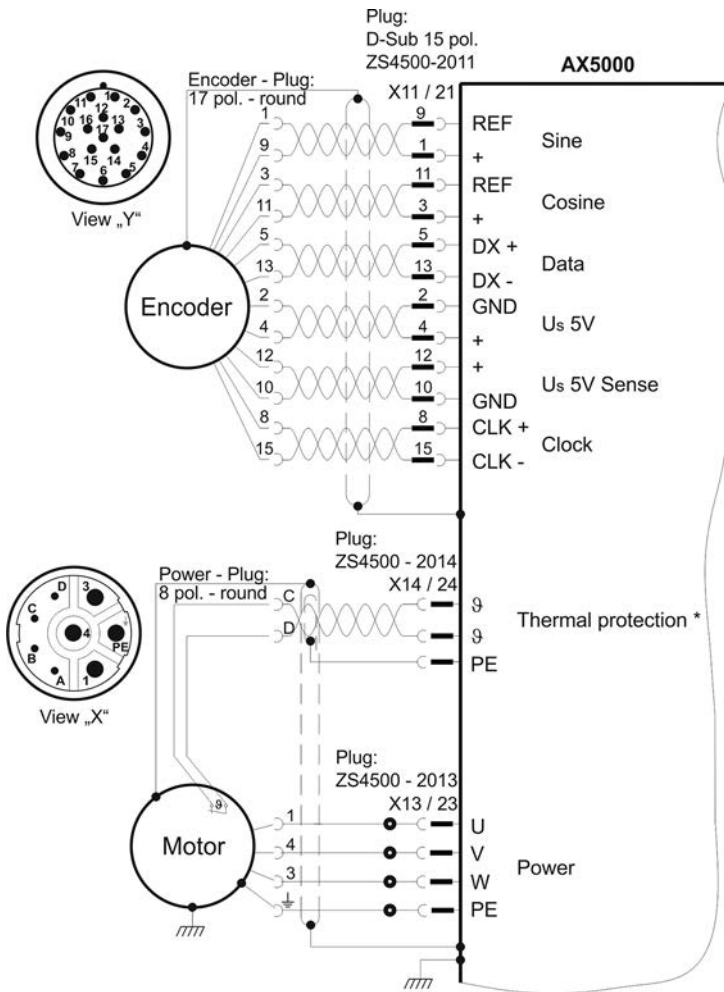

* If no ConnectorBox is used, the ZK4540-0020-xxxx thermal protection contact cable is additionally required. This is to be connected to X14 / 24.

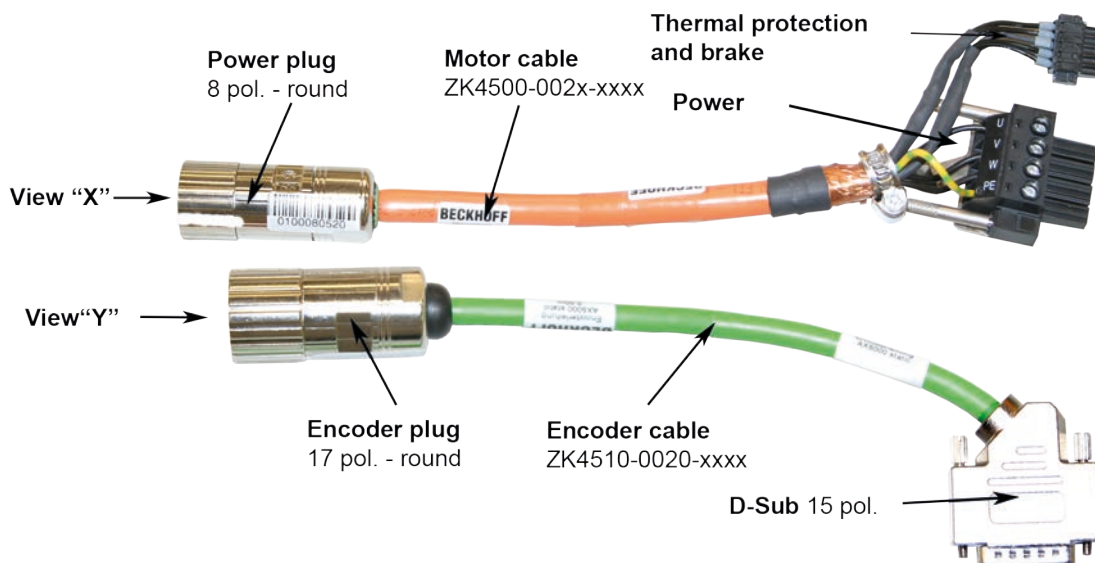

8.3.3 AX5000 connection diagram for AL2xxx and Sin/Cos encoder with zero pulse

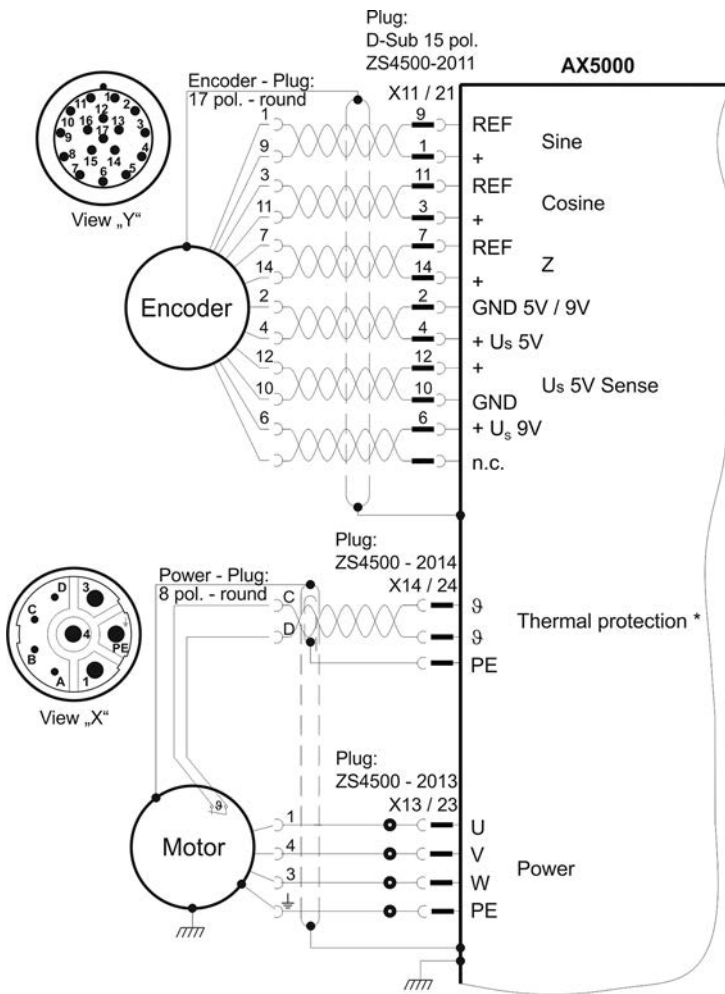

* If no ConnectorBox is used, the ZK4540-0020-xxxx thermal protection contact cable is additionally required. This is to be connected to X14 / 24.

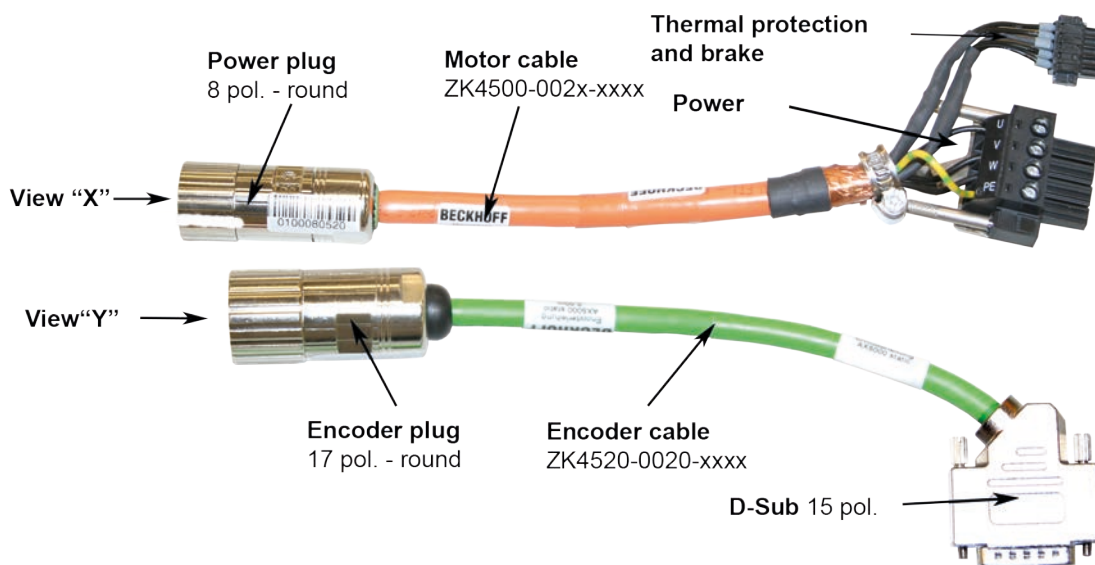

8.3.4 AX5000 connection diagram for AL2xxx and TTL encoder with zero pulse

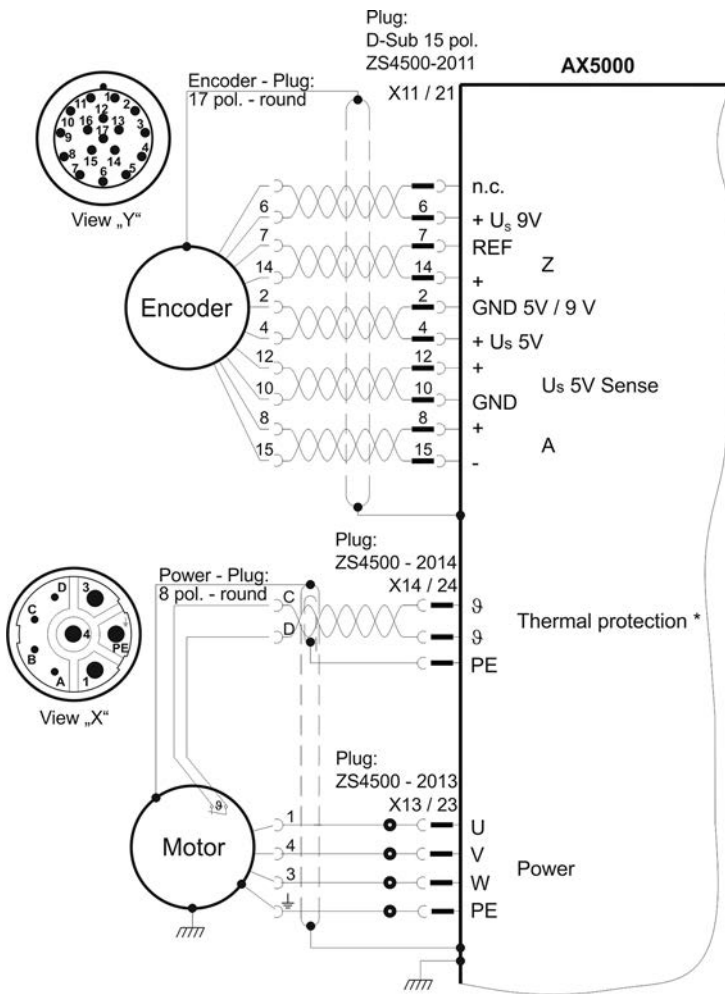

* If no ConnectorBox is used, the ZK4540-0020-xxxx thermal protection contact cable is additionally required. This is to be connected to X14 / 24.

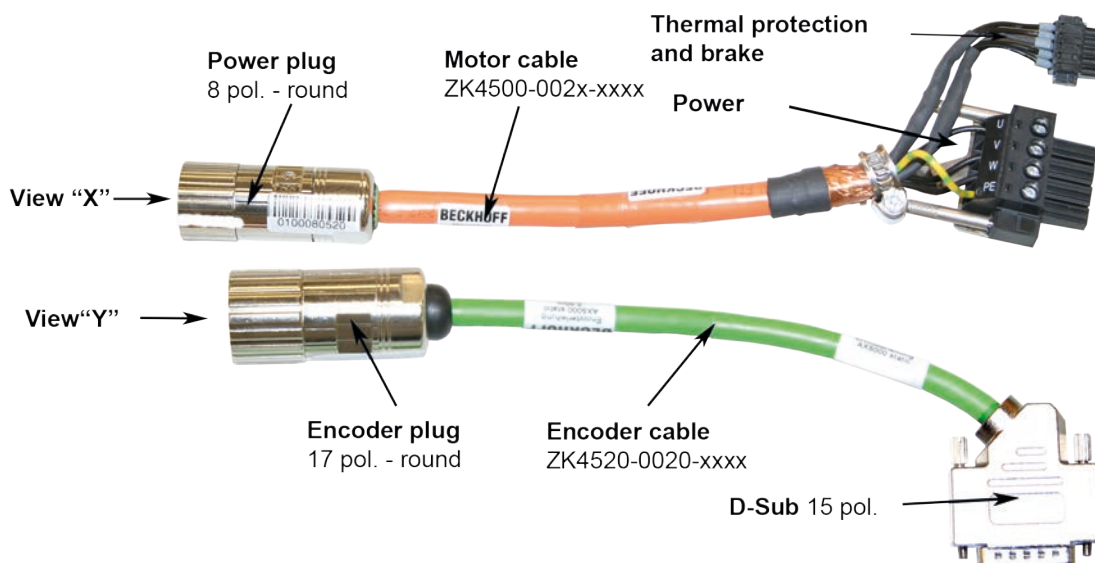

8.4 Temperature sensor

The coil unit is equipped with two temperature sensors, a PTC-1k Ω and a KTY83-122. The temperature sensors are used to monitor the temperature in the coil unit. The temperature cable contains four wires.

8.4.1 PTC specification

The PTC-1k sensor exhibits a sharp rise in temperature when the temperature is close to a certain critical value, and therefore operates as a digital indicator. A gradual temperature signal can, however, not be generated from this PTC.

At room temperature, the PTC has an electrical resistance of around 65 ohms. As the temperature rises up to a critical temperature, the resistance exhibits an almost linear rise up to 1000 ohms. Above this temperature, the resistance rises exponentially. The switching resistance is therefore 1000 ohms. The servo drive will immediately disconnect the power supply if this resistance is exceeded. This makes it possible to guard against overheating the motor. The thermal protection contact cable must therefore be properly connected to the servo drive.

Temperature	Resistance
Up to 20° C below the critical temperature	< 250 Ω
Up to 5° C below the critical temperature	< 550 Ω
Switching resistance	> 1000 Ω
Above the critical temperature	> 1330 Ω

8.4.2 KTY Specification

Diagram of the KTY sensor

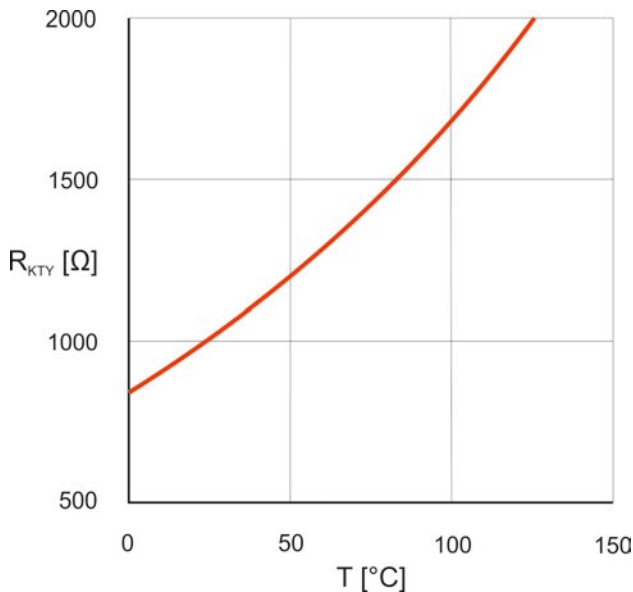

The KTY 83-122 sensor has a stable and moderate temperature coefficient. The KTY is able to acquire temperature measurements up to high values. It is therefore particularly well suited to monitoring the coil temperature.

Image of a resistance circuit

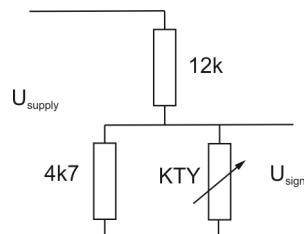

The sensor requires a continuous current of between 0 and 2 mA. The resistance does not respond linearly to temperature. A linear current/temperature ratio can be obtained with a resistance circuit. The basic tolerance is around $\pm 5^\circ\text{C}$ (with shunt resistors).

T (°C)	0	10	20	30	40	50	60	70	80	90	100	110	120	130
R _{KTY} (Ω)	815	886	961	1040	1123	1209	1300	1394	1492	1594	1700	1810	1923	2041

8.5 Polarity test

NOTE

Protection of the linear servomotor

Before the test, make sure that the linear motor system has suitable electrical and mechanical protection.

There is one way of checking the polarity. By means of moving the carriage it is possible to determine whether the direction of movement of the motor corresponds to the count direction of the feedback. If this is the case, the motor is connected correctly. Otherwise, two phases in the motor cable - phases 1 and 3 - must be swapped.

All linear servomotors from Beckhoff are wired and connected in exactly the same way, so that a single test is sufficient in order to determine the polarity of a motor/graduated rule combination. If more than one axis is being constructed in a similar way, the polarity will be identical.

9 Installation of the water cooling



Equipping with water cooling

Only the AL20xx and AL28xx-1000 series are equipped with water cooling.

9.1 General

This chapter considers the optional installation of a water cooling unit. The AL20xx series can be operated as standard with or without water cooling. In the case of the AL28xx series the water cooling represents an option that must be ordered explicitly so that it can be used.

NOTE

Consequential damages due to leaking water cooling

Beckhoff can accept no responsibility for any damage resulting from a leaky water cooling system

9.2 Requirements

	AL20xx	AL28xx-100x
Connecting nipple	M5	Push-pull fitting, - Festo QS-1/8-8*
Seal	M5 plastic seal & Loctite 638/648	Teflon tape
Required torque	0.2 – 0.3 Nm	4.0 Nm

NOTE

Pressure drops due to incorrect connections

If other connectors are used, this can lead to more pressure loss than stated.

9.3 Installation of the water cooling connections

9.3.1 AL2xxx

Make sure that the minimum diameter for water flow is at least 2.5 mm, and that the internal diameter of the hose is at least 4 mm.

1. Degrease the connector and the threaded holes. Allow the degreasing agent to evaporate completely before continuing.
2. Place the plastic sealing ring on the connector.
3. Apply a drop of Loctite 638/648 adhesive to the thread, and spread it all the way round.
4. Attach the connector, and turn it until the sealing ring is visibly deformed. (This only requires a torque of 0.2 to 0.3 Nm!)
5. Remove the excess adhesive.
6. Let the adhesive harden for 4 hours before stressing it.
7. Let the adhesive harden for about 12 hours before exposing it to pressure.
8. The hoses must match the chosen connectors.

Water cooling connections that can be used for hoses with an inside diameter of 4 mm are, for example, the **Festo PU-4 pneumatic** or the very flexible PVC hose **Rauclair E 4x1**. Both hoses and connections can withstand a pressure of 2 bar.

9.3.2 AL28xx-1 water-cooled

Make sure that the minimum diameter for water flow is at least 2.5 mm, and that the internal diameter of the hose is at least 4 mm.

1. Degrease the connector and the threaded holes. Allow the degreasing agent to evaporate completely before continuing.
2. Wrap Teflon tape around the thread of the connecting nipple.
3. Place the connection onto it and screw it tight. (This requires a torque of 4.0 Nm.)
4. The hoses must match the connectors.

Water cooling connections that can be used for hoses with an inside diameter of 4 mm are, for example, the **Festo PU-4 pneumatic** or the very flexible PVC hose **Rauclair E 4x1**. Both hoses and connections can withstand a pressure of 2 bar.

9.4 Connecting the hoses

NOTE

Manufacturing the hoses

The hoses must match the chosen connectors.

The connectors must be free from oil and grease when the hoses are attached. The minimum flow rate is 1 l/min, requiring a pressure drop of less than 1 bar. It is also possible to connect the two cooling lines in parallel. This method of connection does reduce the pressure drop, although only when cavitation-free Y-branches with a diameter of 6-8 mm are used.

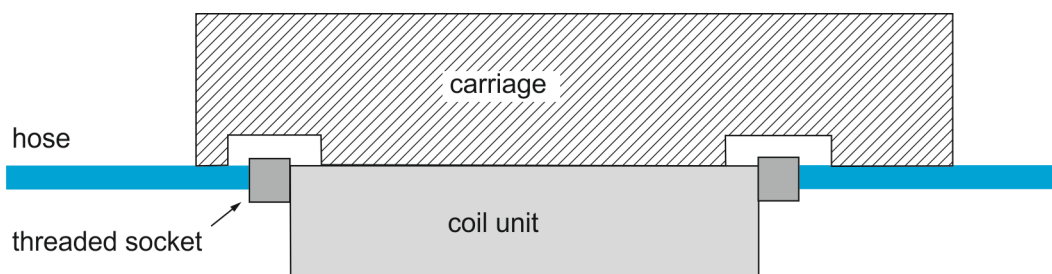

The connections of the cooling water pipe can extend beyond the dimensions of the motor part. This must be observed when designing the carriage.

10 Commissioning

10.1 Important notes

⚠ CAUTION

Serious risk of injury!

- Only specialist personnel with extensive knowledge in the areas of electrical engineering / drive technology are allowed to install and commission the equipment.
- Check that all live connection points are protected against accidental contact.
- Never undo the electrical connections to the motor when it is live.
- The surface temperature of the motor can exceed 70 °C in operation. Check (measure) the temperature of the motor. Wait until the motor has cooled down below 40 °C before touching it.
- Make sure that, even if the drive starts to move unintentionally, no danger can result for personnel or machinery.

10.2 General commissioning

The procedure for commissioning is described as an example. A different method may be appropriate or necessary, depending on the application of the equipment.

Once you have made sure that the linear servomotor system of your application is properly mounted, both mechanically and electrically, you can put your linear servomotor system into operation.

10.2.1 Parameterisation

Depending on the components used (motor type, feedback system, servo drive) the following specific parameters must be configured:

- the presence and switching mode of the limit switches (normally open / normally closed),
- the presence of an electromechanical brake,
- the type and interface,
- the motor type,
- the maximum continuous current,
- the maximum peak current,
- the switching resistance of the temperature sensor,
- safety settings,
- parameterisation of the error reactions: tripping of the limit switches, switching off, overcurrent, overspeed and emergency stop,
- magnetic alignment,
- commutation detection,
- parameters for the current controller (*current loop*),
- parameters for the speed controller (*speed loop*),
- parameters for the position controller (*position loop*),
- pole spacing: 24mm,
- maximum speed (rpm),
- number of increments or periods for one rotation (the pole division length divided by the number of increments per pole division).

10.2.2 Commissioning

- Check that the drive elements (carriage, magnetic plate, coil unit) are tightly fastened and correctly adjusted.
- Are the mechanical end-stops, limit switches and buffers properly dimensioned, and are they configured correctly?
- Is the thermal protection contact cable connected?
- Does the combination of the motor and the graduated rule have the correct polarity?
- Check the wiring and connections to the motor and the servo drive. Check that the earthing is correct.
- Test the function of the holding brake, if used.
- Check whether the carriage of the motor can be moved freely (vent the brake beforehand if there is one). Listen out for grinding noises.
- Check that all the required measures against accidental contact with live and moving parts have been carried out.
- Carry out any further tests which are specifically required for your system.
- Now commission the drive according to the commissioning instructions for the servo drive.
- In multi-axis systems, individually commission each drive unit (servo drive/motor(s)).
- Is the track free from foreign bodies?
- Are cables correctly guided?

10.2.3 Optimising the control settings

The settings of the current control depend only on the application parameters of the servo drive and of the motor.

Due to its sensitivity to oscillations, to noise and to delays, the speed control only has limited use as a factor for servo drive power. Please take the time to adjust this controller correctly before the position controller is optimised. In this respect, be sure to also read the instructions in the manuals for the servo drive employed.

● Adjustment of the controller

i The position controller can only be adjusted correctly if the speed controller has been adjusted correctly beforehand.

10.3 Troubleshooting

The following table describes possible faults and the measures to remedy them. There can be a large number of different reasons for a fault, depending on the particular conditions in your system. The fault causes described below are mostly those which directly influence the motor. Peculiarities which show up in the control behavior can usually be traced back to an error in the parameterization of the servo drives. Information about this can be found in the documentation for the servo drives and the commissioning software.

For multi-axis systems there may be further hidden reasons for faults.

Error	Possible cause	Measures to remove the cause of the fault
Motor does not move	Servo drive not enabled	Supply ENABLE signal
	Motor phases in wrong sequence	Swap the motor phases
	Brake not released	Check brake control
	Drive is mechanically blocked	Check mechanism
Motor runs away	Motor phases in wrong sequence	Check the commutation offset
Motor oscillates	Break in the shielding of the feedback cable	Replace the feedback cable
	Amplification to high	Use the motor default values
Error Message: Output stage fault	Motor cable has short circuit or earth leakage	Replace motor cable
	Motor has short circuit or earth leakage	Replace motor
Error Message: Feedback	Connector is not properly plugged in	Check the plug connector
	Break in cable, cable crushed or similar	Check cables
	Internal error	Read out the error messages
Brake does not grip	Required holding force	Check the design
	Brake faulty	Replace the motor brake

11 Technical data

All details are based on a coil part with a coil temperature of 100°C mounted on an aluminum cooling surface. The cooling surface has a temperature of 20 °C and a thermal resistance of 0.05 K / W.

11.1 Term definitions

Winding type

The winding type describes the structure of the windings. Depending on the coil unit this can be the N-type or the S-type, which differ in their electrical values. The N-type (normal) represents the standard. The S-type (speed) is characterized by a higher max. speed and a higher current consumption.

Peak force F_p (N)

The peak force specifies the maximum force of the motor. It cannot be constantly generated.

Peak current (I_{pa})

The peak current is the maximum permissible current.

Continuous force with water cooling (F_{cw})

The continuous force with water cooling is the force which the motor can constantly generate if the water cooling is used.

Continuous force with air cooling (F_{ca})

The continuous force with air cooling is the force which the motor can constantly generate if the water cooling is not used.

Continuous power loss (P_{ca})

The continuous power dissipation is the max. power dissipation of the motor. It can be used for the calculation of the cooling systems.

Power constant (K_f)

The power constant specifies how much force in Newtons the motor generates with 1A effective sine current.

Pole spacing

The pole pair spacing is the period in which the magnetic field (north/south) of the magnetic plate repeats itself.

Magnetic attractive force (F_a)

The magnetic attractive force acts between the magnetic plate and the coil unit even if no current is flowing. It increases with the size of the motors. On reaching the peak current the magnetic attractive force can increase by up to 10%.

Air gap

The air gap is the distance between the magnetic plate and the coil unit. It must be adhered to in order to attain the rated and maximum values of the motor. The overall mounting height over the magnetic plate and coil unit is given in the dimensional drawings. If this height is adhered to, the air gap will be correct.

11.2 AL20xx

Technical data	AL2003	AL2006	AL2009	AL2012
Winding type	S	N / S	N / S	N / S
Velocity (max.)	7 m/s	3.5 m/s (N) 7 m/s (S)	2.5 m/s (N) 7 m/s (S)	3.5 m/s (N) 7 m/s (S)
Motor configuration	3-phase synchronous linear motors (400 – 480 V AC)			
Peak force (F_p)	225 N	450 N	675 N	900 N
Peak current (I_{pa})	6.5 A	6.5 A (N), 13 A (S)	6.5 A (N), 19.6 A (S)	13.1 A (N), 26.2 A (S)
Continuous force with water cooling (F_{cw})	105 N	210 N	315 N	420 N
Continuous force with air cooling (F_{ca})	75 N	200 N	300 N	400 N
Continuous current (I_{ca})	2.28 A	2.15 A (N), 4.3 A (S)	2.14 A (N), 6.45 A (S)	4.3 A (N), 8.6 A (S)
Continuous power loss (P_{ca})	90 W	150 W	225 W	300 W
Power constant (K_f)	46 N/A	93 N/A (N), 46 N/A (S)	140 N/A (N), 46 N/A (S)	93 N/A (N), 46 N/A (S)
Motor constant (K_m)	185 N ² /W	380 N ² /W	570 N ² /W	760 N ² /W
Pole pitch	24 mm			
Winding resistance Ph-Ph (R_f)	7.8 Ω	14.4 Ω (N), 3.6 Ω (S)	21.6 Ω (N), 2.42 Ω (S)	7.2 Ω (N), 1.8 Ω (S)
Winding inductance Ph-Ph (L_f)	60 mH	108 mH (N), 28 mH (S)	162 mH (N), 18 mH (S)	54 mH (N), 14 mH (S)
Voltage constant EMF phase-phase	26.87 V/m/s (S)	53.74 V/m/s (N) 26.87 V/m/s (S)	80.67 V/m/s (N) 26.87 V/m/s (S)	53.74 V/m/s (N) 26.87 V/m/s (S)
Thermal resistance (R_{th})	0.96 °C/W	0.48 °C/W	0.32 °C/W	0.24 °C/W
Magnetic motor attraction force (F_a)	500 N	950 N	1325 N	1700 N
Weight of the coil unit (M_p)	0.9 kg	1.5 kg	2.0 kg	2.6 kg
Weight of magnetic plate (M_s)	3.8 kg/m			
Air gap	0.5 mm			
Temperature sensor	PTC 1 k Ω & KTY83-122			
Suitable servo drive	AX5x03	AX5x03 (N), AX5x06 (S)	AX5x03 (N), AX5112 (S)	AX5x06 (N), AX5112 (S)
Cable length, unassembled	1 m			
Cable length, assembled	0.5 m			
Minimum static bending radius	4 x cable diameter			
Motor cable, outer diameter	9.60 mm			
Motor cable, core cross-sectional area	4.1 mm ²			
Temperature sensor cable, outer diameter	4.3 mm			
Temperature sensor cable, core cross-sectional area	4 x 0.14 mm ²			

Technical data	AL2015	AL2018	AL2024
Winding type	N / S	N / S	N / S
Velocity (max.)	3.5 m/s (N) 7 m/s (S)	3.5 m/s (N) 7 m/s (S)	3.5 m/s (N) 7 m/s (S)
Motor configuration	3-phase synchronous linear motors (400 – 480 V AC)		
Peak force (F_p)	1125 N	1350 N	1800 N
Peak current (I_{pa})	13.5 A (N), 32.7 A (S)	19.6 A (N), 41 A (S)	26.2 A (N), 52 A (S)
Continuous force with water cooling (F_{cw})	525 N	630 N	840 N
Continuous force with air cooling (F_{ca})	500 N	600 N	800 N
Continuous current (I_{ca})	4.46 A (N), 10.75 A (S)	6.45 A (N), 13.36 A (S)	8.6 A (N), 17.2 A (S)
Continuous power loss (P_{ca})	375 W	450 W	600 W
Power constant (K_f)	112 N/A (N), 46 N/A (S)	93 N/A (N), 44.9 N/A (S)	93 N/A (N), 46 N/A (S)
Motor constant (K_m)	950 N ² /W	1140 N ² /W	1520 N ² /W
Pole pitch	24 mm		
Winding resistance Ph-Ph (R_f)	8.6 Ω (N), 1.44 Ω (S)	4.82 Ω (N), 1.18 Ω (S)	3.62 Ω (N), 0.92 Ω (S)
Winding inductance Ph-Ph (L_f)	64 mH (N), 10.8 mH (S)	36 mH (N), 8.8 mH (S)	28 mH (N), 6.8 mH (S)
Voltage constant EMF phase-phase	65.05 V/m/s (N) 26.87 V/m/s (S)		
Thermal resistance (R_{th})	0.20 °C/W	0.16 °C/W	0.12 °C/W
Magnetic motor attraction force (F_a)	2075 N	2450 N	3400 N
Weight of the coil unit (M_p)	3.2 kg	3.8 kg	5.2 kg
Weight of magnetic plate (M_s)	3.8 kg/m		
Air gap	0.5 mm		
Temperature sensor	PTC 1 k Ω & KTY83-122		
Suitable servo drive	AX5x06 (N), AX5112 (S)	AX5112 (N), AX5118 (S)	AX5112 (N), AX5118 (S)
Cable length, unassembled	0.5 m		
Cable length, assembled	1 m		
Minimum static bending radius	4 x cable diameter		
Motor cable, outer diameter	9.60 mm		11.90 mm
Motor cable, core cross-sectional area	4.10 mm ²		4.25 mm ²
Temperature sensor cable, outer diameter	4.30 mm		
Temperature sensor cable, core cross-sectional area	4 x 0.14 mm ²		

11.2.1 Dimensional drawing, AL20xx and AL21xx

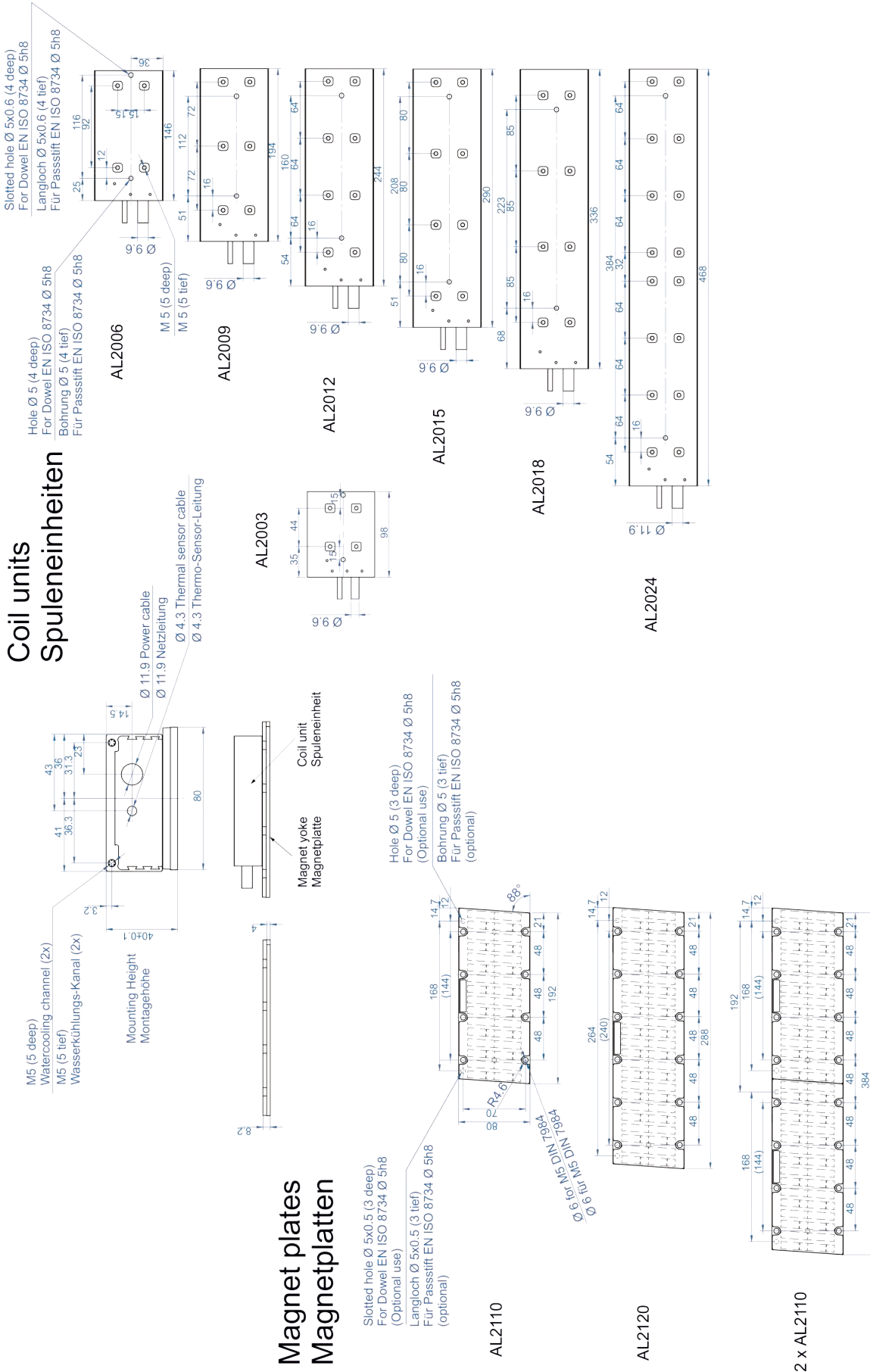

11.3 AL24xx

Technical data	AL2403	AL2406	AL2412	AL2418	
Winding type	S	S	S	N	S
Velocity (max.)	12 m/s	12 m/s	12 m/s	4.5 m/s	10 m/s
Motor configuration	3-phase synchronous linear motors (400 – 480 V AC)				
Peak force (F_p)	120 N	240 N	480 N	720 N	
Peak current (I_{pa})	4.1 A	8.2 A	16.4 A	12.3 A	25.1 A
Continuous force with water cooling (F_{cw})	60 N	120 N	240 N	360 N	
Continuous force with air cooling (F_{ca})	1.54 A	3.08 A	6.15 A	4.5 A	9.3 A
Continuous current (I_{ca})	49 W	99 W	197 W	296 W	
Continuous power loss (P_{ca})	39 N/A			79 N/A	39 N/A
Power constant (K_f)	95 N ² /W	190 N ² /W	380 N ² /W	570 N ² /W	
Motor constant (K_m)	24 mm				
Pole pitch	10.8 Ω	5.4 Ω	2.7 Ω	7.2 Ω	1.7 Ω
Winding resistance Ph-Ph (R_f)	70 mH	34 mH	18 mH	46 mH	11 mH
Winding inductance Ph-Ph (L_f)	22.63 V/m/s			45.96 V/m/s	22.63 V/m/s
Voltage constant EMF phase-phase	1.5 °C/W	0.75 °C/W	0.38 °C/W	0.25 °C/W	
Thermal resistance (R_{th})	300 N	500 N	900 N	1300 N	
Magnetic motor attraction force (F_a)	0.6 kg	0.9 kg	1.6 kg	2.3 kg	
Weight of the coil unit (M_p)	2.1 kg/m				
Weight of magnetic plate (M_s)	0.5 mm				
Air gap	PTC 1 kΩ / KTY83-122				
Temperature sensor	AX5x03	AX5x03 AX5x06	AX5x06/AX5112	AX5x06	AX5112
Suitable servo drive	3 m				
Cable length, unassembled	0.5 m				
Cable length, assembled	4 x cable diameter				
Minimum static bending radius	10 x cable diameter				
Motor cable, outer diameter	9 mm				
Motor cable, core cross-sectional area	4 x 0.5 mm ²				
Temperature sensor cable, outer diameter	4.3 mm				
Temperature sensor cable, core cross-sectional area	4 x 0.14 mm ²				

11.3.1 Dimensional drawing, AL24xx and AL25xx

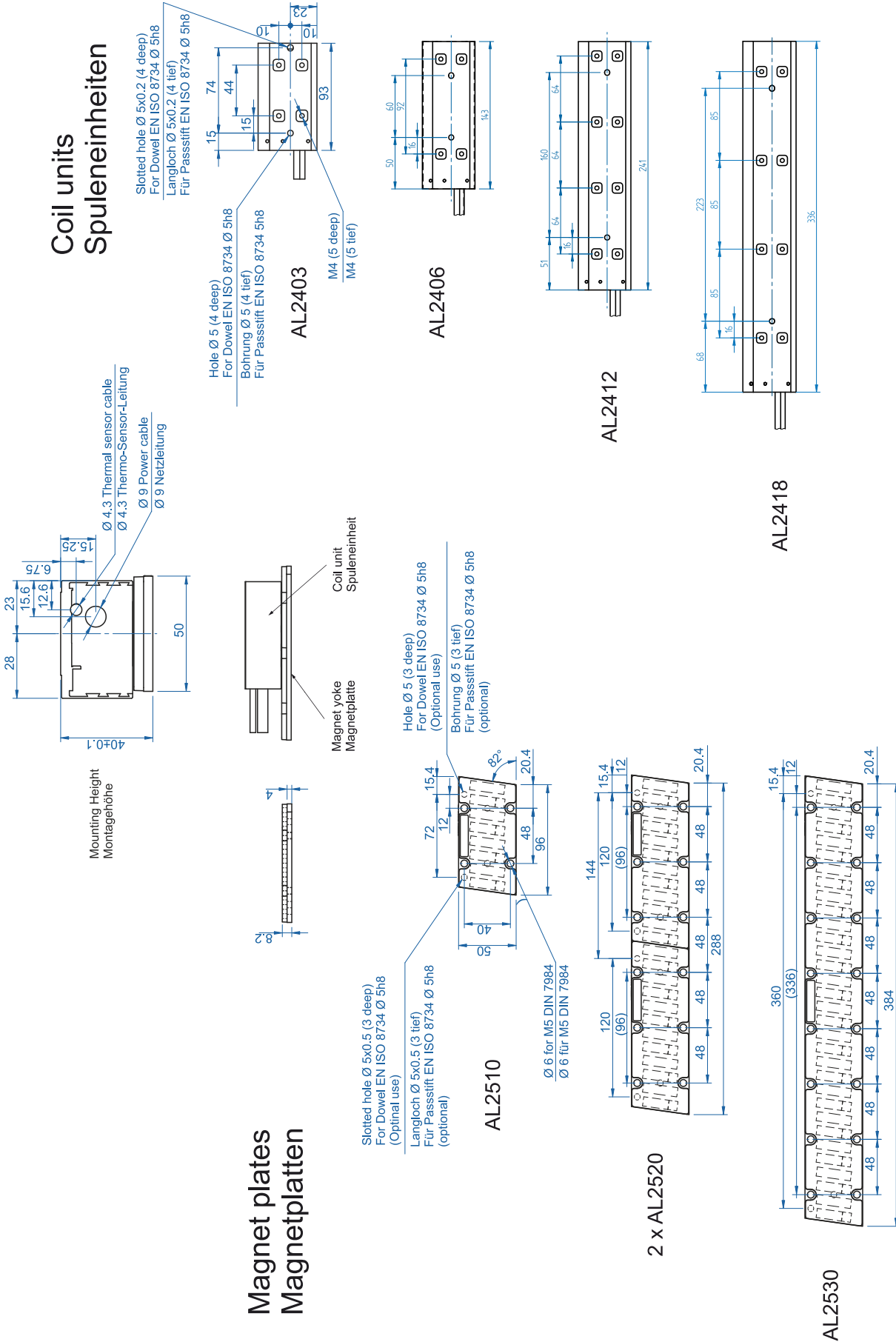

11.4 AL28xx-0 air-cooled

Technical data	AL2812-000x	AL2815-000x	AL2830-000x
Winding type	N / S	N / S	N / S
Velocity (max.)	3 m/s (N) 6 m/s (S)	2.5 m/s (N) 6 m/s (S)	2.5 m/s (N) 6 m/s (S)
Motor configuration	3-phase synchronous linear motors (400 – 480 V AC)		
Peak force (F_p)	1800 N	2250 N	4500 N
Peak current (I_{pa})	13 A (N), 26 A (S)	13.5 A (N), 33 A (S)	27 A (N), 66 A (S)
Continuous force with water cooling (F_{cw})	760 N	950 N	1900 N
Continuous force with air cooling (F_{ca})	4.1 A (N), 8.2 A (S)	4.2 A (N), 10.2 A (S)	8.5 A (N), 20 A (S)
Continuous current (I_{ca})	430 W	530 W	1060 W
Continuous power loss (P_{ca})	186 N/A (N), 93 N/A (S)	225 N/A (N), 93 N/A (S)	225 N/A (N), 93 N/A (S)
Power constant (K_f)	1750 N ² /W	2150 N ² /W	4300 N ² /W
Motor constant (K_m)	24 mm		
Pole pitch	12.6 Ω (N), 3.2 Ω (S)	15.2 Ω (N), 2.6 Ω (S)	7.6 Ω (N), 1.3 Ω (S)
Winding resistance Ph-Ph (R_f)	102 mH (N), 26 mH (S)	120 mH (N), 20 mH (S)	60 mH (N), 10 mH (S)
Winding inductance Ph-Ph (L_f)	107.48 V/m/s (N) 53.74 V/m/s (S)	129.40 V/m/s (N) 53.74 V/m/s (S)	129.40 V/m/s (N) 53.74 V/m/s (S)
Voltage constant EMF phase-phase	0.16 °C/W	0.13 °C/W	0.065 °C/W
Thermal resistance (R_{th})	3400 N	4150 N	8300 N
Magnetic motor attraction force (F_a)	4.9 kg	5.9 kg	11.6 kg
Weight of the coil unit (M_p)	10.5 kg/m		
Weight of magnetic plate (M_s)	0.5 mm		
Air gap	PTC 1 k Ω & KTY83-122		
Temperature sensor	AX5x06 (N), AX5112 (S)	AX5x06 (N), AX5118 (S)	AX5112 (N), AX5125 (S)
Suitable servo drive	1 m		
Cable length, unassembled	0.5 m		-
Cable length, assembled	4 x cable diameter		
Minimum static bending radius	11.9 mm		
Motor cable, outer diameter	4 x 2.5 mm ²		
Motor cable, core cross-sectional area	4.3 mm		
Temperature sensor cable, outer diameter	4 x 0.14 mm ²		

11.4.1 Dimensional drawing, AL28xx-0 air-cooled and AL29xx

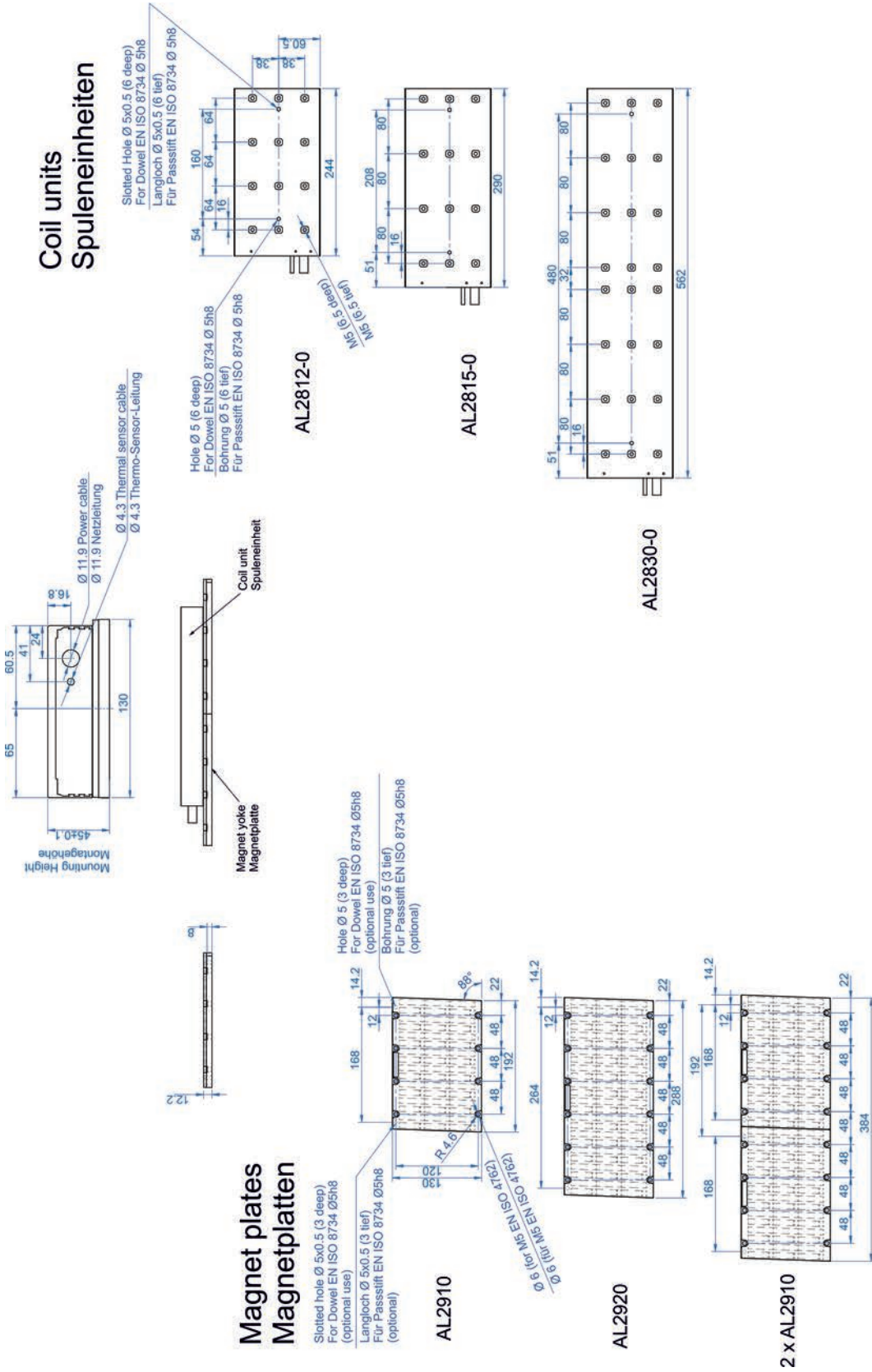

11.5 AL28xx-1 water-cooled

Technical data	AL2818-100x	AL2830-100x	AL2845-100x
Winding type	N / S	N / S	N / S
Velocity (max.)	3 m/s (N) 6 m/s (S)	2.5 m/s (N) 6 m/s (S)	2.5 m/s (N) 6 m/s (S)
Motor configuration	3-phase synchronous linear motors (400 – 480 V AC)		
Peak force (F_p)	2700 N	4500 N	6750 N
Peak current (I_{Pa})	19.6 A (N) 41 A (S)	27 A (N), 65 A (S)	41 A (N), 98 A (S)
Continuous force with water cooling (F_{cw})	1200 N	2000 N	3000 N
Continuous force with air cooling (F_{ca})	1140 N	1900 N	2850 N
Continuous current (I_{ca})	6.5 A (N) 13.4 A (S)	8.9 A (N), 21.5 A (S)	13.4 A (N), 32.3 A (S)
Continuous power loss (P_{ca})	6.1 A (N) 12.7 A (S)	8.5 A (N), 20 A (S)	12.5 A (N), 31 A (S)
Power constant (K_f)	726 W	1209 W	1804 W
Motor constant (K_m)	186 N/A (N) 90 N/A (S)	225 N/A (N), 93 N/A (S)	225 N/A (N), 93 N/A (S)
Pole pitch	2580 N ² /W	4300 N ² /W	6450 N ² /W
Winding resistance Ph-Ph (R_f)	24 mm		
Winding inductance Ph-Ph (L_f)	8.8 Ω (N) 2.0 Ω (S)	7.8 Ω (N), 1.32 Ω (S)	5.2 Ω (N), 0.88 Ω (S)
Voltage constant EMF phase-phase	70 mH (N) 16 mH (S)	62 mH (N), 10 mH (S)	42 mH (N), 6 mH (S)
Thermal resistance (R_{th})	107.48 V/m/s (N) 53.74 V/m/s (S)	129.40 V/m/s (N) 53.74 V/m/s (S)	
Magnetic motor attraction force (F_a)	0.10 °C/W	0.065 °C/W	0.04 °C/W
Weight of the coil unit (M_p)	4900 N	8300 N	12450 N
Weight of magnetic plate (M_s)	7.3 kg	12.3 kg	18.2 kg
Air gap	10.5 kg/m		
Temperature sensor	0.5 mm		
Suitable servo drive	PTC 1 k Ω & KTY83-122		
Cable length, unassembled	AX5112 (N) AX5118 (S)	AX5112 (N), AX5125 (S)	AX5118 (N), AX5140 (S)
Cable length, assembled	1 m		
Minimum static bending radius	-		
Motor cable, outer diameter	4 x cable diameter		
Motor cable, core cross-sectional area	11.9 mm (N) 11.9 mm (S)	11.9 mm (N) 16.9 mm (S)	16.9 mm (N) 16.9 mm (S)
Temperature sensor cable, outer diameter	4 x 2.5 mm ² (N) 4 x 2.5 mm ² (S)	4 x 2.5 mm ² (N) 4 x 6 mm ² (S)	4 x 6 mm ² (N) 4 x 6 mm ² (S)
Temperature sensor cable, core cross-sectional area	4.3 mm		
Winding type	4 x 0.14 mm ²		

11.6 Calculation of the brake resistor

During the braking procedure of the linear axis, energy is fed back into the servo drive. During the design the regenerative power must be calculated in order to select a brake resistor if necessary.

To do this the peak and continuous power must be calculated.

$$P_{\max} = 0.9 * (m * V^2) / (2 t_b)$$

$$P_{\text{rated}} = P_{\max} * t_b / t_z$$

P_{\max} = maximum power of the brake resistor in Watts (W)

P_{rated} = continuous power of the brake resistor in Watts (W)

M = moved mass (carriage + load) in kg

V = carriage velocity in m/s

t_b = braking time in s

t_z = cycle time in s

12 Support and Service

Beckhoff and their partners around the world offer comprehensive support and service, making available fast and competent assistance with all questions related to Beckhoff products and system solutions.

Beckhoff's branch offices and representatives

Please contact your Beckhoff branch office or representative for local support and service on Beckhoff products!

The addresses of Beckhoff's branch offices and representatives round the world can be found on her internet pages:

<http://www.beckhoff.com>

You will also find further documentation for Beckhoff components there.

Beckhoff Headquarters

Beckhoff Automation GmbH & Co. KG

Huelshorstweg 20
33415 Verl
Germany

Phone:	+49(0)5246/963-0
Fax:	+49(0)5246/963-198
e-mail:	info@beckhoff.com

Beckhoff Support

Support offers you comprehensive technical assistance, helping you not only with the application of individual Beckhoff products, but also with other, wide-ranging services:

- support
- design, programming and commissioning of complex automation systems
- and extensive training program for Beckhoff system components

Hotline:	+49(0)5246/963-157
Fax:	+49(0)5246/963-9157
e-mail:	support@beckhoff.com

Beckhoff Service

The Beckhoff Service Center supports you in all matters of after-sales service:

- on-site service
- repair service
- spare parts service
- hotline service

Hotline:	+49(0)5246/963-460
Fax:	+49(0)5246/963-479
e-mail:	service@beckhoff.com