

XNE-2CNT-2PWM Technology Module

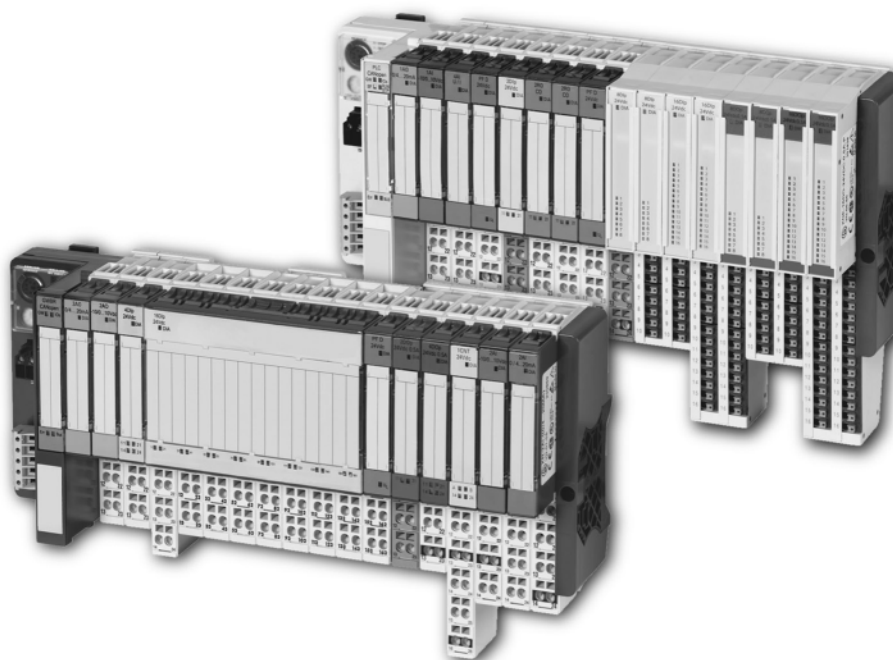

Imprint

Manufacturer

Eaton Automation AG
Spinnereistrasse 8-14
CH-9008 St. Gallen
Switzerland
www.eaton-automation.com
www.eaton.com

Support

Region North America
Eaton Corporation
Electrical Sector
1111 Superior Ave.
Cleveland, OH 44114
United States
877-ETN-CARE (877-386-2273)
www.eaton.com

Other regions
Please contact your supplier or send an
E-mail to:
automation@eaton.com

Original manual

The German version of this document is the original manual.

Translations of the original manual

All non-German editions of this document are translations of the original manual.

Editorial department

Monika Jahn

Brand and product names

All brand and product names are trademarks or registered trademarks of the owner concerned.

Copyright

© Eaton Automation AG, CH-9008 St. Gallen

All rights reserved, also for the translation.

None of this document may be reproduced or processed, duplicated or distributed by electronic systems in any form (print, photocopy, microfilm or any other process) without the written permission of Eaton Automation AG, St. Gallen.

Subject to modifications.

Safety regulations

Before commencing the installation:

- Disconnect the power supply of the device.
- Ensure that devices cannot be accidentally restarted.
- Verify isolation from the supply.
- Earth and short circuit.
- Cover or enclose neighboring units that are live.
- Follow the engineering instructions of the device concerned.
- Only suitably qualified personnel in accordance with EN 50110-1/-2 (DIN VDE 0105 Part 100) may work on this device/system.
- Before installation and before touching the device ensure that you are free of electrostatic charge.
- The functional earth (FE) must be connected to the protective earth (PE) or to the potential equalization. The system installer is responsible for implementing this connection.
- Connecting cables and signal lines should be installed so that inductive or capacitive interference do not impair the automation functions.
- Install automation devices and related operating elements in such a way that they are well protected against unintentional operation.
- Suitable safety hardware and software measures should be implemented for the I/O interface so that a line or wire breakage on the signal side does not result in undefined states in the automation devices.
- Ensure a reliable electrical isolation of the low voltage for the 24 volt supply. Only use power supply units complying with IEC/HD 60364-4-41 (DIN VDE 0100 Part 410).
- Deviations of the mains voltage from the rated value must not exceed the tolerance limits given in the specifications, otherwise this may cause malfunction and dangerous operation.
- Emergency stop devices complying with IEC/EN 60204-1 must be effective in all operating modes of the automation devices. Unlatching the emergency-stop devices must not cause restart.
- Devices that are designed for mounting in housings or control cabinets must only be operated and controlled after they have been installed with the housing closed. Desktop or portable units must only be operated and controlled in enclosed housings.
- Measures should be taken to ensure the proper restart of programs interrupted after a voltage dip or failure. This should not cause dangerous operating states even for a short time. If necessary, emergency-stop devices should be implemented.
- Wherever faults in the automation system may cause damage to persons or property, external measures must be implemented to ensure a safe operating state in the event of a fault or malfunction (for example, by means of separate limit switches, mechanical interlocks etc.).
- The electrical installation must be carried out in accordance with the relevant regulations (e. g. with regard to cable cross sections, fuses, PE).

Safety regulations

- All work relating to transport, installation, commissioning and maintenance must only be carried out by qualified personnel. (IEC/HD 60364 (DIN VDE 0100) and national work safety regulations).
- All shrouds and doors must be kept closed during operation.

Table of contents

1	About this manual.....	7
1.1	Documentation concept.....	7
1.1.1	Additional documentation.....	7
1.2	Description of symbols used.....	8
1.3	Overview.....	9
1.3.1	Prescribed use.....	9
1.3.2	Notes concerning planning /installation of this product.....	9
2	Getting Started - first steps for operating this module.....	11
2.1	General information about the module.....	11
2.1.1	Counter inputs.....	11
2.1.2	PWM outputs.....	11
2.2	Getting Started.....	12
2.2.1	Count function.....	12
2.2.2	PWM function.....	15
3	General description of the module.....	17
3.1	General information about the register interface.....	17
3.1.1	Mapping register contents into process data.....	18
3.1.2	Structure of the process data.....	19
3.2	Technical properties.....	20
3.2.1	Block diagram.....	20
3.2.2	Technical data.....	21
3.2.3	Wiring diagram.....	22
3.2.4	Diagnostic and status messages.....	23
3.2.5	Diagnostic data of the module.....	24
3.2.6	Parameter data of the module.....	25
3.2.7	Process data of the module.....	28
4	Functions of the count inputs (CNT1 and CNT2).....	35
4.1	Basic functions of the count inputs CNTx.....	35
4.1.1	Load count value.....	35
4.1.2	Load load value.....	35
4.1.3	Set count limits.....	36
4.1.4	Enabling the counter.....	37
4.1.5	Latch Retrigger (CNT).....	38
4.1.6	Function of the CMPx compare registers.....	38
4.1.7	Method of counting: single counting.....	39
4.1.8	Method of counting: periodical counting.....	40
4.1.9	Count inputs Ax and Bx.....	42
4.1.10	Special function of inputs Z1 and Z2 at CNTx.....	45
4.2	Additional functions of the count inputs.....	52
4.2.1	Additional function: Measurement mode.....	52
5	Functions of the PWM outputs (PWM1 and PWM2).....	59
5.1	Functions of the PWM outputs (PWM1 and PWM2).....	59
5.1.1	Module restart with saved values.....	59
5.1.2	Operation modes of the PWM outputs Px.....	60
5.1.3	Continuous signal output.....	65
5.1.4	Periodical signal output.....	67
5.1.5	Enabling the pulse output.....	68
5.1.6	Latch retrigger (PWM).....	69

Table of contents

5.1.7	Special function of inputs Z1 and Z2 for the PWM	70
6	Description of the function outputs D1 and D2.....	75
6.1	General.....	75
6.1.1	Direct access to Dx	75
6.1.2	Parameterization of the function "mode Dx"2.....	75
7	Report of configuration errors	81
7.1	Error-register	81
7.1.1	Error messages in REG_CONFIG_ERRSTS for the count operation mode (CNT1 and CNT2)	81
7.1.2	Error messages in REG_CONFIG_ERRSTS for the PWM output (PWM1 and PWM2)	83
8	Error handling in the control interface / check-back interface	85
8.1	Error messages of the module.....	85
8.1.1	Non-volatile flags (MSG).....	85
8.1.2	Storage of messages (MSG)	87
9	Register interface	89
9.1	Internal registers - reading and writing.....	89
9.1.1	Write access.....	89
9.1.2	Read access	90
9.2	Register description and register access	91
9.2.1	Register interface	91
10	Representation of the XNE-2CNT-2PWM in PROFIBUS-DPV1	99
10.1	Process data of the module in PROFIBUS-DPV1	99
10.1.1	Process input / check-back interface.....	100
10.1.2	Process output / control interface	101
10.2	Diagnostics of the module in DPV1.....	102
10.2.1	DPV1 error codes	102
10.2.2	Diagnostic data.....	103
10.3	Parameter in DPV1	104
10.3.1	Parameter data of the module.....	105
11	Representation of the XNE-2CNT-2PWM in CANopen	107
11.1	Objects for counter modules.....	107
11.1.1	General object overview for counter modules	107
11.1.2	Object descriptions	109
11.2	Emergencies of the XNE-2CNT-2PWM.....	148
11.2.1	Structure of the emergency frames	148
12	Appendix	149
12.1	Flow chart of a count operation.....	149
12.2	Flow chart of a pulse output.....	150
13	Index.....	151

1 About this manual

1.1 Documentation concept

This manual describes the technology module XNE-2CNT-2PWM which is part of the product line XI/ON.

In addition to the description of the technical features and functions, it also contains a description of the I/O module's representation in different field bus systems.

1.1.1 Additional documentation

- MN05002004Z
User Manual XI/ON
Gateways for PROFIBUS-DP
- MN05002005Z
User Manual XI/ON
Gateways for CANopen



Note

All manuals concerning the product line XI/ON can be found on our website (www.eaton-automation.com) under "DOWNLOADS".

1 About this manual

1.2 Description of symbols used

1.2 Description of symbols used



Warning

This sign can be found next to all notes that indicate a source of hazards. This can refer to danger to personnel or damage to the system (hardware and software) and to the facility.

This sign means for the operator: work with extreme caution.



Attention

This sign can be found next to all notes that indicate a potential hazard.

This can refer to possible danger to personnel and damages to the system (hardware and software) and to the facility.



Note

This sign can be found next to all general notes that supply important information about one or more operating steps.

These specific notes are intended to make operation easier and avoid unnecessary work due to incorrect operation.

1.3 Overview



Attention

Please read this section carefully. Safety aspects cannot be left to chance when dealing with electrical equipment.

This manual includes all information necessary for the prescribed use of the gateway XNE-GWBR-2ETH-MB. It has been specially conceived for personnel with the necessary qualifications.

1.3.1 Prescribed use

Appropriate transport, storage, deployment and mounting as well as careful operating and thorough maintenance guarantee the trouble-free and safe operation of these devices.



Warning

The devices described in this manual must be used only in applications prescribed in this manual or in the respective technical descriptions, and only with certified components and devices from third party manufacturers.

1.3.2 Notes concerning planning /installation of this product



Warning

All respective safety measures and accident protection guidelines must be considered carefully and without exception.

1 About this manual

1.3 Overview

2 Getting Started - first steps for operating this module

2.1 General information about the module

The XNE-2CNT-2PWM provides 2 counter channels (CNT1 and CNT 2) with 3 count inputs each DI0 (A), DI1 (B) and DI2 (Z) as well as 2 channels with 2 outputs each, P0 and P1 (frequency output) and D1 and D2 (direction).

2.1.1 Counter inputs

The module's counter inputs allow the connection of encoders as well as of count- and direction signals, with the direction evaluation being optional.

Operation modes

- Counting
 - Pulse and direction, → see page 43
 - AB mode, → see page 44
- Measurement
 - Frequency measurement / rotational speed measurement, → see page 53
 - Period duration measurement, → see page 55

2.1.2 PWM outputs

Each channel provides two PWM outputs P1/D1 and P2/D2.

P1 and P2 are used for frequency output.

The logical status of the outputs D1 and D2 can be used to define the rotation direction. The outputs can also be used independently of the PWM.

The outputs Px serve to give out a square wave signal with a defined mark-to-space ratio, a defined period duration and a defined number of pulses.

operation modes

- Period duration / duty cycle, → see page 61
- High time / low time definition, → see page 63

2 Getting Started - first steps for operating this module

2.2 Getting Started

2.2 Getting Started

2.2.1 Count function

The following section describes the general procedure to read the count value of counter **CNT1** of XNE-2CNT-2PWM.

Prerequisites / start conditions

The default settings of the module parameters allow immediate access to the module's count value.

- Parameterization:
mode CNT1 = 0000 = pulse/direction, single sample
(Parameter data of the module (page 25)).
The signals on input A1 are counted, the count direction is defined via signal B1.
Z1 can be used as a HW gate (→ see below).
- Mapping of the count value into the process data:
The count value is mapped into the process data (Process input / check-back interface (page 28)):
ADR AUX REG1 RD DATA = 0x20
→ 0x20 = register no. of REG_CNT1_CNT (actual count value of CNT1) → see also Register interface (page 91).
→ The count value is mapped into bytes 12 to 15 of the process data (→ see also Process input / check-back interface (page 28)).

Current count value

Process input / check-back interface (page 28), byte 12 to byte 15:

AUX_REG1_RD_DATA, Byte 0,

to

AUX_REG1_RD_DATA, Byte 3 contain the current count value of **CNT1**

Enable

The counter function unit of the CNT-inputs is generally enabled per **default setting**.

CNT1_GENERAL_DISABLE = 0

(→ see Process output / control interface byte 0, bit 0, page 32).

The function unit can be generally disabled by setting

CNT1_GENERAL_DISABLE = 1.

The general enabling of the counter function unit is displayed via

STS_CNT1_GENERAL_EN = 1.

(→ see Process input / check-back interface byte 0, bit 0, page 28).

- 1 If the counter has to count from a defined start value, this value has to be written into the load value register REG_CNT1_LOADVAL (→ see Internal registers - reading and writing (page 89)).
- 2 A state change from 0 → 1 in control bit CNT1_SW_LR of the process output / control interface executes a Latch Retrigger which is necessary to transfer the load value.
- 3 An executed Latch Retrigger is confirmed in the process input / check-back interface with MSG_CNT1_SW_LR = 1.
- 4 The load value (REG_CNTx_LOADVAL) is transferred into the register for the current count value CNT1 REG_CNTx_CNT (→ see also Register interface (page 91)).

- 5 If the start conditions for the count operation are defined, the count operation has to be enabled using either the HW **or** the SW gate.
 - 5.1 The default parameterization allows an immediate enabling of the count function via a signal at input Z (HW gate).
Parameters:
Mode Z1 = 0001 = HW gate CNT (→ see Parameter data of the module (page 25))
or
 - 5.2 If the SW gate is to be used to enable the counting, the user has to set the process output bit
CNT1_ENABLE 0 → 1
(→ see Process output / control interface (page 32), byte 0, bit 1.
- 6 The count operation is enabled with CNT1_ENABLE = 1.
- 7 The pulses are counted according to the parameterized operation mode.
(→ see Process input / check-back interface (page 28), byte 0, bit 1, STS_CNT1_RUN = 1)
- 8 In default parameterization, the data (→ see above Prerequisites / start conditions (page 12)) can be read out from registers AUX_REG1_RD_DATA, byte 0 to AUX_REG1_RD_DATA, byte 3 (bytes 12 to 15 of the process input data /check-back interface ((→ see also Current count value (page 12)).



Note

For further functions of the XNE-2CNT-2PWM (parameterization, process image, internal registers etc.), please read the following chapters.

2 Getting Started - first steps for operating this module

2.2 Getting Started

Figure 1:
Count function,
simplified repre-
sentation

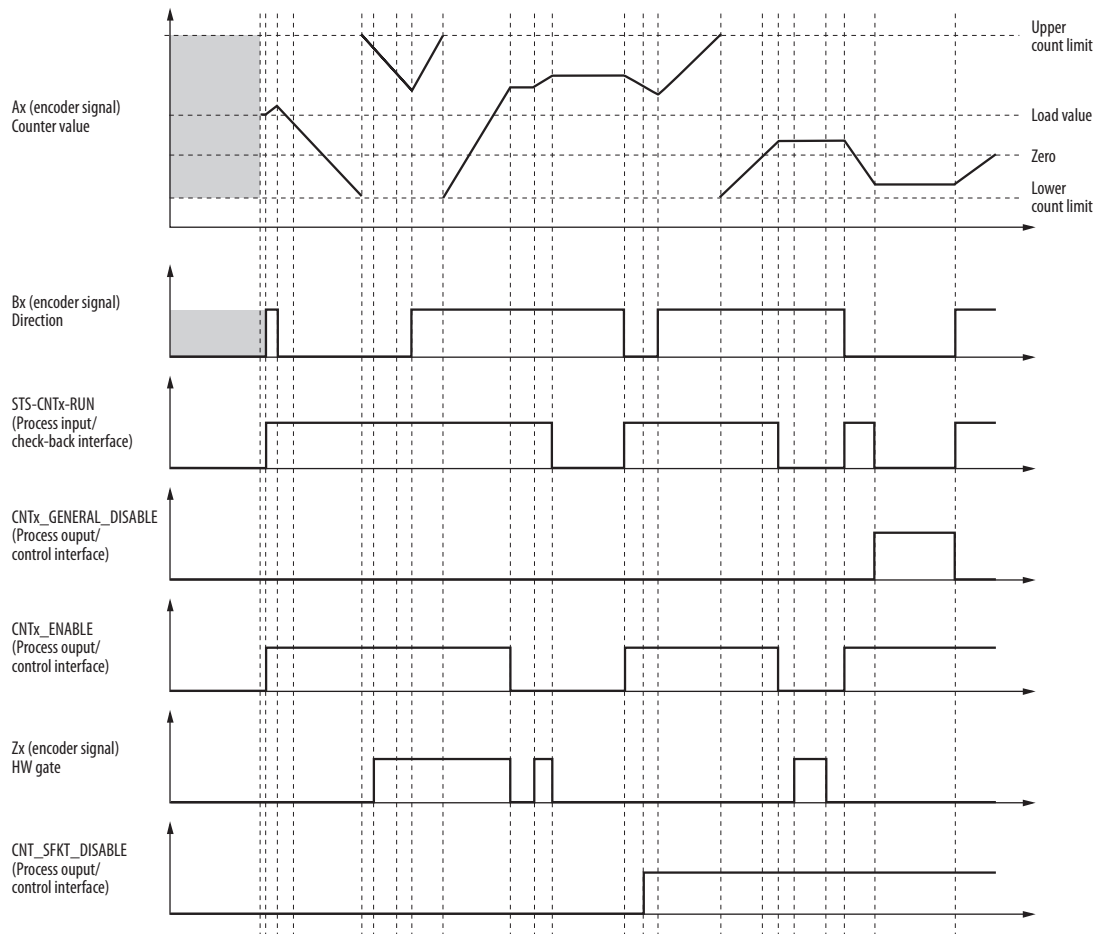

2.2.2

PWM function

The following section describes the current procedure to output pulses at **PWM1** of XNE-2CNT-2PWM:

Prerequisites / start conditions

The default parameterization fulfils all necessary prerequisites / start conditions for a pulse output:

- Operation mode: Period duration / duty cycle definition, → see Parameter data of the module (page 25) and Period Duration / Duty Cycle Definition (page 61)
- Period duration: 1000 Hz, → see REG_PWM1_PD (page 95)
- Duty cycle: 50 %, → see REG_PWM1_DC (page 95)
- PWM1_SINGLE = 0 (continuous enable, → see Process output / control interface (page 32))

**Note**

If a defined number of pulse is to be output, the bit PWM1_SINGLE has to be set = 1 (Process output / control interface (page 32)) **and** the number of the pulses to be output has to be defined via REG_PWM1_CNTSV (load value register of PWM1, register no. 0×64 , → see Chapter 9, Register interface (page 91)).

Enable

The pulse output **is generally enabled via the default settings.**

PWM1_GENERAL_DISABLE = 0

(→ see Process output / control interface byte 2, bit 0, page 32).

The pulse output can be generally disabled using PWM1_GENERAL_DISABLE = 1.

An enabled PWM function is displayed via

STS_PWM1_GENERAL_EN = 1.

(→ see Process input / check-back interface byte 4, bit 4, page 28).

1 The user has to enable the pulse output using either the HW or the SW gate.

1.1 Hardware gate:

Input "Z" can be parameterized as HW gate for the pulse output:

Parameters:

Mode Z1 = 0001 = HW gate PWM (→ see Parameter data of the module (page 25))

or

1.2 Software gate:

The software gate is set via the process output bit

PWM1_ENABLE = 1.

(Process output / control interface byte 2, bit 1, page 32).

2 The pulse output is enabled.

3 The pulses are output according to the parameterized period duration and the parameterized duty cycle (see above).

(→ see Process input / check-back interface (page 28), byte 4, bit 5, STS_PWM1_RUN = 1)

2 Getting Started - first steps for operating this module

2.2 Getting Started

Figure 2:
PWM function,
simplified repre-
sentation

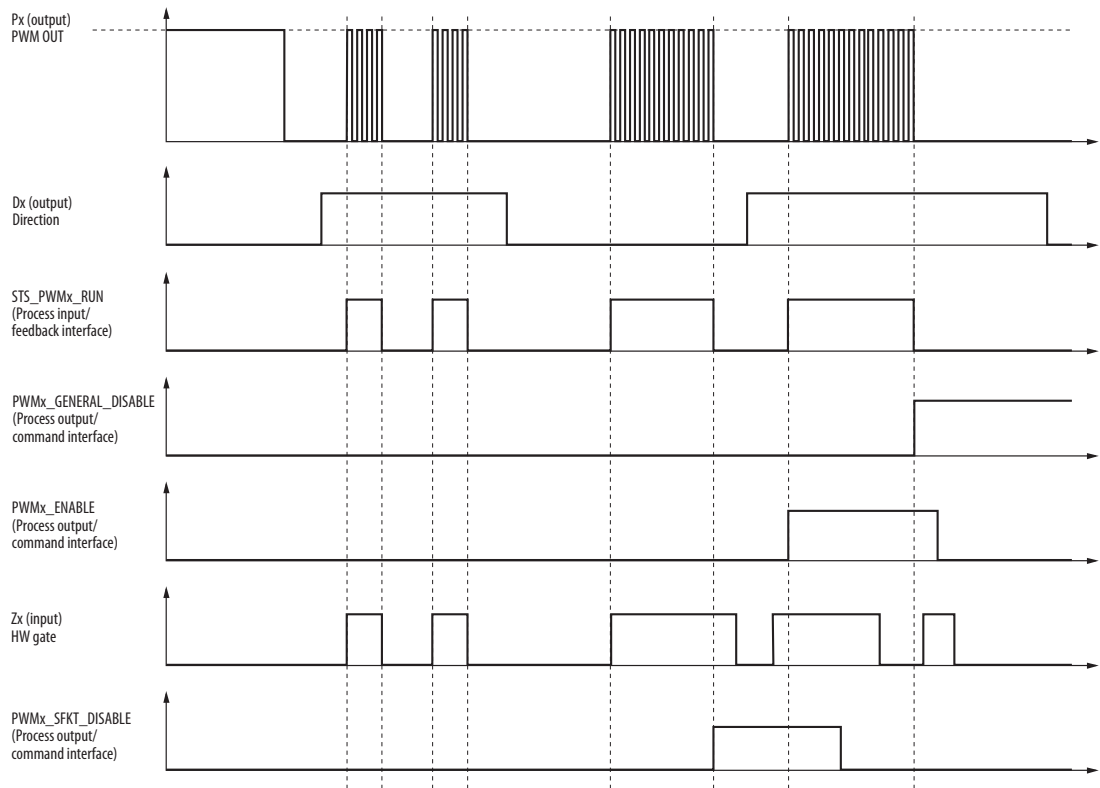

Note

For further functions of the XNE-2CNT-2PWM (parameterization, process image, internal registers etc.), please read the following chapters.

3 General description of the module

3.1 General information about the register interface

The module XNE-2CNT-2PWM contains an internal communication interface, the Register interface → see Chapter 9).

The data area of the register interface is organized in double words and consists of 128 registers large.

The 128 registers of the register interface allow access to all important information, data and settings concerning the module:

- Module information (hardware-version, software-version, etc.)
- Process data
- Parameter data
- Diagnostic data



Note

Please find a detailed description of the register interface in Chapter 9, Register interface.

Example for registers in the register interface:

Table 1:
Example for
registers in the
register inter-
face

Register name	No.	Meaning
REG_HW_VER	0x02	hardware-version
REG_CONFIG_ERRSTS	0x0A	report of configuration errors
REG_DATA_IN1 byte 3-0	0x0C	process input data 1
REG_PARA1 byte 3-0	0x1C	parameter data 1
REG_CNT1_LOADVAL	0x23	load value CNT1



Note

A detailed description of the procedure for the read and the write process can be found in Chapter 9, Internal registers - reading and writing (page 89).

3 General description of the module

3.1 General information about the register interface

3.1.1 Mapping register contents into process data

A subset of the data in the register interface is mapped into the Process data of the module (page 28) in order to allow direct external access.

Bytes 8 -23 of the process data allow reading and writing 4 32-bit-registers of the register interface and can be allocated as required.

Addressing registers to be mapped

The address assignment of the register contents to be mapped can be carried out via the process data or via the module parameters:

1 Address assignment via process data

The address for **one** register access is directly defined via the Process output / control interface (page 32), byte 6 and 7 (REG_WR_ADR and REG_RD_ADR).

2 Address assignment via parameters

The address of **three** further registers to be mapped may be defined via Parameter data of the module (page 25), Byte 10 to Byte 15 (ADR_AUX_REG1_RD_DATA to ADR_AUX_REG3_WR_DATA).

Default-mapping per parameter setting:

Table 2: Default- mapping per parameter setting	Parameters	Default- Parameterization	Access	Register content
		Register no.		
	ADR_AUX_REG1_RD_DATA	0x20	RD	REG_CNT1_CNT current value CNT1
	ADR_AUX_REG2_RD_DATA	0x21	RD	REG_CNT1_MV measured value CNT1
	ADR_AUX_REG3_RD_DATA	0x40	RD	REG_CNT2_CNT current value CNT2
	ADR_AUX_REG1_WR_DATA	0x60	WR	REG_PWM1_PD period duration PWM1
	ADR_AUX_REG2_WR_DATA	0x61	WR	REG_PWM1_DC mark-to-space ratio PWM1
	ADR_AUX_REG3_WR_DATA	0x70	WR	REG_PWM2_PD period duration PWM2

3 General description of the module

3.1 General information about the register interface

Figure 3:
Schematic representation of the register mapping

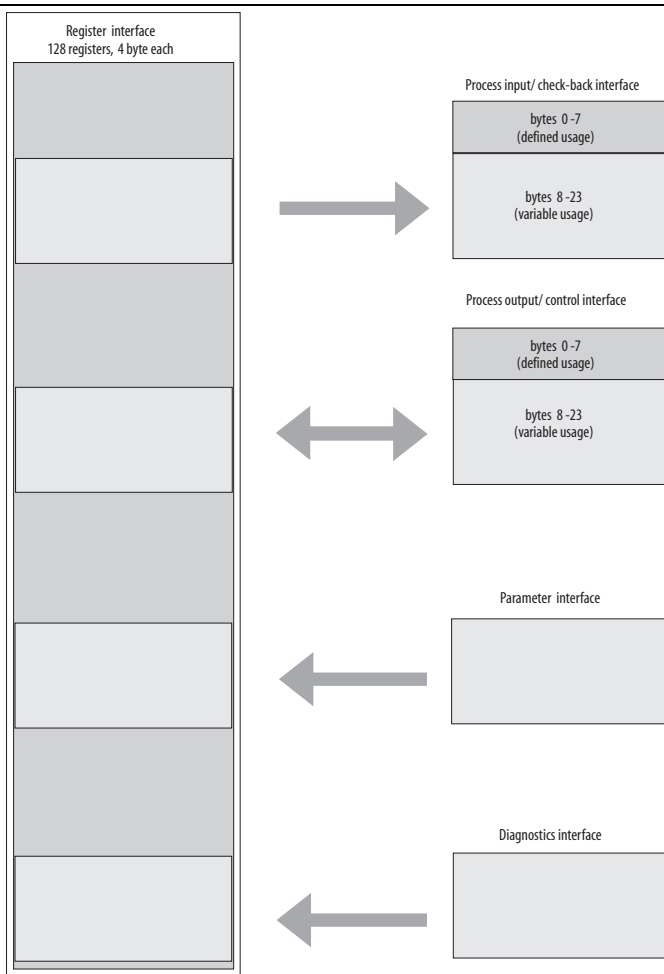

3.1.2

Structure of the process data

The process data of the XNE-2CNT-2PWM contain

- 24 byte process input data, → see page 28
- 24 byte process output data, → see page 32

Additionally, the module provides

- 4 byte diagnostic data, → see page 32
and
- 16 byte parameter data, → see page 25.

3 General description of the module

3.2 Technical properties

3.2 Technical properties

Figure 4:
XNE-2CNT-
2PWM

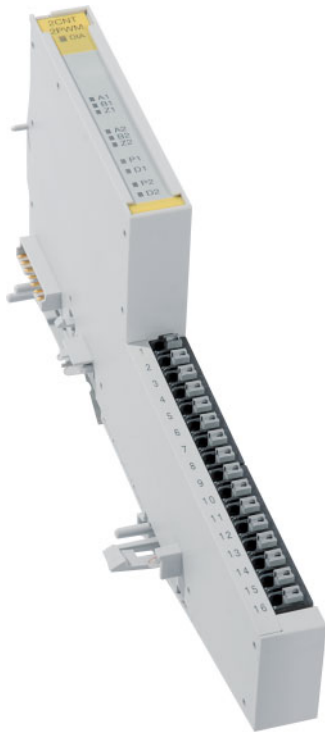

3.2.1 Block diagram

Figure 5:
Block diagram

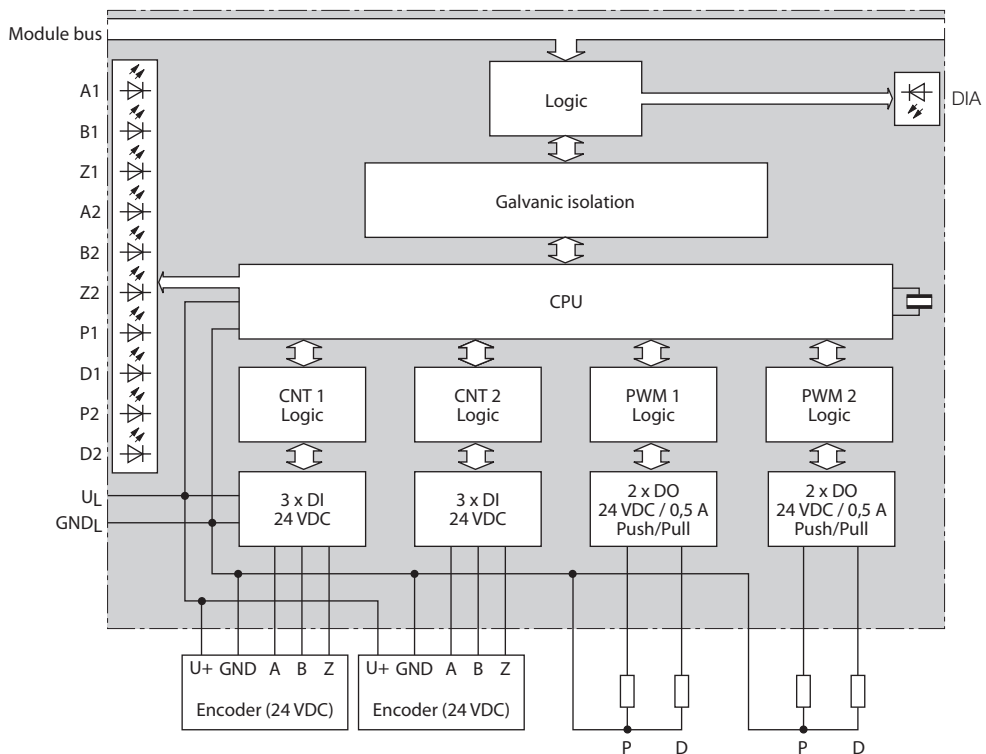

3.2.2 Technical data

Table 3:
Technical data

Designation	XNE-2CNT-2PWM	
Number of channels		
Count inputs	2	
PWM outputs	2	
Nominal voltage from supply terminal (U_L)	24 VDC	
Nominal current consumption from supply terminal (I_L)	Normally 35 mA all inputs and outputs are ,zero'	
Nominal current consumption from module bus (I_{MB})	≤ 30 mA	
Power loss of the module (P_V)	< 2 W	
Counter function		
Sensor supply		
Output voltage	UL (24VDC)	
Output current	< 0.5 A, not protected	
Digital inputs for count signals A, B Z		
Input voltage	0 to 30 VDC	
Parameterizable switching threshold U_{SE}	2.5 V	7.5 V
Low level I_L (active)	0 to 1 V	0 to 4.5 V
High level I_{HL} (active)	3.5 to 30 V	7.5 to 30 V
Input current		
Low level I_L (active)	0 to 0.1 mA	0 to 0.4 mA
High level I_{HL} (active)	0.3 to 3 mA	0.6 to 3 mA
Frequency (f)		
A	max. 200 kHz	
B	max. 200 kHz	
Z	max. 10 kHz	
Minimum pulse width (maximum counting frequency)		
at 200 kHz	≥ 2.5 μ s	
at 31.25 kHz	≥ 16 μ s	

3 General description of the module

3.2 Technical properties

Pulse- and direction output Px, Dx

R_{ON} switch-on resistance	300 m Ω
Output current I_A	
High level (nominal value)	0.5 mA
High level I_{AMAX}	0.6 A (according to IEC/EN 61131-2)
Simultaneity factor	100 %
Switching frequency	
at ohmic load	20 kHz
Short-circuit proof	Yes
Insulation voltage	
U_{MB} to IOs	500 V _{eff}
U_{MB} to FE / U_L to FE	500 V _{eff}
Measurement ranges	
Count mode (all modes)	up to 200 kHz
Frequency measurement	up to 200 kHz
Period duration measurement	up to 178 s

3.2.3 Wiring diagram

Figure 6:
Pin assignment
XNE-2CNT-
2PWM

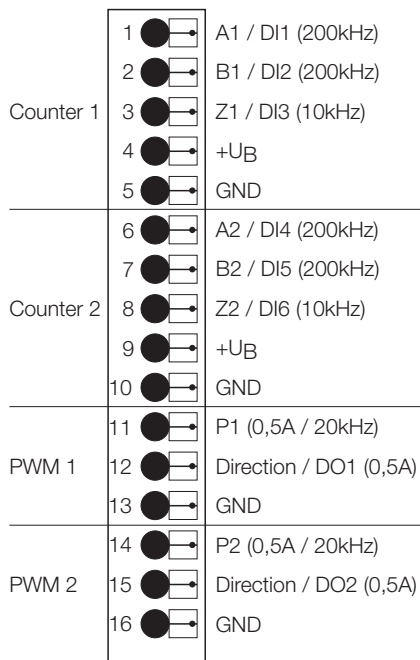

3.2.4 Diagnostic and status messages

Table 4:
LED-displays

LED	Display	Meaning	Remedy
DIA	red, flashing, 0.5 Hz	Diagnosis pending	
	red,	Module bus communication failure	Check if more than two adjoining electronics modules have been pulled. Check the power supply to the module bus.
	OFF	No error message or diagnosis	-
Ax, Bx, Zx	green	Input active	-
	OFF	Inputs not active	
Px, Dx	green	Output active	-
	red,	Overload at output	-
	OFF	Output inactive	

3 General description of the module

3.2 Technical properties

3.2.5 Diagnostic data of the module

The module's diagnostic data contain error messages that are operation and application relevant for the control system. 4 bytes are used to transfer the diagnostic data.

Byte	Bit 7	Bit 6	Bit 5	Bit 4	Bit 3	Bit 2	Bit 1	Bit 0
0	HW_ERR	CNT1_ PAR_ERR	X	X	X	X	X	X
1	HW_ERR	CNT2_ PAR_ERR	X	X	X	X	X	X
2	HW_ERR	PWM1_ PAR_ERR	X	X	X	X	P1_DIAG	D1_DIAG
3	HW_ERR	PWM2_ PAR_ERR	X	X	X	X	P2_DIAG	D2_DIAG

Table 5:
Diagnostics of
the XNE-2CNT-
2PWM

Diagnostic message	Values	Meaning
CNT1_PAR_ERR, CNT2_PAR_ERR, PWM1_PAR_ERR, PWM2_PAR_ERR	0	Parameter set of function unit correct
	1	Faulty / inconsistent parameters, wrong parameterization
P1_DIAG, P2_DIAG, D1_DIAG, D2_DIAG	0	No diagnostic message
	1	Diagnosis pending at channel (short circuit)
HW_ERR	0	No diagnostic message
	1	"Hardware error" Display of common errors of the module's hardware (e.g. CRC-error, adjustment error... Change of device necessary.

3 General description of the module

3.2 Technical properties

3.2.6 Parameter data of the module

Byte	Bit 7	Bit 6	Bit 5	Bit 4	Bit 3	Bit 2	Bit 1	Bit 0
0	input A1	input B1	input Z1	X	diagnostic CNT1	measurement mode CNT1	main count direction CNT1	
1	filter Z1		filter A1, B1		X	pull up Z1	X	threshold input A,B,Z CNT1
2	mode Z1				mode CNT1			
3	input A2	input B2	input Z2	X	diagnostic	measurement mode CNT2	main count direction CNT2	
4	filter Z2		filter A2, B2		X	pull up Z2	X	threshold input A,B,Z CNT2
5	mode Z2				mode CNT2			
6	diagnostic PWM1	X	mode D1					
7	DBP1 STS MODE		substitute value P1	substitute value D1	mode PWM1			
8	diagnostic PWM2	X	mode D2					
9	DBP2 STS MODE		substitute value P2	substitute value D2	mode PWM2			
10	X	ADR AUX REG1 RD DATA						
11	X	ADR AUX REG2 RD DATA						
12	X	ADR AUX REG2 RD DATA						
13	X	ADR AUX REG1 WR DATA						
14	X	ADR AUX REG2 WR DATA						
15	X	ADR AUX REG3 WR DATA						

X = reserved

3 General description of the module

3.2 Technical properties

Table 6:
Parameters of
the XNE-2CNT-
2PWM

A Default-
setting

Parameter name	Value	Meaning	
Main count direction CNTx	00	Basic function A	
	01	None	
	10	Up	
	11	Down	
Measurement mode CNTx	0	Frequency measurement A	
	1	Period duration measurement	
Diagnostic CNTx, Diagnostic PWMx	0	Diagnostic messages of the function unit activated in diagnostic interface A	
	1	Diagnostic messages of the function unit deactivated in diagnostic interface A	
Input Ax, Input Bx, Input Zx,	0 A	Signal logic remains (LOW = 0 / HIGH = 1)	
	1	Invert signal before processing	
Threshold input A,B,Z CNTx	0 A	Threshold 7.5V (only valid for Ax, Bx, Zx)	
	1	Threshold 2.5V (only valid for Ax, Bx, Zx)	
Pull Up Zx	0 A	Pull Up resistance 20 kΩ off	
	1	Pull Up resistance 20 kΩ on	
Filter Ax, Bx	00	2 μs A	Irrespective of the setting for the filter property, the maximum input frequency of the channel has to be considered
	01	16 μs	
	10	reserved	
	11		
Filter Zx	00	2 μs A	Irrespective of the setting for the filter property, the maximum input frequency of the channel has to be considered
	01	16 μs	
	10	reserved	
	11		
Mode CNTx (→ see page 42).	0000 A	Pulse direction, single sample	
	0001	Pulse direction, double sample	
	0010	AB mode, single sample	
	0011	AB mode, double sample	
	0100	AB mode, four samples	
	0101 to 1110	reserved	
	1111	AB only input	

3 General description of the module

3.2 Technical properties

Table 6:
Parameters of
the XNE-2CNT-
2PWM

Parameter name	Value	Meaning
Mode Zx (CNT1 page 45, PWM1 page 70)	0000	Alarm input CNT
	0001 A	HW gate CNT
	0010	Single Latch-Retrigger CNT
	0011	Continuous latch retrigger CNT
	0100	Single L.-R. and HW gate CNT
	0101	Continuous L.-R. and HW gate CNT
	0110	reserved
	0111	Alarm input PWM
	1000	HW gate PWM
	1001	Retrigger PWM
	1010 to 1110	reserved
1111	Z just input	
Mode Dx (→ see page 75).		Definition of the function for Dx (default = 11 1111 → single output, can be controlled via process data)
Mode PWMx (→ see page 60).	0000 A	PD DC Definition:
	0001	HT LT Definition
	0010 to 0111	reserved
	1111	P just output
Substitute value Px, Dx	0 A	The output of the substitute value depends on the parameterization of the used gateway (→ documentation for the XI/ON-gateways).
	1	
DBPx STS MODE	00 A	STS_DBPx = 1 with (REG_CNTx_CMP0) ≤ (REG_CNTx_CNT) < (REG_CNTx_CMP1)
	01	reserved
	10	
	11	STS_DBPx = Px
ADR AUX REGx WR DATA		Address of the basic write registers (Default ADR AUX REG1 WR DATA = 0x60, ADR AUX REG2 WR DATA = 0x61, ADR AUX REG3 WR DATA = 0x70)
ADR AUX REGx RD DATA		Address of the basic read registers (Default ADR AUX REG1 RD DATA = 0x20, ADR AUX REG2 RD DATA = 0x21, ADR AUX REG3 RD DATA = 0x40)

3 General description of the module

3.2 Technical properties

3.2.7 Process data of the module

Process input / check-back interface

	Byte	Bit 7	Bit 6	Bit 5	Bit 4	Bit 3	Bit 2	Bit 1	Bit 0
CNTx (page 29)	0	A1	B1	Z1	STS_CNT1_DIR	STS_CNT1_LOGMSG	STS_CNT1_SFKT_EN	STS_CNT1_RUN	STS_CNT1_GENERAL_EN
	1	MSG_CNT1_SW_LR	MSG_CNT1_SFKT	MSG_CNT1_FQE	MSG_CNT1_ND	MSG_CNT1_OFLW	MSG_CNT1_UFLW	MSG_CNT1_CMP1	MSG_CNT1_CMP0
	2	A2	B2	Z2	STS_CNT2_DIR	STS_CNT2_LOGMSG	STS_CNT2_SFKT_EN	STS_CNT2_RUN	STS_CNT2_GENERAL_EN
	3	MSG_CNT2_SW_LR	MSG_CNT2_SFKT	MSG_CNT2_FQE	MSG_CNT2_ND	MSG_CNT2_OFLW	MSG_CNT2_UFLW	MSG_CNT2_CMP1	MSG_CNT2_CMP0
PWMx page 30	4	STS_PWM1_LOGMSG	STS_PWM1_SFKT_EN	STS_PWM1_RUN	STS_PWM1_GENERAL_EN	MSG_PWM1_DO_ERR	MSG_PWM1_SFKT	MSG_PWM1_NDDC	MSG_PWM1_SW_LR
	5	STS_PWM2_LOGMSG	STS_PWM2_SFKT_EN	STS_PWM2_RUN	STS_PWM2_GENERAL_EN	MSG_PWM2_DO_ERR	MSG_PWM2_SFKT	MSG_PWM2_NDDC	MSG_PWM2_SW_LR
Communication page 31	6	REG_WVR_ACCEPT	REG_WR_AKN	REG_RD_ABORT	STS_CONFIG_ERR	STS_DBP2	D2	STS_DBP1	D1
	7	X	REG_RD_ADR						
User data page 31	8	REG_RD_DATA, Byte 0							
							
	11	REG_RD_DATA, Byte 3							
	12	AUX_REG1_RD_DATA, Byte 0							
							
	15	AUX_REG1_RD_DATA, Byte 3							
	16	AUX_REG2_RD_DATA, Byte 0							
							
	19	AUX_REG2_RD_DATA, Byte 3							
	20	AUX_REG3_RD_DATA, Byte 0							
							
23	AUX_REG3_RD_DATA, Byte 3								

X = reserved

**Note**

STATUS- (STS) or error messages (ERR) are volatile messages which are reset due to a change in status or due to the elimination of an error. In contrast, MSG describes a **non volatile** flag, which is set due to a certain event. It has to be reset (→ see Resetting the control bits (page 87)).

Table 7:
check-back
interface

Bit	Value	Meaning
CNTx		
STS_CNTx_GENERAL_EN	0	Function (CNTx) disabled
	1	Function enabled
STS_CNTx_RUN	0	CNTx Counter not ready to count
	1	CNTx Counter ready to count
STS_CNTx_SFKT_EN	0	Special function of Z disabled for CNTx
	1	Special function of Z enabled for CNTx
STS_CNTx_LOGMSG	0	Curent status of MSG bits
	1	Status of MSG bits are frozen
STS_CNTx_DIR	0	CNTx Counter counts down.
	1	CNTx Counter counts up.
Ax, Bx, Zx	0	Digital input is LOW.
	1	Digital input is HIGH.
MSG_CNTx_CMP0	0	No message active that reports that the compare value CMP0 has been reached.
	1	The counter CNTx reports that the compare value CMP0 was reached.
MSG_CNTx_CMP1	0	No message active that reports that the compare value CMP1 has been reached.
	1	The counter CNTx reports that the compare value CMP1 was reached.
MSG_CNTx_UFLW	0	No message active that reports that the lower count limit has been reached.
	1	The counter CNTx reports the lower count limit was reached.
MSG_CNTx_OFLW	0	No message active that reports that the upper count limit has been reached.
	1	The counter CNTx reports the upper count limit was reached.
MSG_CNTx_ND	0	No message active that reports a zero crossing.
	1	The counter CNTx reports a zero crossing.

3 General description of the module

3.2 Technical properties

Table 7: check-back interface	Bit	Value	Meaning
MSG_CNTx_FQE		0	No error occurred in frequency or period duration measurement.
		1	The counter CNTx reports an error in frequency / period duration measurement. Possible error causes: Max. length of the no-pulse period reached. The value cannot be displayed correctly in the register for the "pulses per integration time" REG_CNTx_IPI (page 93 or page 94) due to a multiplier which has been set too high in register REG_CNTx_MUL (page 93 or page 94).
MSG_CNTx_SFKT		0	The event according to there parameterized special function CNT1_SFKT_DISABLE did not occur .
		1	The event according to there parameterized special function CNT1_SFKT_DISABLE occurred.
MSG_CNTx_SW_LR		0	The function Latch-Retrigger (→ see also page 49) has not been activated.
		1	The function Latch-Retrigger (→ see also page 49) has been activated via bit CNTx_SW_LR = 1 (→ see also page 33).
PWMx			
MSG_PWM1x_SW_LR		0	The function Latch-Retrigger (→ see also page 49) has not been activated.
		1	The function Latch-Retrigger (→ see also page 49) has been activated via bit PWMx_SW_LR = 1 (→ see also page 34).
MSG_PWMx_NDDC		0	No message active that reports a zero crossing of the PWMx.
		1	The counter PWMx reports a zero crossing.
MSG_PWMx_SFKT		0	The event according to there parameterized special function PWMx_SFKT_DISABLE did not occur .
		1	The event according to there parameterized special function PWMx_SFKT_DISABLE occurred.
MSG_PWMx_DO_ERR		0	No error message from outputs Px / Dx.
		1	One of the outputs Px (Px_DIAG) or Dx (Dx_DIAG) of the corresponding PWMx-channel sent an error.
STS_PWMx_GENERAL_EN		0	Function (PWMx) disabled
		1	Function enabled, with a change from 0 → 1 the channel is set to the initial state
STS_PWMx_RUN		0	PWMx-signal output not active
		1	PWMx-signal output active
STS_PWMx_SFKT_EN		0	Special function of Z disabled for PWMx
		1	Special function of Z enabled for PWMx

3 General description of the module

3.2 Technical properties

Table 7:
check-back
interface

Bit	Value	Meaning
STS_PWMx_LOGMSG	0	Current status of MSG bits
	1	Status of MSG bits are frozen
Communication		
Dx	0	Digital input is LOW
	1	Digital input is HIGH
STS_DBPx	0	Status of the information defined through DBPx STS MODE.
	1	
STS_CONFIG_ERR	0	The present configuration is OK.
	1	In REG_CONFIG_ERR an error is reported
REG_RD_ABORT	0	The reading of the register defined in REG_RD_ADR has been accepted and executed. The content of the register can be found in the user data (REG_RD_DATA).
	1	Reading of the register defined in REG_RD_ADR has not been accepted. The register content (REG_RD_DATA) is zero.
REG_WR_AKN	0	A change of register contents had been assigned through a process output.
	1	No change of register contents through a process output. (Write access REG_WR to the register interface is only possible, if this bit was zero before; handshake for data transfer to the registers).
REG_WR_ACCEPT	0	Writing the user data from the control interface to the register addressed with REG_WR_ADR in the control interface could not be done.
	1	Writing the user data from the control interface to the register addressed with REG_WR_ADR in the control interface was successful.
REG_RD_ADR	0 to 127	Address of the input register of which the content is shown in the user data (REG_RD_DATA) in the check-back interface if REG_RD_ABORT = 0.
User data		
REG_RD_DATA	0 ... $2^{32}-1$	Content of the register of which the address is transferred with the process input data (REG_RD_ADR) if REG_RD_ABORT = 0. If not, REG_RD_DATA = 0.
AUX_REGx_RD_DATA	0 ... $2^{32}-1$	Value, which is read from the register with the address defined in the parameterization in ADR_AUX_REGx_RD_DATA.

3 General description of the module

3.2 Technical properties

Process output / control interface

		Byte	Bit 7	Bit 6	Bit 5	Bit 4	Bit 3	Bit 2	Bit 1	Bit 0
Control bytes	CNT x (page 33)	0	X	CNT1_SINGLE	CNT1_SW_LR	CNT1_SFKT_DISABLE	X	CNT1_LOGMSG	CNT1_ENABLE	CNT1_GENERAL_DISABLE
		1	X	CNT2_SINGLE	CNT2_SW_LR	CNT2_SFKT_DISABLE	X	CNT2_LOGMSG	CNT2_ENABLE	CNT2_GENERAL_DISABLE
	PWM x (page 33)	2	X	PWM1_SINGLE	PWM1_SW_LR	PWM1_SFKT_DISABLE	X	PWM1_LOGMSG	PWM1_ENABLE	PWM1_GENERAL_DISABLE
		3	X	PWM2_SINGLE	PWM2_SW_LR	PWM2_SFKT_DISABLE	X	PWM2_LOGMSG	PWM2_ENABLE	PWM2_GENERAL_DISABLE
	DOs	4	X	X	SET_P2	SET_D2	X	X	SET_P1	SET_D1
Register access (page 89)		5	REG_WR	X	X	X	X	AUX_REG3_WR_EN	AUX_REG2_WR_EN	AUX_REG1_WR_EN
		6	X	REG_WR_ADR						
		7	X	REG_RD_ADR						
User data		8	REG_WR_DATA, byte 0							
								
		11	REG_WR_DATA, byte 3							
		12	AUX_REG1_WR_DATA, byte 0							
								
		15	AUX_REG1_WR_DATA, byte 3							
		16	AUX_REG2_WR_DATA, byte 0							
								
		19	AUX_REG2_WR_DATA, byte 3							
		20	AUX_REG3_WR_DATA, byte 0							
								
	23	AUX_REG3_WR_DATA, byte 3								

X = reserved

3 General description of the module

3.2 Technical properties

Table 8:
Process output
data of the
module

Bit	Value	Meaning
CNTx_GENERAL_DISABLE	0	Enable function unit CNTx
	1	Disable function unit CNTx generally
CNTx_ENABLE	0	Not activated
	1	Enable counter CNTx (SW gate) The enable is done either per SW- or per HW gate, → see Enabling the counter (page 37)).
CNTx_LOGMSG	0	The messages in the MSG-bits (MSG for CNTx (page 85)) in the Process input / check-back interface are active
	1	With a change from 0 → 1 the MSG data are held and actual incoming messages are stored to register REG_PWMx_LOGMSG, → see for example Error handling in the control interface / check-back interface (page 85) Before switching to REG_CNTx_LOGMSG, this register is set to "0". With a change from 1 → 0, all data from REG_CNTx_LOGMSG are copied to the MSG-bits in the Process input / check-back interface.
CNT1_SFKT_DISABLE	0	Enable the special function of input Zx depending on the parameterization Mode Zx .
	1	Disable the special function of input Zx.
CNTx_SW_LR	0	Not activated
	1	A Software (SW) latch retrigger (page 38) has to be executed at counter CNTx with a change from 0 → 1
CNTx_SINGLE	0	Continuous enabling of CNTx (Method of counting: periodical counting (page 40))
	1	Single enabling of CNTx (Method of counting: single counting (page 39))
PWMx_GENERAL_DISABLE	0	Enable function unit PWMx
	1	Disable function unit PWMx
PWMx_ENABLE	0	Not activated
	1	Enable output PWMx The enable is done either per SW- or per HW gate, → see Enabling the counter (page 37)).
PWMx_LOGMSG	0	The messages in the MSG-bits (MSG for PWMx (page 86)) in the Process input / check-back interface are active.
	1	With a change from 0 → 1 the MSG data are held and actual incoming messages are stored to register REG_PWMx_LOGMSG, → see for example Error handling in the control interface / check-back interface (page 85). Before switching to REG_PWMx_LOGMSG, this register is set to "0". With a change from 1 → 0, all data from REG_PWMx_LOGMSG are copied to the MSG-bits in the Process input / check-back interface.

3 General description of the module

3.2 Technical properties

Table 8:
Process output
data of the
module

Bit	Value	Meaning
PWMx_SFKT_DISABLE	0	Enable the special function of input Zx depending on the parameterization.
	1	Disable the special function of input Zx depending on the parameterization.
PWMx_SW_LR	0	Not activated
	1	A latch retrigger has to be executed at counter PWMx with a change from 0 → 1.
PWMx_SINGLE	0	Continuous enabling of PWM
	1	Single enabling of PWMx
SET_Dx	0	Clear bit Dx
	1	Set bit Dx
SET_Px	0	Clear bit Px
	1	Set bit Px
AUX_REG1_WR_EN ... AUX_REG3_WR_EN	0	Disabling the writing of register data with the register contents in AUX_REGx_WR_DATA. This option avoids an unintentional writing to registers in the Register interface (→ see also Internal registers - reading and writing (page 89)).
	1	Writing of the Register interface with the register contents in AUX_REGx_WR_DATA is enabled (→ see also Internal registers - reading and writing (page 89)).
REG_WR	0	Initial state
	1	Triggering a write command. The register of which the address has been defined with REG_WR_ADR, will be written with data from REG_WR_DATA.
REG_WR_ADR	0 ...127	Address of the register, which has to be written with REG_WR_DATA (→ see below).
REG_RD_ADR	0 ...127	Address of the register, which has to be read. The user data can be found in REG_RD_DATA in the Process input / check-back interface (page 28) if RD_ABORT = 0.
REG_WR_DATA, Byte 0 ... REG_WR_DATA, Byte 3	0 ... 2 ³² -1	Value which, during a write operation, has to be written to the register selected with REG_WR_ADR (→ see above).
AUX_REGx_WR_DATA, Byte 0 ... AUX_REGx_WR_DATA, Byte 3	0 ... 2 ³² -1	Value which, during a write operation, has to be written to the register defined in (ADR AUX REGx WR DATA (page 27)) in the parameterization.

4 Functions of the count inputs (CNT1 and CNT2)

4.1 Basic functions of the count inputs CNTx

4.1.1 Load count value

The count value can be loaded directly via the Register interface (page 91). To do so, the register (REG_CNTx_CNT) has to be written directly with the desired count value using the access via the Process output / control interface (page 32).

Register name	Register no.	Max. value	Min. value	Default value
REG_CNT1_CNT	32 (0x20)	+2147483647 (0x7F FF FF FF)	-2147483648 (0x80 00 00 00)	0 (0x00 00 00 00)
REG_CNT1_CNT	64 (0x40)			



Note

If the value to be loaded is outside the count limits, the value is not transferred as count value, but the count limit which is the closest to the value is loaded instead. No error message is set in REG_CONFIG_ERRSTS (CNTx) (page 81).

4.1.2 Load load value

The load value is loaded via the Process output / control interface (page 32) and copied into the count value (REG_CNTx_CNT) due to certain events.

These events have to be defined via the Parameter data of the module (page 25).

Register name	Register no.	Max. value	Min. value	Default value
REG_CNT1_LOADVAL	35 (0x23)	+2147483647 (0x7F FF FF FF)	-2147483648 (0x80 00 00 00)	0 (0x00 00 00 00)
REG_CNT2_LOADVAL	67 (0x43)			



Note

If a load value is loaded which is outside the count limits, the value is transferred and an error message is generated in REG_CONFIG_ERRSTS (CNTx) (page 81).

4 Functions of the count inputs (CNT1 and CNT2)

4.1 Basic functions of the count inputs CNTx

4.1.3 Set count limits

The count limits are contained in the following registers:

Register name	Register no.	Max. value	Min. value	Default value
REG_CNT1_LOLIMIT lower count limit CNT1	36 (0x24)	+2147483647 (0x7F FF FF FF)	-2147483648 (0x80 00 00 00)	-2147483648 (0x80 00 00 00)
REG_CNT1_HILIMIT upper count limit CNT1	37 (0x25)			+2147483647 (0x7F FF FF FF)
REG_CNT2_LOLIMIT lower count limit CNT2	68 (0x44)			+2147483647 (0x7F FF FF FF)
REG_CNT2_HILIMIT upper count limit CNT2	69 (0x45)			-2147483648 (0x80 00 00 00)

The count limits can be set via the Process output / control interface (page 32).



Note

If the count limits are loaded with $(REG_CNTx_HILIMIT) \leq (REG_CNTx_LOLIMIT)$, the value is transferred and an error message is recorded in the REG_CONFIG_ERRSTS (CNTx) (page 81).

If a count limit is set so that the actual count value is outside the count range, the current value is set to the count limit which is closest to it. In this case *no* error message is recorded in register REG_CONFIG_ERRSTS.

4.1.4

Enabling the counter

Prerequisite:

Enabling the counter via hard- or software gate requires a general enable of the count function using $CNT1_GENERAL_DISABLE = 0$ (default-setting).



Note

The counter can be enabled either per software **or** per hardware gate:

Example:

NOT $CNTx_GENERAL_DISABLE$ (page 32)

AND (SW-Tor **OR** HW-Tor)

Hardware gate (HW gate)

The count operation is enabled with signal $Zx = 1$ and disabled with $Zx = 0$.

Parameterization of Zx

In order to use Zx to enable the count operation, the special function of the input Zx has to be enabled as well (→ see Special function Zx (CNT): HW gate (page 47)).

The following applies for the HW gate:

$STS_CNTx_RUN = 1$,

if

$CNTx_GENERAL_DISABLE = 0$

and

$CNTx_SFKT_DISABLE = 0$

and

$Zx = 1$

Software-gate (SW gate)

The counter enable is done by setting the bits $CNT1_ENABLE$ (CNT1) or $CNT2_ENABLE$ (CNT2) of the Process output / control interface (page 32).

The following applies for the HW gate:

$STS_CNTx_RUN = 1$,

if

$CNTx_GENERAL_DISABLE = 0$

and

$CNTx_ENABLE = 1$

4 Functions of the count inputs (CNT1 and CNT2)

4.1 Basic functions of the count inputs CNTx

4.1.5 Latch Retrigger (CNT)

The internal count value is retriggered, which means the current count value is stored, the load value is reloaded as count value and the count operation continues.

The count function has to be enabled (→ see Enabling the counter (page 37)) in order to execute this latch retrigger.

Hardware (HW) latch retrigger

The hardware latch retrigger is done via a signal change at Zx 0 → 1 (→ see Special function Zx (CNT): Synchronization (HW latch retrigger) (page 49)). The event is reported via MSGx_CNTx_SFKT of the Process input / check-back interface (page 28) (bit 6 in byte 1 (CNT1) and byte 3 (CNT2)).

Software (SW) latch retrigger

The software latch retrigger is done via a signal change 0 → 1 in bit CNTx_SW_LR in the Process output / control interface (page 32). The executed SW latch retrigger is confirmed through bit MSG_CNTx_SW_LR of the Process input / check-back interface (page 28) (bit 7 in byte 1 (CNT1) and byte 3 (CNT2)).

4.1.6 Function of the CMPx compare registers

Each counter provides two compare registers.

If a counter reaches a count value which matches the content of one of its CMP-registers, this event is reported in the Process input / check-back interface (page 28) through MSG_CNTx_CMP0 or respectively MSG_CNTx_CMP1.

This message remains active until it is reset via the control interface when reading the counter's status messages setting CNTx_LOGMSG 1 → 0.

The compare values are loaded via the control interface.

Register name	Register no.	Max. value	Min. value	Default value
REG_CNT1_CMP0 Compare value 0 CNT1	38 (0x26)	+2147483647 (0x7F FF FF FF)	-2147483648 (0x80 00 00 00)	-2147483648 (0x80 00 00 00)
REG_CNT1_CMP1 Compare value 1 CNT1	39 (0x27)			+2147483647 (0x7F FF FF FF)
REG_CNT2_CMP0 Compare value 0 CNT2	70 (0x46)			+2147483647 (0x7F FF FF FF)
REG_CNT2_CMP1 Compare value 1 CNT2	71 (0x47)			-2147483648 (0x80 00 00 00)



Note

If a compare value is loaded which is outside the count limits, the value is transferred and an error message is generated in REG_CONFIG_ERRSTS (CNTx) (page 81).

4 Functions of the count inputs (CNT1 and CNT2)

4.1 Basic functions of the count inputs CNTx

4.1.7 Method of counting: single counting

If, in the Process output / control interface (page 32), single counting is activated via $CNTx_SINGLE = 1$, the following events reset the status bit STS_CNTx_RUN page 28.

Depending on the main count direction definition (Parameter data of the module (page 25)), the counter reacts as follows:

Table 9:
Main count
direction at
 $CNTx_SINGLE$
 $= 1$

Main count direction CNTx				
Bit 1	Bit 0			
0	0	Basic function	Load value	The counting operation starts with the current count value.
			Upper count limit	If, while counting upwards, the counter reaches the upper count limit and another counting pulse is received, the counter value jumps to the lower count limit.
			Lower count limit	If, while counting downwards, the counter reaches the lower count limit and another counting pulse is received, the counter value jumps to the upper count limit.
			Internal enable	The internal enable is automatically reset, if the counter value jumps to the other count limit after having exceeded the count limit.
0	1	None	Load value	The counting operation starts with the current count value.
			Upper count limit	If, while counting upwards, the counter reaches the upper count limit and another counting pulse is received, the counter value jumps to the load value.
			Lower count limit	If, while counting downwards, the counter reaches the lower count limit and another counting pulse is received, the counter value jumps to the load value.
			Internal enable	The internal enable is automatically reset, if the counter value jumps to the load value after having exceeded the count limit.
1	0	Up	Load value	The counting operation starts with the current count value.
			Upper count limit	If, while counting upwards, the counter reaches the upper count limit and another counting pulse is received, the counter value jumps to the load value.
			Lower count limit	If, while counting downwards, the counter reaches the lower count limit and another counting pulse is received, the counter value jumps to the upper count limit.
			Internal enable	The internal enable is automatically reset, if the counter value jumps to the load value or the other count limit after having exceeded the count limit.
1	1	Down	Load value	The counting operation starts with the current count value.
			Upper count limit	If, while counting downwards, the counter reaches the lower count limit and another counting pulse is received, the counter value jumps to the upper count limit. The counter continues counting starting at the lower count limit.
			Lower count limit	If, while counting downwards, the counter reaches the lower count limit and another counting pulse is received, the counter value jumps to the load value. The counter continues counting starting at the load value.
			Internal enable	The internal enable is not automatically reset. The counter remains active.

4 Functions of the count inputs (CNT1 and CNT2)

4.1 Basic functions of the count inputs CNTx

The internal enable is reset automatically when a count limit is reached and STS_CNTx_RUN is set = 0. In this case, with CNTx_ENABLE = 1 being active, a counter restart is executed through first setting bit CNTx_GENERAL_DISABLE to "1" and then resetting it to "0".

4.1.8 Method of counting: periodical counting

If, in the Process output / control interface (page 32), periodical counting is activated via CNTx_SINGLE = 0, the counter reacts as follows depending on the main count direction defined (Parameter data of the module (page 25)).

Table 10:
Main count
direction with
CNTx_SINGLE
= 0

Main count direction CNTx				
Bit 1	Bit 0			
0	0	Basic function	Load value	The counting operation starts with the current count value.
			Upper count limit	If, while counting upwards, the counter reaches the upper count limit and another counting pulse is received, the counter value jumps to the lower count limit. The counter continues counting starting at the lower count limit.
			Lower count limit	If, while counting downwards, the counter reaches the lower count limit and another counting pulse is received, the counter value jumps to the load value. The counter continues counting starting at the load value.
			Internal enable	The internal enable is not automatically reset. The counter remains active.
0	1	None	Load value	The counting operation starts with the current count value.
			Upper count limit	If, when counting upwards, the counter reaches the upper count limit and another counting pulse is received, the counter value jumps to the load value and continues counting.
			Lower count limit	If, when counting downwards, the counter reaches the lower count limit and another counting pulse is received, the counter value jumps to the load value and continues counting.
			Internal enable	The internal enable is not automatically reset. The counter remains active.
1	0	Up	Load value	The counting operation starts with the current count value.
			Upper count limit	If, while counting upwards, the counter reaches the upper count limit and another counting pulse is received, the counter value jumps to the load value. The counter continues counting starting at the load value.
			Lower count limit	If, while counting downwards, the counter reaches the lower count limit and another counting pulse is received, the counter value jumps to the upper count limit. The counter continues counting starting at the upper count limit.
			Internal enable	The internal enable is not automatically reset. The counter remains active.

4 Functions of the count inputs (CNT1 and CNT2)

4.1 Basic functions of the count inputs CNTx

Table 10:
Main count
direction with
CNTx_SINGLE
= 0

Main count direction CNTx

Bit 1	Bit 0			
1	1	Down	Load value	The counting operation starts with the current count value.
			Upper count limit	If, while counting upwards, the counter reaches the upper count limit and another counting pulse is received, the counter value jumps to the lower count limit. The counter continues counting starting at the lower count limit.
			Lower count limit	If, while counting downwards, the counter reaches the lower count limit and another counting pulse is received, the counter value jumps to the load value. The counter continues counting starting at the load value.
			Internal enable	The internal enable is not automatically reset. The counter remains active.



Note

The counting operation starts with the current count value. The user can preset this value to a defined value (→ see Load load value (page 35)).

4 Functions of the count inputs (CNT1 and CNT2)

4.1 Basic functions of the count inputs CNTx

4.1.9 Count inputs Ax and Bx

The inputs A1, B1 are the inputs for counter 1 (CNT1), inputs A2, B2 are the inputs for counter 2 (CNT2).

The functions of these inputs and the counter operation mode must be set via the parameters "mode CNT1"

and

"mode CNT2"

in the Parameter data of the module (page 25).

Possible functions (→ see page 42):

- Pulse and direction
 - Ax pulse, Bx direction / single sample
 - Ax pulse, Bx direction / double sample
- AB mode:
 - Single sample
 - Double sample
 - Four samples
- Simple digital input



Note

The parameterization of undefined functions is reported through a diagnostic message with CNTx_PAR_ERR = 1 (→ see Diagnostic data of the module (page 24)).
If CNTx_PAR_ERR = 1, then the counter cannot be activated.



Note

If a parameter error occurs, this is reported in the diagnostic data and an error message is set in REG_CONFIG_ERRSTS (CNTx) (page 81).

4 Functions of the count inputs (CNT1 and CNT2)

4.1 Basic functions of the count inputs CNTx

Operation mode: Pulse and direction

If the function "pulse direction, single sample" (→ see Parameter data of the module (page 25)) is set, the rising or falling edges of input Ax are evaluated, depending on the parameterization of input Ax.

If the function "pulse direction, double sample" (→ see Parameter data of the module (page 25)) is set, the rising and falling edges of input Ax are evaluated, depending on the parameterization of input Ax.

Signal Bx defines the count direction.

Figure 7:
Pulse and direction

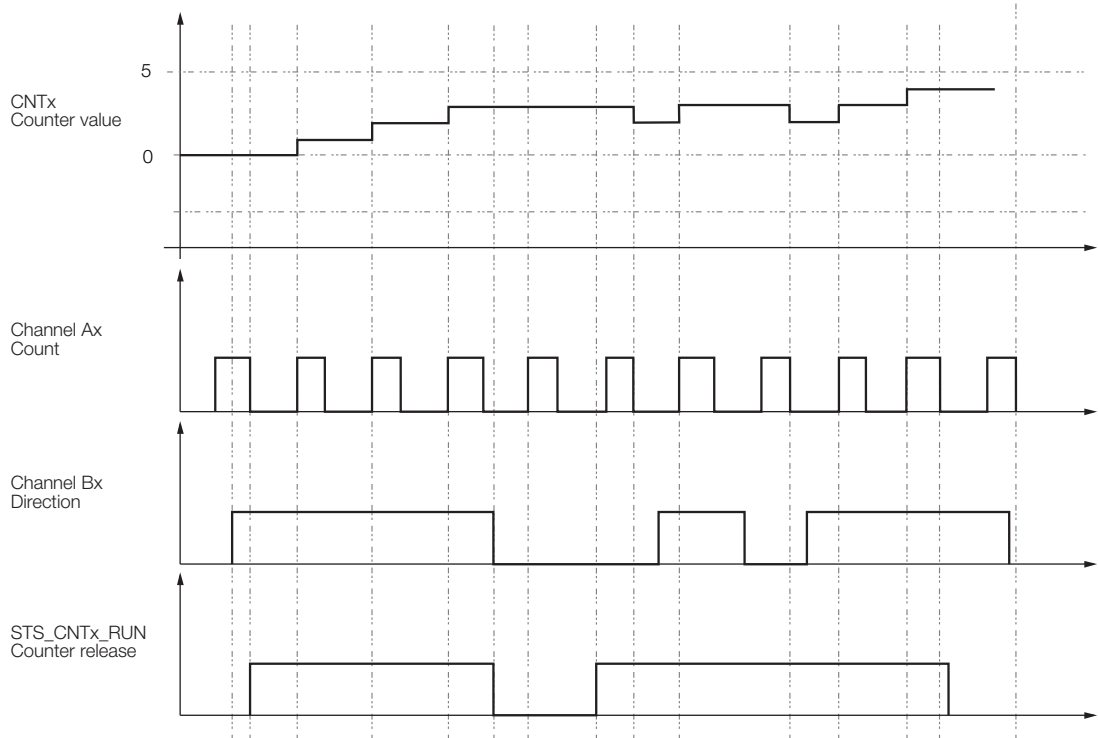
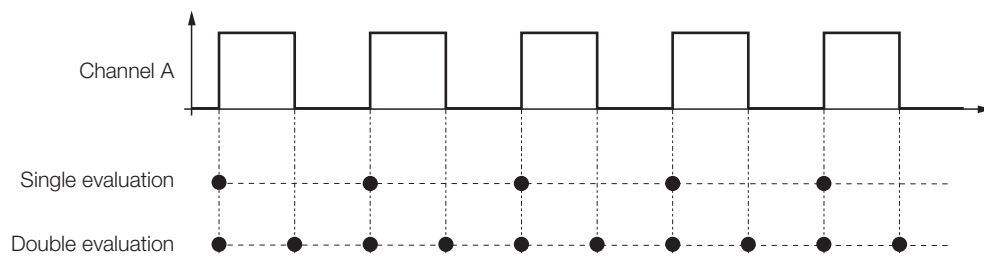

Figure 8:
Pulse and direction, evaluation



4 Functions of the count inputs (CNT1 and CNT2)

4.1 Basic functions of the count inputs CNTx

Time span between direction signal (B) and count signal (A)

For pulse generators with a direction signal, it must be ensured that there is a gap of at least $1,25 \mu\text{s}$ or $4 \mu\text{s}$ between the direction signal (B) and the counter signal (A), depending on the input filter configured.

Figure 9:
Time span between direction signal (B) and count signal (A)

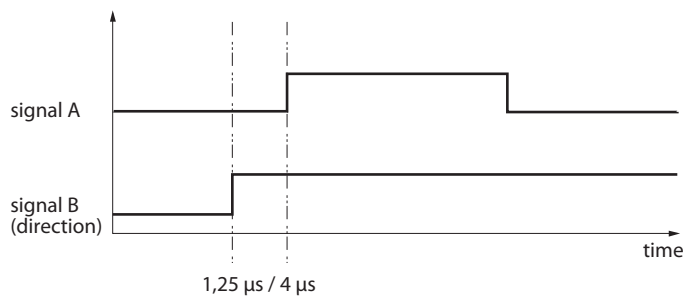

Operation mode: AB mode:

In the AB mode, pulse and direction are determined by the phasing of the input signals Ax and Bx.

The counter counts upwards, if the signal sequence is run through from the left to the right (pos. count direction). The counter counts downwards, if the signal sequence is run through from the right to the left (neg. count direction).

The points in the following figure mark the scan points (change in count value) depending on the parameterization.

Figure 10:
AB mode

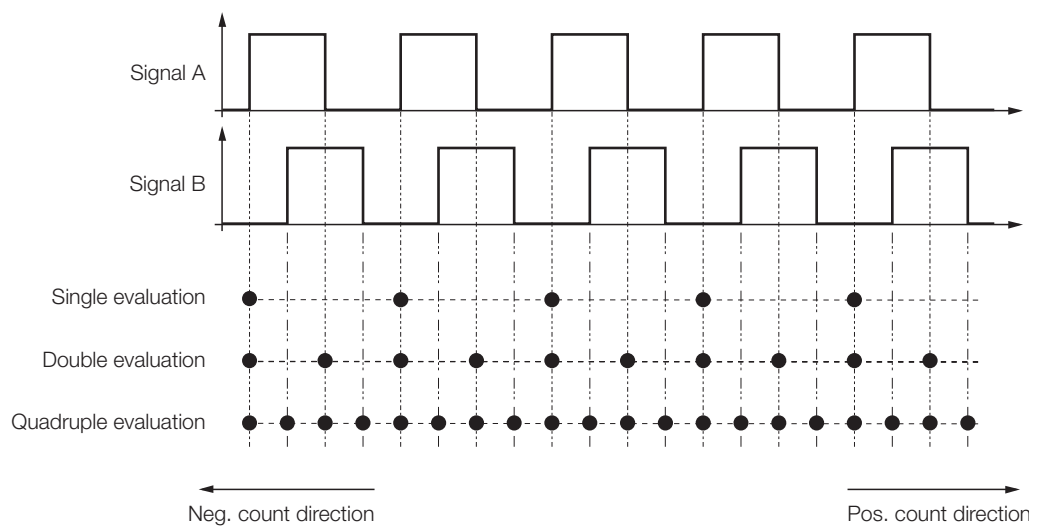

4 Functions of the count inputs (CNT1 and CNT2)

4.1 Basic functions of the count inputs CNTx

4.1.10 Special function of inputs Z1 and Z2 at CNTx

The inputs Z1 and Z2 can be used to support counter functions (or PWM functions, → see Chapter 5).



Note

Each special function of Zx is **enabled** per default via CNTx_SFKT_DISABLE = 0 in the Process output / control interface (page 32). The enabling of this function is acknowledged via STS_CNTx_SFKT_EN = 1.

The special function is **disabled** via CNTx_SFKT_DISABLE = 1.

The function of Zx is defined through the parameter "mode Zx" (→ see Parameter data of the module (page 25)).

Possible functions of the count inputs (CNT1 and CNT2) at a signal change 0 → 1:

- alarm (→ see Special function Zx (CNT): alarm (page 47))
- HW gate (counter enabling, → see Special function Zx (CNT): HW gate (page 47))
- Synchronization (latch retrigger, single or periodical with the load value, → see Special function Zx (CNT): Synchronization (HW latch retrigger) (page 49))

A **combination** of functions (for example: single synchronization *and* HW gate) is possible, using a combination of Z1 and Z2 (→ see also here Parameter data of the module (page 25)).

Table 11:
functions
Z1 and Z2

A Default-
setting

Bit 7 ... Bit 4 (Value)	mode Z1 (→ see byte 2 of the Parameter data of the module (page 25))	mode Z2 (→ see byte 5 of the Parameter data of the module (page 25))
0000	Alarm input CNT A signal change 0 → 1 at Zx causes the setting of the MSG_CNTx_SFKT flag. This serves to also report short-time events.	
0001 A	HW gate CNT The enabling can also be done per software gate (→ see also here Enabling the counter (page 37)) – with Zx = 0, the counter is disabled – with Zx = 1, the counter is enabled	
0010	Single Latch-Retrigger CNT With the first signal change 0 → 1 at Z1, the current count value is copied into the register REG_CNT1_LATCH and the load value 1 is transferred to counter 1. The count operation is not interrupted.	Single Latch-Retrigger CNT With the first signal change 0 → 1 at Z2, the current count value is copied into the register REG_CNT2_LATCH and the load value 2 is transferred to counter 2. The count operation is not interrupted.
0011	Continuous latch retrigger CNT With the first signal change 0 → 1 at Z1, the current count value is copied into the register REG_CNT1_LATCH and the load value 1 is transferred to counter 1. The count operation is not interrupted.	Continuous latch retrigger CNT With the first signal change 0 → 1 at Z2, the current count value is copied into the register REG_CNT2_LATCH and the load value 2 is transferred to counter 2. The count operation is not interrupted.

4 Functions of the count inputs (CNT1 and CNT2)

4.1 Basic functions of the count inputs CNTx

Table 11:
functions
Z1 and Z2

Bit 7 ... Bit 4 (Value)	mode Z1 (→ see byte 2 of the Parameter data of the module (page 25))	mode Z2 (→ see byte 5 of the Parameter data of the module (page 25))
0100	<p>Single L.-R. and HW gate CNT</p> <p>Single synchronization for CNT1 (Z1) and HW gate (Z2) for CNT1. The enabling of Z1 and Z2 is done via CNT1_SFKT_EA:</p> <ul style="list-style-type: none"> – with the first signal change 0 → 1 at Z1, the current count value is copied into the register REG_CNT1_LATCH and the load value of CNT1 is transferred to counter 1. The count operation is not interrupted. – with Z2 = 0, CNT1 is disabled – with Z2 = 1, CNT1 is enabled 	<p>Single synchronization for CNT2 (Z2) and HW gate (Z1) for CNT2. The enabling of Z1 and Z2 is done via CNT2_SFKT_EA:</p> <ul style="list-style-type: none"> – with the first signal change 0 → 1 at Z2, the current count value is copied into the register REG_CNT2_LATCH and the load value of CNT2 is transferred to counter 2. The count operation is not interrupted. – with Z1 = 0, CNT2 is disabled – with Z1 = 1, CNT2 is enabled
0101	<p>Continuous L.-R. and HW gate CNT</p> <p>Continuous synchronization for CNT1 (Z1) and HW gate (Z2) for CNT1. The enabling of Z1 and Z2 is done via CNT1_SFKT_EA:</p> <ul style="list-style-type: none"> – with the first signal change 0 → 1 at Z1, the current count value is copied into the register REG_CNT1_LATCH and the load value of CNT1 is transferred to counter 1. The count operation is not interrupted. – with Z2 = 0, CNT1 is disabled – with Z2 = 1, CNT1 is enabled 	<p>Continuous synchronization for CNT2 (Z2) and HW gate (Z1) for CNT2. The enabling of Z1 and Z2 is done via CNT2_SFKT_EA:</p> <ul style="list-style-type: none"> – with the first signal change 0 → 1 at Z2, the current count value is copied into the register REG_CNT2_LATCH and the load value of CNT2 is transferred to counter 2. The count operation is not interrupted. – with Z1 = 0, CNT2 is disabled – with Z1 = 1, CNT2 is enabled
0110	reserved	
0111 to 1001	Functions of Zx for PWM1 and PWM2, → see Special function of inputs Z1 and Z2 for the PWM (page 70)).	
1010 to 1110	reserved	
1111	<p>Z just input</p> <p>Simple digital input, the status is reported via the check-back interface.</p>	

4 Functions of the count inputs (CNT1 and CNT2)

4.1 Basic functions of the count inputs CNTx

Special function Zx (CNT): alarm

If Zx is parameterized as alarm signal for the counter (Parameter data of the module (page 25)), then the signal status is reported as message.

→ Enable/disable the special function (→ see page 45)

After an alarm signal occurred, bit MSG_CNTx_SFKT page 28 in the Process input / check-back interface is set.



Note

When using alarm-signals as Open Collector, a pull up resistance can be switched via the Parameter data of the module (page 25).

Special function Zx (CNT): HW gate

→ Enable/disable the special function (→ see page 45)

If Zx is parameterized as HW gate for the counter (Parameter data of the module (page 25)), the counter gate is enabled with Zx = 1, and disabled with Zx = 0.



Note

Enabling the counter can be done either via the hardware **or** the software gate. Please read Enabling the counter (page 37).

4 Functions of the count inputs (CNT1 and CNT2)

4.1 Basic functions of the count inputs CNTx

After opening the HW gate, bit MSG_CNTx_SFKT page 28 in the Process input / check-back interface is set. Opening and closing the counter gate via HW or SW only influences the counter enable. Count values are not influenced.

Figure 11:
Count function,
Zx as HW gate

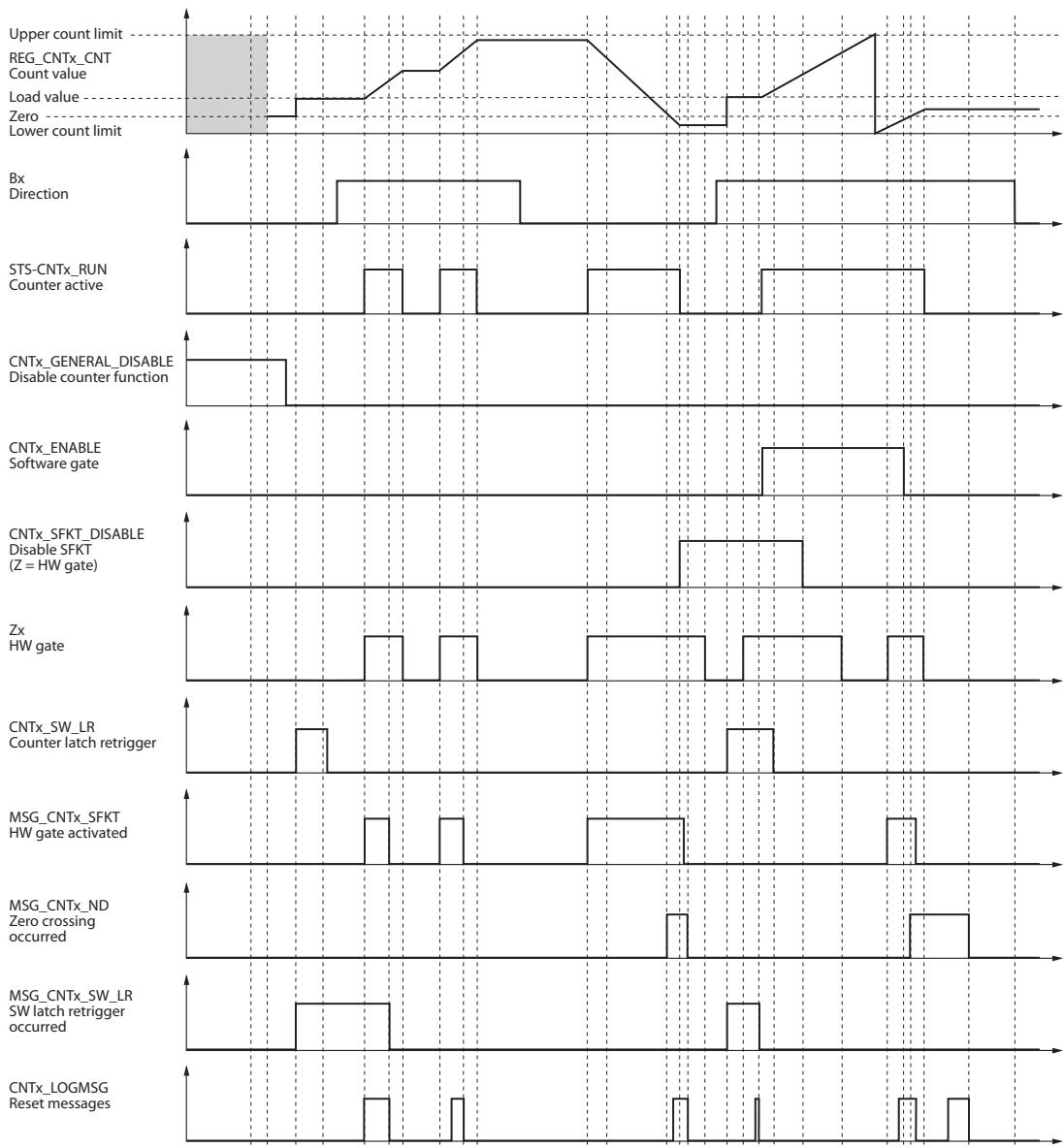

Rule:
 $STS_CNTx_RUN = \neg CNTx_GENERAL_DISABLE \& ((\neg CNTx_SFKT_DISABLE) \& Zx) \vee (CNTx_ENABLE)$

4 Functions of the count inputs (CNT1 and CNT2)

4.1 Basic functions of the count inputs CNTx

Special function Zx (CNT): Synchronization (HW latch retrigger)

→ Enable/disable the special function (→ see page 45)

If the synchronization of the counter value is parameterized for Zx (Parameter data of the module (page 25)), Zx is used as **hardware (HW) latch retrigger** .

With a signal change 0 → 1 at input Zx,

- 1** the current count value is stored to REG_CNTx_LATCH page 94,
- 2** the load value is transferred as count value from REG_CNTx_LOADVAL page 93 to REG_CNTx_CNT page 93

and

- 3** the count operation is continued

After an latch retrigger occurred, the bit MSG_CNT1_SFKT (page 28) or resp. MSG_CNT2_SFKT (page 28) in the check-back interface is set. It can then be reset via bit CNTx_LOGMSG page 32 in the control interface with 0 → 1 → 0.

- Single synchronization:
If in the Process output / control interface (page 32) the single synchronization is parameterized with CNTx_SINGLE = 1 (CNT1: byte 0, bit 6 / CNT2: byte 1, bit 6), a latch retrigger is executed only with the **first** signal change 0 → 1 at Zx after enabling the counter with CNTx_SFKT_DISABLE = 0.
- Periodical synchronization:
If in the Process output / control interface (page 32) the single synchronization is parameterized with CNTx_SINGLE = 0 (CNT1: byte 0, bit 6 / CNT2: byte 1, bit 6), a latch retrigger is executed only with the **first** signal change 0 → 1 at Zx after enabling the counter with CNTx_SFKT_DISABLE = 0.

When executing a HW latch retrigger, the following applies:

```
(REG_CNTx_LATCH) = (REG_CNTx_CNT)
and
(REG_CNTx_CNT) = (REG_CNTx_LOADVAL)
and
MSG_CNTx_SFKT = 1
if
CNTx_GENERAL_DISABLE = 0
and
CNTx_SFKT_DISABLE = 0
and
Zx 0 → 1
```

4 Functions of the count inputs (CNT1 and CNT2)

4.1 Basic functions of the count inputs CNTx



Note

A software latch retrigger is possible as well (→ see also Software (SW) latch retrigger (page 38)). Please use byte 0 (CNT1) or byte 1 (CNT2, bit 5 CNTx_SW_LR Process output / control interface (page 32)).

When executing a SW latch retrigger, the following applies:

(REG_CNTx_LATCH) = (REG_CNTx_CNT)

and

(REG_CNTx_CNT) = (REG_CNTx_LOADVAL)

and

MSG_CNTx_SW_LR = 1

if

CNTx_GENERAL_DISABLE = 0

and

CNTx_SW_LR 0 → 1

4 Functions of the count inputs (CNT1 and CNT2)

4.1 Basic functions of the count inputs CNTx

Figure 12:
Synchronization

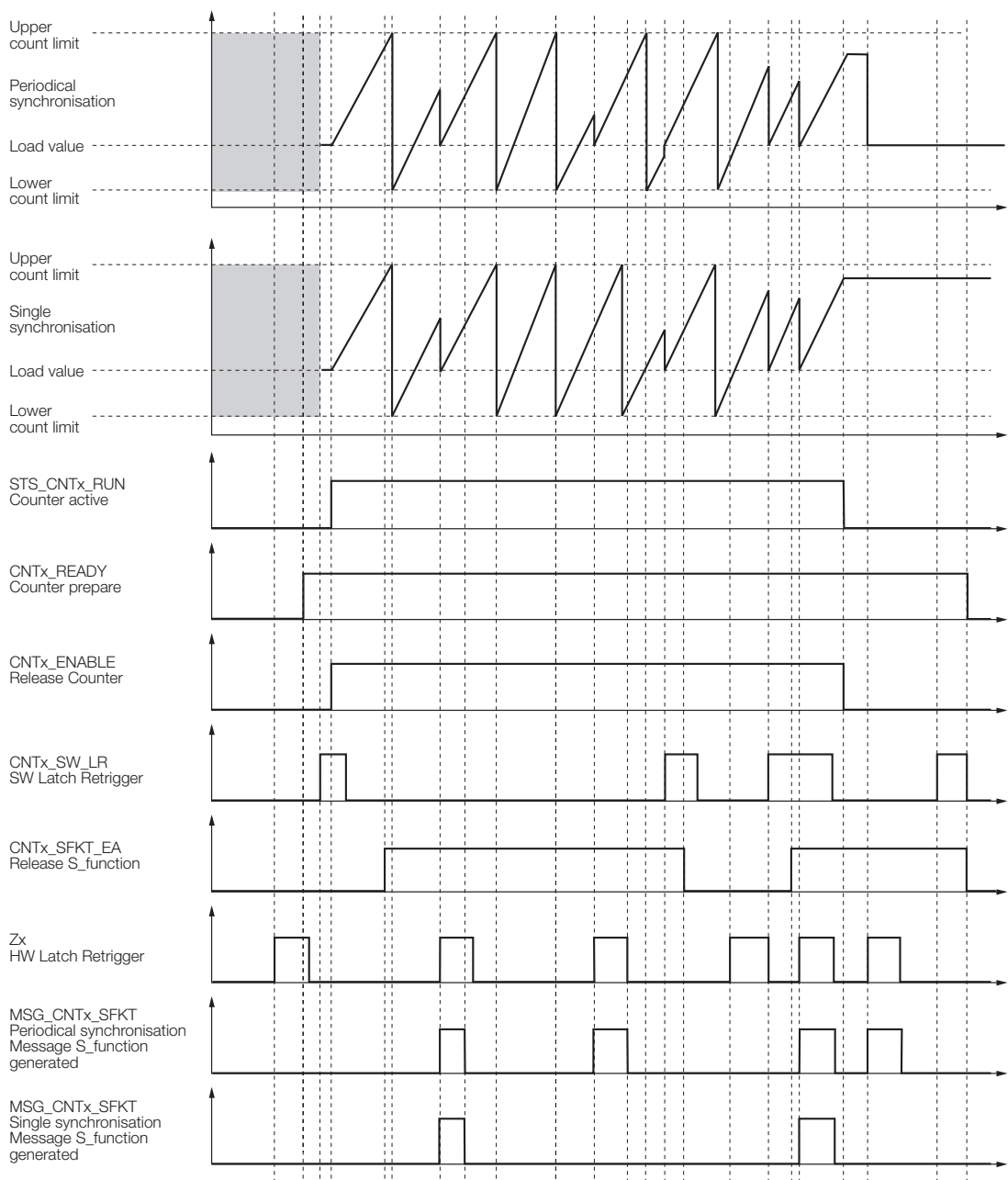

4 Functions of the count inputs (CNT1 and CNT2)

4.2 Additional functions of the count inputs

4.2 Additional functions of the count inputs

4.2.1 Additional function: Measurement mode

In addition to the counter function, the counters are capable of carrying out measurements (Frequency measurement (page 53) or Period duration measurement (page 55)) simultaneously.

The following registers are used to support this function (→ see also Register interface (page 91)).

	Register name	Register no.	Default value	Access
Counter 1	REG_CNT1_MV Measurement value	33 (0x21)		RO
	REG_CNT1_INTIME Integration time CNTx 10 ms/bit (max. 17800 x 10 ms)	41 (0x29)	10 0x00 00 00 0A (100 ms)	RW
	REG_CNT1_MUL Multiplier CNTx	42 (0x2A)	1 0x00 00 00 01	RW
	REG_CNT1_DIV Divisor CNTx	43 (0x2B)	1 0x00 00 00 01	RW
	REG_CNT1_IPI Counted pulses per integration time	44 (0x2C)	0 0x00 00 00 00	RO
	REG_CNT1_TO Time-out CNTx, 10 ms/bit	35 (0x2D)	0 0x00 00 00 00	RW
Counter 2	REG_CNT2_MV Measurement value	65 (0x41)		RO
	REG_CNT2_INTIME Integration time CNTx 10 ms/bit (max. 17800 x 10 ms)	73 (0x49)	10 0x00 00 00 0A (100 ms)	RW
	REG_CNT2_MUL Multiplier CNTx	74 (0x4A)	1 0x00 00 00 01	RW
	REG_CNT2_DIV Divisor CNTx	75 (0x4B)	1 0x00 00 00 01	RW
	REG_CNT2_IPI Counted pulses per integration time	76 (0x4C)	0 0x00 00 00 00	RO
	REG_CNT2_TO Time-out CNTx, 10 ms/bit	77 (0x4D)	0 0x00 00 00 00	RW

4 Functions of the count inputs (CNT1 and CNT2)

4.2 Additional functions of the count inputs

Frequency measurement

In frequency measurement mode, the number of count pulses (content of REG_CNT1_IPI (page 93)) within an integration time, which has to be defined (REG_CNT1_INTTIME (page 93)), are measured. This integration time is parameterizable in steps of 10 ms/bit. An integration time of max. 178 s is possible (a min. of 100 ms is reasonable).

→ After the integration time has expired, the result is calculated and entered into the register interface.



Note

Changes in the count direction within the integration time cause errors in the frequency measurement.

Activation of the frequency measurement

The frequency measurement is activated, if:

CNTx_FQPD = 0

(→ see Parameter data of the module, byte 0, bit2, page 25).

The frequency measurement is done in the following basic measurement modes:

- Calculation of the frequency in **mHz**:

Input registers	Value
REG_CNT1_MUL	1
REG_CNT1_DIV	1
REG_CNT1_INTTIME	Integration time: Multiple of 10 ms
Output registers	
REG_CNT1_MV	Frequency in mHz

- Calculation of the frequency in **Hz**:

Input registers	Value
REG_CNT1_MUL	1
REG_CNT1_DIV	1000
REG_CNT1_INTTIME	Integration time: Multiple of 10 ms
Output registers	
REG_CNT1_MV	Frequency in Hz



Note

The accuracy of the measurement increases with the length of the integration time. It should be noted that the measured value (REG_CNTx_MV) is only updated after the integration time has expired.

4 Functions of the count inputs (CNT1 and CNT2)

4.2 Additional functions of the count inputs

Restrictions

The following settings are **not** allowed:

REG_CNTx_MUL = 0

REG_CNTx_DIV = 0

REG_CNTx_INTTIME = 0

Checking the counter function

In order to check the counter function, a message MSG_CNTx_FQE = 1 can be generated (→ see page 30),

- **if**,
for a defined Time-out-time in REG_CNTx_TO,
the content of the register for the measured value REG_CNTx_MV = 0,
- **or if**
the measured value in REG_CNTx_MV is > 0xFF FF FF FF.

If the time-out-time in REG_CNTx_TO = 00 00 00 00 (default-setting), then the message via MSG_CNTx_FQE is switched off.



Note

If

REG_CNTx_DIV = 0,

or REG_CNTx_INTTIME = 0

or REG_CNTx_INTTIME > 17800,

then the value is transferred and an error bit is set in REG_CONFIG_ERRSTS (CNTx) (page 81).

The calculation of the measurement value will then be stopped and REG_CNTx_MV will be set to "0".

4 Functions of the count inputs (CNT1 and CNT2)

4.2 Additional functions of the count inputs

Period duration measurement

It might be suitable to choose the period duration measurement for signal changes with lower frequencies.

Enabling the period duration measurement

The period duration measurement is activated, if:

CNT_x_FQPD = 1

(→ see Parameter data of the module, byte 0, bit2, page 25).

The period duration measurement is done in the following basic measurement modes:

- Calculation of the period duration measurement in **µs**:

Input registers	Value
REG_CNT1_MUL	1
REG_CNT1_DIV	1
Output registers	
REG_CNT1_MV	period duration measurement in µs

- Calculation of the period duration measurement in **ms**:

Input registers	Value
REG_CNT1_MUL	1
REG_CNT1_DIV	1000
Output registers	
REG_CNT1_MV	period duration measurement in ms



Note

The accuracy of the measurement increases with the length of the integration time. It should be noted, that the measured value (REG_CNT_x_MV) is only updated after the integration time has expired.

Restrictions

The following settings are **not** allowed:

REG_CNT_x_MUL = 0

REG_CNT_x_DIV = 0

REG_CNT_x_INTTIME = 0

4 Functions of the count inputs (CNT1 and CNT2)

4.2 Additional functions of the count inputs

Checking the counter function

In order to check the counter function, a message $MSG_CNTx_FQE = 1$ can be generated (→ see page 30),

- **if**,
after a defined time-out-time in REG_CNTx_TO ,
the period duration measurement has not been finished, yet,
- or **if**
the measured value in REG_CNTx_MV is $> 0xFF\ FF\ FF\ FF$.

If the time-out-time in $REG_CNTx_TO = 00\ 00\ 00\ 00$ (default-setting), then the message generation in MSG_CNTx_FQE is switched off.



Note

If $REG_CNTx_DIV = 0$,

then the value is transferred and an error bit is set.

The calculation of measurement values is stopped and REG_CNTx_MV is set to "0".

4 Functions of the count inputs (CNT1 and CNT2)

4.2 Additional functions of the count inputs

Revolutions speed measurement

The revolutions measurement is not executed directly.

In the operation mode "frequency measurement" (→ see parameter measurement mode CNT1), the no. of revolutions (n) in 1/min can be calculated on the basis of the frequency (f).

REG_CNTx_MUL is used to change the time base (for example from s to min) and REG_CNTx_DIV is used to specify the encoder pulses per revolution.

- Revolutions speed in **1/min**:

Input registers	Value
REG_CNT1_MUL	60
REG_CNT1_DIV	Pulses per encoder revolution ×1000
REG_CNT1_INTTIME	Integration time: Multiple of 10 ms
Output registers	
REG_CNT1_MV	Revolutions speed in 1/min :

- Revolutions speed in **1 / 1000 min**:

Input registers	Value
REG_CNT1_MUL	60
REG_CNT1_DIV	Pulses per revolution of the encoder
REG_CNT1_INTTIME	Integration time: Multiple of 10 ms
Output registers	
REG_CNT1_MV	Revolutions speed in 1 / 1000 min :

- Revolutions speed in **1/s**:

Input registers	Value
REG_CNT1_MUL	1
REG_CNT1_DIV	Pulses per encoder revolution ×1000
REG_CNT1_INTTIME	Integration time: Multiple of 10 ms
Output registers	
REG_CNT1_MV	Revolutions speed in 1/s



Note

The accuracy of the measurement increases with the length of the integration time. It should be noted, that the measured value (REG_CNTx_MV) is only updated after the integration time has expired.

4 Functions of the count inputs (CNT1 and CNT2)

4.2 Additional functions of the count inputs

Downtime monitoring

In revolutions speed measurement, downtime-monitoring can be realized by means of a time-out time.

This time is defined as a multiple of 10 ms in REG_CNTx_TO (page 93).

If, during this time-out-time

REG_CNTx_MV = 0, which means no pulse was detected,

then

MSG_CNTx_FQE = 1 = downtime!

5 Functions of the PWM outputs (PWM1 and PWM2)

5.1 Functions of the PWM outputs (PWM1 and PWM2)

The outputs P1/D1 and P2/D2 provide the two PWM channels. The outputs Px are used for frequency output. The logic status of the outputs Dx can define the direction.

The outputs Px serve to give out a square wave signal with a defined mark-to-space ratio, a defined period duration and a defined number of pulses. Depending on the operation mode, the content of certain registers is used to define the nature of the output signal.

In order to support the PWM function, each channel provides an output Dx, which, for example, can be used as direction signal (→ see Description of the function outputs D1 and D2 (page 75)).

Additionally, further functions are provided with input Z1 for PWM1 and input Z2 for PWM2 (→ see Special function of inputs Z1 and Z2 for the PWM (page 70)).

5.1.1 Module restart with saved values

In case of a power reset, the volatile contents of the PWM-registers (see below) are automatically loaded with the "start values after reset" from the reset-value-registers..

Table 12: Reset-value registers for a restart	REG_PWMx_PD	REG_PWMx_PD_RV
	REG_PWMx_DC	REG_PWMx_DC_RV
	REG_PWMx_DHIGH	REG_PWMx_DHIGH_RV
	REG_PWMx_DLOW	REG_PWMx_DLOW_RV

5 Functions of the PWM outputs (PWM1 and PWM2)

5.1 Functions of the PWM outputs (PWM1 and PWM2)

5.1.2 Operation modes of the PWM outputs Px

The outputs P1 and P2 work as pulse-width modulated outputs.

A square signal with a defined form and of a number of pulses can be given out at these PWM outputs. The function of the output can be chosen as follows via the parameter "mode Px" (→ see Parameter data of the module (page 25))

Table 13: Mode PWMx	Bit 3 ... Bit 0 (Value)	Mode PWM1 (→ see byte 7 of the Parameter data of the module (page 25))	Mode PWM 2 (→ see byte 9 of the Parameter data of the module (page 25))
	0000 A	PD DC Definition (Period Duration / Duty Cycle Definition) (→ see page 61)	
	0001	HT LT Definition (High Time / Low Time Definition) (→ see page 63)	
	0010 to 1110	not defined	
	1111	P just output simple digital output, controlled via the Process output / control interface (page 32)	



Note

The parameterization of undefined functions is reported through a diagnostic message with PWMx_PAR_ERR = 1 (→ see Diagnostic data of the module (page 24)). If PWMx_PAR_ERR = 1, then the PWM can not be activated.

Additionally to the diagnostic message, an error message is reported in the REG_CONFIG_ERRSTS (PWMx) (page 83) when a parameter error was detected.

5 Functions of the PWM outputs (PWM1 and PWM2)

5.1 Functions of the PWM outputs (PWM1 and PWM2)

Period Duration / Duty Cycle Definition

This operation mode allows:

- Pulse width modulation, → see page 62
- Frequency modulation, → see page 62

Registers to be written:

Register name	Register no.	Default value	Description
PWM1			
REG_PWM1_PD period duration PWM1 in 41,667 ns/bit	96 (0x60)	Content of REG_PWM1_PD_RV	volatile, for changes during normal operation
REG_PWM1_PD_RV	104 (0x68)	0 × 00 00 5D C0 (= 1000 Hz)	non-volatile, for defined values during start/reset
REG_PWM1_DC mark-to-space ratio PWM1	97 (0x61)	Content of REG_PWM1_DC_RV	volatile, for changes during normal operation
REG_PWM1_DC_RV	105 (0x69)	0x7F FF FF FF (= 50 %)	non-volatile, for defined values during start/reset
REG_PWM1_CNTSV Load value of the pulses to be given out	100 (0x 64)	0 × 00 00 27 10 (1000 pulses)	non-volatile
PWM2			
REG_PWM2_PD Period duration PWM2 in 41,667 ns/bit	112 (0x70)	Content of REG_PWM2_PD_RV	volatile, for changes during normal operation
REG_PWM2_PD_RV	120 (0x78)	0 × 00 00 5D C0 (= 1000 Hz)	non-volatile, for defined values during start/reset
REG_PWM2_DC mark-to-space ratio PWM2	113 (0x71)	Content of REG_PWM2_DC_RV	volatile, for changes during normal operation
REG_PWM2_DC_RV	121 (0x79)	0x7F FF FF FF (= 50 %)	non-volatile, for defined values during start/reset
REG_PWM2_CNTSV Load value of the pulses to be given out	116 (0x 74)	0 × 00 00 27 10 (1000 pulses)	non-volatile

5 Functions of the PWM outputs (PWM1 and PWM2)

5.1 Functions of the PWM outputs (PWM1 and PWM2)

1 Pulse width modulation (PWM):

Dynamic changing of the pulse width with a constant period duration.

- Period duration (constant):
REG_PWMx_PD (in 41,6667 ns/bit)
- Pulse width (dynamic):
REG_PWMx_DC
The pulse width is the ratio of pulse duration and period duration.
pulse width:
100 % = 0 x FF FF FF FE, corresponds to static ON
50 % = 0 x 7F FF FF FF
0 % = 0 x 00 00 00 00, corresponds to static OFF.

Figure 13:
pulse width
modulation

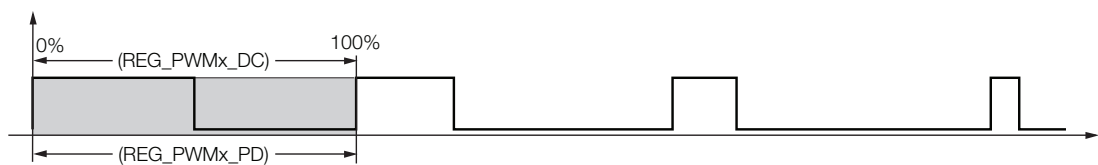

2 Frequency modulation (FM):

Changing the frequency for the pulse output by means of a dynamic change of the period duration at a constant mark-to-space-ratio.

- Period duration (dynamic):
REG_PWMx_PD (in 41,6667 ns/bit)
By means of this, the pulse output can be set within the range from 0,005588 Hz to 20 000 Hz.
- Pulse width (constant):
REG_PWMx_DC
The pulse width is the ratio of pulse duration and period duration.

Figure 14:
Frequency
modulation

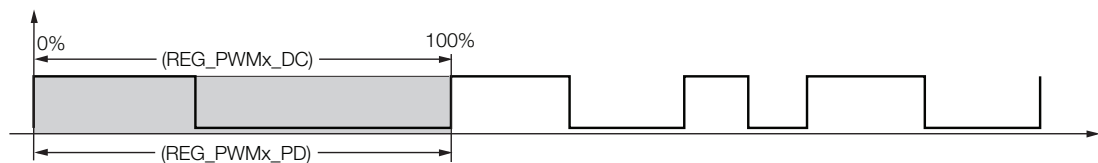

5 Functions of the PWM outputs (PWM1 and PWM2)

5.1 Functions of the PWM outputs (PWM1 and PWM2)

Application example

Frequency modulation:

Necessary settings:

parameterization: Operation mode: PD DC Definition

process data: PWMx_SINGLE =1

To give out a signal with 100 Hz and a duty cycle of 50 % for 25000 signal sequences, the following settings have to be done:

Table 14: Reset-value- registers for a restart	REG_PWMx_DC	0 x 7F FF FF FF (Duty Cycle 50 %)
	REG_PWMx_PD in steps of 41,667 ns	0 x 00 03 A9 80 (240000) Calculation: 100 Hz \triangleq period duration = 0,01 s 0,01 s / 41,667 ns \triangleq (10 x 10 ⁻³) s / (41,667 x 10 ⁻⁹) s = 240000
	REG_PWMx_CNTSV	0 x 00 00 61 A8 (25000 signals)



Note

In case of an incorrect setting of the period duration and/or the pulse width, the change of the register content is transferred and an error message is set in the REG_CONFIG_ERRSTS (PWMx) (page 83).

High Time / Low Time Definition

In the operation mode "High Time / Low Time Definition", the mark-to-space-ratio of the signal to be given out can exactly be defined through the direct presetting of pulse and space duration.

The content of register REG_PWMx_DHIGH corresponds to the pulse duration, the content of register REG_PWMx_DLOW corresponds to the space duration. Both are set in 41,667 ns/bit. These values can be written directly.



Note

The contents of the registers for pulse and space duration (REG_PWMx_DHIGH and REG_PWMx_DLOW) are monitored.

If a pulse or space duration of less than 25 μ s is set or if the sum of pulse and space duration (REG_PWMx_DHIGH + REG_PWMx_DLOW) results in a value > 0 x FF FF FE, then the change of the register content is transferred and an error message is set in the REG_CONFIG_ERRSTS (PWMx) (page 83).

5 Functions of the PWM outputs (PWM1 and PWM2)

5.1 Functions of the PWM outputs (PWM1 and PWM2)

Registers to be written:

Register name	Register no.	Default value	Description
PWM1			
REG_PWM1_DHIG Pulse duration PWM1 in 41,667 ns/bit	98 (0 × 62)	Content of REG_PWM1_DHIG_RV	volatile, for changes during normal operation
REG_PWM1_DHIG_RV	106 (0 × 6A)	0 x 00 00 2E E0 (= 500 ?s)	non-volatile, for defined values during start/reset
REG_PWM1_CNTSV Load value of the pulses to be given out	100 (0 × 64)	0 x 00 00 27 10 (1000 pulses)	non-volatile
REG_PWM1_DLOW Space duration PWM1 in 41,667 ns/bit	115 (0 × 73)	Content of REG_PWM1_DLOW_RV	volatile, for changes during normal operation
REG_PWM1_DLOW_RV	107 (0 × 6B)	0 x 00 00 2E E0 (= 500 ?s)	non-volatile, for defined values during start/reset
PWM2			
REG_PWM2_CNTSV Load value of the pulses to be given out	116 (0 × 74)	0 x 00 00 27 10 (1000 pulses)	non-volatile
REG_PWM2_DHIG Pulse duration PWM2 in 41,667 ns/bit	98 (0 × 62)	Content of REG_PWM2_DHIG_RV	volatile, for changes during normal operation
REG_PWM2_DHIG_RV	106 (0 × 6A)	0 x 00 00 2E E0 (= 500 ?s)	non-volatile, for defined values during start/reset
REG_PWM2_DLOW Period duration PWM2 in 41,667 ns/bit	115 (0 × 73)	Content of REG_PWM2_DLOW_RV	volatile, for changes during normal operation
REG_PWM2_DLOW_RV	107 (0 × 6B)	0 x 00 00 2E E0 (= 500 ?s)	non-volatile, for defined values during start/reset

5 Functions of the PWM outputs (PWM1 and PWM2)

5.1 Functions of the PWM outputs (PWM1 and PWM2)

5.1.3 Continuous signal output

Process output / control interface (page 32): **PWMx_SINGLE = 0**

The signal output is continuous. The signal form is changeable during the signal output by changing the corresponding register entries.

The signal output can be started or stopped using the SW gate (**or**, if parameterized, using the HW gate, → see also Enabling the pulse output (page 68)). The value of the 32 bit counters is preserved.

If PWMx_GENERAL_DISABLE is set to "1", the PWM functions are disabled. The register contents are preserved.

Setting PWMx_GENERAL_DISABLE to "0" generally re-enables the PWM. It continues to work with existing register contents.

Existing messages (MSG) should be reset when setting the PWM (→ see Chapter 8, Error handling in the control interface / check-back interface (page 85)).

5 Functions of the PWM outputs (PWM1 and PWM2)

5.1 Functions of the PWM outputs (PWM1 and PWM2)

Procedure of the continuous signal output:

- 1** Set register contents to define the signal form:
 - 1.1** REG_PWMx_CNTSV Number of pulses to be given out
 - 1.2** REG_PWMx_DC,
REG_PWMx_PD
or
 - 1.3** REG_PWMx_DLOW,
REG_PWMx_DHIGH Operation mode: High Time / Low Time Definition (page 63)
- 2** PWMx_SW_LR 0 → 1 The latch retrigger causes that the start value is copied from REG_PWMx_CNTSV into REG_PWMx_CNTDC.
- 3** REG_PWMx_CNTSV
→ REG_PWMx_CNTDC
- 4** PWMx_ENABLE 0 → 1 Setting the enable-bit, the signal output begins
- 5** REG_PWMx_CNTDC The count value in the register is decremented with every signal change 1 → 0 of the output signal
REG_PWMx_CNTDC = 0.
- 6** REG_PWMx_CNTDC = 0. Number of pulses to be given out
REG_PWMx_CNTDC = 0
- 7** MSG_PWMx_NDDC = 1 Message "zero crossing occurred" (→ see Process input / check-back interface (page 28)).
- 8** PWMx_LOGMSG 1 → 0 The message has to be reset!
To do so, PWMx_LOGMSG is first set from 0 → 1 and then from 1 → 0 (→ see Process output / control interface (page 32)) or Storage of messages (MSG) (page 87)).
- 9** REG_PWMx_LATCH =
REG_PWMx_CNTDC
→ REG_PWMx_LATCH = 0 Number of pulses to be given out = 0.
The value is now copied to the latch register, this register is = 0, too.
A "0" in the latch register causes an automatic latch retrigger, → see also Special function Zx (PWM): Hardware latch retrigger (page 73).
- 10** REG_PWMx_CNTDC =
REG_PWMx_CNTSV The start value from REG_PWMx_CNTSV is reloaded into the register of pulses to be given out.
→ The signal output is continued with the start value.

5 Functions of the PWM outputs (PWM1 and PWM2)

5.1 Functions of the PWM outputs (PWM1 and PWM2)

5.1.4 Periodical signal output

Process output / control interface (page 32): **PWMx_SINGLE = 1**

The signal output is defined as single. The signal form is changeable during the signal output by changing the corresponding register entries.

The signal output can be started or stopped using the SW gate (or, if parameterized, using the HW gate). The value of the 32 bit counters is preserved.

If PWMx_GENERAL_DISABLE is set to "1", the PWM functions are disabled. The register contents are preserved.

Setting PWMx_GENERAL_DISABLE to "0" generally re-enables the PWM. It continues to work with existing register contents.

Existing messages (MSG) should be reset when setting the PWM (→ see Chapter 6, Description of the function outputs D1 and D2 (page 75)).

Procedure of the periodical signal output:

- 1** Set register contents to define the signal form:
 - 1.1** REG_PWMx_CNTSV Number of pulses to be given out
 - 1.2** REG_PWMx_DC,
REG_PWMx_PD
or
1.3 REG_PWMx_DLOW,
REG_PWMx_DHIGH for operation mode: High Time / Low Time Definition (page 63)
- 2** PWMx_SW_LR 0 → 1 The latch retrigger causes that the start value is copied from REG_PWMx_CNTSV into REG_PWMx_CNTDC.
- 3** REG_PWMx_CNTSV
→ REG_PWMx_CNTDC
- 4** PWMx_ENABLE 0 → 1 Setting the enable-bit, the signal output begins STS_PWMx_RUN = 1
- 5** REG_PWMx_CNTDC The count value in the register is decremented with every signal change 1 → 0 of the output signal until REG_PWMx_CNTDC = 0.
- 6** REG_PWMx_CNTDC = 0. Number of pulses to be given out REG_PWMx_CNTDC = 0.
- 7** MSG_PWMx_NDDC = 1 Message "zero crossing occurred" (→ see Process input / check-back interface (page 28)).
- 8** PWMx_LOGMSG → 0 The message has to be reset!
To do so, PWMx_LOGMSG is first set from 0 → 1 and then from 1 → 0 (→ see Process output / control interface (page 32) or Storage of messages (MSG) (page 87)).
- 9** STS_PWMx_RUN = 0 The signal output is stopped, because REG_PWMx_CNTDC = 0.
- 10** PWMx_SW_LR 0 → 1 With another latch retrigger the procedure restarts and the signal output restarts, as long as PWMx_ENABLE = 1.

5 Functions of the PWM outputs (PWM1 and PWM2)

5.1 Functions of the PWM outputs (PWM1 and PWM2)

5.1.5 Enabling the pulse output

Prerequisite:

Enabling the PWM via hard- or software gate requires a general enabling of the function using `PWM1_GENERAL_DISABLE = 0` (default-setting).



Note

The counter can be enabled either per software **or** per hardware gate:

NOT `PWM1_GENERAL_DISABLE`

AND (SW-Tor **OR** HW-Tor)

Hardware gate (HW gate)

The pulse output is enabled with signal $Z_x = 1$ and disabled with $Z_x = 0$.

In order to use Z_x to enable the pulse output, the special function of the output has to be enabled as well (→ see Special function Z_x (PWM): HW gate (page 71)).

The following applies for the HW gate:

`STS_PWMx_RUN = 1`, if

`PWMx_GENERAL_DISABLE = 0` and

`PWMx_SFKT_DISABLE = 0` and

$Z_x = 1$

Software-gate (SW gate)

The enabling of the counter is done using a signal change $0 \rightarrow 1$ at bit `PWM1_ENABLE` (PWM1) or `PWM2_ENABLE` (PWM2) in the Process output / control interface (page 32).

The following always applies for the SW gate:

`STS_PWMx_RUN = 1`, if

`PWMx_GENERAL_DISABLE = 0` and

`PWMx_ENABLE = 1`

The signal output is done with an open SW gate `PWMx_GENERAL_DISABLE = 0` and `PWMx_ENABLE = 1` as long as `REG_PWMx_CNTDC ≠ 0`.

5 Functions of the PWM outputs (PWM1 and PWM2)

5.1 Functions of the PWM outputs (PWM1 and PWM2)

5.1.6 Latch retrigger (PWM)

The number of pulses to be given out is retriggered, the current value of the decrement register REG_PWMx_CNTDC is stored to the latch register ((REG_PWMx_LATCH) = (REG_PWMx_CNTDC)) and the load value from REG_PWMx_CNTSV is loaded again to the decrement register ((REG_PWMx_CNTDC) = (REG_PWMx_CNTSV)). The signal output is continued.

The pulse output has to be enabled (→ see Enabling the pulse output (page 68)) in order to execute this latch retrigger.

Hardware (HW) latch retrigger

The hardware latch retrigger is done via a signal change at Zx 0 → 1 (→ see Special function Zx (PWM): Hardware latch retrigger (page 73)).

Software (SW) latch retrigger

The software latch retrigger is done by setting the bits PWMx_SW_LR in the Process output / control interface (page 32). The executed SW latch retrigger is confirmed through bit MSG_PWMx_SW_LR of the Process input / check-back interface (page 28) (bit 0 in byte 4 (PWM1) and byte 5 (PWM2)).

5 Functions of the PWM outputs (PWM1 and PWM2)

5.1 Functions of the PWM outputs (PWM1 and PWM2)

5.1.7 Special function of inputs Z1 and Z2 for the PWM

The inputs Z1 and Z2 can be used to support the PWM functions (or the counter functions, → see Chapter 4).



Note

Each special function of Zx is **enabled** per default via `PWMx_SFKT_DISABLE = 0` in the Process output / control interface (page 32). The enabling of this function is acknowledged via `STS_PWMx_SFKT_EN = 1`.

The disabling of the special function is done via `PWMx_SFKT_DISABLE = 1`.

Possible functions of the PWM outputs (PWM1 and PWM2) at a signal change 0 → 1:

- alarm (→ see Special function Zx (PWM): alarm (page 71))
- HW gate (enabling the pulse output, → see Special function Zx (PWM): HW gate (page 71))
- Latch Retrigger, single or periodical with the load value, → see Special function Zx (PWM): Hardware latch retrigger (page 73))

Table 15:
functions
Z1 and Z2

Bit 7 ... Bit 4 (Value)	Mode Z1 (→ see byte 0 of the Parameter data of the module (page 25))	Mode Z1 (→ see byte 1 of the Parameter data of the module (page 25))
0000 to 0101	Functions for PWM1 and PWM2, → see Special function of inputs Z1 and Z2 at CNTx (page 45).	
0110	reserved	–
0111	Alarm input PWM A signal change 0 → 1 at Zx causes the setting of the MSG_PWMx_SFKT flag. This serves to also report short-time events.	
1000	HW gate PWM The enabling can also be done per software gate (→ see also Enabling the pulse output (page 68)) – with Zx = 0, the signal output is disabled – with Zx = 1, the signal output is enabled	
	Retrigger PWM	
1001	In single signal output, the counter of the pulses to be given out (REG_PWMx_CNTDC) is reloaded and the signal output is enabled.	
1010 to 1110	reserved	
1111	Z just input Simple digital input, the status is reported via the check-back interface.	

5 Functions of the PWM outputs (PWM1 and PWM2)

5.1 Functions of the PWM outputs (PWM1 and PWM2)

Special function Zx (PWM): alarm

If Zx is parameterized as an alarm-signal for the PWM (Parameter data of the module (page 25)), a message is generated when the signal is triggered.

→ Enable/disable the special function (→ see page 70)

After an alarm-signal occurred, bit MSG_PWMx_SFKT page 28 in the Process input / check-back interface is set.



Note

When using alarm-signals as Open Collector, a pull up resistance can be switched via the Parameter data of the module (page 25).

Special function Zx (PWM): HW gate

→ Enable/disable the special function (→ see page 70)

If Zx is parameterized as HW gate for the PWM (Parameter data of the module (page 25)), the signal output at the PWM output is

started with Zx = 1, and
stopped with Zx = 0.

The special function of Zx has to be enabled via PWMx_SFKT_DISABLE = 0 in the Process output / control interface. The enabling of this function is acknowledged via STS_PWMx_SFKT_EN = 1.

After opening the HW gate, bit MSG_PWMx_SFKT page 28 is set in the Process input / check-back interface and can only be reset after the HW gate is closed again.

Start/ Stop via HW gate



Note

In addition to starting and stopping the PWM output using Zx (HW gate), the output can be started or stopped using PWMx_ENABLE (SW gate) (see also Enabling the pulse output (page 68)).

Stopping the PWM output interrupts the signal output. The current signal status of the output is preserved during this interruption. After a restart of the output, the signal output is continued with the conditions that were active when the output was stopped.

Output signal

During the enabling via HW or SW gate, a PWM output signal is generated depending on the register contents of REG_PWMx_DC und REG_PWMx_PD.

In the continuous signal output, decrementing the counter (REG_PWMx_CNTDC) causes a latch retrigger at "0".

This means, the output counter (REG_PWMx_LATCH) = (REG_PWMx_CNTDC) and is set to (REG_PWMx_CNTDC) = (REG_PWMx_CNTSV). The signal output is not interrupted. MSG_PWMx_NDDC reports the zero crossing, which means the expiration of the counter.

5 Functions of the PWM outputs (PWM1 and PWM2)

5.1 Functions of the PWM outputs (PWM1 and PWM2)

The following applies for the HW gate:

STS_PWMx_RUN = 1, if
 PWMx_GENERAL_DISABLE = 0 and
 PWMx_SFKT_DISABLE = 0 and
 Zx = 1

Figure 15:
 Pulse output
 with HW and
 SW gate

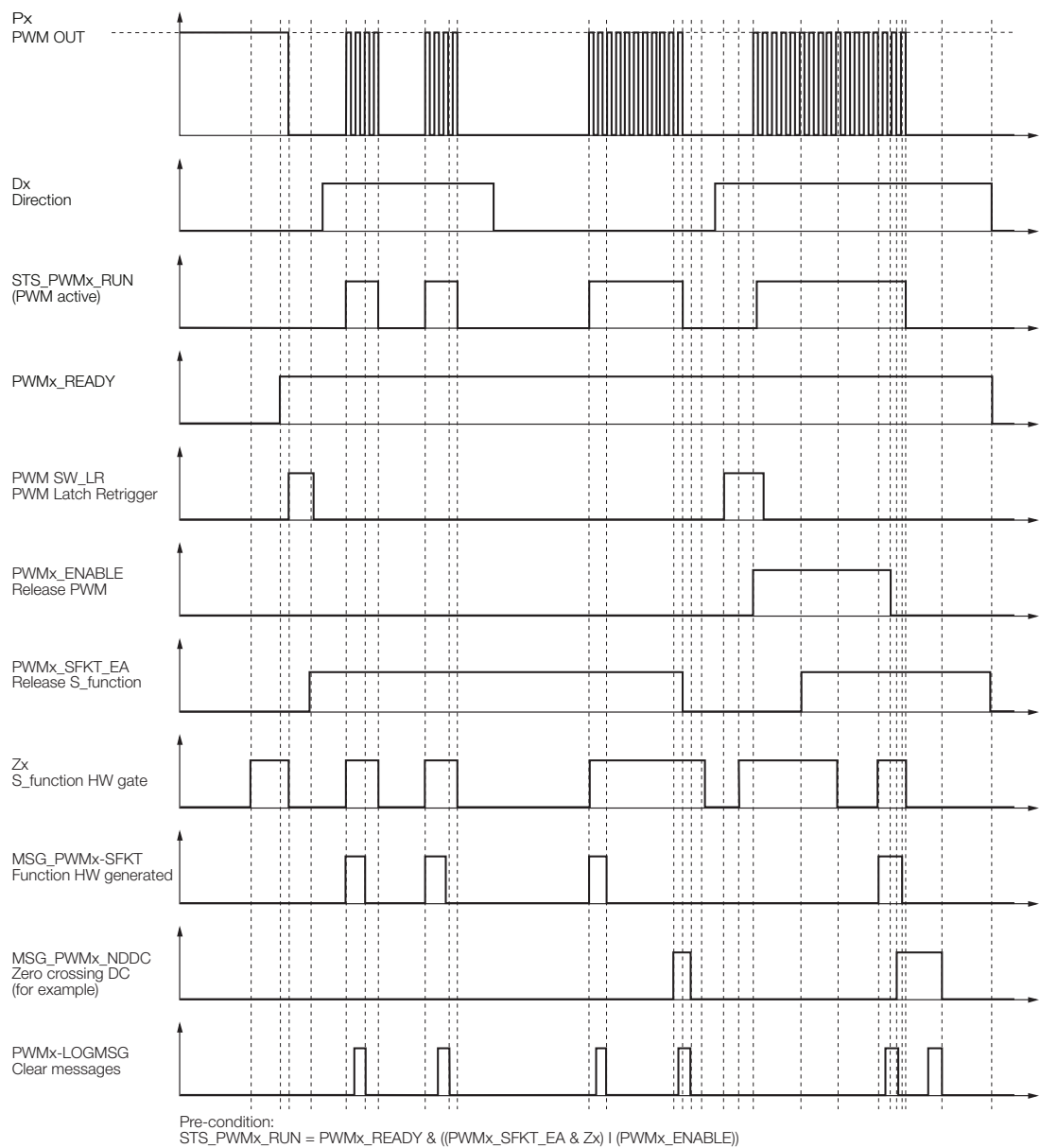

5 Functions of the PWM outputs (PWM1 and PWM2)

5.1 Functions of the PWM outputs (PWM1 and PWM2)

Special function Zx (PWM): Hardware latch retrigger

If Zx is parameterized as latch retrigger signal for the PWM output (Parameter data of the module (page 25)), Zx is used as hardware (HW) latch retrigger

→ Enable/disable the special function (→ see page 70)

With a signal change 0 → 1 at input Zx:

- 1 The content of register REG_PWMx_CNTDC is stored to REG_PWM_LATCH page 95,
- 2 and REG_PWMx_CNTDC is reloaded via REG_PWMx_CNTSV .
- 3 If the enabling is set via SW gate (PWMx_ENABLE), the signal output is started immediately.

After a latch retrigger event occurred, bit MSG_PWM1_SFKT (page 28)

MSG_PWM2_SFKT (page 28) in the check-back interface is set. It can be reset via bit PWMx_LOGMSG page 32 in the control interface with 0 → 1 → 0.

- Single signal output:
If the single signal output (PWMx_SINGLE = 1) is parameterized in the Process output / control interface (page 32), the function is only executed once with the **first** signal change 0 → 1 at Zx after enabling the output with PWMx_SFKT_DISABLE = 0.
- Periodical signal output:
If the periodical signal output (PWMx_SINGLE = 0) is parameterized in the Process output / control interface (page 32), the function is executed with the **every** signal change 0 → 1 at Zx after enabling the output with PWMx_SFKT_DISABLE = 0.

When executing a **HW** latch retrigger, the following applies:

(REG_PWMx_LATCH) = (REG_PWMx_CNTDC) and
(REG_PWMx_CNTDC) = (REG_PWMx_CNTSV) and
MSG_PWMx_SFKT = 1

if

PWMx_GENERAL_DISABLE = 0 and
PWMx_SFKT_DISABLE = 0 and
Zx 0 → 1



Note

A **software (SW) latch retrigger** is also possible (→ see also Latch Retrigger (CNT) (page 38)). Please use byte 2 (PWM1) or byte 3 (PWM2) bit 5 PWMx_SW_LR of the Process output / control interface (page 32).

When executing a SW latch retrigger, the following applies:

(REG_PWMx_LATCH) = (REG_CNTx_CNTDC) and
(REG_PWMx_CNTDC) = (REG_CNTx_CNTSV) and
MSG_PWMx_SW_LR = 1

if

PWMx_GENERAL_DISABLE = 0 and
PWMx_SW_LR 0 → 1

5 Functions of the PWM outputs (PWM1 and PWM2)

5.1 Functions of the PWM outputs (PWM1 and PWM2)

With every valid latch retrigger event, the register is always reloaded with the (REG_PWMx_CNTSV) and decremented with every pulse output until it becomes "0".

Figure 16:
Latch retrigger
at the PWM

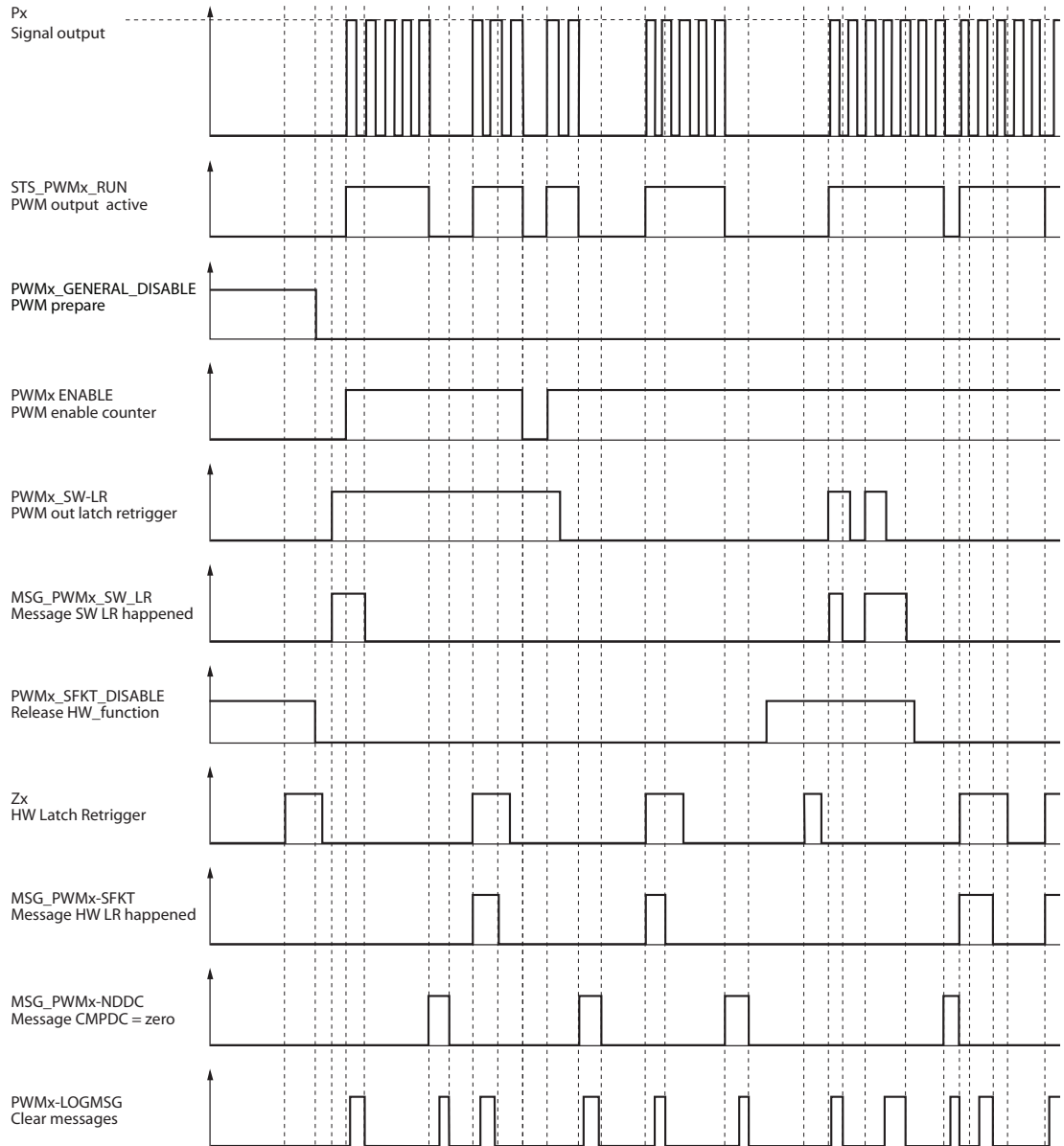

Rule:
Parameterization:
single release (PWMx_SINGLE = 1)
output of 5 pulses (PWMx_CNTSV = 5)

6 Description of the function outputs D1 and D2

6.1 General

The outputs D1 and D2 can be used multifunctionally. They support both, the function of CNTx as well as the function of PWMx.

Each output can generally be used as simple output (default-parameterization).

6.1.1 Direct access to Dx

The output status of D1 and D2 can be changed directly using the bits SET_ D1 and SET_ D2 in the Process output / control interface (page 32). For example, it can be used as direction signal for the PWM.

6.1.2 Parameterization of the function "mode Dx"2

By using the parameter "mode Dx" (→ see Parameter data of the module (page 25)), other functions can be defined for the outputs.

Simple functions of the outputs Dx

Table 16: Simple Functions Dx	Bit 5 ... Bit 0 (Value)	Mode Dx (→ see byte 6 (D1) and byte 8 (D2) of the Parameter data of the module)
A Default- setting	00 0000	D=STS_CNT_GENERAL_EN
	00 0001	D=STS_CNT_RUN
	00 0010	D=STS_CNT_SFKT_EN
	00 0011	reserved
	00 0100	D=STS_CNT_DIR
	00 0101	D=Z
	00 0110	D=B
	00 0111	D=A
	00 1000	D=MSG_CNT_CMPO
	00 1001	D=MSG_CNT_CMP1
	00 1010	D=MSG_CNT_UFLW
	00 1011	D=MSG_CNT_OFLW
	00 1100	D=MSG_CNT_ND
	00 1101	D=MSG_CNT_FQE
	00 1110	D=MSG_CNT_SFKT
	00 1111	D=MSG_CNT_SW_LR
	01 0000	D=MSG_PWM_SW_LR

6 Description of the function outputs D1 and D2

6.1 General

Table 16: Simple Functions Dx	Bit 5 ... Bit 0 (Value)	Mode Dx (→ see byte 6 (D1) and byte 8 (D2) of the Parameter data of the module)
	01 0001	D=MSG_PWM_NDDC
	01 0010	D=MSG_PWM_SFKT
	01 0011	reserved
A Default- setting	01 0100	D=STS_PWM_GENERAL_EN
	01 0101	D=STS_PWM_RUN
	01 0110	D= STS_PWM_SFKT_EN
	01 0111	reserved
	01 1000	D=1 at CNT=0
	01 1001	D=1 at $CMP0 \leq CNT \leq CMP1$ REG_CNT1_CMP 0 ≤ REG_CNT1_CNT ≤ REG_CNT1_CMP
	01 1010	D=1 at $UFLW \leq CNT \leq CMP0$ REG_CNTx_UFLW ≤ REG_CNTx_CNT ≤ REG_CNTx_CMP0
	01 1011	D=1 at $CMP1 \leq CNT \leq OFLW$ REG_CNT1_CMP1 ≤ REG_CNT1_CNT ≤ REG_CNT1_OFLW
	01 1100	reserved
	01 1101	
	01 1111	
	11 1111 A	D1 = simple output to be controlled via the process data

Special functions of the outputs Dx: Pulse output defined by time

The outputs can be used to give out a pulse in case of an occurring event defined via the parameter "mode Dx".

If the parameterized event occurs, Dx is switched on for a defined time (pulse duration).

The pulse duration can be set in the following registers in the Register interface (page 91) with a resolution of 10 ms/bit.

Register name	Register no.	Default value
REG_CNT1_DO1_IMP Pulse time for a pulse output at D1 in 10 ms/bit	48 (0x30)	10 = 100 ms (0x00 00 00 A0)
REG_CNT2_DO2_IMP Pulse time for a pulse output at D2 in 10 ms/bit	80 (0x50)	

Table 17:
Special func-
tions Dx,
Pulse output

Bit 5 ... Bit 0 (Value)	Mode Dx (→ see byte 6 (D1) and byte 8 (D2) of the Parameter data of the module (page 25))
10 0000	D=1 for Tx at MSG_CNT_CMP0 Dx 0 → 1 at MSG_CNTx_CMP0 0 → 1 Dx is switched on for defined pulse time if the count value is equal to the compare value 0 (MSG_CNTx_CMP0 (page 85)).
10 0001	D=1 for Tx at MSG_CNT_CMP1 Dx 0 → 1 at MSG_CNTx_CMP1 0 → 1 Dx is switched on for defined pulse time if the count value is equal to the compare value 1 (MSG_CNTx_CMP1 (page 85)).
10 0010	D=1 for Tx at MSG_CNT_UFLW Dx 0 → 1 at MSG_CNTx_UFLW 0 → 1 Dx is switched on for defined pulse time if an underflow of the count value has been detected (MSG_CNTx_UFLW (page 85)).
10 0011	D=1 for Tx at MSG_CNT_OFLW Dx 0 → 1 at MSG_CNTx_OFLW 0 → 1 Dx is switched on for defined pulse time if an overflow of the count value has been detected (MSG_CNTx_UFLW (page 85)).
10 0100	D=1 for Tx at MSG_CNT_ND Dx 0 → 1 at MSG_CNTx_ND 0 → 1 Dx is switched on for defined pulse time if a zero crossing of the count value has been detected (MSG_CNTx_ND (page 85)).
10 0101	D=1 for Tx at MSG_CNT_FQE Dx 0 → 1 at MSG_CNTx_FQE 0 → 1 Dx is switched on for defined pulse time if, within a defined time, no counter pulse has been received (MSG_CNTx_FQE (page 85)).

6 Description of the function outputs D1 and D2

6.1 General

Table 17:
Special func-
tions Dx,
Pulse output

Bit 5 ... Bit 0 (Value)	Mode Dx (→ see byte 6 (D1) and byte 8 (D2) of the Parameter data of the module (page 25))
10 0110	D=1 for Tx at MSG_CNT_SFKT Dx 0 → 1 at MSG_CNTx_SFKT 0 → 1 Dx is switched on for defined pulse time if an event according to the parameterized special function occurred (MSG_CNTx_SFT (page 85)).
10 0111	D=1 for Tx at MSG_CNT_ND Dx 0 → 1 at MSG_CNTx_SW_LR 0 → 1 Dx is switched on for defined pulse time if a software latch retrigger at CNTx was executed (MSG_CNTx_SW_LR (page 85)).
10 1000	D=1 for Tx at MSG_PWM_SW_LR Dx 0 → 1 at MSG_PWMx_SW_LR 0 → 1 Dx is switched on for defined pulse time if a software latch retrigger at PWMx was executed (MSG_PWMx_SW_LR (page 86)).
10 1001	D=1 for Tx at MSG_PWM_NDDC Dx 0 → 1 at MSG_PWMx_NDDC 0 → 1 Dx is switched on for defined pulse time if a zero crossing has been detected at the PWM (MSG_PWMx_NDDC (page 86)).
10 1010	D=1 for Tx at MSG_PWM_SFKT Dx 0 → 1 at MSG_PWMx_SFKT 0 → 1 Dx is switched on for defined pulse time if an event according to the parameterized special function occurred (MSG_PWMx_SFKT (page 86)).
10 1011	reserved
10 1100	D=1 for Tx at MSG_CNT_CMP0 OR 1 Dx 0 → 1 at MSG_CNTx_CMP0 0 → 1 or Dx 0 → 1 at MSG_CNTx_CMP1 0 → 1 Dx is switched on for a defined pulse time if the counter is equal to the compare value 0 or to the compare value 1 (MSG_CNTx_CMP0 or MSG_CNTx_CMP1 (page 85)).

Special functions of the outputs Dx: Pulse output defined by a hysteresis

The output Dx is switched on due to an event parameterized via the parameter "mode Dx" and only switched off again if this event value has been changed about the hysteresis value.

This avoids that the output is permanently switched on and off in case of a count value toggling around the parameterized switching event (example, → see page 80).

The hysteresis can be set as a number of pulses in the following registers within the register interface:

Register name	Register no.	Default value
REG_CNT1_DO1_HYS Hysteresis of the D1 for CNT1	47 (0x2F0)	10 = 10 pulses (0x00 00 00 0A)
REG_CNT2_DO1_HYS Hysteresis of the D2 for CNT2	79 (0x4F0)	

Table 18:
Special func-
tions Dx,
hysteresis

Bit 5 ... Bit 0 (Value)	Mode Dx (→ see byte 6 (D1) and byte 8 (D2) of the Parameter data of the module (page 25))
11 0000	D=1 at CNT < CMP0 Hys. Dx 0 → 1 at REG_CNTx_CNT < (REG_CNTx_CMP0 - REG_CNTx_DO1_HYS) output 0 → 1, if count value < (compare value 0 - hysteresis value) output 1 → 0, if count value ≥ compare value 0
11 0001	D=1 at CMP0 < CNT < CMP1 Hys. Dx 0 → 1 at REG_CNTx_CNT < (REG_CNTx_CMP1 - REG_CNT1_DO1_HYS) and REG_CNT1_CNT > (REG_CNT1_CMP0 + REG_CNT1_DO1_HYS) output 0 → 1, if count value < (compare value 1 - hysteresis value) and if count value > (compare value 0 + hysteresis value). output 1 → 0, if count value ≤ compare value 1 or ≥ compare value 0
11 0010	D=1 at CNT > CMP1 Hys. Dx 0 → 1 at REG_CNTx_CNT > (REG_CNTx_CMP1 + REG_CNTx_DO1_HYS) output 0 → 1, if count value > (compare value 1 + hysteresis value). output 1 → 0, if count value ≤ compare value 1
11 0011	D=1 at CNT > CMP1 OR < CMP0 Hys. Dx 0 → REG_CNT1_CNT < (REG_CNT1_CMP0 - REG_CNT1_DO1_HYS) or REG_CNT1_CNT > (REG_CNT1_CMP1 + REG_CNT1_DO1_HYS) output 0 → 1, if count value < (compare value 0 - hysteresis value) or if count value > (compare value 1 + hysteresis value). output 1 → 0, if count value ≥ compare value 0 or ≤ compare value 1

6 Description of the function outputs D1 and D2

6.1 General

Examples:

hysteresis:

10 pulses (REG_CNT1_DO1_HYS = 10)

switching event:

Mode Dx

D=1 at $CNT < CMP0$ Hys.,

this means:

output 0 → 1, if count value (REG_CNTx_CNT) < compare value 0 (REG_CNTx_CMP0).

If the count value toggles around the compare value, the output is **only** switched when the count value differs by more than -10 pulses from the compare value.

7 Report of configuration errors

7.1 Error-register

The register REG_CONFIG_ERRSTS (register no. 0x0A) in the Register interface (page 91) is used to report configuration errors.

If REG_CONFIG_ERRSTS \neq 0, then bit STS_CONFIG_ERR = 1 in the Process input / check-back interface (page 28) reports that errors in the device's configuration occurred.

It can be read from the register, which error is existent.

7.1.1 Error messages in REG_CONFIG_ERRSTS for the count operation mode (CNT1 and CNT2)

Table 19: REG_CONFIG_ERRSTS (CNTx)	Bit	Meaning at bit = 1
	0	The count value of CNT1 exceeded the count limits. REG_CNT1_CNT > REG_CNT1_HILIMIT or REG_CNT1_CNT < REG_CNT1_LOLIMIT
	1	The load value of CNT1 exceeded the count limits. REG_CNT1_LOADVAL > REG_CNT1_HILIMIT or REG_CNT1_CNT < REG_CNT1_LOADVAL
	2	The configuration of the count limits is faulty. REG_CNT1_HILIMIT \leq REG_CNT1_LOLIMIT
CNT1	3	The compare value CMP0 of CNT1 exceeded the count limits. REG_CNT1_CMP0 > REG_CNT1_HILIMIT or REG_CNT1_CMP0 < REG_CNT1_LOLIMIT
	4	The compare value CMP1 of CNT1 exceeded the count limits. REG_CNT1_CMP1 > REG_CNT1_HILIMIT or REG_CNT1_CMP1 < REG_CNT1_LOLIMIT
	5	Division through "0" or multiplication with "0" during the measurement at CNT1 REG_CNT1_DIV = 0 or REG_CNT1_MUL = 0
	6	Only valid for frequency measurement: REG_CNT1_INTTIME = 0 or REG_CNT1_INTTIME > 17800
	7	A diagnostic message is pending. The diagnostic byte for CNT1 > 0 (see Diagnostic data of the module (page 24)).

7 Report of configuration errors

7.1 Error-register

Table 19:
REG_CONFIG_
ERRSTS (CNTx)

	Bit	Meaning at bit = 1
CNT2	8	The count value of CNT1 exceeded the count limits. REG_CNT1_CNT > REG_CNT2_HILIMIT or REG_CNT1_CNT < REG_CNT2_LOLIMIT
	9	The load value of CNT1 exceeded the count limits. REG_CNT2_LOADVAL > REG_CNT2_HILIMIT or REG_CNT1_CNT < REG_CNT2_LOADVAL
	10	The configuration of the count limits is faulty. REG_CNT2_HILIMIT ≤ REG_CNT2_LOLIMIT
	11	The compare value CMP0 of CNT1 exceeded the count limits. REG_CNT2_CMP0 > REG_CNT1_HILIMIT or REG_CNT2_CMP0 < REG_CNT2_LOLIMIT
	12	The compare value CMP1 of CNT1 exceeded the count limits. REG_CNT2_CMP1 > REG_CNT2_HILIMIT or REG_CNT2_CMP1 < REG_CNT2_LOLIMIT
	13	Division through "0" or multiplication with "0" during the measurement at CNT1 REG_CNT2_DIV = 0 or REG_CNT2_MUL = 0
	14	Only valid for frequency measurement: REG_CNT2_INTTIME = 0 or REG_CNT2_INTTIME > 17800
	15	A diagnostic message is pending. The diagnostic byte 1 for CNT2 > 0 (see Diagnostic data of the module (page 24)).

7.1.2 Error messages in REG_CONFIG_ERRSTS for the PWM output (PWM1 and PWM2)

Table 20:
REG_CONFIG_
ERRSTS
(PWMx)

Bit	Meaning at bit = 1
PWM 1	16 Period Duration / Duty Cycle Definition (page 61): Wrong setting of period duration and/or duty cycle (pulse width) High Time / Low Time Definition (page 63) Invalid pulse time set (lower than 22 µs). REG_PWM1_DHIGH < 0 x 00 00 02 21
	17 Period Duration / Duty Cycle Definition (page 61): Wrong setting of period duration and/or duty cycle (pulse width) High Time / Low Time Definition (page 63) Invalid space time set (lower than 22 µs). REG_PWM1_DLOW < 0 x 00 00 02 21
	18 invalid period duration set. REG_PWM1_PD > 0 x FF FF FF FE
	19 invalid duty cycle (pulse width) set REG_PWM1_DC > 0 x FF FF FF FE
	20 - 22 reserved
23 A diagnostic message is pending. The diagnostic byte 2 for CNT2 > 0 (see Diagnostic data of the module (page 24)).	
PWM 2	24 Period Duration / Duty Cycle Definition (page 61): Wrong setting of period duration and/or duty cycle (pulse width) High Time / Low Time Definition (page 63) Invalid pulse time set (lower than 22 µs). REG_PWM2_DHIGH < 0 x 00 00 02 21
	25 Period Duration / Duty Cycle Definition (page 61): Wrong setting of period duration and/or duty cycle (pulse width) High Time / Low Time Definition (page 63) Invalid space time set (lower than 22 µs). REG_PWM2_DLOW < 0 x 00 00 02 21
	26 invalid period duration set. REG_PWM2_PD > 0 x FF FF FF FE
	27 invalid duty cycle (pulse width) set REG_PWM2_DC > 0 x FF FF FF FE
	28 - 30 reserved
31 A diagnostic message is pending. The diagnostic byte 2 for CNT2 > 0 (see Diagnostic data of the module (page 24)).	

7 Report of configuration errors

7.1 Error-register

8 Error handling in the control interface / check-back interface

8.1 Error messages of the module

In addition to the higher-level operation- and application relevant diagnostic messages (→ see page 24), each channel of the XNE-2CNT-2PWM also reports channel specific errors via the Process input / check-back interface (page 28).

A distinction is made between:

- volatile status messages (**STS**)
Display of current states (for example CNT/PWM function enabled, CNT/PWM active, CNT/PWM special function active, etc.), → see Process input / check-back interface (page 28).

and

- non-volatile flags (**MSG**)
Non-volatile storage of messages/events (for example overflow, zero crossing, etc.) which could possibly get lost due to their time behavior.

8.1.1 Non-volatile flags (MSG)

MSG for CNTx

- CNT1: Process input / check-back interface, byte 1
- CNT2: Process input / check-back interface, byte 3

Table 21:
MSG for CNTx

Designation	Description	Triggering event
MSG_CNTx_CMP0	Checking the count value for reaching the compare value 0.	REG_CNTx_CNT = REG_CNTx_CMP0
MSG_CNTx_CMP1	Checking the count value for reaching the compare value 1.	REG_CNTx_CNT = REG_CNTx_CMP1
MSG_CNTx_UFLW	Checking the count value for an underflow.	REG_CNTx_CNT = REG_CNTx_UFLW
MSG_CNTx_OFLW	Checking the count value for an overflow.	REG_CNTx_CNT = REG_CNTx_OFLW
MSG_CNTx_ND	Checking the count value for a zero crossing.	REG_CNTx_CNT = 0
MSG_CNTx_FQE	No counter pulse received within a defined time (definition in REG_CNTx_TO (page 93 or page 94)) although the count operation is enabled. If count pulses were received, is only monitored while the count operation is enabled (STS_CNTx_RUN=1).	
MSG_CNTx_SFT	The event according to the parameterized special function occurred (→ see Special function of inputs Z1 and Z2 at CNTx (page 45)).	
MSG_CNTx_SW_LR	A software latch retrigger has been executed.	CNTx_SW_LR of the counter in the control interface changes from 0 → 1

8 Error handling in the control interface / check-back interface

8.1 Error messages of the module

MSG for PWMx

- PWM1: Process input / check-back interface, byte 4, bits 0 to 4
- PWM2: Process input / check-back interface, byte 5, bits 0 to 4

Table 22:
MSG for PWMx

Designation	Description	Triggering event
MSG_PWMx_SW_LR	A software latch retrigger has been executed.	PWMx_SW_LR of the counter in the control interface changes from 0 → 1
MSG_PWMx_NDDC	Checking the count value for a zero crossing.	MSG_PWMx_NDDC = 1 if REG_CNTx_CNTDC = 0
MSG_PWMx_SFKT	The event according to the parameterized special function occurred (→ see Special function of inputs Z1 and Z2 for the PWM (page 70)).	
MSG_PWMx_DO_ERR	One of the outputs Px (page 24) or Dx (page 24) of the corresponding PWMx-channel sent an error.	Short-circuit at one of the outputs of the PWM channels.

8 Error handling in the control interface / check-back interface

8.1 Error messages of the module

8.1.2 Storage of messages (MSG)

In order to guarantee that all events or state changes which effect the MSG bits can be registered at any time, the following behaviour was implemented:

- With the change from 0 → 1 in the control bits CNTx_LOGMSG or respectively PWMx_LOGMSG in the Process input / check-back interface (→ see page 28), all states of the MSG bits are held.
- If events which would cause messages would occur in the meantime, they would get lost.
- To avoid this, a "shadow register" (REG_CNTx_LOGMSG, page 93 ff. or respectively REG_PWMx_LOGMSG, page 95 ff.) was created, in which, as long as the message bits are held, newly occurring messages (MSG) are stored.
- The basic status of the shadow register is: "all MSG = 0".
- The states of the MSG bits, held in the process input data, can now be read out without newly incoming MSG going lost.

Resetting the control bits

- If now the control bits CNTx_LOGMSG or PWMx_LOGMSG in the Process output / control interface (→ see page 32) are reset through 1 → 0, the messages that were meanwhile recorded in the shadow register are copied to the MSG bits in the Process input / check-back interface (page 28).
- By means of this procedure, MSG bits of the Process input / check-back interface (page 28) can be read out or respectively set back without losing messages.

Figure 17:
Flow chart for
the storage of
MSG

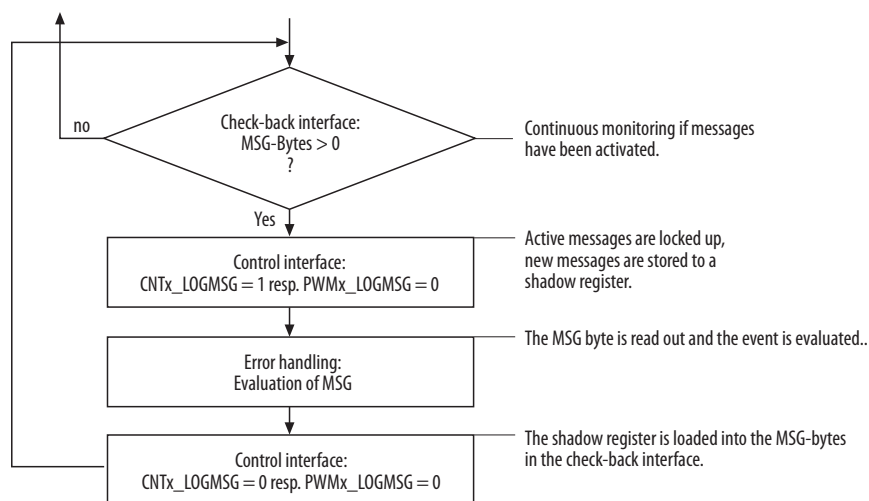

8 Error handling in the control interface / check-back interface

8.1 Error messages of the module

9 Register interface

9.1 Internal registers - reading and writing

This module provides a universal register interface that enables access to up to 128 32-bit registers.

9.1.1 Write access

Write access is realized using REG_WR_DATA, Byte 0 to REG_WR_DATA, Byte 3 via the Process output / control interface (page 32).

For write access, it must be ensured beforehand that the register write interface is in the default status and that there is no write access operation active. This is ensured if REG_WR = 0 in the process output data, and is confirmed in the process input data with REG_WR_AKN = 0.

Write access is now possible.

Therefore, the following values must be transferred with the process output data:

- the address of the register to be written in REG_WR_ADR, Process output / control interface (page 32):
- the value to be written in REG_WR_DATA, Byte 0 to REG_WR_DATA, Byte 3, Process output / control interface (page 32)
- the write command with REG_WR = 1 Process output / control interface (page 32)

The module acknowledges the processing of the write command by setting the acknowledge bit REG_WR_AKN= 1 in the Process input / check-back interface (page 28).

If register was successfully written, this is confirmed in the Process input / check-back interface (page 28) with REG_WR_ACCEPT = 1.

The write operation must then be terminated by REG_WR = 0. This is done to resume the default state.

Abort of the write command

REG_WR_ACCEPT = 0 indicates that the register could not be written (no access authorization, faulty value range,...).

Example for a write access

Writing the lower count limit "0" of counter 1 in register no. 36 (0x24) REG_CNT1_LOLIMIT.

Write access:

- 1 Address of the register to be written:
Process output / control interface (page 32) →
REG_WR_ADR = 36 (0x24)
- 2 value to be written:
lower count limit = 0
Process output / control interface (page 32) →
REG_WR_DATA, byte 0 = 00
REG_WR_DATA, byte 1 = 00
REG_WR_DATA, byte 2 = 00
REG_WR_DATA, byte 3 = 00

9 Register interface

9.1 Internal registers - reading and writing

- 3 Process output / control interface (page 32) →
REG_WR = 0 → 1
The write operation is enabled.

9.1.2 Read access

Read access to an optional register is done via the Process input / check-back interface (page 28) as well as via the Process output / control interface (page 32).

The following entries have to be carried out in the Process output / control interface (page 32):

- Definition of the address of the register to be read out: REG_RD_ADR

The following entries are carried out by the module in the Process input / check-back interface (page 28):

- As an acknowledge, REG_RD_ADR contains the address of the register to be read
- an error-free reading of the register is confirmed by REG_RD_ABORT = 0
- the read register content is shown in REG_RD_DATA, Byte 0 to REG_RD_DATA, Byte 3

Abort of the read command

REG_RD_ABORT = 1 shows that the register could not be read.

In case of a missed register access, REG_RD_ADR of the process input data contains the address that could not be accessed successfully.

The user data is then set to ZERO.

Example for a read access

Reading the actual count value of counter 1 from register no. 32 (0x20) REG_CNT1_CNT.

Read access:

- 1 Address of the register to be read:
Process output / control interface (page 32) →
REG_RD_ADR = 32 (0x20)
- 2 Feedback:
Process input / check-back interface (page 28) →
REG_RD_ADR = 32 (0x20)
- 3 Feedback:
Process input / check-back interface (page 28) →
REG_RD_ABORT = 0
The read access was successful.
- 4 read value:
Process input / check-back interface (page 28) →
Example:
REG_RD_DATA, byte 0 = 27
REG_RD_DATA, byte 1 = 10
REG_RD_DATA, Byte 2 = 00
REG_RD_DATA, Byte 3 = 00

9.2 Register description and register access

9.2.1 Register interface

Designation	No.	Description	Format	Default (HEX)	Storage in module	Process output	Process input	Parameters	Diagnostics
V = volatile NV = non-volatile RD = read access WR = write access									
Standard registers									
-	0x00								
REG_MAGIC_NO	0x01	Magic number (internal use)		0xaa55cc33					RD
REG_HW_VER	0x02	hardware-version							RD
REG_SW_VER	0x03	Firmware version							RD
REG_SF	0x04	Special function register			V		WR		
REG_IF_VER	0x05	Version of the register interface							RD
	...	reserved							RD
REG_CONFIG_ERRSTS	0x0A	report of configuration errors			V		RD		
	...	reserved							
REG_DATA_IN1, byte 3-0	0x0C	Process input 1	32 bit unsigned		V		RD		
REG_DATA_IN2, byte 7-4	0x0D	...			V		RD		
REG_DATA_IN3, byte 11-8	0x0E				V		RD		
REG_DATA_IN4, byte 15-12	0x0F				V		RD		
REG_DATA_IN5, byte 19-16	0x10				V		RD		
REG_DATA_IN6, byte 23-20	0x11	Process input 6			V		RD		
REG_DATA_OUT1, byte 3-0	0x12	Process output 1			V		RD		
REG_DATA_OUT2, byte 7-4	0x13	...			V		RD		
REG_DATA_OUT3, byte 11-8	0x14				V		RD		
REG_DATA_OUT4, byte 15-12	0x15				V		RD		
REG_DATA_OUT5, byte 19-16	0x16				V		RD		
REG_DATA_OUT6, byte 23-20	0x17	Process output 6			V		RD		
REG_DIAG1, byte 3-0	0x18	Diagnostic data 1			V		RD		RD

9 Register interface

9.2 Register description and register access

Designation	No.	Description	Format	Default (HEX)	Storage in module	Process output	Process input	Parameters	Diagnostics
	0x19 to 1B	reserved			V				
REG_PARA1, byte 3-0	0x1C	parameter data 1		0x00 00 00 00	NV	WR	RD	WR	
REG_PARA2, byte 7-4	0x1D	...	32 bit unsigned	0x00 00 00 00	NV	WR	RD	WR	
REG_PARA3, byte 11-8	0x1E			0x00 00 00 00	NV	WR	RD	WR	
REG_PARA4, byte 15-12	0x1F	parameter data 3		0x00 00 00 00	NV	WR	RD	WR	

V = volatile
 NV = non-volatile
 RD = read access
 WR = write access

9 Register interface

9.2 Register description and register access

Designation	No.	Description	Format	Default (HEX)	Storage in module	Process output	Process input	Parameters	Diagnostics
					V = volatile NV = non-volatile RD = read access WR = write access				
Register CNT1									
REG_CNT1_CNT	0x20	Actual binary value of the CNT1			V	WR	RD		
REG_CNT1_MV	0x21	measured value CNT1	32 bit unsigned		V		RD		
...	0x22	reserved	-	-	-	-	-	-	-
REG_CNT1_LOADVAL	0x23	load value CNT1	32 bit signed	0x00 00 00 00	NV	WR	RD		
REG_CNT1_LOLIMIT	0x24	Lower count limit CNT1		0x80 00 00 00	NV	WR	RD		
REG_CNT1_HILIMIT	0x25	Upper count limit CNT1		0x7F FF FF FF	NV	WR	RD		
REG_CNT1_CMP0	0x26	Compare value 0 CNT1		0x00 00 00 00	NV	WR	RD		
REG_CNT1_CMP1	0x27	Compare value 1 CNT1		0x00 00 00 00	NV	WR	RD		
REG_CNT1_LATCH	0x28	Buffer	32 bit signed	-	V		RD		
REG_CNT1_INTTIME	0x29	Integration time CNT1 in 10 ms/bit	32 bit unsigned	0x00 00 00 0A (100 ms)	NV	WR	RD		
REG_CNT1_MUL	0x2A	Factor CNT1		0x00 00 00 01	NV	WR	RD		
REG_CNT1_DIV	0x2B	Divisor CNT1		0x00 00 00 01	NV	WR	RD		
REG_CNT1_IPI	0x2C	Pulses per integration time		-	V		RD		
REG_CNT1_TO	0x2D	Time out CNT1 in 10 ms/bit		0x00 00 00 00	NV	WR	RD		
REG_CNT1_LOGMSG	0x2E	Buffer of the MSG register at MSGLOG (→ see CNT _x _LOGMSG (page 33))		-	V		RD		
REG_CNT1_DO1_HYS	0x2F	Hysteresis of the D1 and STS_DBP1 for CNT1		0x00 00 00 0A (10 pulses)	NV	WR	RD		
REG_CNT1_DO1_IMP	0x30	Pulse time for a pulse output at D1 in 10 ms/bit		0x00 00 00 0A (100 ms)	NV	WR	RD		
	0x31 to 0x3F	reserved		-	-				

9 Register interface

9.2 Register description and register access

Designation	No.	Description	Format	Default (HEX)	Storage in module	Process output	Process input	Parameters	Diagnostics
					V = volatile NV = non-volatile RD = read access WR = write access				
Register CNT2									
REG_CNT2_CNT	0x40	Actual binary value of the CNT2		-	V	WR	RD		
REG_CNT2_MV	0x41	Measured value CNT2	32 bit unsigned		V		RD		
...	0x42	reserved			-	-	-		
REG_CNT2_LOADVAL	0x43	Load value CNT2	32 bit signed	0x00 00 00 00	NV	WR	RD		
REG_CNT2_LOLIMIT	0x44	lower count limit CNT2		0x080 00 00 00	NV	WR	RD		
REG_CNT2_HILIMIT	0x45	Upper count limit CNT2		0x7F FF FF FF	NV	WR	RD		
REG_CNT2_CMP0	0x46	Compare value 0 CNT2		0x00 00 00 00	NV	WR	RD		
REG_CNT2_CMP1	0x47	Compare value 1 CNT2		0x00 00 00 00	NV	WR	RD		
REG_CNT2_LATCH	0x48	Buffer		-	V		RD		
REG_CNT2_INTTIME	0x49	Integration time CNT2 in 10 ms/bit	32 bit unsigned	0x00 00 00 0A (100 ms)	NV	WR	RD		
REG_CNT2_MUL	0x4A	Factor CNT2		0x00 00 00 01	NV	WR	RD		
REG_CNT2_DIV	0x4B	Divisor CNT2		0x00 00 00 01	NV	WR	RD		
REG_CNT2_IPI	0x4C	Pulses per integration time		-	V		RD		
REG_CNT2_TO	0x4D	Time out CNT2 in 10 ms/bit		0x00 00 00 00	NV	WR	RD		
REG_CNT2_LOGMSG	0x4E	Buffer of the MSG register at MSGLOG		-	V		RD		
REG_CNT2_DO1_HYS	0x4F	Hysteresis of the D2 and STS_DBP2 for CNT2		0x00 00 00 0A (10 pulses)	NV	WR	RD		
REG_CNT2_DO2_IMP	0x40	Pulse time for a pulse output at D2 in 10 ms/bit	32 bit unsigned	0x00 00 00 0A (100 ms)	NV	WR	RD		
	0x51 to 0x 5F	reserved							

Designation	No.	Description	Format	Default (HEX)	Storage in module	Process output	Process input	Parameters	Diagnostics
					V = volatile NV = non-volatile RD = read access WR = write access				
Register PWM1									
REG_PWM1_PD	0x60	Period duration PWM1 in 41,667 ns/bit	32 bit unsigned	0x00 00 5D C0 (1000 Hz)	V	WR	RD		
REG_PWM1_DC	0x61	Mark-to-space ratio PWM1, in $23,28 \times 10^{-9}$ %/bit		0x7F FF FF FF (50 %)	V	WR	RD		
REG_PWM1_DHIGH	0x62	Pulse duration PWM1 in 41,667 ns/bit		0x00 00 2E E0 (500 μ s)	V	WR	RD		
REG_PWM1_DLOW	0x63	Space duration PWM1 in 41,667 ns/bit		0x00 00 2E E0 (500 μ s)	V	WR	RD		
REG_PWM1_CNTSV	0x64	Load value of the pulses to be given out		0x00 00 27 10 (10000 pulses)	NV	WR	RD		
REG_PWM1_CNTDC	0x65	Number of pulse which still have to be given out PWM1		-	V		RD		
REG_PWM1_LATCH	0x66	Buffer PWM1		-	V		RD		
REG_PWM1_LOGMSG	0x67	Buffer of the MSG bits at MSGLOG, PWM1		-	V		RD		
REG_PWM1_PD_RV	0x68	Start value after reset: Period duration PWM1 in 41,667 ns/bit		0x00 00 5D C0 (1000 Hz)	NV	WR	RD		
REG_PWM1_DC_RV	0x69	Start value after reset: Mark-to-space ratio PWM1 in $23,28 \times 10^{-9}$ %/bit	32 bit unsigned	0x7F FF FF FF (50 %)	NV	WR	RD		
REG_PWM1_DHIGH_RV	0x6A	Start value after reset: Pulse duration PWM1 in 41,667 ns/bit		0x00 00 2E E0 (500 μ s)	NV	WR	RD		
REG_PWM1_DLOW_RV	0x6B	Start value after reset: Period duration PWM1 in 41,667ns/bit		0x00 00 2E E0 (500 μ s)	NV	WR	RD		
	0x6C to 0x6F	reserved							

9 Register interface

9.2 Register description and register access

Designation	No.	Description	Format	Default (HEX)	Storage in module	Process output	Process input	Parameters	Diagnostics
					V = volatile NV = non-volatile RD = read access WR = write access				
Register PWM2									
REG_PWM2_PD	0x70	Period duration PWM2 in 41,667 ns/bit	32 bit unsigned	0x00 00 5D C0 (1000 Hz)	V	WR	RD		
REG_PWM2_DC	0x71	Mark-to-space ratio PWM2, in $23,28 \times 10^{-9}$ %/bit		0x7F FF FF FF (50 %)	V	WR	RD		
REG_PWM2_DHIGH	0x72	Pulse duration PWM2 in 41,667 ns/bit		0x00 00 2E E0 (500 μ s)	V	WR	RD		
REG_PWM2_DLOW	0x73	Space duration PWM2 in 41,667 ns/bit		0x00 00 2E E0 (500 μ s)	V	WR	RD		
REG_PWM2_CNTSV	0x74	Load value of the pulses to be given out		0x00 00 27 10 (10000 pulses)	NV	WR	RD		
REG_PWM2_CNTDC	0x75	Number of pulse which still have to be given out PWM1		-	V		RD		
REG_PWM2_LATCH	0x76	Buffer PWM2		-	V		RD		
REG_PWM2_LOGMSG	0x77	Buffer of the MSG register at MSGLOG, PWM2		-	V		RD		
REG_PWM2_PD_RV	0x78	Start value after reset: Period duration PWM2 in 41,667 ns/bit	32 bit unsigned	0x00 00 5D C0 (1000 Hz)	NV	WR	RD		
REG_PWM2_DC_RV	0x79	Start value after reset: Mark-to-space ratio PWM2 in $23,28 \times 10^{-9}$ %/bit		0x7F FF FF FF (50 %)	NV	WR	RD		
REG_PWM2_DHIGH_RV	0x7A	Start value after reset: Pulse duration PWM2 in 41,667 ns/bit		0x00 00 2E E0 (500 μ s)	NV	WR	RD		
REG_PWM2_DLOW_RV	0x7B	Start value after reset: Space duration PWM2 in 41,667 ns/bit		0x00 00 2E E0 (500 μ s)	NV	WR	RD		
	0x7C to 0x7F	reserved							



Note

Non-volatile registers can be written for a maximum of 100,000 times.

Special function register / resetting the register interface

If the Special Function Register register no. 0x4 REG_SF is written with

LD20 = 0x4C443230

or

ld20 = 0x6C643230

the default values of all non-volatile registers (→ see Register interface (page 91)) **and** of the parameters (→ see Parameter data of the module (page 25)) are reset and the volatile registers REG_PWMx_PD, REG_PWMx_DC, REG_PWMx_DHIGH and REG_PWMx_DLOW (→ see page 95 ff.) are loaded with the content of the respective reset value registers (for example REG_PWM1_PD_RV).

Values that have been entered before get lost.

If the Special Function Register register no. 0x4 REG_SF is written with

LD48 = 0x4C443230

or

ld48 = 0x6C643438

the default values of all non-volatile registers (→ see Register interface (page 91)), **not** those of the parameters, are reset and the volatile registers REG_PWMx_PD, REG_PWMx_DC, REG_PWMx_DHIGH and REG_PWMx_DLOW (→ see page 95 ff.) are loaded with the content of the respective reset value registers (for example REG_PWM1_PD_RV).

**Note**

Values that have been entered before get lost.

9 Register interface

9.2 Register description and register access

10 Representation of the XNE-2CNT-2PWM in PROFIBUS-DPV1

10.1 Process data of the module in PROFIBUS-DPV1



Note

The structure of the process data bits in PROFIBUS-DPV1 basically corresponds to the general structure of the process data (→ see Chapter 3, section Process data of the module (page 28)).

It has thus to be observed that the structure of the user data words in PROFIBUS-DP differs from the general structure.

10 Representation of the XNE-2CNT-2PWM in PROFIBUS-DPV1

10.1 Process data of the module in PROFIBUS-DPV1

10.1.1 Process input / check-back interface



Note

Please find the meaning of the bits in the general description of the modules Process input / check-back interface in Chapter 3 from page 28.

		Byte	Bit 7	Bit 6	Bit 5	Bit 4	Bit 3	Bit 2	Bit 1	Bit 0
Status messages	CNTx (page 29)	0	A1	B1	Z1	STS_CNT1_DIR	STS_CNT1_LOGMSG	STS_CNT1_SFKT_EN	STS_CNT1_RUN	STS_CNT1_GENERAL_EN
		1	MSG_CNT1_SW_LR	MSG_CNT1_SFKT	MSG_CNT1_FQE	MSG_CNT1_ND	MSG_CNT1_OFLOW	MSG_CNT1_UFLOW	MSG_CNT1_CMP1	MSG_CNT1_CMP0
		2	A2	B2	Z2	STS_CNT2_DIR	STS_CNT2_LOGMSG	STS_CNT2_SFKT_EN	STS_CNT2_RUN	STS_CNT2_GENERAL_EN
		3	MSG_CNT2_SW_LR	MSG_CNT2_SFKT	MSG_CNT2_FQE	MSG_CNT2_ND	MSG_CNT2_OFLOW	MSG_CNT2_UFLOW	MSG_CNT2_CMP1	MSG_CNT2_CMP0
	PWMx (page 30)	4	STS_PWM_LOGMSG	STS_PWM_SFKT_EN	STS_PWM_RUN	STS_PWM_GENERAL_EN	MSG_PWM_DO_ERR	MSG_PWM_SFKT	MSG_PWM_NDDC	MSG_PWM_SW_LR
		5	STS_PWM2_LOGMSG	STS_PWM2_SFKT_EN	STS_PWM2_RUN	STS_PWM2_GENERAL_EN	MSG_PWM2_DO_ERR	MSG_PWM2_SFKT	MSG_PWM2_NDDC	MSG_PWM2_SW_LR
Register access (page 89) and DOs	6	REG_WR_ACCEPT	REG_WR_AKN	REG_RD_ABORT	STS_CONFIG_ERR	STS_DBP2	D2	STS_DBP1	D1	
	7	X	REG_RD_ADR							
User data (page 31)	8	REG_RD_DATA, Byte 3								
								
	11	REG_RD_DATA, Byte 0								
	12	AUX_REG1_RD_DATA, Byte 3								
								
	15	AUX_REG1_RD_DATA, Byte 0								
	16	AUX_REG2_RD_DATA, Byte 3								
								
	19	AUX_REG2_RD_DATA, Byte 0								
	20	AUX_REG3_RD_DATA, Byte 3								
								
23	AUX_REG3_RD_DATA, Byte 0									

10 Representation of the XNE-2CNT-2PWM in PROFIBUS-DPV1

10.1 Process data of the module in PROFIBUS-DPV1

10.1.2

Process output / control interface



Note

Please find the meaning of the bits in the general description of the modules Process output / control interface in Chapter 3 from page 32.

		Byte	Bit 7	Bit 6	Bit 5	Bit 4	Bit 3	Bit 2	Bit 1	Bit 0
Control bytes	CNT x (page 32)	0	X	CNT1_ SINGLE	CNT1_ SW_LR	CNT1_SFKT_ DISABLE	X	CNT1_ LOGMSG	CNT1_ ENABLE	CNT1_ GENERAL_ DISABLE
		1	X	CNT2_ SINGLE	CNT2_ SW_LR	CNT2_SFKT_ DISABLE	X	CNT2_ LOGMSG	CNT2_ ENABLE	CNT2_ GENERAL_ DISABLE
	PWM x (page 32)	2	X	PWM1_ SINGLE	PWM1_ SW_LR	PWM1_ SFKT_ DISABLE	X	PWM1_ LOGMSG	PWM1_ ENABLE	PWM1_ GENERAL_ DISABLE
		3	X	PWM2_ SINGLE	PWM2_ SW_LR	PWM2_ SFKT_ DISABLE	X	PWM2_ LOGMSG	PWM2_ ENABLE	PWM2_ GENERAL_ DISABLE
	DOS	4	X	X	SET_P2	SET_D2	X	X	SET_P1	SET_D1
Register access (page 89)	5	REG_WR	X	X	X	X	AUX_REG3_ WR_EN	AUX_REG2_ WR_EN	AUX_REG1_ WR_EN	
	6	X	REG_WR_ADR							
	7	X	REG_RD_ADR							
User data	8	REG_WR_DATA, byte 3								
								
	11	REG_WR_DATA, byte 0								
	12	AUX_REG1_WR_DATA, byte 3								
								
	15	AUX_REG1_WR_DATA, byte 0								
	16	AUX_REG2_WR_DATA, byte 3								
								
	19	AUX_REG2_WR_DATA, byte 0								
	20	AUX_REG3_WR_DATA, byte 3								
								
23	AUX_REG3_WR_DATA, byte 0									

X = reserved

10 Representation of the XNE-2CNT-2PWM in PROFIBUS-DPV1

10.2 Diagnostics of the module in DPV1

10.2 Diagnostics of the module in DPV1



Note

The module XNE-2CNT-2PWM can only be used with the XI/ON DPV1 gateways. These gateways support the diagnostic function according to PROFIBUS DP specification IEC/EN 61158, type 3.

Please read the corresponding gateway manuals for the description of the diagnostic message structure of the DPV1 gateways (→ see Additional documentation (page 7)).

10.2.1 DPV1 error codes

Table 23:
DPV1 error
codes

Error code (acc. to DPV1 standard)	Diagnostic messages	Channel	Message
4	overload	PWMx (Px, Dx)	P1_DIAG
			P2_DIAG
			D1_DIAG
			D2_DIAG
16	parameterization error	CNTx, PWMx	CNT1_PAR_ERR
			CNT2_PAR_ERR
			PWM1_PAR_ERR
			PWM2_PAR_ERR
27	unknown error	reserved	-

10 Representation of the XNE-2CNT-2PWM in PROFIBUS-DPV1

10.2 Diagnostics of the module in DPV1

10.2.2

Diagnostic data

The module's diagnostic data contain error messages that are operation and application relevant for the control system. 4 bytes are used to transfer the diagnostic data.



Note

A more detailed description of the module's diagnostic data can be found in the field bus independent module description (Chapter 3, section Diagnostic data of the module (page 24)).

Byte	Bit 7	Bit 6	Bit 5	Bit 4	Bit 3	Bit 2	Bit 1	Bit 0
0	HW_ERR	CNT1_ PAR_ERR	X	X	X	X	X	X
1	HW_ERR	CNT2_ PAR_ERR	X	X	X	X	X	X
2	HW_ERR	PWM1_ PAR_ERR	X	X	X	X	P1_DIAG	D1_DIAG
3	HW_ERR	PWM2_ PAR_ERR	X	X	X	X	P2_DIAG	D2_DIAG

10 Representation of the XNE-2CNT-2PWM in PROFIBUS-DPV1

10.3 Parameter in DPV1

10.3 Parameter in DPV1



Note

The module XNE-2CNT-2PWM can only be used with the XI/ON DPV1 gateways. These gateways support the parameterization according to PROFIBUS DP specification IEC/EN 61158, type 3.

Please read the corresponding gateway manuals for the description of the parameter data structure of the DPV1 gateways (→ see Additional documentation (page 7)).

10 Representation of the XNE-2CNT-2PWM in PROFIBUS-DPV1

10.3 Parameter in DPV1

10.3.1

Parameter data of the module



Note

A more detailed description of the module's parameter data can be found in the field bus independent module description (Chapter 3, section Parameter data of the module (page 25)).

Byte	Bit 7	Bit 6	Bit 5	Bit 4	Bit 3	Bit 2	Bit 1	Bit 0
0	input A1	input B1	input Z1	X	diagnostic CNT1	measurement mode CNT1	main count direction CNT1	
1	filter Z1		filter A1, B1		X	pull up Z1	X	threshold input A,B,Z CNT1
2	mode Z1				mode CNT1			
3	input A2	input B2	input Z2	X	diagnostic	measurement mode CNT2	main count direction CNT2	
4	filter Z2		filter A2, B2		X	pull up Z2	X	threshold input A,B,Z CNT2
5	mode Z2				mode CNT2			
6	diagnostic PWM1	X	mode D1					
7	DBP1 STS MODE		substitute value P1	substitute value D1	mode PWM1			
8	diagnostic PWM2	X	mode D2					
9	DBP2 STS MODE		substitute value P2	substitute value D2	mode PWM2			
10	X	ADR AUX REG1 RD DATA						
11	X	ADR AUX REG2 RD DATA						
12	X	ADR AUX REG2 RD DATA						
13	X	ADR AUX REG1 WR DATA						
14	X	ADR AUX REG2 WR DATA						
15	X	ADR AUX REG3 WR DATA						

X = reserved

10 Representation of the XNE-2CNT-2PWM in PROFIBUS-DPV1

10.3 Parameter in DPV1

11 Representation of the XNE-2CNT-2PWM in CANopen

11.1 Objects for counter modules

11.1.1 General object overview for counter modules

Table 24:
General object
overview for
counter
modules

	Object	Name	page	
Manufacturer specific objects	CNTx	5800 _{hex}	not supported	
		5801 _{hex}	Encoder Config	page 109
		5802 _{hex}	Encoder Status	page 111
		5803 _{hex}	Encoder Flags	page 112
		5804 _{hex}	Encoder Diag	page 113
		5805 _{hex}	Encoder Native Status	page 114
		5806 _{hex}	Encoder Optional Status	page 115
		5808 _{hex}	Encoder Control	page 116
		5810 _{hex}	Encoder Load Prepare Value	page 117
		5811 _{hex}	Encoder Pulse Width	page 118
		5820 _{hex}	Measuring Integration Time	page 119
		5821 _{hex}	not supported	
		5822 _{hex}		
		5823 _{hex}		
		5824 _{hex}	Encoder Measuring Divisor	page 120
		5825 _{hex}	Encoder Measuring Factor	page 121
		5827 _{hex}	Encoder Measuring Time Out	page 122
		5830 _{hex}	Encoder Measuring Value	page 123
5831 _{hex}	Encoder Latch Value	page 124		

11 Representation of the XNE-2CNT-2PWM in CANopen

11.1 Objects for counter modules

Table 24:
General object
overview for
counter
modules

	Object	Name	page	
Manufacturer specific objects	5901 _{hex}	PWM Config	page 125	
	5902 _{hex}	PWM Status	page 127	
	5903 _{hex}	PWM Flags	page 128	
	5904 _{hex}	PWM Diag	page 129	
	5908 _{hex}	PWM Control	page 130	
	5910 _{hex}	PWM Load Prepare Value	page 132	
	5913 _{hex}	PWM Duty Cycle	page 133	
	5920 _{hex}	PWM Period Duration	page 134	
	5931 _{hex}	PWM Latch Value	page 135	
Objects according to DS 406 + offset (0x800)	6810 _{hex}	Preset Value For Multi-Sensor Devices	page 136	
	6820 _{hex}	Preset Value For Multi-Sensor Devices	page 137	
	6B00 _{hex}	CAM 1 State Register	page 138	
	6B00 _{hex}	CAM 1 Enable Register	page 139	
	6B00 _{hex}	Cam 1 Polarity Register	page 140	
	6B10 _{hex}	Cam 1 Low Limit	page 141	
	6B20 _{hex}	Cam 1 High Limit	page 142	
	6B30 _{hex}	Cam 1 Hysteresis	page 143	
	6C00 _{hex}	Area State Register	page 144	
	6C01 _{hex}	Work Area Low Limit	page 145	
	6C02 _{hex}	Work Area High Limit	page 146	
	Diagnostics			
	6FFF _{hex}	Device Type	page 147	

11.1.2 Object descriptions

Object 5801_{hex} – Encoder Config

The object 5801_{hex} affects the configuration parameters of CNTx:

- output parameters
- sensor and input filter
- sensor parameters
- behavior on failure of the higher-level PLC

Write accesses initiate a parameter update via the internal module bus of the XI/ON station. The parameter is stored as a non-volatile parameter in the XI/ON gateway and is restored with every node reset.

Table 25:
Object 5801_{hex}

Feature	Sub-index	Description
Name		Encoder Config
Object code		ARRAY
PDO mapping		-
Data type	0x00	Unsigned 8
	0x01 to 0x47	Unsigned 32
Access	0x00	ro
	0x01 to 0x47	rw
Default value	0x00	-
	0x01 to 0x47	-

11 Representation of the XNE-2CNT-2PWM in CANopen

11.1 Objects for counter modules

Structure of the data bytes

Sub-index $0 \times 00 \leq n \leq 0 \times 47$	Byte	Bit 7	Bit 6	Bit 5	Bit 4	Bit 3	Bit 2	Bit 1	Bit 0 (lsb)
n = CNT1	0	input A1 (0x00)	input B1 (0x00)	input Z1 (0x00)	X	diagnostic CNT1 (0x00)	measurement mode CNT1 (0x00)	main count direction CNT1 (0x00)	
	1	Bit 15	Bit 14	Bit 13	Bit 12	Bit 11	Bit 10	Bit 9	Bit 8
		filter Z1 (0x00)		filter A1, B1 (0x00)		X	pull up Z1 (0x00)	X	threshold input A,B,Z CNT1 (0x00)
	2	Bit 23	Bit 22	Bit 21	Bit 20	Bit 19	Bit 18	Bit 17	Bit 16
		mode Z1 (0x03)				mode CNT1 (0x00)			
	3	Bit 31 (msb)	Bit 30	Bit 29	Bit 28	Bit 27	Bit 26	Bit 25	Bit 24
X		ADR AUX REG1 RD DATA (0x20)							
n + 1 = CNT2	0	input A2 (0x00)	input B2 (0x00)	input Z2 (0x00)	X	diagnostic CNT2 (0x00)	measurement mode CNT2 (0x00)	main count direction CNT2 (0x00)	
	1	Bit 15	Bit 14	Bit 13	Bit 12	Bit 11	Bit 10	Bit 9	Bit 8
		filter Z2 (0x00)		filter A2, B2 (0x00)		X	pull up Z2 (0x00)	X	threshold input A,B,Z CNT2 (0x00)
	2	Bit 23	Bit 22	Bit 21	Bit 20	Bit 19	Bit 18	Bit 17	Bit 16
		mode Z2 (0x03)				mode CNT2 (0x00)			
	3	Bit 31 (msb)	Bit 30	Bit 29	Bit 28	Bit 27	Bit 26	Bit 25	Bit 24
X		ADR AUX REG3 RD DATA (0x40)							

() = default parameterization



Note

A more detailed description of the module's parameter data can be found in the field bus independent module description (Chapter 3, section Parameter data of the module (page 25)).

Object 5802hex – Encoder Status

Status displays of the CNTx from the process input data.

The object 5802_{hex} supplies the following status messages:

- count direction
- status of in- and outputs
- operation status of the counter

Table 26:
Object 5802_{hex}

Feature	Sub-index	Description
Name		Encoder Status
Object code		ARRAY
PDO mapping		✓
Data type	0x00	Unsigned 8
	0x01 to 0x47	Unsigned 8
Access SDO	0x00	ro
	0x01 to 0x47	ro
Default value	0x00	-
	0x01 to 0x47	-

Structure of the data bytes

The meaning of the status data bytes generally corresponds to the general description of the module (→ see Process input / check-back interface (page 28)).

exception:

The count direction is not reported via a common bit (STS_CNTx_DIR, page 28) but using the two bits STS_CNT1_UP and STS_CNT1_DN.

Sub-index 0x00 ≤ n ≤ 0x47	Byte	Bit 7 (msb)	Bit 6	Bit 5	Bit 4	Bit 3	Bit 2	Bit 1	Bit 0 (lsb)
n = CNT1	0	STS_CNT1_DN	STS_CNT1_UP	STS_CNT1_SFKT_EN	STS_DBP1	D1	STS_CNT1_GENERAL_EN	Z1	STS_CNT1_RUN
n + 1 = CNT2	0	STS_CNT2_DN	STS_CNT2_UP	STS_CNT2_SFKT_EN	STS_DBP2	D2	STS_CNT2_GENERAL_EN	Z2	STS_CNT2_RUN



Note

A more detailed description of the module's status messages can be found in the field bus independent module description (Chapter 3, section Process input / check-back interface (page 28)).

11 Representation of the XNE-2CNT-2PWM in CANopen

11.1 Objects for counter modules

Object 5803hex – Encoder Flags

Das Object 5803_{hex} supplies the following messages via the process input data:

- reaching of limit values
- execution of a SW latch retrigger
- an event defined as special function (SFKT) has occurred
- a time out in the count pulse measurement occurred

Table 27:
Object 5803_{hex}

Feature	Sub-index	Description
Name		Encoder Flags
Object code		ARRAY
PDO mapping		✓
Data type	0x00	Unsigned 8
	0x01 to 0x47	Unsigned 8
Access SDO	0x00	ro
	0x01 to 0x47	rw
Access PDO	0x01 to 0x47	r
Default value	0x00	-
	0x01 to 0x47	-

Structure of the data bytes

The meaning of the data bytes in the process input / check-back interface generally corresponds to the general description of the module (→ see Process input / check-back interface (page 28)).

Sub-index 0x00 ≤ n ≤ 0x47	Byte	Bit 7 (msb)	Bit 6	Bit 5	Bit 4	Bit 3	Bit 2	Bit 1	Bit 0 (lsb)
n = CNT1	0	MSG_CNT1 _ND	MSG_CNT1 _UFLW	MSG_CNT1 _OFLW	MSG_CNT1 _CMP1	MSG_CNT1 _CMPO	MSG_CNT1 _SW_LR	MSG_CNT1 _SFKT	MSG_CNT1 _FOE
n + 1 = CNT2	0	MSG_CNT2 _ND	MSG_CNT2 _UFLW	MSG_CNT2 _OFLW	MSG_CNT2 _CMP1	MSG_CNT2 _CMPO	MSG_CNT2 _SW_LR	MSG_CNT2 _SFKT	MSG_CNT2 _FOE



Note

A more detailed description of the module's messages can be found in the field bus independent module description (Chapter 3, section Process input / check-back interface (page 28)).

11 Representation of the XNE-2CNT-2PWM in CANopen

11.1 Objects for counter modules

Object 5804_{hex} – Encoder Diag

The object 5804_{hex} reads error messages of CNTx from the module's diagnostic data.

Table 28:
Object 5804_{hex}

Feature	Sub-index	Description
Name		Encoder Diag
Object code		ARRAY
PDO mapping		-
Data type	0x00	Unsigned 8
	0x01 to 0x47	Unsigned 8
Access	0x00	ro
	0x01 to 0x47	ro
Default value	0x00	-
	0x01 to 0x47	-

Structure of the data bytes

The meaning of the diagnostic bits generally corresponds to the general description of the module (→ see Diagnostic data of the module).

Sub-index 0x00 ≤ n ≤ 0x47	Byte	Bit 7 (msb)	Bit 6	Bit 5	Bit 4	Bit 3	Bit 2	Bit 1	Bit 0 (lsb)
n = CNT1	0	HW_ERR	CNT1_ PAR_ERR	CNT1_ ERR_UFLW	CNT1_ ERR_OFLW	reserved			
n + 1 = CNT2	0	HW_ERR	CNT2_ PAR_ERR	CNT2_ ERR_UFLW	CNT2_ ERR_OFLW	reserved			



Note

A more detailed description of the module's diagnostic data can be found in the field bus independent module description (Chapter 3, section Diagnostic data of the module (page 24)).

11 Representation of the XNE-2CNT-2PWM in CANopen

11.1 Objects for counter modules

Object 5805hex – Encoder Native Status

The object 5805_{hex} reads the counter's status byte and the flag byte (B1, B0) from the Process input / check-back interface of the module. The following operation states are reported.

Table 29:
Object 5805_{hex}

Feature	Sub-index	Description
Name		Encoder Native Status
Object code		ARRAY
PDO mapping		✓
Data type	0x00	Unsigned 8
	0x01 to 0x47	Unsigned 16
Access	0x00	ro
	0x01 to 0x47	ro
Default value	0x00	-
	0x01 to 0x47	-

Structure of the data bytes

Sub-index 0x00 ≤ n ≤ 0x47	Byte	Bit 7	Bit 6	Bit 5	Bit 4	Bit 3	Bit 2	Bit 1	Bit 0 (lsb)
n = CNT1	0	A1	B1	Z1	STS_CNT1_DIR	STS_CNT1_LOGMSG	STS_CNT1_SFKT_EN	STS_CNT1_RUN	STS_CNT1_GENERAL_EN
	1	Bit 15 (msb)	Bit 14	Bit 13	Bit 12	Bit 11	Bit 10	Bit 9	Bit 8
		MSG_CNT1_SW_LR	MSG_CNT1_SFKT	MSG_CNT1_FQE	MSG_CNT1_ND	MSG_CNT1_OFLW	MSG_CNT1_UFLW	MSG_CNT1_CMP1	MSG_CNT1_CMP0
n + 1 = CNT2	Byte	Bit 7	Bit 6	Bit 5	Bit 4	Bit 3	Bit 2	Bit 1	Bit 0 (lsb)
	0	A2	B12	Z2	STS_CNT2_DIR	STS_CNT2_LOGMSG	STS_CNT2_SFKT_EN	STS_CNT2_RUN	STS_CNT2_GENERAL_EN
	1	Bit 15 (msb)	Bit 14	Bit 13	Bit 12	Bit 11	Bit 10	Bit 9	Bit 8
MSG_CNT2_SW_LR		MSG_CNT2_SFKT	MSG_CNT2_FQE	MSG_CNT2_ND	MSG_CNT2_OFLW	MSG_CNT2_UFLW	MSG_CNT2_CMP1	MSG_CNT2_CMP0	



Note

A more detailed description of the module's messages can be found in the field bus independent module description (Chapter 3, section Process input / check-back interface (page 28)).

11 Representation of the XNE-2CNT-2PWM in CANopen

11.1 Objects for counter modules

Object 5806hex – Encoder Optional Status

The object 5806_{hex} supplies the following status messages:

Table 30:
Object 5806_{hex}

Feature	Sub-index	Description
Name		Encoder Optional Status
Object code		ARRAY
PDO mapping		✓
Data type	0x00	Unsigned 8
	0x01 to 0x47	Unsigned 8
Access	0x00	ro
	0x01 to 0x47	ro
Default value	0x00	-
	0x01 to 0x47	-

Structure of the data bytes

Sub-index 0x00 ≤ n ≤ 0x47	Byte	Bit 7	Bit 6	Bit 5	Bit 4	Bit 3	Bit 2	Bit 1	Bit 0 (lsb)
n = CNT1	0	reserved						STS_DBP1	D1
n + 1 = CNT2	0	reserved						STS_DBP2	D2



Note

A more detailed description of the module's messages can be found in the field bus independent module description (Chapter 3, section Process input / check-back interface (page 28)).

11 Representation of the XNE-2CNT-2PWM in CANopen

11.1 Objects for counter modules

Object 5808hex – Encoder Control

The object 5808_{hex} provides the following control functions for CNTx (Process output / control interface (page 32)):

- general enabling or disabling of the count function
- start/stop of the count operation
- storing of Error messages of the module (page 85) for readout without data loss
- enabling or disabling of the special function
- executing a software latch retrigger
- setting the single or continuous count

Table 31:
Object 5808_{hex}

Feature	Sub-index	Description
Name		Encoder Control
Object code		ARRAY
PDO mapping		✓
Data type	0x00	Unsigned 8
	0x01 to 0x47	Unsigned 8
Access SDO	0x00	ro
	0x01 to 0x47	rw
Access PDO	0x01 to 0x47	r
Default value	0x00	-
	0x01 to 0x47	-

Structure of the data bytes

Sub-index 0x00 ≤ n ≤ 0x47	Byte	Bit 7	Bit 6	Bit 5	Bit 4	Bit 3	Bit 2	Bit 1	Bit 0 (lsb)
n = CNT1	0	reserved	CNT1_SINGLE	CNT1_SW_LR	CNT1_SFKT_DISABLE	reserved	CNT1_LOGMSG	CNT1_ENABLE	CNT1_GENERAL_DISABLE
n + 1 = CNT2	0	reserved	CNT2_SINGLE	CNT2_SW_LR	CNT2_SFKT_DISABLE	reserved	CNT2_LOGMSG	CNT2_ENABLE	CNT2_GENERAL_DISABLE



Note

A more detailed description of the module's control bits can be found in the field bus independent module description (Chapter 3, section Process output / control interface (page 32)).

11 Representation of the XNE-2CNT-2PWM in CANopen

11.1 Objects for counter modules

Object 5810_{hex} – Encoder Load Prepare Value

The object 5810_{hex} contains the load value (load value register, CNT1 no. 0×23, CNT2 no. 0×43) for the "prepared loading" of the counters. Setting the counter's count value to this value is event-driven.

Table 32:
Object 5810_{hex}

Feature	Sub-index	Description
Name		Encoder Load Prepare Value
Object code		ARRAY
PDO mapping		-
Data type	0×00	Unsigned 8
	0×01 to 0×47	Integer 32
Access SDO	0×00	ro
	0×01 to 0×47	rw
Default value	0×00	-
	0×01 to 0×47	-

Structure of the data bytes

Sub-index	Byte	Description	Register	Register no.
0×00 ≤ n ≤ 0×47				
n = CNT1	0 to 3	load value register of CNT1 (Register interface (page 91))	REG_CNT1_LOADVAL (page 93)	0×23
n + 1 = CNT2	0 to 3	load value register of CNT2 (Register interface (page 91))	REG_CNT2_LOADVAL (page 94)	0×43

11 Representation of the XNE-2CNT-2PWM in CANopen

11.1 Objects for counter modules

Object 5811_{hex} – Encoder Pulse Width

The object 5811_{hex} is used for setting the pulse duration. The time is set in 1 ms/bit.

Value range: 0 ms to 65535 ms (1 min 5 s).

In the module, the time is stored with a time base of 10 ms/bit. The gateway thus converts the value respectively.

Table 33:
Object 5811_{hex}

Feature	Sub-index	Description
Name		Encoder Pulse Width
Object code		ARRAY
PDO mapping		-
Data type	0x00	Unsigned 8
	0x01 to 0x47	Unsigned 16
Access	0x00	ro
	0x01 to 0x47	rw
Default value	0x00	-
	0x01 to 0x47	-

Structure of the data bytes

Sub-index	Byte	Description	Register	Register no.
$0x00 \leq n \leq 0x47$				
n = CNT1	0 to 3	register containing the pulse time for a pulse output at D1 (Register interface (page 91))	REG_CNT1_DO1_IMP (page 93)	0x30
n + 1 = CNT2	0 to 3	register containing the pulse time for a pulse output at D2 (Register interface (page 91))	REG_CNT2_DO2_IMP (page 94)	0x50

11 Representation of the XNE-2CNT-2PWM in CANopen

11.1 Objects for counter modules

Object 5820hex – Measuring Integration Time

The object 5820_{hex} is used to set the integration time for the counters.

For the Frequency measurement (page 53), Revolutions speed measurement (page 57) the integration time is entered in 10 ms/bit.

Feature	Sub-index	Description
Name		Measuring Integration Time
Object code		ARRAY
PDO mapping		-
Data type	0x00	Unsigned 8
	0x01 to 0x47	Unsigned 32
Access	0x00	ro
	0x01 to 0x47	rw
Default value	0x00	-
	0x01 to 0x47	-

Structure of the data bytes

Sub-index	Byte	Description	Register	Register no.
$0x00 \leq n \leq 0x47$				
n = CNT1	0 to 3	Integration time CNT1 10 ms/bit (Register interface (page 91))	REG_CNT1_INTIME (page 93)	0x29
n + 1 = CNT2	0 to 3	integration time CNT2 10 ms/bit (Register interface (page 91))	REG_CNT2_INTIME (page 94)	0x49

11 Representation of the XNE-2CNT-2PWM in CANopen

11.1 Objects for counter modules

Object 5824_{hex} – Encoder Measuring Divisor

The object 5824_{hex} is used for scaling the measured value (→ see also Additional function: Measurement mode (page 52)).

Table 35:
Object 5824_{hex}

Feature	Sub-index	Description
Name		Encoder Measuring Divisor
Object code		ARRAY
PDO mapping		-
Data type	0x00	Unsigned 8
	0x01 to 0x47	Unsigned 32
Access	0x00	ro
	0x01 to 0x47	rw
Default value	0x00	-
	0x01 to 0x47	-

Structure of the data bytes

Sub-index	Byte	Description	Register	Register no.
0x00 ≤ n ≤ 0x47				
n = CNT1	0 to 3	Divisor CNT1 (Register interface (page 91))	REG_CNT1_DIV (page 93)	0x2B
n + 1 = CNT2	0 to 3	Divisor CNT2 (Register interface (page 91))	REG_CNT2_DIV (page 94)	0x4B

11 Representation of the XNE-2CNT-2PWM in CANopen

11.1 Objects for counter modules

Object 5825hex – Encoder Measuring Factor

The object 5825_{hex} is used for scaling the measured value (→ see also Additional function: Measurement mode (page 52)).

Table 36:
Object 5825_{hex}

Feature	Sub-index	Description
Name		Encoder Measuring Factor
Object code		ARRAY
PDO mapping		-
Data type	0x00	Unsigned 8
	0x01 to 0x47	Unsigned 32
Access	0x00	ro
	0x01 to 0x47	rw
Default value	0x00	-
	0x01 to 0x47	-

Structure of the data bytes

Sub-index	Byte	Description	Register	Register no.
0x00 ≤ n ≤ 0x47				
n = CNT1	0 to 3	Factor CNT1 (Register interface (page 91))	REG_CNT1_MUL (page 93)	0x2A
n + 1 = CNT2	0 to 3	Factor CNT2 (Register interface (page 91))	REG_CNT2_MUL (page 94)	0x4A

11 Representation of the XNE-2CNT-2PWM in CANopen

11.1 Objects for counter modules

Object 5827hex – Encoder Measuring Time Out

The object 5827_{hex} defines the time out (in 10 ms/bit), after which a message (Object 5803hex (page 112) MSG_CNTx_FQE) is generated in period duration measurement.

Table 37:
Object 5827_{hex}

Feature	Sub-index	Description
Name		Encoder Measuring Time Out
Object code		ARRAY
PDO mapping		-
Data type	0x00	Unsigned 8
	0x01 to 0x47	Unsigned 32
Access	0x00	ro
	0x01 to 0x47	rw
Default value	0x00	-
	0x01 to 0x47	-

Structure of the data bytes

Sub-index	Byte	Description	Register	Register no.
0x00 ≤ n ≤ 0x47				
n = CNT1	0 to 3	time out CNT1 in 10 ms/bit (Register interface (page 91))	REG_CNT1_TO (page 93)	0x2D
n + 1 = CNT2	0 to 3	time out CNT2 in 10 ms/bit (Register interface (page 91))	REG_CNT2_TO (page 94)	0x4D

Object 5830hex – Encoder Measuring Value

The object 5830_{hex} reads the measured value of the counters CNTx.

Table 38:
Object 5830_{hex}

Feature	Sub-index	Description
Name		Encoder Measuring Value
Object code		ARRAY
PDO mapping		-
Data type	0x00	Unsigned 8
	0x01 to 0x47	Unsigned 32
Access	0x00	ro
	0x01 to 0x47	ro
Default value	0x00	-
	0x01 to 0x47	-

Structure of the data bytes

Sub-index	Byte	Description	Register	Register no.
0x00 ≤ n ≤ 0x47				
n = CNT1	0 to 3	measured value CNT1 (Register interface (page 91))	REG_CNT1_MV (page 93)	0x21
n + 1 = CNT2	0 to 3	Measured value CNT2 (Register interface (page 91))	REG_CNT2_MV (page 94)	0x41

11 Representation of the XNE-2CNT-2PWM in CANopen

11.1 Objects for counter modules

Object 5831_{hex} – Encoder Latch Value

The object 5831_{hex} reads the value of the latch register for the counters CNT_x.

Table 39:
Object 5831_{hex}

Feature	Sub-index	Description
Name		Encoder Latch Value
Object code		ARRAY
PDO mapping		-
Data type	0x00	Unsigned 8
	0x01 to 0x47	Unsigned 32
Access	0x00	ro
	0x01 to 0x47	ro
Default value	0x00	-
	0x01 to 0x47	-

Structure of the data bytes

Sub-index	Byte	Description	Register	Register no.
0x00 ≤ n ≤ 0x47				
n = CNT1	0 to 3	buffer CNT1 (Register interface (page 91))	REG_CNT1_LATCH (page 93)	0x28
n + 1 = CNT2	0 to 3	buffer CNT2 (Register interface (page 91))	REG_CNT2_LATCH (page 94)	0x48

11 Representation of the XNE-2CNT-2PWM in CANopen

11.1 Objects for counter modules

Object 5901hex – PWM Config

The object 5901_{hex} affects the configuration parameters of PWMx:

Write accesses initiate a parameter update via the internal module bus of the XI/ON station. The parameter is stored as a non-volatile parameter in the XI/ON gateway and is restored with every node reset.

Feature	Sub-index	Description
Name		PWM Config
Object code		ARRAY
PDO mapping		-
Data type	0x00	Unsigned 8
	0x01 to 0x47	Unsigned 32
Access	0x00	ro
	0x01 to 0x47	rw
Default value	0x00	-
	0x01 to 0x47	-

Structure of the data bytes

Sub-index 0x00 ≤ n ≤ 0x47	Byte	Bit 7	Bit 6	Bit 5	Bit 4	Bit 3	Bit 2	Bit 1	Bit 0 (lsb)
n = PWM1	0	diagnostic PWM1	X	mode D1 (0x3F)					
	1	Bit 15	Bit 14	Bit 13	Bit 12	Bit 11	Bit 10	Bit 9	Bit 8
		DBP1 STS MODE (0x00)		substitute value P1 (0x00)	substitute value D1 (0x00)	mode PWM1 (0x00)			
	2	Bit 23	Bit 22	Bit 21	Bit 20	Bit 19	Bit 18	Bit 17	Bit 16
		X							
	3	Bit 31 (msb)	Bit 30	Bit 29	Bit 28	Bit 27	Bit 26	Bit 25	Bit 24
X		ADR AUX REG1 WR DATA (0x60)							

11 Representation of the XNE-2CNT-2PWM in CANopen

11.1 Objects for counter modules

Sub-index $0 \times 00 \leq n \leq 0 \times 47$	Byte	Bit 7	Bit 6	Bit 5	Bit 4	Bit 3	Bit 2	Bit 1	Bit 0 (lsb)
n + 1 = PWM2	0	diagnostic PWM2	X	mode D2 (0x3F)					
	1	Bit 15	Bit 14	Bit 13	Bit 12	Bit 11	Bit 10	Bit 9	Bit 8
		DBP2 STS MODE (0x00)		substitute value P2 (0x00)	substitute value D2 (0x00)	mode PWM2 (0x00)			
	2	Bit 23	Bit 22	Bit 21	Bit 20	Bit 19	Bit 18	Bit 17	Bit 16
		X							
	3	Bit 31 (msb)	Bit 30	Bit 29	Bit 28	Bit 27	Bit 26	Bit 25	Bit 24
X		ADR AUX REG3 WR DATA (0x70)							

() = default parameterization



Note

A more detailed description of the module's parameter data can be found in the field bus independent module description (Chapter 3, section Parameter data of the module (page 25)).

11 Representation of the XNE-2CNT-2PWM in CANopen

11.1 Objects for counter modules

Object 5902_{hex} – PWM Status

The object 5902_{hex} supplies the following status messages:

- output status
- operation status of the PWM

Table 41:
Object 5902_{hex}

Feature	Sub-index	Description
Name		PWM Status
Object code		ARRAY
PDO mapping		✓
Data type	0x00	Unsigned 8
	0x01 to 0x47	Unsigned 8
Access	0x00	ro
	0x01 to 0x47	ro
Default value	0x00	-
	0x01 to 0x47	-

Structure of the data byte

Sub-index 0x00 ≤ n ≤ 0x47	Byte	Bit 7	Bit 6	Bit 5	Bit 4	Bit 3	Bit 2	Bit 1	Bit 0
n = PWM1	0	X	X	STS_ DBP1	D1	STS_ PWM1_ LOGMSG	STS_ PWM1_ SFKT_EN	STS_ PWM1_ RUN	STS_ PWM1_ GENERAL_ EN
n + 1 = PWM2	0	X	X	STS_ DBP2	D2	STS_ PWM2_ LOGMSG	STS_ PWM2_ SFKT_EN	STS_ PWM2_ RUN	STS_ PWM2_ GENERAL_ EN



Note

A more detailed description of the module's messages can be found in the field bus independent module description (Chapter 3, section Process input / check-back interface (page 28)).

11 Representation of the XNE-2CNT-2PWM in CANopen

11.1 Objects for counter modules

Object 5903hex – PWM Flags

The object 5903_{hex} supplies the following status messages:

- execution of a SW latch retrigger
- zero-crossing of the counter for the signal output
- an event defined as special function (SFKT) has occurred
- PWM output error

Table 42:
Object 5903_{hex}

Feature	Sub-index	Description
Name		PWM Flags
Object code		ARRAY
PDO mapping		✓
Data type	0x00	Unsigned 8
	0x01 to 0x47	Unsigned 8
Access SDO	0x00	ro
	0x01 to 0x47	rw
Access PDO	0x01 to 0x47	r
Default value	0x00	-
	0x01 to 0x47	-



Note

By means of this access, the messages are reset automatically after reading.

Structure of the data byte

Sub-index 0x00 ≤ n ≤ 0x47	Byte	Bit 7	Bit 6	Bit 5	Bit 4	Bit 3	Bit 2	Bit 1	Bit 0
n = PWM1	0	X	X	X	X	MSG_ PWM1_ DO_ERR	MSG_ PWM1_ SFKT	MSG_ PWM1_ NDDC	MSG_ PWM1_ SW_LR
n + 1 = PWM2	0	X	X	X	X	MSG_ PWM2_ DO_ERR	MSG_ PWM2_ SFKT	MSG_ PWM2_ NDDC	MSG_ PWM2_ SW_LR



Note

A more detailed description of the module's messages can be found in the field bus independent module description (Chapter 3, section Process input / check-back interface (page 28)).

11 Representation of the XNE-2CNT-2PWM in CANopen

11.1 Objects for counter modules

Object 5904hex – PWM Diag

The object 5904_{hex} reads the module's diagnostic byte.

Table 43:
Object 5904_{hex}

Feature	Sub-index	Description
Name		PWM Diag
Object code		ARRAY
PDO mapping		-
Data type	0x00	Unsigned 8
	0x01 to 0x47	Unsigned 8
Access	0x00	ro
	0x01 to 0x47	ro
Default value	0x00	-
	0x01 to 0x47	-



Note

By means of this access, the messages are reset automatically after reading.

Structure of the data byte

The meaning of the diagnostic bits generally corresponds to the general description of the module (→ see Diagnostic data of the module).

Sub-index	Byte	Bit 7	Bit 6	Bit 5	Bit 4	Bit 3	Bit 2	Bit 1	Bit 0
0x00 ≤ n ≤ 0x47									
n = PWM1	0	HW_ERR	PWM1_ PAR_ERR	X	X	X	X	P1_DIAG	D1_DIAG
n + 1 = PWM2	0	HW_ERR	PWM2_ PAR_ERR	X	X	X	X	P2_DIAG	D2_DIAG



Note

A more detailed description of the module's diagnostic data can be found in the field bus independent module description (Chapter 3, section Diagnostic data of the module (page 24)).

11 Representation of the XNE-2CNT-2PWM in CANopen

11.1 Objects for counter modules

Object 5908hex – PWM Control

The object 5908_{hex} provides the following control functions for the PWMx:

- general enabling or disabling of the PWM function
- start/stop of the signal output
- storing of Error messages of the module (page 85) for readout without data loss
- enabling or disabling of the special function
- executing a software latch retrigger
- Setting the single/continuous signal output

Table 44:
Object 5908_{hex}

Feature	Sub-index	Description
Name		PWM Control
Object code		ARRAY
PDO mapping		✓
Data type	0x00	Unsigned 8
	0x01 to 0x47	Unsigned 16
Access SDO	0x00	ro
	0x01 to 0x47	rw
Access PDO	0x01 to 0x47	r
Default value	0x00	-
	0x01 to 0x47	-



Note

By means of this access, the messages are reset automatically after reading.

11 Representation of the XNE-2CNT-2PWM in CANopen

11.1 Objects for counter modules

Structure of the data byte

The meaning of the diagnostic bits generally corresponds to the general description of the module (→ see Diagnostic data of the module).

Sub-index $0 \times 00 \leq n \leq 0 \times 47$	Byte	Bit 7	Bit 6	Bit 5	Bit 4	Bit 3	Bit 2	Bit 1	Bit 0 (lsb)
n = PWM1	0	X	PWM1_ SINGLE	PWM1_ SW_LR	PWM1_ SFKT_ DISABLE	X	PWM1_ LOGMSG	PWM1_ ENABLE	PWM1_ GENERAL_D ISABLE
	1	Bit 15 (msb)	Bit 14	Bit 13	Bit 12	Bit 11	Bit 10	Bit 9	Bit 8
		X	X	X	X	X	X	X	SET_P1
n + 1 = PWM2	0	X	PWM2_ SINGLE	PWM2_ SW_LR	PWM2_ SFKT_ DISABLE	X	PWM2_ LOGMSG	PWM2_ ENABLE	PWM2_ GENERAL_D ISABLE
	1	Bit 15 (msb)	Bit 14	Bit 13	Bit 12	Bit 11	Bit 10	Bit 9	Bit 8
		X	X	X	X	X	X	X	SET_P2



Note

A more detailed description of the module's control bits can be found in the field bus independent module description (Chapter 3, section Process output / control interface (page 32)).

11 Representation of the XNE-2CNT-2PWM in CANopen

11.1 Objects for counter modules

Object 5910_{hex} – PWM Load Prepare Value

The object 5910_{hex} contains the load value (load value register, PWM1 no. 0x64, PWM2 no. 0x74) for the "prepared loading" of the counters. Setting the count value of the signals to be given out to this value is event-driven.

Table 45:
Object 5910_{hex}

Feature	Sub-index	Description
Name		PWM Load Prepare Value
Object code		ARRAY
PDO mapping		-
Data type	0x00	Unsigned 8
	0x01 to 0x47	Integer 32
Access	0x00	ro
	0x01 to 0x47	rw
Default value	0x00	-
	0x01 to 0x47	-

Structure of the data bytes

Sub-index	Byte	Description	Register	Register no.
0x00 ≤ n ≤ 0x47				
n = PWM1	0 to 3	load value register of PWM1 (Register interface (page 91))	REG_PWM1_CNTSV (page 95)	0x64
n + 1 = PWM2	0 to 3	load value register of PWM2 (Register interface (page 91))	REG_PWM2_CNTSV (page 96)	0x74

Object 5913hex – PWM Duty Cycle

The object 5913_{hex} is used to set the duty cycle of the PWM pulse.

Table 46:
Object 5913_{hex}

Feature	Sub-index	Description
Name		PWM Duty Cycle
Object code		ARRAY
PDO mapping		-
Data type	0x00	Unsigned 8
	0x01 to 0x47	Integer 32
Access	0x00	ro
	0x01 to 0x47	rw
Default value	0x00	-
	0x01 to 0x47	-

Structure of the data bytes

Sub-index	Byte	Description	Register	Register no.
0x00 ≤ n ≤ 0x47				
n = PWM1	0 to 3	Mark-to-space ratio PWM1, (Register interface (page 91))	REG_PWM1_DC (page 95)	0x61
n + 1 = PWM2	0 to 3	Mark-to-space ratio PWM2, (Register interface (page 91))	REG_PWM2_DC (page 96)	0x71

**Note**

See also, Chapter 5, Period Duration / Duty Cycle Definition (page 61).

11 Representation of the XNE-2CNT-2PWM in CANopen

11.1 Objects for counter modules

Object 5920hex – PWM Period Duration

The object 5920_{hex} contains the value for the period duration of the PWM.

Table 47:
Object 5920_{hex}

Feature	Sub-index	Description
Name		PWM Period Duration
Object code		ARRAY
PDO mapping		✓
Data type	0x00	Unsigned 8
	0x01 to 0x47	Integer 32
Access SDO	0x00	ro
	0x01 to 0x47	rw
Access PDO	0x01 to 0x47	rw
Default value	0x00	-
	0x01 to 0x47	-

Structure of the data bytes

Sub-index	Byte	Description	Register	Register no.
0x00 ≤ n ≤ 0x47				
n = PWM1	0 to 3	Period duration of PWM1 (Register interface (page 91))	REG_PWM1_PD (page 95)	0x60
n + 1 = PWM2	0 to 3	Period duration of PWM2 (Register interface (page 91))	REG_PWM2_PD (page 96)	0x70



Note

See also Chapter 5, Period Duration / Duty Cycle Definition (page 61).

Object 5931hex – PWM Latch Value

The object 5931_{hex} reads the value of the latch register for the PWMx.

Table 48: Object 5931 _{hex}	Feature	Sub-index	Description
	Name		PWM Latch Value
	Object code		ARRAY
	PDO mapping		-
	Data type	0x00	Unsigned 8
		0x01 to 0x47	Unsigned 32
	Access	0x00	ro
		0x01 to 0x47	ro
	Default value	0x00	-
		0x01 to 0x47	-

Structure of the data bytes

Sub-index	Byte	Description	Register	Register no.
0x00 ≤ n ≤ 0x47				
n = PWM1	0 to 3	Buffer PWM1 (Register interface (page 91))	REG_PWM1_LATCH (page 95)	0x66
n + 1 = PWM2	0 to 3	Buffer PWM2 (Register interface (page 91))	REG_PWM2_LATCH (page 96)	0x76

11 Representation of the XNE-2CNT-2PWM in CANopen

11.1 Objects for counter modules

Object 6810hex – Preset Value For Multi-Sensor Devices

This object is used to adapt the encoder zero-point to the mechanical zero-point of the system. The object 6810hex (corresponds to object 6010hex in accordance with CiA DS-406) directly writes the counter value for the counter..

Table 49:
Object 6810_{hex}

Feature	Sub-index	Description
Name		Preset Value For Multi-Sensor Devices
Object code		ARRAY
PDO mapping		-
Data type	0x00	Unsigned 8
	0x01 to 0x47	Unsigned 32
Access	0x00	ro
	0x01 to 0x47	rw
Default value	0x00	-
	0x01 to 0x47	-

Structure of the data bytes

Sub-index	Byte	Description	Register	Register no.
0x00 ≤ n ≤ 0x47				
n = CNT1	0 to 3	Actual binary value of the CNT1 (Register interface (page 91))	REG_CNT1_CNT (page 93)	0x20
n + 1 = CNT2	0 to 3	Actual binary value of the CNT2 (Register interface (page 91))	REG_CNT1_CNT (page 93)	0x40

11 Representation of the XNE-2CNT-2PWM in CANopen

11.1 Objects for counter modules

Object 6820hex – Position Value For Multi-Sensor Devices

The object 6820hex (corresponds to object 6020hex in accordance with CiA DS-406) contains the counter's counter value. .

Table 50:
Object 6820_{hex}

Feature	Sub-index	Description
Name		Preset Value For Multi-Sensor Devices
Object code		ARRAY
PDO mapping		✓
Data type	0x00	Unsigned 8
	0x01 to 0x47	Unsigned 32
Access	0x00	ro
	0x01 to 0x47	rw
Default value	0x00	-
	0x01 to 0x47	-

Structure of the data bytes

Sub-index	Byte	Description	Register	Register no.
0x00 ≤ n ≤ 0x47				
n = CNT1	0 to 3	Actual binary value of the CNT1 (Register interface (page 91))	REG_CNT1_CNT (page 93)	0x20
n + 1 = CNT2	0 to 3	Actual binary value of the CNT2 (Register interface (page 91))	REG_CNT1_CNT (page 93)	0x40

11 Representation of the XNE-2CNT-2PWM in CANopen

11.1 Objects for counter modules

Object 6B00hex – CAM 1 State Register

The object 6B00_{hex} (corresponds to object 6300_{hex} in accordance with CiA DS-406) indicates whether the counter status is within a specified range. This range is limited by CAM1 Low Limit (object 6B10_{hex}) and CAM1 High Limit (object 6B20_{hex}).

Table 51:
Object 6B00_{hex}

Feature	Sub-index	Description
Name		CAM 1 State Register
Object code		ARRAY
PDO mapping		✓
Data type	0x00	Unsigned 8
	0x01 to 0x47	Unsigned 8
Access	0x00	ro
	0x01 to 0x47	ro
Default value	0x00	-
	0x01 to 0x47	-

The following applies:

STS_DBPx = 1

at $(REG_CNTx_CMP0) \leq (REG_CNTx_CNT) < (REG_CNTx_CMP1)$

Structure of the data byte

Sub-index $0x00 \leq n \leq 0x47$	Byte	Bit 7	Bit 6	Bit 5	Bit 4	Bit 3	Bit 2	Bit 1	Bit 0 (lsb)
n = CNT1	0	X	X	X	X	X	X	X	STAT_ CAM1(STS_ DBP1)
n + 1 = CNT2	0	X	X	X	X	X	X	X	STAT_ CAM2(STS_ DBP2)



Note

The function is only given, if DBPx STS MODE = 00 is parameterized (→ see Parameter data of the module (page 25)).

11 Representation of the XNE-2CNT-2PWM in CANopen

11.1 Objects for counter modules

Object 6B01hex – CAM 1 Enable Register

The object 6B01_{hex} activates or deactivates the status message concerning the comparison result (object Object 6B00hex – CAM 1 State Register).

Table 52:
Object 6B01_{hex}

Feature	Sub-index	Description
Name		CAM 1 Enable Register
Object code		ARRAY
PDO mapping		-
Data type	0x00	Unsigned 8
	0x01 to 0x47	Unsigned 8
Access	0x00	ro
	0x01 to 0x47	rw
Default value	0x00	-
	0x01 to 0x47	-

Function setting for the special functions of the outputs.

Structure of the data byte

Sub-index 0x00 ≤ n ≤ 0x47	Byte	Bit 7	Bit 6	Bit 5	Bit 4	Bit 3	Bit 2	Bit 1	Bit 0 (lsb)
n = CNT1	0	X	X	X	X	X	X	X	EN_CAM1
n + 1 = CNT2	0	X	X	X	X	X	X	X	EN_CAM2

11 Representation of the XNE-2CNT-2PWM in CANopen

11.1 Objects for counter modules

Object 6B02hex – CAM1 Polarity Register

The object 6B02_{hex} can invert the status message for the comparison result (Object 6B00hex – CAM 1 State Register).

Feature	Sub-index	Description
Name		CAM1 Polarity Register
Object code		ARRAY
PDO mapping		-
Data type	0x00	Unsigned 8
	0x01 to 0x47	Unsigned 8
Access	0x00	ro
	0x01 to 0x47	rw
Default value	0x00	-
	0x01 to 0x47	-

Function setting for the special functions of the outputs.

Structure of the data byte

Sub-index 0x00 ≤ n ≤ 0x47	Byte	Bit 7	Bit 6	Bit 5	Bit 4	Bit 3	Bit 2	Bit 1	Bit 0 (lsb)
n = CNT1	0	X	X	X	X	X	X	X	POL_ CAM1
n + 1 = CNT2	0	X	X	X	X	X	X	X	POL_ CAM2

11 Representation of the XNE-2CNT-2PWM in CANopen

11.1 Objects for counter modules

Object 6B10hex – CAM 1 Low Limit

The object 6B10_{hex} contains the compare value CMP0 of the counter module (→ see also Function of the CMPx compare registers (page 38)).

The object corresponds to object 6310_{hex} in accordance with CiA DS-406.

Table 54:
Object 6B10_{hex}

Feature	Sub-index	Description
Name		CAM 1 Low Limit
Object code		ARRAY
PDO mapping		-
Data type	0x00	Unsigned 8
	0x01 to 0x47	Unsigned 32
Access	0x00	ro
	0x01 to 0x47	rw
Default value	0x00	-
	0x01 to 0x47	-

Structure of the data bytes

Sub-index	Byte	Description	Register	Register no.
0x00 ≤ n ≤ 0x47				
n = CNT1	0 to 3	compare value 0 of CNT1 (Register interface (page 91))	REG_CNT1_CMP0 (page 93)	0x26
n + 1 = CNT2	0 to 3	compare value 0 of CNT2 (Register interface (page 91))	REG_CNT2_CMP0 (page 94)	0x46



Note

If a compare value is loaded which is outside the count limits, the value is transferred and an error message is generated in REG_CONFIG_ERRSTS (Error messages in REG_CONFIG_ERRSTS for the count operation mode (CNT1 and CNT2) (page 81)).

11 Representation of the XNE-2CNT-2PWM in CANopen

11.1 Objects for counter modules

Object 6B20hex – CAM 1 High Limit

The object 6B20_{hex} contains the compare value CMP1 of the counter module (→ see also Function of the CMPx compare registers (page 38)).

The object corresponds to object 6320_{hex} in accordance with CiA DS-406.

Table 55:
Object 6B20_{hex}

Feature	Sub-index	Description
Name		CAM 1 High Limit
Object code		ARRAY
PDO mapping		-
Data type	0x00	Unsigned 8
	0x01 to 0x47	Unsigned 32
Access	0x00	ro
	0x01 to 0x47	rw
Default value	0x00	-
	0x01 to 0x47	-

Structure of the data bytes

Sub-index	Byte	Description	Register	Register no.
0x00 ≤ n ≤ 0x47				
n = CNT1	0 to 3	compare value 1 of CNT1 (Register interface (page 91))	REG_CNT1_CMP1 (page 93)	0x27
n + 1 = CNT2	0 to 3	compare value 1 of CNT2 (Register interface (page 91))	REG_CNT2_CMP1 (page 94)	0x47



Note

If a compare value is loaded which is outside the count limits, the value is transferred and an error message is generated in REG_CONFIG_ERRSTS (Error messages in REG_CONFIG_ERRSTS for the count operation mode (CNT1 and CNT2) (page 81)).

11 Representation of the XNE-2CNT-2PWM in CANopen

11.1 Objects for counter modules

Object 6B30hex – CAM 1 Hysteresis

The object 6B30_{hex} defines the hysteresis value for compare value CMP0 and CMP1 which affects the digital output Dx assigned to the counter and the STS_DBP_x.

The object corresponds to object 6330_{hex} in accordance with CiA DS-406. .



Note

See Chapter 6, Special functions of the outputs Dx: Pulse output defined by a hysteresis (page 79).

Table 56:
Object 6B31_{hex}

Feature	Sub-index	Description
Name		CAM 1 Hysteresis
Object code		ARRAY
PDO mapping		-
Data type	0x00	Unsigned 8
	0x01 to 0x47	Unsigned 16
Access	0x00	ro
	0x01 to 0x47	rw
Default value	0x00	-
	0x01 to 0x47	-

Structure of the data bytes

Sub-index	Byte	Description	Register	Register no.
0x00 ≤ n ≤ 0x47				
n = CNT1	0 to 1	hysteresis of the D0 and STS_DBP1 for CNT1 (Register interface (page 91))	REG_CNT1_DO1_HYS (page 93)	0x2F
n + 1 = CNT2	0 to 1	hysteresis of the D2 and STS_DBP2 for CNT2 (Register interface (page 91))	REG_CNT2_DO1_HYS (page 94)	0x4F

11 Representation of the XNE-2CNT-2PWM in CANopen

11.1 Objects for counter modules

Object 6C00hex – Area State Register

Object 6C00_{hex} contains two status bits that indicate the count value falling below the lower count limit (Object 6C01hex – Work Area Low Limit (page 145)) and exceeding the upper count limit (Object 6C02hex – Work Area High Limit (page 146)).

The status bits are non-volatile. All status messages are reset by writing Object 5803hex – Encoder Flags (page 112) with any value. Object 5803_{hex} contains the redundant status information.

The object corresponds to object 6400_{hex} in accordance with CiA DS-406. .



Note

See Chapter 6, Special functions of the outputs Dx: Pulse output defined by a hysteresis (page 79).

Table 57:
Object 6C00_{hex}

Feature	Sub-index	Description
Name		Area State Register
Object code		ARRAY
PDO mapping		-
Data type	0x00	Unsigned 8
	0x01 to 0x47	Unsigned 8
Access	0x00	ro
	0x01 to 0x47	ro
Default value	0x00	-
	0x01 to 0x47	-

Structure of the data byte

Sub-index $0x00 \leq n \leq 0x47$	Byte	Bit 7	Bit 6	Bit 5	Bit 4	Bit 3	Bit 2	Bit 1	Bit 0 (lsb)
$n = \text{CNT1}$	0	X	X	X	X	X	MSG_ CNT1_ UFLW	MSG_ CNT1_ OFLW	X
$n + 1 = \text{CNT2}$	0	X	X	X	X	X	MSG_ CNT2_ UFLW	MSG_ CNT2_ OFLW	X



Note

A more detailed description of the module's messages can be found in the field bus independent module description (Chapter 3, section Process input / check-back interface (page 28)).

11 Representation of the XNE-2CNT-2PWM in CANopen

11.1 Objects for counter modules

Object 6C01hex – Work Area Low Limit

The object 6C01_{hex} defines the value for the lower count limit (→ see also Set count limits (page 36)).

In the event of an underflow, bit 2 in Object 6C00hex – Area State Register (page 144) and bit 6 in Object 5803hex – Encoder Flags (page 112) are set.

The object corresponds to object 6401_{hex} in accordance with CiA DS-406.

Table 58:
Object 6C01_{hex}

Feature	Sub-index	Description
Name		Work Area Low Limit
Object code		ARRAY
PDO mapping		-
Data type	0x00	Unsigned 8
	0x01 to 0x47	Unsigned 32
Access	0x00	ro
	0x01 to 0x47	rw
Default value	0x00	-
	0x01 to 0x47	-

Structure of the data bytes

Sub-index	Byte	Description	Register	Register no.
0x00 ≤ n ≤ 0x47				
n = CNT1	0 to 3	lower count limit of CNT1 (Register interface (page 91))	REG_CNT1_LOLIMIT (page 93)	0x24
n + 1 = CNT2	0 to 3	lower count limit of CNT2 (Register interface (page 91))	REG_CNT2_LOLIMIT (page 94)	0x44



Note

If the count limits are loaded with $(REG_CNTx_HILIMIT) \leq (REG_CNTx_LOLIMIT)$, the value is transferred and an error message is recorded in the REG_CONFIG_ERRSTS (CNTx) (page 81).

If a count limit is set so that the actual count value is outside the count range, the current value is set to the count limit which is closest to it. In this case *no* error message is recorded in register REG_CONFIG_ERRSTS.

11 Representation of the XNE-2CNT-2PWM in CANopen

11.1 Objects for counter modules

Object 6C02hex – Work Area High Limit

The object 6C02_{hex} defines the value for the upepr count limit (→ see also Set count limits (page 36)).

In the event of an underflow, bit 1 in Object 6C00hex – Area State Register (page 144) and bit 5 Object 5803hex – Encoder Flags (page 112) are set.

The object corresponds to object 6402_{hex} in accordance with CiA DS-406.

Table 59:
Object 6C02_{hex}

Feature	Sub-index	Description
Name		Work Area High Limit
Object code		ARRAY
PDO mapping		-
Data type	0x00	Unsigned 8
	0x01 to 0x47	Unsigned 32
Access	0x00	ro
	0x01 to 0x47	rw
Default value	0x00	-
	0x01 to 0x47	-

Structure of the data bytes

Sub-index	Byte	Description	Register	Register no.
0x00 ≤ n ≤ 0x47				
n = CNT1	0 to 3	upper count limit of CNT1 (Register interface (page 91))	REG_CNT1_HILIMIT (page 93)	0x25
n + 1 = CNT2	0 to 3	upper count limit of CNT2 (Register interface (page 91))	REG_CNT2_HILIMIT (page 94)	0x45



Note

If the count limits are loaded with $(REG_CNTx_HILIMIT) \leq (REG_CNTx_LOLIMIT)$, the value is transferred and an error message is recorded in the REG_CONFIG_ERRSTS (CNTx) (page 81).

If a count limit is set so that the actual count value is outside the count range, the current value is set to the count limit which is closest to it. In this case *no* error message is recorded in register REG_CONFIG_ERRSTS.

11 Representation of the XNE-2CNT-2PWM in CANopen

11.1 Objects for counter modules

Object 6FFF_{hex} – Device Type

The object 6FFF_{hex} specifies the type of the second device profile supported.

The object contains the value 0x 00 0A 01 96.

The low word (0x01 96 = 406_{dec}) specifies the device profile.

The high word (0x00 0A describes the encoder type in accordance with CiA DS-406 (10_{dec} = Multi Sensor Encoder Interface).

The object corresponds to object 67FF_{hex} in accordance with CiA DS-406.

Table 60:
Object 6FFF_{hex}

Feature	Sub-index	Description
Name		Device Type
Object code		VAR
PDO mapping		-
Data type	0x00	Unsigned 32
Access	0x00	ro

11 Representation of the XNE-2CNT-2PWM in CANopen

11.2 Emergencies of the XNE-2CNT-2PWM

11.2 Emergencies of the XNE-2CNT-2PWM

With the EMERGENCY 7010_{hex}, a "general module error in the station" is reported.

Additionally EMERGENCY 7011_{hex} defines precisely, if a change in the module's diagnostic data occurs. This EMERGENCY is sent with every change in module's diagnostic data..

Designation	Byte	0	1	2	3	4	5	6	7
		error code		error register	additional information				
General module error		7010 _{hex}		Bit 0 =1 Bit 7 = 1 (→ see Table 61)	0	0	0	0	0
Change of dia. (Change in bytes 0 to 3 of the diagnostic data)		7011 _{hex}			module no.	0	0	0	0

11.2.1 Structure of the emergency frames

XI/ON CANopen supports Emergency Frames (EMCY) as standardized in CiA DS-301.

The COB-IDs for the EMCY telegrams are defined by the Predefined Master-Slave Connection Set: COB-ID = 129 - 1 + Node-ID

In the event of a communication error, not only the Emergency Error Code but also the Error register and additional information will be transmitted, so that the error can be more precisely identified. Only a part of the 5 bytes is used for the additional information. The remaining bytes are then 0.

Error register

Table 61:
Bit assignment
of the XI/ON
Error register

A M =
mandatory
B O = optional

Error register	M/O	Meaning
Bit 0	M A	Generate the error message
Bit 1	O B	current error
Bit 2	0	voltage error
Bit 3	0	temperature error
Bit 4	0	communication error (overrun, error state)
Bit 5	0	device-profile-specific error
Bit 6	0	reserved
Bit 7	0	manufacturer-specific error

12 Appendix

12.1 Flow chart of a count operation

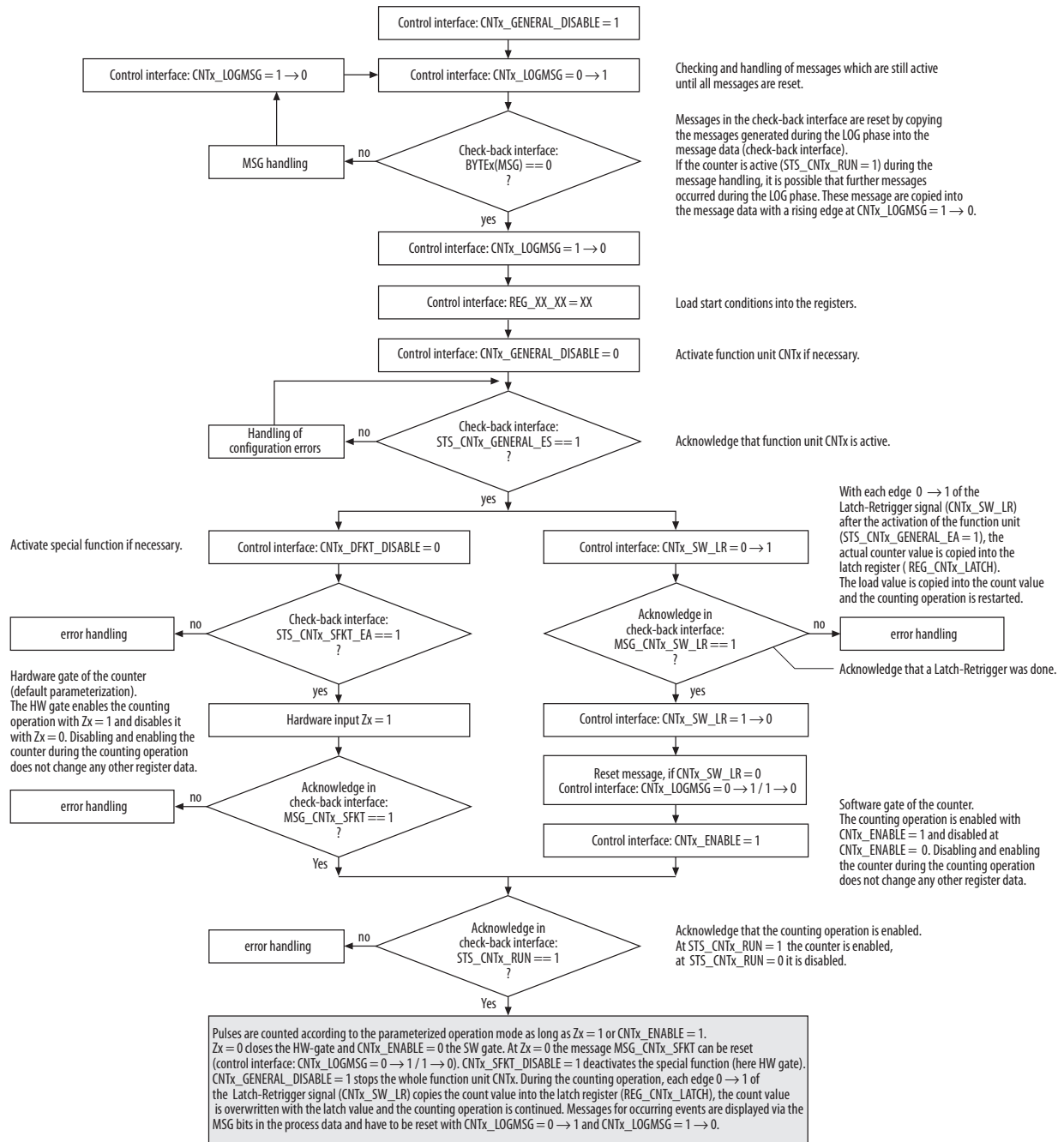

12 Appendix

12.2 Flow chart of a pulse output

12.2 Flow chart of a pulse output

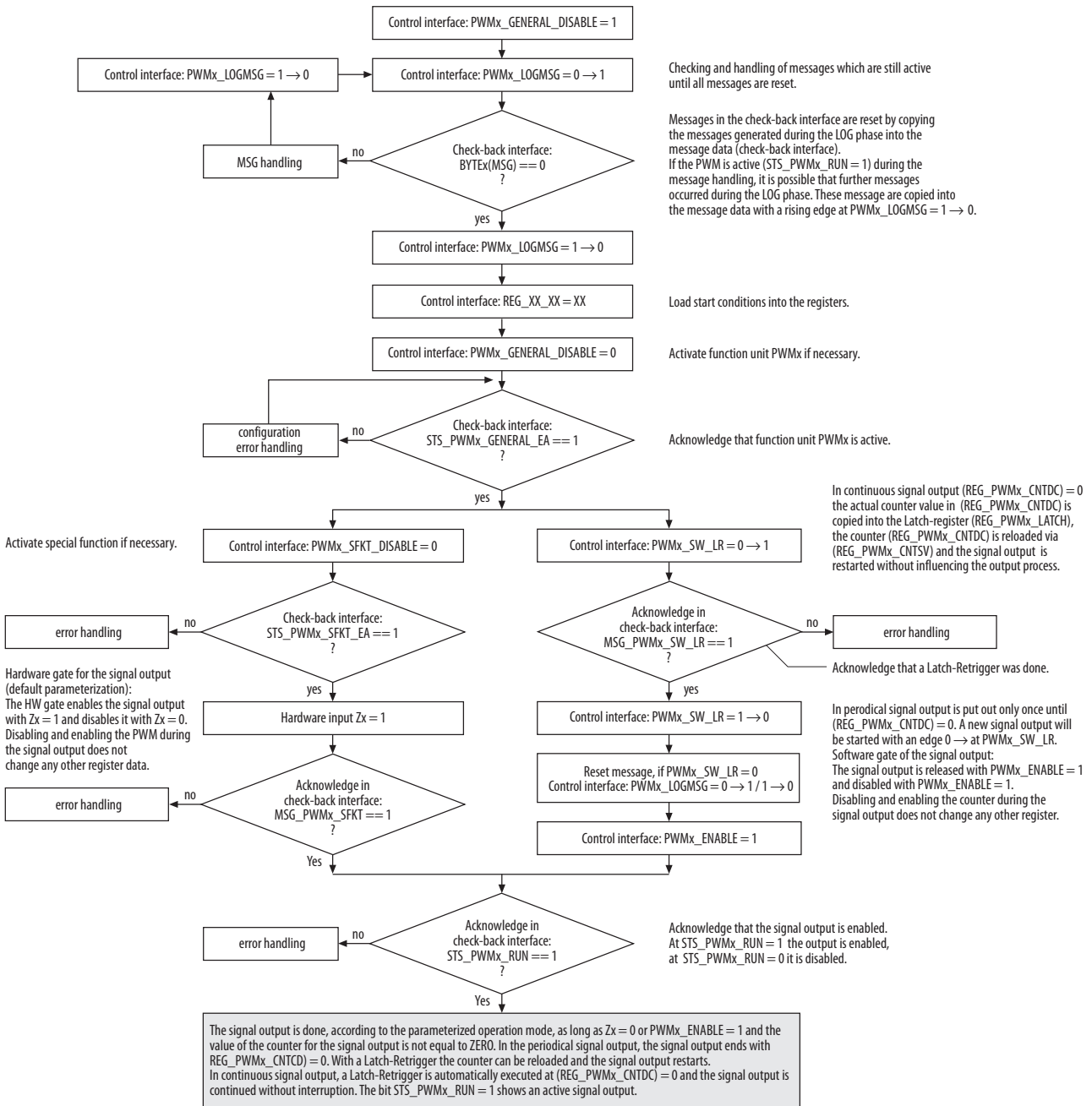

13 Index

A

additional documentation7

B

block diagram20

C

CANopen
 – EMCY148
 – emergency frame148
 – object overview107
 CNTx
 – AB mode44
 – additional functions52
 – basic functions35
 – Count function12
 – count inputs Ax and Bx42
 – downtime-monitoring58
 – Enabling12
 – enabling the counter37
 – frequency measurement53
 – function of inputs Z1 and Z245
 – function of the CMPx compare registers38
 – hardware (HW) latch retrigger38
 – latch retrigger (CNT)38
 – load count value35
 – load load value35
 – measurement mode52
 – operation modes11
 – period duration measurement55
 – periodical counting40
 – pulse and direction43
 – revolutions speed measurement57
 – set count limits36
 – single counting39
 – software (SW) latch retrigger38
 – special function Zx (CNT), HW gate47
 – special function Zx (CNT), synchr. (HW latch retrigger) 49
 CNTx_LOGMSG87
 configuration errors81
 count inputs11, 35
 count operation
 – flow chart149

D

diagnostic and status messages23
 diagnostic messages24

E

error handling85
 error messages85
 – CNTx81
 – PWMx83
 error register81, 148

F

function outputs75

L

latch retrigger, hardware49, 73
 latch retrigger, software50, 73

M

main count direction39, 40
 mode Dx75
 MSG85, 87
 – CNTx85

N

non-volatile flags85

O

object descriptions109
 objects
 – counter module107

P

parameter data25
 process data19, 28
 process input/ check-back interface28
 process output/ control interface32
 PROFIBUS-DPV1
 – process data99
 pulse output
 – defined by a hysteresis79
 – defined by time77
 – flow chart150
 PWM function15
 PWM outputs11, 59
 PWMx
 – basic functions59
 – continuous signal output65
 – duty cycle definition61
 – enabling15, 68
 – frequency modulation63
 – hardware (HW) latch retrigger69
 – High Time / Low Time definition63

13 Index

– latch retrigger (PWM)	69
– operation modes	11, 60
– period duration	61
– periodical signal output	67
– restart	59
– software (SW) latch retrigger	69
– special function Zx	71
– special function Zx (PWM), HW gate	71
– special function Zx, synchr. (HW latch retrigger) .	73
PWMx_LOGMSG	87

R

REG_CNTx_LOGMSG	87
REG_CONFIG_ERRSTS	81
REG_PWMx_LOGMSG	87
register	89
– CNT1	93
– CNT2	94
– PWM1	95
– PWM2	96
– read access	90
– standard	91

– write access	89
register access	91
register interface	17, 91
representation	
– CANopen	107
– PROFIBUS-DPV1	99

S

shadow register	87
storage of messages	87
STS	85
synchronization	49

T

technical data	21
----------------------	----

V

volatile status messages	85
--------------------------------	----

W

wiring diagram	22
----------------------	----