

USER MANUAL

PRODUCT MODEL : **DWS-3000 SERIES**
DWL-3500AP/8500AP

UNIFIED WIRED & WIRELESS ACCESS SYSTEM
RELEASE 1

Information in this document is subject to change without notice.

© 2007 D-Link Computer Corporation. All rights reserved.

Reproduction in any manner whatsoever without the written permission of D-Link Computer Corporation is strictly forbidden.

Trademarks used in this text: D-Link and the D-Link logo are trademarks of D-Link Computer Corporation; Microsoft and Windows are registered trademarks of Microsoft Corporation.

Other trademarks and trade names may be used in this document to refer to either the entities claiming the marks and names or their products. D-Link Computer Corporation disclaims any proprietary interest in trademarks and trade names other than its own.

FCC Warning

This equipment has been tested and found to comply with the limits for a Class A digital device, pursuant to Part 15 of the FCC Rules. These limits are designed to provide reasonable protection against harmful interference when the equipment is operated in a commercial environment. This equipment generates, uses, and can radiate radio frequency energy and, if not installed and used in accordance with this user's guide, may cause harmful interference to radio communications. Operation of this equipment in a residential area is likely to cause harmful interference in which case the user will be required to correct the interference at his own expense.

CE Mark Warning

This is a Class A product. In a domestic environment, this product may cause radio interference in which case the user may be required to take adequate measures.

Warnung!

Dies ist ein Produkt der Klasse A. Im Wohnbereich kann dieses Produkt Funkstörungen verursachen. In diesem Fall kann vom Benutzer verlangt werden, angemessene Massnahmen zu ergreifen.

Precaución!

Este es un producto de Clase A. En un entorno doméstico, puede causar interferencias de radio, en cuyo caso, puede requerirse al usuario para que adopte las medidas adecuadas.

Attention!

Ceci est un produit de classe A. Dans un environnement domestique, ce produit pourrait causer des interférences radio, auquel cas l'utilisateur devrait prendre les mesures adéquates.

Attenzione!

Il presente prodotto appartiene alla classe A. Se utilizzato in ambiente domestico il prodotto può causare interferenze radio, nel cui caso è possibile che l'utente debba assumere provvedimenti adeguati.

VCCI Warning

この装置は、クラスA情報技術装置です。この装置を家庭環境で使用すると電波妨害を引き起こすことがあります。この場合には使用者が適切な対策を講ずるよう要求されることがあります。

Table of Contents

List of Tables	9
List of Figures	11
About This Document	13
<i>Audience</i>	13
<i>Organization</i>	13
<i>Document Conventions</i>	13
<i>Safety Instructions</i>	14
<i>Safety Cautions</i>	14
<i>General Precautions for Rack-Mountable Products</i>	16
<i>Protecting Against Electrostatic Discharge</i>	17
<i>Battery Handling Reminder</i>	17
1 Overview of the D-Link Unified Access System	19
<i>D-Link Unified Access System Components</i>	19
<i>D-Link Unified Switch</i>	19
<i>D-Link Access Point</i>	20
<i>WLAN Visualization</i>	20
<i>D-Link Unified Access System Topology</i>	21
<i>Single Unified Switch Deployment</i>	21
<i>Peer Switch Unified Switch Deployment</i>	22
<i>Understanding the User Interfaces</i>	23
<i>Using the Web Interface</i>	24
<i>Using the Command-Line Interface</i>	26
<i>Using SNMP</i>	27
<i>Wireless System Features and Standards Support</i>	28
2 Planning the D-Link Unified Access System Network	31
<i>System Requirements</i>	31
<i>WLAN Topology Considerations</i>	32
<i>Access Point-to-Switch Discovery</i>	34
<i>Access Point Placement</i>	34
<i>Network Planning to Support Layer 3 Roaming</i>	35
3 Installing the Hardware	37
<i>Hardware Overview</i>	37
<i>Front Panel Components</i>	38
<i>LED Indicators</i>	38
<i>Rear Panel Description</i>	40
<i>Side Panels</i>	40
<i>Installation</i>	41
<i>Package Contents</i>	41
<i>Installation Guidelines</i>	41
<i>Installing the Switch without the Rack</i>	42

<i>Installing the Switch in a Rack</i>	42
<i>Powering On the Switch</i>	43
<i>Installing the SFP ports</i>	43
<i>Installing the Optional Modules</i>	44
<i>Connecting to the External Redundant Power System</i>	46
<i>Connecting the Switch</i>	46
<i>Connecting the Switch to the Network</i>	47
<i>Connecting the Switch and AP Directly</i>	47
<i>Connecting the Switch and AP through the L2/L3 Network</i>	48
<i>Connecting to the Core Network</i>	48
4 Installing the D-Link Unified Access System	49
<i>System Deployment Overview</i>	49
<i>Connecting the Switch to the Network</i>	51
<i>Enabling the WLAN Features on the Switch</i>	52
<i>Preparing the Access Points</i>	54
<i>Logging on to the AP</i>	54
<i>Changing the AP Password</i>	55
<i>Configuring 802.1x Authentication Information on the AP</i>	55
<i>Configuring AP-to-Switch Authentication Information</i>	56
<i>Configuring VLAN Information on the Access Point</i>	56
<i>Discovering Access Points and Peer Switches</i>	57
<i>Understanding the Discovery Methods</i>	57
<i>Discovery and Peer Switches</i>	60
<i>Assigning the IP Address to Switches and Managed APs</i>	60
<i>Enabling the AP and Peer Switch Discovery</i>	63
<i>Authenticating and Validating Access Points</i>	70
<i>Configuring AP Authentication</i>	71
<i>Using the Local Database for AP Validation</i>	72
<i>Using the RADIUS Database for AP Validation</i>	74
<i>Managing Failed or Rogue APs</i>	76
5 Configuring Access Point Settings	77
<i>AP Profiles, Networks, and the Local Database</i>	77
<i>Access Point Profiles</i>	77
<i>Networks</i>	78
<i>Local Access Point Database</i>	78
<i>Configuring AAA and RADIUS Settings</i>	79
<i>Configuring Wireless Radio Settings</i>	81
<i>Configuring SSID Settings</i>	86
<i>Managing Virtual Access Point Configuration</i>	86
<i>Configuring the Default Network</i>	87
<i>Enabling and Configuring Additional VAPs</i>	90
<i>Configuring a VAP for L3 Tunnels</i>	91
<i>Configuring AP Security</i>	93
<i>Configuring Valid Access Point Settings</i>	98

6	Managing and Maintaining D-Link Access Points	103
	<i>Resetting the Access Points</i>	103
	Managing Radio Frequency Settings	104
	<i>Configuring Channel Plan and Power Settings</i>	104
	<i>Viewing the Channel Plan History</i>	107
	<i>Initiating Manual Channel Plan Assignments</i>	108
	<i>Initiating Manual Power Adjustments</i>	109
	Upgrading the Access Point Software	110
	Performing Advanced Access Point Management	112
	<i>Enabling AP Debugging</i>	113
	<i>Adjusting the Channel and Power</i>	114
7	Monitoring Status and Statistics	117
	Monitoring Wireless Global Information	117
	<i>Viewing IP Discovery Status</i>	120
	Monitoring Peer Switch Status	120
	Monitoring All Access Points	121
	Monitoring Managed Access Point Status	123
	<i>Monitoring Managed AP Statistics</i>	131
	<i>Viewing Access Point Authentication Failure Status</i>	135
	Monitoring Rogue and RF Scan Access Points	136
	Monitoring Associated Client Information	138
	<i>Viewing Associated Client Status</i>	139
	<i>Viewing Associated Client SSID Status</i>	141
	<i>Viewing Associated Client VAP Status</i>	142
	<i>Viewing Associated Client Statistics</i>	142
	<i>Viewing Client Authentication Failure Status</i>	144
	Monitoring and Managing Ad Hoc Clients	146
8	Configuring Advanced Settings	149
	Creating, Configuring, and Managing AP Profiles	149
	<i>Creating, Copying, and Deleting AP Profiles</i>	151
	<i>Applying an AP Profile</i>	152
	Configuring Global Settings	153
	Enabling SNMP Traps	154
	<i>Configuring QoS</i>	156
9	Visualizing the Wireless Network	161
	Importing and Configuring a Background Image	162
	Setting Up the Graph Components	163
	<i>Creating a New Graph</i>	163
	<i>Graphing the WLAN Components</i>	166
	Understanding the Menu Bar Options	168
	<i>Legend Menu</i>	170
	<i>Managing the Graph</i>	173
A	D-Link Unified Access System Default Settings	175
	<i>Default D-Link Unified Switch Settings</i>	175

<i>Default D-Link Access Point Settings</i>	176
<i>Default D-Link Access Point Profile Settings</i>	177
B Configuring the External RADIUS Server	179
<i>Configuring RADIUS Settings for Access Points</i>	179
<i>FreeRADIUS Server Configuration Example</i>	181
<i>Configuring RADIUS Clients</i>	181
<i>Creating and Including an Attribute Dictionary</i>	181
<i>Adding Access Points to the Valid AP Database</i>	182
<i>Configuring RADIUS Settings for Wireless Clients</i>	183
<i>Configuring RADIUS for Client MAC Authentication</i>	183
<i>FreeRADIUS Example for Wireless Client Configuration</i>	184
<i>Configuring User-Based Authentication and Dynamic VLANs</i>	184
<i>Configuring MAC Authentication</i>	185
C L3 Roaming Example	187
<i>Configuring the WLAN and Tunnel Interfaces</i>	187
<i>Using a Loopback Interface for the Wireless Functions</i>	189
<i>Creating the VLAN Routing Interface</i>	190
<i>Configuring the L3 Tunnel Network</i>	192
<i>Example of Configuring L3 Roaming by Using the CLI</i>	193
<i>Example of Configuring L3 Roaming by Using the Web Interface</i>	196
<i>Configuring DHCP Relay and the DHCP Server</i>	197
<i>Configuring the Relay Agent</i>	197
<i>Configuring the DHCP Server</i>	198
<i>Setting the MTU Size</i>	200
D Understanding Quality of Service	203
<i>QoS and Load Balancing</i>	203
<i>802.11e and WMM Standards Support</i>	203
<i>Coordinating Traffic Flow</i>	204
<i>QoS Queues and DSCP on Packets</i>	204
<i>EDCF Control of Data Frames and AIFS</i>	205
<i>Random Backoff and Contention Windows</i>	206
<i>Packet Bursting for Better Performance</i>	206
<i>TXOP Interval for Client Stations</i>	207
<i>802.1p and DSCP tags</i>	207
E Warranty and Registration Information	209
<i>All countries and regions excluding USA</i>	209
<i>WARRANTIES EXCLUSIVE</i>	210
<i>LIMITATION OF LIABILITY</i>	210
<i>Limited Warranty</i>	211
<i>Limited Warranty (USA Only)</i>	212
<i>Product Registration</i>	216
<i>D-Link Europe Limited Product Warranty</i>	216
<i>Geographical Scope of the Limited Product Warranty</i>	217
<i>Limitation of Product Warranty</i>	217

<i>Limited Product Warranty Period</i>	218
<i>Performance of the Limited Product Warranty</i>	218
<i>Warrantor</i>	219
D-Link Europe Limited Produktgarantie	219
<i>Räumlicher Geltungsbereich der eingeschränkten Garantie</i>	220
<i>Einschränkung der Garantie</i>	220
<i>Laufzeit der eingeschränkten Garantie</i>	220
<i>Leistungsumfang der eingeschränkten Garantie</i>	221
<i>Garantiegeber</i>	221
D-Link Europe a limité la garantie des produits	222
<i>Etendue géographique de la Garantie Produit Limitée</i>	222
<i>Limitation de la Garantie Produit</i>	223
<i>Période de Garantie Produit Limitée</i>	223
<i>Exécution de la Garantie Produit Limitée</i>	224
<i>Garant</i>	224
Garantía limitada del producto D-LINK Europa	224
<i>Cobertura geográfica de la garantía limitada del producto</i>	225
<i>Limitación de la garantía del producto</i>	225
<i>Período de la garantía limitada del producto</i>	226
<i>Uso de la garantía limitada del producto</i>	226
<i>Garante</i>	227
D-Link Europe Termini di Garanzia dei Prodotti	227
<i>Ambito geografico della Garanzia limitata</i>	228
<i>Limitazione della Garanzia</i>	228
<i>Periodo di garanzia</i>	228
<i>Prestazioni della Garanzia limitata</i>	229
<i>Garante</i>	229
F Technical Support	231
<i>International Offices</i>	259
<i>Registration Information</i>	260

List of Tables

Table 1. Typographical Conventions	14
Table 2. LED Description	39
Table 3. Basic Wireless Global Configuration	52
Table 4. IEEE 802.1x Supplicant Commands	55
Table 5. AP VLAN Commands	57
Table 6. L3/IP Discovery	66
Table 7. Global RADIUS Server	79
Table 8. MAC Authentication	80
Table 9. Radio Settings	82
Table 10. Advanced Radio Configuration	85
Table 11. Default VAP Configuration	87
Table 12. Wireless Network Configuration	88
Table 13. Static WEP	95
Table 14. Static WPA	97
Table 15. Valid Access Point Summary	99
Table 16. Valid AP Configuration	100
Table 17. RF Channel Plan and Power Adjustment	106
Table 18. Channel Plan History	108
Table 19. AP Upgrade	110
Table 20. AP Upgrade Status	112
Table 21. Advanced AP Management	113
Table 22. AP Debug	114
Table 23. Managed AP Channel/Power Adjust	114
Table 24. Global WLAN Statistics	118
Table 25. Peer Switch Status	121
Table 26. Monitoring All Access Points	122
Table 27. Managed Access Point Status	123
Table 28. Detailed Managed Access Point Status	125
Table 29. Managed AP Radio Summary	127
Table 30. Managed AP Radio Detail	127
Table 31. Managed AP Neighbor Status	129
Table 32. Neighbor AP Clients	130
Table 33. Managed Access Point VAP Status	131
Table 34. Managed Access Point WLAN Summary Statistics	132
Table 35. Managed Access Point Ethernet Summary Statistics	132
Table 36. Detailed Managed Access Point Statistics	133
Table 37. Managed Access Point Radio Statistics	133
Table 38. Managed Access Point VAP Statistics	134
Table 39. Access Point Authentication Failure Status	136
Table 40. Access Point RF Scan Status	138
Table 41. Associated Client Status Summary	139
Table 42. Detailed Associated Client Status	140
Table 43. Associated Client Neighbor AP Status	141

Table 44. Associated Client SSID Status	142
Table 45. Associated Client VAP Status	142
Table 46. Associated Client Association Summary Statistics	143
Table 47. Associated Client Summary Statistics	143
Table 48. Associated Client Association Detail Statistics	143
Table 49. Associated Client Session Detail Statistics	144
Table 50. Failed Client Status	145
Table 51. Client Authentication Failure Status	146
Table 52. Ad Hoc Client Status	147
Table 53. General Global Configurations	154
Table 54. SNMP Traps	155
Table 55. QoS Settings	157
Table 56. WLAN Visualization Menu Bar Options	168
Table 57. Component Information	173
Table 58. Switch Defaults	175
Table 59. AP Default AP Settings	176
Table 60. AP Default AP Profile Settings	177
Table 61. RADIUS Attributes for the Access Point	179
Table 62. RADIUS Attributes for Wireless Clients	183
Table 63. RADIUS Attributes for Wireless Client MAC Authentication	183
Table 64. L3 Tunnel Status Values	194
Table 65. VLAN Priority Tags	208

List of Figures

Figure 1. Sample WLAN Visualization.....	21
Figure 2. Single Unified Switch with Layer 2 Roaming Support.....	22
Figure 3. Peer Unified Switch with Layer 3 Roaming Support.....	23
Figure 4. Web Interface Layout.....	24
Figure 5. Cascading Navigation Menu	25
Figure 6. Hierarchical Tree Navigation Menu.....	25
Figure 7. D-Link Unified Access System Components.....	32
Figure 8. Wiring Closet Topology	33
Figure 9. Data Center Topology	34
Figure 10. Inter-Subnet Roaming	36
Figure 11. Front Panel View of the DWS-3024 as Shipped.....	38
Figure 12. Front Panel View of the DWS-3026 as Shipped.....	38
Figure 13. LED Indicators on DWS-3024	38
Figure 14. LED Indicators on DWS-3026	38
Figure 15. Rear panel view of DWS-3024	40
Figure 16. Rear panel view of DWS-3026	40
Figure 17. Prepare Switch for Installation on a Desktop or Shelf	42
Figure 18. Fasten Mounting Brackets to Switch.....	42
Figure 19. Mounting the Switch in a Standard 19" Rack	43
Figure 20. Inserting the Fiber-Optic Transceivers into the Switch.....	44
Figure 21. Front Panel of the DEM-410X	45
Figure 22. Front Panel of the DEM-410CX	45
Figure 23. Inserting the optional module into the Switch (DWS-3026).....	45
Figure 24. DWS-3026 with optional DEM-410X module installed.....	46
Figure 25. RPS Connector	46
Figure 26. Switch and AP Connected Directly.....	47
Figure 27. Switch and APs Connected Through Network.....	48
Figure 28. Switch Connected to Network Core.....	48
Figure 29. Ethernet Connection for Static IP Assignment.....	54
Figure 30. L2 Discovery Example	58
Figure 31. L3 Discovery Example 1	58
Figure 32. L3 Discovery Example 2	59
Figure 33. DHCP Option Example	59
Figure 34. Requiring AP Authentication	72
Figure 35. MAC Access Control	80
Figure 36. Radio Settings.....	81
Figure 37. VAP Settings	86
Figure 38. Configuring Network Settings.....	88
Figure 39. AP Profile With Five VAPs Enabled	90
Figure 40. Networks Available to the Wireless Client	91
Figure 41. L3 Roaming Example.....	92
Figure 42. AP Network Security Options	93
Figure 43. Static WEP Configuration	94

Figure 44. WPA Personal Configuration	96
Figure 45. Adding a Valid AP	99
Figure 46. Configuring a Valid AP.....	100
Figure 47. Access Point Reset	103
Figure 48. RF Channel Plan and Power Configuration	105
Figure 49. Channel Plan History.....	107
Figure 50. Manual Channel Plan	108
Figure 51. Manual Power Adjustments	109
Figure 52. AP Upgrade	110
Figure 53. AP Upgrade Status.	111
Figure 54. Advanced AP Management.....	113
Figure 55. Global WLAN Status	118
Figure 56. Wireless Discovery Status.....	120
Figure 57. Peer Switch Status	121
Figure 58. All Access Points.....	121
Figure 59. Managed AP Status	123
Figure 60. Managed AP Statistics.....	131
Figure 61. Authentication Failed AP Status	135
Figure 62. RF Scan	137
Figure 63. Associated Client Status.....	138
Figure 64. Client Authentication Failure Status	145
Figure 65. Ad Hoc Clients	147
Figure 66. Multiple AP Profiles.....	150
Figure 67. Adding a Profile	151
Figure 68. Configuring an AP Profile.....	151
Figure 69. Applying the AP Profile	152
Figure 70. Global Configuration.....	153
Figure 71. SNMP Trap Configuration	154
Figure 72. QoS Configuration	156
Figure 73. Sample WLAN Visualization.....	162
Figure 74. Multiple Graphs.....	166
Figure 75. List View and Tabbed View.....	166
Figure 76. Component Tool Tip	167
Figure 77. Graphed Components	168
Figure 78. Legend.....	170
Figure 79. Sentry Mode - Detailed View.....	171
Figure 80. Channel Colors	171
Figure 81. Tool Tip for Radio Managed AP Information.....	172
Figure 82. Wireless Component Attributes	173
Figure 83. Example of a Network with L3 Tunnel Subnet.....	187
Figure 84. Traffic Prioritization.....	208

About This Document

This guide describes the planning, setup, configuration, administration, and maintenance for the D-Link Unified Access System.

Audience

The information in this guide is intended for the person responsible for installing, configuring, monitoring, and maintaining the D-Link Unified Access System as part of a network infrastructure.

Organization

The D-Link Unified Access System User Manual contains the following chapters:

- Chapter 1, [“Overview of the D-Link Unified Access System”](#) on page 19
- Chapter 2, [“Planning the D-Link Unified Access System Network”](#) on page 31
- Chapter 3, [“Installing the Hardware”](#) on page 37
- Chapter 4, [“Installing the D-Link Unified Access System”](#) on page 49
- Chapter 5, [“Configuring Access Point Settings”](#) on page 77
- Chapter 6, [“Managing and Maintaining D-Link Access Points”](#) on page 103
- Chapter 7, [“Monitoring Status and Statistics”](#) on page 117
- Chapter 8, [“Configuring Advanced Settings”](#) on page 149
- Chapter 9, [“Visualizing the Wireless Network”](#) on page 161
- Appendix A, [“D-Link Unified Access System Default Settings”](#) on page 175
- Appendix B, [“Configuring the External RADIUS Server”](#) on page 179
- Appendix C, [“L3 Roaming Example”](#) on page 187
- Appendix D, [“Understanding Quality of Service”](#) on page 203
- Appendix E, [“Warranty and Registration Information”](#) on page 209
- Appendix F, [“Technical Support”](#) on page 231

Document Conventions

This section describes the conventions this document uses.

NOTE: A **Note** provides more information about a feature or technology.

CAUTION: A **Caution** provides information about critical aspects of the configuration, combinations of settings, events, or procedures that can adversely affect network connectivity, security, and so on.

This guide uses the typographical conventions that [Table 1](#) describes.

Table 1. Typographical Conventions

Symbol	Description	Example
Bold	Menu titles, page names, and button names	Click Submit to apply your settings.
Blue Text	Hyperlinked text.	See “About This Document” on page 13.
<code>courier font</code>	Screen text, file names.	<code>(switch-prompt)#</code>
<code>courier bold</code>	Commands, user-typed command-line entries	<code>show network</code>
<i><code>courier font italics</code></i>	Command parameter, which might be a variable or fixed value.	<i><code>value</code></i>
<> Angle brackets	Indicates a parameter is a variable. You must enter a value in place of the brackets and text inside them.	<code><value></code>
[] Square brackets	Indicates an optional fixed parameter.	<code>[value]</code>
[<>] Angle brackets within square brackets	Indicates an optional variable.	<code>[<value>]</code>
{ } curly braces	Indicates that you must select a parameter from the list of choices.	<code>{choice1 choice2}</code>
Vertical bars	Separates the mutually exclusive choices.	<code>choice1 choice2</code>
[{ }] Braces within square brackets	Indicate a choice within an optional element.	<code>[{choice1 choice2}]</code>

Safety Instructions

Use the following safety guidelines to ensure your own personal safety and to help protect your system from potential damage.

Safety Cautions

To reduce the risk of bodily injury, electrical shock, fire, and damage to the equipment, observe the following precautions.

- Observe and follow service markings. Do not service any product except as explained in your system documentation. Opening or removing covers that are marked with the triangular symbol with a lightning bolt may expose you to electrical shock. Only a trained service technician should service components inside these compartments.
- If any of the following conditions occur, unplug the product from the electrical outlet and replace the part or contact your trained service provider:
 - The power cable, extension cable, or plug is damaged.
 - An object has fallen into the product.
 - The product has been exposed to water.
 - The product has been dropped or damaged.
 - The product does not operate correctly when you follow the operating instructions.

- Keep your system away from radiators and heat sources. Also, do not block the cooling vents.
- Do not spill food or liquids on your system components, and never operate the product in a wet environment. If the system gets wet, see the appropriate section in your troubleshooting guide or contact your trained service provider.
- Do not push any objects into the openings of your system. Doing so can cause a fire or an electric shock by shorting out interior components.
- Use the product only with approved equipment.
- Allow the product to cool before removing covers or touching internal components.
- Operate the product only from the type of external power source indicated on the electrical ratings label. If you are not sure of the type of power source required, consult your service provider or local power company.
- To help avoid damaging your system, be sure the voltage selection Switch (if provided) on the power supply is set to match the power available at your location:
 - 115 volts (V)/60 hertz (Hz) in most of North and South America and some Far Eastern countries such as South Korea and Taiwan
 - 100 V/50 Hz in eastern Japan and 100 V/60 Hz in western Japan
 - 230 V/50 Hz in most of Europe, the Middle East, and the Far East
- Also be sure that attached devices are electrically rated to operate with the power available in your location.
- Use only approved power cable(s). If you have not been provided with a power cable for your system or for any AC-powered option intended for your system, purchase a power cable that is approved for use in your country. The power cable must be rated for the product and for the voltage and current marked on the product's electrical ratings label. The voltage and current rating of the cable should be greater than the ratings marked on the product.
- To help prevent an electric shock, plug the system and peripheral power cables into properly grounded electrical outlets. These cables are equipped with three-prong plugs to help ensure proper grounding. Do not use adapter plugs or remove the grounding prong from a cable. If you must use an extension cable, use a 3-wire cable with properly grounded plugs.
- Observe extension cable and power strip ratings. Make sure that the total ampere rating of all products plugged into the extension cable or power strip does not exceed 80 percent of the ampere ratings limit for the extension cable or power strip.
- To help protect your system from sudden, transient increases and decreases in electrical power, use a surge suppressor, line conditioner, or uninterruptible power supply (UPS).
- Position system cables and power cables carefully; route cables so that they cannot be stepped on or tripped over. Be sure that nothing rests on any cables.
- Do not modify power cables or plugs. Consult a licensed electrician or your power company for site modifications. Always follow your local/national wiring rules.
- When connecting or disconnecting power to hot-pluggable power supplies, if offered with your system, observe the following guidelines:
 - Install the power supply before connecting the power cable to the power supply.
 - Unplug the power cable before removing the power supply.
 - If the system has multiple sources of power, disconnect power from the system by unplugging all power cables from the power supplies.
- Move products with care; ensure that all casters and/or stabilizers are firmly connected to the system. Avoid sudden stops and uneven surfaces.

General Precautions for Rack-Mountable Products

Observe the following precautions for rack stability and safety. Also refer to the rack installation documentation accompanying the system and the rack for specific caution statements and procedures.

- Systems are considered to be components in a rack. Thus, “component” refers to any system as well as to various peripherals or supporting hardware.

CAUTION: Installing systems in a rack without the front and side stabilizers installed could cause the rack to tip over, potentially resulting in bodily injury under certain circumstances. Therefore, always install the stabilizers before installing components in the rack.

- After installing system/components in a rack, never pull more than one component out of the rack on its slide assemblies at one time. The weight of more than one extended component could cause the rack to tip over and may result in serious injury.
- Before working on the rack, make sure that the stabilizers are secured to the rack, extended to the floor, and that the full weight of the rack rests on the floor. Install front and side stabilizers on a single rack or front stabilizers for joined multiple racks before working on the rack.
- Always load the rack from the bottom up, and load the heaviest item in the rack first.
- Make sure that the rack is level and stable before extending a component from the rack.
- Use caution when pressing the component rail release latches and sliding a component into or out of a rack; the slide rails can pinch your fingers.
- After a component is inserted into the rack, carefully extend the rail into a locking position, and then slide the component into the rack.
- Do not overload the AC supply branch circuit that provides power to the rack. The total rack load should not exceed 80 percent of the branch circuit rating.
- Ensure that proper airflow is provided to components in the rack.
- Do not step on or stand on any component when servicing other components in a rack.

NOTE: A qualified electrician must perform all connections to DC power and to safety grounds. All electrical wiring must comply with applicable local or national codes and practices.

CAUTION: Never defeat the ground conductor or operate the equipment in the absence of a suitably installed ground conductor. Contact the appropriate electrical inspection authority or an electrician if you are uncertain that suitable grounding is available.

CAUTION: The system chassis must be positively grounded to the rack cabinet frame. Do not attempt to connect power to the system until grounding cables are connected. Completed power and safety ground wiring must be inspected by a qualified electrical inspector. An energy hazard will exist if the safety ground cable is omitted or disconnected.

Protecting Against Electrostatic Discharge

Static electricity can harm delicate components inside your system. To prevent static damage, discharge static electricity from your body before you touch any of the electronic components, such as the microprocessor. You can do so by periodically touching an unpainted metal surface on the chassis.

You can also take the following steps to prevent damage from electrostatic discharge (ESD):

1. When unpacking a static-sensitive component from its shipping carton, do not remove the component from the antistatic packing material until you are ready to install the component in your system. Just before unwrapping the antistatic packaging, be sure to discharge static electricity from your body.
2. When transporting a sensitive component, first place it in an antistatic container or packaging.
3. Handle all sensitive components in a static-safe area. If possible, use antistatic floor pads and workbench pads and an antistatic grounding strap.

Battery Handling Reminder

CAUTION: There is a danger of explosion if the battery is incorrectly replaced. Replace only with the same or equivalent type of battery recommended by the manufacturer. Discard used batteries according to the manufacturer's instructions.

Overview of the D-Link Unified Access System

The D-Link Unified Access System is a wireless local area network (WLAN) solution that enables WLAN deployment while providing state-of-the-art wireless networking features. It is a scalable solution that provides secure wireless connectivity and seamless layer 2 and layer 3 roaming for end users.

This chapter contains the following sections:

- [D-Link Unified Access System Components](#)
- [D-Link Unified Access System Topology](#)
- [Understanding the User Interfaces](#)
- [Wireless System Features and Standards Support](#)

D-Link Unified Access System Components

The D-Link Unified Access System components include the D-Link Unified Switch and the D-Link Access Point (AP).

Each D-Link Unified Switch can manage up to 48 D-Link Access Points, and each access point can handle up to 512 associated wireless clients (256 per radio). The switch tracks the status and statistics for all associated WLAN traffic and devices.

You can configure up to four peer D-Link Unified Switches that share various information about APs and their associated wireless clients. The peer unified switches can be directly connected to each other, separated by layer 2 bridges, or located in different IP subnets. Wireless clients can roam among the access points managed by peer unified switches without losing network connections.

Whether or not you have a peer group, the D-Link Unified Access System can support a total of 8000 wireless clients.

D-Link Unified Switch

The D-Link Unified Switch handles Layer 2, 3, and 4 switching and routing functions for traffic on the wired and wireless LAN and manages up to 48 access points (APs). The Unified

Switch user interface allows you to configure and monitor all AP settings and maintain a consistent configuration among all APs in the network.

The Unified Switch supports advanced data path connectivity, mobility control, security safeguards, control over radio and power parameters, and management features for both network and element control. The Unified Switch allows you to control the discovery, validation, authentication, and monitoring of peer unified switches, D-Link Access Points, and clients on the WLAN, including discovery and status of rogue APs and clients.

The D-Link Unified Access System works with the following D-Link switches:

- DWS-3024 (24 GE ports)
- DWS-3026 (24 GE ports + 2 10G ports)

D-Link Access Point

The D-Link Access Point is part of the D-Link Unified Access System, and you manage it by using the D-Link Unified Switch.

By using the Unified Switch to manage the access points, you can centralize AP management and streamline the AP upgrade process by pushing configuration profiles and software upgrades from the Unified Switch to the managed APs.

The D-Link Unified Access System works with the following D-Link access points:

- DWL-3500AP
- DWL-8500AP

The DWL-3500AP supports one radio, and the DWL-8500AP supports two radios. The DWL-3500AP radio and one of the DWL-8500AP radios operate in IEEE 802.11g mode. The second radio on the DWL-8500AP operates in IEEE 802.11a mode.

Each access point supports up to eight virtual access points (VAPs) on each radio. The VAP feature allows you to segment each physical access point into eight logical access points (per radio) that each support a unique SSID, VLAN ID, and security policy.

WLAN Visualization

The D-Link Unified Access System includes the WLAN Visualization tool, which provides a graphical representation of your wireless network through a Web browser. WLAN Visualization detects and displays the D-Link Unified Switch, D-Link Access Points, other access points, and all wireless clients associated with the D-Link Access Point. You can import information about your building layout to customize the network view.

Figure 1 shows an example of a floor plan and network with a D-Link Unified Switch that manages two APs. The graph also shows a peer switch and a rogue AP in the network.

Figure 1. Sample WLAN Visualization

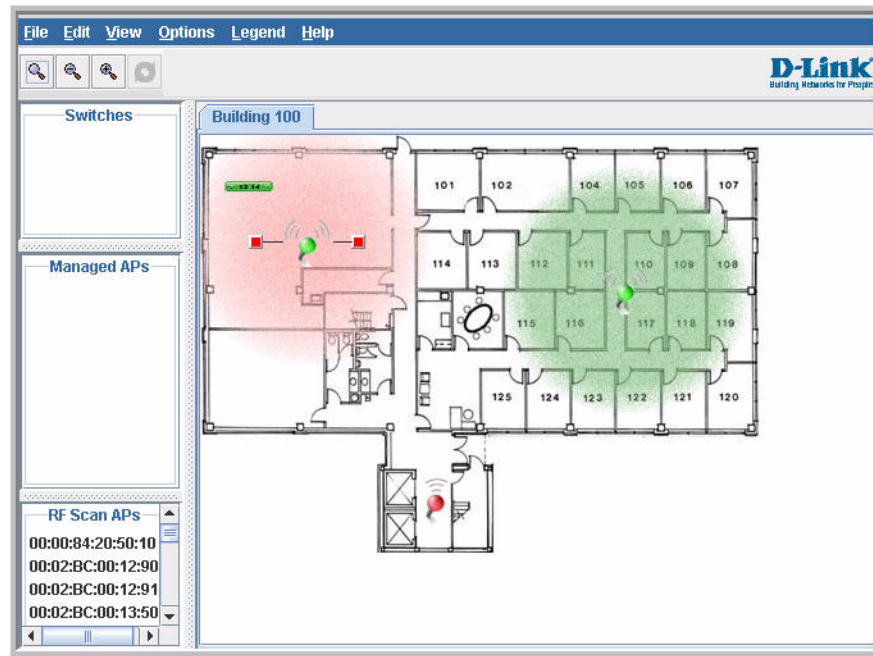

The WLAN Visualization tool provides an AP power display with color-coded channels to help you determine where to physically place access points to reduce interference or increase coverage on your WLAN.

D-Link Unified Access System Topology

The WLAN network topology you use depends on the size and requirements of your network. Small-to-medium networks might require only one Unified Switch that manages a few D-Link Access Points. For larger networks that need greater roaming capabilities for wireless clients, a deployment with multiple peer switches that each manage several APs might be appropriate.

Single Unified Switch Deployment

When you deploy a D-Link Access Point, the D-Link Unified Switch can automatically detect the AP and assign a default profile, which includes automatic RF channel selection and

automatic power adjustment. [Figure 2](#) shows a deployment with one D-Link Unified Switch that manages three D-Link Access Points.

Figure 2. Single Unified Switch with Layer 2 Roaming Support

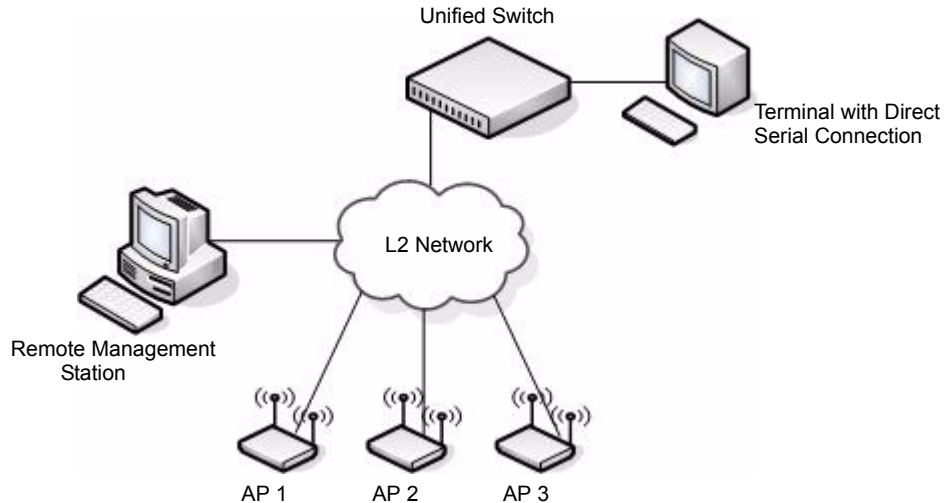

When the APs are on the same subnet and have the same SSID, wireless clients can seamlessly roam among the three APs with no interruption in network access. The client keeps the same IP address and does not need to re-authenticate when it moves into the broadcast area of a different AP. Configuration changes to the APs are managed by the switch simultaneously or on a per-AP basis.

Peer Switch Unified Switch Deployment

To support larger networks, you can configure up to four switches as peers, which increases the size and range of the WLAN. [Figure 3](#) shows a D-Link Unified Access System deployment that utilizes three peer unified switches. Each peer unified switch can manage up

to 48 access points. The Unified Switch and the APs it manages do not need to be on the same subnet.

Figure 3. Peer Unified Switch with Layer 3 Roaming Support

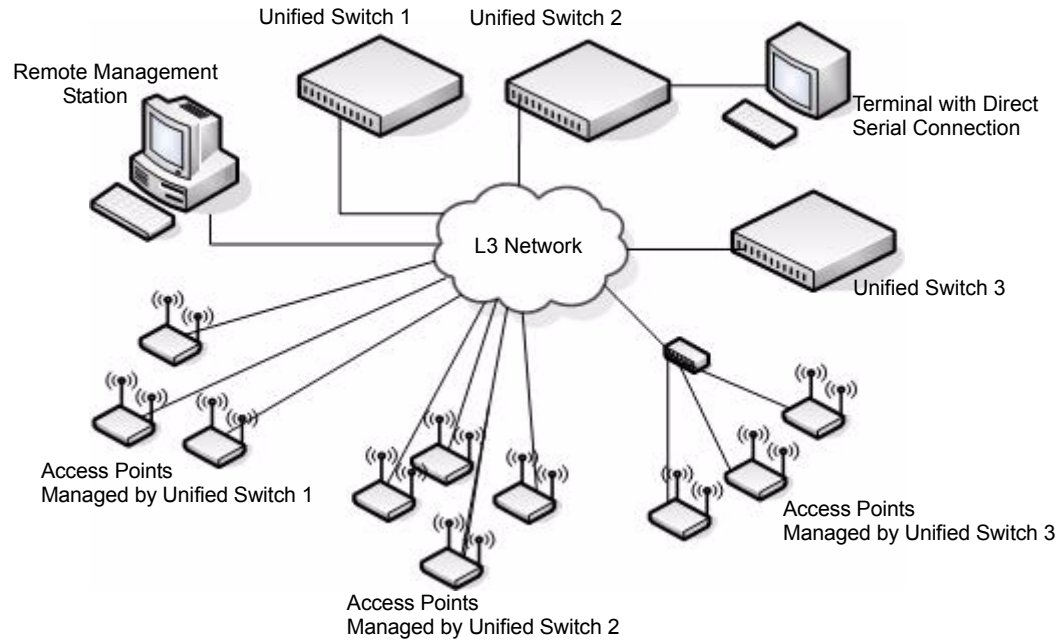

Peer unified switches share information about APs and allow Layer 3 roaming among them. To support this, peer unified switches establish IPv4 tunnels so that the wireless client keeps the same IP address even when the client associates with an access point in a different subnet. The Layer 3 roaming service allows wireless phone users to roam between access points connected to different subnets without dropping calls.

Understanding the User Interfaces

The D-Link Unified Access System enables centralized management of multiple wireless access points, which not only facilitates deployment and management, but also enhances security. The D-Link Unified Access System includes a set of comprehensive management functions for managing and monitoring the WLAN by using one of the following three methods:

- Web-based
- Command-Line Interface (CLI)
- Simple Network Management Protocol (SNMP)

Each of the standards-based management methods enables you to configure, manage, and control the components of the D-Link Unified Access System locally or remotely. Management is standards-based, with configuration parameters and a private MIB that provides control for functions not completely specified in the standard MIBs.

The method you use to configure and monitor the D-Link Unified Switch depends on your network size and requirements, and on your preference.

Using the Web Interface

To access the switch by using a Web browser, the browser must meet the following software requirements:

- HTML version 4.0, or later
- HTTP version 1.1, or later
- JavaScript™ version 1.5, or later

Use the following procedures to log on to the Web Interface:

1. Open a Web browser and enter the IP address of the switch in the Web browser address field.
2. Click **Login** when the Login screen displays.
3. Enter the user name and password into the dialogue box that appears.

The user name and password are the same as those you use to log on to the command-line interface. By default, the user name is **admin**, and there is no password.

4. After the system authenticates you, the System Description page displays.

Figure 4 shows the layout of the D-Link Unified Switch Web interface. Each Web page contains three main areas: interface configuration graphic, the navigation tree, and the configuration status or options.

Figure 4. Web Interface Layout

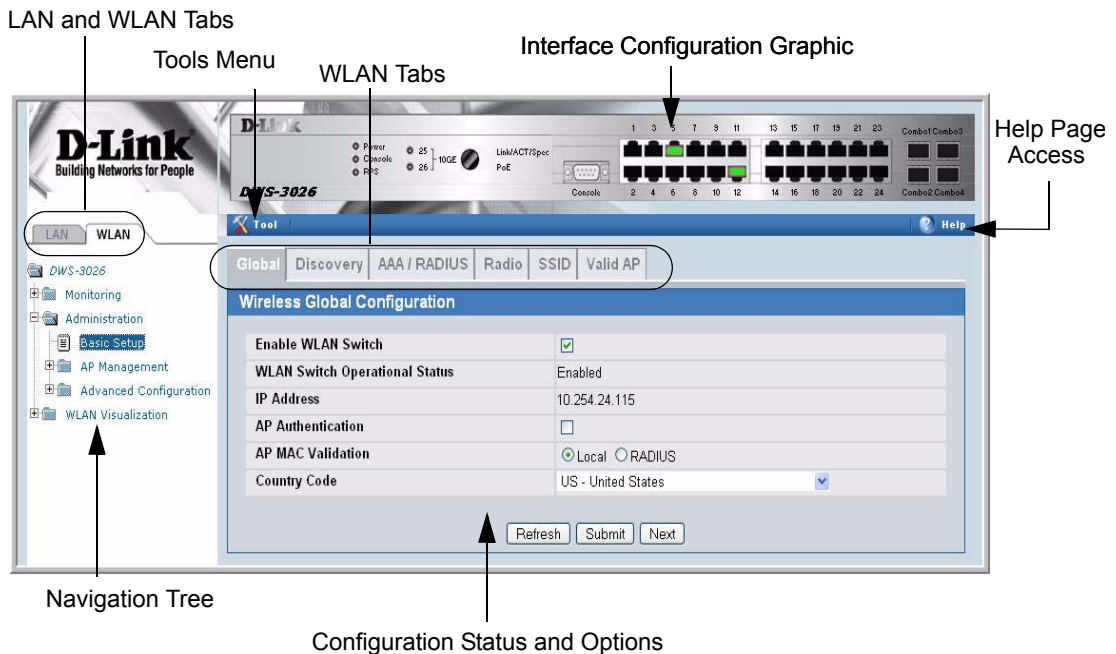

Interface Configuration Graphic

The interface configuration graphic is a Java™ applet that displays the ports on the D-Link Unified Switch. This graphic appears at the top of each page to provide an alternate way to navigate to configuration and monitoring options.

Click the port you want to view or configure to see a menu that displays statistics and configuration options. Click the menu option to access the page that contains the configuration or monitoring options.

If you click the graphic but do not click a specific port, the main menu appears. This menu contains the same option as the navigation menu on the left side of the page.

Figure 5. Cascading Navigation Menu

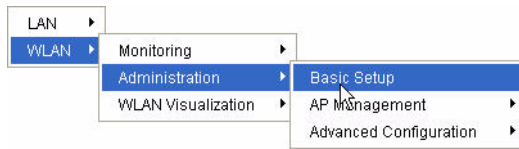

Navigation Menu

A hierarchical-tree view appears to the left of the panel. The tree consists of a combination of folders, subfolders, and configuration and status HTML pages. Click the folder to view the options in that folder. Each folder contains either subfolders or HTML pages, or a combination of both. Figure 6 shows an example of a folder, subfolder, and HTML page in the navigation menu. When you click a folder or subfolder that is preceded by a plus (+), the folder expands to display the contents. If you click an HTML page, a new page displays in the main frame. A folder or subfolder has no corresponding HTML page.

Figure 6. Hierarchical Tree Navigation Menu

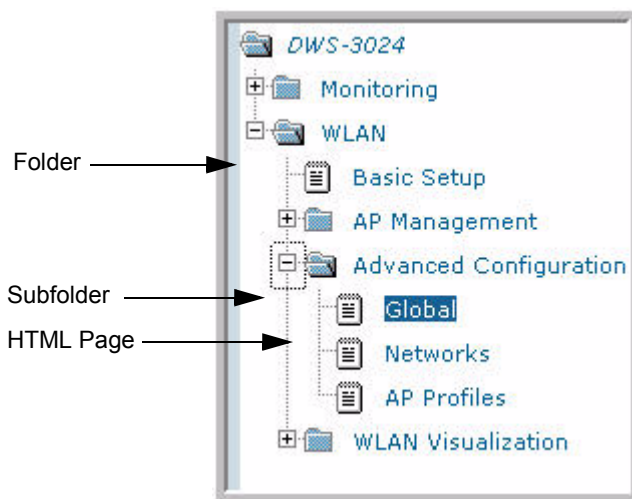

Configuration and Monitoring Options

The panel directly under the graphic and to the right of the navigation menu displays the configuration information or status for the page you select. On pages that contain configuration options, you can input information into fields or select options from drop-down menus.

Each page contains access to the HTML-based Help that explains the fields and configuration options for the page. Many pages also contain command buttons.

The following command buttons are used throughout the pages in the Web interface:

- | | |
|----------------|--|
| Submit | Clicking the Submit button sends the updated configuration to the switch. Configuration changes take effect immediately, but some changes are not retained across a power cycle unless you save them to the system configuration file. |
| Save | Clicking the Save button saves the current configuration to the system configuration file. When you click Save , changes that you have submitted are saved even when you reboot the system. To save the configuration, use the Save Changes link in the Tools menu. |
| Refresh | Clicking the Refresh button refreshes the data on the panel. |

WLAN Tabs

Many of the pages in the WLAN folder contain tabs to simplify navigation and to group functions for a common feature. Click the tab to access a specific page.

NOTE: Other packages in the software suite do not use tabs in the Web interface.

Tools Menu

If you mouse over the **Tool** icon, a list of the following useful system tools appears:

- Reset Configuration
- Reset Password
- REboot
- Save Changes
- Download File
- Upload File
- Multiple Image Services

Each item in the list is a link to the Web page where you can perform the related task.

Using the Command-Line Interface

The command-line interface (CLI) is a text-based way to manage and monitor the system. You can access the CLI by using a direct serial connection or by using a remote logical connection with Telnet or SSH.

The CLI groups commands into modes according to the command function. Each of the command modes supports specific software commands. The commands in one mode are not available until you switch to that particular mode, with the exception of the User EXEC mode commands. You can execute the User EXEC mode commands in the Privileged EXEC mode.

To display the commands available in the current mode, enter a question mark (?) at the command prompt. To display the available command keywords or parameters, enter a question mark (?) after each word you type at the command prompt. If there are no additional command keywords or parameters, or if additional parameters are optional, the following message appears in the output:

```
<cr>                               Press Enter to execute the command
```

For more information about the CLI, see the *D-Link CLI Command Reference*.

The *D-Link CLI Command Reference* lists each command available from the CLI by the command name and provides a brief description of the command. Each command reference also contains the following information:

- The command keywords and the required and optional parameters.
- The command mode you must be in to access the command.
- The default value, if any, of a configurable setting on the device.

The **show** commands in the document also include a description of the information that the command shows.

Using SNMP

For D-Link Unified Switch software that includes the SNMP module, you can configure SNMP groups and users that can manage traps the SNMP agent generates.

The D-Link Unified Switch uses both standard public MIBs for standard functionality as well as a number of additional private MIBs for additional functionality supported by the switch. All private MIBs begin with a “DLINK-” prefix. The main object for interface configuration is in DLINK-SWITCHING-MIB, which is a private MIB. Some interface configurations also involve objects in the public MIB, IF-MIB.

SNMP is enabled by default. The **System Description** Web page, which is the page the displays after a successful login, and the **show sysinfo** command display the information you need to configure an SNMP manager to access the switch.

Any user can connect to the switch using the SNMPv3 protocol, but for authentication and encryption, you need to configure a new user profile. To configure a profile by using the CLI, see the SNMP section in the *D-Link CLI Command Reference*. To configure an SNMPv3 profile by using the Web interface, use the following steps:

1. Select **LAN > Administration > User Accounts** from the hierarchical tree on the left side of the Web interface.
2. Using the **User** pull-down menu, select **Create** to create a new user.
3. Enter a new user name in the **User Name** field.
4. Enter a new user password in the **Password** field and then retype it in the **Confirm Password** field.

To use SNMPv3 Authentication for this user, set a password of eight or more alphanumeric characters.

5. To enable authentication, use the **Authentication Protocol** pull-down menu to select either MD5 or SHA for the authentication protocol.

6. To enable encryption, use the **Encryption Protocol** pull-down menu to select **DES** for the encryption scheme. Then, enter an encryption code of eight or more alphanumeric characters in the Encryption Key field.
7. Click **Submit**.

To access configuration information for SNMPv1 or SNMPv2, click **LAN > Administration > SNMP Manager** and click the page that contains the information to configure.

Wireless System Features and Standards Support

In addition to core switching features, the D-Link Unified Switch supports the following features and standards:

- IP Tunneling
- Spanning Tree
- Auto detection and configuration of APs
- Automatic Peer-Switch Discovery
- Automatic or Manual RF Channel Assignment
- Automatic or Manual AP Power Adjustment
- AP Authentication
- Client Authentication
- Load Balancing
- RF Scan and AP Sentry Mode
- Dual Radio Support
- Multiple Mode Support for Radios:
 - IEEE 802.11a
 - IEEE 802.11b
 - IEEE 802.11g
 - Atheros Dynamic Turbo 5Ghz
 - Atheros Dynamic Turbo 2.4 Ghz
- IEEE 802.11h (TPC & DFS)
- Security Standard Support:
 - WEP (64, 128)
 - WEP (152)
 - TKIP
 - AES & CCMP
 - Inhibit / Ignore SSID broadcast
 - WPA (Personal)
 - WPA (Enterprise)
 - WPA2 (Personal) 802.11i
 - WPA2 (Enterprise) 802.11i
- MAC Authentication
- Multiple BSSID/VLANs
- Security and Authentication Settings per SSID
- VLAN Support
- IEEE 802.11d (Country Code)
- IEEE 802.11e (WMM)
- RADIUS support
- WLAN Visualization (NMS like product for APs)

- Mobility
 - Inter- and Intra- Subnet Fast Roaming
 - Key caching
 - Tunneled and distributed forwarding
 - Peer-to-peer WLAN switch roaming
- Intrusion Detection
 - Rogue AP detection
 - Rogue Client detection
 - Station blacklisting
 - Ad-hoc network detection
- Network Management
 - SNMP v1, v2c, v3
 - CLI
 - SYSLOG
 - Up to 48 APs per switch
 - Auto AP image download
 - D-Link WLAN Private MIB
- Simultaneous AP upgrade
- Centralized data forwarding via tunneling for fast roaming and unified QoS
- AP RF Monitoring
- Configuration & Firmware Upload/Download

Each AP supports 8 virtual access points (VAPs) per radio. You can configure a unique SSID and security policy on each VAP. The following list shows some of the D-Link Access Point features and standards support:

- WLAN and IEEE Standards
 - IEEE 802.11a
 - IEEE 802.11b
 - IEEE 802.11d
 - IEEE 802.11e (WMM)
 - IEEE 802.11g
 - IEEE 802.11h
 - IEEE 802.11i (WPA2)
 - IEEE 802.1X - 2001 Port Based Network Access Control
 - IEEE802.3af PoE Support
- WLAN RF Features
 - RF Scan
 - Transmit Power Control
 - Load Balancing
 - Dynamic Channel Assignment
 - Dual Radio Support
 - Atheros Dynamic Turbo 5Ghz
 - Atheros Dynamic Turbo 2.4 Ghz
 - TELECOM 4.9GHZ 802.11a modes
 - Wireless Statistics
 - Virtual AP with Multiple BSSIDs/SSIDs
- WLAN AP Management
 - CLI Management (SSH)
 - Web Management (SSL support)

- SNMP v1/v2
- SNMP v3
- TFTP
- 802.11 MIB
- IF MIB
- Bridge MIB
- D-Link AP Enterprise MIB
- WLAN Networking and QoS
 - Switch/AP Discovery
 - Tunneling
 - WMM (802.11e)
 - 802.1p (MAC layer QoS support)
 - DSCP
 - Dynamic VLANs
 - MAC ACLs
 - SpectralLink Priority Support
- WLAN Encryption and Security
 - WEP
 - TKIP
 - AES & CCMP
 - Rogue AP detection
 - Ad-Hoc Client Detection
 - Inhibit / Ignore SSID broadcast
 - Weak IV avoidance
 - MAC Authentication
 - Port/IP blocking
 - RADIUS support
 - EAP
 - PEAP
 - TLS and TTLS
 - WPA (Personal, Enterprise)
 - WPA2 (Personal, Enterprise) 802.11i
 - 802.1x Supplicant
 - Client Authentication
 - Firewall/IP filtering support

Planning the D-Link Unified Access System Network

The D-Link Unified Access System provides continuous, high-speed access between your wireless and Ethernet devices. It is an advanced, scalable, standards-based solution for wireless networking. The D-Link Unified Access System enables wireless local area network (WLAN) deployment while providing state-of-the-art wireless networking features.

This chapter contains the following sections to help you plan your D-Link Unified Access System:

- [System Requirements](#)
- [WLAN Topology Considerations](#)
- [Network Planning to Support Layer 3 Roaming](#)

System Requirements

You accomplish the initial D-Link Unified Switch configuration by using a direct cable connection. After the initial configuration, you can manage the Unified Switch by using a Web-based user interface (UI), command line interface (CLI), or SNMP. The following list describes the minimum requirements you need to install and manage the D-Link Unified Switch:

- VT100 terminal or PC with terminal-emulation software
- Direct serial connection to the console port of the D-Link Unified Switch
- Remote system for management access with a Web browser, Telnet/SSH client, or SNMP manager

To support security and networking features in D-Link Unified Access System, you can use the following optional equipment on your network:

- A RADIUS server for authentication and accounting features for wireless clients, access points, and peer unified switches
- Network equipment that supports VLANs
- A DHCP server to dynamically assign network information to the switch and to all access points
- A Syslog server for external logging

Figure 7 shows a simple D-Link Unified Access System deployment with required and optional equipment for setup and operation.

Figure 7. D-Link Unified Access System Components

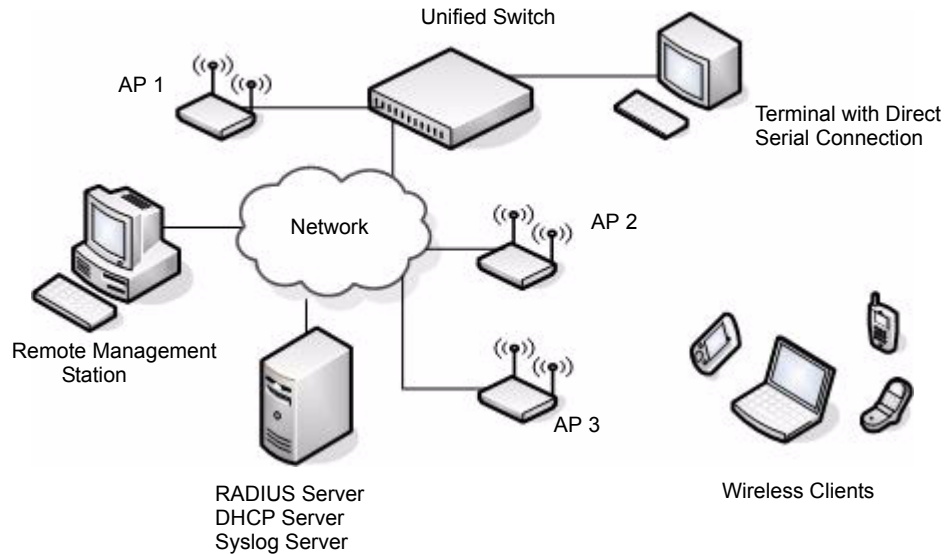

NOTE: The D-Link Unified Switch has a built-in DHCP server. If you do not already have a DHCP server on your network, you can configure the Unified Switch to assign network information to network hosts.

As the figure shows, the wireless clients can be laptop computers, personal digital assistants (PDAs), smart phones, or any other hand-held, portable or stationary device equipped with a Wi-Fi adapter and supporting drivers. In order to connect to the access point, wireless clients need the software and hardware the following list describes:

- A portable or built-in Wi-Fi client adapter that supports one or more of the IEEE 802.11 modes in which you plan to run the access point. (IEEE 802.11a, 802.11b, 802.11g)
- Client software such as Microsoft Windows Supplicant configured to associate with the WLAN.
- Wireless security software that is compatible with the authentication mode the access point uses.

WLAN Topology Considerations

The D-Link Unified Switch adds WLAN functionality to the base switching and IP routing features standard in most Layer 2/3 switches. Where you put the D-Link Unified Switch in your network depends on the size, requirements, and existing topology of your network. If you are adding a wireless network to an existing network, your requirements are different than the requirements of someone who does not have a sufficient LAN infrastructure.

Since the D-Link Unified Switch has Layer 2/3 switching functions as well as WLAN data and management functions, you can connect D-Link Access Points, wired PCs, or other network

equipment such as hubs, routers, or other switches directly to the 10/100/1000 Mbps Ethernet ports on the switch. All connections to the D-Link Unified Switch must be wired connections since the switch does not have any radios.

In [Figure 8](#), the D-Link Unified Switches are both LAN and WLAN switches that handle traffic from end users connected to the wired LAN as well as traffic from the D-Link Access Points. In the diagram, Building 1 and Building 2 have a D-Link Unified Switch on each floor.

Figure 8. Wiring Closet Topology

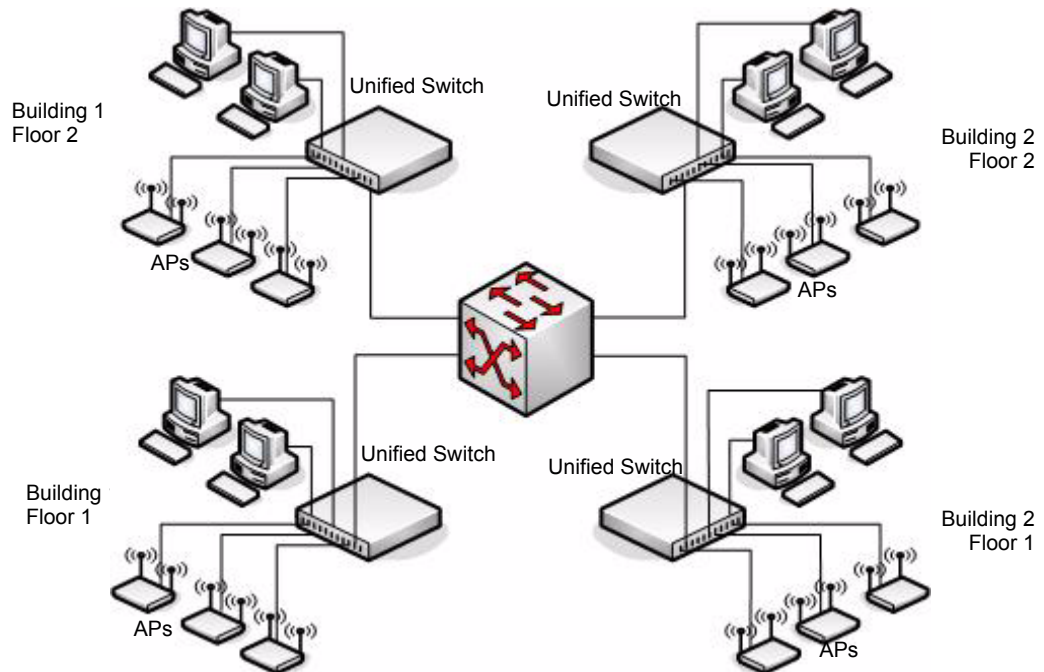

The four D-Link Unified Switches are in the same peer group. This allows wireless clients to roam between floors and between buildings without the need to re-authenticate. Additionally, each Unified Switch shares its list of managed APs and wireless clients with the switches in the peer group so that the APs and wireless clients are not reported as rogues (unknown).

The topology in [Figure 8](#) works well if you need to add, upgrade, or replace LAN switches on your network.

NOTE: When tunneled clients are used in conjunction with peer switches, one of the peer switches must be configured as a default gateway for the tunneled clients. Normally the default gateway routes all traffic from the client's subnet to other subnets, however in a peer switch network the unified switch that manages the AP to which the client is associated routes the frames into the remote subnets. This means that each peer switch must have routing table entries that enable it to route frames to every subnet in the network.

Figure 9 shows two D-Link Unified Switches in the network data center. In this deployment, the switches do not connect directly to APs or end-user nodes.

Figure 9. Data Center Topology

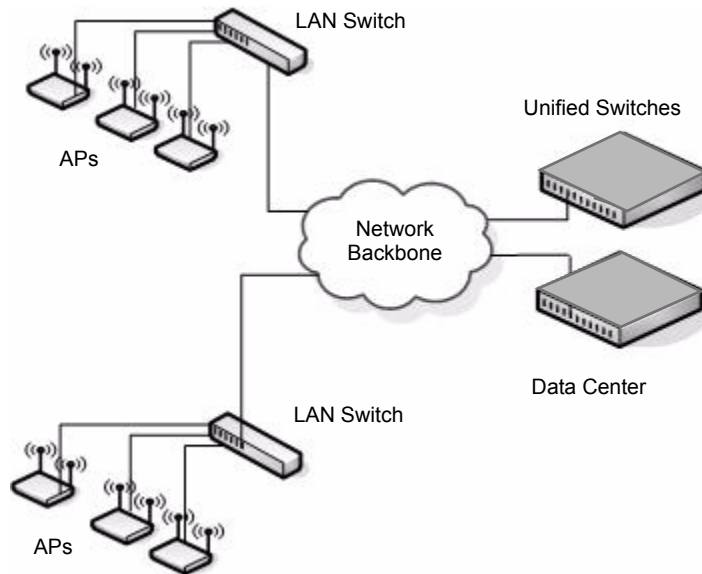

The data center topology is a good solution in networks where the goal is to add a wireless LAN to a network with minimal changes to the existing network. Traffic from wireless clients to the APs is either tunneled through the Unified Switch or tagged with a VLAN ID by the AP and handled accordingly. If the traffic is tagged, it might not pass through the Unified Switch.

Access Point-to-Switch Discovery

To enable the AP and Unified Switch to discover each other, you can use one of the following four methods:

- Enter the IP address of the Unified Switch into the AP
- Enter the IP address of the AP into the Unified Switch
- Configure the DHCP server to pass the IP address of the Unified Switch to the AP in DHCP option 43
- Use the D-Link Wireless Device Discovery Protocol

The AP-to-switch discovery method you use depends on your network topology. For example, if the Unified Switch and AP are in the same Layer 2 multicast domain, we recommend that you use the D-Link Wireless Device Discovery Protocol.

These options are discussed in more detail in [“Discovering Access Points and Peer Switches”](#) on page 57.

Access Point Placement

D-Link Access Points can be on the same subnet as the switch or on a different subnet. You can connect the AP directly to the Unified Switch or to another networking device. The range

of the D-Link Access Point is about 100 meters, but the range is affected by various environmental factors.

To maximize the range, use the following guidelines for the placement of the AP:

- Place the AP in an area where you expect wireless clients will operate.
- Elevated locations, such as on top of a shelf are preferred to increase line-of-sight access.
- Avoid placing the AP near sources of interference, such as PCs, microwaves, and 2.4 GHz cordless phones.
- Keep the AP away from large metal surfaces.
- Position the antenna horizontally to increase the up-and-down range, or position it vertically to increase side-to-side coverage.
- When APs are within broadcast range of each other, use non-interfering RF channels (five channels apart for the 802.11b/g radio).

How close you place APs to each other depends on the RF transmission power level, the number of wireless clients on your network, and the channels the APs use. The RF signal transmission power level directly affects the broadcast range of the AP signal. If the power level is too low, wireless clients will not detect the signal or experience poor WLAN performance. If the power level is too high, the RF signal might interfere with other APs within range. If the RF signal broadcasts beyond the physical confines of your building or network, it increases the security threat to the network.

When the power level is high and RF broadcast area is larger, more wireless clients can detect the signal and associate with the AP. An increase in the number of wireless clients that associate with the AP generally means that the amount of traffic the AP receives and transmits increases as well. You can limit the network utilization level allowed on an AP to prevent wireless clients from experiencing slower network speeds. However, once the network utilization is reached, new clients are unable to associate with the AP. If an AP frequently reaches the network utilization limit, it might indicate that you should add another AP nearby. You can configure the APs to automatically adjust the power and channel to the needs of the network environment.

Network Planning to Support Layer 3 Roaming

With the D-Link Unified Access System, mobile stations can maintain their IP connections while roaming from one access point to another even when these access points are attached to different IP subnets. This feature enables Voice over IP (VoIP) deployments on 802.11 subnetted networks.

It is often necessary to subdivide the enterprise IPv4 network into several subnets. An access point may be directly attached to the unified switch or it may be located several router hops away from the unified switch.

To support layer 3 roaming, the switch uses IP tunneling to establish a link between itself and the access point it manages. The switch routes all IPv4 unicast frames so that the wireless networks are perceived as locally attached networks by the unified switch. Routing must be enabled on the switch to support L3 roaming.

Figure 10 shows a single wireless client as it roams among three APs in three different subnets. A D-Link Unified Switch controls the three APs. When the wireless client connects to

any of the APs, it receives an IP address from the Unified Switch that is in the L3 Tunnel subnet. As the client roams among the APs, it maintains its connection to the WLAN and keeps the same IP address that the switch originally assigned it. All traffic the client sends and receives goes through the switch.

Figure 10. Inter-Subnet Roaming

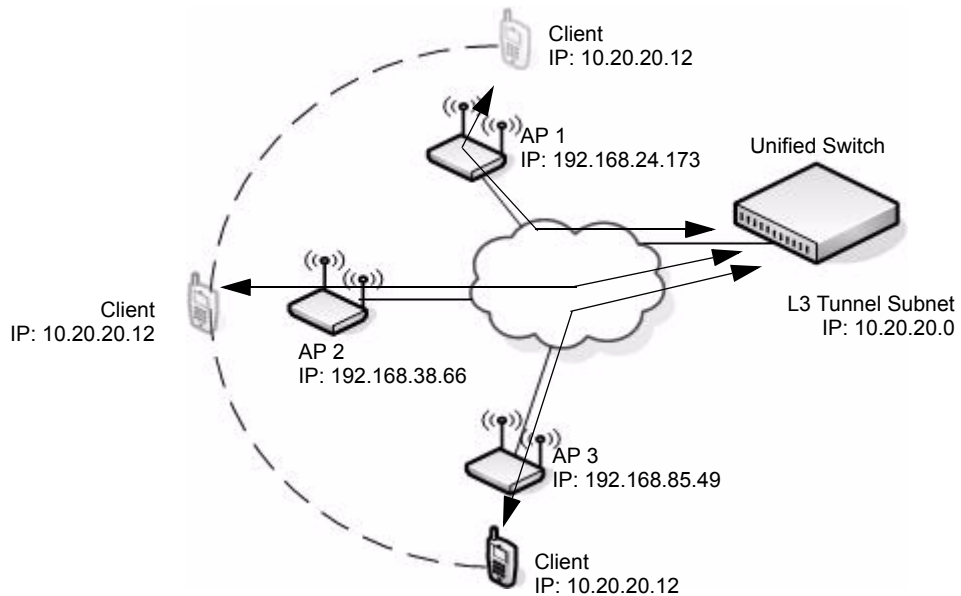

In the tunneling configuration, you can use ACL lists and QoS parameters to ensure that time-sensitive traffic, such as VoIP, takes priority over other WLAN traffic.

For many IP phone systems, you must connect a call server to a wired port on the L3 tunnel subnet. You must also either configure DHCP relay on the switch or configure the switch to be a DHCP server. APs, peer switches, and other routers cannot be connected to the L3 tunnel subnet.

For more information about L3 tunnelling and how to configure it, see [“Configuring a VAP for L3 Tunnels”](#) on page 91 and Appendix C, [“L3 Roaming Example”](#) on page 187.

Installing the Hardware

This chapter provides instructions for installing the D-Link DWS-3024 and DWS-3026 switch hardware. The following sections describe this installation process:

- [Hardware Overview](#)
 - [Front Panel Components](#)
 - [LED Indicators](#)
 - [Rear Panel Description](#)
 - [Side Panels](#)
- [Installation](#)
 - [Package Contents](#)
 - [Installation Guidelines](#)
 - [Installing the Switch without the Rack](#)
 - [Installing the Switch in a Rack](#)
 - [Powering On the Switch](#)
 - [Installing the SFP ports](#)
 - [Installing the Optional Modules](#)
 - [Connecting to the External Redundant Power System](#)
- [Connecting the Switch](#)
 - [Connecting the Switch to the Network](#)
 - [Connecting the Switch and AP Directly](#)
 - [Connecting the Switch and AP through the L2/L3 Network](#)
 - [Connecting to the Core Network](#)

Hardware Overview

This section describes the front, back, and side panels and the LED indicators on the switch. The DWS-3024 and DWS-3026 have slightly different front and back panels based on the available features.

Front Panel Components

The front panel of the Switch consists of LED indicators for Power, Console, RPS, PoE, and Link/Act/Speed for each port on the Switch including 10GE Ports for optional modules and SFP port LEDs. [Table 2](#) describes the LED indicators in more detail.

Figure 11. Front Panel View of the DWS-3024 as Shipped



Figure 12. Front Panel View of the DWS-3026 as Shipped

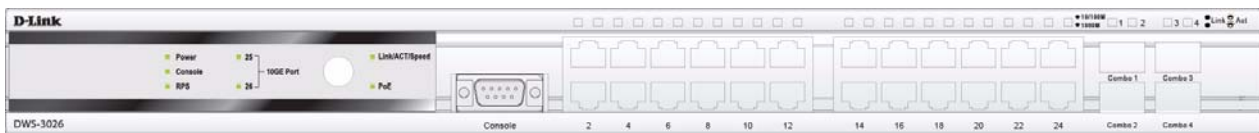

LED Indicators

The Switch supports LED indicators for Power, Console, RPS, PoE, and Port LEDs including 10GE port LEDs for optional module inserts on the DWS-3026.

Figure 13. LED Indicators on DWS-3024



Figure 14. LED Indicators on DWS-3026



The following table describes the LEDs and the Mode Select Button on the front panel of each Switch.

Table 2. LED Description

LED	Description
Power	This LED lights green after powering the Switch on to indicate the ready state of the device. The indicator is dark when the Switch is no longer receiving power (i.e powered off).
Console	This LED blinks green during the Power-On Self Test (POST). When the POST is finished, the LED goes dark. The indicator lights steady green when an active console link is in session via the RS-232 console port.
RPS	This LED lights when the internal power has failed and the RPS has taken over the power supply to the Switch. Otherwise, it remains dark.
Link/Act/Speed and PoE Mode	<p>You can change the mode of the LEDs over each port to display the information about the link, activity, and speed of a port or whether 802.3af Power Over Ethernet (PoE) is supporting devices attached to the port.</p> <p>To change the LED mode from Link/Act/Speed to PoE and vice versa, press the LED Mode Select Button.</p>
Port LEDs	<p>One row of LEDs for each port is located above the ports on the front panel. The indicator above the left side of a port corresponds to the port below the indicator in the upper row of ports. The indicator above the right side of a port corresponds to the port below the indicator in the lower row of ports. The port LEDs show information about link, activity, and speed on the port or Power over Ethernet usage on the port, depending on the LED mode you select.</p> <p>For Link/Act/Speed Mode:</p> <ul style="list-style-type: none"> • Solid Green—Indicates a valid 1000Mbps link on the port, while a blinking green light indicates activity on the port (at 1000Mbps). • Solid Amber—Indicates a valid 10 or 100Mbps link on the port. • Blinking Amber—Indicates activity on the port (at 100Mbps). • Off—No link/activity on the port. <p>For PoE Mode:</p> <ul style="list-style-type: none"> • Solid Green—Power feeding (802.3af-compliant PD was detected). • Blinking Amber—PoE port ERROR (non-standard PD connected, Under load state according to 802.3af (current is below I min), Overload state according to 802.3af (current is above I cut), hardware problems preventing port operation, power budget exceeded, short condition was detected at a port delivering power, temperature overload at the port, succession of Underload and Overload states caused port shutdown (may be caused by a PD's DC/DC fault)...etc.) • Off—No power feeding (no PD detected, or no connection)

Table 2. LED Description

LED	Description
10GE Port LEDs	(DWS-3026 only) A steady green light denotes a valid link on the port while a blinking green light indicates activity on the port. These LEDs remain dark if there is no link/activity on the port.
Combo SFP Ports	The LED indicators for the Combo ports are located above the ports and numbered 1 – 4 for Combo 1, Combo 2, Combo 3, and Combo 4 ports. A steady green light indicates a valid link on the port while a blinking green light indicates activity on the port. These LEDs remain dark if there is no link/activity on the port.

Rear Panel Description

The AC power connector is a standard three-pronged connector that supports the power cord. Plug the female connector of the provided power cord into this socket, and plug the male side of the cord into a power outlet. The Switch automatically adjusts its power setting to any supply voltage in the range from 100 ~ 240 VAC at 50 ~ 60 Hz.

The rear panel also includes an outlet for an optional external power supply. When a power failure occurs, the optional external RPS will immediately and automatically assume the power supply for the Switch.

The rear panel of the DWS-3024 contains an AC power connector, a system fan vent, and a redundant power supply connector.

Figure 15. Rear panel view of DWS-3024

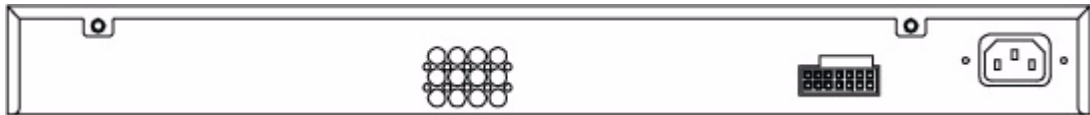

The rear panel of the DWS-3026 contains an AC power connector, a system fan vent, a redundant power supply connector and two empty slots for optional 10GE module inserts.

Figure 16. Rear panel view of DWS-3026

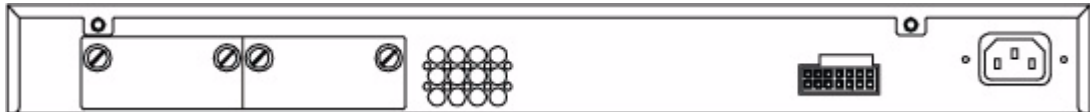

Side Panels

The system fans and heat vents located on each side of the Switch dissipate heat. Do not block these openings. Leave at least 6 inches of space at the rear and sides of the Switch for proper ventilation. Without proper heat dissipation and air circulation, system components might overheat, which could lead to system failure and severely damage components.

Installation

This section describes how to install the Switch on a flat surface or in a standard equipment rack. It also describes how to install the optional components for the Switch.

Package Contents

Open the shipping carton of the Switch and carefully unpack its contents. The carton should contain the following items:

1. One Switch
2. One AC power cord
3. Mounting kit (two brackets and screws)
4. Four rubber feet with adhesive backing
5. RS-232 console cable
6. One CD Kit for DWS-3000 Series Administrator's Guide and CLI Reference Guide
7. Registration card & China Warranty Card (for China only)

If any item is missing or damaged, please contact your local D-Link Reseller for replacement.

Installation Guidelines

Please follow these guidelines for setting up the Switch:

- Install the Switch on a sturdy, level surface that can support at least 6.6 lb. (3 kg) of weight. Do not place heavy objects on the Switch.
- The power outlet should be within 1.82 meters (6 feet) of the Switch.
- Visually inspect the power cord and see that it is fully secured to the AC power port.
- Make sure that there is proper heat dissipation from the Switch and adequate ventilation around the Switch. Leave at least 10 cm (4 inches) of space at the front and rear of the Switch for ventilation.
- Install the Switch in a fairly cool and dry place for the acceptable temperature and humidity operating ranges.
- Install the Switch in a site free from strong electromagnetic field generators (such as motors), vibration, dust, and direct exposure to sunlight.
- When installing the Switch on a level surface, attach the rubber feet to the bottom of the device. The rubber feet cushion the Switch, protect the casing from scratches, and prevent it from scratching other surfaces.

Installing the Switch without the Rack

First, attach the rubber feet included with the Switch if installing on a desktop or shelf. Attach these cushioning feet on the bottom at each corner of the device. Allow enough ventilation space between the Switch and any other objects in the vicinity.

Figure 17. Prepare Switch for Installation on a Desktop or Shelf

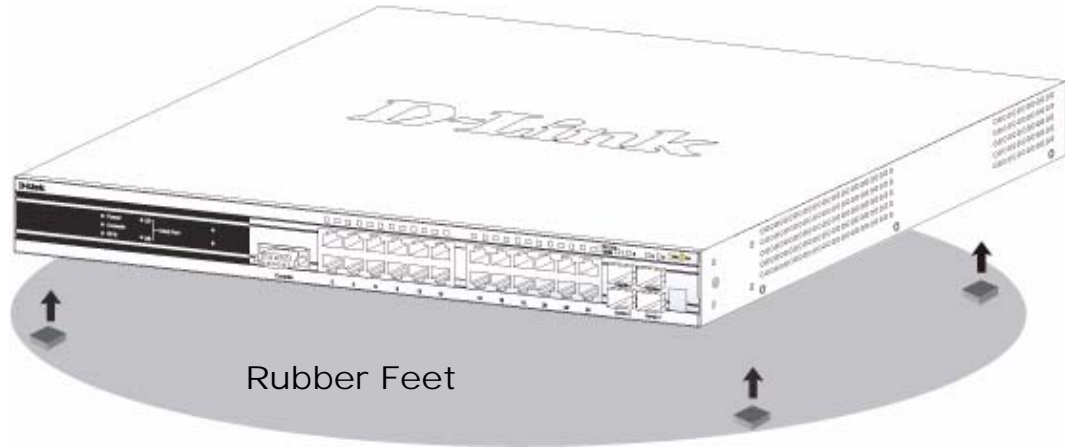

Installing the Switch in a Rack

The Switch can be mounted in a standard 19" rack. Use the following diagrams as a guide.

Figure 18. Fasten Mounting Brackets to Switch

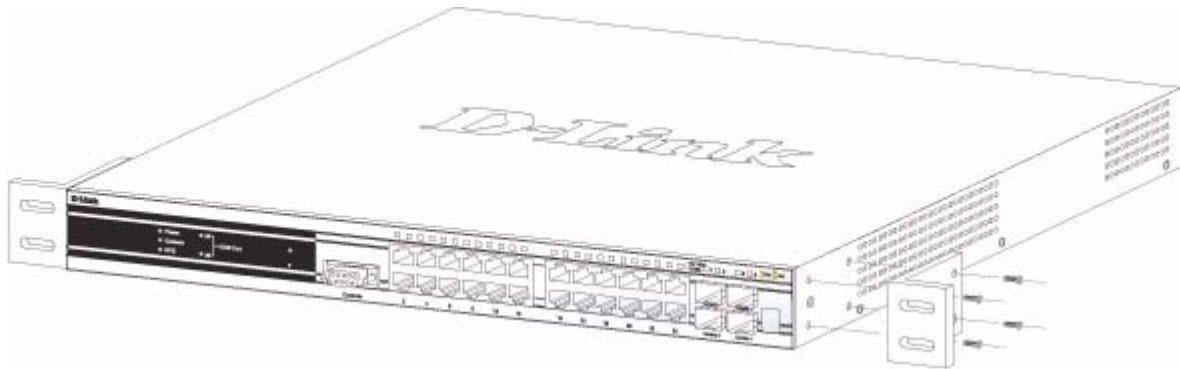

Fasten the mounting brackets to the Switch using the screws provided. With the brackets attached securely, the Switch can be mounted in a standard rack as shown in [Figure 19](#).

Figure 19. Mounting the Switch in a Standard 19" Rack

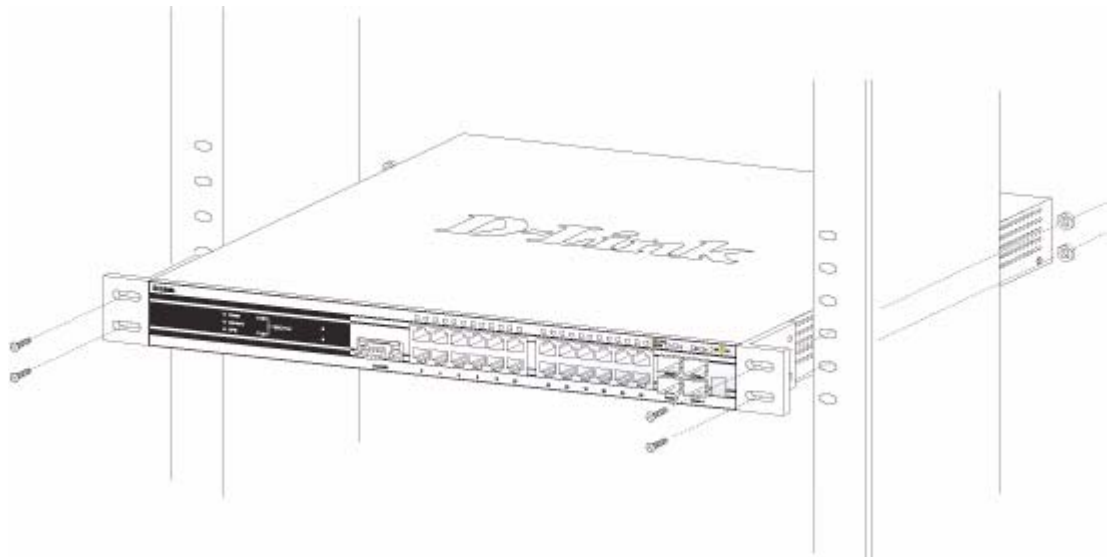

Powering On the Switch

Plug one end of the AC power cord into the power connector of the Switch and the other end into the local power source outlet.

After powering on the Switch, the LED indicators will momentarily blink. This blinking of the LED indicators represents a reset of the system.

Power Failure

As a precaution, in the event of a power failure, unplug the Switch. When power is resumed, plug the Switch back in.

Installing the SFP ports

The DWS-3000 series switches are equipped with SFP (Small Form-factor Pluggable) ports, which are to be used with fiber-optical transceiver cabling in order to uplink various other networking devices for a gigabit link that may span great distances. These SFP ports support full-duplex transmissions, have auto-negotiation and can be used with DEM-310GT (1000BASE-LX), DEM-311GT (1000BASE-SX), DEM-314GT (1000BASE-LH) and DEM-

315GT (1000BASE-ZX) transceivers. See the figure below for installing the SFP ports in the Switch.

Figure 20. Inserting the Fiber-Optic Transceivers into the Switch

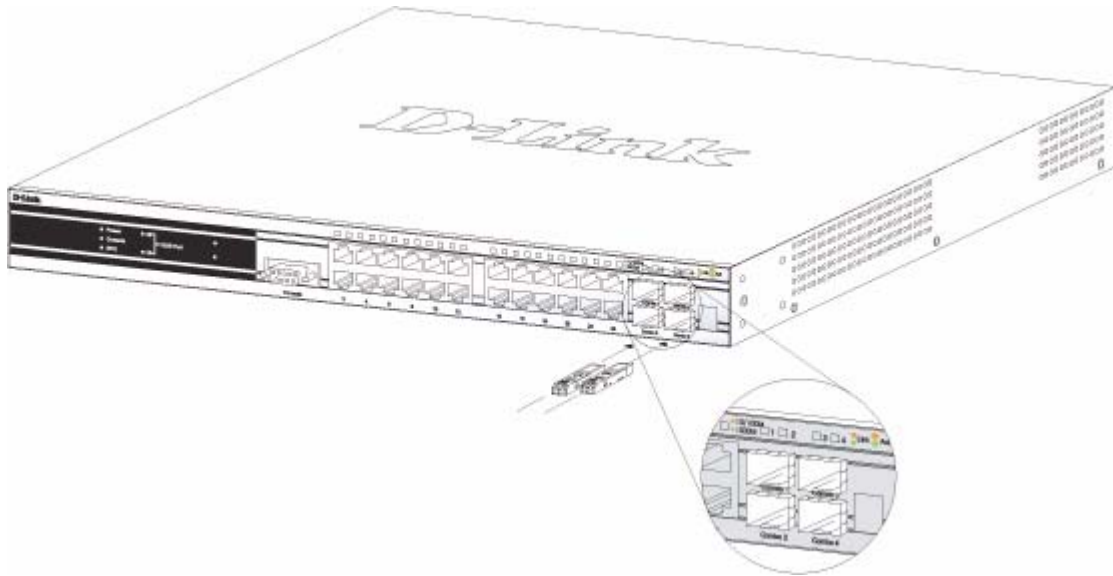

Installing the Optional Modules

The rear panel of the DWS-3026 includes two open slots that may be equipped with the DEM-410X 1-port 10GE XFP uplink module, or a DEM-410CX 1-port 10GBASE-CX4 uplink module, both sold separately.

Adding the DEM-410X optional module allows the switch to transmit data at a rate of ten gigabits per second. The module port(s) are compliant with standard IEEE 802.3ae, support full-duplex transmissions only and must be used with XFP MSA-compliant transceivers.

The DEM-410CX uses copper wire medium, not optic fiber and therefore has a transmit length limit up to 1 meters. Compliant with the IEEE802.3ak standard, this module uses a 4-lane copper connector for data transfer in full-duplex mode.

To install these modules in the DWS-3026 Switch, follow the steps listed in this section.

CAUTION: Before adding the optional module, make sure to disconnect all power sources connected to the Switch. Failure to do so may result in an electrical shock, which may cause damage, not only to the individual but to the Switch as well.

At the back of the Switch to the left are the two slots for the optional modules. These slots must be covered with the faceplate if the slots are not being used. To install a module in an available slot, remove the faceplate by loosening the screws and pulling off the plate.

The front panels of the available modules are shown here:

Figure 21. Front Panel of the DEM-410X

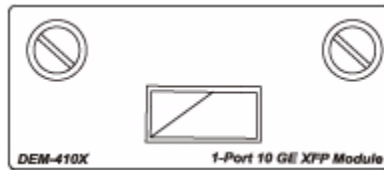
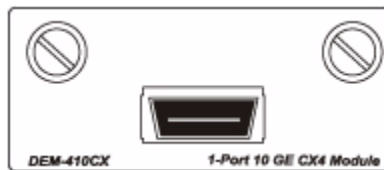

Figure 22. Front Panel of the DEM-410CX



Install the Module

Unplug the Switch before removing the faceplate covering the empty slot. To install the module, slide it in to the available slot at the rear of the Switch until it reaches the back, as shown in the following figure. Gently, but firmly push in on the module to secure it to the Switch. The module should fit snugly into the corresponding receptors.

Figure 23. Inserting the optional module into the Switch (DWS-3026)

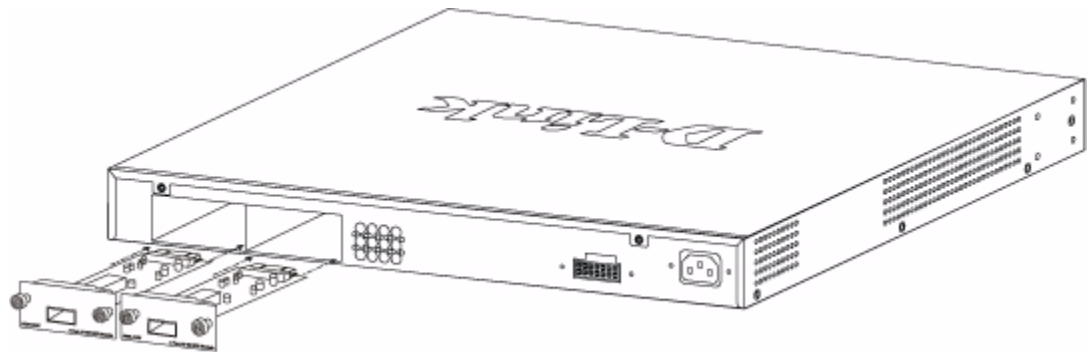

Now tighten the two screws at adjacent ends of the module into the available screw holes on the Switch. The upgraded Switch is now ready for use.

Figure 24. DWS-3026 with optional DEM-410X module installed

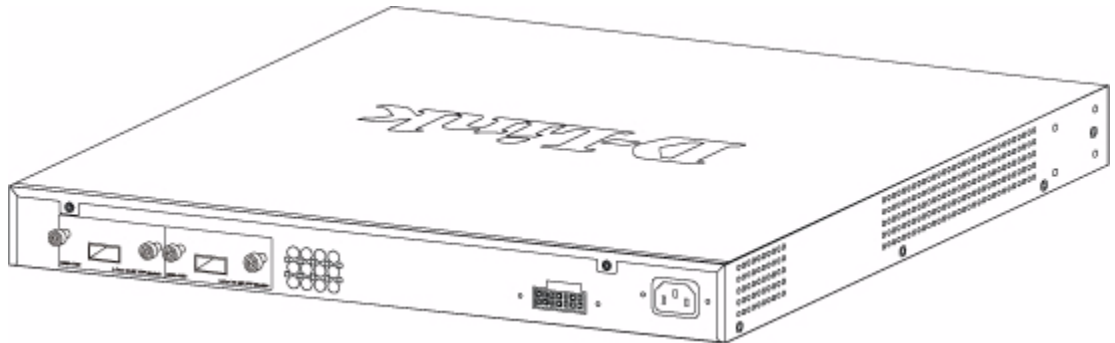

Connecting to the External Redundant Power System

The Switch supports an external redundant power system (RPS). The diagrams below illustrate a proper RPS power connection to the Switch. Please consult the documentation for information on power cabling and connectors and setup procedure.

Figure 25. RPS Connector

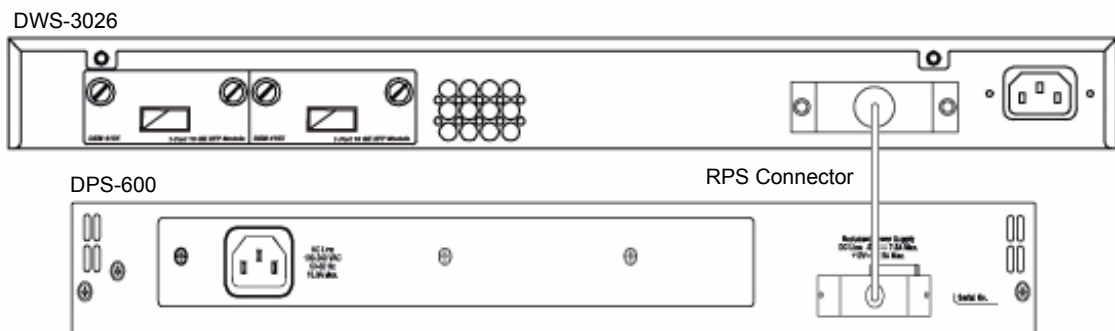

Connecting the Switch

This section describes how to connect the following nodes:

- Switch to the network
- AP directly to the Switch
- AP to the Switch through the L2/L3 network
- Switch through the 10GB uplink to the network core

NOTE: All 24 high-performance N-Way Ethernet ports can support both MDI-II and MDI-X connections.

Connecting the Switch to the Network

You can use any of the 1000BASE-T ports, 10GB ports, or fiber-optic ports to connect the Switch to your network. The type of port you use to connect the switch depends on your network requirements and the type of node to which you connect the Switch, which might be a hub, router, or another switch.

There is a great deal of flexibility on how connections are made using the appropriate cabling.

- Connect a 10BASE-T hub or switch to the Switch via a twisted-pair Category 3, 4 or 5 UTP/STP cable.
- Connect a 100BASE-TX hub or switch to the Switch via a twisted-pair Category 5 UTP/STP cable.
- Connect 1000BASE-T switch to the Switch via a twisted pair Category 5e UTP/STP cable.
- Connect a switch supporting a fiber-optic uplink to the Switch's SFP ports via fiber-optic cabling.
- Change the Switch to PoE mode using the Mode Select button. When in PoE Mode, the Switch works with all D-Link 802.3af capable devices.

The Link/Act LEDs for each UTP port will light green or amber when the link is valid. A blinking LED indicates packet activity on that port.

Connecting the Switch and AP Directly

You can connect one or more DWL-3500AP or DWL-8500AP access points directly to the Switch by using a straight-through or crossover UTP cable.

Figure 26. Switch and AP Connected Directly

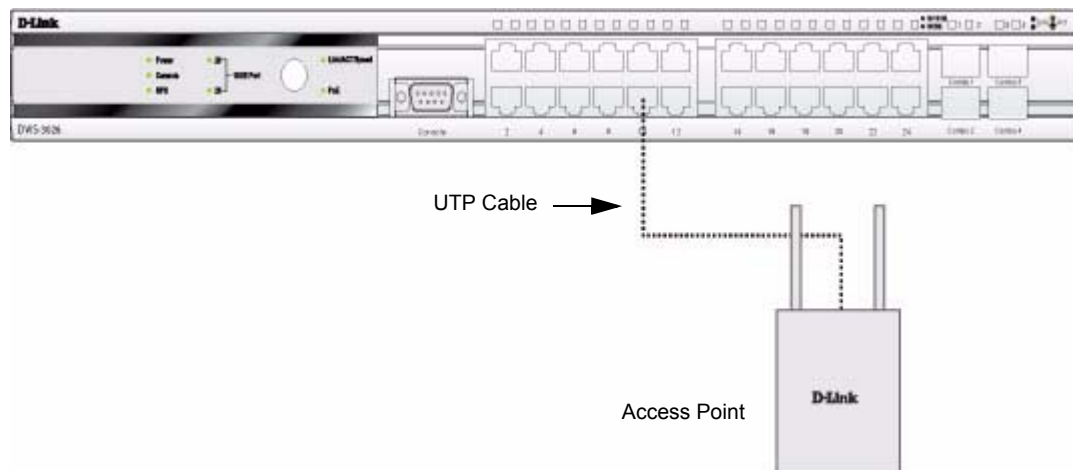

Connecting the Switch and AP through the L2/L3 Network

The Switch can discover and manage APs whether they are directly connected, connected through a device in the same subnet, or connected to different subnets.

Figure 27. Switch and APs Connected Through Network

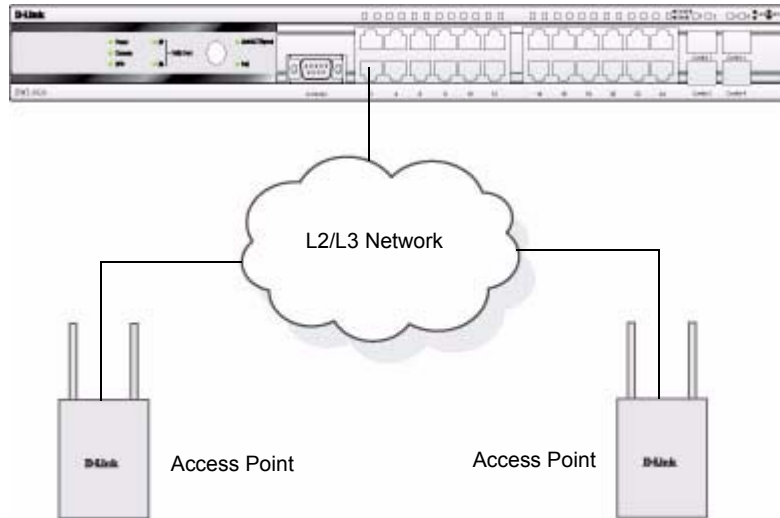

Connecting to the Core Network

The optional 10GB ports on the DWS-3026 are ideal for uplinking to the core network. Connections to the Gigabit Ethernet ports are made using a fiber-optic cable or Category 5e copper cable, depending on the type of port. A valid connection is indicated when the Link LED is lit.

Figure 28 shows the rear panel of the DWS-3026 with the optional DEM-410X module.

Figure 28. Switch Connected to Network Core

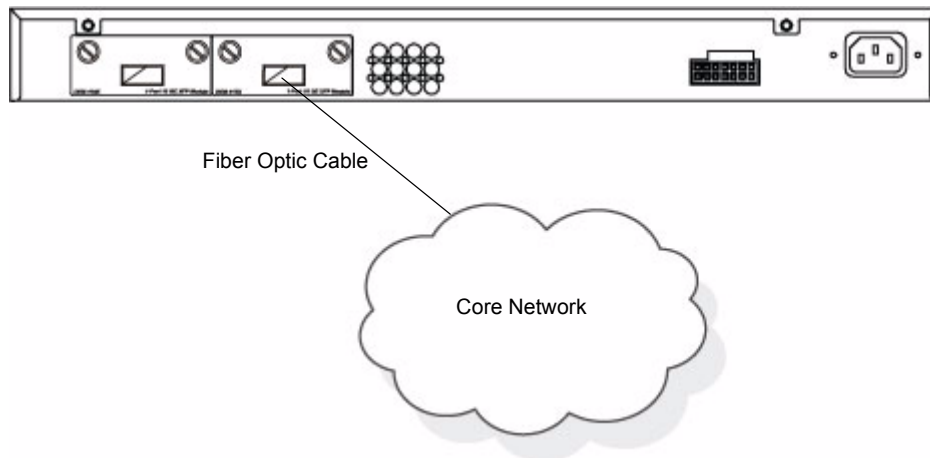

Installing the D-Link Unified Access System

This chapter contains the following sections to help you install your D-Link Unified Access System network:

- [System Deployment Overview](#)
- [Connecting the Switch to the Network](#)
- [Enabling the WLAN Features on the Switch](#)
- [Preparing the Access Points](#)
- [Discovering Access Points and Peer Switches](#)
- [Authenticating and Validating Access Points](#)

System Deployment Overview

To setup and deploy the D-Link Unified Access System solution, use the following general steps:

1. Plan the WLAN network topology.

Decide where to locate each access point to maximize accessibility to the WLAN by wireless clients and to minimize radio frequency (RF) interference by other access points. You should also determine how to integrate the D-Link Unified Switch into your existing network topology. For more information about planning the WLAN topology, see [“WLAN Topology Considerations”](#) on page 32.

2. Install and configure the D-Link Unified Switch.

To install and configure the switch, you need a serial connection to the switch, or you must connect to the switch from a host in the same subnet as the switch default IP address (10.90.90.90/8). From the initial connection to the switch, you can configure basic network information or enable the DHCP client on the switch to acquire this information automatically.

3. Enable the WLAN switch function and assign an IP address to the switch interface.

The WLAN features on the switch are enabled by default. The WLAN feature must be enabled in order for the switch to discover and validate D-Link Access Points. If the

routing mode is disabled, the Unified Switch function uses the IP address of the network interface. If routing is enabled, the switch uses a loopback or routing interface for the wireless functions. Changing the IP address of the network interface automatically disables and re-enables the wireless function. Enabling routing also disables and re-enables the wireless function.

4. Configure the default AP Profile settings that the access point will use after the switch validates it.

When the switch successfully validates an access point, it sends the AP Profile to the access point. The AP Profile contains all of the access point configuration information, such as the radio, security, and SSID settings. You can configure all of the AP settings before or after the switch validates an AP. For information about configuring the default AP profile, see Chapter 5, “[Configuring Access Point Settings](#)” on page 77.

5. Prepare and deploy D-Link Access Points and enable AP-to-switch discovery.

After you connect an AP to the network and it obtains an IP address (either statically or dynamically by using DHCP), the unified switch can automatically discover the AP. However, if your network uses IEEE 802.1x authentication or you require the AP to be authenticated by the switch upon discovery, you must log on to the AP and configure security information.

6. Authenticate and validate the APs.

You can optionally configure the Unified Switch so that it only manages APs that it authenticates. You can use the local database or an external RADIUS database for AP authentication. Whether or not you require AP-to-Unified Switch authentication, the switch must be able to validate an AP before it can manage the AP. For the switch to validate the AP, you must add the MAC address of each AP to the AP database on the switch or to the database on an external RADIUS server.

Once you validate the AP, you can use the switch to manage the AP and to view client associations, status, and statistics. If you follow the procedures in this chapter, the APs will have the default configuration profile. The default AP Profile settings are listed in [Appendix A](#).

CAUTION: The default AP profile does not use a security mechanism for wireless client associations. All wireless clients will be able to connect to an AP and access your network.

To prevent unauthorized access to the network by wireless clients, you can configure security on the default profile before you deploy the APs, or you can create additional AP profiles to assign the APs when you add them to the Valid AP database. For information about how to configure default profile settings, see Chapter 5, “[Configuring Access Point Settings](#)” on page 77.

You can use the switch to create multiple AP profiles to assign the APs that you deploy on your network. For each profile, you can define information such as RF configuration, QoS configuration, and virtual AP (VAP) configuration. For information about AP profiles, see “[AP Profiles, Networks, and the Local Database](#)” on page 77. For information about creating and configuring a new AP profile, see “[Creating, Configuring, and Managing AP Profiles](#)” on page 149.

Connecting the Switch to the Network

After you perform the physical hardware installation, you need to connect the D-Link Unified Switch to the network. The default IP address of the switch is 10.90.90.90/8, and DHCP is disabled by default. If you want to enable DHCP on the switch or assign a different static IP address, you must connect to the switch and change the default settings.

You can connect to the switch through Telnet or a Web browser from a host on the 10.0.0.0/8 network, or you can connect to the switch through the console port (RS-232 DCE). After you connect to the switch, you can provide network information or enable the DHCP client.

To connect to the switch from a host on the 10.0.0.0 network, enter the default IP address of the switch (10.90.90.90) into the address field of a Web browser or a Telnet client.

To connect to the console port and provide network information, use the following steps:

1. Using a null-modem cable, connect a VT100/ANSI terminal or a workstation to the console (serial) port.

If you attached a PC, Apple, or UNIX workstation, start a terminal-emulation program, such as HyperTerminal or TeraTerm.

2. Configure the terminal-emulation program to use the following settings:

- Baud rate: 115,000 bps
- Data bits: 8
- Parity: none
- Stop bit: 1
- Flow control: none

3. Press the return key, and the **user:** prompt appears.

Enter **admin** as the user name. There is no default password. Press ENTER at the password prompt if you did not change the default password.

After a successful login, the screen shows the `(switch-prompt)>` prompt.

4. At the `(switch-prompt)>` prompt, enter **enable** to enter the Privileged EXEC command mode. There is no default password to enter Privileged EXEC mode. Press ENTER at the password prompt if you did not change the default password.

The command prompt changes to `(switch-prompt)#`.

5. Configure the network information.

- To use a DHCP server to obtain the IP address, subnet mask, and default gateway information, enter **network protocol dhcp**.
- To use a BootP server to obtain the IP address, subnet mask, and default gateway information, enter **network protocol bootp**.
- To manually configure the IP address, subnet mask, and default gateway, enter **network parms** *<ipaddress>* *<netmask>* [*<gateway>*], for example:

```
network parms 192.168.2.23 255.255.255.0 192.168.2.1
```

The default gateway is an optional parameter, so you do not need to enter an address to execute the command.

To view the network information, enter `show network`.

- To save these changes so they are retained during a switch reset, enter the following command:

`write`

Once the D-Link Unified Switch is connected to the network, you can use the IP address for remote access to the switch by using a Web browser or through Telnet or SSH.

Enabling the WLAN Features on the Switch

In order for the Unified Switch to be able to discover and manage access points, the WLAN switch and its operational status must both be enabled. The WLAN component is enabled by default.

When you access the switch user interface, make sure you set the correct country code for the switch so that the access points can only operate in the modes permitted in your country. The default country code is US for operation in the United States.

To set the country code and enable the switch by using the Web interface, click **Administration > Basic Setup**. [Table 3](#) describes the fields on the **Wireless Global Configuration** page.

NOTE: Wireless features are available under the **WLAN** tab on the navigation menu.

NOTE: Most configuration pages have a **Submit** button, which applies the changes to the running configuration but does not save them to non-volatile memory (NVRAM). To make the changes permanent so they persist across a reboot, click the Tool, then click **Save Changes** to navigate to the appropriate page. You can also use the `write` command in Privileged Exec mode.

Table 3. Basic Wireless Global Configuration

Field	Description
Enable WLAN Switch	<p>Check the box to enable WLAN switching functionality on the system. Clear the check box to administratively disable the WLAN switch.</p> <p>If you clear the check box, all peer switches and APs that are associated with this switch are disassociated.</p> <p>Disabling the WLAN switch does not affect non-WLAN features on the switch, such as VLAN or STP functionality.</p>
WLAN Switch Operational Status	<p>Shows the operational status of the switch. The status can be one of the following values:</p> <ul style="list-style-type: none"> • Enabled • Enable-Pending • Disabled • Disable-Pending <p>If the status is pending, click Refresh to refresh the screen.</p>

Table 3. Basic Wireless Global Configuration

Field	Description
WLAN Switch Disable Reason	<p>If the status is disabled, this field appears and one of the following reasons is listed:</p> <ul style="list-style-type: none"> • None—The cause for the disabled status is unknown. • Administrator disabled—The Enable WLAN Switch check box has been cleared. • No IP Address—The WLAN interface does not have an IP address. • No SSL Files—The D-Link Unified Switch communicates with the APs it manages by using Secure Sockets Layer (SSL) connections. The first time you power on the Unified Switch, it automatically generates a server certificate that will be used to set up the SSL connections. The SSL certificate and key generation can take up to an hour to complete. <p>If routing is enabled on the switch, the operational status might be disabled due to one of the following reasons:</p> <ul style="list-style-type: none"> • No Loopback Interface—The switch does not have a loopback interface. • Global Routing Disabled—Even if the routing mode is enabled on the switch interface, it must also be enabled globally for the operational status to be enabled. <p>For information about how to configure a loopback interface and enable routing, see “D-Link Unified Switch with Routing Enabled” on page 61.</p>
IP Address	<p>This field shows the IP address of the WLAN interface on the switch. If routing is disabled, the IP address is the network interface. If routing is enabled, this is the IP address of the routing or loopback interface you configure for the Unified Switch features.</p>
AP Authentication	<p>Select the check box to require APs to be authenticated before they can associate with the switch.</p>
AP MAC Validation	<p>Select the database to use for AP validation.</p> <ul style="list-style-type: none"> • Local—If you select this option, you must add the MAC address of each AP to the local Valid AP database. • RADIUS—If you select this option, you must configure the MAC address of each AP in an external RADIUS server.
Country Code	<p>Select the country code for the country where your switch and APs operate. A popup window asks you to confirm the change.</p> <p>Wireless regulations vary from country to country. Make sure you select the correct country code so that your WLAN system complies with the regulations in your country. Some WLAN modes, such as the Atheros modes, are not available in some countries.</p> <p>Changing the country code disables and re-enables the switch. Any channel and radio mode settings that are invalid for the regulatory domain are reset to the default values.</p> <p>The country code (IEEE 802.11d) is transmitted in beacons and probe responses from the access points.</p>

From the CLI, you can view the same information that is available on the **Wireless Global Configuration** page with the `show wireless` command in Privileged EXEC mode. If you need to change the country code, you can view the list of available countries and their two-letter codes with the `show wireless country-code` command.

The CLI commands to set the country code and enable the WLAN switch are available in Wireless Config mode. To set the country code, enter `country-code <code>`. To enable the WLAN switch, enter `enable`. The following example shows how to access Wireless Config mode, set the country code to Canada, and enable the WLAN switch.

```
(switch-prompt) #configure
(switch-prompt) (Config)#wireless
(switch-prompt) (Config-wireless)#country-code CA
(switch-prompt) (Config-wireless)#enable
```

Preparing the Access Points

Depending on your network security requirements, you might need to connect to the access point CLI and configure some settings before you connect it to the network. By default, the AP uses untagged VLANs and no security. If your network requires IEEE 802.1x authentication, you must configure the supplicant information in the AP before you connect to the network. Also, if you configure the D-Link Unified Switch to require local AP authentication, you must connect to the access point CLI and configure a pass phrase. To prevent wireless clients from having access to the AP management interface, you can create a management VLAN.

NOTE: The commands you enter on the AP apply the changes to the running configuration but does not save them to non-volatile memory (NVRAM). To make the changes permanent so they persist across a reboot, use the `save-running` command.

Logging on to the AP

You can access the AP CLI only through Telnet. The default IP address is 10.90.90.91/8, and DHCP is enabled by default on the D-Link Access Point. When you connect the AP to a network with a DHCP server, the AP automatically acquires an IP address. If there is no DHCP server on the network, the AP retains its default IP address of 10.90.90.91/8 until you assign a static IP address.

For initial configuration with a direct Ethernet connection, make sure your PC has an IP address in the 10.0.0.0/8 subnet so you can access the AP CLI.

To use a direct-cable connection, connect one end of an Ethernet straight-through or crossover cable to the network port on the access point and the other end of the cable to the Ethernet port on the PC, as shown in [Figure 29](#).

Figure 29. Ethernet Connection for Static IP Assignment

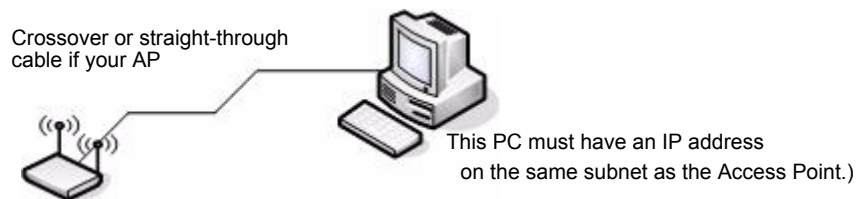

If you use this method, you will need to reconfigure the cabling for subsequent startup and deployment of the access point so that the access point is no longer connected directly to the PC but instead is connected to the LAN.

When you Telnet to the AP CLI the `DLINK-WLAN-AP login:` prompt appears.

Enter `admin` as the user name and `admin` as the password. After a successful login, the `DLINK-WLAN-AP#` prompt appears.

For information about how to disable the DHCP client on the AP or to set a static IP address, see “D-Link Access Point” on page 63 in the [Assigning the IP Address to Switches and Managed APs](#) section.

Changing the AP Password

For access to the AP, you need to provide the user name (admin), and a password. We recommend that you change the default AP password to make access to the device more secure.

To change the default password, log on to the AP and enter the following command:

```
set system password <password>
```

For example, the following command changes the password to test1234.

```
set system password test1234
```

The password you type appears in plain text. You are not asked to confirm the password after you enter it once.

Configuring 802.1x Authentication Information on the AP

On networks that use IEEE 802.1x port-based network access control, a supplicant (client) cannot gain access to the network until the 802.1x authenticator grants access. If your network uses 802.1x, you must configure 802.1x authentication information that the AP can supply to the authenticator.

NOTE: The access point supports MD5 authentication.

[Table 4](#) shows the commands you can use to configure 802.1x supplicant information.

Table 4. IEEE 802.1x Supplicant Commands

Action	Command
View 802.1x supplicant settings	<code>get dot1x-supplicant</code>
Enable 802.1x supplicant	<code>set dot1x-supplicant status up</code>
Disable 802.1x supplicant	<code>set dot1x-supplicant status down</code>
Set the 802.1x user name	<code>set dot1x-supplicant user <name></code>
Set the 802.1s password	<code>set dot1x-supplicant password <password></code>

In the following example, the administrator enables the 802.1x supplicant and sets the user name to wlanAP and the password to test1234.

```
WLAN-AP# set dot1x-supplicant status up
WLAN-AP# set dot1x-supplicant user wlanAP
WLAN-AP# set dot1x-supplicant password test1234
WLAN-AP# get dot1x-supplicant
Property Value
-----
status      up
user        wlanAP
```

Configuring AP-to-Switch Authentication Information

You can configure a pass phrase on the AP and on the switch so that only authenticated APs can associate with the switch. If you do enable AP authentication on the Unified Switch, you must connect to the access point CLI and configure a pass phrase. This pass phrase must be the same as the one you configure on the Unified Switch.

To configure the pass phrase on the AP, use the following command:

```
set managed-ap pass-phrase <phrase>
```

The pass phrase can be up to 32 alphanumeric characters.

For example, the following command sets the AP-to-Unified Switch authentication pass phrase to test1234.

```
WLAN-AP# set managed-ap pass-phrase test1234
```

For more information about AP-to-Unified Switch authentication and how to configure it on the switch, see [“Configuring AP Authentication”](#) on page 71.

Configuring VLAN Information on the Access Point

The management VLAN is VLAN 1 by default. This VLAN is also the default untagged VLAN. This means that all traffic, including management traffic, is untagged.

If you want to limit access to the management interface on the access point or if you already have a management VLAN configured on your network with a different VLAN ID, you can change the VLAN ID of the management VLAN on the access point from the AP CLI.

Table 5. AP VLAN Commands

Action	Command
View management interface information, including the VLAN ID	<code>get management</code>
Set the management VLAN ID	<code>set management vlan-id <1-4096></code>
View untagged VLAN information	<code>get untagged-vlan</code>
Enable the untagged VLAN	<code>set untagged-vlan status up</code>
Disable the untagged VLAN	<code>set untagged-vlan status down</code>
Set the untagged VLAN ID	<code>set untagged-vlan vlan-id <1-4096></code>

Discovering Access Points and Peer Switches

The D-Link Unified Switch can discover, validate, authenticate, or monitor the following system devices:

- Peer unified switches
- D-Link Access Points
- Wireless clients
- Rogue APs
- Rogue wireless clients.

This section describes the procedures you use to discover D-Link Access Points and other D-Link Unified Switches. For information about the discovery of wireless clients, see [“Monitoring Associated Client Information”](#) on page 138. For more information about discovering rogue devices, see [“Monitoring Rogue and RF Scan Access Points”](#) on page 136.

In order for the Unified Switch to discover other WLAN devices and establish communication with them, the devices must have their own IP address, must be able to find other WLAN devices, and must be compatible.

When the D-Link Unified Switch discovers and validates D-Link Access Points, the switch takes over the management of the AP. The default AP Profile settings are listed in [Appendix A](#).

For information about how to change the AP Profile settings, see Chapter 5, [“Configuring Access Point Settings”](#) on page 77.

Understanding the Discovery Methods

The Unified Switch and AP have multiple ways of discovering each other. The following examples describe different ways the discovery can occur.

Example 1: L2 Discovery

In [Figure 30](#), the AP and Unified Switch are directly connected. The devices are in the same layer 2 broadcast domain and use the default VLAN settings. After both devices acquire an IP

address, either statically or through DHCP, the Unified Switch automatically discovers the AP through its broadcast of a L2 discovery message.

Figure 30. L2 Discovery Example

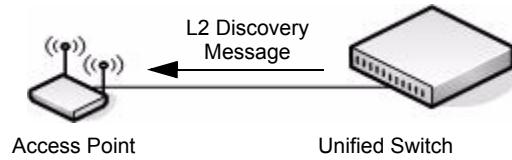

In this example, the administrator does not need to configure any discovery information on the AP or the Unified Switch. The L2 discovery works automatically when the devices are directly connected or connected by using a layer 2 bridge.

For more information about this discovery method, see [“D-Link Wireless Device Discovery Protocol”](#) on page 64.

Example 2: IP Address of AP Configured in the Switch

[Figure 31](#) shows two access points. One AP is directly connected to the D-Link Unified Switch, and the other AP is connected via a L3 switch.

Figure 31. L3 Discovery Example 1

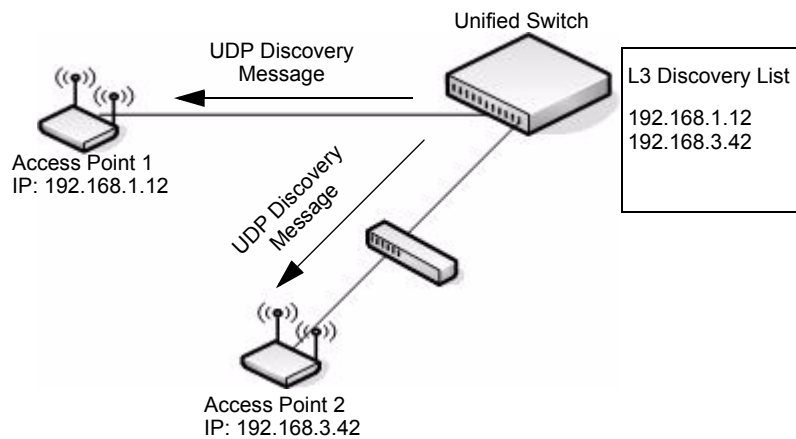

The administrator disables the L2 discovery method on the switch and adds the IP addresses of the APs to the L3 Discovery list on the switch. The Unified Switch sends UDP discovery messages to the IP addresses in its list. When the AP receives the messages and decides that it can connect to the switch, it initiates an SSL TCP connection to the switch.

For information about how to configure this discovery method, see [“Configuring IP Addresses of Peers and APs in the Switch”](#) on page 65.

Example 3: IP Address of Switch Configured in the AP

In this example, the administrator connects to the access point CLI and statically configures the IP addresses of two D-Link Unified Switches that are allowed to manage the AP.

Figure 32. L3 Discovery Example 2

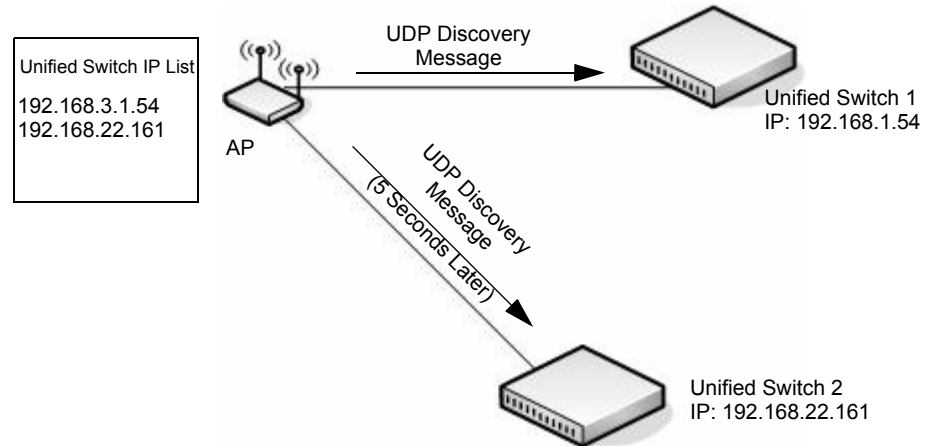

The AP sends a UDP discovery message to the first IP address configured in its list. When the switch receives the message, it verifies that the vendor ID on the AP is valid, there is no existing SSL TCP connection to the access point, and the maximum number of managed APs hasn't been reached. If all these conditions are met then the switch sends an invitation message to the AP to start the SSL TCP connection.

If the AP does not receive an invitation from the first Unified Switch configured in its list, it sends a UDP discovery message to the second Unified Switch configured in the list five seconds after sending the message to the first Unified Switch.

When an IP address of a Unified Switch is configured on the AP, the AP only associates with that switch even if other switches discover the AP by using other mechanisms.

For more information about how to configure this discovery method, see [“Setting the Switch IP Address in the D-Link Access Point”](#) on page 67.

Example 4: DHCP Option

In this example, the administrator has configured the IP address of the Unified Switch as an option in the DHCP response to the DHCP request that the AP sends the DHCP server.

Figure 33. DHCP Option Example

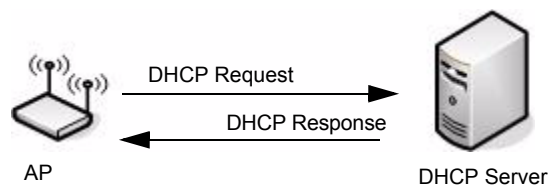

The AP can learn up to four Unified Switch IP addresses or DNS names through DHCP option 43 in the DHCP response.

This discovery method only works if you configure the DHCP option before the AP receives its network information from the DHCP server.

For information about how to configure option 43 with the IP address of one or more Unified Switch, see [“Setting the Switch Information in the DHCP Option”](#) on page 69.

Discovery and Peer Switches

When multiple peer switches are present in the network, you can control which switch or switches are allowed to discover a particular AP by the discovery method you use.

If you want to make sure that an AP is discovered by one specific switch, use one of the following methods:

- Disable L2 Discovery on all switches and configure the IP address of the AP in only one Unified Switch.
- Configure the IP address of one Unified Switch in the AP.
- Configure the DHCP option 43 with the IP address of only one Unified Switch.

An alternative approach is to configure the RADIUS server to return a switch IP address during AP MAC address checking in the AP authentication process. For information about how to configure the RADIUS server to return a switch IP address, see Appendix B, [“Configuring the External RADIUS Server”](#) on page 179.

If the RADIUS server indicates that the AP is a valid managed AP and returns an IP address of a switch that is not the same as this switch, then the switch sends a "re-link" message to the access point with the IP address of the unified switch to which the AP should be talking to. When the AP gets the re-link message it modifies or sets the unified switch IP address, breaks the TCP connection with the current switch and starts a new discovery process.

You can configure the D-Link Unified Access System so that each AP is allowed to be managed by any of the four switches in a peer group. If the Unified Switch that manages an AP goes down, one of the backup switches takes over the management responsibilities.

To use one or more peer switches as a backup for an AP, use one of the following discovery methods:

- If the AP and any of the peer switches are in the same L2 broadcast domain, L2 Discovery is enabled, and all the devices use the default VLAN settings, a peer switch will automatically discover the AP if the primary Unified Switch becomes unavailable.
- Configure the IP address of the AP in up to four switches.
- Connect to the access point CLI and configure the IP address of up to four switches.
- Configure the DHCP option 43 with the IP address of up to four switches in a peer group.

Assigning the IP Address to Switches and Managed APs

D-Link Unified Switches communicate with each other and with D-Link Access Points by using the IP protocol, so each device must have a valid IP address.

D-Link Unified Switch with Routing Disabled

If routing is disabled on the D-Link Unified Switch, it uses the network interface address of the switch that you configured during the initial setup process.

NOTE: If you change the IP address of the network interface, the wireless function on the switch automatically disables and re-enables. If you used DHCP for the IP address assignment, make sure the lease does not expire.

D-Link Unified Switch with Routing Enabled

If the routing mode is enabled on the D-Link Unified Switch, you must create a loopback or routing interface on the switch. Peer switches and APs use the IP Address of the lowest loopback interface index to identify and communicate with the switch. If you do not define a loopback interface, the wireless function uses the lowest index routing interface.

If routing is enabled, we strongly recommend that you define a loopback interface on the switch. By creating a loopback interface, you can control which routing interface the wireless function uses for its IP address when multiple routing interfaces exist. This can avoid discovery problems for the discovery modes that use the IP address of the Unified Switch. With the loopback interface, the IP address of the wireless function is always the same.

NOTE: In this context, the loopback interface does not refer to the loopback interface with the 127.0.0.1 IP address. When you configure a loopback interface for the wireless interface on the switch, it is essentially a permanent logical interface and cannot have an IP address of 127.0.0.1. You must create a dedicated subnet for the loopback interface, and other devices on the network must be able to contact the IP address of the loopback interface.

The advantage of defining a loopback interface is that the interface never goes down. The disadvantage is that network configuration is more complex because the loopback interface is located on its own subnet and the rest of the network must know how to get to the subnet.

The network must have routes between the Unified Switch and the APs you want it to manage. The APs must be able to ping the IP address assigned to the wireless interface on the Unified Switch. You configure static routes on the switch through the configuration pages under **LAN > L3 Features > Router**.

The following procedures show an example of how to enable routing and configure a IP address on a routing or loopback interface by using the CLI:

1. Log on to the CLI and switch to Global Config mode:

```
(switch-prompt)
User: admin
Password:
(switch-prompt) >enable
Password:
(switch-prompt) #config
(switch-prompt) (Config)#
```

2. Enable routing.

```
(switch-prompt) (Config)#ip routing
```

3. Change to Interface Config mode for loopback interface 0, and assign an IP address and subnet mask.

```
(switch-prompt) (Config)#interface loopback 0
(switch-prompt) (Interface loopback 0)#ip address 10.1.1.1 255.255.0.0
```

4. [Optional] Change to Interface Config mode for slot 0, port 2, assign an IP address, and enable routing on the interface.

```
(switch-prompt) (Config)#interface 0/2
(switch-prompt) (Interface 0/2)#ip address 192.168.1.24 255.255.255.0
(switch-prompt) (Interface 0/2)#routing
```

You can also use the Web interface or SNMP to enable routing and configure an IP address. The following shows the procedures to enable routing and configure an IP address on the switch by using the Web interface.

NOTE: Routing is available under the **LAN** tab on the navigation menu.

1. Log on to the Web interface and click **L3 Features > IP > Configuration** to access the **IP Configuration** page.
2. From the **Routing Mode** drop-down menu, choose **Enable**, and then click **Submit**.
3. To create a loopback interface, click **Routing > Loopback > Configuration**.
4. From the Loopback drop-down menu, choose **Create**, and then click **Submit**
5. Enter an IPv4 address and subnet mask in the appropriate fields, and then click **Submit**.
6. To create a routing interface and assign an IP address, click **Routing > IP > Interface Configuration**, and select the interface to configure from the Slot/Port drop-down menu.
7. Enter an IP address and subnet mask in the appropriate fields, choose **Enable** from the **Routing Mode** drop-down menu, and click **Submit**.

IP Interface Configuration	
Slot/Port	0/3
IP Address	192.168.1.12
Subnet Mask	255.255.255.0
Routing Mode	Enable
Administrative Mode	Enable
Link Speed Data Rate	
Forward Net Directed Broadcasts	Disable
Active State	Inactive
MAC Address	00:02:BC:00:00:79
Encapsulation Type	Ethernet
Proxy Arp	Enable
Local Proxy Arp	Disable
IP MTU	1500 (68 to 1500)

D-Link Access Point

On the D-Link Access Points, the default IP address is 10.90.90.91/8, and DHCP is enabled by default. If you do not have a DHCP server on the network, the AP retains its default IP address until you assign a static IP address.

You can connect to the AP CLI from a host on the 10.0.0.0/8 network by telnetting to the AP's default IP address.

To set a static IP address on the AP, use the following procedures:

1. Log on to the D-Link Access Point.

For information about how to log on to the AP, see [“Logging on to the AP”](#) on page 54.

2. Enter `get management` to view information about the AP's management interface.
3. Disable the DHCP client on the AP so that it does not broadcast DHCP requests.

```
set management dhcp-status down
```

4. To set the static IP address, enter the following command:

```
set management static-ip <ipaddress> static-mask <subnet_mask>
```

For example:

```
set management static-ip 192.168.22.133 static-mask 255.255.255.0
```

5. To set the default gateway, enter the following command:

```
set static-ip-route gateway <gateway_ip> mask <subnet>
```

For example,

```
set static-ip-route gateway 102.168.22.1 mask 255.255.255.0
```

6. From the CLI, enter `save-running` to save the configuration to memory.

You can use the Unified Switch as a DHCP server. If you plan to use the Unified Switch as the DHCP server that responds to DHCP requests from the AP, see [“Setting the Switch Information in the DHCP Option”](#) on page 69

Enabling the AP and Peer Switch Discovery

The D-Link Unified Switch can discover peer unified switches and D-Link Access Points regardless of whether these devices are connected to each other, located in the same Layer 2 broadcast domain, or attached to different IP subnets.

You can enable discovery between the D-Link Access Point and D-Link Unified Switch by using one of following four mechanisms:

- Use VLANs to broadcast the D-Link Wireless Device Discovery Protocol.
- Connect to the access point CLI and manually add the IP address of the switch.
- Configure a DHCP server to include the switch IP address in the DHCP response to the AP DHCP client request.
- Manually add the IP address of the AP to the switch. Multiple peer switches might find the same access point. The first association always takes precedence. The AP does not change

its association unless the connectivity to the current unified switch fails or the switch tells the AP to disassociate and associate with another switch.

The following sections describe each discovery mechanism.

D-Link Wireless Device Discovery Protocol

The Wireless Device Discovery Protocol is a good discovery method to use if D-Link Unified Switches and D-Link Access Points are located in the same Layer 2 multicast domain. The D-Link Unified Switch periodically sends a multicast packet containing the discovery message on each VLAN enabled for discovery. You can enable the discovery protocol on up to 16 VLANs.

By default, VLAN 1 is enabled on the AP, and VLAN 1 is enabled for discovery on the Unified Switch. If the switch and AP are in the same Layer 2 multicast domain, you might not need to take any action to enable AP-to-Switch discovery.

If the switch has discovered a new AP by using L2 discovery and the MAC address of the AP is not in the Valid AP database, the AP appears in the list on the **Monitoring > Access Point > Authentication Failed Access Points** page. To view AP authentication failures from the CLI, enter `show wireless ap failure status` in Privileged EXEC mode.

The APs process the discovery message only when it comes in on the management VLAN. The APs do not forward the L2 discovery messages onto the wireless media.

Use the following procedures to add a VLAN to the discovery list by using the Web interface:

1. Use a browser to log on to the D-Link Unified Switch.
2. From the Navigation menu, click **Administration > Basic Setup**, then select the **Discovery** tab.
3. Make sure the box for **L2/VLAN Discovery** is selected and add the management VLAN ID of an AP or peer switch to the **VLAN (1-4094)** field.
4. Click **Add** to add the VLAN to the list.

The screenshot shows the 'Discovery' configuration page. At the top, there are tabs for 'Global', 'Discovery', 'AAA / RADIUS', 'Radio', 'SSID', and 'Valid AP'. The 'Discovery' tab is active. Below the tabs is the 'Wireless Discovery Configuration' section. It is divided into two main areas: 'L3/IP Discovery' and 'L2/VLAN Discovery'. 'L3/IP Discovery' has an unchecked checkbox and an empty 'IP List' field. 'L2/VLAN Discovery' has a checked checkbox and a 'VLAN List' containing '1 - Default', '2 - Engineering', and '3 - Marketing'. Below these lists are input fields for 'IP Address Range' (with 'From' and 'To' sub-fields) and 'VLAN (1-4094)' (with the value '4'). There are 'Add' and 'Delete' buttons for each list. At the bottom of the configuration area are 'Refresh', 'Submit', and 'Next' buttons.

5. Click **Submit** to apply the changes.

From the Unified Switch, you can check the discovery status. To view information about whether the switch discovered the AP, click the **Monitoring > Access Points > Managed Access Points** tab. If you have not added the MAC address of the AP to the local or RADIUS Valid AP database, the AP appears in the **Monitoring > Access Point > Authentication Failed Access Points** list, and the failure type is listed as No Database Entry. For more information about AP validation, see [“Authenticating and Validating Access Points”](#) on page 70.

The following example shows how to add a VLAN to the list by using the CLI.

1. From a Telnet, SSH, or serial connection, log on to the D-Link Unified Switch and enter the Wireless Configuration mode.

```
(switch-prompt) >enable
Password:
(switch-prompt) #config
(switch-prompt) (Config)#wireless
```

2. Add a VLAN to the discovery list:

```
(switch-prompt) (Config-wireless)#discovery vlan-list 4
```

3. Enter CTRL + Z to return to Privileged EXEC mode.

4. Save the changes to the configuration file:

```
(switch-prompt) #write
```

```
This operation may take a few minutes.
Management interfaces will not be available during this time.
```

```
Are you sure you want to save? (y/n) y
```

```
Configuration Saved!
```

To check the managed status from the Unified Switch CLI, enter the following command:

```
(switch-prompt) #show wireless ap status
```

Configuring IP Addresses of Peers and APs in the Switch

You can configure up to 256 IP addresses for potential peer switches and APs in the D-Link Unified Switch. The switch sends association invitations to all IP addresses in this list. If the device accepts the invitation and is successfully validated by the switch, the switch and the AP or peer switch are associated.

This discovery method mechanism is useful for peer switch discovery and AP discovery when the devices are in different IP subnets. In fact, for a switch to recognize a peer that is not on the same subnet, you must configure the IP addresses of each switch in the peer’s L3 discovery list.

NOTE: The list of IP addresses is separate and independent from the list of valid managed APs. Devices discovered through this list might not be valid APs or switches.

NOTE: If an AP has already been discovered through another method, the Unified Switch will not poll the IP address of the AP.

Table 6. L3/IP Discovery

Field	Description
L3/IP Discovery	This check box is used to enable or disable IP-based discovery of access points and peer unified switches. When checked, IP polling is enabled and the switch will periodically poll each address in the configured IP List. By default, L3/IP Discovery is enabled.
IP List	The list of IP addresses configured for discovery, to remove entries from the list select one or more entries and press the delete button. There are no default entries, the maximum number of entries supported is 256.
IP Address Range	This text field is used to add a range of IP address entries to the IP List. Enter the IP address at the start of the address range in the From field, and enter the IP address at the end of the range in the To field, then click Add . All IP addresses in the range are added to the IP List. Once all desired entries are added, click Submit to save the list in the running configuration. NOTE: To add a single IP address, enter the address in the From field and leave the To field blank, then click Add .

To view the IP address of the AP, log on to the AP as described in “[Logging on to the AP](#)” on page 54 and enter the `get management` command.

Use the following procedures to add the IP address of a peer switch or AP to the discovery list by using the Web interface:

1. Use a browser to log on to the D-Link Unified Switch.
2. From the Navigation menu, click **Administration > Basic Setup**, then select the **Discovery** tab.
3. Clear the check box for **L2/IP Discovery** to prevent the switch from sending L2 Discovery messages.
4. Make sure the check box for **L3/IP Discovery** is selected and add the range of peer switch or D-Link Access Point IP addresses in the From and To fields next to **IP Address Range**.

If the IP addresses are non-contiguous or if you only want to add one IP address, enter the the address in the From field, and leave the To field blank.

5. Click **Add** to add the IP addresses to the list.

6. Click **Submit** to apply the changes to the switch.

To view information about whether the switch successfully polled the IP address you entered, click the **Monitoring > Global > IP Discovery** tab.

The following example shows how to add an address to the L3 Discovery list by using the CLI.

1. From a Telnet, SSH, or serial connection, log on to the D-Link Unified Switch and enter the Wireless Configuration mode.

```
(switch-prompt) >enable
Password:
(switch-prompt) #config
(switch-prompt) (Config)#wireless
```

2. Add the IP address of a peer switch or AP to the discovery list:

```
(switch-prompt) (Config-wireless)#discovery ip-list 192.168.6.211
```

From the CLI, you can only add one IP address at a time.

3. Enter CTRL + Z to return to Privileged EXEC mode.
4. Save the changes to the configuration file:

```
(switch-prompt) #write
```

This operation may take a few minutes.
Management interfaces will not be available during this time.

```
Are you sure you want to save? (y/n) y
```

```
Configuration Saved!
```

To check the managed AP status from the Unified Switch CLI, enter the following command:

```
(switch-prompt) #show wireless ap status
```

Setting the Switch IP Address in the D-Link Access Point

You can connect to the D-Link Access Point CLI and statically set the IP address or DNS name of the D-Link Unified Switch. You can configure up to four D-Link Unified Switches

for AP association, but you can only use one switch to manage the AP. The other three switches are backup or alternate switches.

Once you configure the AP with the IP addresses or DNS names of switches, the AP will only associate with those switches. Even if other switches discover the AP by using other mechanisms, the AP only accepts associations from the unified switches you configure. If you change the IP address of the switch that manages the AP, you must use a secondary switch to manage the AP. You can connect directly to the AP CLI and configure the IP address of the switch that will manage the AP.

If you know the IP address of the D-Link Access Point, you can Telnet to the CLI. The default IP address of the AP is 10.90.90.91 with a default subnet mask of 255.0.0.0.

NOTE: For this method to work, the AP must be able to find a route to the Unified Switch.

1. Log on to the D-Link Access Point.

For information about how to log on to the AP, see [“Logging on to the AP”](#) on page 54.

2. Enter the IP address of up to four switches that are permitted to manage the AP.

For example, to enter a Unified Switch with an IP address of 192.168.66.202 and a Unified Switch with an IP address of 192.168.19.242, use the following commands:

```
WLAN-AP# set managed-ap switch-address-1 192.168.66.202
WLAN-AP# set managed-ap switch-address-2 192.168.19.242
```

3. Use the `get managed-ap` command to verify that the information you entered is correct.

```
WLAN-AP# get managed-ap
Property                               Value
-----
mode                                    up
ap-state                                down
switch-address-1                        192.168.66.202
switch-address-2                        192.168.19.242
switch-address-3
switch-address-4
dhcp-switch-address-1
dhcp-switch-address-2
dhcp-switch-address-3
dhcp-switch-address-4
managed-mode-watchdog 5
```

From the Unified Switch, you can check the discovery status. To view information about whether the switch discovered the AP, click the **Monitoring > Access Points > Managed Access Points** tab. It might take several minutes for the AP to discover the switch.

NOTE: If you have not added the MAC address of the AP to the local or RADIUS Valid AP database, the AP appears in the **Monitoring > Access Point > Authentication Failed Access Points** list, and the failure type is No Database Entry. For more information about AP validation, see [“Authenticating and Validating Access Points”](#) on page 70.

To check the Managed AP status from the Unified Switch CLI, enter the following command:

```
(switch-prompt) #show wireless ap status
```

Setting the Switch Information in the DHCP Option

Instead of statically configuring the unified switch IP address in the AP, you can configure the DHCP server on your network to pass the IP addresses of up to four D-Link Unified Switches to the access point in DHCP option 43. If you configured a static IP address in the D-Link Access Point, the AP ignores DHCP option 43.

The procedures to add the DHCP option to the DHCP server depend on the type of DHCP server you use on your network. If you use a Microsoft Windows 2000 or Microsoft Windows 2003 DHCP Server, you configure the scope you use with the access points with DHCP Option 43, as the following procedures describe.

1. From the DHCP manager, right-click the applicable scope and select **Configure Options...**

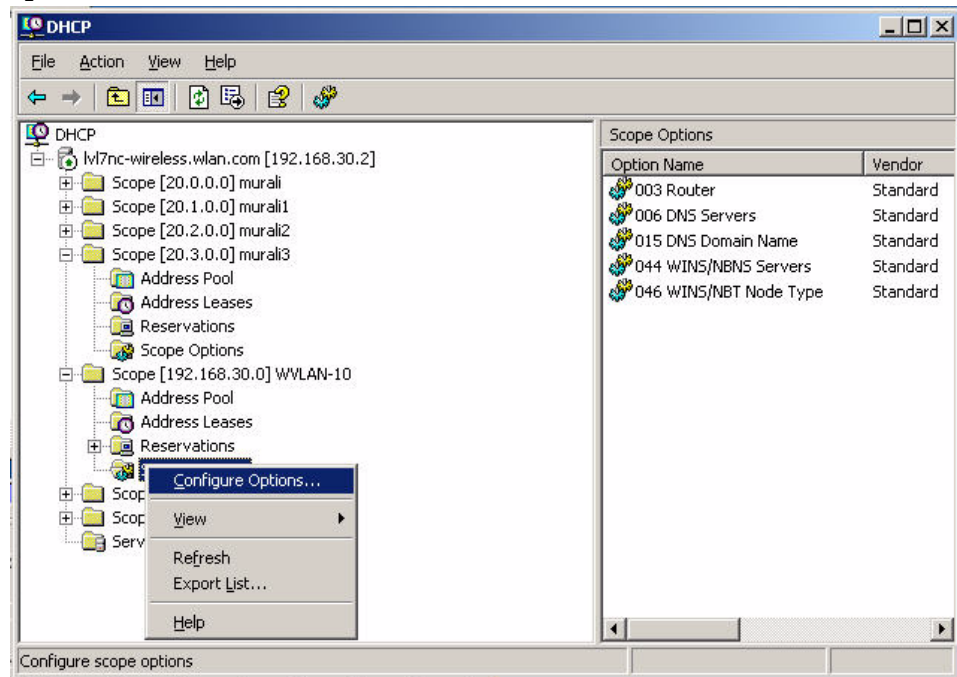

2. From the Available Options list, scroll to Option 43 and select the **043 Vendor Specific Info** check box.
3. Enter the Option 43 data into the Data Entry field.

The format for DHCP option 43 values are defined by RFC 2132. To enter an IP address of 192.168.1.10 into the Binary column, you enter the data type code (01) and the address length (04), followed by the IP address in hexadecimal format. You repeat the data type and address length codes for each address you enter.

For example, to add the four switch IP addresses 192.168.1.10, 192.168.2.10, 192.168.3.10, and 192.168.4.16 to Option 43, you enter the following hexadecimal numbers into the Data Entry field:

```
01 04 0C A8 01 0A 01 04 0C A8 02 0A 01 04 0C A8 03 0A 01 04 0C A8 04 10
```

The following image shows the four IP addresses entered into the Data Entry field on the Windows DHCP server.

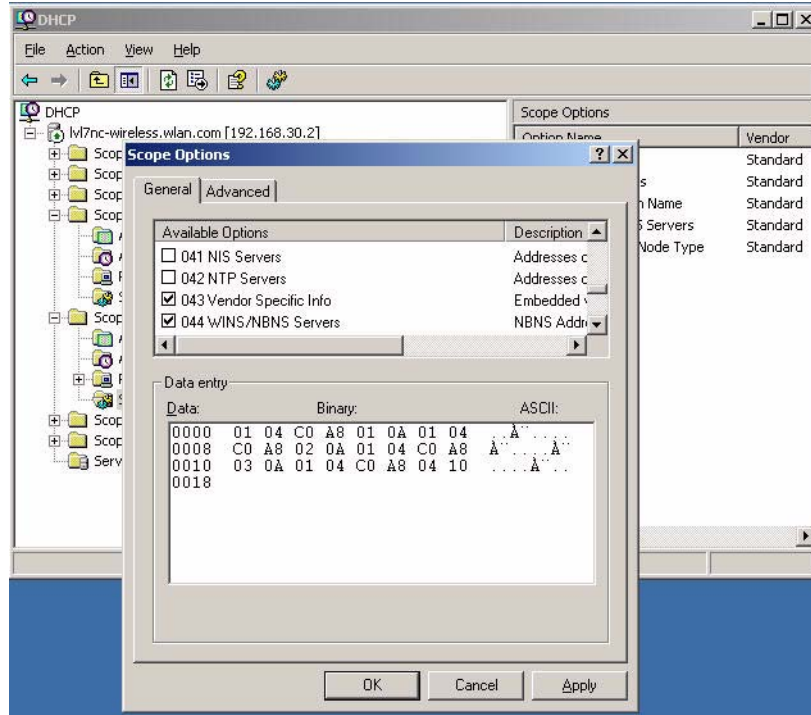

4. Click OK.

The following figure shows a scope with Option 43 configured.

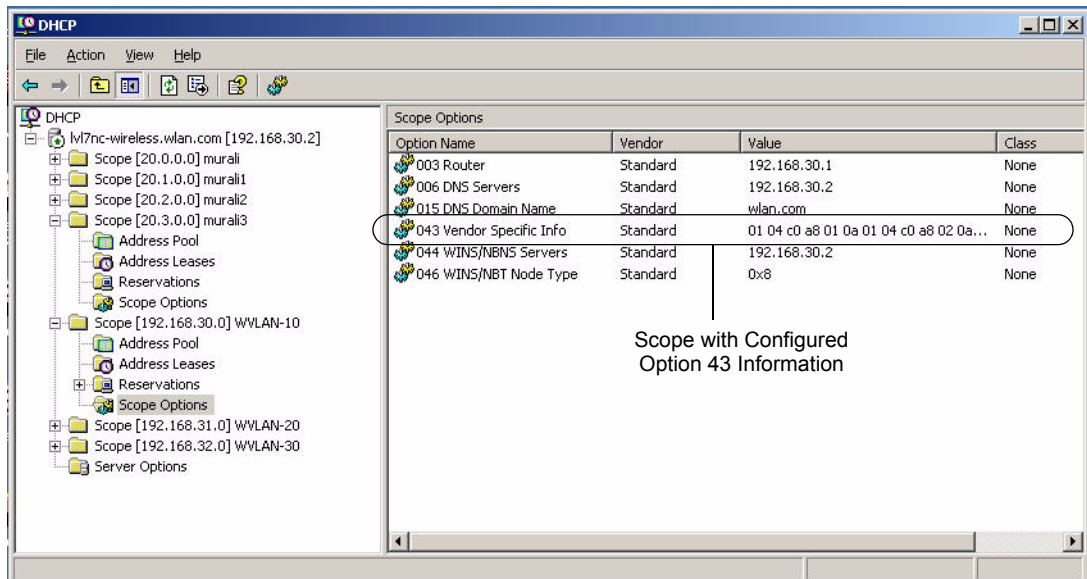

Authenticating and Validating Access Points

For a D-Link Unified Switch to manage an AP, you must add the MAC address of the AP to the local or external RADIUS database. When the switch discovers an AP that is not managed

by another Unified Switch, it looks up the MAC address of the AP in the local or RADIUS Valid AP database. If it finds the MAC address in the database, the switch validates the AP and assumes management. If you have not added the MAC address of the AP to the database, the AP appears in the Authentication Failed Access Points list, and the failure type is No Database Entry.

Optionally, you can require that the AP is authenticated before the Unified Switch manages it. You can add authentication information about the AP when you add its MAC address to the local or RADIUS database. If you enable authentication, it takes place immediately after the switch validates the AP.

NOTE: When a switch successfully validates an AP, it sends an AP Profile to the access point. The AP Profile contains all of the access point configuration information, such as the radio, security, and SSID settings. You can configure all of the AP settings *before* the switch validates an AP. For information about configuring the default AP profile, see Chapter 5, “[Configuring Access Point Settings](#)” on page 77.

Configuring AP Authentication

Unless access to the wired network is secured with IEEE 802.1x authentication or another security mechanism, the AP should always use authentication so that Rogue APs do not automatically associate with the switch.

If you require the AP to authenticate itself to the switch, you must perform the following three steps:

1. Enable AP authentication on the switch, which is described in this section.
2. Connect to the access point CLI and configure a pass phrase as described in “[Preparing the Access Points](#)” on page 54.
3. Enter the pass phrase in the Valid AP database.

To enter a pass phrase in the local database, see “[Using the Local Database for AP Validation](#)” on page 72. To enter a pass phrase in the RADIUS database, see “[Using the RADIUS Database for AP Validation](#)” on page 74.

To enable AP authentication on the Unified Switch, click **Administration > Basic Setup**. From the **Global** tab, check the AP Authentication box, then click **Submit** to apply your changes.

Figure 34. Requiring AP Authentication

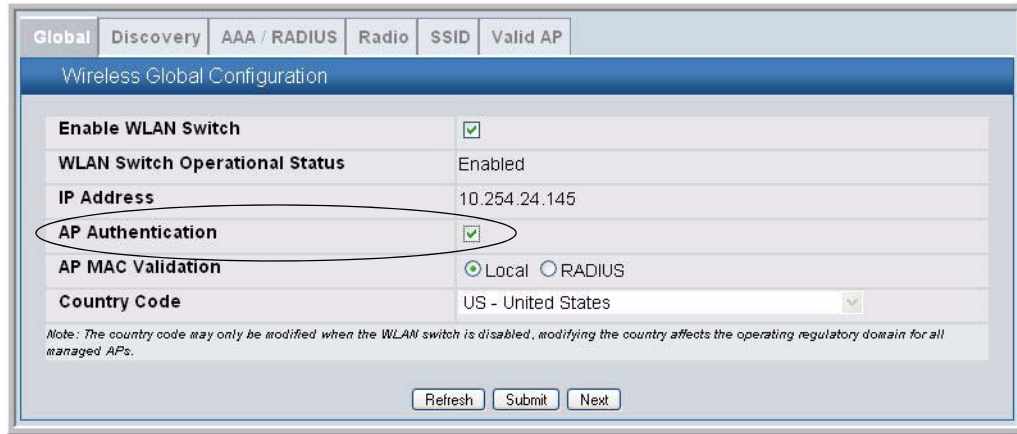

To enable AP authentication from the CLI, access Wireless Config mode and enable authentication:

```
(switch-prompt) >enable
Password:
(switch-prompt) #config
(switch-prompt) (Config)#wireless
(switch-prompt) (Config-wireless)#ap authentication
```

Using the Local Database for AP Validation

To use the local Valid AP database, set the AP Validation to local, add APs to the database, and configure the settings for the APs in the database. All of the configuration takes place on the switch.

To set up the local database for AP Validation, use the following steps:

1. From the **Administration > Basic Setup > Global** page, make sure AP Validation is set to **Local**, which is the default.
2. Click **Submit** if you made any changes.
3. Click the **Valid AP** tab.

- In the MAC Address field, enter the MAC address of the AP to validate, and enter the physical location of the AP in the second field, then click **Add**.

NOTE: If the switch has already discovered the AP, the MAC address of the AP appears on the **Monitoring > Access Points > Managed Access Points** page or on the **Monitoring > Access Point > Authentication Failed Access Points** page. To view the MAC address of discovered APs from the CLI, enter `show wireless ap status` or `show wireless ap failure status` in Privileged EXEC mode.

After you add the AP, additional fields appear so you can provide configuration information about the AP, including a passphrase for AP authentication.

- If you selected the AP Authentication check box on the **Wireless Global Configuration** page, select the Apply check box and enter an authentication password for the AP.

The password must match the pass phrase that you configured on the AP. The length of the password can be 8-63 alphanumeric characters, but for good security, you should enter at least 24 characters.

- Use the default settings or configure other information about the AP, such as the channel the AP uses and the strength of the power transmission.

For more information about the fields on the **Valid Access Point Configuration** page and how to configure valid APs, see [“Configuring Valid Access Point Settings”](#) on page 98.

- Click **Submit** to apply your changes to the running configuration.

The following example shows how to configure the local database by using the CLI:

1. Log on to the switch and enter Wireless Config Mode.

```
(switch-prompt) >enable
Password:
(switch-prompt) #config
(switch-prompt) (Config)#wireless
```

2. Set the local database as the validation method.

```
(switch-prompt) (Config-wireless)#ap validation local
```

3. Enter the MAC address of the AP to add to the database and configure a password:

```
(switch-prompt) (Config-wireless)#ap database 00:02:BC:00:14:40
```

4. If you require AP-to-switch authentication, enter the pass phrase for the AP

```
(switch-prompt) (Config-ap)#password
Enter password (8 - 63 characters):*****
Re-enter password:*****
```

For information about configuring additional database parameters for an AP by using the CLI, see the *D-Link CLI Command Reference*.

Using the RADIUS Database for AP Validation

To use a RADIUS server to validate the AP, you must configure settings on both the Unified Switch and the RADIUS server. From the switch, set the AP Validation to RADIUS and configure information about the RADIUS server, such as its IP address. From the RADIUS server, configure information about the Valid APs, including the pass phrase for AP authentication. For information about the parameters to configure on the RADIUS server, see Appendix B, “[Configuring the External RADIUS Server](#)” on page 179.

When you enable RADIUS as the validation method, the local Valid AP database is not used. The Valid AP database is only used for local authentication and validation.

To use a RADIUS server for the Valid AP database, use the following procedures:

1. From the **Administration > Basic Setup > Global** page, set AP Validation to **RADIUS**.
2. Click **Submit** to apply the changes.
3. From the **LAN** menu, click **Security > RADIUS > Authentic Radius Configuration**.

The RADIUS settings in the **AAA/RADIUS** tab in the Wireless Global Configuration Basic Setup are applied to access points that use the default AP Profile - and not to the switch. If you require a RADIUS server to authenticate wireless clients before they can associate with an AP, you configure the settings in the **AAA/RADIUS** tab as described in “[Configuring AAA and RADIUS Settings](#)” on page 79.

4. Enter the IP address of the RADIUS server to use for the valid AP database and click **Submit**.

Authentic RADIUS Server Configuration

RADIUS Server IP Address	Add
IP Address	192.168.10.5

Submit

Additional fields appear.

5. Configure information that the Unified Switch must use to contact the RADIUS server on your network, such as the shared secret.

Authentic RADIUS Server Configuration

RADIUS Server IP Address	192.168.10.5
Port	1812 (0 to 65535)
Secret	***** <input checked="" type="checkbox"/> Apply
Primary Server	Yes
Message Authenticator	Enable
Secret Configured	No
Current	Yes

Submit Remove Refresh

6. Click **Submit** to apply your changes.

The following example shows how to configure RADIUS authentication by using the CLI:

1. Enter the Wireless Config mode.

```
(switch-prompt) >enable
Password:
(switch-prompt) #config
(switch-prompt) (Config)#wireless
```

2. Set the RADIUS server as the validation method.

```
(switch-prompt) (Config-wireless)#ap validation radius
```

3. Exit to Global Config Mode and configure the RADIUS settings.

In the following command example, the RADIUS server IP address is 192.168.2.2.

```
(switch-prompt) (Config-wireless)#exit
(switch-prompt) (Config)#radius server host auth 192.168.2.2
(switch-prompt) (Config)#radius server key auth 192.168.2.2
Enter secret (16 characters max):*****
Re-enter secret:*****
```

For information about configuring additional RADIUS parameters by using the CLI, see the *D-Link CLI Command Reference*.

Managing Failed or Rogue APs

If an AP attempts to contact a switch but the authentication fails or if the MAC address of an AP is not in the Valid AP database, AP Validation fails and the AP appears in the list on the **Authentication Failed Access Points** page. If the switch learns about an AP that is not in the database, and the AP has not tried to discover the switch, the AP appears in the list on the **Rogue/RF Scan Access** page.

You can add the AP to the local Valid AP database from the list on the **Authentication Failed Access Points** page or the **Rogue/RF Scan Access** page.

To add an AP from the **Authentication Failed Access Points** page or the **Rogue/RF Scan Access** page to the local Valid AP database, use the following procedures:

1. Access either the **Authentication Failed Access Points** page or the **Rogue/RF Scan Access** page from the by clicking **Monitoring > Access Point** folder.
2. Select the check box associated with the AP and click **Manage**.

The AP is added to the Valid AP database, and its MAC address appears in the list on the **Administration > Basic Setup > Valid AP** page. If the switch requires AP Authentication for all APs, click the MAC address of the AP to configure the pass phrase.

NOTE: You cannot add an AP to the RADIUS database from the AP authentication failure page. If you use a RADIUS server for AP Validation, you must enter the AP information into the RADIUS database.

To view the list of failed APs by using the CLI, use the `show wireless ap failure status` command in Privileged EXEC mode. To view the list of APs detected through the RF scan, use the `show wireless ap rfscan status` command.

To add a failed or rogue AP to the local Valid AP database, use the procedures described in [“Using the Local Database for AP Validation”](#) on page 72.

Configuring Access Point Settings

After you validate a D-Link Access Point that associates with a switch, the switch assumes management functions for the AP. You can configure all of the AP settings directly from the switch before or after you validate the AP. This chapter describes the AP settings and how to manage them by using the D-Link Unified Switch.

This chapter contains the following sections:

- [AP Profiles, Networks, and the Local Database](#)
- [Configuring AAA and RADIUS Settings](#)
- [Configuring Wireless Radio Settings](#)
- [Configuring SSID Settings](#)
- [Configuring Valid Access Point Settings](#)

For information about the commands you use to configure access point settings by using the CLI, see the *D-Link CLI Command Reference*.

NOTE: Changing some access point settings might cause the AP to stop and restart system processes. If this happens, wireless clients will temporarily lose connectivity. We recommend that you change access point settings when WLAN traffic is low.

AP Profiles, Networks, and the Local Database

This section provides an overview of the access point profiles, wireless networks, and the local access point database that you configure on the D-Link Unified Switch.

Access Point Profiles

You manage the configuration of D-Link Access Points through the use of configuration profiles. A profile is like a configuration template that you can apply to one or more APs. The D-Link Unified Switch allows you to create multiple configuration profiles for access points. When you validate an AP, you can specify which profile the AP receives.

You can define many AP profiles on the Unified Switch, but each access point can only have one profile at a time. You can use the same profile for multiple APs, or you can create a unique profile to assign each AP that the switch manages. An existing profile and all of its

configurations may be copied to another profile or used to create a new profile. Each configuration profile can have unique settings for the following access point features:

- RADIUS server settings
- MAC authentication list
- Radio interface and RF configuration
- QOS Configuration
- Virtual Access Point (VAP) Configuration

When you modify and apply a profile, the switch applies the changes to the APs it manages that use the modified profile.

NOTE: The switch only applies the changes to the APs after you explicitly apply the profile on the **Advanced Configuration > AP Profile** page or use the `ap profile apply` command.

Until you apply the updated profile to the APs, the APs continue to operate with the original AP profile settings. If you assign a new profile to the AP in the Valid AP database, you must reset the AP.

All of the AP settings that you configure from the tabs on the **Basic Setup** page are for the default AP profile. When you make changes to these settings, the settings affect all APs that use the default profile.

All of the fields that you configure for the default profile are also available for profiles that you create. For information about how to create a new profile and assign it to an AP, see [“Creating, Configuring, and Managing AP Profiles”](#) on page 149.

Networks

In general, a wireless client connects to an access point by choosing a network (identified by the SSID) from a list of available wireless networks. You configure these wireless networks, including their associated SSID, on the D-Link Unified Switch.

You manage the networks available on the WLAN by modifying or adding network configurations, which include settings for the SSID, VLAN ID, security, and tunneling parameters. You can associate a network with a Virtual APs (VAPs) within an AP configuration profile.

By default, the switch has 8 networks, and each network is associated with one of the 8 VAPs on each radio. You can modify (but not delete) the default network configurations and add new network configurations. The first network is configured with a default SSID "Guest Network," and the other networks have default SSIDs assigned based on the Network ID. All the default networks are configured with open authentication and assigned to the default VLAN 1. The default VLAN is used if RADIUS-based authentication is not configured for the network or the RADIUS server does not return a VLAN for a specific client.

Local Access Point Database

In order for a Unified Switch to manage an access point, you must add the physical MAC address of the AP to the Valid AP database. The Valid AP database can reside locally on the switch or externally on a RADIUS server. When an AP is discovered, the switch verifies the

AP's MAC address according to the validation mode (local or RADIUS) as long as the AP is enabled for Managed Mode and has been authenticated (if required). Once the AP is verified, it becomes managed by the switch.

If an AP is discovered and its MAC address is not found in the Valid AP database or the AP fails to authenticate, the switch adds an entry to the AP failure list. If you use the local Valid AP database, you can add the failed AP to the Valid AP database directly from the AP Authentication Failures page.

The Valid AP database stores additional information about the AP along with its MAC address such as the AP mode, local authentication password, and the AP profile that the access point uses. You can also manually set the channel and RF signal transmit power level for an individual AP, which overrides the channel and power settings in the AP profile.

Configuring AAA and RADIUS Settings

In the D-Link Unified Access System, you can use a RADIUS server for the following functions:

- Management of client-to-AP authentication and accounting
- Management of AP-to-Switch authentication and accounting
- Database for AP settings

The information in this section applies to the client-to-AP authentication and accounting management. For information about AP-to-switch management, see [“Using the RADIUS Database for AP Validation”](#) on page 74. For information about how to set AP database settings in the RADIUS server, see Appendix B, [“Configuring the External RADIUS Server”](#) on page 179.

The RADIUS server that you configure from the **Administration > Basic Setup > AAA/RADIUS** tab is the RADIUS server for the default AP profile. For each network, you can configure a unique RADIUS server or use the default RADIUS server.

When you use a RADIUS server for wireless client-to-AP communications, such as when clients use WPA Enterprise or WEP IEEE 802.1x security to connect to the AP, the AP is the RADIUS client and communicates with the RADIUS server. The unified switch does **not** tunnel packets between the AP and RADIUS server. This means that you must configure the AP as a client in the RADIUS server. For information about how to configure RADIUS clients, see [Appendix B](#).

[Table 7](#) describes the fields you can configure for the default AP profile RADIUS server.

Table 7. Global RADIUS Server

Field	Description
IP Address	This is the IP address of the RADIUS server the AP uses for authentication.
Secret	The RADIUS Secret is the shared secret key for the RADIUS server. Click the Edit check box to enter a secret. The text you enter is displayed as “*” characters to prevent others from seeing the RADIUS key as you type.
Accounting	RADIUS Accounting allows you to track and measure the resources a particular user has consumed such as system time and amount of data transmitted and received.

NOTE: If you access the RADIUS and MAC Authentication configuration information from the AP Profile page, the **Profile Name** field also appears. To rename the profile, delete the existing name and enter the new name in the field, then click **Submit**.

On the **AAA/RADIUS** tab, you can also configure a global list containing the MAC addresses of wireless clients to allow or deny access to APs. The list only applies to profiles that use local MAC Authentication, which is an **SSID** setting. MAC Authentication is disabled by default. For information about enabling MAC Authentication, see “[Configuring the Default Network](#)” on page 87.

If you select Allow as the default action, the wireless clients you add to the Allow MAC List can connect to the AP, and all other wireless clients are denied. If you select Deny as the default action, the wireless clients with the MAC addresses that you add to the Deny MAC list cannot associate with the AP.

NOTE: The MAC list label updates depending on the default action you select.

Figure 35. MAC Access Control

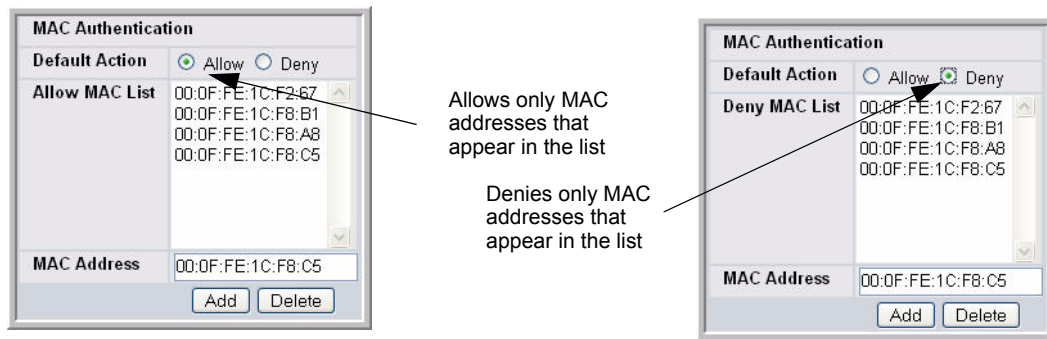

To add a wireless client to the MAC Authentication list, enter the MAC address of the client in the MAC Address field and click **Add**. You must click **Submit** to apply the changes.

The following table describes the MAC Authentication fields in more detail.

Table 8. MAC Authentication

Field	Description
Default Action	The default action is the action that is taken for unknown MAC addresses of wireless clients that attempt to associate with an access point. <ul style="list-style-type: none"> • Allow—Only the clients you explicitly add to this list are allowed access to APs that use MAC Authentication. • Deny—Only the clients you explicitly add to this list are denied access to APs that use MAC Authentication.
MAC List	This list shows the MAC address of the wireless clients that have already been added to the list of wireless clients to allow or deny access to the APs.
MAC Address	Enter the MAC address of the wireless client to allow or deny access to all APs that use this profile.

Configuring Wireless Radio Settings

The DWL-3500AP supports one radio that operates in IEEE 802.11g mode. The DWL-8500AP supports two radios: Radio 1 operates in IEEE 802.11a mode, and Radio 2 operates in IEEE 802.11g mode.

The difference between the IEEE 802.11 modes is the frequency in which they operate. IEEE 802.11g operates in the 2.4 GHz frequency, and IEEE 802.11a operates in the 5 GHz frequency of the radio spectrum.

You configure the default radio settings from the **Administration > Basic Setup > Radio** tab, which [Figure 36](#) shows.

NOTE: The radio settings for the IEEE 802.11g radio are directly below the settings for the IEEE 802.11a radio. When the profile is applied to the DWL-3500AP, only the settings for the IEEE 802.11g radio are applied.

Figure 36. Radio Settings

Summary		Default		
Global		Radio		
SSID		QoS		
Access Point Profile Radio Configuration				
AP Profile 1-Default				
State	<input checked="" type="radio"/> On <input type="radio"/> Off		Mode	802.11a
Super A	Disable		Maximum Clients	256 (0 to 256)
RTS Threshold (bytes)	2347 (0 to 2347)		DTIM Period (# beacons)	10 (1 to 255)
Load Balancing	<input type="checkbox"/>		Beacon Period (msecs)	100 (20 to 2000)
Load Utilization (%)	60 (1 to 100)		Automatic Channel	<input checked="" type="checkbox"/>
RF Scan Other Channels	<input checked="" type="checkbox"/>		Limit Channels	<input type="checkbox"/>
RF Scan Interval (secs)	60 (30 to 120)		Automatic Power	<input checked="" type="checkbox"/>
RF Scan Sentry	<input type="checkbox"/>		Initial Power (%)	100
RF Scan Sentry Channels	<input checked="" type="checkbox"/> 802.11a <input checked="" type="checkbox"/> 802.11b/g		Frag Threshold (bytes)	2346 (256 to 2346)
RF Scan Duration (msecs)	10 (10 to 2000)		Short Retries	7
Transmit Lifetime (msecs)	512		Long Retries	4
Receive Lifetime (msecs)	512			
Rate Sets (Mbps)	6 9 12 18 24 36 48 54			
Basic	<input checked="" type="checkbox"/> <input type="checkbox"/> <input checked="" type="checkbox"/> <input type="checkbox"/> <input checked="" type="checkbox"/> <input type="checkbox"/> <input type="checkbox"/> <input type="checkbox"/>			
Supported	<input checked="" type="checkbox"/> <input checked="" type="checkbox"/> <input checked="" type="checkbox"/> <input checked="" type="checkbox"/> <input checked="" type="checkbox"/> <input checked="" type="checkbox"/> <input checked="" type="checkbox"/> <input checked="" type="checkbox"/>			

The following table describes the fields you can configure from the **Radio** tab on the **Basic Setup** page. After you change the settings, click **Submit** to apply the settings.

Table 9. Radio Settings

Field	Description
State	<p>Specify whether you want the radio on or off by clicking On or Off.</p> <p>If you turn off a radio, the AP sends disassociation frames to all the wireless clients it is currently supporting so that the radio can be gracefully shutdown and the clients can start the association process with other available APs.</p>
Super A Super G	<p>Super A and Super G attempt to increase performance through bursting and frame compression. Performance increases when the AP communicates with Super A and Super G-enabled clients. However, with Super A and Super G enabled, the access point transmissions consume more bandwidth.</p> <ul style="list-style-type: none"> To enable Super A or Super G, select Enabled. To disable Super A or Super G, select Disabled. To enable Super A or Super G with Dynamic Turbo, select Enable with Dynamic Turbo.
RTS Threshold	<p>The RTS threshold specifies the packet size of a request to send (RTS) transmission. This helps control traffic flow through the access point, especially one with a lot of clients.</p> <p>If you specify a low threshold value, RTS packets will be sent more frequently. This will consume more bandwidth and reduce the throughput of the packet.</p> <p>On the other hand, sending more RTS packets can help the network recover from interference or collisions which might occur on a busy network, or on a network experiencing electromagnetic interference.</p> <p>The RTS Threshold value can be between 0 and 2347.</p>
Load Balancing	<p>If you enable load balancing, you can control the amount of traffic that is allowed on the AP.</p>
Load Utilization	<p>This field allows you to set a threshold for the percentage of network bandwidth utilization allowed on the radio. Once the level you specify is reached, the AP stops accepting new client associations.</p> <p>If you specify 0 in this field, all new associations will be allowed regardless of the utilization rate.</p>
RF Scan Other Channels	<p>The access point can perform RF scans to collect information about other wireless devices within range and then report this information to the Unified Switch.</p> <p>If you select the Scan Other Channels check box, the radio periodically moves away from the operational channel to scan other channels.</p> <p>Enabling this mode causes the radio to interrupt user traffic, which may be noticeable with voice connections. Changing the channels also causes the radio to lose auto-calibration settings which may degrade the signal quality.</p> <p>When the Scan Other Channels check box is not enabled the AP scans only the operating channel.</p>
RF Scan Interval	<p>This field controls the length of time between channel changes during the RF Scan.</p>

Table 9. Radio Settings

Field	Description
RF Scan Sentry	<p>If you select the RF Scan Sentry check box, the radio primarily performs dedicated RF scanning. The radio passively listens for beacons and traffic exchange between clients and other access points but does not accept connections from wireless clients. In sentry mode, all VAPs are disabled.</p> <p>In this mode, the radio switches from one channel to the next. The length of time spent on each channel is controlled by the scan duration. The default scan duration is 10 milliseconds.</p>
RF Scan Sentry Channels	<p>The radio can scan channels in the radio frequency used by the 802.11b/g band, the 802.11a band, or both bands. Select the channel band for the radio to scan.</p> <p>NOTE: The band selection applies only to radios in sentry mode.</p>
Rate Sets	<p>Check the transmission rate sets you want the access point to support and the basic rate sets you want the access point to advertise.</p> <p>Rates are expressed in megabits per second.</p>
Basic	<p>These numbers indicate rates that the access point will advertise to the network for the purposes of setting up communication with other APs and client stations on the network. It is generally more efficient to have an AP broadcast a subset of its supported rate sets.</p>
Supported	<p>These numbers indicate rates that the access point supports. You can check multiple rates (click a check box to select or de-select a rate). The AP automatically chooses the most efficient rate based on factors like error rates and distance of client stations from the AP.</p>
Mode	<p>The Mode defines the Physical Layer (PHY) standard the radio uses.</p> <p>The DWL-3500AP and Radio 1 on the DWL-8500AP use the IEEE 802.11g mode PHY standard. This mode is a higher speed extension (up to 54 Mbps) to the 802.11b PHY, while operating in the 2.4 GHz band. It uses orthogonal frequency division multiplexing (OFDM). It supports data rates ranging from 1 to 54 Mbps. IEEE 802.11b clients can use the 802.11g mode.</p> <p>Radio 2 on the DWL-8500AP use the IEEE 802.11a mode, which is a PHY standard that specifies operating in the 5 GHz U-NII band using orthogonal frequency division multiplexing (OFDM). It supports data rates ranging from 6 to 54 Mbps.</p> <p>If the radio state is disabled, the mode displays as Off.</p>
Maximum Clients	<p>Specify the maximum number of stations allowed to access this access point at any one time.</p> <p>You can enter a value between 0 and 256.</p>

Table 9. Radio Settings

Field	Description
DTIM Period	<p>The Delivery Traffic Information Map (DTIM) message is an element included in some beacon frames. It indicates which client stations, currently sleeping in low-power mode, have data buffered on the access point awaiting pick-up.</p> <p>The DTIM period you specify indicates how often the clients served by this access point should check for buffered data still on the AP awaiting pickup. Specify a DTIM period within the given range (1 - 255).</p> <p>The measurement is in beacons. For example, if you set this field to “1” clients will check for buffered data on the AP at every beacon. If you set this field to 10, clients will check on every 10th beacon.</p>
Beacon Period	<p>Beacon frames are transmitted by an access point at regular intervals to announce the existence of the wireless network. The default behavior is to send a beacon frame once every 100 milliseconds (or 10 per second).</p> <p>The Beacon Interval value is set in milliseconds. Enter a value from 20 to 2000.</p>
Automatic Channel	<p>The channel defines the portion of the radio spectrum that the radio uses for transmitting and receiving. The range of channels and the default channel are determined by the Mode of the radio interface.</p> <p>When the AP boots, the AP scans the RF area for occupied channels and selects a channel from the available non-interfering, or clear channels. However, channel conditions can change during operation.</p> <p>Enabling the Automatic Channel makes APs assigned to this profile eligible for auto-channel selection. You can automatically or manually run the auto-channel selection algorithm to allow the Unified Switch to adjust the channel on APs as WLAN conditions change.</p> <p>By default, the global auto-channel mode is set to manual. To enable the automatic channel selection mode, go to the AP Management > RF Management page and select Fixed or Interval for the Channel Plan mode. You can also run the automatic channel selection algorithm manually from the Manual Channel Plan page.</p> <p>NOTE: If you assign a static channel to an AP in the Valid AP database or on the Advanced AP Management page, the AP will not participate in the auto-channel selection.</p>
Limit Channels	<p>If the radio is operating in 802.11a mode, you can select the Limit Channels check box to allow the AP to select from the available channels.</p> <p>NOTE: The available channels depends on the country in which the APs operate.</p> <p>If the Limit Channels option is not selected, the AP can also broadcast on channels 149, 153, 157, 161, and 165. Some legacy 802.11a adapters might not support these higher channel numbers.</p>

Table 9. Radio Settings

Field	Description
Automatic Power	<p>The power level affects how far an AP broadcasts its RF signal. If the power level is too low, wireless clients will not detect the signal or experience poor WLAN performance. If the power level is too high, the RF signal might interfere with other APs within range.</p> <p>Automatic power uses a proprietary algorithm to automatically adjust the RF signal to broadcast far enough to reach wireless clients, but not so far that it interferes with RF signals broadcast by other APs. The power level algorithm increases or decreases the power level in 10% increments based on presence or absence of packet retransmission errors.</p>
Initial Power	<p>The automatic power algorithm will not reduce the power below the number you set in the initial power field. By default, the power level is 100%. Therefore, even if you enable the automatic power, the power of the RF signal will not decrease.</p> <p>The power level is a percentage of the maximum transmission power for the RF signal.</p>

If you access the Access Point Profile Radio configuration through the **Advanced Configuration > AP Profile > Radio** tab, some additional fields are available for configuration.

The following table describes the fields for the AP radio that are only available from the Advanced Configuration menu.

Table 10. Advanced Radio Configuration

Field	Description
RF Scan Duration	This field controls the amount of time the radio spends scanning the other channel (in milliseconds) during an RF scan.
Transmit Lifetime	Shows the number of milliseconds to wait before terminating attempts to transmit the MSDU after the initial transmission.
Receive Lifetime	Shows the number of milliseconds to wait before terminating attempts to reassemble the MMPDU or MSDU after the initial reception of a fragmented MMPDU or MSDU.
Frag Threshold	The fragmentation threshold limits the size of packets transmitted over the network. Acceptable values are <i>even</i> numbers from 256-2345. Packets that are under the configured size are not fragmented. A value of 2346 means that packets are not fragmented.
Short Retries	The value in this field indicates the maximum number of transmission attempts on frame sizes less than or equal to the RTS Threshold. The range is 1-255.
Long Retries	The value in this field indicates the maximum number of transmission attempts on frame sizes greater than the RTS Threshold. The range is 1-255.

Configuring SSID Settings

The **SSID** tab displays the virtual access point (VIAP) settings associated with the default AP profile. Each VAP has an associated network, which is identified by its network number and Service Set Identifier (SSID). You can configure and enable up to 8 VAPs per radio on each physical access point.

Figure 37. VAP Settings

SSID	VLAN	L3 Tunnel	Hide SSID	Security
<input checked="" type="checkbox"/> Guest Network	1-Default	Disabled	Disabled	None
<input type="checkbox"/> Managed SSID 2	1-Default	Disabled	Disabled	None
<input type="checkbox"/> Managed SSID 3	1-Default	Disabled	Disabled	None
<input type="checkbox"/> Managed SSID 4	1-Default	Disabled	Disabled	None
<input type="checkbox"/> Managed SSID 5	1-Default	Disabled	Disabled	None
<input type="checkbox"/> Managed SSID 6	1-Default	Disabled	Disabled	None
<input type="checkbox"/> Managed SSID 7	1-Default	Disabled	Disabled	None
<input type="checkbox"/> Managed SSID 8	1-Default	Disabled	Disabled	None

VAPs segment the wireless LAN into multiple broadcast domains that are the wireless equivalent of Ethernet VLANs. To a wireless client, each VAP appears to be a single physical access point. However, since the VAPs use the same channel, there is no risk of RF interference among the networks that are on a single AP.

VAPs can help you maintain better control over broadcast and multicast traffic, which affects network performance. You can also configure different security mechanisms for each VAP.

A VAP is a “physical” entity. Each VAP maps directly to a MAC address. A network is a logical entity that you apply to a VAP. Networks are identified by a network number and an associated SSID. The SSID does not need to be unique for each network. You can create and modify a network in one place and apply the network to one or more VAP as needed. This allows you to mix networks within different profiles without having to reconfigure everything. When you edit a network configuration that is applied to more than one VAP, you edit it for every VAP that uses the network.

Managing Virtual Access Point Configuration

The Default AP profile has one VAP enabled by default. The default VAP uses the Guest Network SSID, and there is no security to prevent wireless clients from associating with the VAP. To enable additional VAPs, select the check box next to the VAP. Once you enable a VAP, you can select the network (SSID) to use from the drop-down menu. To change Network settings, click **Edit**.

The following table describes the fields on the **SSID** page.

Table 11. Default VAP Configuration

Field	Description
Radio 1 Radio 2	You configure the VAPs for Radio 1 and Radio 2 separately. Select the radio to configure the settings for before you enable the VAP.
Check Box	This check box enables or disables the corresponding VAP on the radio. When checked, the VAP is enabled. The SSID field on the page is also enabled to allow network selection for the VAP. NOTE: You cannot disable the default VAP, VAP0.
Network	The drop-down menu lists the available networks that you can assign to the VAP. You can configure up to 64 separate networks on the switch and apply them across multiple radio and VAP interfaces. By default, eight networks are pre-configured and applied in order to the VAPs on each radio. To configure additional networks, click Advanced Configuration > Networks .
Edit	Click Edit to modify settings for the corresponding network. When you click edit, the Wireless Network Configuration page appears.
VLAN	Shows the VLAN ID of the VAP. To change this setting, click Edit .
L3 Tunnel	Shows whether L3 Tunneling is enabled on the VAP. To change this setting, click Edit . NOTE: When L3 tunneling is enabled the VLAN ID is not used. In fact, the switch puts the management VLAN ID, if any, on the tunneled packets.
Hide SSID	Shows whether the VAP broadcasts the SSID. If enabled, the SSID for this network is not included in AP beacons. To change this setting, click Edit .
Security	Shows the current security settings for the VAP. To change this setting, click Edit .

Configuring the Default Network

Each network is identified by its Service Set Identifier (SSID), which is an alphanumeric key that identifies a wireless local area network. You can configure up to 64 different networks on the D-Link Unified Switch. Each network can have a unique SSID, or you can configure multiple networks with the same SSID.

When you click Edit on the VAP page, the Wireless Network Configuration page appears, as Figure 38 shows.

Figure 38. Configuring Network Settings



Table 12 describes the fields on the Wireless Network Configuration page. After you change the wireless network settings, click **Submit** to save the changes.

Table 12. Wireless Network Configuration

Field	Description
SSID	Wireless clients identify a wireless network by the SSID, which is an alphanumeric key that uniquely identifies a wireless local area network. The SSID can be up to thirty-two characters in length, and there are no restrictions on the characters that may be used in an SSID.
Hide SSID	<p>You can hide the SSID broadcast to discourage stations from automatically discovering your access point. When the broadcast SSID of the AP is hidden, the network name is not displayed in the list of available networks on a client station. Instead, the client must have the exact network name configured in the supplicant before it is able to connect.</p> <p>Disabling the broadcast SSID is sufficient to prevent clients from accidentally connecting to your network, but it will not prevent even the simplest of attempts by a hacker to connect, or monitor unencrypted traffic.</p> <p>This offers a very minimal level of protection on an otherwise exposed network (such as a guest network) where the priority is making it easy for clients to get a connection and where no sensitive information is available.</p>

Table 12. Wireless Network Configuration

Field	Description
VLAN	<p>A virtual LAN (VLAN) is a software-based, logical grouping of devices on a network that allow them to act as if they are connected to a single physical network, even though they may not be. The nodes in a VLAN share resources and bandwidth, and are isolated on that network.</p> <p>The D-Link Unified Access System supports the configuration of a wireless VLAN. You can configure each VAP to be on a unique VLAN or on the same VLAN as other VAPs.</p> <p>When a wireless client connects to the AP by using this network (SSID), the AP tags the client's traffic with the VLAN ID you configure in this field. By default, all networks use VLAN 1, which is also untagged by default.</p> <p>NOTE: The VLAN ID you configure in this field can be overwritten by the VLAN ID configured for the AP in the RADIUS server. In other words, if your network uses a RADIUS server to assign wireless clients to VLANs, the wireless client uses the VLAN ID from the RADIUS server and ignores the VLAN ID configured on the VAP.</p>
L3 Tunnel	<p>The L3 Tunnel feature allows mobile stations to maintain their IP connections while roaming from one access point to another access point even when these access points are attached to different IP subnets.</p> <p>NOTE: When L3 tunneling is enabled the VLAN ID is not used. In fact, the switch puts the management VLAN ID, if any, on the tunneled packets.</p> <p>Before you enable this feature, make sure your network meets the design requirements described in “Network Planning to Support Layer 3 Roaming” on page 35.</p> <p>For more information about the L3 Roaming network, see “Configuring a VAP for L3 Tunnels” on page 91.</p>
L3 Tunnel Status	<p>This field shows the status of L3 Tunneling. In order for tunnel to be completely configured, routing must be enabled and the switch must have a routing interface IP address that is in the tunnel subnet. The the status can be one of the following:</p> <ul style="list-style-type: none"> • None (L3 Tunnel is disabled or the network is not associated with any AP profiles) • Configured • Not Configured - Routing Disabled • Not Configured - No Routing Interface
L3 Tunnel Subnet	<p>The network IP address you enter in this field must be in the same subnet as a routing interface for the WLAN that you define on the switch.</p>
L3 Tunnel Mask	<p>Enter the subnet mask for the network IP address on the L3 Tunnel subnet.</p>
MAC Authentication	<p>If you enable MAC authentication, wireless clients must be authenticated by the AP in order to connect to the network. You must configure the MAC addresses of the clients to accept or deny (based on the default action you set in the AP profile) in one of the following databases:</p> <ul style="list-style-type: none"> • Local • RADIUS

Table 12. Wireless Network Configuration

Field	Description
RADIUS IP Address	<p>If you use a RADIUS server to authenticate wireless clients, you can use the same RADIUS server that you configure on the AAA/RADIUS tab for the profile, or you can specify a different RADIUS server.</p> <p>To specify a RADIUS server for this VAP, clear the Use Profile check box and enter the IP address of the RADIUS server in the field.</p>
RADIUS Secret	<p>To enter a RADIUS secret, select the Edit check box and type the secret in the field.</p>
RADIUS Accounting	<p>Select the RADIUS Accounting check box to enable accounting for wireless clients on the specified RADIUS server.</p>
Security	<p>The default AP profile does not use any security mechanism by default. In order to protect your network, we strongly recommend that you select a security mechanism so that unauthorized wireless clients cannot gain access to your network.</p> <p>The following WLAN network security options are available:</p> <ul style="list-style-type: none"> • None • WEP • WPA/WPA2 <p>If you select WEP or WPA/WPA2 as your security mechanism, a dialogue box asks if you want to change network security. After you click OK, additional fields appear, and any network settings that you modified are applied to the switch.</p> <p>“Configuring AP Security” on page 93 describes the security mechanisms and the additional fields you can configure if you select WEP or WPA/WPA2.</p>

Enabling and Configuring Additional VAPs

When a wireless client searches for available wireless networks, each VAP you enable on the **VAP** tab appears as a separate network to the wireless client. [Figure 39](#) shows an example of an AP Profile with five VAPs enabled. Each VAP uses a different network.

Figure 39. AP Profile With Five VAPs Enabled

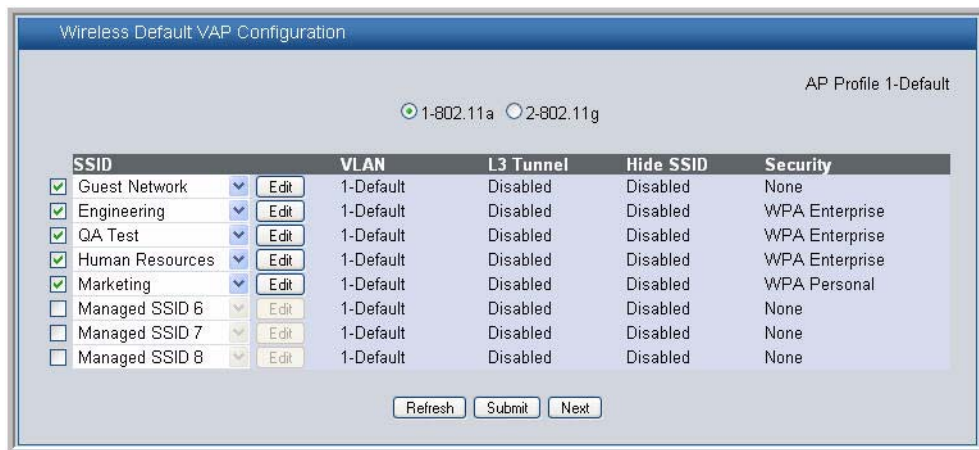
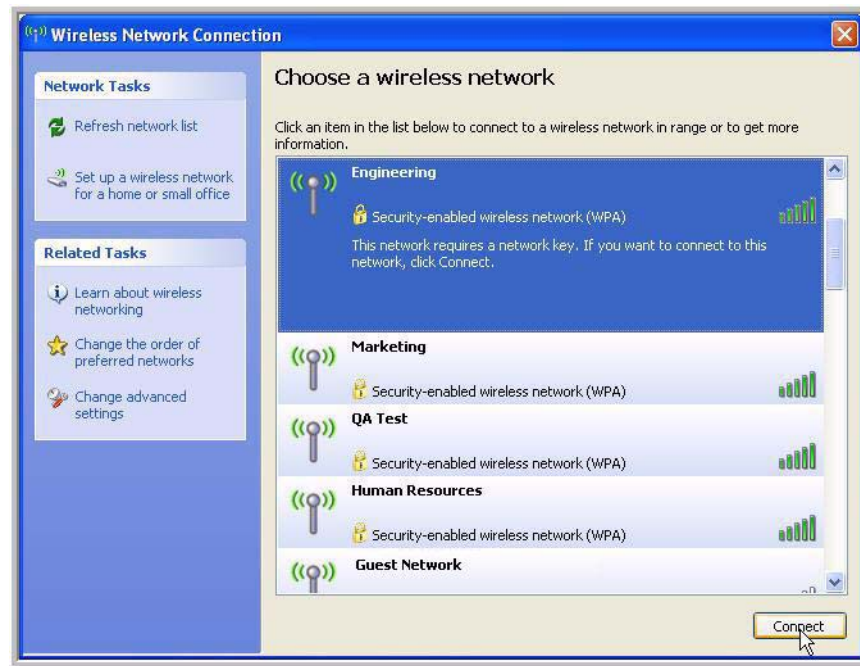

Figure 40 shows what a user on a Microsoft Windows XP client sees when the user searches for wireless networks within range.

Figure 40. Networks Available to the Wireless Client



Although the wireless client finds five different wireless networks, these networks are all on the same access point. The D-Link Access Point looks like five separate access points to the wireless client.

In this example, the administrator configured multiple VAPs based on different functional groups within the company. Each VAP has a different SSID, security settings, and VLAN ID to separate traffic.

You can associate the same network (SSID) with multiple VAPs. When you do this, the VAPs look like the same network to wireless clients. Some administrators configure VAPs with identical settings on each radio so that wireless clients can connect to the same network whether their wireless adapters are 802.11a or 802.11b/g compatible.

By default, both radios have the same networks assigned to the VAPs, and only VAP0 is enabled. You must configure each radio independently. In other words, if you enable additional VAPs on one radio, it does not affect the VAPs on the second radio.

Configuring a VAP for L3 Tunnels

This section provides an overview of the L3 Tunneling feature. For a detailed configuration example of a network that uses L3 roaming, see Appendix C, “[L3 Roaming Example](#)” on page 187.

The L3 Tunnel feature allows mobile stations to maintain their IP connections while roaming from one access point to another access point even when these access points are attached to

different IP subnets. This feature is especially useful for environments that use wireless Voice over IP (VoIP) on the 802.11 networks with multiple subnets.

Without IP tunneling, when a wireless client roams between APs that are on different subnets, the client's IP address changes and the IP connections are dropped. When the IP connection drops, time-sensitive traffic, such as voice, is affected. L3 roaming allows the client to continue using the same IP address even when roaming among different subnets.

You can enable L3 tunnels so that the wireless client appears to stay in the same subnet regardless of which AP it associates with. Every AP that the client associates with must have a network with the same SSID, network IP, and subnet mask, and L3 tunnels must be enabled on this network. When the wireless client connects to this network (SSID), all traffic is encapsulated with this network information and tunneled through various subnets.

You can also use L3 tunnels as a mechanism for aggregating data traffic into the unified switch. This allows QoS characteristics, such as access control lists and DiffServ to be configured in a single place on the unified switch rather than on individual access points or edge switches. For more information about QoS, see “Configuring QoS” on page 156.

If you enable L3 tunnels, we recommend that you enable and configure a separate VAP for clients that need to use this feature. Configure clients that need L3 Tunneling to connect to the SSID with L3 tunnels enabled, but configure all other wireless clients to use the VAP with L3 tunnels disabled.

In general, only clients that transmit and receive time-sensitive data while roaming need to take advantage of this feature. Figure 41 shows a network with two APs that are controlled by a D-Link Unified Switch. The APs and switch are all on different subnets.

Figure 41. L3 Roaming Example

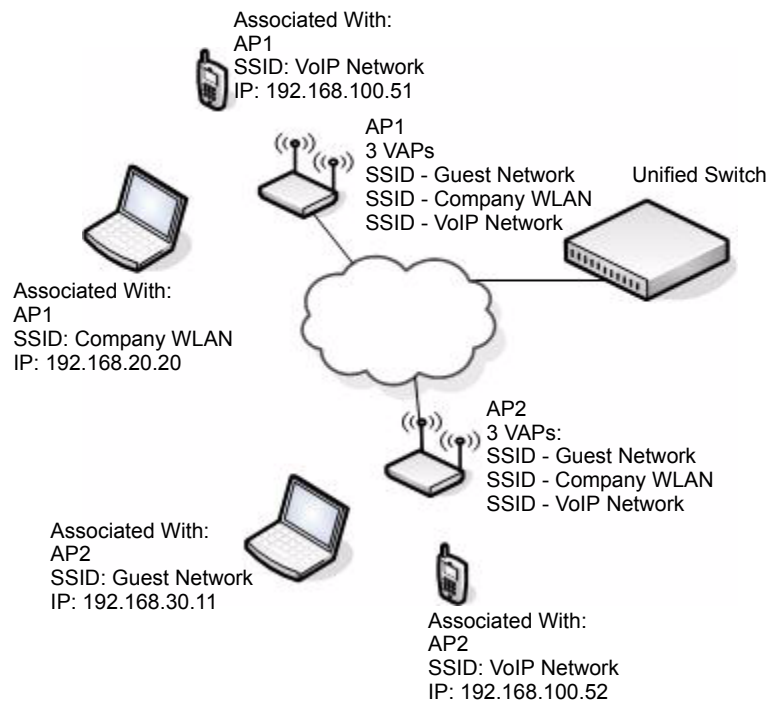

Both of the APs in [Figure 41](#) use the same default profile. The default profile has three virtual access points (VAPs) enabled, and each VAP uses a different network (SSID). When users search for available wireless networks, all three SSIDs appear in the list of networks. The laptop clients connect to the Company WLAN or Guest Network, and the VoIP phones connect to the VoIP Network.

The L3 Tunnel feature is enabled on the VoIP network, but it is disabled on the Guest and Company WLAN networks since those networks are primarily for data traffic. The VoIP network is for voice traffic. L3 Roaming uses IP tunneling so clients appear to be on the same subnet even though the APs are on different subnets.

In the sample network that [Figure 41](#) shows, the laptop users are connected to different WLAN networks on two different APs. The Internet phone users are connected to the same WLAN network on two different APs. On the VoIP Network, the phone users can seamlessly roam between AP1 and AP2 without service interruption or the need to re-authenticate or change networks.

The Unified Switch uses a VLAN routing interface as a separate logical network configured for the L3 tunnel network. This network is the L3 tunneling subnet and has a network address of 192.168.100.0.

For information about how to configure a network to use L3 tunneling, including CLI commands and Web configuration procedures, see Appendix C, “[L3 Roaming Example](#)” on page 187.

Configuring AP Security

The Default AP profile does not use any security mechanism by default. In order to protect your network, we strongly recommend that you select a security mechanism so that unauthorized wireless clients cannot gain access to your network.

From the **Wireless Network Configuration** page, you can select **None**, **WEP** or **WPA/WPA2** as the WLAN security mechanisms, as [Figure 42](#) shows. The default is **None**.

Figure 42. AP Network Security Options

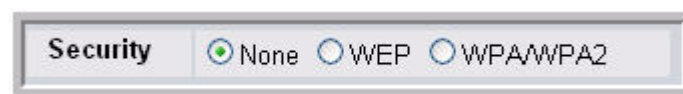

The following sections describe the security mechanisms.

Using No Security

If you select **None** as your security mode, no further options are configurable on the AP. This mode means that any data transferred between the D-Link Access Point and the associated wireless clients is not encrypted, and any wireless client can associate with the AP.

This security mode can be useful during initial network configuration or for problem solving, but it is not recommended for regular use on the internal network because it is not secure.

Using Static or Dynamic WEP

Wired Equivalent Privacy (WEP) is a data encryption protocol for 802.11 wireless networks. If you select this security mechanism, all wireless clients and access points on the network are configured with a 64-bit (40-bit secret key + 24-bit initialization vector (IV)), 128-bit (104-bit secret key + 24-bit IV), or 152-bit (128-bit secret key + 24-bit IV) Shared Key for data encryption.

Static WEP is not the most secure mode available, but it offers more protection than setting the security mode to **None** as it does prevent an outsider from easily sniffing out unencrypted wireless traffic.

Dynamic WEP is more secure than Static WEP, but you need a RADIUS server to manage the dynamically generated keys.

WEP encrypts data moving across the wireless network based on a static key. (The encryption algorithm is a “stream” cipher called RC4.)

If you select WEP as the Security Mode, additional fields display, as [Figure 43](#) shows.

Figure 43. Static WEP Configuration

The screenshot shows a configuration window for Static WEP. The 'Security' section has radio buttons for 'None', 'WEP' (selected), and 'WPA/WPA2'. Under 'WEP', there are radio buttons for 'Static WEP' (selected) and 'WEP IEEE802.1x'. The 'Authentication' section has checkboxes for 'Open System' (checked) and 'Shared Key'. The 'WEP Key Type' section has radio buttons for 'ASCII' (selected) and 'HEX'. The 'WEP Key Length (bits)' section has radio buttons for '64' (selected), '128', and '152'. The 'WEP Keys' section is labeled 'Tx' and contains four rows, each with a radio button and a text input field: '1 abcde' (selected), '2 fghij', '3 klmno', and '4 pqrst'.

Table 13 describes the configuration options for WEP.

Table 13. Static WEP

Field	Description
Static WEP or WEP IEEE 802.1x	<p>Static WEP uses static key management. You manually configure the same keys to encrypt data on both the wireless client and the AP. Dynamic WEP (WEP IEEE 802.1x) uses dynamically generated keys to encrypt client-to-AP traffic. Dynamic WEP is more secure than Static WEP, but you need a RADIUS server to manage the keys.</p> <p>If you select WEP IEEE 802.1x, the screen refreshes, and there are no more fields to configure. The AP uses the global RADIUS server IP address and secret or the RADIUS server settings you specify for the VAP. The AP acts as the RADIUS client and must be configured as a client in the RADIUS server.</p> <p>For information about how to configure the global RADIUS server settings on the Unified Switch, see “Configuring AAA and RADIUS Settings” on page 79.</p>
Authentication	<p>Choose the authentication type:</p> <ul style="list-style-type: none"> • Open System—No authentication is performed • Shared Key—Provides a rudimentary form of user authentication, which many experts consider to be less secure than Open System since it sends the WEP key to the client in plain text. • Both—Only WEP clients are authenticated.
WEP Key Type	<p>Select the key type by clicking one of the radio buttons:</p> <ul style="list-style-type: none"> • ASCII—includes upper and lower case alphabetic letters, the numeric digits, and special symbols such as @ and # • Hex—includes digits 0 to 9 and the letters A to F
WEP Key Length	<p>Specify the length of the key by clicking one of the radio buttons:</p> <ul style="list-style-type: none"> • 64 bits • 128 bits • 152 bits
Tx	<p>The Transfer Key Index indicates which WEP key the access point uses to encrypt the data it transmits. To select a transfer key, click the button located between the key number and the field where you enter the key. In Figure 43, the transfer key is 3.</p>
WEP Keys	<p>You can specify up to four WEP keys. In each text box, enter a string of characters for each key. These are the RC4 WEP keys shared with the stations using the access point.</p> <p>Use the same number of characters for each key. The number of keys you enter depends on the Key Type and Key Length. The following list shows the number of keys to enter in the field:</p> <ul style="list-style-type: none"> • 64 bit—ASCII: 5 characters; Hex: 10 characters • 128 bit—ASCII: 13 characters; Hex: 26 characters • 152 bit—ASCII: 16 characters; Hex: 32 characters <p>Each client station must be configured to use one of these same WEP keys in the same slot as specified here on the AP.</p>

Static WEP Rules

If you use Static WEP, the following rules apply:

- All client stations must have the Wireless LAN (WLAN) security set to WEP and all clients must have one of the WEP keys specified on the AP in order to de-code AP-to-station data transmissions.
- The AP must have all keys used by clients for station-to-AP transmit so that it can de-code the station transmissions.
- The same key must occupy the same slot on all nodes (AP and clients). For example if the AP defines *abc12* key as WEP key 3, then the client stations must define that same string as WEP key 3.
- Client stations can use different keys to transmit data to the access point. (Or they can all use the same key, but this is less secure because it means one station can decrypt the data being sent by another.)
- On some wireless client software, you can configure multiple WEP keys and define a client station “transfer key index”, and then set the stations to encrypt the data they transmit using different keys. This ensures that neighboring APs cannot decode each other’s transmissions.
- You cannot mix 64-bit, 128-bit, and 152-bit WEP keys between the access point and its client stations.

Using WPA/WPA2 Personal or Enterprise

WPA and WPA2 are Wi-Fi Alliance IEEE 802.11i standards, which include AES-CCMP and TKIP mechanisms. The WPA/WPA2 Personal employs a pre-shared key to perform an initial check of credentials. The WPA/WPA2 Enterprise uses a RADIUS server to authenticate users.

If you select WPA/WPA2 as the security mode, additional fields display, as [Figure 44](#) shows.

Figure 44. WPA Personal Configuration

Security	<input type="radio"/> None <input type="radio"/> WEP <input checked="" type="radio"/> WPA/WPA2 <input checked="" type="radio"/> WPA Personal <input type="radio"/> WPA Enterprise
WPA Versions	<input checked="" type="checkbox"/> WPA <input checked="" type="checkbox"/> WPA2
WPA Ciphers	<input checked="" type="checkbox"/> TKIP <input type="checkbox"/> CCMP(AES)
WPA Key Type	ASCII
Passphrase	<input type="text"/>

Table 14 describes the configuration options for the Static WPA security mode.

Table 14. Static WPA

Field	Description
WPA Personal or WPA Enterprise	<p>WPA/WPA2 Personal uses static key management. You manually configure the same keys to encrypt data on both the wireless client and the AP. WPA/WPA2 Enterprise uses a RADIUS server and dynamically generated keys to encrypt client-to-AP traffic. WPA Enterprise is more secure than WPA Personal, but you need a RADIUS server to manage the keys.</p> <p>If you select WPA Enterprise, the screen refreshes and a different set of fields appear (described later in this table). The AP uses the global RADIUS server IP address and secret or the RADIUS server settings you specify for the VAP. The AP acts as the RADIUS client and must be configured as a client in the RADIUS server.</p> <p>For information about how to configure the global RADIUS server settings on the Unified Switch, see “Configuring AAA and RADIUS Settings” on page 79.</p>
WPA Versions	<p>Select the types of client stations you want to support:</p> <ul style="list-style-type: none"> • WPA. If all client stations on the network support the original WPA but none support the newer WPA2, then select WPA. • WPA2. If all client stations on the network support WPA2, we suggest using WPA2 which provides the best security per the IEEE 802.11i standard. • WPA and WPA2. If you have a mix of clients, some of which support WPA2 and others which support only the original WPA, select both of the boxes. This lets both WPA and WPA2 client stations associate and authenticate, but uses the more robust WPA2 for clients who support it. This WPA configuration allows more interoperability, at the expense of some security.
WPA Ciphers	<p>Select the cipher suite you want to use:</p> <ul style="list-style-type: none"> • TKIP • CCMP (AES) • TKIP and CCMP (AES) <p>Both TKIP and AES clients can associate with the access point. WPA clients must have one of the following to be able to associate with the AP:</p> <ul style="list-style-type: none"> • A valid TKIP key • A valid AES-CCMP key
WPA Key Type	<p>Select the key type by clicking one of the radio buttons:</p> <ul style="list-style-type: none"> • ASCII—includes upper and lower case alphabetic letters, the numeric digits, and special symbols such as @ and # • Hex—includes digits 0 to 9 and the letters A to F
Passphrase	<p>The WPA Key is the shared secret key for WPA Personal. Enter a string of at least 8 characters to a maximum of 63 characters.</p>

Table 14. Static WPA

Field	Description
Pre-Authentication	<p>If you select WPA/WAP2 Enterprise, you can enable Pre-Authentication. Click the Pre-Authentication check box if you want WPA2 wireless clients to send pre-authentication packets. The pre-authentication information is relayed from the access point the client is currently using to the target access point.</p> <p>Enabling this feature can help speed up authentication for roaming clients who connect to multiple access points. Only clients that connect by using WPA2 can use this feature. It is not supported by the original WPA.</p>
Pre-Authentication Limit	<p>Enter the number of pre-authentications that can be in progress simultaneously on an AP. The limit prevents too much load on the RADIUS server. This does not prevent the pre-authentication from being attempted again when the load is lighter. A value of 0 represents no limit.</p> <p>NOTE: This field is only available if you access the network through the AP Profile or Network page under Advanced Configuration.</p>
Key Forwarding	<p>Select the check box to allow APs to forward the Pairwise Master Key (PMK) for the wireless client to other APs in case the client roams to another AP.</p> <p>NOTE: This field is only available if you access the network through the AP Profile or Network page under Advanced Configuration.</p>
Key Caching Hold Time	<p>Enter the amount of minutes a PMK will be held by the AP. This applies to PMKs generated by RADIUS, those that come from pre-authentication, and those that are forwarded to the AP. Note that this time limit can be overridden by RADIUS if the RADIUS server returns a longer time in the Session-Timeout attribute for a particular user. The valid values of this are from 1-1440 minutes.</p> <p>NOTE: This field is only available if you access the network through the AP Profile or Network page under Advanced Configuration.</p>

Configuring Valid Access Point Settings

You can add an AP into the list of Valid APs from the **Administration > Basic Setup > Valid AP** tab, as [Figure 45](#) shows, or you can add an AP from the AP Authentication Failures or Rogue AP/RF Scan lists.

From the Valid AP page, you can manually set the channel and RF signal transmit power level for an individual AP. You can also configure the AP mode and local authentication password, and you can specify which profile the AP uses.

Figure 45. Adding a Valid AP

After you enter the MAC address and location of the AP to add to the list, click **Add** to add the AP to the database and to access the configuration page for the AP. For an AP that is already in the database, click the MAC address of the AP to access its configuration page.

Table 15. Valid Access Point Summary

Field	Description
MAC Address	Enter the MAC address of the AP in this field. When you add the MAC address, you add the AP to the local database on the switch.
Location	To help you identify the AP, you can enter a location. This field accepts up to 32 alphanumeric characters, including special characters.
Managed Mode	This field displays the current mode of the AP. You can configure the mode on the Valid Access Point Configuration page, which you access by clicking the MAC address of the AP.
Profile	This field displays the AP profile assigned to the AP. If you have multiple AP profiles, you can assign a new profile to an AP from the summary page. Select the check box next to one or more APs, then select the new profile from the drop-down menu. Click Change Profile to apply the profile to the selected APs.

If you use the local database for AP validation, the switch maintains the database of access points that you validate. When you add the MAC address of an AP to the database, you can specify whether the AP is a Managed AP or Acknowledged Rogue and assign an AP profile to

the device. When the switch collects and reports information from the RF scan, it can assign the appropriate status to an AP if it is in the database.

Figure 46. Configuring a Valid AP

The screenshot displays the 'Valid Access Point Configuration' page. At the top, there are navigation tabs: Global, Discovery, AAA / RADIUS, Radio, SSID, and Valid AP. The main content area is titled 'Valid Access Point Configuration' and contains the following fields and controls:

- MAC Address:** A text input field containing '00:11:95:35:05:00'.
- Managed Mode:** A dropdown menu set to 'WS Managed'.
- Location:** A text input field containing 'Engineering'.
- Authentication Password:** A text input field with masked characters and an 'Edit' checkbox.
- Profile:** A dropdown menu set to '1 - Default'.
- Radio 802.11g:** A section containing 'Channel' (set to 'Auto') and 'Power (%)' (set to '0').

At the bottom of the form, there are four buttons: 'Delete', 'Refresh', 'Submit', and 'Back'.

Table 16 describes the fields available on the Valid Access Point Configuration page.

Table 16. Valid AP Configuration

Field	Description
MAC Address	This field shows the MAC address of the AP. To change this field, you must delete the entire Valid AP configuration and then enter the correct MAC address from the page that lists all Valid APs.
Managed Mode	You can configure the D-Link Access Point to be in one of three modes: <ul style="list-style-type: none"> WS Managed—The AP is part of the D-Link Unified Access System, and you manage it by using the D-Link Unified Switch. If an AP is in Managed Mode, the Administrator Web UI and SNMP services on the AP are disabled. Acknowledged Rogue—The AP has been discovered by the switch and acknowledge as a Rogue. This AP is not a D-Link Access Point. You can add an Acknowledged Rogue to the Valid AP list to prevent the Rogue from being identified as a threat.
Location	To help you identify the AP, you can enter a location. This field accepts up to 32 alphanumeric characters.
Authentication Password	You can require that the AP authenticate itself with the switch upon discovery. If you require authentication, which is a setting on the Basic Setup > Global tab, you enter the password in this field. The password in this field must match the password configured on the AP.
Profile	If you configure multiple AP Profiles, you can select the profile to assign to this AP. For more information about configuring AP Profiles, see “Creating, Configuring, and Managing AP Profiles” on page 149.

Table 16. Valid AP Configuration

Field	Description
Channel	<p>The Channel defines the portion of the radio spectrum that the radio uses for transmitting and receiving. The range of channels and the default channel are determined by the Mode of the radio interface and the country in which the APs operate.</p> <p>In the United States, IEEE 802.11b/802.11g modes (802.11 b/g) support use of channels 1 through 11 inclusive, while IEEE 802.11a mode supports a larger set of non-consecutive channels (36,40,44, 48, 52, 56, 60, 64, 149, 153, 157, 161, 165).</p> <p>Interference can occur when multiple access points within range of each other are broadcasting on the same or overlapping channels. The impact of this interference on network performance can intensify during busy times when a large amount of data and media traffic is competing for bandwidth.</p> <p>If you select auto, the AP scans the RF area for occupied channels and selects a channel from the available non-interfering, or clear channels. The AP selects the best channel whenever its radio or radios restart.</p> <p>If you specify a channel, make sure that the channel does not interfere with the channel that neighbor APs use.</p> <p>NOTE: The channel you set for an AP in the valid AP database is fixed and takes precedence over initial channel selection done by the AP and any automatic channel planning done by the switch.</p> <p>NOTE: For radios that use 802.11a mode, some countries have a regulatory domain that requires radar detection. For these countries (based on the country code setting), the radio automatically uses the 802.11h protocol for selecting the channel if radar is detected on the statically assigned channel.</p>
Power	<p>The power level affects how far an AP broadcasts its RF signal. If the power level is too low, wireless clients will not detect the signal or experience poor WLAN performance. If the power level is too high, the RF signal might interfere with other APs within range.</p> <p>The default value of 0 indicates that the AP uses the power level set in the AP profile.</p> <p>NOTE: The power level you set for an AP in the valid AP database is fixed and takes precedence over any automatic power adjustments done by the AP or the switch.</p>

Managing and Maintaining D-Link Access Points

This chapter contains the following sections to help you manage and maintain the D-Link Access Points on your D-Link Unified Access System network:

- [Resetting the Access Points](#)
- [Managing Radio Frequency Settings](#)
- [Upgrading the Access Point Software](#)
- [Performing Advanced Access Point Management](#)

For information about the commands you use to manage and maintain the APs by using the CLI, see the *D-Link CLI Command Reference*.

Resetting the Access Points

You can manually reset one or all APs from the D-Link Unified Switch. When you issue the command to reset an AP, the AP closes the SSL connection to the switch before resetting the hardware.

To reset one or more APs, click **AP Management > Reset**.

Figure 47. Access Point Reset

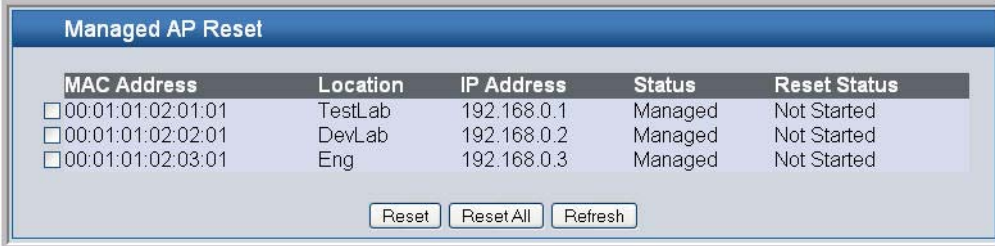

MAC Address	Location	IP Address	Status	Reset Status
<input type="checkbox"/> 00:01:01:02:01:01	TestLab	192.168.0.1	Managed	Not Started
<input type="checkbox"/> 00:01:01:02:02:01	DevLab	192.168.0.2	Managed	Not Started
<input type="checkbox"/> 00:01:01:02:03:01	Eng	192.168.0.3	Managed	Not Started

Reset Reset.All Refresh

Select the APs you want to reset and click **Reset**, or click **Reset All** to reset all of the APs managed by the switch.

The APs might take several minutes to reset and re-establish communication with the switch. While the AP is resetting, the status changes to failed, and then back to managed once the AP is back online.

Managing Radio Frequency Settings

The radio frequency (RF) broadcast channel defines the portion of the radio spectrum that the radio on the access point uses for transmitting and receiving. The range of available channels for an access point is determined by the IEEE 802.11 mode (also referred to as band) of the access point.

The DWL-3500AP is a single-band system that operates in 802.11g mode, and the DWL-8500AP is a dual-band system that operates in 802.11a and 802.11g modes. IEEE 802.11b and 802.11g modes (802.11 b/g) operate in the 2.4 GHz RF frequency and support use of channels 1 through 11. IEEE 802.11a mode operates in the 5 GHz frequency and supports a larger set of non-consecutive channels (36,40,44, 48, 52, 56, 60, 64, 149, 153, 157, 161, 165).

NOTE: The available channels depends on the country in which the APs operate. The channels described in this section are valid for the United States.

Interference can occur when multiple access points within range of each other are broadcasting on the same or overlapping channels. The impact of this interference on network performance can intensify during busy times when a large amount of data and media traffic is competing for bandwidth. For the “b/g” radio band, the classical set of non-interfering channels is 1, 6, 11. Channels 1, 4, 8, 11 produce minimal overlap. A similar set of non-interfering channels is used for the “a” radio band, which includes all channels for that mode since they are not overlapping.

Configuring Channel Plan and Power Settings

The D-Link Unified Switch software contains a channel plan algorithm that automatically determines which RF channels each D-Link Access Point should use to minimize RF interference. When you enable the channel plan algorithm, the switch periodically evaluates the operational channel on every AP it manages and changes the channel if the current channel is noisy.

NOTE: The regulation of radio frequencies and channel assignments varies from country to country. In countries that do not support channels 1, 6, and 11 on the 802.11b/g radio, the channel plan algorithm is inactive. For the 802.11a radio, the algorithm is inactive in countries that require 802.11h radar detection, which includes European countries and Japan.

The automatic channel selection algorithm does not affect APs that meet any of the following conditions:

- The channel is statically assigned to the AP in the RADIUS or local AP database.
- The channel has been statically assigned to the AP from the **AP Management > Advanced** page.
- The AP uses a profile that has the Automatic Channel field disabled (Radio Configuration setting).

Additionally, radios configured to use Super A or Super G cannot use the channel plan algorithm.

NOTE: If the AP is not assigned a fixed channel or is not assigned a specific channel by the automatic channel selection algorithm, the AP channel selection mode is set to “best.” This means that the AP selects the “best” channel whenever the radio restarts or if the AP detects a radar signal.

The RF transmission power level affects how far an AP broadcasts its signal. If the power level is too low, wireless clients will not detect the signal or experience poor WLAN performance. If the power level is too high, the RF signal might interfere with other APs within range or broadcast the signal beyond the desired physical boundaries, which can create a security risk.

Automatic power uses a proprietary algorithm to automatically adjust the RF signal to broadcast far enough to reach wireless clients, but not so far that it interferes with RF signals broadcast by other APs.

To configure Channel Plan and Power Adjustment settings, click **AP Management > RF Management**.

Figure 48. RF Channel Plan and Power Configuration

The screenshot shows a web interface for RF Configuration. At the top, there are four tabs: Configuration, Channel Plan History, Manual Channel Plan, and Manual Power Adjustments. The Configuration tab is active. Below the tabs is a section titled "RF Configuration" with the following settings:

Channel Plan	<input checked="" type="radio"/> 802.11a <input type="radio"/> 802.11b/g
Channel Plan Mode	<input type="radio"/> Fixed Time <input checked="" type="radio"/> Manual <input type="radio"/> Interval
Channel Plan History Depth	5 (0 to 10)
Channel Plan Interval (hours)	6 (6 to 24)
Channel Plan Fixed Time (hh:mm)	0 : 0
Power Adjustment Mode	<input checked="" type="radio"/> Manual <input type="radio"/> Interval
Power Adjustment Interval (minutes)	15 (15 to 1440)

At the bottom of the configuration area is a "Submit" button.

Table 17 describes the RF Channel Plan and Power Adjustment fields you can configure.

NOTE: When the AP changes its channel, all associated wireless clients temporarily lose their connection to the AP and must re-associate. The re-association can take several seconds, which can affect time-sensitive traffic such as voice and video.

Table 17. RF Channel Plan and Power Adjustment

Field	Description
Channel Plan	Before you configure channel plan settings, select the mode to configure.
Channel Plan Mode	<p>This field indicates the channel assignment mode. The mode of channel plan assignment can be one of the following:</p> <ul style="list-style-type: none"> • Fixed Time—If you select the fixed time channel plan mode, you specify the time for the channel plan and channel assignment. In this mode the plan is applied once every 24 hours at the specified time. • Manual—With the manual channel plan mode, you control and initiate the calculation and assignment of the channel plan. You must manually run the channel plan algorithm and apply the channel plan to the APs. • Interval—In the interval channel plan mode, the switch periodically calculates and applies the channel plan. You can configure the interval to be from every 6 to every 24 hours. The interval period begins when you click Submit.
Channel Plan History Depth	<p>The channel plan history lists the channels the switch assigns each of the APs it manages after a channel plan is applied. Entries are added to the history regardless of interval, time, or channel plan mode.</p> <p>The number you specify in this field controls the number of iterations of the channel assignment.</p> <p>NOTE: The APs changed in previous iterations cannot be assigned new channels in the next iteration. This history prevents the same APs from being changed time after time.</p>
Channel Plan Interval	If you select the Interval channel plan mode, you can specify the frequency at which the channel plan calculation and assignment occurs. The interval time is in hours, and you can specify an interval that ranges between every 6 hours to every 24 hours.
Channel Plan Fixed Time	If you select the Fixed Time channel plan mode, you can specify the time at which the channel plan calculation and assignment occurs. The channel plan calculation will occur once every 24 hours at the time you specify.

Table 17. RF Channel Plan and Power Adjustment

Field	Description
Power Adjustment Mode	<p>You can set the power of the AP radio frequency transmission in the AP profile, the local database or in the RADIUS server. The power level in the AP profile is the default level for the AP, and the power will not be adjusted below the value in the AP profile.</p> <p>The settings in the local database and RADIUS server always override power set in the profile setting. If you manually set the power, the level is fixed and the AP will not use the automatic power adjustment algorithm.</p> <p>You can configure the power as a percentage of maximum power, where the maximum power is the minimum of power level allowed for the channel by the regulatory domain or the hardware capability.</p> <ul style="list-style-type: none"> • Manual—In this mode, you run the proposed power adjustments manually from the Manual Power Adjustments page. • Interval—In this mode, the switch periodically calculates the power adjustments and applies the power for all APs. The interval period begins when you click Submit. <p>NOTE: If you set the power level in the local or RADIUS database, the settings override the power level set in the AP profile.</p> <p>For more information about manually setting the power level, see “Configuring Wireless Radio Settings” on page 81 and “Configuring Valid Access Point Settings” on page 98.</p>
Power Adjustment Interval	<p>This field determines how often the switch runs the power adjustment algorithm. The algorithm runs automatically only if you set the power adjustment mode to Interval.</p>

Viewing the Channel Plan History

The D-Link Unified Switch stores channel assignment information for the APs it manages. To access the Channel Plan History information, click the **AP Management > RF Management > Channel Plan History** tab.

Figure 49. Channel Plan History



Table 18 describes the Channel Plan History fields

Table 18. Channel Plan History

Field	Description
802.11a 802.11g	The 802.11a and 802.11g radios use different channel plans, so the switch tracks the channel history separately for each radio. The channel information that displays on the page is only for the radio you select.
Operational Status	This field shows whether the switch is using the automatic channel adjustment algorithm on the D-Link Access Point radios.
Last Iteration	The number in this field indicates the last iteration of channel plan adjustments. The APs that received a channel adjustment in previous iterations cannot be assigned new channels in the next iteration to prevent the same APs from being changed time after time. On the AP Management > RF Management > Configuration tab, you can set the history depth to control the maximum number of iterations stored and displayed in the channel plan history.
Last Algorithm Time	Shows the date and time when the channel plan algorithm last ran. NOTE: To set the system time on the switch, you must use SNTP, which is disabled by default. From the Web interface, you configure the SNTP client and server information from the LAN > Administration > SNTP Settings page. From the CLI, use the sntp commands in Global Config mode.
AP MAC Address Location Radio Iteration Channel	This table displays the channel assigned to an AP in an iteration of the channel plan.

Initiating Manual Channel Plan Assignments

If you specify Manual as the Channel Plan Mode on the Configuration tab, the **Manual Channel Plan** page allows you to initiate the Channel Plan algorithm.

To manually run the channel plan adjustment feature, select the radio to update the channels on (802.11a or 802.11g) and click the **Start** button.

Figure 50. Manual Channel Plan



The Current Status of the plan shows one of the following states:

- None—The channel plan algorithm has not been manually run since the last switch reboot.
- Algorithm In Progress—The channel plan algorithm is running.
- Algorithm Complete—The channel plan algorithm has finished running. A table displays to indicate proposed channel assignments. Each entry shows the AP along with the current and new channel. To accept the proposed channel change, click **Apply**. You must manually apply the channel plan for the proposed assignments to be applied.
- Apply In Progress—The switch is applying the proposed channel plan and adjusting the channel on the APs listed in the table.
- Apply Complete—The algorithm and channel adjustment are complete.

After the channel plan runs, a table shows any APs that the algorithm recommends for new channel assignments. The current channel shows the current operating channel, and the new channel shows the proposed channel. To apply the new channels, click **Apply**. If no APs appear after the algorithm is complete, the algorithm does not recommend any channel changes.

It is possible for the network configuration to change between the time the automatic channel selection runs and the time you attempt to apply the proposed channel assignments.

The channel will fail to be applied to an AP if one of the following conditions exist:

- The AP has failed.
- The radio on the AP has been disabled through a profile update.
- The channel is not valid for the radio mode.
- The AP has been rebooted since the channel plan was computed and acquires a static channel that has been set statically via local database.
- The channel has been set manually through the advanced page.
- The auto-channel mode has been disabled in the profile for this AP.

Initiating Manual Power Adjustments

If you select Manual as the Power Adjustment Mode on the Configuration tab, you can manually initiate the power adjustment algorithm on the **Manual Power Adjustments** page.

Figure 51. Manual Power Adjustments



The Current Status of the plan shows one of the following states:

- None—The power adjustment algorithm has not been manually run since the last switch reboot.
- Algorithm In Progress—The power adjustment algorithm is running.
- Algorithm Complete—The power adjustment algorithm has finished running.

A table displays to indicate proposed power adjustments. Each entry shows the AP along with the current and new power levels. To accept the proposed change, click **Apply**. You must manually apply the power adjustment for the proposed assignments to be applied.

- Apply In Progress—The switch is adjusting the power levels that the APs use.
- Apply Complete—The algorithm and power adjustment are complete.

Upgrading the Access Point Software

The D-Link Unified Switch can upgrade software on the APs that it manages. To upgrade one or more D-Link Access Point from the switch that manages it, click the **WLAN > AP Management > Software Downloads** tab.

Figure 52. AP Upgrade

NOTE: The APs automatically reset after the code is successfully downloaded.

Table 19 describes the fields you must complete to upgrade D-Link Access Points.

Table 19. AP Upgrade

Field	Description
Server Address	Enter the IP address of the host where the upgrade file is located. The host must have a TFTP server installed and running.
File Path	Enter the path to the directory where the upgrade file is located. You may enter up to 96 characters.
File Name	Enter the name of the upgrade file. You may enter up to 32 characters, and the file extension ".tar" must be included.

Table 19. AP Upgrade

Field	Description
Group Size	<p>When you upgrade multiple APs, each AP contacts the TFTP server to download the upgrade file. To prevent the TFTP server from being overloaded, you can limit the number of APs to be upgraded at a time.</p> <p>In the Group Size field, enter the number of APs that can be upgraded at the same time. When one group completes the upgrade, the next group begins the process.</p>
Managed AP	<p>The drop-down menu lists the APs that the switch manages. Each AP is identified by its MAC address. To upgrade a single AP, select the AP MAC address from the drop down list. To upgrade all APs, select “All” from the top of the list. If “All” is selected, the Group Size field will limit the number of simultaneous AP upgrades in order not to overwhelm the TFTP server.</p> <p>NOTE: We recommend that you upgrade all managed APs at the same time.</p>

After you provide the information about the upgrade file, click **Start** to begin the upgrade process. Additional fields appear to provide information about upgrade status and success.

Figure 53. AP Upgrade Status.

The screenshot shows the 'Wireless Software Download' interface. It contains several input fields and a summary table.

Server Address	10.254.24.68	Download Status	In Progress
File Path	downloads/ap	Download Count	1
File Name	DL20061128_1.tar	Successful Download Count	0
Group Size	10 (1 to 48)	Failure Count	0
Managed AP	All		

Managed AP	Location	Status	Software Version
00:11:95:A3:7B:40		Downloading	D.11.28.1

Note: It takes about 12 minutes for the upgrade process to complete for an AP. After that the AP will become managed again.

Buttons: Abort, Refresh

Table 20 describes the fields that appear after you start the AP upgrade process.

Table 20. AP Upgrade Status

Field	Description
Download Status	<p>This field shows the status of the upgrade process for all APs:</p> <ul style="list-style-type: none"> • Not Started—The Unified Switch has not started the download process. • Requested—A request to download AP software has been made, but the switch has not done any downloads. • In Progress—The AP is currently attempting to download software from the server. • Success—Download completed successfully on all APs. An AP reports a successful download to the switch after the software transfers from the TFTP server to the AP and the code checksum is good. The code must also match the intended hardware platform. • Partial-Success—Download worked on some APs, but failed on others. A table lists each AP and its individual status so that you can see which APs failed to upgrade. • Failure—Download failed on all APs. A software download fails if the AP reports a software download failure due to an inability to contact the TFTP server or find the upgrade file, or if the AP loses connectivity with the switch.
Download Count	<p>The number in this field shows the number of managed APs to download software in the current download request. If you selected All for the managed APs to upgrade, the download count shows the number of managed APs at the time the download request was started. The value is 1 if only one AP is being updated.</p>
Success Count	<p>The number in this field shows the number of APs that have successfully downloaded the new code. This value starts with 0 at the beginning of the download and increases by one for every AP that successfully downloaded the code.</p>
Failure Count	<p>The number in this field shows the number of APs that failed to download the new code. This value starts with 0 at the beginning of the download and increases by one for every AP that failed to download the code.</p>

A table also appears and lists each AP, its download status, and the software version it is downloading. The status for an individual AP can have one of the following values:

- Requested—Download has been requested for this AP.
- Pending—Download is planned for this AP, but the AP is not in the current download group, so it hasn't been told to start the download yet.
- Downloading—The AP has been told to download the code.
- Success—The AP reported successful code download.
- Failure—The AP reported a failed code download.

Performing Advanced Access Point Management

When the D-Link Access Point is in Managed mode, remote access to the AP is disabled. However, you can enable Telnet access by enabling the Debug feature on the AP

Management > Advanced page. From the **Advanced** page, you can also manually change the RF channel and power for each radio on an AP.

Figure 54. Advanced AP Management

MAC Address	Location	Debug	Radio	Channel	Power (%)
00:01:01:02:01:01	TestLab	Disabled	1-802.11a 2-802.11g	0 0	0 0
00:01:01:02:02:01	DevLab	Disabled	1-802.11a 2-802.11g	0 0	0 0
00:01:01:02:03:01	Eng	Disabled	1-802.11a 2-802.11g	0 0	0 0

Each AP managed by the D-Link Unified Switch is listed by its MAC address and location. The location is based on the value in the RADIUS or local Valid AP database. [Table 21](#) describes the Advanced features you can configure for the AP.

Table 21. Advanced AP Management

Field	Description
Debug	<p>To help you troubleshoot, you can enable Telnet access to the AP so that you can debug the device from the CLI.</p> <p>The Debug field shows the debug status and can be one of the following:</p> <ul style="list-style-type: none"> • Disabled • Set Requested • Set in Progress • Enabled <p>To change the status, click the Debug status link. The Managed AP Debug page appears. Table 22 describes the fields on the new page.</p>
Channel	<p>Click the Channel link to access the Managed AP Channel/Power Adjust page. From that page, you can set a new channel for Radio 1 or Radio 2. The available channels depend on the radio mode and country in which the APs operate. Table 23 describes the fields on the new page.</p>
Power	<p>Click the Power link to access the Managed AP Channel/Power Adjust page. From that page, you can set a new power level for the AP. Table 23 describes the fields on the new page.</p>

Enabling AP Debugging

You can enable debugging on an AP to allow Telnet access to the access point. Once you Telnet to the AP, you can issue commands from the CLI to help you troubleshoot.

The fields in [Table 22](#) appear when you click the Debug link for a managed AP on the **Managed AP Advanced** page.

Table 22. AP Debug

Field	Description
MAC Address	Shows the MAC address of the access point.
Location	Shows the location of the access point, as configured in the Valid AP database.
IP Address	Shows the IP address of the AP.
Status	Shows the debug status, which can be one of the following: <ul style="list-style-type: none"> • None—Debugging has not been enabled or disabled. • Set Requested—A request has been made to change the debug status. • Set Complete—Debugging has been enabled or disabled.
Password	Enter the admin password for the AP (the default is admin).
Confirm Password	Since the password is encrypted, you must retype the password to confirm the password.
Enable Debug	Select or clear the Enable check box to enable or disable debugging. Once once you Telnet to the AP, you get an AP interface login prompt. The user name is admin. Enter the password you set in the previous field. The default password is admin if you did not specify a new password. From the AP CLI, you can also access the standard Linux prompt by typing the '!' character. You can issue the following debug commands at the Linux OS prompt: <ul style="list-style-type: none"> • get management—Display management interface information • get managed-ap—Display managed AP information You can issue the following debug commands at the Linux OS prompt: <ul style="list-style-type: none"> • ifconfig—display all interfaces. • cat /proc/meminfo—View memory utilization

Adjusting the Channel and Power

Changes you make to the channel and power are runtime changes only. If you change the channel or power settings, the new settings are lost if the AP or switch is reset.

The fields in [Table 23](#) appear when you click the current channel or power setting for an AP on the **Managed AP Advanced** page.

Table 23. Managed AP Channel/Power Adjust

Field	Description
AP MAC Address	Shows the MAC address of the access point.
Radio	Displays the radio and its mode. The changes apply only to this radio.
Channel Status	The status is one of the following: <ul style="list-style-type: none"> • None • Set Requested • Set Complete

Table 23. Managed AP Channel/Power Adjust

Field	Description
Channel	<p>The Channel defines the portion of the radio spectrum that the radio uses for transmitting and receiving. The range of channels and the default channel are determined by the Mode of the radio interface.</p> <p>IEEE 802.11b/802.11g modes (802.11 b/g) support use of channels 1 through 11 inclusive, while IEEE 802.11a mode supports a larger set of non-consecutive channels (36,40,44, 48, 52, 56, 60, 64, 149, 153, 157, 161, 165).</p> <p>NOTE: The available channels depends on the country in which the APs operate.</p> <p>NOTE: For radios that use 802.11a mode, some countries have a regulatory domain that requires radar detection. For these countries (based on the country code setting), the radio automatically uses the 802.11h protocol for selecting the channel if radar is detected on the statically assigned channel.</p> <p>Interference can occur when multiple access points within range of each other are broadcasting on the same or overlapping channels. The impact of this interference on network performance can intensify during busy times when a large amount of data and media traffic is competing for bandwidth.</p> <p>If you select auto, the AP scans the RF area for occupied channels and selects a channel from the available non-interfering, or clear channels.</p> <p>If you specify a channel, make sure that the channel does not interfere with the channel that neighbor APs use.</p>
Power Status	<p>The status is one of the following:</p> <ul style="list-style-type: none"> • None • Set Requested • Set Complete
Power	<p>The power level affects how far an AP broadcasts its RF signal. If the power level is too low, wireless clients will not detect the signal or experience poor WLAN performance. If the power level is too high, the RF signal might interfere with other APs within range.</p>

Monitoring Status and Statistics

This chapter contains the following sections to help you monitor the status and statistics for your D-Link Unified Access System network:

- [Monitoring Wireless Global Information](#)
- [Monitoring Peer Switch Status](#)
- [Monitoring All Access Points](#)
- [Monitoring Managed Access Point Status](#)
- [Viewing Access Point Authentication Failure Status](#)
- [Monitoring Rogue and RF Scan Access Points](#)
- [Monitoring Associated Client Information](#)
- [Viewing Client Authentication Failure Status](#)
- [Monitoring and Managing Ad Hoc Clients](#)

For information about the commands you use to view WLAN status and statistics by using the CLI, see the *D-Link CLI Command Reference*.

Monitoring Wireless Global Information

The D-Link Unified Switch periodically collects information from the D-Link Access Points it manages and from peer switches that are associated with it. The information on the Global page shows status and statistics about the switch and all of the objects associated with it.

You can access the global WLAN statistics by clicking **Monitoring > Global**.

For more information about an item on the Wireless Global Status page, click the value associated with the item to go to its status page.

Figure 55. Global WLAN Status

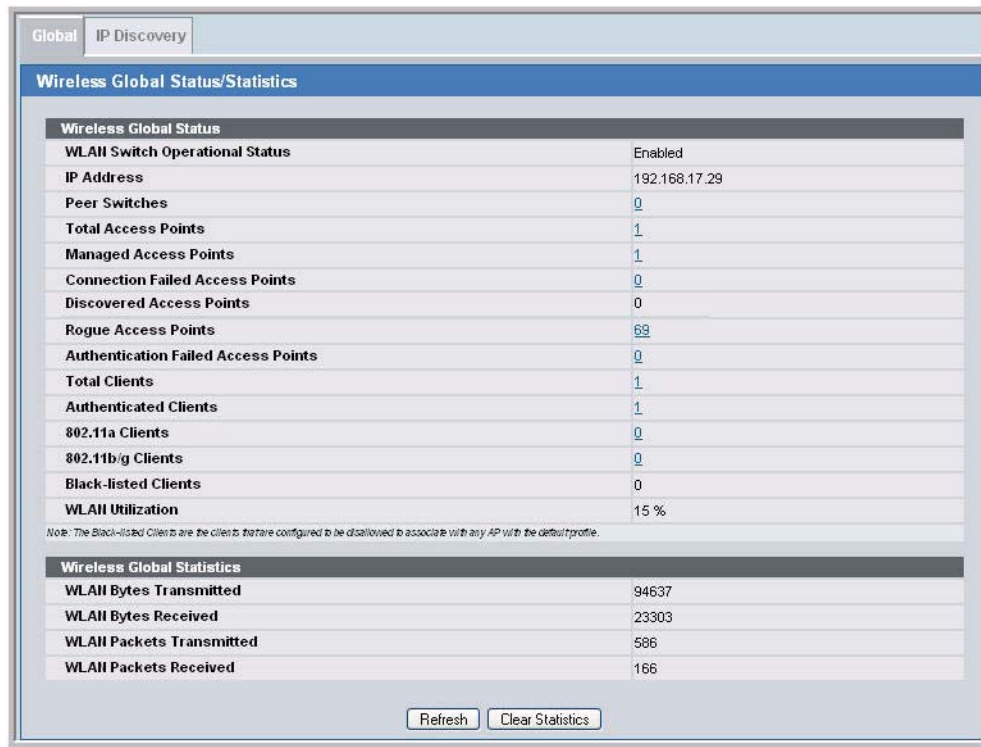

Table 24 describes the fields on the **Wireless Global Status** page.

Table 24. Global WLAN Statistics

Field	Description
WLAN Switch Operation Status	This status field displays the operational status of the WLAN Switch. The WLAN Switch may be configured as enabled, but is operationally disabled due to configuration dependencies. If the operational status is disabled, the reason will be displayed in the following status field. The WLAN Switch is composed of multiple components, and each component in the system must acknowledge an enable or disable of the WLAN Switch. During a transition the operational status might temporarily show a pending status.
IP Address	IP address of the switch. For information about the switch IP address, see “Assigning the IP Address to Switches and Managed APs” on page 60.
Peer Switches	Number of peer unified switches detected on the network.
Total Access Points	Total number of Managed APs in the database. This value is always equal to the sum of "Managed Access Points," "Connection Failed Access Points," and "Discovered Access Points."
Managed Access Points	Number of APs in the managed AP database that are authenticated, configured, and have an active connection with the unified switch.

Table 24. Global WLAN Statistics

Field	Description
Connection Failed Access Points	Number of APs that were previously authenticated and managed, but currently don't have connection with the unified switch.
Discovered Access Points	APs that have a connection with the switch but have not been completely configured. This value includes all managed APs with a "Discovered" or "Authenticated" status.
Rogue Access Points	Number of Rogue APs currently detected on the WLAN. When an AP performs an RF scan, it might detect access points that have not been validated. It reports these APs as rogues.
Authentication Failed Access Points	Number of access points that failed to authenticate with the Unified Switch.
Total Clients	Total number of clients in the database. This total includes clients with an "Associated", "Authenticated", or "Disassociated" status.
Authenticated Clients	Total number of clients in the client database with an "Authenticated" status.
802.11a Clients	Shows the number of clients connected to the 802.11a radio frequency.
802.11b/g Clients	Shows the number of clients connected to the 802.11b/g radio frequency.
Black-listed Clients	Shows the number of clients that are configured to be disallowed to associate with any AP that uses the default AP profile.
WLAN Utilization	Total network utilization across all APs managed by this switch. This is based on global statistics.
WLAN Bytes Transmitted	Total bytes transmitted across all APs managed by the switch.
WLAN Bytes Received	Total bytes received across all APs managed by the switch.
WLAN Packets Transmitted	Total packets transmitted across all APs managed by the switch.
WLAN Packets Received	Total packets received across all APs managed by the switch.

Viewing IP Discovery Status

From the **Monitoring > Global > IP Discovery** tab, you can view information about communication with the devices in the IP discovery list on the **Administration > Basic Setup > Discovery** page.

Figure 56. Wireless Discovery Status



IP Address	Status
10.254.24.43	Polled
10.254.24.44	Polled
10.254.24.45	Polled
10.254.24.46	Polled
10.254.24.47	Polled
10.254.24.48	Polled

The status is in one of the following states:

- **Not Polled**—The switch has not attempted to contact the IP address in the L3/IP Discovery list.
- **Polled**—The switch has attempted to contact the IP address.
- **Discovered**—The switch contacted the peer switch or AP with IP address in the L3/IP Discovery list and has authenticated or validated the device.
- **Discovered - Failed**—The switch contacted the peer switch or AP with IP address in the L3/IP Discovery list and was unable to authenticate or validate the device.

If the device is an access point, an entry appears in the AP failure list with a failure reason.

For information about adding IP addresses to the IP Discovery list, see [“Configuring IP Addresses of Peers and APs in the Switch”](#) on page 65.

Monitoring Peer Switch Status

The Peer Switch page provides information about other D-Link Unified Switches in the network. To access the peer switch information, click **Monitoring > Peer Switch**.

Peer unified switches within the same peer group exchange data about themselves, their managed APs, and clients. The switch maintains a database with this data so you can view information about a peer, such as its IP address and software version. If the switch loses contact with a peer, all of the data for that peer is deleted.

Peer switches do not exchange configuration profiles or additional data about their managed APs. This means that you cannot view any other status or statistics for a managed AP from a peer switch. However, switches do use shared information for rogue AP detection.

Figure 57. Peer Switch Status

IP Address	Vendor ID	Software Version	Protocol Version	Discovery Reason	Age
192.168.17.103	LVL7	D.6.6.1	1	IP Poll	0h:0m:3s

Table 25 describes the fields available on the **Peer Switch Status** page.

Table 25. Peer Switch Status

Field	Description
IP Address	IP address of the peer unified switch managed in the peer group.
Vendor ID	Vendor of the peer switch software.
Software Version	The software version for the given peer switch.
Protocol Version	Version of protocol software on the peer switch.
Discovery Reason	The discovery method of the given peer switch, which can be one of the following methods: <ul style="list-style-type: none"> L2 Poll IP Poll
Age	Time since last communication with the switch in Hours, Minutes, and Seconds.

Monitoring All Access Points

The **Monitoring > Access Points > All Access Points** page shows summary information about managed, failed, and rogue access points the switch has discovered or detected.

Figure 58. All Access Points

MAC Address	Location	IP Address	Firmware Version	Age	Status	Profile	Radio	Channel	Authenticated Clients
00:01:01:02:01:01	TestLab	192.168.0.1	1.0	0h:55m:1	Managed	1-Default	802.11a	0	14
00:01:01:02:02:01	DevLab	192.168.0.2	1.0	0h:55m:1	Managed	1-Default	802.11g	0	0
00:01:01:02:03:01	Eng	192.168.0.3	1.0	0h:55m:1	Managed	1-Default	802.11a	0	0
00:03:7f:e0:00:1c	N/A	192.168.17.3	N/A	0h:5m:55	Failed: No Database Entry	N/A	802.11g	0	0

The font color for the AP listing indicates that the AP is one of the following types:

- Green—Managed AP
- Red—Failed AP
- Gray—Rogue AP
- Amber—Peer Managed AP

Table 26 describes the fields on the **All Access Points** page.

Table 26. Monitoring All Access Points

Field	Description
MAC Address	Shows the MAC address of the access point.
Location	A location description for the AP. This is the value configured in the valid AP database (either locally or on the RADIUS server).
IP Address	The network address of the access point.
Firmware Version	Shows the version of D-Link Access Point software that the AP is running.
Age	Shows how much time has passed since the AP was last detected and the information was last updated.
Status	Shows the access point status: <ul style="list-style-type: none"> • Managed—The AP profile configuration has been applied to the AP and it's operating in managed mode. • No Database Entry—The MAC address of the AP does not appear in the local or RADIUS Valid AP database. • Authentication (Failed AP)—The AP failed to be authenticated by the Unified Switch or RADIUS server. • Failed—The Unified Switch lost contact with the AP; a failed entry will remain in the managed AP database unless you remove it. Note that a managed AP will temporarily show a failed status during a reset. • Rogue—The AP has not attempted to contact the switch, and the MAC address of the AP is not in the Valid AP database. • Acknowledged Rogue—The AP has been acknowledged as a known rogue, and its MAC address of the AP is in the Valid AP database.
Profile	The AP profile configuration currently applied to the managed AP. The profile is assigned to the AP in the valid AP database. NOTE: Once an AP is discovered and managed by the Unified Switch, if the profile is changed in the valid AP database (either locally or on the RADIUS server) the AP is automatically reset when a new profile is assigned.
Radio	Shows the wireless radio mode that each radio on the AP is using. The D-Link DWL-3500AP access point has one radio, and the D-Link DWL-8500AP access point has two radios.
Channel	Shows the operating channel for the radio.
Authenticated Clients	Shows the number of wireless clients that are associated and authenticated with the access point per radio.

NOTE: Some values for APs in the All Access Points list are unknown. The unknown values are listed as N/A.

Monitoring Managed Access Point Status

From the **Monitoring > Access Points > Managed Access Points** page, you can access a variety of information about each AP that the switch manages. The pages you access from the Status tab provide configuration and association information about managed APs and their neighbors. The pages you access from the Statistics page display information about the number of packets and bytes transmitted and received on different interfaces.

Figure 59 shows the **Managed Access Point Status** page with three managed APs.

Figure 59. Managed AP Status

MAC Address	Location	IP Address	Software Version	Age	Status	Configuration	Profile	Radio	Channel	Authenticated Clients
00:11:95:a3:7a:e0		10.254.24.254	11.52.01	0h:0m:5s	Managed	Success	Default	1-802.11a	165	0
00:11:95:a3:7b:00		10.254.25.6	48.50.29	0h:0m:1s	Managed	Success	Default	2-802.11g 1-802.11a	1 157	0 0
00:11:95:a3:7b:50	Conference Room A	10.254.25.9	48.50.29	0h:0m:1s	Managed	Success	Default	2-802.11g 1-802.11a	6 44	0 0
								2-802.11g	11	0

The following tabs are available from the **Managed AP Status** page:

- **Summary**—Lists the APs managed by the switch and provides summary information about them.
- **Detail**—Shows detailed status information collected from the AP.
- **Radio Summary**—Shows the channel, transmit power, and number of associated wireless clients for all managed APs.
- **Radio Detail**—From the Radio Summary page, click the MAC address of the AP to view detailed status for a radio interface. Use the radio button to navigate between the two radio interfaces.
- **Neighbor APs**—Shows the neighbor APs that the specified AP has discovered through periodic RF scans on the selected radio interface.
- **Neighbor Clients**—Shows information about wireless clients associated with an AP or detected by the AP radio.
- **VAP**—Shows summary information about the virtual access points (VAPs) for the selected AP and radio interface on the APs that the switch manages.

Table 27 describes the fields you see on the **Summary** page for the managed access point status.

Table 27. Managed Access Point Status

Field	Description
MAC Address	The Ethernet address of the Unified Switch managed AP.
Location	A location description for the AP. This is the value configured in the valid AP database (either locally or on the RADIUS server).

Table 27. Managed Access Point Status

Field	Description
IP Address	The network IP address of the managed AP.
Software Version	The software version the AP is currently running.
Age	Time since last communication between the WDS and the AP.
Status	The current managed state of the AP. The possible values are: <ul style="list-style-type: none"> • Discovered - The AP is discovered and by the switch, but is not yet authenticated. • Authenticated - The AP has been validated and authenticated (if authentication is enabled), but it is not configured. • Managed - The AP profile configuration has been applied to the AP and it's operating in managed mode. • Failed - The Unified Switch lost contact with the AP, a failed entry will remain in the managed AP database unless you remove it. Note that a managed AP will temporarily show a failed status during a reset.
Configuration Status	This status indicates if the AP is configured successfully with the assigned profile. The status is one of the following: <ul style="list-style-type: none"> • Not Configured - The profile has not been sent to the AP yet, the AP may be discovered but not yet authenticated. • In Progress - The switch is currently sending the AP profile configuration packet to the AP. • Success - The entire profile has been sent to the AP and there were no configuration errors. • Partial Success - The entire profile has been sent to the AP and there were configuration errors (for example, some configuration parameters were not accepted), but the AP is operational. • Failure - The profile has been sent to the AP and there were configuration errors, the AP is not operational.
Profile	The AP profile configuration currently applied to the managed AP, the profile is assigned to the AP in the valid AP database. NOTE: Once an AP is discovered and managed by the Unified Switch, if the profile is changed in the valid AP database (either locally or on the RADIUS server) the AP must be reset to configure with the new profile.
Radio	Shows the wireless radio mode that each radio on the AP is using. The D-Link DWL-3500AP access point has one radio, and the D-Link DWL-8500AP access point has two radios.
Channel	Shows the operating channel for the radio.
Authenticated Clients	Shows the number of wireless clients associated and associated with the access point per radio.

NOTE: You can sort the list of APs by any of the column heading. For example, to sort the APs by the profile they use, click **Profile**.

Viewing Detailed Managed Access Point Status

To view detailed information about an AP that the switch manages, select the MAC address of the AP from the drop-down menu above the table that displays the detailed information. Click the Reset button to reset the managed AP. A pop-up asks you to confirm that you want to reset

the AP. Any wireless clients associated with the access point will be disassociated. To refresh the status information for the AP, click Refresh

Table 28 describes the fields you see on the **Detail** page for the managed access point status.

Table 28. Detailed Managed Access Point Status

Field	Description
MAC Address - Location	The label at the top of the table shows the MAC address and location of the AP. The location is the value configured in the Valid AP database.
IP Address	The network IP address of the managed AP.
Profile	The AP profile configuration currently applied to the managed AP, the profile is assigned to the AP in the valid AP database. Note: Once an AP is discovered and managed by the Unified Switch, if the profile is changed in the valid AP database (either locally or on the RADIUS server) the AP must be reset to configure with the new profile.
Status	The current managed state of the AP. The possible values are: <ul style="list-style-type: none"> Discovered - The AP is discovered and by the switch, but is not yet authenticated. Authenticated - The AP has been validated and authenticated (if authentication is enabled), but it is not configured. Managed - The AP profile configuration has been applied to the AP and it's operating in managed mode. Failed - The Unified Switch lost contact with the AP, a failed entry will remain in the managed AP database unless you remove it. Note that a managed AP will temporarily show a failed status during a reset.
Discovery Reason	This status value indicates how the managed AP was discovered, the status is one of the following values: <ul style="list-style-type: none"> IP Poll Received - The AP was discovered via an IP poll from the Unified Switch, its IP address is configured in the IP polling list. Peer Redirect - The AP was discovered through a peer switch redirect, the AP tried to associate with another peer switch and learned the current Unified Switch IP address from the peer (peer learned Unified Switch IP address in RADIUS server response when validating the AP). Switch IP Configured - The managed AP is configured with the Unified Switch IP address. Switch IP DHCP - The managed AP learned the current Unified Switch IP address through DHCP option 43. L2 Poll Received - The AP was discovered through the D-Link Wireless Device Discovery protocol.

Table 28. Detailed Managed Access Point Status

Field	Description
Configuration Status	<p>This status indicates if the AP is configured successfully with the assigned profile. The status is one of the following:</p> <ul style="list-style-type: none"> • Not Configured - The profile has not been sent to the AP yet, the AP may be discovered but not yet authenticated. • In Progress - The switch is currently sending the AP profile configuration packet to the AP. • Complete Success - The entire profile has been sent to the AP and there were no configuration errors. • Partial Success - The entire profile has been sent to the AP and there were configuration errors, but the AP is operational. • Failure - The profile has been sent to the AP and there were configuration errors, the AP is not operational.
Protocol Version	Indicates the protocol version supported by the software on the AP, this is learned from the AP during discovery.
Software Version	Indicates the version of software on the AP, this is learned from the AP during discovery.
Last Failing Configuration Element	If the configuration status indicates a partial success or complete failure, this field indicates the last element that failed during configuration. This field is only visible if there is a failed element.
Configuration Failure Error Message	If the configuration status indicates a partial success or complete failure, this field contains an ASCII string filled in by the AP containing the error message for the last failing configuration element.
Code Download Status	<p>This indicates the current status of a code download request for this AP. The possible values include the following:</p> <ul style="list-style-type: none"> • Not Started - A code download has not been requested for the AP. • Requested - A code download has been requested for the AP, the switch has not processed the request. • In Progress - The switch is processing a code download request for the AP. • Success - The AP has successfully downloaded the new software image. • Failure - The AP failed to download the new software image.
Associated Clients	Total number of clients currently associated to the AP. This is the sum of all associated clients for all the VAPs enabled on the AP. Association is a transitional state.
Authenticated Clients	Total number of clients currently authenticated to the AP. This is the sum of all authenticated clients for all the VAPs enabled on the AP.
System Uptime	Time in seconds since last power-on reset of the managed AP.
Age	Time since last communication between the WDS and the AP.

Viewing Managed Access Point Radio Summary Information

You can view general information about each operational radio on all APs managed by the switch. The Managed Access Point Radio Summary page shows the channel, transmit power, and number of associated wireless clients for all managed APs. For more information about a specific radio on an AP, click the radio.

Table 29 describes the fields you see on the **Radio Summary** page for the managed access point status.

Table 29. Managed AP Radio Summary

Field	Description
MAC Address	The Ethernet address of the Unified Switch managed AP.
Location	A location description for the AP, this is the value configured in the valid AP database (either locally or on the RADIUS server).
Radio	Indicates the radio interface and configured mode of the radio, if the radio is disabled the radio mode will be displayed as Off instead of showing the configured mode.
Channel	If radio is operational, the current operating channel for the radio.
Transmit Power	If radio is operational, the current transmit power for the radio.
Associated Clients	Total count of clients associated on the physical radio, this is a sum of all the clients associated to each VAP enabled on the radio.
Authenticated Clients	Total number of clients currently associated to the AP that have been authenticated. This is the sum of all authenticated clients for all the VAPs enabled on the radio.

Viewing Detailed Managed Access Point Radio Information

You can view detailed information about each radio on the APs that the Unified Switch manages on the Radio Detail page for the managed access point radio status.

Table 30 describes the fields you see on the **Radio Detail** page for the managed access point status.

Table 30. Managed AP Radio Detail

Field	Description
MAC Address - Location (Drop-down Menu)	Shows the MAC address and location of the AP to which the values on the page apply. To view details about a different AP, select its MAC address from the drop-down menu.
Radio	Indicates the radio interface and configured mode of the radio, if the radio is disabled the radio mode will be displayed as Off instead of showing the configured mode.
Supported Channels	The list of eligible channels the AP reported to the switch for channel assignment. The list is based on country code, hardware capabilities, and any configured channel limitations.
Channel	If radio is operational, the current operating channel for the radio.
Associated Clients	Total count of clients associated on the physical radio, this is a sum of all the clients associated to each VAP enabled on the radio.
Authenticated Clients	Total count of clients authenticated on the physical radio, this is a sum of all the clients authenticated to each VAP enabled on the radio.
Transmit Power	If radio is operational, the current transmit power for the radio.
Authenticated Clients	Total count of clients authenticated clients on the physical radio, this is a sum of all the clients authenticated to each VAP enabled on the radio.

Table 30. Managed AP Radio Detail

Field	Description
Fixed Channel Indicator	This flag indicates if a fixed channel is configured and assigned to the radio, a fixed channel can be configured in the valid AP database (locally or on a RADIUS server).
Fixed Power Indicator	This flag indicates if a fixed power setting is configured and assigned to the radio, a fixed transmit power can be configured in the valid AP database (locally or on a RADIUS server).
Manual Channel Adjustment Status	Indicates the current state of a manual request to change the channel on this radio. The valid values are: <ul style="list-style-type: none"> • Not Started - No request has been made to change the channel. • Requested - A channel change has been requested by the user but has not been processed by the switch. • In Progress - The switch is processing a channel change request for this radio. • Success - A channel change request is complete. • Failure - A channel change request failed.
Manual Power Adjustment Status	Indicates the current state of a manual request to change the power setting on this radio. The valid values are: <ul style="list-style-type: none"> • None - No request has been made to change the power. • Requested - A power adjustment has been requested by the user but has not been processed by the switch. • In Progress - The switch is processing a power adjustment request for this radio. • Success - A power adjustment request is complete. • Failure - A power adjustment request failed.
WLAN Utilization	Indicates the total network utilization for the physical radio, this value is based on radio statistics.
Total Neighbors	Total number of neighbors (both APs and clients) that can be seen by this radio in its RF area.

Viewing Managed Access Point Neighbor APs

During the RF scan, an access point collects and stores beacon information visible from neighboring access points. Access points can store the neighbor information for up to 64 neighbor APs. If the neighbor scan information exceeds the capacity the oldest data in the neighbor list is overwritten.

The **Delete All Neighbors** button clears the list. The list is repopulated as neighbors are discovered.

Table 31 describes the fields you see on the **Neighbor APs** page for the managed access point status.

Table 31. Managed AP Neighbor Status

Field	Description
MAC Address - Location (Drop-down Menu)	Shows the MAC address and location of the AP to which the values on the page apply. To view details about a different AP, select its MAC address from the drop-down menu.
Radio (ex. 1-802.11g)	Indicates a radio interface and its configured mode. Select one of the radios to view the neighbor APs detected via an RF scan on that radio.
Neighbor AP MAC	The Ethernet MAC address of the neighbor AP network, this could be a physical radio interface or VAP MAC address. For D-Link Access Points this is always a VAP MAC address. The neighbor AP MAC address may be cross-referenced in the RF Scan status.
SSID	Service Set ID of the neighbor AP network.
RSSI	Received signal strength indication, this is an indicator of the signal strength relative to the neighbor and may give an idea of the neighbor's distance from the managed AP.
Status	Indicates the managed status of the AP, whether this is a valid AP known to the switch or a Rogue on the network. The valid values are: <ul style="list-style-type: none"> • WS Managed - The neighbor AP is managed by this switch, the neighbor AP status can be referenced using its base MAC address. • Peer WS Managed - The neighbor AP is managed by another switch within the peer group. • Acknowledged Rogue - The AP is configured as a valid AP entry (local or RADIUS), it has been acknowledged and is not reported as Rogue. • Ad Hoc Rogue - The AP neighbor was detected participating in an ad hoc network.
Age	Indicates the time since this AP was last reported from an RF scan on the radio.

Viewing Clients Associated with Neighbor Access Points

The Neighbor Clients page shows information about wireless clients that have been discovered by the selected AP. D-Link Access Points can store information for up to 1024 wireless clients. If the information exceeds the capacity, the oldest data in the neighbor client list is overwritten. The Delete All Neighbors button clears the list. The list is repopulated as neighbors and associated clients are discovered.

Table 32 describes the fields you see on the **Neighbor Clients** page for the managed access point status.

Table 32. Neighbor AP Clients

Field	Description
MAC Address - Location (Drop-down Menu)	Shows the MAC address and location of the AP to which the values on the page apply. To view details about a different AP, select its MAC address from the drop-down menu.
Radio (ex. 1-802.11g)	Indicates a radio interface and its configured mode. Select one of the radios to view the neighbor clients detected on that radio.
Neighbor Client MAC	The Ethernet address of client station.
RSSI	Received signal strength indication, this is an indicator of the signal strength relative to the neighbor and may give an idea of the neighbor's distance from the managed AP.
Channel	The managed AP channel the client frame was received on, which may be different than the operating channel for this radio.
Discovery Reason	Indicates one or more discovery methods for the neighbor client. One or more of the following values may be displayed: <ul style="list-style-type: none"> • RF Scan - The client was reported from an RF scan on the radio. Note that client stations are difficult to detect via RF scan, the other methods are more common for client neighbor detection. • Probe Request - The managed AP received a probe request from the client. • Associated to Managed AP- This neighbor client is associated to another managed AP. • Associated to This AP - The client is associated to this managed AP on the displayed radio. • Associated to Peer AP - The client is associated to an AP managed by a peer switch. • Ad Hoc Rogue - The client was detected as part of an Ad Hoc network.
Age	Indicates the time since this client was last reported from an RF scan on the radio.

Viewing Managed Access Point VAPs

There are eight virtual access points (VAPs) available on each radio of an AP. For each radio of an access point managed by the switch, you can view a summary of the VAP configuration and the number of wireless clients associated with a particular VAP.

Table 33 describes the fields you see on the VAPs page for the managed access point status.

Table 33. Managed Access Point VAP Status

Field	Description
MAC Address - Location (Drop-down Menu)	Shows the MAC address and location of the AP to which the values on the page apply. To view details about a different AP, select its MAC address from the drop-down menu.
Radio (ex. 1-802.11g)	Indicates a radio interface and its configured mode. Select one of the radios to view VAP status for that radio.
VAP ID	The integer ID used to identify the VAP (0-7), this is used to uniquely identify the VAP for configuration via CLI/SNMP.
VAP Mode	Indicates whether or not the VAP is enabled or disabled. VAPs are always configured, but are only sending beacons and accepting clients when they are Enabled.
BSSID	The Ethernet address of the VAP.
SSID	Indicates the network assigned to the VAP. The network for each VAP is configured within the AP profile and the SSID is based on the network configuration.
Client Associations	Indicates the total number of clients currently associated to the VAP.
Client Authentications	Indicates the total number of clients currently authenticated with the VAP.

Monitoring Managed AP Statistics

The managed AP statistics show information about traffic on the wired and wireless interface of the access point. This information can help diagnose network issues, such as throughput problems.

Figure 60 shows the **Managed Access Point Statistics** page with two managed APs.

Figure 60. Managed AP Statistics

MAC Address	Packets Received	Bytes Received	Packets Transmitted	Bytes Transmitted
00:01:01:02:01:01	0	0	0	0
00:01:01:02:02:01	0	0	0	0
00:01:01:02:03:01	0	0	0	0

The following tabs are available from the **Managed AP Statistics** page:

- **WLAN Summary**—Shows summary information about the wireless interfaces on each AP the switch manages.

- **Ethernet Summary**—Shows summary information about the Ethernet (wired) interfaces on each AP the switch manages.
- **Detail**—Shows the number and type of packets transmitted and received on a specific AP.
- **Radio**—Shows per-radio information about the number and type of packets transmitted and received for a specific AP.
- **VAP**—Shows per-VAP information about the number of packets transmitted and received and the number of wireless client failures for a specific AP

On the WLAN Summary and Ethernet Summary pages, click the MAC address of the AP to view detailed statistics about the AP.

Table 34. Managed Access Point WLAN Summary Statistics

Field	Description
MAC Address	The Ethernet address of the Unified Switch managed AP.
Packets Received	Total packets received by the AP on the wireless network.
Bytes Received	Total bytes received by the AP on the wireless network.
Packets Transmitted	Total packets transmitted by the AP on the wireless network.
Bytes Transmitted	Total bytes transmitted by the AP on the wireless network.

NOTE: You can sort the list of APs by any of the column heading. For example, to sort the APs by the number of packets transmitted, click **Packets Transmitted**.

Viewing Managed Access Point Ethernet Statistics

The Ethernet summary statistics show information about the number of packets and bytes transmitted and received on the wired interface of each access point managed by the switch. The wired interface is physically connected to the LAN.

[Table 35](#) describes the fields you see on the **Ethernet Summary** page for the managed access point statistics.

Table 35. Managed Access Point Ethernet Summary Statistics

Field	Description
MAC Address	The Ethernet address of the Unified Switch managed AP.
Packets Received	Total packets received by the AP on the wired network.
Bytes Received	Total bytes received by the AP on the wired network.
Packets Transmitted	Total packets transmitted by the AP on the wired network.
Bytes Transmitted	Total bytes transmitted by the AP on the wired network.

Viewing Detailed Managed Access Point Statistics

The detailed AP statistics show information about the packets and bytes transmitted and received on the wired and wireless interface of a particular access point managed by the switch.

Table 36 describes the fields you see on the **Detail** page for the managed access point statistics.

Table 36. Detailed Managed Access Point Statistics

Field	Description
MAC Address -Location (Drop-down Menu)	Shows the MAC address and location of the AP to which the values on the page apply. To view details about a different AP, select its MAC address from the drop-down menu.
WLAN Packets Received	Total packets received by the AP on the wireless network.
WLAN Bytes Received	Total bytes received by the AP on the wireless network.
WLAN Packets Transmitted	Total packets transmitted by the AP on the wireless network.
WLAN Bytes Transmitted	Total bytes transmitted by the AP on the wireless network.
Ethernet Packets Received	Total packets received by the AP on the wired network.
Ethernet Bytes Received	Total bytes received by the AP on the wired network.
Ethernet Packets Transmitted	Total packets transmitted by the AP on the wired network.
Ethernet Bytes Transmitted	Total bytes transmitted by the AP on the wired network.
Multicast Packets Received	Total multicast packets received by the AP on the wired network.
Total Receive Errors	Total receive errors detected by the AP on the wired network.
Total Transmit Errors	Total transmit errors detected by the AP on the wired network.

Viewing Managed Access Point Radio Statistics

The radio statistics show detailed information about the packets and bytes transmitted and received on the radio (wireless) interface of a particular access point managed by the switch.

Table 37 describes the fields you see on the **Radio** page for the managed access point statistics.

Table 37. Managed Access Point Radio Statistics

Field	Description
MAC Address -Location (Drop-down Menu)	Shows the MAC address and location of the AP to which the values on the page apply. To view details about a different AP, select its MAC address from the drop-down menu.
WLAN Packets Received	Total packets received by the AP on this radio interface.
WLAN Bytes Received	Total bytes received by the AP on this radio interface.
WLAN Packets Transmitted	Total packets transmitted by the AP on this radio interface.
WLAN Bytes Transmitted	Total bytes transmitted by the AP on this radio interface.
Fragments Received	Count of successfully received MPDU frames of type data or management.
Fragments Transmitted	Number of transmitted MPDU with an individual address or an MPDU with a multicast address of type Data or Management.
Multicast Frames Received	Count of MSDU frames received with the multicast bit set in the destination MAC address.

Table 37. Managed Access Point Radio Statistics

Field	Description
Multicast Frames Transmitted	Count of successfully transmitted MSDU frames where the multicast bit is set in the destination MAC address.
Duplicate Frame Count	Number of times a frame is received and the Sequence Control field indicates is a duplicate.
Failed Transmit Count	Number of times a MSDU is not transmitted successfully due to transmit attempts exceeding either the short retry limit or the long retry limit.
Transmit Retry Count	Number of times a MSDU is successfully transmitted after one or more retries.
Multiple Retry Count	Number of times a MSDU is successfully transmitted after more than one retry.
RTS Success Count	Count of CTS frames received in response to an RTS frame.
RTS Failure Count	Count of CTS frames not received in response to an RTS frame.
ACK Failure Count	Count of ACK frames not received when expected.
FCS Error Count	Count of FCS errors detected in a received MPDU frame.
Frames Transmitted	Count of each successfully transmitted MSDU.
WEP Undecryptable Count	Count of encrypted frames received and the key configuration of the transmitter indicates that the frame should not have been encrypted or that frame was discarded due to the receiving station not implementing the privacy option.

Viewing Managed Access Point VAP Statistics

The VAP statistics show information about the client failures and number of packets and bytes transmitted and received on each VAP on radio one or two for a particular access point managed by the switch.

[Table 38](#) describes the fields you see on the **VAP** page for the managed access point statistics.

Table 38. Managed Access Point VAP Statistics

Field	Description
MAC Address -Location (Drop-down Menu)	Shows the MAC address and location of the AP to which the values on the page apply. To view information about a different AP, select its MAC address from the drop-down menu.
Radio (ex. 1-802.11g)	Indicates a radio interface and its configured mode. Select one of the radios to view its VAP statistics.
VAP ID	Select one of the 8 VAPs from the drop-down menu to display its statistics. All VAPs are available regardless of whether they are enabled.
WLAN Packets Received	Total packets received by the AP on this VAP.
WLAN Bytes Received	Total bytes received by the AP on this VAP.
WLAN Packets Transmitted	Total packets transmitted by the AP on this VAP.
WLAN Bytes Transmitted	Total bytes transmitted by the AP on this VAP.

Table 38. Managed Access Point VAP Statistics

Field	Description
Client Association Failures	Number of clients that have been denied association to the VAP.
Client Authentication Failures	Number of clients that have failed authentication to the VAP.

Viewing Access Point Authentication Failure Status

An AP might fail to associate to the switch due to errors such as invalid packet format or vendor ID, or because the AP is not configured as a valid AP with the correct local or RADIUS authentication information.

Status entries for failed access points are collected at a point in time and eventually age out. The age value for each entry shows how long ago the switch recorded the entry. You can configure the age out time for status entries on the **Administration > Advanced Configuration > Global** page. You can also manually delete status entries.

To view a list of APs that failed to associate with the D-Link Unified Switch, click **Monitoring > Access Points > Authentication Failed Access Points**.

Figure 61. Authentication Failed AP Status

Access Point Failure Status				
	MAC Address	IP Address	Last Failure Type	Age
<input type="checkbox"/>	00:03:7f:e0:00:1c	192.168.17.33	No Database Entry	1h:9m:6s
<input type="checkbox"/>	00:11:95:e1:5d:10	192.168.17.110	No Database Entry	1h:12m:4s

The AP authentication failure list shows information about APs that failed to establish communication with the D-Link Unified Switch. The AP can fail due to one of the following reasons:

- **No Database Entry**—The MAC address of the AP is not in the local Valid AP database or the external RADIUS server database, so the AP has not been validated.
- **Authentication**—The authentication password configured in the AP did not match the password configured in the local database or RADIUS database.

To delete the entries for all APs from the failure list, click **Delete All**. To add an AP from the access point authentication failure list to the Valid AP database, select the check box next to the MAC address of the AP and click **Manage**. If you use the local database for AP Validation, you can click the **Administration > Basic Setup > Valid AP** tab to modify the AP configuration.

If you use a RADIUS server for AP validation, you must add the MAC address of the AP to the RADIUS server database.

Click the MAC address of the AP to view more information about the AP. If the AP is not a D-Link Access Point, some values are unknown.

To view additional data (beacon information) for an AP in the failure list, you can search for the MAC address of the failed AP on the Rogue/RF Scan page. However, some APs that attempt to contact the switch on the wired network might not be detected during the RF scan.

Table 39. Access Point Authentication Failure Status

Field	Description
MAC Address	The Ethernet address of the AP.
IP Address	The network IP address of the AP.
Last Failure Type	Indicates the last type of failure that occurred.
Vendor ID	Vendor of the AP software.
Validation Failures	The count of association failures for this AP.
Authentication Failures	The count of authentication failures for this AP.
Protocol Version	Indicates the protocol version supported by the software on the AP.
Software Version	Indicates the version of software on the AP.
Hardware Type	Hardware platform for the AP.
Age	Time in seconds since failure occurred.

Monitoring Rogue and RF Scan Access Points

The radios on each D-Link Access Point can periodically scan the radio frequency to collect information about other APs and wireless clients that are within range. In normal operating mode the AP always scans on the operational channel for the radio. Two other scan modes are available for each radio on the APs:

- **Scan Other Channels**—Configures the AP to periodically leave its operational channel and scan other channels within that frequency.
- **Scan Sentry**—Disables normal operation of the radio and performs a continuous radio scan. In this mode, no beacons are sent, and no clients are allowed to associate with the AP.

When Scan Other Channels or Scan Sentry modes are enabled, the AP scans all available channels on each radio. When the scan is complete, the AP sends information it collected during the RF scan to the switch that manages it. For information about how to configure the scan mode, see [“Configuring Wireless Radio Settings”](#) on page 81.

The D-Link Unified Switch considers an access point to be a Rogue if is detected during the RF scan process and the MAC address of the detected AP is not in the local or RADIUS Valid AP database or if the AP is not managed by a peer switch.

From the **Monitoring > Access Points > Rogue/RF Scan Access Points** page, you can view information about all APs detected via RF scan, including those reported as Rogues.

You can sort the APs in the list based any of the column headings. For example, to group all Rogue APs together, click **Status**.

Status entries in the RF Scan list are collected at a point in time and eventually age out. The age value for each entry shows how long ago the switch recorded the entry. You can configure the age out time for status entries on the **Administration > Advanced Configuration > Global** page. You can also manually delete status entries. To clear all APs from the RF scan list, click **Delete All**.

To configure a Rogue AP to be managed by the switch next time it is discovered, select the check box next to the MAC address of a detected AP and click **Manage**. The switch adds the AP to the Valid AP database as a Managed AP with the default AP profile. Then, you can use the switch to configure the AP settings. If you use a RADIUS server for AP validation, you must add the MAC address of the AP to the AP database on the RADIUS server. For more information, see Appendix B, “[Configuring the External RADIUS Server](#)” on page 179.

Figure 62. RF Scan

The screenshot shows the 'Access Point RF Scan Status' page with a table of detected APs. The table has columns for MAC Address, SSID, Physical Mode, Channel, Status, and Age. Two rows are selected with checkmarks in the first column. A 'Manage' button is highlighted with a mouse cursor. Below the table, there are buttons for 'Delete All', 'Manage', 'Acknowledge', and 'Refresh'. A label 'Selected APs to Manage' points to the selected rows, and a page indicator '1 2 3' is visible.

MAC Address	SSID	Physical Mode	Channel	Status	Age
<input checked="" type="checkbox"/> 00:0f:b5:11:46:00	NG-PM	802.11g	11	Rogue	0h:35m:38s
<input checked="" type="checkbox"/> 00:02:bc:00:15:2c	Big Net 5	802.11g	11	Rogue	0h:0m:8s
<input type="checkbox"/> 00:03:7f:e0:00:24	Guest Network	802.11g	11	WS Managed	0h:46m:33s
<input type="checkbox"/> 00:11:95:e1:5d:10	Guest Network	802.11a	60	WS Managed	0h:49m:9s
<input type="checkbox"/> 00:03:7f:e0:00:1c	Guest Network	802.11a	36	WS Managed	0h:39m:3s
<input type="checkbox"/> 00:11:95:e1:5d:18	Guest Network	802.11g	6	WS Managed	0h:52m:38s

To identify an AP as an acknowledge rogue, select the check box next to the MAC address of the AP and click **Acknowledge**. The switch adds the AP to the Valid AP database as an Acknowledged Rogue.

When you manage or acknowledge a rogue AP, the switch adds an entry to the valid AP database but does not change the entry on the RF Scan Status page. However, the next time the switch discovers the AP, its entry in the RF Scan Status list will be handled based on the change.

To view additional information about the detected AP, click the MAC address of the AP.

The detailed status for access points detected during the RF scan shows the information on the summary page plus some additional information learned from the beacon frame, such as transmission rate.

The following table shows the information the Access Point RF Scan Status page shows for an individual access point.

Table 40. Access Point RF Scan Status

Field	Description
MAC Address	The Ethernet MAC address of the detected AP, this could be a physical radio interface or VAP MAC. For D-Link Access Points this is always a VAP MAC address.
SSID	Service Set ID of the network, this is broadcast in detected beacon frame.
Physical Mode	Indicates the 802.11 mode being used on the AP.
Channel	Transmit channel of the AP.
Status	Indicates the managed status of the AP, whether this is a valid AP known to the switch or a Rogue on the network. The valid values are: <ul style="list-style-type: none"> • WS Managed - The neighbor AP is managed by this switch, the neighbor AP status can be referenced using its base MAC address. • Peer WS Managed - The neighbor AP is managed by another switch within the peer group. • Acknowledged Rogue - The AP is configured as a valid AP entry (local or RADIUS), it has been acknowledged and is not reported as Rogue. • Ad Hoc Rogue - The AP neighbor was detected participating in an ad hoc network.
Transmit Rate	Indicates the rate at which the AP is currently transmitting data.
Beacon Interval	Beacon interval for the neighbor AP network.
Discovered Age	Time in seconds since this AP was first detected in an RF scan.
Age	Time in seconds since this AP was last detected in an RF scan.

Monitoring Associated Client Information

You can view a variety of information about the wireless clients that are associated with the APs the switch manages. To access the associated client information, click **Monitoring > Client > Associated Clients**.

Figure 63. Associated Client Status



The following tabs are available:

- **Status**—Shows status information about wireless clients that are associated with APs managed by the switch and contains the following information:
 - **Summary**—Shows basic information about associated clients.
 - **Detail**—Shows more detailed information about associated clients, such as which VLAN the client is assigned to and how long the client has been inactive.
 - **Neighbor APs**—Shows the managed APs that are within range of the wireless clients, which can help you determine the managed AP an associated client might use for roaming.
- **SSID Status**—Shows the SSID and client MAC address of all clients connected to specific networks.
- **VAP Status**—Shows the clients associated with a specific VAP on a D-Link Access Point
- **Statistics**—Shows statistics about wireless clients that are associated with APs managed by the switch and contains the following information:
 - **Association Summary**—Shows the statistics for a wireless client while it is associated with a single AP.
 - **Session Summary**—If a wireless client roams among different managed APs, the switch can track the statistics for the entire session.
 - **Association Detail**—Shows additional information about packets the associated client transmits and receives during association with a single managed AP.
 - **Session Detail**—Shows additional information about packets the associated client transmits and receives during a session, which can include statistics for one or more managed AP associations if the client has roamed.

Since the associated client database supports roaming across APs, an entry is not removed when a client disassociates from a specific AP. After a client has disassociated the entry is deleted after the client times out. You configure the timeout value in the Client Roam Timeout field on the **WLAN > Administration > Advanced Configuration > Global** page. The timeout value corresponds to the time allowed for roaming to another managed AP.

Viewing Associated Client Status

Table 41 describes the information available on the **Summary** page for the associated client status.

Table 41. Associated Client Status Summary

Field	Description
MAC Address	The Ethernet address of client station.
AP MAC Address	The Ethernet MAC address of the AP that the client is associated with.
SSID	Indicates the network on which the client is connected.
Tunnel IP Address	If the client is using an L3 Tunnel, this field shows the IP address of the client. Otherwise, this field is blank.
Location	The location of the AP that the client is associated with. The AP location is configured in the Valid AP database.
Channel	Indicates the operating channel for the client association.
Radio	The mode of the radio that the wireless client is using.

Table 41. Associated Client Status Summary

Field	Description
Encryption Protocol	The security that the wireless client is using to connect to the WLAN.
Status	Indicates whether or not the client has associated and/or authenticated. The valid values are: <ul style="list-style-type: none"> • Associated - The client is current associated to the managed AP. • Authenticated - The client is currently associated and authenticated to the managed AP. • Disassociated - The client has disassociated from the managed AP, if the client does not roam to another managed AP within the client roam timeout, it will be deleted.

Viewing Detailed Associated Client Status

For each client associated with an AP that the switch manages, you can view detailed status information about the client and its association with the access point.

[Table 42](#) describes the information available on the **Detail** page for the associated client status.

Table 42. Detailed Associated Client Status

Field	Description
MAC Address	The Ethernet address of client station. To view details about a different client, select its MAC address from the drop-down menu.
SSID	Indicates the network on which the client is connected.
AP MAC Address	MAC address of the AP to which this client is associated.
BSSID	Indicates the Ethernet MAC address for the managed AP VAP where this client is associated.
Location	Location of the AP to which this client is associated.
Status	Indicates whether or not the client has associated and/or authenticated. The valid values are: <ul style="list-style-type: none"> • Associated - The client is current associated to the managed AP. • Authenticated - The client is currently associated and authenticated to the managed AP. • Disassociated - The client has disassociated from the managed AP, if the client does not roam to another managed AP within the client roam timeout, it will be deleted.
Radio	Indicates the radio on which the client is associated.
Channel	Indicates the operating channel for the client association.
VLAN	If client is on a VAP using VLAN data forwarding mode, indicates the current assigned VLAN.
User Name	Indicates the user name of client that have authenticated via 802.1x, clients on networks with other security modes will not have a user name.
Transmit Data Rate	Indicates the rate at which the client station is currently transmitting data.
Inactive Period	For current association, period of time that the AP has not seen any traffic for the client.

Table 42. Detailed Associated Client Status

Field	Description
Age	Indicates the time in seconds since the switch has received new association data for this client.
Tunnel IP Address	This field is blank for all non-tunneled clients. For a tunneled client, this is the assigned tunnel IP address.

Viewing Associated Client Neighbor AP Status

The **Neighbor AP** page for the associated client status shows information about access points that the client detects. The information on this page can help you determine the managed AP an associated client might use for roaming.

[Table 43](#) describes the information available on the **Neighbor AP** page for the associated client status.

Table 43. Associated Client Neighbor AP Status

Field	Description
MAC Address (Drop-down Menu)	Shows the MAC address of the client to which the values on the page apply. To view details about a different associated client, select its MAC address from the drop-down menu.
AP MAC Address	The base Ethernet address of the Unified Switch-managed AP.
Location	The configured descriptive location for the managed AP
Radio	The radio interface and its configured mode that detected this client as a neighbor.
Discovery Reason	Indicates one or more discovery methods for the neighbor client. One or more of the following values may be displayed: <ul style="list-style-type: none"> • RF Scan - The client was reported from an RF scan on the radio. Note that client stations are difficult to detect via RF scan, the other methods are more common for client neighbor detection. • Probe Request - The managed AP received a probe request from the client. • Associated to Managed AP- This neighbor client is associated to another managed AP. • Associated to this AP - The client is associated to this managed AP on the displayed radio. • Associated to Peer AP - The client is associated to an AP managed by a peer switch. • Ad Hoc Rogue - The client was detected as part of an ad hoc network with this AP.

Viewing Associated Client SSID Status

Each managed AP can have up to 16 different networks that each have a unique SSID. Although several wireless clients might be connected to the same physical AP, they might not

connect by using the same SSID. The **SSID Status** page lists the SSIDs of the networks that each wireless client associated with a managed AP has used for WLAN access.

Table 44. Associated Client SSID Status

Field	Description
SSID	Indicates the network on which the client is connected.
MAC Address	The Ethernet address of client station.
Channel	Indicates the operating channel for the client association.
Status	Indicates whether or not the client has associated and/or authenticated. The valid values are: <ul style="list-style-type: none"> • Associated - The client is current associated to the managed AP. • Authenticated - The client is currently associated and authenticated to the managed AP. • Disassociated - The client has disassociated from the managed AP, if the client does not roam to another managed AP within the client roam timeout, it will be deleted.

Viewing Associated Client VAP Status

Each AP has 8 Virtual Access Points (VAPs) per radio, and every VAP has a unique MAC address (BSSID). The VAP Associated Client Status page shows information about the VAPs on the managed AP that have associated wireless clients.

Table 45. Associated Client VAP Status

Field	Description
BSSID	Indicates the Ethernet MAC address for the managed AP VAP where this client is associated.
SSID	The SSID the client is using to connect to the WLAN.
AP MAC Address	This field indicates the base AP Ethernet MAC address for the managed AP.
Location	The descriptive location configured for the managed AP.
Radio	Displays the managed AP radio interface the client is associated to and its configured mode.
Client MAC Address	The Ethernet address of client station.
Client IP Address	Shows the IP address of the client associated with the VAP.

Viewing Associated Client Statistics

A wireless client can roam among APs without interruption in WLAN service. The D-Link Unified Switch tracks the traffic the client sends and receives during the entire wireless session while the client roams among APs that the switch manages. The switch stores statistics about client traffic while it is associated with a single AP as well as throughout the roaming session.

The statistics on the **Association Summary** page show information about the traffic a wireless client receives and transmits while it is associated with a single AP.

Table 46. Associated Client Association Summary Statistics

Field	Description
MAC Address	The Ethernet address of client station.
Packets Received	Packets received from the client station.
Bytes Received	Bytes received from the client station.
Packets Transmitted	Packets transmitted to the client station.
Bytes Transmitted	Bytes transmitted to the client station.

The statistics on the **Session Summary** page show information about the traffic a wireless client receives and transmits while it is connected to the same WLAN network shared by APs that the switch manages.

If the client roams from one AP to another AP but remains connected to the same network, the session continues and the session statistics continue to accumulate. If the client closes the wireless connection or roams out of the range of an AP managed by the switch, the session ends.

Table 47. Associated Client Summary Statistics

Field	Description
MAC Address	The Ethernet address of client station.
Packets Received	Packets received from the client station.
Bytes Received	Total bytes received from the client station.
Packets Transmitted	Total packets transmitted to the client station.
Bytes Transmitted	Total bytes transmitted to the client station.

The statistics on the **Association Detail** page show information about the traffic a wireless client receives and transmits while it is associated with a single AP.

Table 48. Associated Client Association Detail Statistics

Field	Description
MAC Address (Drop-down Menu)	Shows the MAC address of the client to which the values on the page apply. To view details about a different associated client, select its MAC address from the drop-down menu.
Packets Received	Total packets received from the client station.
Bytes Received	Total bytes received from the client station.
Packets Transmitted	Total packets transmitted to the client station.
Bytes Transmitted	Total bytes transmitted to the client station.
Fragments Received	Total fragmented packets received from the client station.
Fragments Transmitted	Total fragmented packets transmitted to the client station.
Transmit Retries	Number of times transmits to client station succeeded after one or more retries.

Table 48. Associated Client Association Detail Statistics

Field	Description
Transmit Retries Failed	Number of times transmits to client station failed after one or more retries.
Duplicates Received	Total duplicate packets received from the client station.

The statistics on the **Session Detail** page show information about the traffic a wireless client receives and transmits while it is connected to the same WLAN network shared by APs that the switch manages.

Table 49. Associated Client Session Detail Statistics

Field	Description
MAC Address (Drop-down Menu)	Shows the MAC address of the client to which the values on the page apply. To view details about a different associated client, select its MAC address from the drop-down menu.
Packets Received	Total packets received from the client station.
Bytes Received	Total bytes received from the client station.
Packets Transmitted	Total packets transmitted to the client station.
Bytes Transmitted	Total bytes transmitted to the client station.
Fragments Received	Total fragmented packets received from the client station.
Fragments Transmitted	Total fragmented packets transmitted to the client station.
Transmit Retries	Number of times transmits to client station succeeded after one or more retries.
Transmit Retries Failed	Number of times transmits to client station failed after one or more retries.
Duplicates Received	Total duplicate packets received from the client station.

Viewing Client Authentication Failure Status

Wireless clients that fail to associate or authenticate with an AP appear in the client failure list along with the number of failed attempts. The client might have security or authentication information that does not match the settings on the AP.

Status entries for failed clients are collected at a point in time and eventually age out. The age value for each entry shows how long ago the switch recorded the entry. You can configure the age out time for status entries on the **Administration > Advanced Configuration > Global** page. You can also manually delete status entries.

To view a list of clients that fail to associate or authenticate with the a D-Link Access Point, click the **Failed Clients** page.

Figure 64. Client Authentication Failure Status

Client Failure Status					
	MAC Address	BSSID	SSID	Last Failure Type	Age
<input type="checkbox"/>	00:01:21:18:01:01	00:01:01:02:02:02	Network2	Authentication	15h:44m:57s
<input type="checkbox"/>	00:01:32:18:01:01	00:01:01:02:01:03	Network3	Association	15h:44m:57s

Buttons: Delete All, Allow MAC, Deny MAC, Refresh

To delete all clients from the list, click **Delete All**.

To block a failed client from WLAN access, select the check box next to the MAC address of the client and click **Deny MAC**. The MAC address is added to the MAC Authentication Deny MAC List for all AP Profiles where the default action is Deny. To add the client to the MAC Authentication Allow MAC List for all profiles where the default action is Allow, select the client and click **Allow MAC**. You must re-apply the AP profiles in order for the changes to be applied to the APs.

NOTE: If the **Deny MAC** button is not available, it means all profiles use Allow as the default MAC Authentication action. Likewise, if the **Allow MAC** button is not available, no profiles have an Allow default action.

NOTE: If you use RADIUS for MAC authentication in one or more AP profiles, you must add the MAC Address to the RADIUS database.

[Table 50](#) shows the fields on the summary page for failed client status.

Table 50. Failed Client Status

Field	Description
MAC Address	The Ethernet address of the client.
BSSID	The managed AP VAP Ethernet MAC address on which the client attempted to associate and/or authenticate.
SSID	The network SSID on which client attempted to associate and/or authenticate.
Last Failure Type	Indicates the last type of failure that occurred, which can be Authentication or Association.
Age	Time since failure occurred.

Click the MAC address of the failed client to view additional information about a client.

NOTE: If a wrong password is entered on a client for WEP, this page may not list that authentication failed client. This issue actually arises from a known problem with the IEEE 802.11 specification. The specification says that if the AP is unable to decode the third frame (containing the encrypted challenge text), it should send an unsuccessful result. However, if the AP is unable to decode a WEP frame, it does not know whether that frame is actually the third frame, or even a Shared Key frame at all, and does not send a result. This issue only

applies to WEP (which is not recommended due to security issues) that uses Shared Key authentication when the key is incorrect.

The client authentication failure status for an individual client shows information about the client that failed to authenticate or associate with an AP and list the number of authentication or association failures. A client with a high number of failed authentications might indicate a possible threat to the WLAN.

Table 51 shows the fields on the detail page for Client Authentication Failure Status.

Table 51. Client Authentication Failure Status

Field	Description
MAC Address	The Ethernet address of the client.
BSSID	The managed AP VAP Ethernet MAC address on which the client attempted to associate and/or authenticate.
SSID	The network SSID on which client attempted to associate and/or authenticate.
Last Failure Type	Indicates the last type of failure that occurred, which can be Authentication or Association.
Authentication Failure Count	Count of authentication failures for this client.
Association Failure Count	Count of association failures for this client.
Age	Time since failure occurred.

Monitoring and Managing Ad Hoc Clients

An ad hoc client is a wireless client that gains access to the WLAN through a wireless client that is associated with an access point. The ad hoc client does not communicate directly with the AP. Ad hoc networks are a particular concern because they consume RF bandwidth and can present a security risk.

Status entries for ad hoc clients are collected at a point in time and eventually age out. The age value for each entry shows how long ago the switch recorded the entry. You can configure the age out time for status entries on the **Administration > Advanced Configuration > Global** page. You can also manually delete status entries.

From the **Monitoring > Client > Ad Hoc Clients** page, you can view and manage wireless clients that are connected to the WLAN through an ad hoc network.

Figure 65. Ad Hoc Clients

Ad Hoc Client Status						
	MAC Address	AP MAC Address	Location	Radio	Detection Mode	Age
<input type="checkbox"/>	00:01:01:30:01:01	00:01:01:02:01:01		1	Beacon Frame	15h:45m:21s
<input type="checkbox"/>	00:01:01:42:01:01	00:01:01:02:03:01		1	Beacon Frame	15h:45m:21s
<input type="checkbox"/>	00:01:01:45:01:01	00:01:01:02:01:01		1	Beacon Frame	15h:45m:21s

To delete the ad hoc client entries from the list, click **Delete All**. The status list is cleared on the switch.

NOTE: Clearing the list does not disassociate any of the ad hoc clients, and the clients might still be involved in the ad hoc network.

If you want to block an ad hoc client from WLAN access, select the check box next to the MAC address of the client and click **Deny MAC**. The MAC address is added to the MAC Deny List in the AP Profile MAC Authentication settings. If you select the check box and click Allow MAC, the MAC address is added to the Allow MAC List in the AP Profile MAC Authentication settings.

NOTE: The MAC address is added to the local MAC authentication list for all profiles where the global default action is set to allow (for Allow MAC), or deny (for Deny MAC). If you use RADIUS for MAC authentication in one or more AP profiles, you must add the MAC to the RADIUS database.

Each AP profile has one global MAC authentication list which is either a list to deny access to all MAC addresses on the list or to allow access to all MAC addresses on the list. To see the mode for the default AP Profile, click the **Administration > Basic Setup > AAA/RADIUS** tab. Set the MAC Authentication Default Action field to Allow or Deny all MAC Addresses in the list. To set the mode for a different AP profile go to the **Global** tab on the AP Profile to configure.

The switch does not remove MAC entries from this list even when a client successfully authenticates with an AP. The historical ad hoc data gives you more time to take action against clients that establish ad hoc networks on the WLAN.

Table 52. Ad Hoc Client Status

Field	Description
MAC Address	The Ethernet address of the client. If the Detection Mode is Beacon then the client is represented as an AP in the RF Scan database and the Neighbor AP List. If the Detection Mode is Data Frame then the client information is in the Neighbor Client List.
AP MAC Address	The base Ethernet MAC Address of the managed AP which detected the client.
Location	The configured descriptive location for the managed AP.

Table 52. Ad Hoc Client Status

Field	Description
Radio	The radio interface and its configured mode that detected the ad hoc device.
Detection Mode	The mechanism of detecting this Ad Hoc device. The possible values are Beacon Frame or Data Frame.
Age	Time in seconds since last detection of the ad hoc network.

Configuring Advanced Settings

This chapter contains the following sections to help you configure your D-Link Unified Access System network:

- [Creating, Configuring, and Managing AP Profiles](#)
- [Configuring Global Settings](#)
- [Enabling SNMP Traps](#)
- [Configuring QoS](#)

Creating, Configuring, and Managing AP Profiles

Access point configuration profiles are a useful feature for large wireless networks with APs that serve a variety of different users. You can create multiple AP profiles on the D-Link Unified Switch to customize APs based on location, function, or other criteria. Profiles are like templates., and once you create an AP profile, you can apply that profile to any AP that the Unified Switch manages.

For each AP profile, you can configure the following features:

- Global RADIUS settings
- MAC authentication list
- Radio settings
- Network settings
- QoS configuration

[Figure 66](#) shows ten APs that are managed by a D-Link Unified Switch in a campus network. Each building has multiple APs, and the users in one building have different network

requirements than the users in other buildings. The administrator of this WLAN has created two AP profiles on the switch in addition to the default profile.

Figure 66. Multiple AP Profiles

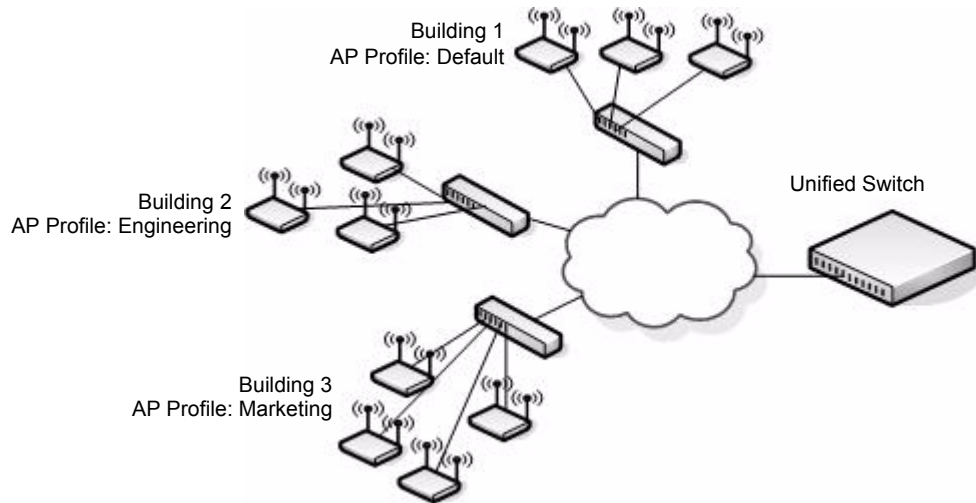

Building 1 contains the main lobby and several conference rooms. The WLAN users in this location are primarily non-employees and guests. The APs in Building 1 use the default AP profile with no additional networks and no security.

Building 2 is the engineering building. The Building 2 APs use a profile called “Engineering.” The Engineering profile has three different VAPs that each have a unique SSID: Hardware, Software and Test.

Building 3 is the Sales and Marketing building. The Building 3 AP uses a profile called “Marketing.” The Marketing AP Profile has three VAPs. The SSIDs for the VAPs are: Sales, Marketing, and Program Management.

If the network administrator adds another AP to Building 2, she assigns the Engineering profile to the AP during the AP validation process.

Creating, Copying, and Deleting AP Profiles

From the **Access Point Profile Summary** page, you can create, copy, or delete AP profiles. You can create up to 16 AP Profiles on the D-Link Unified Switch. To create a new profile, enter the name of the profile in the **Profile Name** field, and then click **Add**.

Figure 67. Adding a Profile



After you add the profile, the **Global Configuration** page for the profile appears, and a new tab with the name of the profile appears at the top of the page. Click the **Radio**, **VAP**, or **QoS** tabs to configure additional features for the profile.

Figure 68 shows the layout for AP Profile configuration.

Figure 68. Configuring an AP Profile

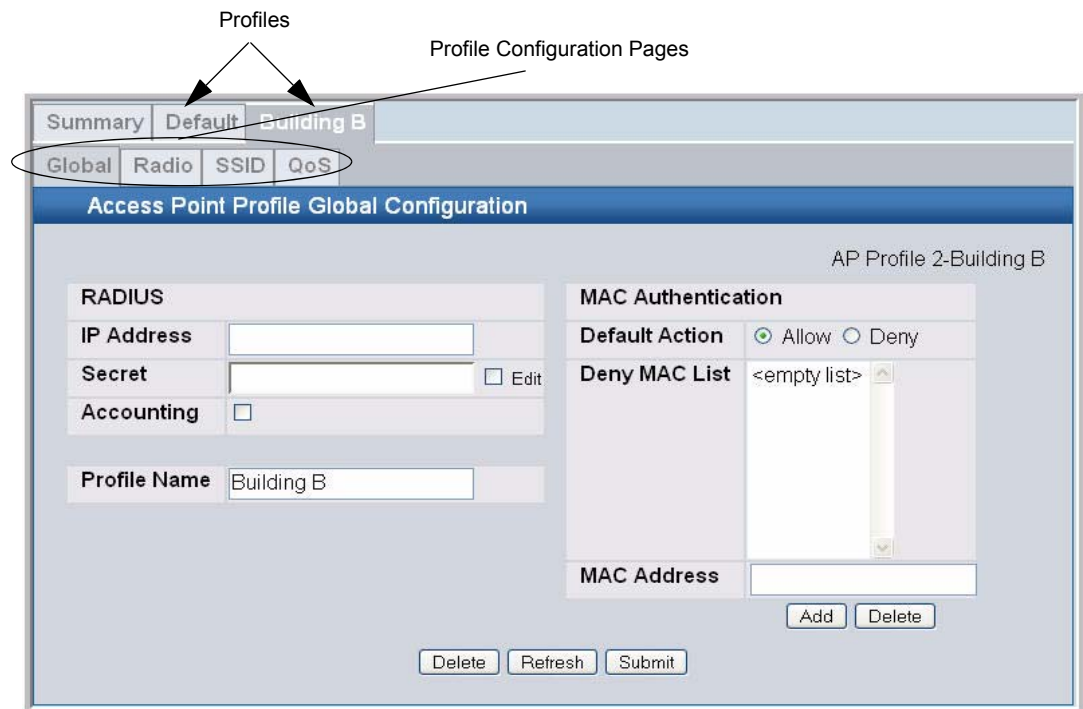

To copy an existing profile and all of its configurations to a new profile, select the profile with the configuration to copy, enter a name for the new profile, and click **Copy**.

To delete a profile, select the profile and click **Delete**.

To access an existing profile, click the tab with the name of the profile. When you add a new profile, it has the default AP settings, which are listed in [Appendix A](#). When you copy a profile, it has the AP settings configured in the original profile.

To modify any settings within a profile, click the Global, Radio, Network or QoS settings for the profile you select and update the appropriate fields.

For more information about the fields on the Global page, see [“Configuring AAA and RADIUS Settings”](#) on page 79.

For more information about the fields on the Radio page, see [“Configuring Wireless Radio Settings”](#) on page 81.

For more information about the fields on the Network page, see [“Configuring SSID Settings”](#) on page 86.

For more information about the fields on the QoS page, see [“Configuring QoS”](#) on page 156.

Applying an AP Profile

After you update an AP Profile on the Unified Switch, the changes are not applied to the access points that use that profile until you explicitly apply the profile on the **Access Point Profile Summary** page or reset the APs that use the profile.

NOTE: When you change the VLAN ID for a wireless network, the AP might temporary lose its DHCP-assigned IP address when you apply the updated profile. As soon as the AP regains its IP address from the DHCP server on your network, it resumes normal operation as a managed AP. You might also see this behavior when you enable or disable a VAP (SSID) and re-apply the AP profile.

To apply the profile changes to all access points that use a profile, select the profile and click **Apply**, as [Figure 69](#) shows.

Figure 69. Applying the AP Profile

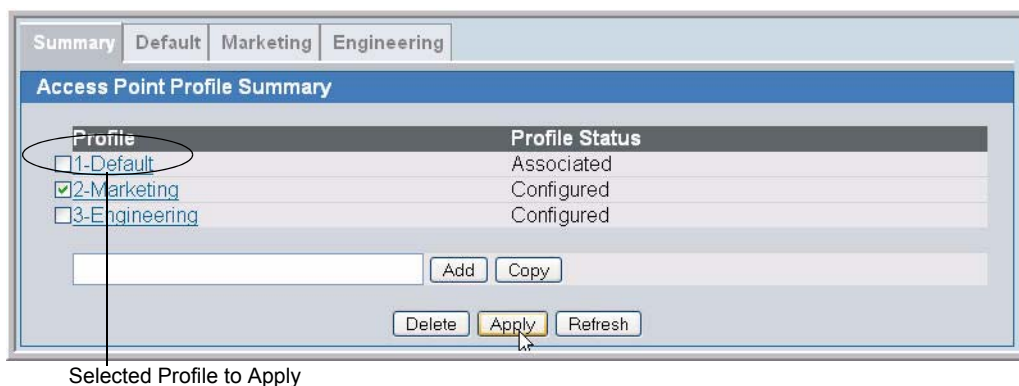

NOTE: When you apply new AP Profile settings to an AP, the access point stops and restarts system processes. If this happens, wireless clients will temporarily

lose connectivity. We recommend that you change access point settings when WLAN traffic is low.

The Profile Status field can have one of the following values:

- **Associated**—The profile is configured, and one or more APs managed by the switch are associated with this profile.
- **Associated-Modified**—The profile has been modified since it was applied to one or more associated APs; the profile must be re-applied for the changes to take effect.
- **Apply Requested**—After you select a profile and click **Apply**, the screen refreshes and shows that an apply has been requested.
- **Apply In Progress**—The profile is being applied to all APs that use this profile. During this process the APs reset, and all wireless clients are disassociated from the AP.
- **Configured**—The profile is configured, but no APs managed by the switch currently use this profile.

NOTE: You associate a profile with an AP in the Valid AP database.

Configuring Global Settings

The fields on the **Administration > Advanced Configuration > Global > General** tab are settings that apply to the D-Link Unified Switch.

Figure 70. Global Configuration

The screenshot shows a web interface for configuring global settings. At the top, there are two tabs: "General" (selected) and "SNMP Traps". Below the tabs is a blue header for "Wireless Global Configuration". The main area contains a table of settings:

Peer Group ID	<input type="text" value="1"/>	(1 to 255)
Client Roam Timeout (secs)	<input type="text" value="30"/>	(1 to 120)
Ad Hoc Client Status (hours)	<input type="text" value="24"/>	(0 to 168)
AP Failure Status (hours)	<input type="text" value="24"/>	(0 to 168)
Client Failure Status (hours)	<input type="text" value="24"/>	(0 to 168)
RF Scan Status (hours)	<input type="text" value="24"/>	(0 to 168)

At the bottom of the form is a "Submit" button.

Table 53 describes the fields on the **Wireless Global Configuration** page.

Table 53. General Global Configurations

Field	Description
Peer Group ID	In order to support larger networks, you can configure unified switches as peers, with up to 4 switches in a peer group. Peer unified switches share some information about APs and allow L3 roaming among them. Peer unified switches are grouped according to the Group ID.
Client Roam Timeout	This value determines how long to keep an entry in the Associated Client Status list after a client has disassociated. Each entry in the status list shows an age, and when the age reaches the value you configure in the timeout field, the entry is deleted.
Ad Hoc Client Status	This value determines how long to keep an entry in the Ad Hoc Client Status list. Each entry in the status list shows an age, and when the age reaches the value you configure in the timeout field, the entry is deleted.
AP Failure Status	This value determines how long to keep an entry in the AP Authentication Failure Status list. Each entry in the status list shows an age, and when the age reaches the value you configure in the timeout field, the entry is deleted.
Client Failure Status	This value determines how long to keep an entry in the Client Authentication Failure Status list. Each entry in the status list shows an age, and when the age reaches the value you configure in the timeout field, the entry is deleted.
RF Scan Status	This value determines how long to keep an entry in the RF Scan Status list. Each entry in the status list shows an age, and when the age reaches the value you configure in the timeout field, the entry is deleted.

Enabling SNMP Traps

If you use Simple Network Management Protocol (SNMP) to manage the D-Link Unified Switch, you can configure the SNMP agent on the switch to send traps to the SNMP manager on your network from the **Administration > Advanced Configuration > Global > SNMP Traps** tab.

Figure 71. SNMP Trap Configuration

The screenshot shows the 'Wireless SNMP Trap Configuration' page. It has two tabs: 'General' and 'SNMP Traps', with 'SNMP Traps' selected. The page title is 'Wireless SNMP Trap Configuration'. Below the title is a table of settings:

AP Failure Traps	Enable
AP State Change Traps	Enable
Client Failure Traps	Enable
Client State Change Traps	Disable
Peer Switch Traps	Enable
RF Scan Traps	Disable
Rogue AP Traps	Disable
Wireless Status Traps	Disable

At the bottom of the page is a 'Submit' button.

The AP does not send out any traps. The switch generates all SNMP traps based on its own events and events it learns about through updates from the APs it manages.

[Table 54](#) describes the events that generate SNMP traps. All traps are disabled by default.

Table 54. SNMP Traps

Field	Description
AP Failure Traps	If you enable this field, the SNMP agent sends a trap if an AP fails to associate or authenticate with the switch.
AP State Change Traps	If you enable this field, the SNMP agent sends a trap for one of the following reasons: <ul style="list-style-type: none"> • Managed AP Discovered • Managed AP Failed • Managed AP Unknown Protocol Discovered • Managed AP Load Balancing Utilization Exceeded
Client Failure Traps	If you enable this field, the SNMP agent sends a trap if a wireless client fails to associate or authenticate with an AP that is managed by the switch.
Client State Change Traps	If you enable this field, the SNMP agent sends a trap for one of the following reasons associated with the wireless client: <ul style="list-style-type: none"> • Client Association Detected • Client Disassociation Detected • Client Roam Detected
Peer Switch Traps	If you enable this field, the SNMP agent sends a trap for one of the following reasons associated with a peer switch: <ul style="list-style-type: none"> • Peer Unified Switch Discovered • Peer Unified Switch Failed • Peer Unified Switch Unknown Protocol Discovered
RF Scan Traps	If you enable this field, the SNMP agent sends a trap when the RF scan detects a new AP, wireless client, or ad-hoc client.
Rogue AP Traps	If you enable this field, the SNMP agent sends a trap when the switch discovers a rogue AP.
Wireless Status Traps	If you enable this field, the SNMP agent sends a trap if the operational status of the D-Link Unified Switch changes or of any of the following databases or lists has reached the maximum number of entries: <ul style="list-style-type: none"> • Managed AP database • AP Neighbor List • Client Neighbor List • AP Authentication Failure List • RF Scan AP List • Client Association Database • Client Authentication Failure List

Configuring QoS

Quality of Service (QoS) provides you with the ability to specify parameters on multiple queues for increased throughput and better performance of differentiated wireless traffic like Voice-over-IP (VoIP), other types of audio, video, and streaming media as well as traditional IP data over the D-Link Unified Access System.

For detailed information about QoS and how it is used in the D-Link Unified Access System, see Appendix D, “Understanding Quality of Service” on page 203.

Figure 72. QoS Configuration

The screenshot shows the 'QoS' configuration page for an 'Access Point Profile'. It includes tabs for 'Summary', 'Default', 'Global', 'Radio', 'SSID', and 'QoS'. The main content area is titled 'Access Point Profile QoS Configuration' and shows 'AP Profile 1-Default' with radio options for '1-802.11a' (selected) and '2-802.11g'. Below this are two tables: 'AP EDCA Parameters' and 'Station EDCA Parameters'. Both tables have columns for Queue, AIFS, cwMin, cwMax, and Max. Burst (or TXOP Limit). The 'WMM Mode' checkbox is checked.

AP EDCA Parameters				
Queue	AIFS	cwMin	cwMax	Max. Burst
Data 0 (Voice)	1	3 msec	7 msec	1500
Data 1 (Video)	1	7 msec	15 msec	3000
Data 2 (Best Effort)	3	15 msec	63 msec	0
Data 3 (Background)	7	15 msec	1023 msec	0

WMM Mode

Station EDCA Parameters				
Queue	AIFS	cwMin	cwMax	TXOP Limit
Data 0 (Voice)	2	3 msec	7 msec	47
Data 1 (Video)	2	7 msec	15 msec	94
Data 2 (Best Effort)	3	15 msec	63 msec	0
Data 3 (Background)	7	15 msec	1023 msec	0

Refresh Submit

Configuring Quality of Service (QoS) on the D-Link Unified Access System consists of setting parameters on existing queues for different types of wireless traffic, and effectively specifying minimum and maximum wait times (through Contention Windows) for transmission. The settings described here apply to data transmission behavior on the access point only, not to that of the client stations.

AP Enhanced Distributed Channel Access (EDCA) Parameters affect traffic flowing from the access point to the client station. Station Enhanced Distributed Channel Access (EDCA) Parameters affect traffic flowing from the client station to the access point.

NOTE: QoS is configured per radio interface.

Table 55 describes the QoS settings you can configure.

Table 55. QoS Settings

Field	Description
Queue	<p>Queues are defined for different types of data transmitted from AP-to-station:</p> <p>Data 0 (Voice) High priority queue, minimum delay. Time-sensitive data such as VoIP and streaming media are automatically sent to this queue.</p> <p>Data 1 (Video) High priority queue, minimum delay. Time-sensitive video data is automatically sent to this queue.</p> <p>Data 2 (best effort) Medium priority queue, medium throughput and delay. Most traditional IP data is sent to this queue.</p> <p>Data 3 (Background) Lowest priority queue, high throughput. Bulk data that requires maximum throughput and is not time-sensitive is sent to this queue (FTP data, for example).</p>
AIFS (Inter-Frame Space)	<p>The Arbitration Inter-Frame Spacing (AIFS) specifies a wait time (in milliseconds) for data frames.</p> <p>Valid values for AIFS are 1 through 255.</p>
cwMin (Minimum Contention Window)	<p>This parameter is input to the algorithm that determines the initial random backoff wait time ("window") for retry of a transmission.</p> <p>The value specified here in the Minimum Contention Window is the upper limit (in milliseconds) of a range from which the initial random backoff wait time is determined.</p> <p>The first random number generated will be a number between 0 and the number specified here.</p> <p>If the first random backoff wait time expires before the data frame is sent, a retry counter is incremented and the random backoff value (window) is doubled. Doubling will continue until the size of the random backoff value reaches the number defined in the Maximum Contention Window.</p> <p>Valid values for the "cwmin" are 1, 3, 7, 15, 31, 63, 127, 255, 511, or 1024. The value for "cwmin" must be lower than the value for "cymax".</p>
cwMax (Maximum Contention Window)	<p>The value specified here in the Maximum Contention Window is the upper limit (in milliseconds) for the doubling of the random backoff value. This doubling continues until either the data frame is sent or the Maximum Contention Window size is reached.</p> <p>Once the Maximum Contention Window size is reached, retries will continue until a maximum number of retries allowed is reached.</p> <p>Valid values for the "cymax" are 1, 3, 7, 15, 31, 63, 127, 255, 511, or 1024. The value for "cymax" must be higher than the value for "cwmin".</p>

Table 55. QoS Settings

Field	Description
Max. Burst Length	<p>AP EDCA Parameter Only (The Max. Burst Length applies only to traffic flowing from the access point to the client station.)</p> <p>This value specifies (in milliseconds) the Maximum Burst Length allowed for packet bursts on the wireless network. A <i>packet burst</i> is a collection of multiple frames transmitted without header information. The decreased overhead results in higher throughput and better performance.</p> <p>Valid values for maximum burst length are 0.0 through 999.9.</p>
WMM Mode	<p>Wi-Fi MultiMedia (WMM) is enabled by default. With WMM enabled, QoS prioritization and coordination of wireless medium access is on. With WMM enabled, QoS settings on the D-Link Unified Access System control <i>downstream</i> traffic flowing from the access point to client station (AP EDCA parameters) and the <i>upstream</i> traffic flowing from the station to the access point (station EDCA parameters).</p> <p>Disabling WMM deactivates QoS control of station EDCA parameters on <i>upstream</i> traffic flowing from the station to the access point</p> <p>With WMM disabled, you can still set some parameters on the downstream traffic flowing from the access point to the client station (AP EDCA parameters).</p> <p>To disable WMM extensions, click Disabled.</p> <p>To enable WMM extensions, click Enabled.</p>
Queue	<p>Queues are defined for different types of data transmitted from station-to-AP:</p> <p>Data 0 (Voice)</p> <p>Highest priority queue, minimum delay. Time-sensitive data such as VoIP and streaming media are automatically sent to this queue.</p> <p>Data 1 (Video)</p> <p>Highest priority queue, minimum delay. Time-sensitive video data is automatically sent to this queue.</p> <p>Data 2 (best effort)</p> <p>Medium priority queue, medium throughput and delay. Most traditional IP data is sent to this queue.</p> <p>Data 3 (Background)</p> <p>Lowest priority queue, high throughput. Bulk data that requires maximum throughput and is not time-sensitive is sent to this queue (FTP data, for example).</p>
AIFS (Inter-Frame Space)	<p>The Arbitration Inter-Frame Spacing (AIFS) specifies a wait time (in milliseconds) for data frames.</p>

Table 55. QoS Settings

Field	Description
cwMin (Minimum Contention Window)	<p>This parameter is input to the algorithm that determines the initial random backoff wait time ("window") for retry of a transmission.</p> <p>The value specified in the Minimum Contention Window is the upper limit (in milliseconds) of a range from which the initial random backoff wait time is determined.</p> <p>The first random number generated will be a number between 0 and the number specified here.</p> <p>If the first random backoff wait time expires before the data frame is sent, a retry counter is incremented and the random backoff value (window) is doubled. Doubling will continue until the size of the random backoff value reaches the number defined in the Maximum Contention Window.</p>
cwMax (Maximum Contention Window)	<p>The value specified in the Maximum Contention Window is the upper limit (in milliseconds) for the doubling of the random backoff value. This doubling continues until either the data frame is sent or the Maximum Contention Window size is reached.</p> <p>Once the Maximum Contention Window size is reached, retries will continue until a maximum number of retries allowed is reached.</p>
TXOP Limit	<p>Station EDCA Parameter Only (The TXOP Limit applies only to traffic flowing from the client station to the access point.)</p> <p>The Transmission Opportunity (TXOP) is an interval of time when a WME client station has the right to initiate transmissions onto the wireless medium (WM).</p> <p>This value specifies (in milliseconds) the Transmission Opportunity (TXOP) for client stations; that is, the interval of time when a WMM client station has the right to initiate transmissions on the wireless network.</p>

Visualizing the Wireless Network

The WLAN Visualization component is an optional feature that graphically shows information about the wireless network. WLAN Visualization uses a Java applet to display D-Link Unified Switches, D-Link Access Points, other access points, and associated wireless clients. The WLAN Visualization tool can help you visualize where the APs are in relationship to the building.

You can upload one or more custom images to create a background for the graph. Then, you place the WLAN components discovered by the switch on the graph to help provide a realistic representation of your wireless network. From each object on the WLAN Visualization graph, you can access information about the object and links to configuration pages on the Web interface.

This chapter contains the following sections to help you manage the WLAN Visualization component of the D-Link Unified Access System:

- [Importing and Configuring a Background Image](#)
- [Setting Up the Graph Components](#)
- [Understanding the Menu Bar Options](#)
- [Managing the Graph](#)

Figure 73 shows an example of a floor plan with a D-Link Unified Switch that manages two APs. The figure also shows two switches and a rogue AP.

Figure 73. Sample WLAN Visualization

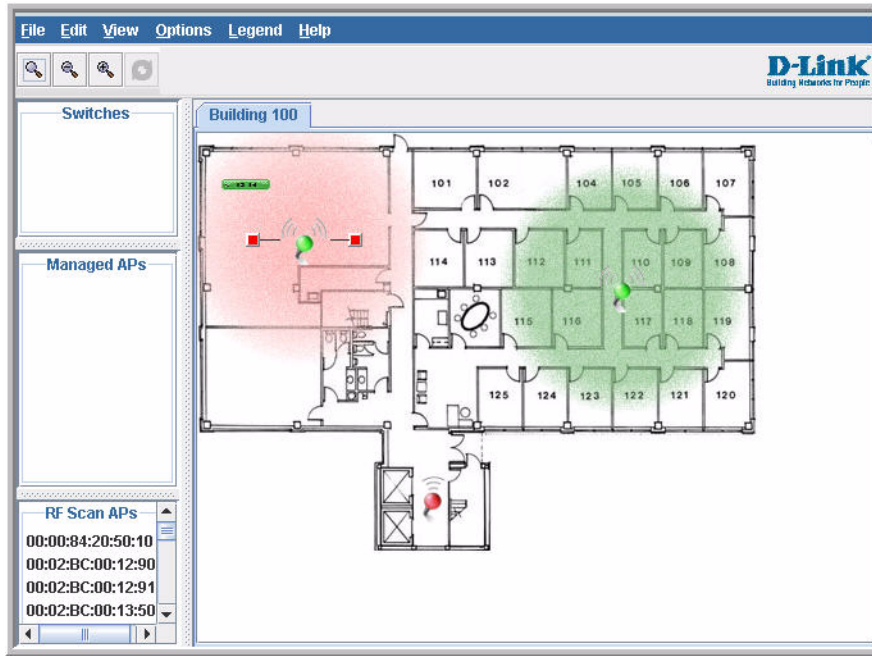

Importing and Configuring a Background Image

By default, the WLAN Visualization graph does not have a background image. You can upload one or more images, such as your office floor plan, to provide a site context and site related information.

Images that you upload should be in one of the following two file formats:

- GIF (Graphics Interchange Format)
- JPG (Joint Photographic Experts Group)

Additionally, we recommend that you do not use color images since the WLAN components might not show up as well.

To load an image onto the switch to use as a background for the WLAN Visualization graph, use the following procedures:

1. Click **WLAN Visualization > Download Image**.
2. Click Browse to navigate to the file location.

3. Select the file to upload and click **Start File Transfer**.



Once you upload an image file and save the running configuration, the image remains on the switch and you can assign it to an existing graph using the WLAN Visualization application.

Setting Up the Graph Components

To start the WLAN Visualization tool, click **WLAN Visualization > Launch...** This opens a new browser window and starts the Java applet.

The first time you launch the WLAN Visualization tool, there is no background image, and all discovered WLAN components are ungraphed. The screen is split into two panes. The left pane has 3 container views that are used to hold un-graphed components. The right pane is an area where graph definitions are shown. This graph pane is initially blank and must be defined before WLAN components can be placed.

Creating a New Graph

To create a new graph and load the background image, launch the WLAN Visualization tool and use the following steps.

1. From the WLAN Visualization menu bar, click **Edit > New Graph**.

The New Graph Definition dialogue box opens.

2. Enter a name to identify the graph and select the image to use as the background.

For information about how to upload an image to use as a graph background, see

“Importing and Configuring a Background Image” on page 162.

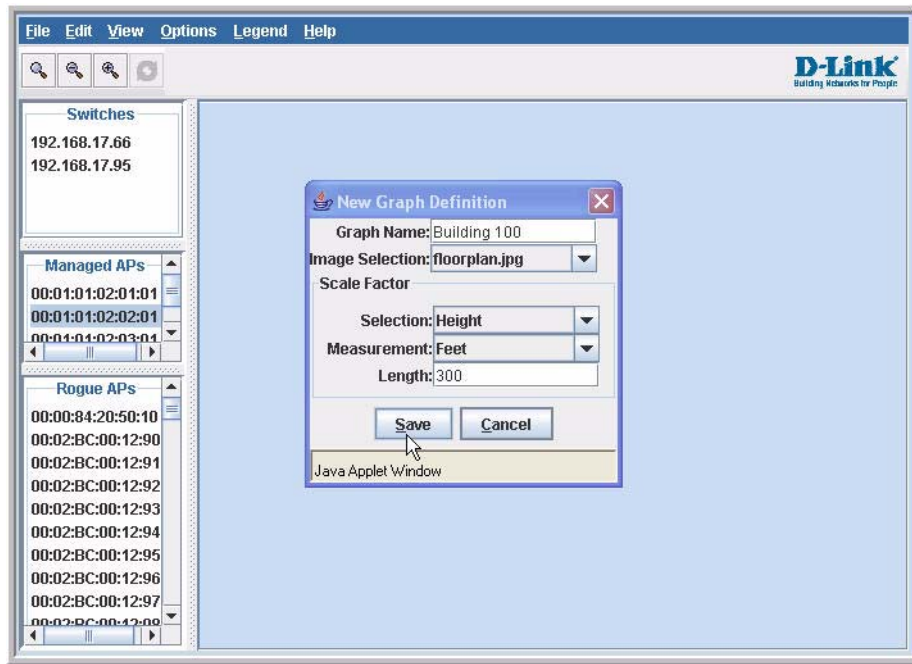

3. Enter the represented length for one of the graph dimensions (height or width).

Use the Selection and Measurement drop-down menus to specify whether the length is the height or width, and whether it is in meters or feet.

The length you enter determines the scale of the background image in relation to the network components. The scale of the background image affects the way the WLAN Visualization tool presents the radio frequency (RF) coverage of the access points, so it is important to be as accurate as possible when you specify the length.

For example, in the following graphs, the background image is the same, and the APs are in the same location in both images. The only difference between the images is that one image was set up with a graph definition length of 200 feet, and the other image was set up

with a graph definition length of 800 feet.

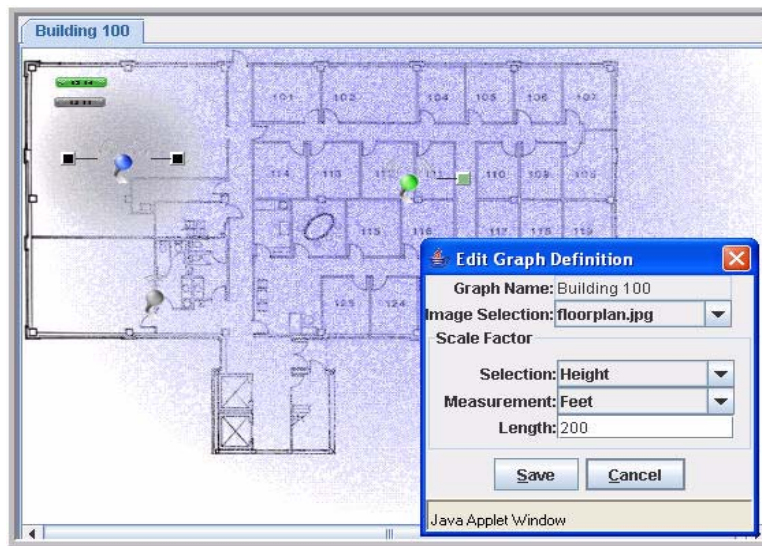

Graph Definition Length = 200'

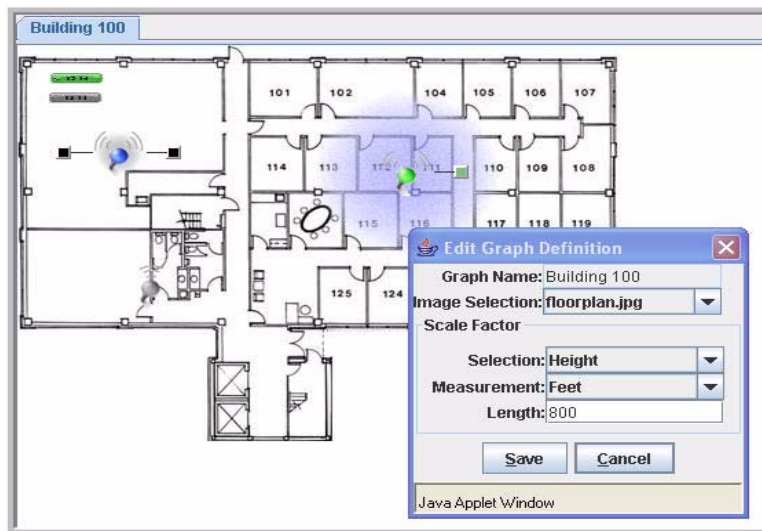

Graph Definition Length = 800'

4. Click **Save** to complete the graph setup.

The background you uploaded to the switch appears in the background of the graph.

You can create multiple graphs. For example, if your network spans multiple floors or buildings, you might have a graph for each area. Additional graphs that you create appear as tabs at the top of the graph panel, as [Figure 74](#) shows.

Figure 74. Multiple Graphs

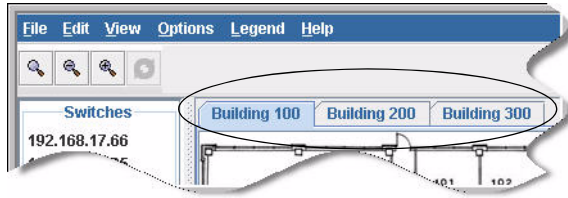

To create additional graphs, repeat the steps in this section.

Graphing the WLAN Components

The WLAN Visualization tool automatically shows the WLAN components that the switch has discovered.

The panel lists the following component types:

- Switches (Unified Switch and peer unified switches)
- Managed Access Points
- RF Scan Access Points

These components appear in the panel on the left until you drag them onto the graph. From the **View** menu, you can choose to view the components in a list view, which shows all three types of components in the left panel or in a tabbed view, which shows one type of component at a time, organized by tabs. [Figure 75](#) shows an example of a list view and a tabbed view of the same components. Access points are listed by location or MAC address, and switches are listed by IP address.

Figure 75. List View and Tabbed View

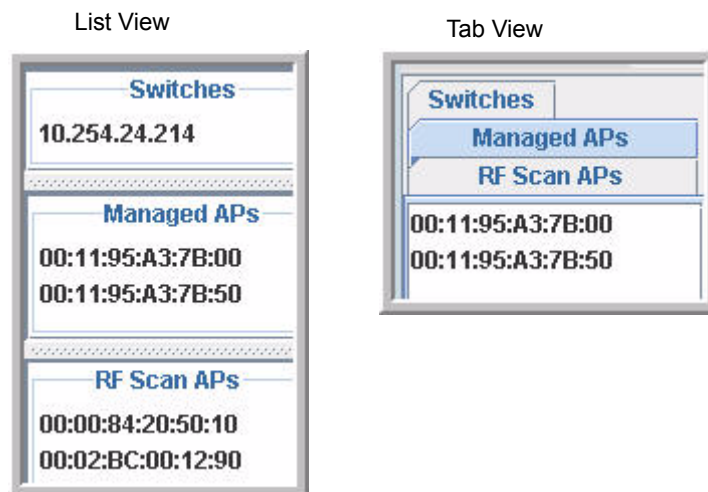

Wireless clients do not appear in the panel. Instead, they are automatically graphed based on their association with (or disassociation from) a D-Link Access Point that is graphed.

If you mouse-over an ungraphed component, a tool tip appears to provide additional information about the ungraphed component, as shown in [Figure 76](#)

Figure 76. Component Tool Tip

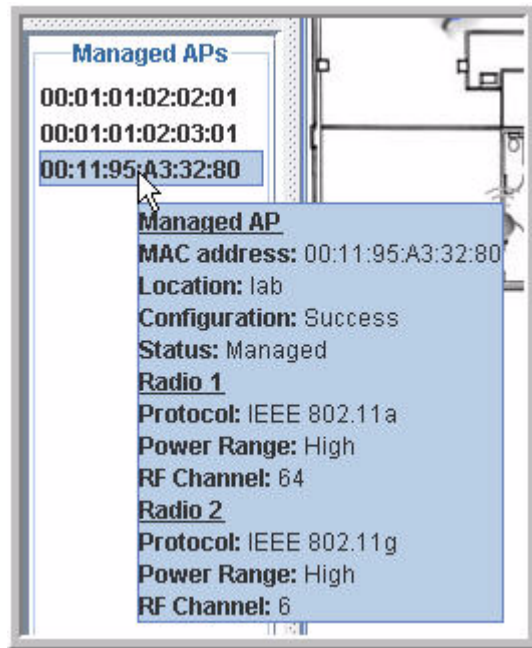

To graph a component that is listed in the panel, click the component and drag it to the location in the graph that represents the physical location of the component in the building. Once you move a switch or access point to the graph area, it is removed from the panel.

Hold the SHIFT or CTRL key to select multiple components, then right-click a selected component to drag the components onto the graph at the same time.

Figure 77. Graphed Components

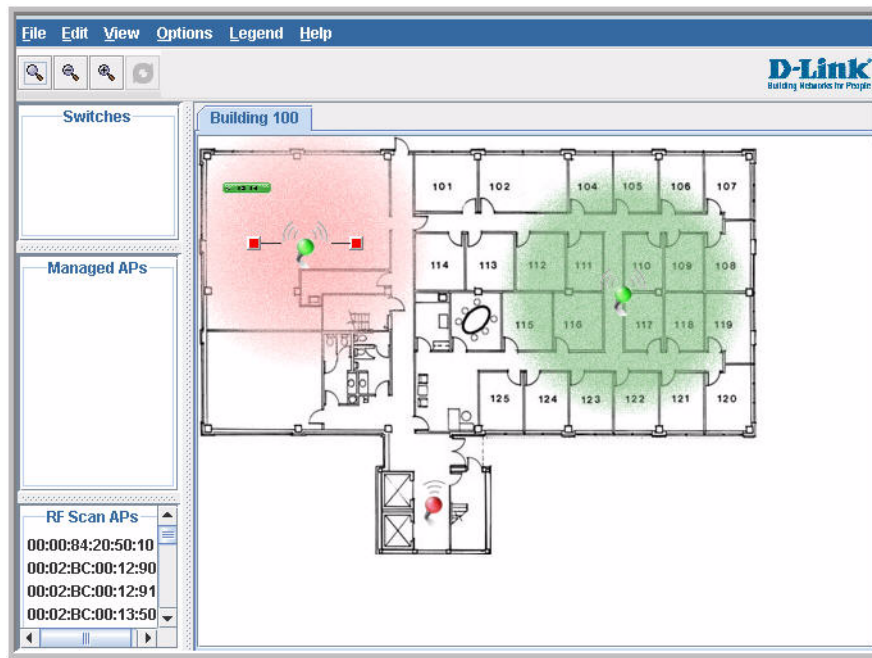

To remove a component from the graph, right-click the component, then select **Edit > Un-Graph**.

Understanding the Menu Bar Options

The following table provides an overview of the menu items available in the WLAN Visualization tool.

Table 56. WLAN Visualization Menu Bar Options

Menu Item	Description
File	
Force Refresh	Resynchronizes the Java client application. If you edit the graph, you can force a refresh to manually update the view.
Reconnect and Refresh	Disconnects the client application from the switch and re-connects it.
Exit	Exits the WLAN Visualization application.
Edit	
New Graph	Opens a window that allows you to create and configure a new graph, including the name, background image, and scale factor for the graph.

Table 56. WLAN Visualization Menu Bar Options

Menu Item	Description
Edit Graph	Opens the window for an existing graph. You can change the background image or graph scale. To change the name of the graph, you must create a new graph.
Delete Graph	Deletes the active graph. When you select this item, a dialogue box appears to confirm that you want to delete the graph.
Image Management	Lists the available background images and allows you to delete any available image.
View	
Ungraphed Components	<p>Allows you to change the view of the ungraphed components in the panel on the left:</p> <ul style="list-style-type: none"> • Tab View—Shows one type of component at a time, organized by tabs. • List View—Shows all three types of components in the left panel. <p>Figure 75 on page 166 shows the difference between the tab view and list view.</p>
AP Power Display	<p>Select the power range image to display for a managed AP:</p> <ul style="list-style-type: none"> • Disable Power Display—The power range image is not displayed • Show 802.11 a—Shows the transmit power for all managed APs that have a radio operating in 802.11a mode. • Show 802.11 b/g—Shows the transmit power for all managed APs that have a radio operating in 802.11 b/g mode. <p>The size of the power range image is based on the transmit power for the radio, which can be low, medium, or high. The size of the power range image also depends on the actual scale factor of the current background image.</p> <p>If the AP has two radios that are configured in the same mode, two power range images are displayed.</p> <p>NOTE: The color of the power range image is based on the assigned channel of the associated radio.</p> <p>If two APs use the same channel (or channels that are close together) and are within each other's transmission range, the APs will interfere with each other and wireless clients will experience poor WLAN performance. To reduce interference, you can take one of the following steps:</p> <ul style="list-style-type: none"> • Reduce the transmit power on the APs. • Physically place the APs further apart. • Use the automatic channel adjustment algorithm on the APs or statically set the channels so they are non-interfering channels. <p>CAUTION: Power ranges are for illustrative purposes only. The actual power distribution varies based on factors such as office wall propagation and background RF noise.</p>

Table 56. WLAN Visualization Menu Bar Options

Menu Item	Description
Options	
Show Managed APs	Controls whether to display D-Link Access Point on the graph. Clearing the check box hides but does not un-graph the objects.
Show RF Scan APs	Controls whether to display the APs detected through the RF scan. Clearing the check box hides but does not un-graph the objects.
Show Managed AP Clients	Controls whether to display wireless clients associated with managed APs. Clearing the check box hides but does not un-graph the objects.
Legend	
Images	Shows the icons associated with each WLAN component on the graph.
Channel Color	Maps the color of the power transmission image to the channel that the radio is using for transmission.
Help	
Table of Contents	Opens a new HTML window to display the table of contents for the WLAN online Help.

Legend Menu

The items in the **Legend** menu contain information about the icons and colors that appear on the graph.

The **Images** menu item shows the icons that represent the WLAN components on the graph.

Figure 78. Legend

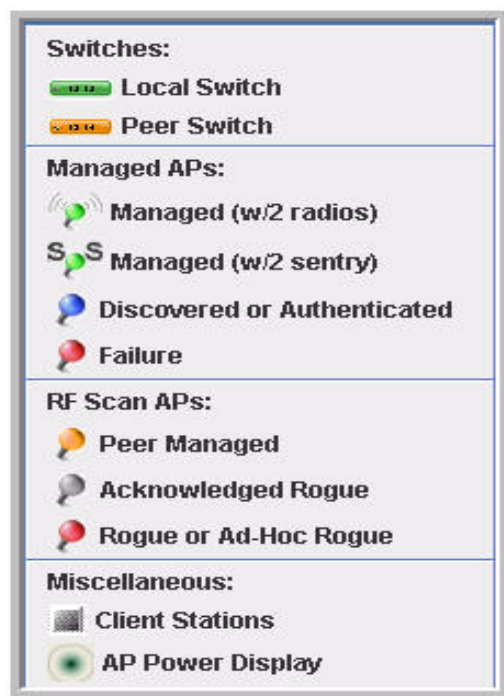

As the legend shows, the Managed AP icon can be blue, green, or red, depending on the status of the AP:

- Blue—The AP has been discovered and by the switch, but it is in a transitional state. The AP could be waiting to be authenticated, or it has been validated and authenticated but not configured.
- Green—The AP profile configuration has been applied to the AP, and it is operating in managed mode.
- Red—The switch has lost contact with the AP, the AP is being reset, or the AP has experienced an authentication failure.

When a radio is operating in Sentry Mode, the antenna on the AP icon is replaced by the letter “S” as [Figure 79](#) shows.

Figure 79. Sentry Mode - Detailed View

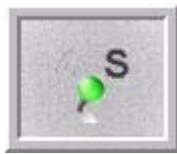

For radios in sentry mode, the AP power display image around the AP is gray.

The Channel Color legend maps the color of the power display image to the channel that the image color represents. The color corresponds to the channel that the radio is using for transmission. The available channels depend on the mode and country of operation.

Figure 80. Channel Colors

1	2	3	4
5	6	7	8
9	10	11	14
36	40	42	44
48	50	52	56
58	60	64	100
149	152	153	157
160	161	165	

To view the channel that a radio is using, you can mouse-over the managed AP to activate the tool tip. The tool tip displays general information about the AP, including the channel that each radio uses.

Figure 81. Tool Tip for Radio Managed AP Information

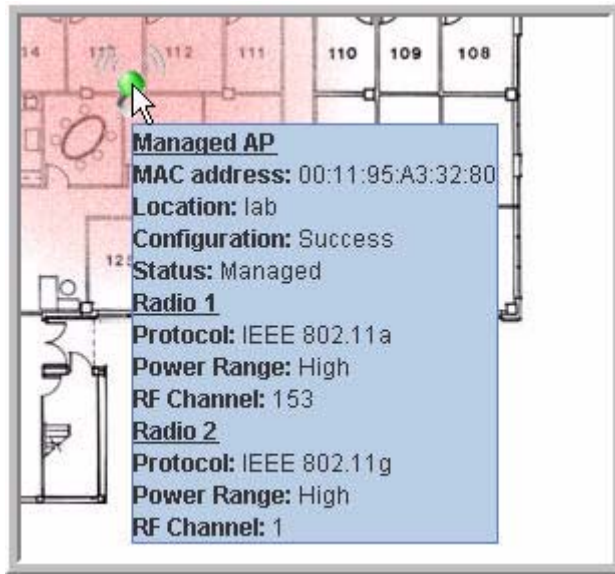

You can also right-click the object to access a variety of information, which the next section describes.

Managing the Graph

After you place a component on the graph, you can right-click the component to learn more information about it, un-graph it, or link to a page on the Web UI to manage or monitor the component.

Figure 82. Wireless Component Attributes

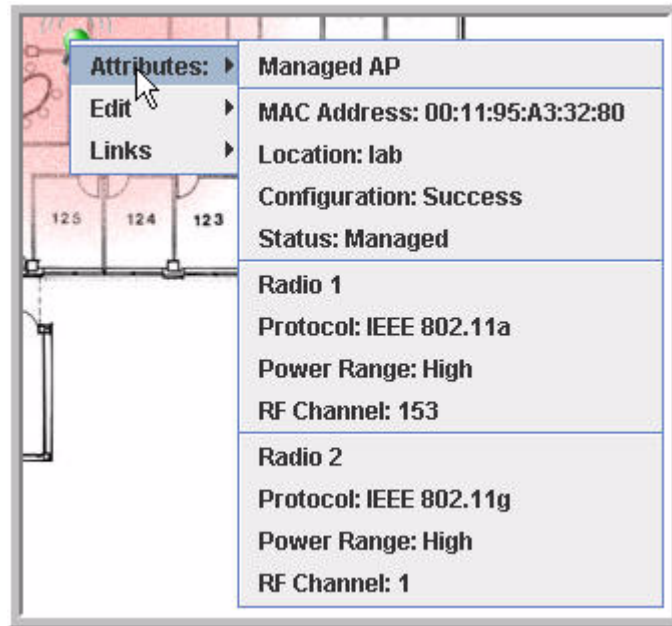

Table 57 lists the attribute and link information available from each component.

Table 57. Component Information

Component	Attributes	Links/Commands
Switch	IP Address	Basic Setup RF Management Global Status/Statistics
Peer Switch	IP Address	Peer Switch Status

Table 57. Component Information

Component	Attributes	Links/Commands
Managed AP	MAC Address Location Configuration Status—Managed Radio—1 or 2 Protocol—802.11b/g or 802.11a Power Range—Low, Medium, or High RF Channel—Depends on channel plan Sentry Mode (if enabled)	Configuration <ul style="list-style-type: none"> • AP Profile Configuration • Valid AP Configuration Management <ul style="list-style-type: none"> • Radio • Software Download • Debug Status and Statistics <ul style="list-style-type: none"> • Managed AP Status Detail • Radio Status and Statistics Command: AP Reset
Other AP	MAC Address Status—Rogue, Peer Managed, or Acknowledged AP RF Channel	Status Commands: <ul style="list-style-type: none"> • Manage • Acknowledge
Wireless Client	MAC Address Radio—1 or 2 RF Channel—Depends on channel plan	Associated Client Status Detail Command: Disassociate

D-Link Unified Access System Default Settings

This chapter identifies the default values for the D-Link Unified Switch, the default D-Link Access Point settings, and the default AP Profile setting that the switch assigns to the AP after it is discovered and authenticated (when the AP uses the default profile).

Default D-Link Unified Switch Settings

[Table 58](#) shows the default settings for the D-Link Unified Switch.

Table 58. Switch Defaults

Feature	Default
System Information	
User Name	admin
Password	None
Network Information	
DHCP Client	Disabled
Network Configuration Protocol	None
IP Address	10.90.90.90
Subnet Mask	255.0.0.0
802.1Q	Enabled
Management VLAN ID	1
Untagged VLAN ID	1
Spanning Tree Protocol	Enabled

Table 58. Switch Defaults

Feature	Default
WLAN Information	
Unified Switch Mode	Enabled
AP Authentication	Disabled
AP Validation	Local
Country Code	US
Default Profile Name	Default
Peer Switch Group ID	1
L2 (VLAN) /L3 (IP) Discovery	Enabled
SNMP Traps	Disabled
Client Roam Timeout	30 seconds
Ad Hoc Client Status	24 hours
AP Failure Status	24 hours
Client Failure Status	24 hours
RF Scan Status	24 hours

Default D-Link Access Point Settings

[Table 60](#) shows the default D-Link Access Point settings.

Table 59. AP Default AP Settings

Feature	Default
System Information	
User Name	admin
Password	admin
Network Information	
DHCP Client	Enabled
Management IP Address	10.90.90.91 (If not assigned by DHCP)
Subnet Mask	255.0.0.0 (If not assigned by DHCP)
Management VLAN	1
Untagged VLAN	1

Default D-Link Access Point Profile Settings

Table 60 shows the AP settings for the default profile. By default, when a D-Link Access Point associates with the switch, the settings in this table are assigned to the AP upon successful AP validation.

Table 60. AP Default AP Profile Settings

Feature	Default
Radio Settings	
Radio (1 and 2)	On
Radio 1 IEEE 802.11 Mode	802.11a
	NOTE: If the AP operates in a regulatory domain where 802.11a is not supported, the radio is disabled and no mode is configured.
Radio 2 IEEE 802.11 Mode	802.11b/g
RF Scan Other Channels	Enabled
RF Scan Interval	60 seconds
RF Scan Duration	10 milliseconds
Super A/G	Disabled
Extended Range	Disabled
Automatic Channel	Enabled
Automatic Power	Enabled
Initial Power	100
Load Balancing	Disabled
Load Utilization	60%
Maximum Clients	256
RTS Threshold	2347 bytes
DTIM Period	10 beacons
Fragmentation Threshold	2346 bytes
Beacon Period	100 milliseconds
Rate Sets Supported (Mbps)	IEEE 802.1a: 54, 48, 36, 24, 18, 12, 9, 6 IEEE 802.1g: 54, 48, 36, 24, 18, 12, 11, 9, 6, 5.5, 2, 1 IEEE 802.1b: 11, 5.5, 2, 1 Atheros Dynamic Turbo 5 GHz: 108, 96, 72, 48, 36, 24, 18, 12
Rate Sets (Mbps) (Basic/Advertised)	IEEE 802.1a: 24, 12, 6 IEEE 802.1g: 11, 5.5, 2, 1 IEEE 802.1b: 2, 1 Atheros Dynamic Turbo 5 GHz: 48, 24, 12

Table 60. AP Default AP Profile Settings

Feature	Default
Virtual Access Point and Network Settings	
Status	VAP0 is enabled on both radios, all other VAPs disabled
Network Name (SSID)	Guest Network (VAP0)
VLAN	1
Hide SSID	Disabled
L3 Tunnel	Disabled
Security Mode	Open System
MAC Authentication	Disabled
RADIUS IP Address	Use Profile (Global)
RADIUS Accounting	Disabled
Other Settings	
QoS	Enabled
WMM	Enabled

Configuring the External RADIUS Server

You can store the Valid AP configuration on a local database on the D-Link Unified Switch or on an external RADIUS server. This appendix describes the attributes you must define for each feature to setup their configuration on the RADIUS server.

One important reason why you might define the AP information on the RADIUS server rather than on the switch is to allow peer switches to obtain the data from a single source rather than having to define it on each switch.

Configuring RADIUS Settings for Access Points

Since the AP is identified by its physical MAC address, you must add a RADIUS entry for each AP with the User-Name attribute set to the MAC address. [Table 61](#) indicates the attributes to configure in the RADIUS server entry for each AP. Add the vendor-specific attributes by using the D-Link vendor ID (6132) and the identifier D-Link-Wireless-AP-* (where "*" represents the attribute name).

NOTE: This appendix does not describe RADIUS configuration for AP network authentication using 802.1x. This feature is separate from a valid AP configuration entry. The edge device that connects to the AP performs the network authentication. The edge device might not be the D-Link Unified Switch.

Table 61. RADIUS Attributes for the Access Point

RADIUS Server Attribute	Description	Range	Usage
User-Name (1)	Ethernet Address of the AP.	Valid Ethernet MAC Address	Required
User-Password (2)	A fixed password used to lookup an AP entry.	8-63 characters, default NOPASSWORD	Required
Vendor-Specific (26) Location	A description for the AP, often based on its location.	1-32 characters	Optional

Table 61. RADIUS Attributes for the Access Point

RADIUS Server Attribute	Description	Range	Usage
Vendor-Specific (26) Mode	Indicates whether this AP is managed by the switch, by an administrator, or is a rogue AP.	WS Managed (1) Acknowledged Rogue (3)	Required
Vendor-Specific (26) Profile-ID	If AP is managed by a switch, the ID of the configuration profile for this AP.	1-16	Required if mode is WS managed.
Vendor-Specific (26) Switch-IP	If there is more than one switch using this RADIUS server, indicates the IP address of the switch to manage this AP.	Valid IP Address	Optional
Vendor-Specific (26) Radio-1-Chan Vendor-Specific (26) Radio-2-Chan	Indicates a fixed channel for the radio.	Valid channels depend on the regulatory domain (country-code) and the configured mode for that radio in the assigned AP profile. If the channel is not valid, its ignored. 0 indicates automatic channel assignment.	Optional, if defined and valid will override auto channel configuration
Vendor-Specific (26) Radio-1-Power	Indicates a fixed power setting for the radio.	0, 1-100 percent 0 indicates automatic power assignment.	Optional, if defined and valid will override auto power configuration
Vendor-Specific (26) Radio-2-Power	Indicates a fixed power setting for the radio.	0, 1-100 percent 0 indicates automatic power assignment.	Optional, if defined and valid will override auto power configuration

When you do not require authentication between the APs and the RADIUS server, the switch uses the password “NOPASSWORD” in communications between the RADIUS client on the switch and the RADIUS server. The RADIUS client on the switch uses this password when it retrieves entries from the server. When you do require AP authentication, the password for AP authentication to the unified switch (separate from and in addition to AP authentication to the network) will be in this field.

FreeRADIUS Server Configuration Example

FreeRADIUS is an open source RADIUS server that you can download free from <http://www.freeradius.org>. The example in this section describes the files you need to configure in order to authenticate the D-Link Unified Switch and the D-Link Access Point with the RADIUS server and to configure the Valid AP settings in the RADIUS database.

Configuring RADIUS Clients

If you require the D-Link Unified Switch or D-Link Access Points to authenticate themselves with the RADIUS server, you must configure client entries for the devices in the RADIUS server's `etc/raddb/clients.conf` file.

The entry contains the IP address of the client, the shared secret, and a nickname (or DNS name) for the device.

The following entry in the `clients.conf` file is for a switch with the following information:

- IP address: 192.168.30.249
- Subnet mask: 255.255.255.0
- Shared secret: wireless
- DNS name: wireless-sw1

The following code shows the format of the client entry in the `clients.conf` file:

```
client 192.168.30.249/24 {
    secret      = wireless
    shortname   = wireless-sw1
}
```

Creating and Including an Attribute Dictionary

You configure attributes in an attribute dictionary so that you can assign the attributes and values to an access point when you configure it in the Valid AP database on the RADIUS server. For example, to assign a location to an access point, the attribute you define has the following format:

```
ATTRIBUTE      D-Link-Wireless-AP-Location      101      string D-Link
```

The fields in the attribute are as follows:

- Attribute—type of entry
- D-Link-Wireless-AP-Location—name of the attribute
- 101—ID number assigned to the attribute; you must use this number when you configure the location attribute
- string—type of data for the attribute
- D-Link—vendor-specific name for the attribute

The following VALUE field defines one of the of values you can assign to an AP for the AP Mode.

```
VALUE D-Link-Wireless-AP-Mode      WS-Managed      1
```

The VALUE fields are as follows:

- VALUE—type of entry

- D-Link-Wireless-AP-Mode—name of the attribute
- WS-Managed—value for the attribute
- 1—name-to-number mapping for the attribute

The following code is an example of the D-Link attribute dictionary. The code shows the complete file. You can create your own dictionary and configure the attributes and values that your WLAN requires. The `VENDOR` field has the vendor-specific attribute name-to-number mapping.

After you create the file, save the dictionary in the `etc/raddb` directory with a file name `dictionary.<company>`, for example, `dictionary.D-Link`.

```
VENDOR      D-Link      6132
#
#      D-Link Vendor Specific Extensions
#
#
ATTRIBUTE   D-Link-Wireless-AP-Location      101      string   D-Link
ATTRIBUTE   D-Link-Wireless-AP-Mode          102      integer  D-Link
ATTRIBUTE   D-Link-Wireless-AP-Profile-ID    103      integer  D-Link
ATTRIBUTE   D-Link-Wireless-AP-Switch-IP     104      ipaddr   D-Link
ATTRIBUTE   D-Link-Wireless-AP-Radio-1-Chan  105      integer  D-Link
ATTRIBUTE   D-Link-Wireless-AP-Radio-2-Chan  106      integer  D-Link
ATTRIBUTE   D-Link-Wireless-AP-Radio-1-Power 107      integer  D-Link
ATTRIBUTE   D-Link-Wireless-AP-Radio-2-Power 108      integer  D-Link

VALUE D-Link-Wireless-AP-Mode      WS-Managed      1
VALUE D-Link-Wireless-AP-Mode      Rogue             3

VALUE D-Link-Wireless-AP-Radio-1-Chan  Auto             0
VALUE D-Link-Wireless-AP-Radio-2-Chan  Auto             0

VALUE D-Link-Wireless-AP-Radio-1-Power  Auto             0
VALUE D-Link-Wireless-AP-Radio-1-Power  Minimum          1
VALUE D-Link-Wireless-AP-Radio-1-Power  Maximum          100

VALUE D-Link-Wireless-AP-Radio-2-Power  Auto             0
VALUE D-Link-Wireless-AP-Radio-2-Power  Minimum          1
VALUE D-Link-Wireless-AP-Radio-2-Power  Maximum          100
```

After you create an attribute dictionary file, you must insert an `INCLUDE` statement into the main file dictionary for the FreeRADIUS server.

The main dictionary is `etc/raddb/dictionary`. The following example shows an `INCLUDE` statement for the D-Link attribute dictionary called `dictionary.D-Link`.

```
$INCLUDE dictionary.D-Link
```

Adding Access Points to the Valid AP Database

You use the attributes you define in the dictionary file to configure the settings for an access point in the Valid AP database on the RADIUS server. The file you configure is the `etc/raddb/users` file. The following code is an example of a database entry for an AP with the MAC address 00:11:95:a3:32:80.

NOTE: In the FreeRADIUS database, the MAC address is case sensitive, and the octets must be separated by hyphens.

```
00-11-95-a3-32-80      Auth-Type := Local, User-Password=="NOPASSWORD"
                        D-Link-Wireless-AP-Mode = WS-Managed,
                        D-Link-Wireless-AP-Location = "Lobby AP",
                        D-Link-Wireless-AP-Profile-ID = 1,
                        D-Link-Wireless-AP-Switch-IP = 192.168.30.4,
                        D-Link-Wireless-AP-Radio-1-Chan = Auto,
                        D-Link-Wireless-AP-Radio-2-Chan = Auto,
                        D-Link-Wireless-AP-Radio-1-Power = Auto,
                        D-Link-Wireless-AP-Radio-2-Power = Auto
```

Configuring RADIUS Settings for Wireless Clients

You can configure D-Link Access Points to use 802.1x authentication on the RADIUS server to allow or deny specific users on client stations access to the wireless network. If you enable 802.1x authentication, the client entry on a RADIUS server can support user-based VLANs and subnet assignments for IP tunneling. [Table 62](#) shows the attributes to set for wireless clients within the RADIUS server.

Table 62. RADIUS Attributes for Wireless Clients

RADIUS Server Attribute	Description	Range	Usage
User-Name (1)		1-32 characters	Required
User-Password (2)		1-128 characters	Required
Tunnel-Medium-Type (65)		802	Optional

Configuring RADIUS for Client MAC Authentication

You can configure the AP to use RADIUS-based MAC authentication to allow or deny specific client stations access to the wireless network. Although this method is less secure than 802.1x, you can use it for client stations that do not support 802.1x.

The addresses you enter are either allowed or denied based on the global default action within the AP profile.

[Table 63](#) indicates the attributes that you configure in the RADIUS server entry.

Table 63. RADIUS Attributes for Wireless Client MAC Authentication

RADIUS Server Attribute	Description	Range	Usage
User-Name (1)	Ethernet Address of the client station.	Valid Ethernet MAC Address.	Required
User-Password (2)	A fixed password used to lookup a client MAC entry.	NOPASSWORD	Required

FreeRADIUS Example for Wireless Client Configuration

You can use an external RADIUS server, such as a server running FreeRADIUS, to authenticate users who attempt to connect to an access point. The authentication is based on the username and password, and not the wireless client used for access. The RADIUS server can also assign the user to a VLAN after he or she is authenticated by the server.

In addition to user-based authentication, you can configure MAC-based authentication to allow or deny wireless clients access to the AP based on the MAC address of the client.

Configuring User-Based Authentication and Dynamic VLANs

You can configure an entry in the external RADIUS server to pass a users credentials to the access point and to dynamically assign the user to a VLAN.

Dynamic VLANs allow you to assign a user to a VLAN, and switches dynamically use this information to configure the port on the switch automatically. Selection of the VLAN is usually based on the identity of the user. The RADIUS server informs the access point of the selected VLAN as part of the authentication. This setup enables users of Dynamic VLANs to move from one location to another without intervention and without having to make any changes to the switches.

If you use an external RADIUS server to manage VLANs, you configure the server to use Tunnel attributes in Access-Accept messages in order to inform the access point about the selected VLAN. These attributes are defined in RFC 2868 and their use for dynamic VLAN is specified in RFC 3580.

The VLAN attributes defined in RFC3580 are as follows:

- Tunnel-Type=VLAN (13)
- Tunnel-Medium-Type=802
- Tunnel-Private-Group-ID=VLANID

NOTE: The FreeRADIUS dictionary maps the 802 string value to the integer 6, which is why client entries use 6 for the Tunnel-Medium-Type value.

To create a user and assign the user to a particular VLAN by using FreeRADIUS, open the `etc/raddb/users` file, which contains the user account information, and add for the new user.

The following example shows the entry for a user in the `users` file. The username is "johndoe," the password is "test1234." The user is assigned to VLAN 77.

```
johndoe Auth-Type: = EAP, User-Password == "test1234"  
      Tunnel-Type = 13,  
      Tunnel-Medium-Type = 6,  
      Tunnel-Private-Group-ID = 77
```

Tunnel-Type and Tunnel-Medium-Type use the same values for all stations. Tunnel-Private-Group-ID is the selected VLAN ID and can be different for each user.

NOTE: Do not use the management VLAN ID of the AP for the value of the Tunnel-Private-Group-ID.

The dynamically-assigned RADIUS VLAN cannot be the same as the AP's management VLAN. If the RADIUS server attempts to assign a dynamic VLAN to a client that associates with an AP with that VLAN as the management VLAN, the AP ignores the dynamic VLAN assignment and a newly associated client is assigned to the default VLAN for that VAP. A re-authenticating client retains its previous VLAN ID.

The default management VLAN ID for all APs is 1. The only way to change an AP's management VLAN ID is by using the `set management vlan-id` command from the CLI.

After you change the `etc/raddb/users` file, you must restart the RADIUS server daemon to apply the changes.

Configuring MAC Authentication

For each network, you can configure whether to use a local or RADIUS database for client MAC authentication. To use RADIUS-based MAC authentication for wireless clients, you add an entry for each client in the `etc/raddb/users` file. If the default action for MAC Authentication on the switch is set to "Allow," only clients that have an entry in the `users` file are allowed access to the network through the AP. If the default action is set to "deny" the clients with a MAC address in the `users` file cannot authenticate with the AP.

The following line is an example of an entry for a client in the `etc/raddb/users` file.

```
00-0F-FE-1C-F2-67 Auth-Type: = Local, User-Password == "NOPASSWORD"
```

NOTE: The password is always NOPASSWORD, and the MAC address of the client uses hyphens, not colons.

L3 Roaming Example

The example in this appendix describes how to configure a D-Link Unified Switch for a network that needs L3 roaming capabilities. This example contains information about the following features, which might be required to use L3 tunneling on your WLAN:

- [Configuring the WLAN and Tunnel Interfaces](#)
- [Configuring the L3 Tunnel Network](#)
- [Configuring DHCP Relay and the DHCP Server](#)
- [Setting the MTU Size](#)

Configuring the WLAN and Tunnel Interfaces

The following figure shows an example of a network that uses L3 tunnels to support wireless roaming. The subnet that all clients will use for L3 roaming is 192.168.60.0/24. The configuration examples in the rest of this appendix use the network information in this figure.

Figure 83. Example of a Network with L3 Tunnel Subnet

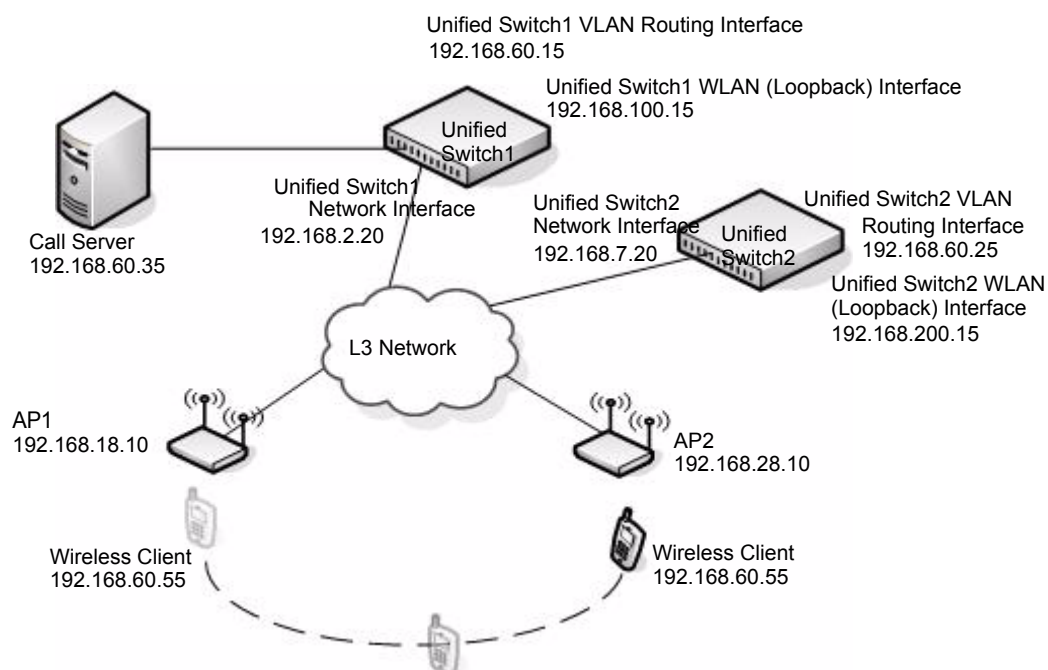

The network in the example has the following characteristics:

- The VLAN Routing interface on each switch, call server, and roaming wireless client are all on the L3 tunnel subnet.
- Peer unified switches have logical interfaces on the same L3 tunnel subnet in order for clients to roam among APs managed by all peer unified switches on the network.
- Peer unified switches are not on the same physical subnet.
- The APs are not in the same subnet as the switches or as the L3 tunnel subnet.
- The call server is physically connected to a Unified Switch, and the port the call server uses is assigned to the VLAN ID of the VLAN Routing interface of the tunneled subnet.
- Each switch uses a loopback interface for the WLAN functions, and the loopback interface is on a different network than the L3 tunnel subnet.
- Routing is enabled on each switch.
- Network devices have routes to the loopback and L3 tunnel subnets, and a host can ping the loopback interface and L3 tunnel interface on each switch.
- DHCP relay is enabled on each switch so that a DHCP server on the network can assign IP addresses to the wireless clients.
- The wireless client receives an IP address in the L3 tunnel subnet and keeps that IP address throughout the roaming session.

CAUTION: APs, peer unified switches, and other routers must not be connected to the tunneled routing interface.

Some phone system require placement of a call server on the same subnet as the phones. The D-Link tunneling feature supports this configuration.

There are a few things to consider when planning a network with L3 roaming capabilities:

- Packets that use the L3 tunnel have an extra 20 bytes in the header for encapsulation.
- To support these larger frames, you can increase the MTU size on all intermediate ports and unified switch ports.
- If you use tunneling only for IP telephony, or if you set the MTU size on all wireless clients that use tunneling to 1480, you do not need to increase the MTU size in the network.
- For traffic in the L3 tunnel, the switch forwards IPv4 unicast frames in hardware; other types of traffic, such as multicast and non-IP traffic, are forwarded in software.
 - Multicast and non-IP traffic on the L3 tunneling network could cause network congestion.
 - Wireless tunneling does not work if IPv6 or multicast traffic is enabled on the L3 tunnel interface.
- All devices that use the L3 tunnel network are stored in the ARP cache because the wireless subnet is local to the switch, which means the ARP cache can fill up faster than expected.
- When tunneled clients are used in conjunction with peer switches, one of the peer switches must be configured as a default gateway for the tunneled clients. Normally the default gateway routes all traffic from the client's subnet to other subnets, however in a peer switch network the unified switch that manages the AP to which the client is associated routes the frames into the remote subnets. This means that each peer switch must have routing table entries that enable it to route frames to every subnet in the network.

Using a Loopback Interface for the Wireless Functions

By creating a loopback interface, you can control which routing interface the wireless function uses for its IP address when multiple routing interfaces exist. With the loopback interface, the IP address of the wireless function is always the same.

NOTE: In this context, the loopback interface does not refer to the loopback interface with the 127.0.0.1 IP address. When you configure a loopback interface for the wireless interface on the switch, it is essentially a permanent logical interface and cannot have an IP address of 127.0.0.1. You must create a dedicated subnet for the loopback interface, and other devices on the network must be able to contact the IP address of the loopback interface.

You must create static routes so other devices can find the loopback interface.

The advantage of defining a loopback interface is that the interface never goes down. The disadvantage is that network configuration is more complex because the loopback interface is located on its own subnet and the rest of the network must know how to get to the subnet.

The network must have routes between the Unified Switch and the APs to manage. The APs must be able to ping the IP address of the loopback interface used as the WLAN interface on the Unified Switch.

The following procedures show an example of how to enable routing and configure an IP address on a loopback or routing interface.

1. Log on to the CLI and switch to Global Config mode:

```
(System-Prompt)
User: admin
Password:
(System-Prompt) >enable
Password:
(System-Prompt) #config
(System-Prompt) (Config)#
```

2. Enable routing.

```
(System-Prompt) (Config)#ip routing
```

3. Change to Interface Config mode for loopback interface 0, and assign an IP address and subnet mask.

```
(System-Prompt) (Config)#interface loopback 0
(System-Prompt) (Interface loopback 0)#ip address 192.168.100.15 255.255.255.255
```

You can also use the Web interface or SNMP to enable routing and configure an IP address. The following example shows the procedures to enable routing and configure an IP address on the switch by using the Web interface.

1. Log on to the Web interface and click **Routing > IP > Configuration** to access the **IP Configuration** page.
2. From the **Routing Mode** drop-down menu, choose **Enable**, and then click **Submit**.
3. To create a loopback interface, click **Routing > Loopback > Configuration**.
4. From the Loopback drop-down menu, choose **Create**, and then click **Submit**.

5. Enter an IPv4 address and subnet mask in the appropriate fields, and then click **Submit**.

Creating the VLAN Routing Interface

The D-Link Unified Switch and the D-Link Access Point support Virtual LANs (VLANs) to provide the logical separation of a physical network. You can use VLANs to segment the wireless network on a per-VAP basis. VLAN routing interfaces allow VLANs to span across different subnets, which is useful for L3 Tunneling.

In [Figure 83](#), Unified Switch1 and Unified Switch2 have a VLAN routing interface on the L3 Tunnel subnet. The following commands show how to configure the interface for Unified Switch1, which has a VLAN Routing interface with VLAN ID 200 and an IP address of 192.168.60.15.

1. Enter VLAN config mode, create a VLAN, and give it a name.

```
(switch-prompt) #vlan database
(switch-prompt) (Vlan)#vlan 200
(switch-prompt) (Vlan)#vlan name 200 "L3 Tunnel"
```

2. Create a VLAN routing interface on VLAN 200.

```
(switch-prompt) (Vlan)#vlan routing 200
```

3. Exit to Privileged EXEC mode and view the VLAN routing interface configuration.

```
(switch-prompt) (Vlan)#exit
(switch-prompt) #show ip vlan
```

MAC Address used by Routing VLANs: 00:00:00:01:00:02

VLAN ID	Logical Interface	IP Address	Subnet Mask
200	0/4/1	0.0.0.0	0.0.0.0

The new VLAN routing interface is 0/4/1 in unit/slot/port format. For non-stacking platforms, the interface would be 4/1.

4. Enter the interface configuration mode for the new VLAN routing interface.

```
(switch-prompt) #configure
(switch-prompt) (Config)#interface 0/4/1
```

5. Assign an IP address to the interface and enable routing.

```
(switch-prompt) (Interface 0/4/1)#ip address 192.168.60.15 255.255.255.0
(switch-prompt) (Interface 0/4/1)#routing
```

6. Add the port to which the call server is attached to VLAN 200 (in this example, the call server is attached to port 3).

```
(switch-prompt) (Config)#interface 1/0/3
(switch-prompt) (Interface 1/0/3)#vlan participation include 200
```

To perform the same steps by using the Web interface, use the following procedures:

1. From the **L2 Features > VLAN > Configuration** page, create a VLAN, give it a name, and add the port to which the call server is attached to VLAN 200 (in this example, the call server is attached to port 3).

Slot/Port	Status	Participation	Tagging
All			
0/1			Autodetect Untagged
0/2			Autodetect Untagged
0/3			Include Untagged

2. From the **L3 Features > VLAN Routing Configuration** page, create a VLAN routing interface on VLAN 200.

Field	Value
VLAN ID	200 (1 to 3965)
Slot/Port	4/1
MAC Address	00:50:ba:22:22:)
IP Address	0.0.0.0
Subnet Mask	0.0.0.0

Buttons: Create, Delete

- From the **L3 Features > IP > Interface Configuration** page, assign an IP address and subnet mask to the interface, and make sure routing is enabled.



- From the **Monitoring > L3 Status > VLAN Routing Summary** page, view the summary information for the VLAN routing interface.

VLAN Routing Summary				
VLAN ID	Slot/Port	MAC Address	IP Address	Subnet Mask
200	4/1	00:50:BA:22:22:24	192.168.60.15	255.255.255.0

Configuring the L3 Tunnel Network

Configure L3 tunneling by modifying or adding a Network. Then, make sure the network is associated with a VAP on the AP Profile assigned to the APs that wireless clients might use for roaming. Once you change the AP Profile, re-apply the profile to the APs to reset the APs that use the profile.

NOTE: When L3 tunneling is enabled, the VLAN ID for the network is not used. In fact, the switch puts the management VLAN ID, if any, on the tunneled packets.

In this example, the L3 Tunnel network is on Network 3 on the Default AP Profile. The SSID of the network is “L3 Tunnel,” and the security mechanism is WPA Enterprise.

Example of Configuring L3 Roaming by Using the CLI

The following procedures show how to configure the D-Link Unified Switch by using the CLI. The Web interface configuration procedures follow this example.

1. Enter the network configuration mode for network 3.

```
(switch-prompt) #configure
(switch-prompt) (Config)#wireless
(switch-prompt) (Config-wireless)#network 3
```

2. Create the network name (SSID).

```
(switch-prompt) (Config-network)#ssid "L3 Tunnel"
```

3. Configure security on the network to control wireless client access.

For this network, the administrator uses WPA Enterprise for the security mode. The administrator must also configure the security on each client that is allowed to access the L3 Tunnel network.

```
(switch-prompt) (Config-network)#security mode wpa-enterprise
```

4. Enable L3 roaming.

```
(switch-prompt) (Config-network)#tunnel
```

5. Configure the L3 network IP address and subnet mask for the tunnel.

NOTE:The network address you enter must be the same subnet used by the VLAN routing interface created in [“Creating the VLAN Routing Interface”](#) on page 190.

```
(switch-prompt) (Config-network)#tunnel subnet 192.168.60.0 mask
255.255.255.0
```

6. Exit out of Network mode and Enter AP profile configuration mode for the default profile (Profile 1).

```
(switch-prompt) (Config-network)#exit
(switch-prompt) (Config-wireless)#ap profile 1
```

7. Enter the AP Profile Radio Config mode for the radio you want to use.

In this example, the L3 Tunnel network uses Radio 1, which is the 802.11g radio by default.

```
(switch-prompt) (Config-ap-profile)#radio 1
```

8. Enter the AP Profile VAP Config mode for VAP 2 and enable the VAP.

VAP 0 is the default network and is the only network enabled by default. In this example, the Guest networks is on VAP 0, the Corporate Network is on VAP 1, and the L3 Tunnel Network is on VAP 2.

```
(switch-prompt) (Config-ap-radio)#vap 2
(switch-prompt) (Config-ap-profile-vap)#enable
```

9. Associate the L3 Tunnel Network (network 3) with VAP 2.

```
(switch-prompt) (Config-ap-profile-vap)#network 3
```

- Enter CTRL + Z to exit to Privileged EXEC mode and view the network configuration to make sure the L3 Tunnel Status is listed as “Configured” and to confirm that other network settings are correct.

```
(switch-prompt) #show wireless network 3
```

```
Network ID..... 3
SSID..... L3 Tunnel
Default VLAN..... 1
Hide SSID..... Disable
Deny Broadcast..... Disable
L3 Tunnel Mode..... Enable
L3 Tunnel Status..... Configured
L3 Tunnel Subnet IP..... 192.168.60.0
L3 Tunnel Subnet Mask..... 255.255.255.0
Security Mode..... WPA Enterprise
MAC Authentication..... Disable
RADIUS Use AP Profile..... Enable
RADIUS Server IP..... 0.0.0.0
RADIUS Secret Configured..... No
RADIUS Accounting..... Disable
WPA Versions..... WPA/WPA2
WPA Ciphers..... TKIP
WPA Key Type..... ASCII
WPA Key.....
WPA2 Pre-Authentication..... Enable
WPA2 Pre-Authentication Limit (minutes)..... 0
WPA2 Pre-Authentication Timeout (minutes)..... 0
--More-- or (q)uit
WPA2 Key Forwarding..... Enable
WPA2 Key Caching Holdtime (minutes)..... 10
WEP Authentication Type..... Open System
WEP Key Type..... HEX
WEP Key Length (bits)..... 128
WEP Transfer Key Index..... 1
WEP Key 1.....
WEP Key 2.....
WEP Key 3.....
WEP Key 4.....
```

An important value to note is the L3 Tunnel Status value. The following table lists the possible values and explains what they mean.

Table 64. L3 Tunnel Status Values

L3 Tunnel Status	Description
None	The status might be None for one of the following reasons: <ul style="list-style-type: none"> The WLAN Operational Status is disabled L3 Tunnel is Disabled The network is not associated with any AP profiles. If you create or edit a network and configure L3 Tunneling, but there are no VAPs on any AP Profiles that use the network, the status is None.
Configured	The L3 Tunnel is configured and ready to be applied to the APs that use this profile.

Table 64. L3 Tunnel Status Values

L3 Tunnel Status	Description
Not Configured - Routing Disabled	Routing is disabled on the routing interface.
Not Configured - No Routing Interface	<p>The status might show this value for one of the following reasons:</p> <ul style="list-style-type: none"> • The routing interface for the L3 Tunnel network does not exist. • IPv6 is enabled on the routing interface. • IP Multicast is enabled on the routing interface. • The Tunnel subnet address does not match a routing interface. <p>In the example in this appendix, the VLAN routing interface has an IP address of 192.168.60.15/24, and the L3 Tunnel Subnet is 192.168.60.0/24, so the tunnel subnet matches a routing interface.</p>

11. From Privileged EXEC mode, apply the modified default profile to the APs that use the default profile (Profile 1).

```
(switch-prompt)#wireless ap profile apply 1
```

After the managed AP updates complete, the L3 Tunnel network is available on all APs that use the default profile. Users who connect to an AP by using the L3 Tunnel SSID can roam among all APs without traffic interruption.

To test connectivity, make sure you can ping from each AP to the switch loopback IP address and the IP address used by the routing interface for L3 tunnels. From Privileged EXEC mode, you can enable debugging on the AP with the `wireless ap debug <macaddr>` command, which allows you to Telnet to the AP.

Once a wireless client associates with the tunneled subnet, use the ping command and set a large packet size to make sure you can send the desired MTU size through the tunnel. For more information about setting the MTU size, see [“Setting the MTU Size”](#) on page 200.

From a Windows client, use `-l <size>` to set the packet size and `-f` to prohibit packet fragmentation, for example:

```
ping -l 1542 -f 192.168.60.15
```

From a Unix system, use `-s <size>` to set the packet size and `-M do` to prohibit packet fragmentation, for example:

```
ping -s 1542 -M do 192.168.60.15
```

Example of Configuring L3 Roaming by Using the Web Interface

The following steps shows the procedures to configure the L3 Tunnel Network by using the Web interface on the switch.

1. From the **Administration > Basic Setup > SSID** tab, select the check box next to the SSID to configure and click **Edit**.

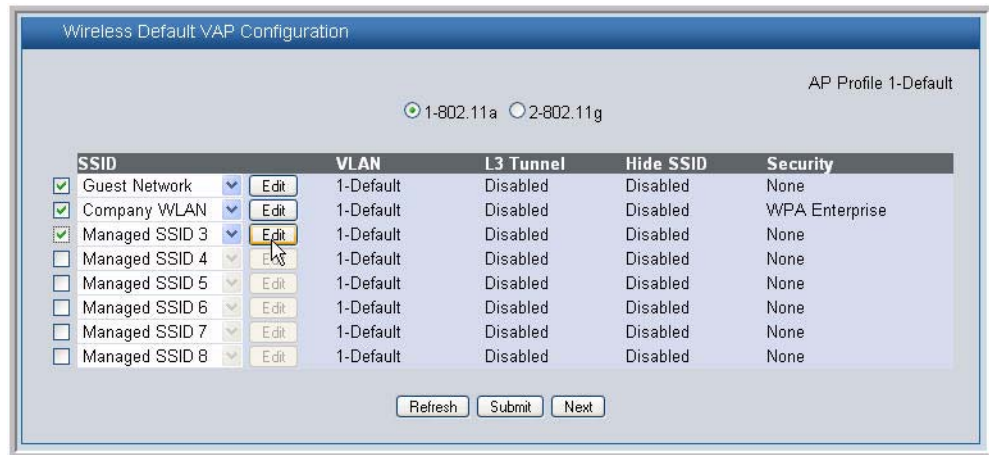

2. From Wireless Network Configuration page, configure the following settings:
 - SSID—L3 Tunnel
 - L3 Tunnel check box—Selected
 - L3 Tunnel Subnet—192.168.60.0
 - L3 Tunnel Mask—255.255.255.0.
 - Security—WPA/PSK.

The L3 Tunnel Subnet is the network IP address of the VLAN routing interface configured in the procedures for [Creating the VLAN Routing Interface](#).



3. Click **Submit** to save the changes to the L3 Tunnel network configuration.

4. Check the L3 Tunnel Status to make sure the L3 Tunnel Status is Configured.
5. To apply the profile changes to the APs, click **Administration > Advanced Configuration > AP Profiles**.
6. Select the Default profile check box and click **Apply**.

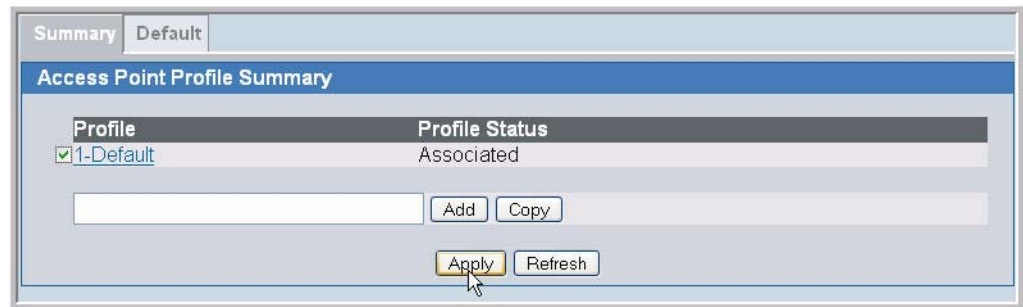

When you update the profile, the Unified Switch adds the L3 Tunnel network to the Managed APs that use the default profile.

Configuring DHCP Relay and the DHCP Server

Unless you use the Unified Switch as a DHCP server or use static IP addresses for all devices, you must enable DHCP relay on the switch so that the switch can forward DHCP requests from the roaming wireless clients to the DHCP server on your network.

If you choose to use the Unified Switch as a DHCP server for wireless clients, you must configure the DHCP server and the address pool for wireless clients.

Configuring the Relay Agent

Use the following command in Global Config mode to enable BootP and DHCP relay on the switch:

```
bootpdhcprelay enable
```

Use the following command in Global Config mode to specify the IP address of the BootP or DHCP server that will assign IP addresses to wireless clients:

```
bootpdhcprelay serverip 192.168.30.2
```

To configure BootP and DHCP relay from the Web interface on the switch, go to the **L3 Features > BootP/DHCP Relay Agent > Configuration** page. Configure the server IP address and enable the Admin Mode, then click **Submit**.

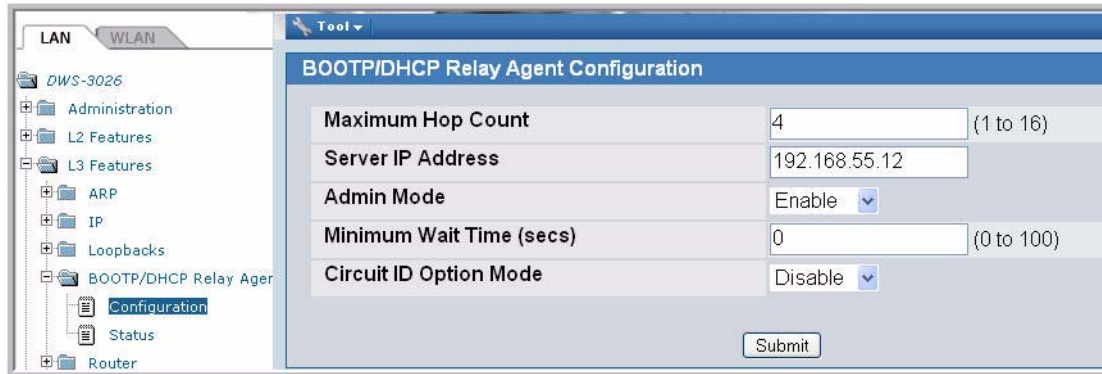

Configuring the DHCP Server

To configure DHCP on the D-Link Unified Switch, you configure the global DHCP settings and the address pool for the clients. The following example shows how to create an address pool for the wireless clients on the L3 Tunnel network. You can create additional address pools so that the DHCP server on the Unified Switch can serve IP addresses to wireless clients that use other networks (such as the Guest Network or Corporate LAN).

The following commands show how to configure a DHCP server to use for the wireless clients that connect to the L3 Tunnel wireless network.

- From Global Config mode, enable DHCP.

```
(switch-prompt) (Config)#service dhcp
```
- Exclude the IP addresses in the range of 192.168.60.1 through 192.168.60.50, which includes the IP addresses of Unified Switch1, Unified Switch2, and the Call Server.

```
(switch-prompt) (Config)#ip dhcp excluded-address 192.168.2.201
192.168.2.255
```
- Create an address pool.

```
(switch-prompt) (Config)#ip dhcp pool vlan200
```
- Configure the L3 Tunnel subnet and netmask as the network address for the clients on VLAN 200.

```
(switch-prompt) (Config)network 192.168.60.0 255.255.255.0
```
- Configure the default router for the address pool.

```
(switch-prompt) (Config)default-router 192.168.60.1
```

Use the following procedures to perform the same configuration by using the Web interface.

1. From the **Administration > DHCP Server > Global Configuration** page, enable the Admin Mode and enter the range of IP addresses that you do not want to assign to wireless clients, then click **Submit**.

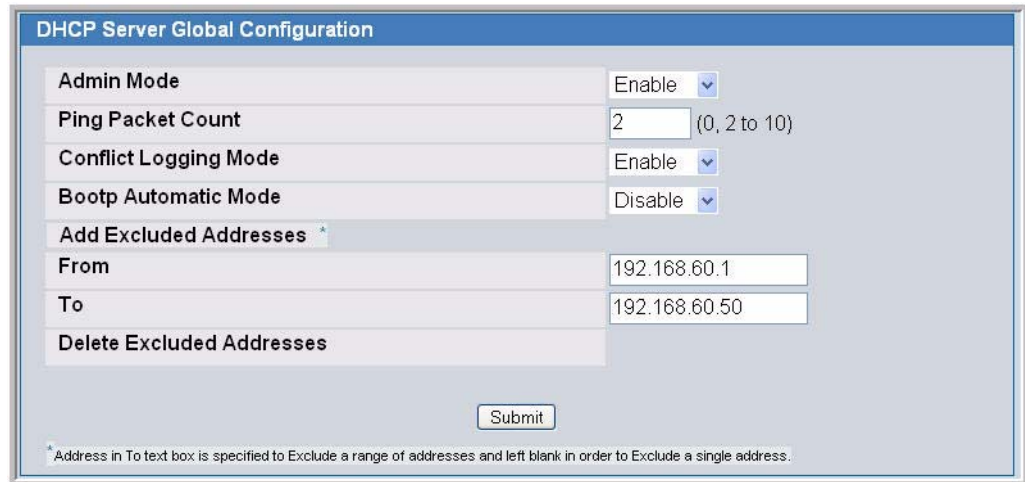

DHCP Server Global Configuration	
Admin Mode	Enable
Ping Packet Count	2 (0, 2 to 10)
Conflict Logging Mode	Enable
Bootp Automatic Mode	Disable
Add Excluded Addresses *	
From	192.168.60.1
To	192.168.60.50
Delete Excluded Addresses	
Submit	
* Address in To text box is specified to Exclude a range of addresses and left blank in order to Exclude a single address.	

2. Navigate to the **Administration > DHCP Server > Pool Configuration** page and select Create from the **Pool Name** drop-down menu.
3. Enter a name for the address pool in the **Pool Name** field and select Dynamic from the **Type of Binding** drop-down menu.
4. Enter a network number, network mask, and default router address in the appropriate fields and click **Submit**.

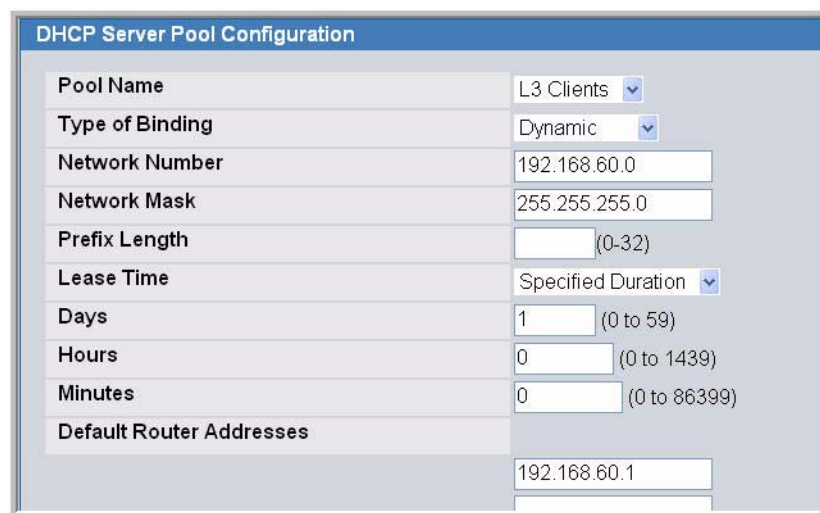

DHCP Server Pool Configuration	
Pool Name	L3 Clients
Type of Binding	Dynamic
Network Number	192.168.60.0
Network Mask	255.255.255.0
Prefix Length	(0-32)
Lease Time	Specified Duration
Days	1 (0 to 59)
Hours	0 (0 to 1439)
Minutes	0 (0 to 86399)
Default Router Addresses	192.168.60.1

Setting the MTU Size

The MTU determines the maximum size of a packet that can be transmitted through a port in one frame. The default MTU size for the ports on the D-Link Unified Switch is 1518 bytes. Packets that use the L3 tunnel have an extra 20 bytes in the header for encapsulation. To support these larger frames, you can increase the MTU size on all intermediate ports and unified switch ports. The AP can transmit and receive frames of up to 1542 bytes on the LAN port

NOTE: If you use tunneling only for IP telephony, or if you set the MTU size on all wireless clients that use tunneling to 1480, you do not need to increase the MTU size in the network.

The following example shows how to change the MTU size on port 12 (interface 1/0/12 in unit/slot/port format or 0/12 in slot/port format) to 1542 bytes.

1. From the CLI, log on to the switch and enter interface configuration mode for the port to configure.

```
(switch-prompt) >enable  
Password:*****  
(switch-prompt) #configure  
(switch-prompt) (Config)#interface 1/0/12
```
2. Use the **mtu** command to set the desired maximum transmission unit size for the interface.

```
(switch-prompt) (Interface 0/12)#mtu 1542
```
3. To save your changes to NVRAM, exit to Privileged EXEC mode and enter **write**.

Use the following steps to set the MTU size by using the Web interface

1. Log on to the switch and access the **Administration > Port Configuration > Port Configuration** page.
2. From the **Slot/Port** or **Unit/Slot/Port** field, select the port to configure from the drop-down list, or select All to configure all ports.

3. Enter the MTU size in the **Maximum Frame Size** field.

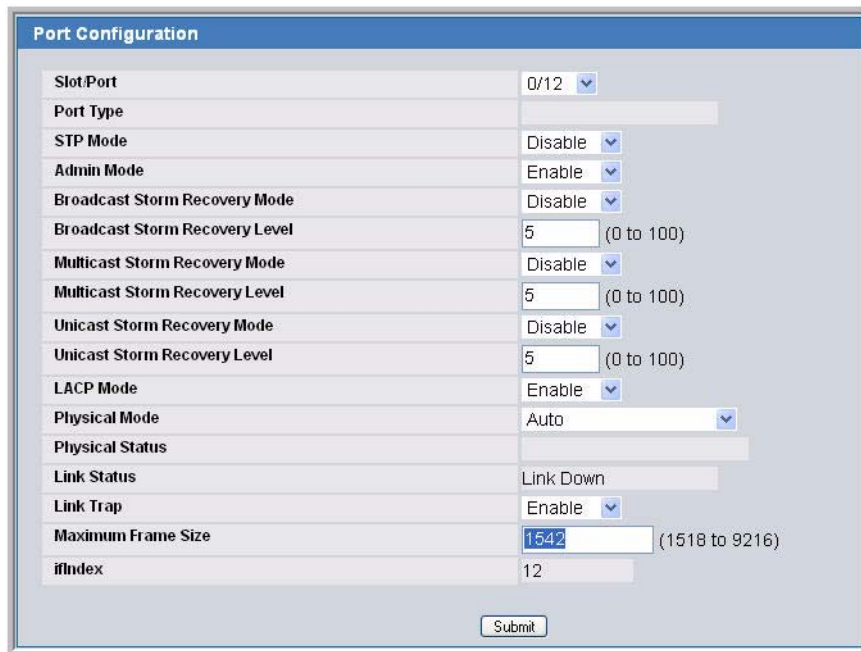

The screenshot displays the 'Port Configuration' web interface. The 'Maximum Frame Size' field is highlighted with a blue selection box and contains the value '1542'. The range '(1518 to 9216)' is shown to the right of the input field. Other configuration options include Slot/Port (0/12), Port Type, STP Mode (Disable), Admin Mode (Enable), Broadcast Storm Recovery Mode (Disable), Broadcast Storm Recovery Level (5), Multicast Storm Recovery Mode (Disable), Multicast Storm Recovery Level (5), Unicast Storm Recovery Mode (Disable), Unicast Storm Recovery Level (5), LACP Mode (Enable), Physical Mode (Auto), Physical Status, Link Status (Link Down), Link Trap (Enable), and ifIndex (12). A 'Submit' button is located at the bottom right of the configuration area.

Field	Value
Slot/Port	0/12
Port Type	
STP Mode	Disable
Admin Mode	Enable
Broadcast Storm Recovery Mode	Disable
Broadcast Storm Recovery Level	5 (0 to 100)
Multicast Storm Recovery Mode	Disable
Multicast Storm Recovery Level	5 (0 to 100)
Unicast Storm Recovery Mode	Disable
Unicast Storm Recovery Level	5 (0 to 100)
LACP Mode	Enable
Physical Mode	Auto
Physical Status	
Link Status	Link Down
Link Trap	Enable
Maximum Frame Size	1542 (1518 to 9216)
ifIndex	12

4. Click **Submit** to apply your changes to the running configuration.
5. To make your changes permanent across a reboot, click **Save Changes** from the Tool Menu, t.

Understanding Quality of Service

Quality of Service (QoS) provides you with the ability to specify parameters on multiple queues for increased throughput and better performance of differentiated wireless traffic like *Voice-over-IP* (VoIP), other types of audio, video, and streaming media as well as traditional IP data over the D-Link Unified Access System.

A primary factor that affects QoS is network congestion due to an increased number of clients attempting to access the air waves and higher traffic volume competing for bandwidth during a busy time of day. The most noticeable degradation in service on a busy, overloaded network will be evident in time-sensitive applications like Video, *Voice-over-IP* (VoIP), and streaming media.

Unlike typical data files which are less affected by variability in QoS, Video, VoIP and streaming media must be sent in a specific order at a consistent rate and with minimum delay between Packet transmission. If the quality of service is compromised, the audio or video will be distorted.

QoS and Load Balancing

By using a combination of load balancing (see “[Configuring Load Balancing](#)” on page 74) and QoS techniques, you can provide a high quality of service for time-sensitive applications even on a busy network. Load balancing sets thresholds for client associations and AP utilization. QoS is a means of allocating bandwidth and network access based on transmission priorities for different types of wireless traffic within a single access point.

802.11e and WMM Standards Support

QoS describes a range of technologies for controlling data streams on shared network connections. The IEEE 802.11e task group is in the process of defining a QoS standard for transmission quality and availability of service on wireless networks. QoS is designed to provide better network service by minimizing network congestion; limiting Jitter, Latency, and Packet Loss; supporting dedicated bandwidth for time-sensitive or mission critical applications, and prioritizing wireless traffic for channel access.

As with all IEEE 802.11 working group standards, the goal is to provide a standard way of implementing QoS features so that components from different companies are interoperable.

The D-Link Access Points provide QoS based on the *Wireless Multimedia* (WMM) specification, which implements a subset of 802.11e features.

Both access points and wireless clients (laptops, consumer electronics products) can be WMM-enabled by the Wi-Fi Alliance.

Coordinating Traffic Flow

Configuring QoS options on the D-Link Unified Access System consists of setting parameters on existing queues for different types of wireless traffic. You can configure different minimum and maximum wait times for the transmission of packets in each queue based on the requirements of the media being sent. Queues automatically provide minimum transmission delay for Voice, Video, multimedia, and mission critical applications, and rely on best-effort parameters for traditional IP data.

For example, time-sensitive Voice, Video, and multimedia are given effectively higher priority for transmission (lower wait times for channel access), while other applications and traditional IP data which are less time-sensitive but often more data-intensive are expected to tolerate longer wait times.

The D-Link Unified Access System implements QoS based on the IEEE Wireless Multimedia (WMM) standard. A Linux-based queuing class is used to tag packets and establish multiple queues. The queues provided offer built-in prioritization and routing based on the type of data being transmitted.

The Administration UI provides a way for you to configure parameters on the queues.

QoS Queues and DSCP on Packets

QoS on the D-Link Unified Access System leverages WMM information in the IP packet header related to Diff-Serv Code Point (DSCP). Every IP packet sent over the network includes a DSCP field in the header that indicates how the data should be prioritized and transmitted over the network. The DSCP field consists of a 6 bit value defined by the local administration. For WMM, Wi-Fi Alliance suggests a particular mapping for DSCP values

The access point examines the DSCP field in the headers of all packets that pass through the AP. Based on the value in a packet's DSCP field, the AP prioritizes the packet for transmission by assigning it to one of the queues. This process occurs automatically, regardless of whether you deliberately configure QoS or not.

A different type of data is associated with each queue. The queue and associated priorities and parameters for transmission are as follows:

- Data 0 (Voice). Highest priority queue, minimum delay. Time-sensitive data such as Voice over IP (VoIP) is automatically sent to this queue.
- Data 1 (Video). High priority queue, minimum delay. Time-sensitive data such as Video and other streaming media are automatically sent to this queue.
- Data 2 (Best Effort). Medium priority queue, medium throughput and delay. Most traditional IP data is sent to this queue.

- Data 3 (Background). Lowest priority queue, high throughput. Bulk data that requires maximum throughput and is not time-sensitive is sent to this queue (FTP data, for example).

Using the QoS settings in the AP profile, you can configure *Enhanced Distributed Channel Access* (EDCA) parameters that determine how each queue is treated when it is sent by the access point to the client or by the client to the access point.

Wireless traffic travels:

- Downstream from the access point to the client station
- Upstream from client station to access point
- Upstream from access point to network
- Downstream from network to access point

With WMM enabled, QoS settings on the D-Link Unified Access System affect the first two of these; *downstream* traffic flowing from the access point to client station (AP EDCA parameters) and the *upstream* traffic flowing from the station to the access point (station EDCA parameters).

With WMM disabled, you can still set some parameters on the downstream traffic flowing from the access point to the client station (AP EDCA parameters).

The other phases of the traffic flow (to and from the network) are not under control of the QoS settings on the AP.

EDCF Control of Data Frames and AIFS

Data is transmitted over 802.11 wireless networks in *frames*. A *Frame* consists of a discrete portion of data along with some descriptive meta-information packaged for transmission on a wireless network.

Each frame includes a source and destination MAC address, a control field with protocol version, frame type, frame sequence number, frame body (with the actual information to be transmitted) and frame check sequence for error detection.

The 802.11 standard defines various *frame* types for management and control of the wireless infrastructure, and for data transmission. 802.11 frame types are (1) *management frames*, (2) *control frames*, and (3) *data frames*. Management and control frames (which manage and control the availability of the wireless infrastructure) automatically have higher priority for transmission.

802.11e uses *interframe spaces* to regulate which frames get access to available channels and to coordinate wait times for transmission of different types of data.

Management and control frames wait a minimum amount of time for transmission; they wait a *short interframe space* (SIF). These wait times are built-in to 802.11 as infrastructure support and are not configurable.

The D-Link Unified Access System supports the *Enhanced Distribution Coordination Function* (EDCF) as defined by the 802.11e standard. EDCF, which is an enhancement to the DCF standard and is based on CSMA/CA protocol, defines the interframe space (IFS) between

data frames. Data frames wait for an amount of time defined as the *arbitration interframe space* (AIFS) before transmitting.

This parameter is configurable.

Random Backoff and Contention Windows

If an access point detects that the medium is in use (busy), it uses the DCF *random backoff* timer to determine the amount of time to wait before attempting to access a given channel again. Each access point waits some random period of time between retries. The wait time (initially a random value within a range specified as the *Minimum Contention Window*) increases exponentially up to a specified limit (*Maximum Contention Window*). The random delay avoids most of the collisions that would occur if multiple APs got access to the medium at the same time and tried to transmit data simultaneously. The more active users you have on a network, the more significant the performance gains of the backoff timer will be in reducing the number of collisions and retransmissions.

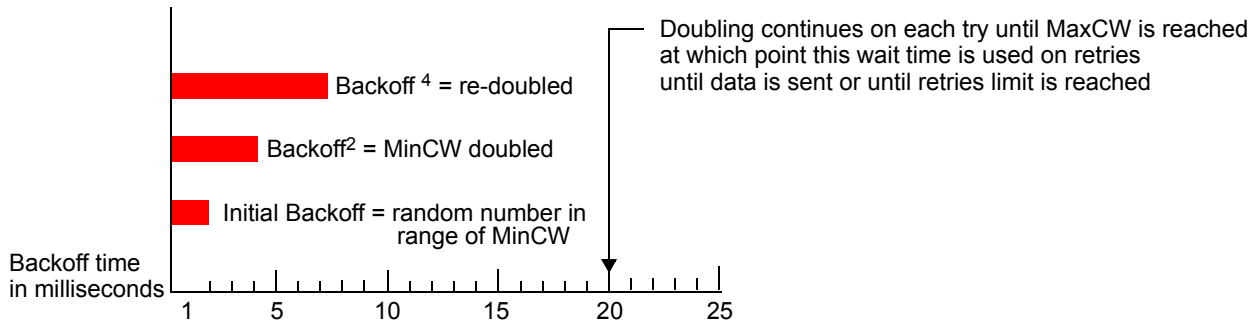

The random backoff used by the access point is a configurable parameter. To describe the random delay, a “Minimum Contention Window” (MinCW) and a “Maximum Contention Window” (MaxCW) is defined.

- The value specified for the Minimum Contention Window is the upper limit of a range for the initial random backoff wait time. The number used in the random backoff is initially a random number between 0 and the number defined for the Minimum Contention Window.
- If the first random backoff time ends before successful transmission of the data frame, the access point increments a retry counter, and doubles the value of the random backoff window. The value specified in the Maximum Contention Window is the upper limit for this doubling of the random backoff. This doubling continues until either the data frame is sent or the Maximum Contention Window size is reached.

Packet Bursting for Better Performance

The D-Link Unified Access System includes 802.11e based *packet bursting* technology that increases data throughput and speed of transmission over the wireless network. Packet bursting enables the transmission of multiple packets without the extra overhead of header information. The effect of this is to increase network speed and data throughput. The size of packet bursts allowed (maximum burst length) is a configurable parameter.

TXOP Interval for Client Stations

The *Transmission Opportunity* (TXOP) is an interval of time when a Wi-Fi Multimedia (WMM) client station has the right to initiate transmissions onto the wireless medium (WM).

802.1p and DSCP tags

IEEE 802.1p is an extension of the IEEE 802 standard and is responsible for QoS provision. One purpose of 802.1p is to prioritize network traffic at the data link/ MAC layer.

The 802.1p tag includes a three-bit field for prioritization, which allows packets to be grouped into various traffic classes. Eight priority levels are defined. The highest priority is seven, which might go to network critical traffic (voice). The lowest priority level is zero, this is used as a best-effort default, it is invoked automatically when no other value has been set.

NOTE: IEEE 802.1p prioritization will not work unless QoS and WMM are enabled. WMM must be enabled on both the AP and on the client connecting to the AP.

Figure 84 outlines the way in which tags are retrieved and traffic prioritized on a network.

Figure 84. Traffic Prioritization

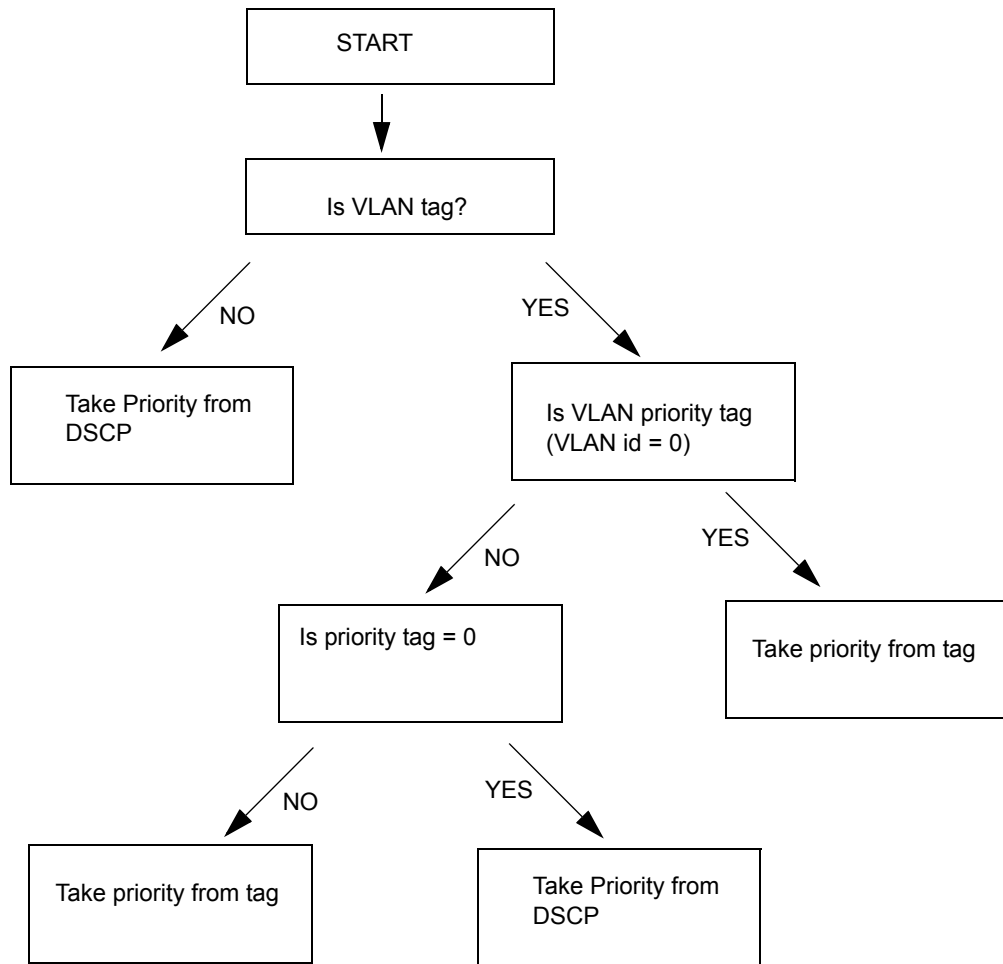

Table 65 outlines the VLAN priority and DSCP values.

Table 65. VLAN Priority Tags

VLAN Priority	Priority	DSCP Value
0	Best Effort	0
1	Background	16
2	Background	8
3	Best Effort	24
4	Video	32
5	Video	40
6	Voice	48
7	Voice	56



Warranty and Registration Information

All countries and regions excluding USA

Wichtige Sicherheitshinweise

1. Bitte lesen Sie sich diese Hinweise sorgfältig durch.
2. Heben Sie diese Anleitung für den spätern Gebrauch auf.
3. Vor jedem Reinigen ist das Gerät vom Stromnetz zu trennen. Verwenden Sie keine Flüssig- oder Aerosolreiniger. Am besten dient ein angefeuchtetes Tuch zur Reinigung.
4. Um eine Beschädigung des Gerätes zu vermeiden sollten Sie nur Zubehörteile verwenden, die vom Hersteller zugelassen sind.
5. Das Gerät is vor Feuchtigkeit zu schützen.
6. Bei der Aufstellung des Gerätes ist auf sichern Stand zu achten. Ein Kippen oder Fallen könnte Verletzungen hervorrufen. Verwenden Sie nur sichere Standorte und beachten Sie die Aufstellhinweise des Herstellers.
7. Die Belüftungsöffnungen dienen zur Luftzirkulation die das Gerät vor Überhitzung schützt. Sorgen Sie dafür, daß diese Öffnungen nicht abgedeckt werden.
8. Beachten Sie beim Anschluß an das Stromnetz die Anschlußwerte.
9. Die Netzanschlußsteckdose muß aus Gründen der elektrischen Sicherheit einen Schutzleiterkontakt haben.
10. Verlegen Sie die Netzanschlußleitung so, daß niemand darüber fallen kann. Es sollete auch nichts auf der Leitung abgestellt werden.
11. Alle Hinweise und Warnungen die sich am Geräten befinden sind zu beachten.
12. Wird das Gerät über einen längeren Zeitraum nicht benutzt, sollten Sie es vom Stromnetz trennen. Somit wird im Falle einer Überspannung eine Beschädigung vermieden.
13. Durch die Lüftungsöffnungen dürfen niemals Gegenstände oder Flüssigkeiten in das Gerät gelangen. Dies könnte einen Brand bzw. Elektrischen Schlag auslösen.
14. Öffnen Sie niemals das Gerät. Das Gerät darf aus Gründen der elektrischen Sicherheit nur von autorisiertem Servicepersonal geöffnet werden.
15. Wenn folgende Situationen auftreten ist das Gerät vom Stromnetz zu trennen und von einer qualifizierten Servicestelle zu überprüfen:
 - A. Netzkabel oder Netzstecker sint beschädigt.

- B. Flüssigkeit ist in das Gerät eingedrungen.
 - C. Das Gerät war Feuchtigkeit ausgesetzt.
 - D. Wenn das Gerät nicht der Bedienungsanleitung entsprechend funktioniert oder Sie mit Hilfe dieser Anleitung keine Verbesserung erzielen.
 - E. Das Gerät ist gefallen und/oder das Gehäuse ist beschädigt.
 - F. Wenn das Gerät deutliche Anzeichen eines Defektes aufweist.
16. Bei Reparaturen dürfen nur Originalersatzteile bzw. den Originalteilen entsprechende Teile verwendet werden. Der Einsatz von ungeeigneten Ersatzteilen kann eine weitere Beschädigung hervorrufen.
17. Wenden Sie sich mit allen Fragen die Service und Reparatur betreffen an Ihren Servicepartner. Somit stellen Sie die Betriebssicherheit des Gerätes sicher.
18. Zum Netzanschluß dieses Gerätes ist eine geprüfte Leitung zu verwenden, Für einen Nennstrom bis 6A und einem Gerätegewicht größer 3kg ist eine Leitung nicht leichter als H05VV-F, 3G, 0.75mm² einzusetzen.

WARRANTIES EXCLUSIVE

IF THE D-LINK PRODUCT DOES NOT OPERATE AS WARRANTED ABOVE, THE CUSTOMER'S SOLE REMEDY SHALL BE, AT D-LINK'S OPTION, REPAIR OR REPLACEMENT. THE FOREGOING WARRANTIES AND REMEDIES ARE EXCLUSIVE AND ARE IN LIEU OF ALL OTHER WARRANTIES, EXPRESSED OR IMPLIED, EITHER IN FACT OR BY OPERATION OF LAW, STATUTORY OR OTHERWISE, INCLUDING WARRANTIES OF MERCHANTABILITY AND FITNESS FOR A PARTICULAR PURPOSE. D-LINK NEITHER ASSUMES NOR AUTHORIZES ANY OTHER PERSON TO ASSUME FOR IT ANY OTHER LIABILITY IN CONNECTION WITH THE SALE, INSTALLATION MAINTENANCE OR USE OF D-LINK'S PRODUCTS.

D-LINK SHALL NOT BE LIABLE UNDER THIS WARRANTY IF ITS TESTING AND EXAMINATION DISCLOSE THAT THE ALLEGED DEFECT IN THE PRODUCT DOES NOT EXIST OR WAS CAUSED BY THE CUSTOMER'S OR ANY THIRD PERSON'S MISUSE, NEGLIGENCE, IMPROPER INSTALLATION OR TESTING, UNAUTHORIZED ATTEMPTS TO REPAIR, OR ANY OTHER CAUSE BEYOND THE RANGE OF THE INTENDED USE, OR BY ACCIDENT, FIRE, LIGHTNING OR OTHER HAZARD.

LIMITATION OF LIABILITY

IN NO EVENT WILL D-LINK BE LIABLE FOR ANY DAMAGES, INCLUDING LOSS OF DATA, LOSS OF PROFITS, COST OF COVER OR OTHER INCIDENTAL, CONSEQUENTIAL OR INDIRECT DAMAGES ARISING OUT THE INSTALLATION, MAINTENANCE, USE, PERFORMANCE, FAILURE OR INTERRUPTION OF A D-LINK PRODUCT, HOWEVER CAUSED AND ON ANY THEORY OF LIABILITY. THIS LIMITATION WILL APPLY EVEN IF D-LINK HAS BEEN ADVISED OF THE POSSIBILITY OF SUCH DAMAGE.

IF YOU PURCHASED A D-LINK PRODUCT IN THE UNITED STATES, SOME STATES DO NOT ALLOW THE LIMITATION OR EXCLUSION OF LIABILITY FOR

INCIDENTAL OR CONSEQUENTIAL DAMAGES, SO THE ABOVE LIMITATION MAY NOT APPLY TO YOU.

Limited Warranty

Hardware:

D-Link warrants each of its hardware products to be free from defects in workmanship and materials under normal use and service for a period commencing on the date of purchase from D-Link or its Authorized Reseller and extending for the length of time stipulated by the Authorized Reseller or D-Link Branch Office nearest to the place of purchase.

This Warranty applies on the condition that the product Registration Card is filled out and returned to a D-Link office within ninety (90) days of purchase. A list of D-Link offices is provided at the back of this manual, together with a copy of the Registration Card.

If the product proves defective within the applicable warranty period, D-Link will provide repair or replacement of the product. D-Link shall have the sole discretion whether to repair or replace, and replacement product may be new or reconditioned. Replacement product shall be of equivalent or better specifications, relative to the defective product, but need not be identical. Any product or part repaired by D-Link pursuant to this warranty shall have a warranty period of not less than 90 days, from date of such repair, irrespective of any earlier expiration of original warranty period. When D-Link provides replacement, then the defective product becomes the property of D-Link.

Warranty service may be obtained by contacting a D-Link office within the applicable warranty period, and requesting a Return Material Authorization (RMA) number. If a Registration Card for the product in question has not been returned to D-Link, then a proof of purchase (such as a copy of the dated purchase invoice) must be provided. If Purchaser's circumstances require special handling of warranty correction, then at the time of requesting RMA number, Purchaser may also propose special procedure as may be suitable to the case.

After an RMA number is issued, the defective product must be packaged securely in the original or other suitable shipping package to ensure that it will not be damaged in transit, and the RMA number must be prominently marked on the outside of the package. The package must be mailed or otherwise shipped to D-Link with all costs of mailing/shipping/insurance prepaid. D-Link shall never be responsible for any software, firmware, information, or memory data of Purchaser contained in, stored on, or integrated with any product returned to D-Link pursuant to this warranty.

Any package returned to D-Link without an RMA number will be rejected and shipped back to Purchaser at Purchaser's expense, and D-Link reserves the right in such a case to levy a reasonable handling charge in addition mailing or shipping costs.

Software:

Warranty service for software products may be obtained by contacting a D-Link office within the applicable warranty period. A list of D-Link offices is provided at the back of this manual, together with a copy of the Registration Card. If a Registration Card for the product in question has not been returned to a D-Link office, then a proof of purchase (such as a copy of the dated purchase invoice) must be provided when requesting warranty service. The term

“purchase” in this software warranty refers to the purchase transaction and resulting license to use such software.

D-Link warrants that its software products will perform in substantial conformance with the applicable product documentation provided by D-Link with such software product, for a period of ninety (90) days from the date of purchase from D-Link or its Authorized Reseller. D-Link warrants the magnetic media, on which D-Link provides its software product, against failure during the same warranty period. This warranty applies to purchased software, and to replacement software provided by D-Link pursuant to this warranty, but shall not apply to any update or replacement which may be provided for download via the Internet, or to any update which may otherwise be provided free of charge.

D-Link's sole obligation under this software warranty shall be to replace any defective software product with product which substantially conforms to D-Link's applicable product documentation. Purchaser assumes responsibility for the selection of appropriate application and system/platform software and associated reference materials. D-Link makes no warranty that its software products will work in combination with any hardware, or any application or system/platform software product provided by any third party, excepting only such products as are expressly represented, in D-Link's applicable product documentation as being compatible. D-Link's obligation under this warranty shall be a reasonable effort to provide compatibility, but D-Link shall have no obligation to provide compatibility when there is fault in the third-party hardware or software. D-Link makes no warranty that operation of its software products will be uninterrupted or absolutely error-free, and no warranty that all defects in the software product, within or without the scope of D-Link's applicable product documentation, will be corrected.

Limited Warranty (USA Only)

Subject to the terms and conditions set forth herein, D-Link Systems, Inc. (“D-Link”) provides this Limited Warranty:

- Only to the person or entity that originally purchased the product from D-Link or its authorized reseller or distributor, and
- Only for products purchased and delivered within the fifty states of the United States, the District of Columbia, U.S. Possessions or Protectorates, U.S. Military Installations, or addresses with an APO or FPO.

Limited Warranty: D-Link warrants that the hardware portion of the D-Link product described below (“Hardware”) will be free from material defects in workmanship and materials under normal use from the date of original retail purchase of the product, for the period set forth below “Warranty Period”), except as otherwise stated herein.

Limited Lifetime Warranty for the product is defined as follows:

- Hardware: For as long as the original customer/end user owns the product, or five (5) years after product discontinuance, whichever occurs first (excluding power supplies and fans)
- Power supplies and fans: Three (3) Year
- Spare parts and spare kits: Ninety (90) days

The customer's sole and exclusive remedy and the entire liability of D-Link and its suppliers under this Limited Warranty will be, at D-Link's option, to repair or replace the defective

Hardware during the Warranty Period at no charge to the original owner or to refund the actual purchase price paid. Any repair or replacement will be rendered by D-Link at an Authorized D-Link Service Office. The replacement hardware need not be new or have an identical make, model or part. D-Link may, at its option, replace the defective Hardware or any part thereof with any reconditioned product that D-Link reasonably determines is substantially equivalent (or superior) in all material respects to the defective Hardware. Repaired or replacement hardware will be warranted for the remainder of the original Warranty Period or ninety (90) days, whichever is longer, and is subject to the same limitations and exclusions. If a material defect is incapable of correction, or if D-Link determines that it is not practical to repair or replace the defective Hardware, the actual price paid by the original purchaser for the defective Hardware will be refunded by D-Link upon return to D-Link of the defective Hardware. All Hardware or part thereof that is replaced by D-Link, for which the purchase price is refunded, shall become the property of D-Link upon replacement or refund.

Limited Software Warranty: D-Link warrants that the software portion of the product (“Software”) will substantially conform to D-Link’s then current functional specifications for the Software, as set forth in the applicable documentation, from the date of original retail purchase of the Software for a period of ninety (90) days (“Software Warranty Period”), provided that the Software is properly installed on approved hardware and operated as contemplated in its documentation. D-Link further warrants that, during the Software Warranty Period, the magnetic media on which D-Link delivers the Software will be free of physical defects. The customer's sole and exclusive remedy and the entire liability of D-Link and its suppliers under this Limited Warranty will be, at D-Link’s option, to replace the non-conforming Software (or defective media) with software that substantially conforms to D-Link’s functional specifications for the Software or to refund the portion of the actual purchase price paid that is attributable to the Software. Except as otherwise agreed by D-Link in writing, the replacement Software is provided only to the original licensee, and is subject to the terms and conditions of the license granted by D-Link for the Software. Replacement Software will be warranted for the remainder of the original Warranty Period and is subject to the same limitations and exclusions. If a material non-conformance is incapable of correction, or if D-Link determines in its sole discretion that it is not practical to replace the non-conforming Software, the price paid by the original licensee for the non-conforming Software will be refunded by D-Link; provided that the non-conforming Software (and all copies thereof) is first returned to D-Link. The license granted respecting any Software for which a refund is given automatically terminates.

Non-Applicability of Warranty: The Limited Warranty provided hereunder for Hardware and Software portions of D-Link's products will not be applied to and does not cover any refurbished product and any product purchased through the inventory clearance or liquidation sale or other sales in which D-Link, the sellers, or the liquidators expressly disclaim their warranty obligation pertaining to the product and in that case, the product is being sold “As-Is” without any warranty whatsoever including, without limitation, the Limited Warranty as described herein, notwithstanding anything stated herein to the contrary.

Submitting A Claim: The customer shall return the product to the original purchase point based on its return policy. In case the return policy period has expired and the product is within warranty, the customer shall submit a claim to D-Link as outlined below:

- The customer must submit with the product as part of the claim a written description of the Hardware defect or Software nonconformance in sufficient detail to allow D-Link to

confirm the same, along with proof of purchase of the product (such as a copy of the dated purchase invoice for the product) if the product is not registered.

- The customer must obtain a Case ID Number from D-Link Technical Support at 1-877-453-5465, who will attempt to assist the customer in resolving any suspected defects with the product. If the product is considered defective, the customer must obtain a Return Material Authorization (“RMA”) number by completing the RMA form and entering the assigned Case ID Number at <https://rma.dlink.com/>.
- After an RMA number is issued, the defective product must be packaged securely in the original or other suitable shipping package to ensure that it will not be damaged in transit, and the RMA number must be prominently marked on the outside of the package. Do not include any manuals or accessories in the shipping package. D-Link will only replace the defective portion of the product and will not ship back any accessories.
- The customer is responsible for all in-bound shipping charges to D-Link. No Cash on Delivery (“COD”) is allowed. Products sent COD will either be rejected by D-Link or become the property of D-Link. Products shall be fully insured by the customer and shipped to D-Link Systems, Inc., 17595 Mt. Herrmann, Fountain Valley, CA 92708. D-Link will not be held responsible for any packages that are lost in transit to D-Link. The repaired or replaced packages will be shipped to the customer via UPS Ground or any common carrier selected by D-Link. Return shipping charges shall be prepaid by D-Link if you use an address in the United States, otherwise we will ship the product to you freight collect. Expedited shipping is available upon request and provided shipping charges are prepaid by the customer.

D-Link may reject or return any product that is not packaged and shipped in strict compliance with the foregoing requirements, or for which an RMA number is not visible from the outside of the package. The product owner agrees to pay D-Link’s reasonable handling and return shipping charges for any product that is not packaged and shipped in accordance with the foregoing requirements, or that is determined by D-Link not to be defective or non-conforming.

What Is Not Covered: The Limited Warranty provided herein by D-Link does not cover: Products that, in D-Link’s judgment, have been subjected to abuse, accident, alteration, modification, tampering, negligence, misuse, faulty installation, lack of reasonable care, repair or service in any way that is not contemplated in the documentation for the product, or if the model or serial number has been altered, tampered with, defaced or removed; Initial installation, installation and removal of the product for repair, and shipping costs; Operational adjustments covered in the operating manual for the product, and normal maintenance; Damage that occurs in shipment, due to act of God, failures due to power surge, and cosmetic damage; Any hardware, software, firmware or other products or services provided by anyone other than D-Link; and Products that have been purchased from inventory clearance or liquidation sales or other sales in which D-Link, the sellers, or the liquidators expressly disclaim their warranty obligation pertaining to the product. While necessary maintenance or repairs on your Product can be performed by any company, we recommend that you use only an Authorized D-Link Service Office. Improper or incorrectly performed maintenance or repair voids this Limited Warranty.

Disclaimer of Other Warranties: EXCEPT FOR THE LIMITED WARRANTY SPECIFIED HEREIN, THE PRODUCT IS PROVIDED “AS-IS” WITHOUT ANY WARRANTY OF ANY KIND WHATSOEVER INCLUDING, WITHOUT LIMITATION, ANY WARRANTY OF MERCHANTABILITY, FITNESS FOR A PARTICULAR PURPOSE AND NON-INFRINGEMENT. IF ANY IMPLIED WARRANTY CANNOT BE DISCLAIMED IN ANY TERRITORY WHERE A PRODUCT IS SOLD, THE DURATION OF SUCH IMPLIED

WARRANTY SHALL BE LIMITED TO NINETY (90) DAYS. EXCEPT AS EXPRESSLY COVERED UNDER THE LIMITED WARRANTY PROVIDED HEREIN, THE ENTIRE RISK AS TO THE QUALITY, SELECTION AND PERFORMANCE OF THE PRODUCT IS WITH THE PURCHASER OF THE PRODUCT.

Limitation of Liability: TO THE MAXIMUM EXTENT PERMITTED BY LAW, D-LINK IS NOT LIABLE UNDER ANY CONTRACT, NEGLIGENCE, STRICT LIABILITY OR OTHER LEGAL OR EQUITABLE THEORY FOR ANY LOSS OF USE OF THE PRODUCT, INCONVENIENCE OR DAMAGES OF ANY CHARACTER, WHETHER DIRECT, SPECIAL, INCIDENTAL OR CONSEQUENTIAL (INCLUDING, BUT NOT LIMITED TO, DAMAGES FOR LOSS OF GOODWILL, LOSS OF REVENUE OR PROFIT, WORK STOPPAGE, COMPUTER FAILURE OR MALFUNCTION, FAILURE OF OTHER EQUIPMENT OR COMPUTER PROGRAMS TO WHICH D-LINK'S PRODUCT IS CONNECTED WITH, LOSS OF INFORMATION OR DATA CONTAINED IN, STORED ON, OR INTEGRATED WITH ANY PRODUCT RETURNED TO D-LINK FOR WARRANTY SERVICE) RESULTING FROM THE USE OF THE PRODUCT, RELATING TO WARRANTY SERVICE, OR ARISING OUT OF ANY BREACH OF THIS LIMITED WARRANTY, EVEN IF D-LINK HAS BEEN ADVISED OF THE POSSIBILITY OF SUCH DAMAGES. THE SOLE REMEDY FOR A BREACH OF THE FOREGOING LIMITED WARRANTY IS REPAIR, REPLACEMENT OR REFUND OF THE DEFECTIVE OR NON-CONFORMING PRODUCT. THE MAXIMUM LIABILITY OF D-LINK UNDER THIS WARRANTY IS LIMITED TO THE PURCHASE PRICE OF THE PRODUCT COVERED BY THE WARRANTY. THE FOREGOING EXPRESS WRITTEN WARRANTIES AND REMEDIES ARE EXCLUSIVE AND ARE IN LIEU OF ANY OTHER WARRANTIES OR REMEDIES, EXPRESS, IMPLIED OR STATUTORY.

Governing Law: This Limited Warranty shall be governed by the laws of the State of California. Some states do not allow exclusion or limitation of incidental or consequential damages, or limitations on how long an implied warranty lasts, so the foregoing limitations and exclusions may not apply. This Limited Warranty provides specific legal rights and you may also have other rights which vary from state to state.

Trademarks: D-Link is a registered trademark of D-Link Systems, Inc. Other trademarks or registered trademarks are the property of their respective owners.

Copyright Statement: No part of this publication or documentation accompanying this product may be reproduced in any form or by any means or used to make any derivative such as translation, transformation, or adaptation without permission from D-Link Corporation/D-Link Systems, Inc., as stipulated by the United States Copyright Act of 1976 and any amendments thereto. Contents are subject to change without prior notice. Copyright 2005 by D-Link Corporation/D-Link Systems, Inc. All rights reserved.

CE Mark Warning: This is a Class A product. In a residential environment, this product may cause radio interference, in which case the user may be required to take adequate measures.

FCC Statement: This equipment has been tested and found to comply with the limits for a Class A digital device, pursuant to part 15 of the FCC Rules. These limits are designed to provide reasonable protection against harmful interference in a commercial installation. This equipment generates, uses, and can radiate radio frequency energy and, if not installed and used in accordance with the instructions, may cause harmful interference to radio communication. However, there is no guarantee that interference will not occur in a particular

installation. Operation of this equipment in a residential environment is likely to cause harmful interference to radio or television reception. If this equipment does cause harmful interference to radio or television reception, which can be determined by turning the equipment off and on, the user is encouraged to try to correct the interference by one or more of the following measures:

- Reorient or relocate the receiving antenna.
- Increase the separation between the equipment and receiver.
- Connect the equipment into an outlet on a circuit different from that to which the receiver is connected.
- Consult the dealer or an experienced radio/TV technician for help.

For detailed warranty information applicable to products purchased outside the United States, please contact the corresponding local D-Link office.

Product Registration

Register your D-Link product online at <http://support.dlink.com/register/>.

NOTE: Product registration is entirely voluntary and failure to complete or return this form will not diminish your warranty rights.

Trademarks

Copyright 2006 D-Link Corporation. Contents subject to change without prior notice. D-Link is a registered trademark of D-Link Corporation/ D-Link Systems Inc. All other trademarks belong to their respective proprietors.

Copyright Statement

No part of this publication may be reproduced in any form or by any means or used to make an derivative such as translation, transformation, or adaptation without permission from D-Link Corporation/ D-Link Systems Inc. as stipulated by the United States Copyright Act of 1976.

CE EMI Class A Warning

This is a Class A product. In a domestic environment, this product may cause radio interference, in which case the user may be required to take adequate measures.

D-Link Europe Limited Product Warranty

General Terms

The Limited Product Warranty set forth below is given by D-LINK (Europe) Ltd. (herein referred to as "D-LINK"). This Limited Product Warranty is only effective upon presentation of the proof of purchase. Upon further request by D-LINK, this warranty card has to be presented, too.

EXCEPT AS EXPRESSLY SET FORTH IN THIS LIMITED WARRANTY, D-LINK MAKES NO OTHER WARRANTIES, EXPRESS OR IMPLIED, INCLUDING ANY IMPLIED WARRANTIES OF MERCHANTABILITY AND FITNESS FOR A

PARTICULAR PURPOSE. D-LINK EXPRESSLY DISCLAIMS ALL WARRANTIES NOT STATED IN THIS LIMITED WARRANTY. ANY IMPLIED WARRANTIES THAT MAY BE IMPOSED BY LAW ARE LIMITED IN DURATION TO THE LIMITED WARRANTY PERIOD. SOME STATES OR COUNTRIES DO NOT ALLOW A LIMITATION ON HOW LONG AN IMPLIED WARRANTY LASTS OR THE EXCLUSION OR LIMITATION OF INCIDENTAL OR CONSEQUENTIAL DAMAGES FOR CONSUMER PRODUCTS. IN SUCH STATES OR COUNTRIES, SOME EXCLUSIONS OR LIMITATIONS OF THIS LIMITED WARRANTY MAY NOT APPLY TO YOU. THIS LIMITED WARRANTY GIVES YOU SPECIFIC LEGAL RIGHTS. YOU MAY ALSO HAVE OTHER RIGHTS THAT MAY VARY FROM STATE TO STATE OR FROM COUNTRY TO COUNTRY. YOU ARE ADVISED TO CONSULT APPLICABLE STATE OR COUNTRY LAWS FOR A FULL DETERMINATION OF YOUR RIGHTS.

This limited warranty applies to D-LINK branded hardware products (collectively referred to in this limited warranty as “D-LINK Hardware Products”) sold by from D-LINK (Europe) Ltd., its worldwide subsidiaries, affiliates, authorized resellers, or country distributors (collectively referred to in this limited warranty as “D-LINK”) with this limited warranty. The Term “D-LINK Hardware Product” is limited to the hardware components and all its internal components including firmware. The term “D-LINK Hardware Product” DOES NOT include any software applications or programs.

Geographical Scope of the Limited Product Warranty

This Limited Product Warranty is applicable in all European Countries as listed in the addendum “European Countries for D-LINK Limited Product Warranty”. The term “European Countries” in this D-LINK Limited Product Warranty only include the countries as listed in this addendum. The Limited Product Warranty will be honored in any country where D-LINK or its authorized service providers offer warranty service subject to the terms and conditions set forth in this Limited Product Warranty. However, warranty service availability and response times may vary from country to country and may also be subject to registration requirements.

Limitation of Product Warranty

D-LINK warrants that the products described below under normal use are free from material defects in materials and workmanship during the Limited Product Warranty Period set forth below (“Limited Product Warranty Period”), if the product is used and serviced in accordance with the user manual and other documentation provided to the purchaser at the time of purchase (or as amended from time to time). D-LINK does not warrant that the products will operate uninterrupted or error-free or that all deficiencies, errors, defects or non-conformities will be corrected.

This warranty shall not apply to problems resulting from: (a) unauthorized alterations or attachments; (b) negligence, abuse or misuse, including failure to operate the product in accordance with specifications or interface requirements; (c) improper handling; (d) failure of goods or services not obtained from D-LINK or not subject to a then-effective D-LINK warranty or maintenance agreement; (e) improper use or storage; or (f) fire, water, acts of God or other catastrophic events. This warranty shall also not apply to any particular product if any D-LINK serial number has been removed or defaced in any way.

D-LINK IS NOT RESPONSIBLE FOR DAMAGE THAT OCCURS AS A RESULT OF YOUR FAILURE TO FOLLOW THE INSTRUCTIONS FOR THE D-LINK HARDWARE PRODUCT.

Limited Product Warranty Period

The Limited Product Warranty Period starts on the date of purchase from D-LINK. Your dated sales or delivery receipt, showing the date of purchase of the product, is your proof of the purchase date. You may be required to provide proof of purchase as a condition of receiving warranty service. You are entitled to warranty service according to the terms and conditions of this document if a repair to your D-LINK branded hardware is required within the Limited Product Warranty Period.

This Limited Product Warranty extends only to the original end-user purchaser of this DLINK Hardware Product and is not transferable to anyone who obtains ownership of the DLINK Hardware Product from the original end-user purchaser.

Product Type	Product Warranty Period
Managed Switches (i.e. Switches with built in SNMP agent, including modules and management software)	Five (5) years
All other products	Two (2) years
Spare parts (i.e. External Power Adapters, Fans)	One (1) year

The warranty periods listed above are effective in respect of all D-LINK products sold in European Countries by D-LINK or one of its authorized resellers or distributors from 1st of January 2004. All products sold in European Countries by D-LINK or one of its authorized resellers or distributors before 1st January 2004 carry 5 years warranty, except power supplies, fans and accessories that are provided with 2 year warranty.

The warranty period stated in this card supersedes and replaces the warranty period as stated in the user's manual or in the purchase contract for the relevant products. For the avoidance of doubt, if you have purchased the relevant D-LINK product as a consumer your statutory rights remain unaffected.

Performance of the Limited Product Warranty

If a product defect occurs, D-LINK's sole obligation shall be to repair or replace any defective product free of charge to the original purchaser provided it is returned to an Authorized D-LINK Service Center during the warranty period. Such repair or replacement will be rendered by D-LINK at an Authorized D-LINK Service Center. All component parts or hardware products removed under this limited warranty become the property of D-LINK.

The replacement part or product takes on the remaining limited warranty status of the removed part or product. The replacement product need not be new or of an identical make, model or part; D-LINK may in its discretion replace the defective product (or any part thereof) with any reconditioned equivalent (or superior) product in all material respects to the defective product. Proof of purchase may be required by D-LINK.

Warrantor

D-Link (Europe) Ltd.
4th Floor, Merit House
Edgware Road
Colindale
London NW9 5 AB
United Kingdom
Telephone: +44-020-8731-5555
Facsimile: +44-020-8731-5511
www.dlink.co.uk

D-Link Europe Limited Produktgarantie

Allgemeine Bedingungen

Die hierin beschriebene eingeschränkte Garantie wird durch D-LINK (Europe) Ltd. Gewährt (im Folgenden: „D-LINK“). Diese eingeschränkte Garantie setzt voraus, dass der Kauf des Produkts nachgewiesen wird. Auf Verlangen von D-LINK muss auch dieser Garantieschein vorgelegt werden.

AUSSER IN DEM HIER AUSDRÜCKLICH BESCHRIEBENEN UMFANG GEWÄHRT D-LINK KEINE WEITEREN GARANTIEN, WEDER AUSDRÜCKLICH NOCH STILLSCHWEIGEND. INSBESONDERE WIRD NICHT STILLSCHWEIGEND EINE GARANTIE FÜR DIE ALLGEMEINE GEBRAUCHSTAUGLICHKEIT ODER DIE EIGNUNG FÜR EINEN BESTIMMTEN ZWECK ERKLÄRT. D-LINK LEHNT AUSDRÜCKLICH JEDE GARANTIE AB, DIE ÜBER DIESE EINGESCHRÄNKTE GARANTIE HINAUSGEHT. JEDE GESETZLICH ANGEORDNETE GARANTIE IST AUF DIE LAUFZEIT DER EINGESCHRÄNKTEN GARANTIE BESCHRÄNKT. IN EINIGEN STAATEN ODER LÄNDERN IST DIE ZEITLICHE BESCHRÄNKUNG EINER STILLSCHWEIGEND ERKLÄRTEN GARANTIE SOWIE AUSSCHLUSS ODER BESCHRÄNKUNG VON SCHADENERSATZ FÜR NEBEN- ODER FOLGESCHÄDEN BEIM VERBRAUCHSGÜTERKAUF UNTERSAGT. SOWEIT SIE IN SOLCHEN STAATEN ODER LÄNDERN LEBEN, ENTFALTEN MÖGLICHERWEISE EINIGE AUSSCHLÜSSE ODER EINSCHRÄNKUNGEN DIESER EINGESCHRÄNKTEN GARANTIE GEGENÜBER IHNEN KEINE WIRKUNG. DIESE EINGESCHRÄNKTE GARANTIE GEWÄHRT IHNEN SPEZIFISCHE RECHTE. DARÜBER HINAUS STEHEN IHNEN MÖGLICHERWEISE NOCH WEITERE RECHTE ZU, DIE SICH JEDOCH VON STAAT ZU STAAT ODER VON LAND ZU LAND UNTERSCHIEDEN KÖNNEN. UM DEN UMFANG IHRER RECHTE ZU BESTIMMEN, WIRD IHNEN EMPFOHLEN, DIE ANWENDBAREN GESETZE DES JEWEILIGEN STAATES ODER LANDES ZU RATE ZU ZIEHEN.

Diese eingeschränkte Garantie ist auf Hardware-Produkte der Marke D-LINK (insgesamt im Folgenden: „D-LINK Hardware-Produkte“) anwendbar, die von D-LINK (Europe) Ltd. Oder dessen weltweiten Filialen, Tochtergesellschaften, Fachhändlern oder Länderdistributoren (insgesamt im Folgenden: „D-LINK“) mit dieser eingeschränkten Garantie verkauft wurden. Der Begriff „D-LINK Hardware-Produkte“ beinhaltet nur Hardwarekomponenten und deren

Bestandteile einschließlich Firmware. Der Begriff "D-LINK Hardware-Produkte" umfasst KEINE Software-Anwendungen oder -programme.

Räumlicher Geltungsbereich der eingeschränkten Garantie

Diese eingeschränkte Garantie gilt für alle genannten europäischen Staaten gemäß dem Anhang „Eingeschränkte Garantie von D-LINK in europäischen Staaten“. Im Rahmen dieser eingeschränkten Garantie sind mit dem Begriff „europäische Staaten“ nur die im Anhang genannten Staaten gemeint. Die eingeschränkte Garantie findet überall Anwendung, wo D-LINK oder dessen autorisierte Servicepartner Garantiedienste gemäß den Bestimmungen dieser eingeschränkten Garantie erbringen. Gleichwohl kann sich die Verfügbarkeit von Garantiediensten und die Bearbeitungszeit von Land zu Land unterscheiden und von Registrierungsanforderungen abhängig sein.

Einschränkung der Garantie

D-LINK gewährleistet, dass die nachstehend aufgeführten Produkte bei gewöhnlicher Verwendung für die unten angegebene Laufzeit der eingeschränkten Garantie („Garantielaufzeit“) frei von wesentlichen Verarbeitungs- und Materialfehlern sind. Voraussetzung hierfür ist jedoch, dass das Produkt entsprechend dem Benutzerhandbuch und den weiteren Dokumentationen, die der Benutzer beim Kauf (oder später) erhalten hat, genutzt und gewartet wird. D-LINK garantiert nicht, dass die Produkte störungs- oder fehlerfrei arbeiten oder dass alle Mängel, Fehler, Defekte oder Kompatibilitätsstörungen beseitigt werden können. Diese Garantie gilt nicht für Probleme wegen: (a) unerlaubter Veränderung oder Hinzufügung, (b) Fahrlässigkeit, Missbrauch oder Zweckentfremdung, einschließlich des Gebrauchs des Produkts entgegen den Spezifikationen oder den durch Schnittstellen gegebenen Vorgaben, (c) fehlerhafter Bedienung, (d) Versagen von Produkten oder Diensten, die nicht von D-LINK stammen oder nicht Gegenstand einer zum maßgeblichen Zeitpunkt gültigen Garantie- oder Wartungsvereinbarung sind, (e) Fehlgebrauch oder fehlerhafter Lagerung oder (f) Feuer, Wasser, höherer Gewalt oder anderer Katastrophen. Diese Garantie gilt ebenfalls nicht für Produkte, bei denen eine D-LINK-Seriennummer entfernt oder auf sonstige Weise unkenntlich gemacht wurde.

D-LINK STEHT NICHT FÜR SCHÄDEN EIN, DIE DADURCH ENTSTEHEN, DASS DIE ANLEITUNG FÜR DAS D-LINK HARDWARE-PRODUKT NICHT BEFOLGT WIRD.

Laufzeit der eingeschränkten Garantie

Die Laufzeit der eingeschränkten Garantie beginnt mit dem Zeitpunkt, zu dem das Produkt von D-LINK gekauft wurde. Als Nachweis für den Zeitpunkt des Kaufs gilt der datierte Kauf- oder Lieferbeleg. Es kann von Ihnen verlangt werden, dass Sie zur Inanspruchnahme von Garantiediensten den Kauf des Produkts nachweisen. Wenn Ihre Hardware-Produkte der Marke D-LINK innerhalb der Laufzeit der eingeschränkten Garantie eine Reparatur benötigen, so sind Sie berechtigt, gemäß den Bedingungen dieser eingeschränkten Garantie Garantiedienste in Anspruch zu nehmen.

Diese eingeschränkte Garantie gilt nur für denjenigen, der das D-LINK Hardware-Produkt ursprünglich als originärer Endbenutzer gekauft hat. Sie ist nicht auf Dritte übertragbar, die das D-LINK-Produkt von dem ursprünglichen originären Endbenutzer erworben haben.

Produkttyp	Gewährleistungslaufzeit
Verwaltete Switches (d. h. Switches mit eingebauten SNMP-Agents) (einschließlich Modulen und Verwaltungssoftware)	Fünf (5) Jahre
Alle weiteren Produkte	Zwei (2) Jahre
Ersatzteile (z.B. externe Netzteile, Lüfter)	Ein (1) Jahr

Die oben aufgeführten Garantielaufzeiten gelten für alle D-LINK-Produkte, die in europäischen Staaten ab dem 1. Januar 2004 von D-LINK oder einem autorisierten Fachhändler oder Distributor verkauft werden. Alle vor dem 1. Januar 2004 von D-LINK oder einem autorisierten Vertragshändler oder Distributor verkauften Produkte haben eine Gewährleistung von 5 Jahren; ausgenommen sind Netzteile, Lüfter und Zubehör, diese haben eine Garantie von 2 Jahren.

Die durch diesen Garantieschein festgelegte Garantielaufzeit tritt an die Stelle der im Benutzerhandbuch oder im Kaufvertrag für das jeweilige Produkt angegebenen Laufzeit. Sollten Sie das betreffende D-LINK-Produkt als Verbraucher erworben haben, so sei klargestellt, dass Ihre gesetzlichen Rechte hiervon unberührt bleiben.

Leistungsumfang der eingeschränkten Garantie

Bei Auftreten eines Produktfehlers besteht die einzige Verpflichtung von D-LINK darin, dem ursprünglichen Käufer das defekte Produkt kostenlos zu reparieren oder es auszutauschen. Voraussetzung hierfür ist, dass das Produkt während der Garantielaufzeit einem autorisierten D-LINK-Servicecenter übergeben wird. Reparatur oder Austausch werden von D-LINK durch ein autorisiertes D-LINK-Servicecenter durchgeführt. Bauteile oder Hardware-Produkte, die gemäß dieser eingeschränkten Garantie entfernt werden, gehen in das Eigentum von D-LINK über. Die verbliebene eingeschränkte Garantie des entfernten Teils oder Produkts wird auf das Ersatzteil oder -produkt übertragen. Das Austauschprodukt muss weder neu sein noch dem defekten Produkt ganz oder in Teilen entsprechen. D-LINK darf dieses nach eigenem Ermessen gegen ein entsprechendes wiederaufbereitetes Produkt austauschen, welches dem defekten Produkt im Wesentlichen entspricht (oder höherwertig ist). D-LINK kann verlangen, dass der Kauf des Produkts nachgewiesen wird.

DIE VORSTEHENDE GARANTIE WURDE IN DIE DEUTSCHE SPRACHE AUS DEM ENGLISCHEN ÜBERSETZT. BEI ABWEICHUNGEN ZWISCHEN DER ENGLISCHEN VERSION UND DER DEUTSCHEN ÜBERSETZUNG GELTEN DIE BESTIMMUNGEN DER ENGLISCHEN VERSION.

Garantiegeber

D-Link (Europe) Ltd.
4th Floor, Merit House
Edgware Road
Colindale
London NW9 5 AB

Vereinigtes Königreich
Telefon: +44-020-8731-5555
Fax: +44-020-8731-5511
www.dlink.co.uk

D-Link Europe a limité la garantie des produits

Conditions Générales

La Garantie Produit Limitée énoncée ci-dessous émane de D-LINK (Europe) Ltd. (ci-après « D-LINK »). Cette Garantie Produit Limitée n'est valable que sur présentation de la preuve d'achat. D-LINK peut également exiger la présentation du présent bon de garantie.

SAUF INDICATION EXPLICITE DES PRESENTES, D-LINK NE FOURNIT AUCUNE AUTRE GARANTIE, EXPLICITE OU IMPLICITE, Y COMPRIS UNE GARANTIE IMPLICITE DE VALEUR MARCHANDE OU D'ADAPTATION DU PRODUIT A UN USAGE PRECIS. D-LINK DECLINE EXPLICITEMENT TOUTE GARANTIE NON ENONCEE DANS LES PRESENTES. TOUTE GARANTIE IMPLICITE IMPOSEE PAR LA LOI, LE CAS ECHEANT, EST LIMITEE DANS SA DUREE A CELLE DE LA GARANTIE LIMITEE. CERTAINS ETATS OU PAYS NE PERMETTENT PAS DE LIMITER LA DUREE DE LA GARANTIE IMPLICITE OU INTERDISENT D'EXCLURE OU DE LIMITER LA COUVERTURE DES DOMMAGES DIRECTS OU INDIRECTS OCCASIONNES AUX PRODUITS GRAND PUBLIC. DANS LES ETATS OU PAYS EN QUESTION, CERTAINES EXCLUSIONS OU LIMITATIONS DE LA PRESENTE GARANTIE PEUVENT NE PAS S'APPLIQUER A VOTRE CAS. LA PRESENTE GARANTIE LIMITEE VOUS OCTROIE CERTAINS DROITS LEGAUX SPECIFIQUES. VOUS POUVEZ EGALEMENT BENEFICIER D'AUTRES DROITS VARIABLES D'UN ETAT OU D'UN PAYS A L'AUTRE. NOUS VOUS RECOMMANDONS DE CONSULTER LA LEGISLATION EN VIGUEUR DANS VOTRE LIEU DE RESIDENCE POUR CONNAITRE L'ETENDUE DE VOS DROITS.

La présente garantie limitée s'applique aux produits matériels commercialisés sous la marque D-LINK (collectivement ici « les Produits Matériels D-LINK ») vendus par D-LINK (Europe) Ltd., ses filiales, sociétés affiliées, revendeurs agréés ou distributeurs locaux à travers le monde (collectivement ici « D-LINK ») avec la présente garantie limitée. Le terme de « Produit Matériel D-LINK » se limite aux composants matériels et à l'ensemble de leurs composants internes, notamment le firmware. Le terme de « Produit Matériel D-LINK » N'englobe PAS les applications ou programmes logiciels.

Etendue géographique de la Garantie Produit Limitée

La présente Garantie Produit Limitée s'applique à tous les pays européens figurant dans l'annexe « Pays européens où s'applique la Garantie Produit Limitée D-LINK ». Le terme de « pays européens » utilisé dans la présente Garantie Produit Limitée D-LINK englobe uniquement les pays figurant dans la liste en annexe. La Garantie Produit Limitée sera honorée dans tout pays où D-LINK ou ses prestataires agréés proposent le service de garantie, sous réserve des modalités énoncées dans la présente Garantie Produit Limitée. Cependant, la disponibilité du service de garantie et les temps de réponse varient d'un pays à l'autre et peuvent également être assujettis à un enregistrement.

Limitation de la Garantie Produit

D-LINK garantit que les produits décrits ci-dessous, dans le cadre d'une utilisation normale, sont dénués de défauts conséquents, tant au niveau de leurs composants matériels que de leur fabrication, et ce pendant toute la Période de Garantie Produit Limitée indiquée ci-dessous (« Période de Garantie Produit Limitée »), sous réserve qu'ils soient utilisés et entretenus conformément au manuel utilisateur et aux autres documents remis au client lors de l'achat (ou amendés de temps à autre). D-LINK ne garantit pas le fonctionnement ininterrompu ou sans erreur de ses produits. D-LINK ne s'engage pas non plus à corriger tous les défauts, erreurs ou non conformités.

La présente garantie ne s'applique pas aux problèmes qui sont la conséquence : (a) d'altérations ou d'ajouts non autorisés ; (b) d'une négligence, d'un abus ou d'une mauvaise utilisation, notamment une utilisation du produit non conforme à ses spécifications ou aux interfaces requises ; (c) d'une mauvaise manipulation ; (d) d'une panne de biens ou de services acquis auprès d'une société tierce (non D-LINK) ou qui ne font pas l'objet d'un contrat D-LINK de garantie ou de maintenance en bonne et due forme ; (e) d'une mauvaise utilisation ou d'un rangement dans des conditions inadaptées ; ou (f) du feu, de l'eau, d'une catastrophe naturelle ou autre. La présente garantie ne s'applique pas non plus à un produit dont le numéro de série D-LINK aurait été retiré ou altéré de quelque manière que ce soit.

D-LINK N'EST NULLEMENT RESPONSABLE DE DOMMAGES RESULTANT DE VOTRE INOBSERVATION DES INSTRUCTIONS FOURNIES POUR L'UTILISATION DE SON PRODUIT MATERIEL.

Période de Garantie Produit Limitée

La Période de Garantie Produit Limitée court à compter de la date d'achat auprès de D-LINK. La date de votre reçu ou bon de livraison correspond à la date d'achat du produit et constitue la date de votre preuve d'achat. Il est possible que le service de garantie ne vous soit accordé que sur production de votre preuve d'achat. Vous avez droit à un service de garantie conforme aux modalités énoncées dans les présentes dès lors que votre matériel de marque D-LINK nécessite une réparation pendant la Période de Garantie Produit Limitée.

La présente Garantie Produit Limitée s'applique uniquement à l'acheteur utilisateur final initial du Produit Matériel D-LINK. Elle est non cessible à quiconque se procure le Produit Matériel D-LINK auprès de l'acheteur utilisateur final initial.

Type de produit	Période de Garantie
Switches gérés (Switches comportant un agent SNMP intégré)(y compris modules et logiciels de gestion)	Cinq (5) ans
Tous autres produits	Deux (2) ans
Pièces détachées (adaptateurs d'alimentation externes, ventilateurs)	Un (1) an

Les périodes de garantie indiquées ci-dessus s'appliquent à tous les produits D-LINK vendus depuis le 1er janvier 2004 dans les pays européens par D-LINK ou l'un de ses revendeurs ou distributeurs agréés. Tous les produits vendus avant le 1er janvier 2004 dans les pays européens par D-LINK ou l'un de ses revendeurs ou distributeurs agréés bénéficient d'une

garantie de 5 ans, excepté les fournitures électriques, ventilateurs et accessoires, qui sont couverts par une garantie de 2 ans.

La période de garantie indiquée sur ce bon annule et remplace celle qui figure dans le manuel utilisateur ou dans le contrat d'achat des produits considérés. Pour éviter le doute, si vous avez acheté votre produit D-LINK en tant que consommateur, vos droits légaux demeurent inchangés.

Exécution de la Garantie Produit Limitée

En cas de défaut ou d'erreur d'un produit, l'unique obligation de D-LINK se limite à la réparation ou au remplacement gratuit du produit défectueux, au bénéfice de l'acheteur initial, sous réserve que le produit soit rapporté à un Centre de Service Agréé D-LINK pendant la période de garantie. D-LINK assure la réparation ou le remplacement dans un Centre de Service Agréé D-LINK. Les composants, pièces ou produits retirés dans le cadre de cette garantie limitée deviennent propriété de D-LINK. La pièce ou le produit de remplacement est couvert par la garantie limitée de la pièce ou du produit d'origine pendant la période restante.

Le produit de remplacement n'est pas nécessairement neuf, ni d'une marque ou d'un modèle identique ; D-LINK peut décider, de manière discrétionnaire, de remplacer le produit défectueux (ou ses pièces) par un équivalent (ou un article supérieur) reconditionné ayant toutes les fonctionnalités du produit défectueux. D-LINK peut exiger la preuve d'achat.

Garant

D-Link (Europe) Ltd.
4th Floor, Merit House
Edgware Road
Colindale
London NW9 5 AB
Royaume-Uni
Tél : +44-020-8731-5555
Fax : +44-020-8731-5511
www.dlink.co.uk

Garantía limitada del producto D-LINK Europa

Condiciones generales

Esta garantía la ofrece D-LINK (Europe) Ltd. (en este documento, "D-LINK"). La garantía limitada del producto sólo es válida si se acompaña del comprobante de la compra. También deberá presentarse la tarjeta de garantía si D-LINK lo solicita.

EXCEPTO EN LO EXPRESAMENTE INDICADO EN ESTA GARANTÍA LIMITADA, D-LINK NO CONCEDE OTRAS GARANTÍAS, NI EXPLÍCITAS NI IMPLÍCITAS, INCLUIDAS LAS GARANTÍAS IMPLÍCITAS DE COMERCIALIDAD Y APTITUD A UN FIN DETERMINADO. D-LINK RECHAZA EXPLÍCITAMENTE CUALQUIER GARANTÍA QUE NO FIGURE EN ESTA GARANTÍA LIMITADA. LA DURACIÓN DE CUALQUIER GARANTÍA IMPLÍCITA QUE PUEDA SER IMPUESTA POR LEY QUEDA LIMITADA AL PERÍODO DE LA GARANTÍA LIMITADA. ALGUNOS ESTADOS O

PAÍSES NO PERMITEN QUE EN LA GARANTÍA LIMITADA DE PRODUCTOS DE CONSUMO SE RESTRINJA LA DURACIÓN TEMPORAL, NI QUE SE EXCLUYAN O LIMITEN LOS DAÑOS INCIDENTALES O RESULTANTES PARA EL CONSUMIDOR DE LOS PRODUCTOS. EN ESTOS ESTADOS O PAÍSES, A USTED NO LE PUEDEN APLICAR ALGUNAS EXCLUSIONES O LIMITACIONES DE LA GARANTÍA LIMITADA. ESTA GARANTÍA LIMITADA LE CONCEDE DETERMINADOS DERECHOS. PUEDE, TAMBIÉN, TENER OTROS DERECHOS, QUE PUEDEN SER DISTINTOS DE UN ESTADO A OTRO O DE UN PAÍS A OTRO. SE RECOMIENDA QUE CONSULTE LAS LEYES PERTINENTES DE UN ESTADO O PAÍS A FIN DE QUE CONOZCA SUS DERECHOS.

Esta garantía limitada se aplica a los productos de hardware de la marca D-LINK (llamados en esta guía “Productos de hardware D-LINK”) comprados a D-LINK (Europe) Ltd., a sus filiales en el mundo, a sus proveedores autorizados o a sus distribuidores locales (llamados en este documento “D-LINK”) con esta garantía limitada. El término “producto de hardware D-LINK” se restringe a los componentes de hardware y a los componentes internos de estos, incluyendo el firmware. El término “producto de hardware D-LINK” NO incluye ni las aplicaciones ni los programas de software.

Cobertura geográfica de la garantía limitada del producto

Esta garantía limitada del producto es válida en todos los países europeos que figuran en el apéndice “Países europeos de la garantía limitada del producto D-LINK”. En esta garantía limitada del producto D-Link, el término “países europeos” sólo incluye los países que figuran en el apéndice. La garantía limitada del producto será válida en cualquier país en el que D-LINK o sus proveedores autorizados de servicios ofrezcan un servicio de garantía sujeto a los términos y condiciones recogidos en esta garantía limitada del producto. Sin embargo, la disponibilidad del servicio de garantía, así como el tiempo de respuesta, pueden variar de un país a otro y pueden estar sujetos a requisitos de registro.

Limitación de la garantía del producto

D-LINK garantiza que los productos descritos más adelante están libres de defectos de fabricación y materiales, en condiciones normales de uso, a lo largo del período de la garantía limitada del producto que se indica en este documento (“período de la garantía limitada del producto”), si el producto se ha utilizado y mantenido conforme a lo recogido en el manual del usuario o en otra documentación que se haya proporcionado al comprador en el momento de la compra (o que se haya corregido). D-LINK no garantiza que los productos funcionarán sin interrupciones o sin errores, ni que se corregirán todas las deficiencias, errores, defectos o disconformidades.

Esta garantía no cubre problemas derivados de: (a) modificaciones o conexiones no autorizadas; (b) negligencia, abuso o mal uso, incluyendo el incumplimiento de las especificaciones y de los requisitos de la interfaz en el funcionamiento del producto; (c) manejo incorrecto; (d) errores en artículos o servicios ajenos a D-LINK o no sujetos a una garantía o un contrato de mantenimiento vigentes de D-LINK; (e) uso o almacenamiento incorrecto; o (f) fuego, agua, casos fortuitos u otros hechos catastróficos. Esta garantía tampoco es válida para aquellos productos a los que se haya eliminado o alterado de algún modo el número de serie D-LINK.

D-LINK NO SE RESPONSABILIZA DE LOS DAÑOS CAUSADOS COMO CONSECUENCIA DEL INCUMPLIMIENTO DE LAS INSTRUCCIONES DEL PRODUCTO DE HARDWARE D-LINK.

Período de la garantía limitada del producto

El período de la garantía limitada del producto se inicia en la fecha en que se realizó la compra a D-LINK. Para el comprador, el comprobante de la fecha de la compra es el recibo de la venta o de la entrega, en el que figura la fecha de la compra del producto. Puede ser necesario tener que presentar el comprobante de la compra a fin de que se preste el servicio de garantía. El comprador tiene derecho al servicio de garantía conforme a los términos y condiciones de este documento, si requiere una reparación del hardware de la marca D-LINK dentro del período de garantía limitada del producto.

Esta garantía limitada del producto cubre sólo al originario comprador-usuario final de este producto de hardware D-LINK, y no es transferible a otras personas que reciban el producto de hardware D-LINK del originario comprador-usuario final.

Estos períodos de garantía están en vigor para todos los productos D-LINK que hayan sido comprados en países europeos a D-LINK o a alguno de sus proveedores o distribuidores autorizados a partir del 1 de enero del 2004. Todos los productos comprados en países europeos a D-LINK o a uno de sus proveedores o distribuidores autorizados antes del 1 de enero del 2004 cuentan con 5 años de garantía, excepto las fuentes de alimentación, los ventiladores y los accesorios, que cuentan con 2 años de garantía.

Tipo de producto	Período de garantía del producto
Conmutadores gestionados (p. ej., conmutadores con agente SNMP integrado) (incluyendo módulos y software de gestion)	Cinco (5) años
Resto de productos	Dos (2) años
Piezas de repuesto (p. ej., adaptadores de alimentacion externos, ventiladores)	Un (1) año

El período de garantía que figura en esta tarjeta sustituye y reemplaza al período de garantía que consta en el manual del usuario o en el contrato de compra de los productos correspondientes. Para evitar dudas: si usted ha comprado el producto D-LINK correspondiente como consumidor, sus derechos legales no se ven afectados.

Uso de la garantía limitada del producto

Si un producto presenta algún defecto, la obligación exclusiva de D-LINK será reparar o reemplazar, sin coste alguno para el comprador originario, cualquier producto defectuoso siempre y cuando éste sea entregado en un centro autorizado de servicio D-LINK durante el período de garantía. D-LINK realizará la reparación o sustitución para un centro autorizado de servicio D-LINK. Todos los productos de hardware o componentes que se eliminen bajo esta garantía limitada serán propiedad de D-LINK. La parte o el producto de repuesto adquiere, para el resto de la garantía limitada, el estatus de parte o producto eliminado. El producto de repuesto no ha de ser nuevo o de la misma marca, modelo o parte; D-LINK puede sustituir a discreción el producto defectuoso (o cualquier parte) con un producto equivalente

recondicionado (o superior) en cualquier material respecto al producto defectuoso. D-LINK puede pedir el comprobante de compra.

Garante

D-Link (Europe) Ltd.
4th Floor, Merit House
Edgware Road
Colindale
London NW9 5 AB
United Kingdom
Teléfono: +44-020-8731-5555
Fax: +44-020-8731-5511
www.dlink.co.uk

D-Link Europe Termini di Garanzia dei Prodotti

Generalità

La presente Garanzia viene fornita da D-LINK (Europe) Ltd. (di seguito denominata "DLINK"). Essa viene riconosciuta solo se accompagnata dalla prova di acquisto. D-LINK può richiedere anche l'esibizione della presente cartolina di garanzia.

SALVO QUANTO ESPRESSAMENTE STABILITO NELLA PRESENTE GARANZIA LIMITATA, D-LINK NON FORNISCE NESSUN'ALTRA GARANZIA NE' ESPRESSA NE' IMPLICITA, COMPRESE EVENTUALI GARANZIE DI COMMERCIALIZZABILITÀ O DI IDONEITÀ PER UN PARTICOLARE SCOPO. D-LINK NEGA ESPRESSAMENTE QUALUNQUE ALTRA GARANZIA CHE NON RIENTRI NELLA PRESENTE GARANZIA LIMITATA. QUALSIASI GARANZIA IMPLICITA, CHE DOVESSE ESSERE IMPOSTA PER LEGGE, SARÀ CIRCOSCRITTA ALLA DURATA DELLA PRESENTE GARANZIA. ALCUNI PAESI VIETANO QUALSIASI LIMITAZIONE DEL PERIODO DI VALIDITÀ DELLE GARANZIE IMPLICITE OPPURE L'ESCLUSIONE O LA LIMITAZIONE DEI DANNI INCIDENTALI O CONSEGUENZIALI PER I PRODOTTI. IN TALI PAESI, EVENTUALI ESCLUSIONI O LIMITAZIONI DELLA PRESENTE GARANZIA NON POTRANNO APPLICARSI AL VOSTRO CASO. LA PRESENTE GARANZIA VI CONFERISCE DIRITTI LEGALI SPECIFICI. INOLTRE POTRETE GODERE DI ULTERIORI DIRITTI CHE POSSONO VARIARE A SECONDA DEL PAESE. SIETE INVITATI A CONSULTARE LE LEGGI APPLICABILI DEL VOSTRO PAESE AL FINE DI DETERMINARE CON PRECISIONE I VOSTRI DIRITTI.

La presente garanzia trova applicazione su tutti i prodotti hardware recanti il marchio D-LINK (di seguito denominati collettivamente "Prodotti hardware D-LINK") venduti da D-LINK (Europe) Ltd., dalle sue controllate, dalle sue affiliate, dai rivenditori autorizzati o dai distributori nazionali (di seguito denominati collettivamente "D-LINK"), accompagnati dalla presente garanzia limitata. Il termine "Prodotto hardware D-LINK" si riferisce esclusivamente ai componenti hardware e a tutte le parti interne compreso il firmware. Il termine "Prodotto hardware D-LINK" NON comprende eventuali applicazioni o programmi software.

Ambito geografico della Garanzia limitata

La presente Garanzia è estesa a tutti i Paesi europei elencati nell'appendice "Paesi europei - Garanzia limitata dei prodotti D-LINK". Il termine "Paesi europei" si riferisce esclusivamente ai paesi nominati in questa appendice. La Garanzia verrà riconosciuta in tutti i paesi nei quali D-LINK o i suoi Centri di Assistenza autorizzati offrono assistenza conformemente alle condizioni e ai termini stabiliti nella presente Garanzia. Tuttavia, la disponibilità all'assistenza e i tempi di intervento variano da paese a paese e possono essere soggetti a eventuali requisiti di registrazione.

Limitazione della Garanzia

D-LINK garantisce che i prodotti sotto descritti in condizioni di normale utilizzo non presentano difetti di fabbricazione o vizi di materiale durante il Periodo di garanzia sotto specificato ("Periodo di garanzia"), a condizione che vengano utilizzati e sottoposti a manutenzione in conformità con il manuale d'uso e con ogni altra documentazione fornita all'acquirente all'atto dell'acquisto (e relativi emendamenti). D-LINK non garantisce che il funzionamento del prodotto sarà ininterrotto o esente da errori né tanto meno che tutti gli eventuali errori, carenze, difetti o non conformità potranno essere corretti.

La presente garanzia non copre eventuali problemi derivanti da: (a) alterazioni o aggiunte non autorizzate; (b) negligenza, abuso o utilizzo improprio, compresa l'incapacità di far funzionare il prodotto in conformità con le specifiche e i requisiti di connessione; (c) movimentazione impropria; (d) guasto di prodotti o servizi non forniti da D-LINK o non soggetti a una garanzia successiva di D-LINK o a un accordo di manutenzione; (e) impiego o conservazione impropri; (f) incendio, inondazione, cause di forza maggiore o altro evento catastrofico accidentale. La presente garanzia non si applica altresì ad alcun prodotto particolare qualora il numero di serie di D-LINK sia stato rimosso o reso illeggibile in altro modo.

D-LINK DECLINA OGNI RESPONSABILITÀ PER EVENTUALI DANNI RISULTANTI DAL MANCATO RISPETTO DELLE ISTRUZIONI RELATIVE AL PRODOTTO HARDWARE D-LINK.

Periodo di garanzia

Il Periodo di garanzia ha decorrenza dalla data dell'acquisto presso D-LINK. Prova della data di acquisto è il documento fiscale (scontrino fiscale o ricevuta) recante la data di acquisto del prodotto. Per avere diritto alla garanzia può esserVi richiesto di esibire la prova di acquisto. Potete beneficiare delle prestazioni di assistenza previste dalla garanzia in conformità con i termini e le condizioni di cui sotto nel momento in cui il Vostro prodotto hardware D-LINK necessita di una riparazione durante il Periodo di garanzia.

La presente Garanzia si applica esclusivamente al primo acquirente del Prodotto hardware D-LINK e non può essere trasferita a terzi che abbiano ottenuto la proprietà del Prodotto hardware D-LINK dal primo acquirente.

Tipo de producto	Período de garantía del producto
Switch (solo Switch dotati di agente SNMP incorporato) (inclusi moduli esoftware di gestione)	5 (cinque) anni

Tipo de producto	Período de garantía del producto
Tutti gli altri prodotti	2 (due) anni
Pezzi di ricambio (es. adattatori esterni di potenza, alimentatori esterni, ventole)	1 (Un) anno

Il periodo di garanzia sopra specificato relativamente a tutti i prodotti D-LINK venduti nei Paesi europei da D-LINK o da qualsiasi suo rivenditore o distributore autorizzato decorre dal 1 gennaio 2004. Tutti i prodotti venduti nei Paesi europei da D-LINK o da uno qualsiasi dei suoi rivenditori o distributori autorizzati prima del 1 gennaio 2004 sono coperti da una garanzia di 5 anni fatto salvo per alimentatori, ventole e accessori che hanno 2 anni di garanzia.

Il periodo di garanzia qui menzionato sostituisce qualsiasi altro periodo di garanzia definito nel manuale d'uso o nel contratto di acquisto del prodotto. Se avete acquistato un prodotto D-LINK in qualità di consumatore i Vostri diritti rimangono invariati.

Prestazioni della Garanzia limitata

Qualora comparisse un difetto o una non conformità, D-LINK avrà l'unico obbligo di riparare o sostituire il prodotto non conforme senza alcun costo per l'acquirente a condizione che il prodotto venga restituito a un Centro di Assistenza autorizzato D-LINK entro il periodo di garanzia. La riparazione o la sostituzione verranno eseguite da D-LINK presso un Centro di Assistenza autorizzato D-LINK. Tutti i componenti o i prodotti hardware rimossi conformemente ai termini e alle condizioni della presente garanzia divengono di proprietà di D-LINK. Il pezzo o il prodotto in sostituzione beneficerà della garanzia per il tempo residuo della parte o del prodotto originale. Il prodotto in sostituzione non deve necessariamente essere nuovo o di identica fattura, modello o composizione; D-LINK può a sua discrezione sostituire il prodotto non conforme (o qualsiasi parte di esso) con un prodotto che risulti essere equivalente (o di valore superiore) al prodotto non conforme. D-LINK può richiedere che venga esibita la prova di acquisto.

Garante

D-Link (Europe) Ltd.
 4th Floor, Merit House
 Edgware Road
 Colindale
 Londra NW9 5 AB
 Regno Unito
 Telefono: +44-020-8731-5555
 Fax: +44-020-8731-5511
www.dlink.co.uk

Technical Support

Technical Support

You can find software updates and user documentation on the D-Link website.

D-Link provides free technical support for customers within the United States and within Canada for the duration of the warranty period on this product.

U.S. and Canadian customers can contact D-Link technical support through our website, or by phone.

Tech Support for customers within the United States:

D-Link Technical Support over the Telephone:

(888) 843-6100

Hours of Operation: 8:00AM to 6:00PM PST

D-Link Technical Support over the Internet:

<http://support.dlink.com>

email: support@dlink.com

Tech Support for customers within Canada:

D-Link Technical Support over the Telephone:

(800) 361-5265

Monday to Friday 7:30am to 12:00am EST

D-Link Technical Support over the Internet:

<http://support.dlink.ca>

email: support@dlink.ca

Technical Support

You can find software updates and user documentation on the D-Link websites.

If you require product support, we encourage you to browse our FAQ section on the Web Site before contacting the Support line. We have many FAQ's which we hope will provide you a speedy resolution for your problem.

For Customers within The United Kingdom & Ireland:

D-Link UK & Ireland Technical Support over the Internet:

<http://www.dlink.co.uk>

<ftp://ftp.dlink.co.uk>

D-Link UK & Ireland Technical Support over the Telephone:

08456 12 0003 (United Kingdom)

+1890 886 899 (Ireland)

Lines Open

8.00am-10.00pm Mon-Fri

10.00am-7.00pm Sat & Sun

For Customers within Canada:

D-Link Canada Technical Support over the Telephone:

1-800-361-5265 (Canada)

Mon. to Fri. 7:30AM to 9:00PM EST

D-Link Canada Technical Support over the Internet:

<http://support.dlink.ca>

email: support@dlink.ca



Technische Unterstützung

Aktualisierte Versionen von Software und Benutzerhandbuch finden Sie auf der Website von D-Link.

D-Link bietet kostenfreie technische Unterstützung für Kunden innerhalb Deutschlands, Österreichs, der Schweiz und Osteuropas.

Unsere Kunden können technische Unterstützung über unsere Website, per E-Mail oder telefonisch anfordern.

Web: <http://www.dlink.de>

E-Mail: support@dlink.de

Telefon: +49 (1805)2787

0,12€/Min aus dem Festnetz der Deutschen Telekom.

Telefonische technische Unterstützung erhalten Sie Montags bis Freitags von 09.00 bis 17.30 Uhr.

Unterstützung erhalten Sie auch bei der Premiumhotline für D-Link Produkte unter der Rufnummer 09001-475767

Montag bis Freitag von 6-22 Uhr und am Wochenende von 11-18 Uhr.
1,75€/Min aus dem Festnetz der Deutschen Telekom.

Wenn Sie Kunde von D-Link außerhalb Deutschlands, Österreichs, der Schweiz und Osteuropas sind, wenden Sie sich bitte an die zuständige Niederlassung aus der Liste im Benutzerhandbuch.

D-Link[®]
Building Networks for People

Assistance technique

Vous trouverez la documentation et les logiciels les plus récents sur le site web **D-Link**.

Vous pouvez contacter le service technique de **D-Link** par notre site internet ou par téléphone.

Support technique destiné aux clients établis en France:

Assistance technique D-Link par téléphone :

0820 0803 03

N° INDIGO - 0,12€ TTC/min*

*Prix en France Métropolitaine au 3 mars 2005

Du lundi au samedi – de 9h00 à 19h00

Assistance technique D-Link sur internet :

<http://www.dlink.fr>

e-mail : support@dlink.fr

Support technique destiné aux clients établis au Canada :

Assistance technique D-Link par téléphone :

(800) 361-5265

Lun.-Ven. 7h30 à 21h00 HNE.

Assistance technique D-Link sur internet :

<http://support.dlink.ca>

e-mail : support@dlink.ca

D-Link[®]
Building Networks for People

Asistencia Técnica

Puede encontrar las últimas versiones de software así como documentación técnica en el sitio web de **D-Link**.

D-Link ofrece asistencia técnica gratuita para clientes residentes en España durante el periodo de garantía del producto.

Asistencia Técnica de D-Link por teléfono:

+34 902 30 45 45

Lunes a Viernes de 9:00 a 14:00 y de 15:00 a 18:00

Asistencia Técnica de D-Link a través de Internet:

<http://www.dlink.es/support/>

e-mail: soporte@dlink.es



Supporto tecnico

Gli ultimi aggiornamenti e la documentazione sono disponibili sul sito D-Link.

Supporto tecnico per i clienti residenti in Italia

D-Link Mediterraneo S.r.L.

Via N. Bonnet 6/B 20154 Milano

Supporto Tecnico dal lunedì al venerdì dalle ore
9.00 alle ore 19.00 con orario continuato
Telefono: 02-39607160

URL : <http://www.dlink.it/supporto.html>
Email: tech@dlink.it

D-Link[®]
Building Networks for People

Technical Support

You can find software updates and user documentation on the D-Link website.

D-Link provides free technical support for customers within Benelux for the duration of the warranty period on this product.

Benelux customers can contact D-Link technical support through our website, or by phone.

Tech Support for customers within the Netherlands:

D-Link Technical Support over the Telephone:

0900 501 2007

Monday to Friday 9:00 am to 10:00 pm

D-Link Technical Support over the Internet:

www.dlink.nl

Tech Support for customers within Belgium:

D-Link Technical Support over the Telephone:

070 66 06 40

Monday to Friday 9:00 am to 10:00 pm

D-Link Technical Support over the Internet:

www.dlink.be

Tech Support for customers within Luxemburg:

D-Link Technical Support over the Telephone:

+32 70 66 06 40

Monday to Friday 9:00 am to 10:00 pm

D-Link Technical Support over the Internet:

www.dlink.be



Pomoc techniczna

Najnowsze wersje oprogramowania i dokumentacji użytkownika można znaleźć w serwisie internetowym firmy D-Link.

D-Link zapewnia bezpłatną pomoc techniczną klientom w Polsce w okresie gwarancyjnym produktu.

Klienci z Polski mogą się kontaktować z działem pomocy technicznej firmy D-Link za pośrednictwem Internetu lub telefonicznie.

Telefoniczna pomoc techniczna firmy D-Link:

(+48 12) 25-44-000

Pomoc techniczna firmy D-Link świadczona przez Internet:

URL: <http://www.dlink.pl>

e-mail: dlink@fixit.pl



Technická podpora

Aktualizované verze software a uživatelských příruček najdete na webové stránce firmy D-Link.

D-Link poskytuje svým zákazníkům bezplatnou technickou podporu

Zákazníci mohou kontaktovat oddělení technické podpory přes webové stránky, mailem nebo telefonicky

Web: <http://www.dlink.cz/support/>

E-mail: support@dlink.cz

Telefon: 224 247 503

Telefonická podpora je v provozu:
PO- PÁ od 09.00 do 17.00

D-Link[®]
Building Networks for People

Technikai Támogatás

Meghajtó programokat és frissítéseket a **D-Link** Magyarország weblapjáról tölthet le.
Telefonon technikai segítséget munkanapokon hétfőtől-csütörtökig 9.00 – 16.00 óráig és pénteken 9.00 – 14.00 óráig kérhet a **(1) 461-3001** telefonszámon vagy a support@dlink.hu emailcímen.

Magyarországi technikai támogatás :

D-Link Magyarország

1074 Budapest, Alsóerdősor u. 6. – R70 Irodaház 1 em.

Tel. : 06 1 461-3001

Fax : 06 1 461-3004

email : support@dlink.hu

URL : <http://www.dlink.hu>

D-Link[®]
Building Networks for People

Teknisk Support

Du kan finne programvare oppdateringer og bruker dokumentasjon på D-Links web sider.

D-Link tilbyr sine kunder gratis teknisk support under produktets garantitid.

Kunder kan kontakte D-Links teknisk support via våre hjemmesider, eller på tlf.

Teknisk Support:

D-Link Teknisk telefon Support:

800 10 610
(Hverdager 08:00-20:00)

D-Link Teknisk Support over Internett:

<http://www.dlink.no>

D-Link[®]
Building Networks for People

Teknisk Support

Du finder software opdateringer og bruger-dokumentation på D-Link's hjemmeside.

D-Link tilbyder gratis teknisk support til kunder i Danmark i hele produktets garantiperiode.

Danske kunder kan kontakte D-Link's tekniske support via vores hjemmeside eller telefonisk.

D-Link teknisk support over telefonen:

Tlf. 7026 9040

Hverdager: kl. 08:00 – 20:00

D-Link teknisk support på Internettet:

<http://www.dlink.dk>



Teknistä tukea asiakkaille Suomessa:

D-Link tarjoaa teknistä tukea asiakkailleen.
Tuotteen takuun voimassaoloajan.
Tekninen tuki palvelee seuraavasti:

Arkisin klo. 9 - 21
numerosta
0800-114 677

Internetin kautta
Ajurit ja lisätietoja tuotteista.
<http://www.dlink.fi>

Sähköpostin kautta
voit myös tehdä kyselyitä.

D-Link[®]
Building Networks for People

Teknisk Support

På vår hemsida kan du hitta mer information om mjukvaru uppdateringar och annan användarinformation.

D-Link tillhandahåller teknisk support till kunder i Sverige under hela garantitiden för denna produkt.

Teknisk Support för kunder i Sverige:

D-Link Teknisk Support via telefon:

0770-33 00 35

Vardagar 08.00-20.00

D-Link Teknisk Support via Internet:

<http://www.dlink.se>



Technical Support

You can find software updates and user documentation on the D-Link website.

Tech Support for customers within Australia:

D-Link Technical Support over the Telephone:

1300-766-868

Monday to Friday 8:00am to 8:00pm EST

Saturday 9:00am to 1:00pm EST

D-Link Technical Support over the Internet:

<http://www.dlink.com.au>

email: support@dlink.com.au

Tech Support for customers within New Zealand:

D-Link Technical Support over the Telephone:

0800-900-900

Monday to Friday 8:30am to 8:30pm

Saturday 9:00am to 5:00pm

D-Link Technical Support over the Internet:

<http://www.dlink.co.nz>

email: support@dlink.co.nz

D-Link®
Building Networks for People



Suporte Técnico

Você pode encontrar atualizações de software e documentação de utilizador no site de D-Link Portugal <http://www.dlink.pt>.

A D-Link fornece suporte técnico gratuito para clientes no Portugal durante o período de vigência de garantia deste produto.

Suporte Técnico para clientes no Portugal:

Assistência Técnica:

Email: soporte@dlink.es

http: www.dlink.pt/support/

ftp: <ftp://ftp.dlink.es>



Τεχνική Υποστήριξη

Μπορείτε να βρείτε software updates και πληροφορίες για τη χρήση των προϊόντων στις ιστοσελίδες της D-Link

Η D-Link προσφέρει στους πελάτες της δωρεάν υποστήριξη στον Ελλαδικό χώρο

Μπορείτε να επικοινωνείτε με το τμήμα τεχνικής υποστήριξης μέσω της ιστοσελίδας ή μέσω τηλεφώνου

Για πελάτες εντός του Ελλαδικού χώρου:

Τηλεφωνική υποστήριξη D-Link :

Τηλ: 210 86 11 114

Φαξ: 210 86 53 172

(Δευτέρα-Παρασκευή 09:00-17:00)

e-mail: support@dlink.gr

Τεχνική υποστήριξη D-Link μέσω Internet:

<http://www.dlink.gr>

<ftp://ftp.dlink.it>

D-Link®
Building Networks for People

Technical Support

You can find software updates and user documentation on the D-Link website.

Tech Support for customers within South Eastern Asia and Korea:

D-Link South Eastern Asia and Korea Technical Support over the Telephone:

+65-6895-5355

Monday to Friday 9:00am to 12:30pm, 2:00pm-6:00pm
Singapore Time

D-Link Technical Support over the Internet:

email: support@dlink.com.sg



Technical Support

You can find software updates and user documentation on the D-Link website.

Tech Support for customers within India

D-Link Technical Support over the Telephone:

+91-22-26526741

+91-22-26526696 –ext 161 to 167

Monday to Friday 9:30AM to 7:00PM

D-Link Technical Support over the Internet:

<http://www.dlink.co.in>

<http://www.dlink.co.in/dlink/drivers/support.asp>

<ftp://support.dlink.co.in>

email: techsupport@dlink.co.in



Technical Support

You can find software updates and user documentation on the D-Link website.

D-Link provides free technical support for customers for the duration of the warranty period on this product.

Customers can contact D-Link technical support through our web site or by phone.

Tech Support for customers within the Russia

D-Link Technical Support over the Telephone:

(495) 744-00-99

Monday to Friday 10:00am to 6:30pm

D-Link Technical Support over the Internet

<http://www.dlink.ru>

email: support@dlink.ru



Technical Support

You can find software updates and user documentation on the D-Link website.

Tech Support for customers within the U.A.E & North Africa:

D-Link Technical Support over the Telephone:

(971) 4-391-6480 (U.A.E)

Sunday to Wednesday 9:00am to 6:00pm GMT+4

Thursday 9:00am to 1:00pm GMT+4

D-Link Middle East & North Africa

D-Link Technical Support over the Internet:

<http://support.dlink-me.com>

email: support@dlink-me.com

Tech Support for customers within Israel:

D-Link Technical Support over the Telephone:

(972) 9-9715701

Sunday to Thursday 9:00am to 5:00pm

D-Link Technical Support over the Internet:

<http://www.dlink.co.il/support/>

e-mail: support@dlink.co.il

Tech Support for customers within Turkey:

D-Link Technical Support over the Telephone:

0090 312 473 40 55

Monday to Friday 9:00am to 6:00pm

D-Link Technical Support over the Internet:

<http://www.dlink.com.tr>

e-mail: turkiye@dlink-me.com

Tech Support for customers within Egypt:

D-Link Technical Support over the Telephone:

+202-2919035, +202-2919047

Sunday to Thursday 9:00am to 5:00pm

D-Link Technical Support over the Internet:

<http://support.dlink-me.com>

e-mail: amostafa@dlink-me.com

D-Link®
Building Networks for People

Technical Support

You can find software updates and user documentation on the D-Link website.

Tech Support for customers within South Africa and Sub Sahara Region:

D-Link South Africa and Sub Sahara Technical Support over the Telephone:

+27-12-665-2165

08600 DLINK (For South Africa only)

Monday to Friday 8:30am to 9:00pm South Africa Time

D-Link Technical Support over the Internet:

<http://www.d-link.co.za>

[email:support@d-link.co.za](mailto:support@d-link.co.za)



Technical Support

You can find updates and user documentation on the D-Link website

Tech Support for Latin America customers:

D-Link Technical Support over the followings Telephones:

Argentina: 0800-666 1442	Monday to Friday 09:00am to 22:00pm
Chile: 800-214 422	Monday to Friday 08:00am to 21:00pm
Colombia: 01800-700 1588	Monday to Friday 07:00am to 20:00pm
Ecuador: 1800-777 711	Monday to Friday 07:00am to 20:00pm
El Salvador: 800-6137	Monday to Friday 06:00am to 19:00pm
Guatemala: 1800-300 0017	Monday to Friday 06:00am to 19:00pm
Panama: 0800-560 0193	Monday to Friday 07:00am to 20:00pm
Peru: 0800-52049	Monday to Friday 07:00am to 20:00pm
Venezuela: 0800-100 3470	Monday to Friday 08:00am to 21:00pm

D-Link Technical Support over the Internet:

www.dlinkla.com
www.dlinklatinamerica.com
email:support@dlink.cl

Tech Support for customers within Brazil:

D-Link Technical Support over the Telephone:

0800-7014104
Monday to Friday 8:30am to 18:30pm

D-Link Technical Support over the Internet:

www.dlinkbrasil.com.br
email:suporte@dlinkbrasil.com.br

D-Link[®]
Building Networks for People

Техническая поддержка

Обновления программного обеспечения и документация доступны на Интернет-сайте D-Link.

D-Link предоставляет бесплатную поддержку для клиентов в течение гарантийного срока.

Клиенты могут обратиться в группу технической поддержки D-Link по телефону или через Интернет.

Техническая поддержка D-Link:
(495) 744-00-99

Техническая поддержка через Интернет
<http://www.dlink.ru>
email: support@dlink.ru



Asistencia Técnica

D-Link Latin América pone a disposición de sus clientes, especificaciones, documentación y software mas reciente a través de nuestro Sitio Web **www.dlinkla.com**

El servicio de soporte técnico tiene presencia en numerosos países de la Región Latino América, y presta asistencia gratuita a todos los clientes de D-Link, en forma telefónica e internet, a través de la casilla **soporte@dlinkla.com**

Soporte Técnico Help Desk Argentina:

Teléfono: 0800-6661442 Lunes a Viernes 09:00 am a 22:00 pm

Soporte Técnico Help Desk Chile:

Teléfono: 800 8 35465 Lunes a Viernes 08:00 am a 21:00 pm

Soporte Técnico Help Desk Colombia:

Teléfono: 01800-7001588 Lunes a Viernes 07:00 am a 20:00 pm

Soporte Técnico Help Desk Ecuador:

Teléfono: 1800-777 711 Lunes a Viernes 07:00 am a 20:00 pm

Soporte Técnico Help Desk El Salvador:

Teléfono: 800-6137 Lunes a Viernes 06:00 am a 19:00 pm

Soporte Técnico Help Desk Guatemala:

Teléfono: 1800-300 0017 Lunes a Viernes 06:00 am a 19:00 pm

Soporte Técnico Help Desk Panamá:

Teléfono: 0800-560 0193 Lunes a Viernes 07:00 am a 20:00 pm

Soporte Técnico Help Desk Perú:

Teléfono: 0800-52049 Lunes a Viernes 07:00 am a 20:00 pm

Soporte Técnico Help Desk Venezuela:

Teléfono: 0800-1003470 Lunes a Viernes 08:00 am a 21:00 pm



Suporte Técnico

Você pode encontrar atualizações de software e documentação de usuário no site da D-Link Brasil www.dlinkbrasil.com.br.

A D-Link fornece suporte técnico gratuito para clientes no Brasil durante o período de vigência da garantia deste produto.

Suporte Técnico para clientes no Brasil:

Telefone

São Paulo (11) 2185-9301

Segunda à sexta

Das 8h30 às 18h30

Demais Regiões do Brasil 0800 70 24 104

E-mail:

[email:suporte@dlinkbrasil.com.br](mailto:suporte@dlinkbrasil.com.br)



技术支持

办公地址：北京市朝阳区建国路71号惠通时代广场C1座
202室 邮编：100025

技术支持中心电话：8008296688/(028) 66052968

技术支持中心传真：(028)85176948

维修中心地址：北京市朝阳区建国路71号惠通时代广场C1
座202室 邮编：100025

维修中心电话：(010) 58635800

维修中心传真：(010) 58635799

网址：<http://www.dlink.com.cn>

办公时间：周一到周五，早09:00到晚18:00



友冠技術支援

台灣地區用戶可以透過我們的網站，電子郵件或電話與友冠資訊技術支援人員聯絡。

支援服務時間從
週一到週五，上午8:30 a.m. 到 7:00 p.m

Web: <http://www.dlinktw.com.tw/>
FAQ: <http://www.dlinktw.com.tw/suppFaq.asp>
Email: dssqa_service@dlinktw.com.tw

Phone: 0800-002-615

如果您是台灣地區以外的用戶，請參考使用手冊中記載的D-Link 全球各地分公司的聯絡資訊取得支援服務。

產品維修與保固相關資訊，請參考友冠資訊網頁說明：
<http://www.dlinktw.com.tw/suppFaq.asp>



International Offices

U.S.A

17595 Mt. Herrmann Street
Fountain Valley, CA 92708
TEL: 1-800-326-1688
URL: www.dlink.com

Canada

2180 Winston Park Drive
Oakville, Ontario, L6H 5W1
Canada
TEL: 1-905-8295033
FAX: 1-905-8295223
URL: www.dlink.ca

Europe (U. K.)

4th Floor, Merit House
Edgware Road, Colindale
London NW9 5AB
U.K.
TEL: +44-20-8955-9000
FAX: +44-20-8955-9001
URL: www.dlink.co.uk

Germany

Schwalbacher Strasse 74
D-65760 Eschborn
Germany
TEL: 49-6196-77990
FAX: 49-6196-7799300
URL: www.dlink.de

France

41 boulevard Vauban
78280 Guyancourt
France
TEL: 33-1-30238688
FAX: 33-1-30238689
URL: www.dlink.fr

Netherlands

Weena 290
3012 NJ, Rotterdam
Netherlands
Tel: +31-10-282-1445
Fax: +31-10-282-1331
URL: www.dlink.nl

Belgium

Rue des Colonies 11
B-1000 Brussels
Belgium
Tel: +32(0)2 517 7111
Fax: +32(0)2 517 6500
URL: www.dlink.be

Italy

Via Nino Bonnet n. 6/b
20154 ñ Milano
Italy
TEL: 39-02-2900-0676
FAX: 39-02-2900-1723
URL: www.dlink.it

Sweden

P.O. Box 15036, S-167 15 Bromma
Sweden
TEL: 46-(0)8564-61900
FAX: 46-(0)8564-61901
URL: www.dlink.se

Denmark

Naverland 2, DK-2600
Glostrup, Copenhagen
Denmark
TEL: 45-43-969040
FAX: 45-43-424347
URL: www.dlink.dk

Norway

Karihaugveien 89
N-1086 Oslo
Norway
TEL: +47 99 300 100
FAX: +47 22 30 95 80
URL: www.dlink.no

Finland

Latokartanontie 7A
FIN-00700 HELSINKI
Finland
TEL: +358-10 309 8840
FAX: +358-10 309 8841
URL: www.dlink.fi

Spain

Avenida Diagonal, 593-95, 9th floor
08014 Barcelona
Spain
TEL: 34 93 4090770
FAX: 34 93 4910795
URL: www.dlink.es

Portugal

Rua Fernando Pahlá
50 Edifício Simol
1900 Lisbon Portugal
TEL: +351 21 8688493
URL: www.dlink.es

Czech Republic

Vaclavske namesti 36, Praha 1
Czech Republic
TEL :+420 (603) 276 589
URL: www.dlink.cz

Switzerland

Glatt Tower, 2.OG CH-8301
Glattzentrum Postfach 2.OG
Switzerland
TEL : +41 (0) 1 832 11 00
FAX: +41 (0) 1 832 11 01
URL: www.dlink.ch

Greece

101, Panagoulis Str. 163-43
Helioupolis Athens, Greece
TEL : +30 210 9914 512
FAX: +30 210 9916902
URL: www.dlink.gr

Luxemburg

Rue des Colonies 11,
B-1000 Brussels,
Belgium
TEL: +32 (0)2 517 7111
FAX: +32 (0)2 517 6500
URL: www.dlink.be

Poland

Budynek Aurum ul. Walic-w 11
PL-00-851
Warszawa
Poland
TEL : +48 (0) 22 583 92 75
FAX: +48 (0) 22 583 92 76
URL: www.dlink.pl

Hungary

R-k-czi-t 70-72
HU-1074
Budapest
Hungary
TEL : +36 (0) 1 461 30 00
FAX: +36 (0) 1 461 30 09
URL: www.dlink.hu

Singapore

1 International Business Park
#03-12 The Synergy
Singapore 609917
TEL: 65-6774-6233
FAX: 65-6774-6322
URL: www.dlink-intl.com

Australia

1 Giffnock Avenue
North Ryde, NSW 2113
Australia
TEL: 61-2-8899-1800
FAX: 61-2-8899-1868
URL: www.dlink.com.au

India

D-Link House, Kurla Bandra Complex Road
Off CST Road, Santacruz (East)
Mumbai - 400098
India
TEL: 91-022-26526696/56902210
FAX: 91-022-26528914
URL: www.dlink.co.in

Egypt

47, El Merghany street, Heliopolis
Cairo-Egypt
TEL: +202-2919035, +202-2919047
FAX: +202-2919051
URL: www.dlink-me.com

Middle East (Dubai)

P.O.Box: 500376
Office: 103, Building:3
Dubai Internet City
Dubai, United Arab Emirates
Tel: +971-4-3916480
Fax: +971-4-3908881
URL: www.dlink-me.com

Turkey

Cetin Emec Bulvari, 74.sokak, ABC Plaza No:9/3
Ovecler/Ankara- TURKEY
TEL: 0090 312 473 40 55
FAX: 0090 312 473 40 58
URL: www.dlink.com.tr

Israel

11 Hamanofim Street
Ackerstein Towers, Regus Business Center
P.O.B 2148, Hertzelia-Pituach 46120
Israel
TEL: +972-9-9715700
FAX: +972-9-9715601
URL: www.dlink.co.il

LatinAmerica

Isidora Goyechea 2934
Ofcina 702
Las Condes
Santiago ñ Chile
TEL: 56-2-232-3185
FAX: 56-2-232-0923
URL: www.dlink.cl

Brazil

Av das Nacoes Unidas
11857 ñ 14- andar - cj 141/142
Brooklin Novo
Sao Paulo - SP - Brazil
CEP 04578-000 (Zip Code)
TEL: (55 11) 21859300
FAX: (55 11) 21859322
URL: www.dlinkbrasil.com.br

South Africa

Einstein Park II
Block B
102-106 Witch-Hazel Avenue
Highveld Technopark
Centurion
Gauteng
Republic of South Africa
TEL: 27-12-665-2165
FAX: 27-12-665-2186
URL: www.d-link.co.za

Russia

Grafsky per., 14, floor 6
Moscow
129626 Russia
TEL: 7-495-744-0099
FAX: 7-495-744-0099 #350
URL: www.dlink.ru

China

No.202,C1 Building, Huitong Office Park,
No. 71, Jianguo Road, Chaoyang District, Beijing
100025, China.
TEL +86-10-58635800
FAX: +86-10-58635799
URL: www.dlink.com.cn

Taiwan

No. 289 , Sinhu 3rd Rd., Neihu District ,
Taipei City 114 ,Taiwan
TEL: 886-2-6600-0123
FAX: 886-2-6600-1188URL: www.dlinktw.com.tw

Registration Information

(All Countries and Regions excluding USA)

Print, type or use block letters.

Your name: Mr./Ms _____

Organization: _____ Dept. _____

Your title at organization: _____

Telephone: _____ Fax: _____

Organization's full address: _____

Country: _____

Date of purchase (Month/Day/Year): _____

Product Model	Product Serial No.

Product was purchased from:

Reseller's name: _____

Telephone: _____ Fax: _____

Reseller's full address: _____

Answers to the following questions help us to support your product:

- Where and how will the product primarily be used?
 Home Office Travel Company Business Home Business Personal Use
- How many employees work at installation site?
 1 employee 2-9 10-49 50-99 100-499 500-999 1000 or more
- What network protocol(s) does your organization use?
 XNS/IPX TCP/IP DECnet Others _____
- What network operating system(s) does your organization use?
 D-Link LANsmart Novell NetWare NetWare Lite SCO Unix/Xenix PC NFS 3Com 3+Open
 Banyan Vines DECnet Pathwork Windows NT Windows 2000 Windows XP
 Others _____
- What network management program does your organization use?
 D-View HP OpenView/Windows HP OpenView/Unix SunNet Manager Novell NMS
 NetView 6000 Others _____
- What network medium/media does your organization use?
 Fiber-optics Thick coax Ethernet Thin coax Ethernet 10BASE-T UTP/STP
 100BASE-TX 100BASE-T4 100VGAnyLAN Others _____
- What applications are used on your network?
 Desktop publishing Spreadsheet Word processing CAD/CAM
 Database management Accounting Others _____
- What category best describes your company?
 Aerospace Engineering Education Finance Hospital Legal Insurance/Real Estate
 Manufacturing Retail/Chainstore/Wholesale Government Transportation/Utilities/Communication
 VAR System house/company Other _____
- Would you recommend your D-Link product to a friend?
 Yes No Don't know yet
- Your comments on this product?

PLEASE
PLACE STAMP
HERE

TO: _____

D-Link®

