



# P70530 (DC) High Performance Micro-Stepping Drive

Reference Guide  
Revision C  
2/2012



EN60034-1  
EN60034-5

Keep all product manuals as a product component during the life span of the product.  
Pass all product manuals to future users/owners of the product.

**KOLLMORGEN**™

Part # M-SD-7DC-01

## Record of Manual Revisions

Revision	Date	Description of Revision
1	04/2006	Initial Release
A	10/2007	Added motor selection, changed branding.
B	02/2009	Updated section 3.1
C	02/2012	Replace obsolete pin, add heat sink note to 3.1, rebrand

## Copyright Information

© Copyright 2006 Danaher Motion – All rights reserved.  
Printed in the United States of America

### NOTICE:

Not for use or disclosure outside of Kollmorgen except under written agreement. All rights are reserved. No part of this book shall be reproduced, stored in retrieval form, or transmitted by any means, electronic, mechanical, photocopying, recording, or otherwise without the written permission from the publisher. While every precaution has been taken in the preparation of the book, the publisher assumes no responsibility for errors or omissions. Neither is any liability assumed for damages resulting from the use of the information contained herein.

This document is proprietary information of Kollmorgen that is furnished for customer use ONLY. No other uses are authorized without written permission of Kollmorgen. Information in this document is subject to change without notice and does not represent a commitment on the part of Kollmorgen. Therefore, information contained in this manual may be updated from time-to-time due to product improvements, etc., and may not conform in every respect to former issues.

*Kollmorgen reserves the right to make engineering refinements on all its products. Such refinements may affect information in instructions. USE ONLY THE INSTRUCTIONS PACKED WITH THE PRODUCT.*

Safety-alert symbols used in this document are:



**WARNING**

*Alerts users to potential physical danger or harm. Failure to follow warning notices could result in personal injury or death.*



**CAUTION**

*Directs attention to general precautions, which if not followed, could result in personal injury and/or equipment damage.*



**NOTE**

*Highlights information critical to your understanding or use of the product.*

## Table of Contents

<b>1. GETTING STARTED.....</b>	<b>1</b>
1.1 UNPACKING AND INSPECTING .....	2
1.2 PART NUMBER .....	2
1.3 ACCESSORIES.....	3
1.4 SPECIFICATIONS.....	3
1.4.1 Drive Power.....	3
1.4.2 I/O Specifications .....	4
1.4.3 Environmental .....	5
1.5 DC MOUNTING.....	5
1.5.1 DC Base Drive Mounting Dimensions .....	6
<b>2. WIRING.....</b>	<b>7</b>
2.1 CONNECTOR LOCATIONS.....	7
2.2 FUNCTIONS BY CONNECTOR .....	8
2.2.1 J4 Connector – Command I/O.....	8
2.2.1.1. Step, Direction, and Enable Inputs .....	8
2.2.1.2. Connection Scheme for Differential Step and Direction Signals .....	10
2.2.1.3. Connection Scheme for Open-Collector Single- Ended Step and Direction Signals .....	11
2.2.1.4. General Purpose Inputs.....	12
2.2.1.5. Fault Output (J4-7, 8) .....	13
2.2.1.6. General Purpose Output (J4-21, 22) .....	13
2.2.2 J5 Serial Connector (RS-232).....	14
2.2.3 J6 Motor .....	15
2.2.3.1. Connecting A Motor.....	15
2.2.4 J7 DC Power .....	17
<b>3. CONFIGURE THE DRIVE WITH SWITCHES.....</b>	<b>18</b>
3.1 MOTOR SELECTION.....	18
3.2 STEP RESOLUTION .....	20
3.3 LOAD INERTIA .....	20
3.4 DYNAMIC SMOOTHING™ .....	21
3.5 CURRENT REDUCTION .....	21
3.6 MULTI-STEPPING™ .....	21
3.7 ENCODERLESS STALL DETECTION™.....	22

<b>4.</b>	<b>USING P7000TOOLS .....</b>	<b>23</b>
4.1	INSTALLING P7000TOOLS.....	23
4.2	SET-UP WIZARD .....	23
4.3	TOOLBARS .....	24
4.4	PRODUCT SELECTION .....	25
4.5	CONFIGURATION AND UNIT ADDRESS.....	25
4.5.1	<i>Status Screen</i> .....	26
4.5.2	<i>Configuration Summary</i> .....	27
4.5.3	<i>Stepper Motor Screen</i> .....	27
4.5.3.1.	Motor File Editor .....	28
4.5.4	<i>Mechanical</i> .....	29
4.5.4.1.	User Units Ratio .....	29
4.5.4.2.	Load Information.....	30
4.5.5	<i>Command Configuration</i> .....	30
4.5.6	<i>I/O Configuration</i> .....	31
4.5.6.1.	INPUTS .....	31
4.5.6.2.	Input Debounce Time .....	32
4.5.6.3.	Output .....	32
4.5.7	<i>X-Smoothness</i> .....	33
4.5.8	<i>Advanced Setup</i> .....	34
4.5.8.1.	Anti-Resonance .....	35
4.5.8.2.	Current Reduction.....	35
4.5.8.3.	Profiling.....	36
4.5.8.4.	Stall Detection .....	36
4.5.9	<i>Motion Profile Generator</i> .....	37
<b>5.</b>	<b>TROUBLESHOOTING.....</b>	<b>39</b>
5.1	COMMON PROBLEMS .....	39
5.2	STATUS DISPLAY .....	39
5.3	SAFETY .....	40
5.4	FIRMWARE UPGRADE PROCEDURES .....	42
<b>APPENDIX A.....</b>	<b>43</b>	
A.1	POWER SUPPLY SELECTION .....	43
A.2	CBUS MIN.....	44
A.3	REGULATORY INFORMATION.....	I
A.3.1	<i>Use Conforming Requirements</i> .....	<i>I</i>
A.3.2	<i>CE-Approval</i> .....	<i>I</i>
A.3.3	<i>The CE test setup consisted of the following:</i> .....	<i>II</i>

---

**INDEX** ..... **IV**



# 1. GETTING STARTED



**WARNING**

***Read this reference guide before you apply power to the drive. Mis-wiring of the drive may result in damage to the unit voiding the warranty. Improper grounding of the drive may cause serious injury to the operator.***

Only qualified personnel are permitted to transport, assemble, commission, and maintain this equipment. Properly qualified personnel are persons who are familiar with the transport, assembly, installation, commissioning and operation of motors, and who have the appropriate qualifications for their jobs.

Read all available documentation before assembling and using. Incorrect handling of products in this manual can result in injury and damage to persons and machinery. Strictly adhere to the technical information regarding installation requirements.



**CAUTION**

***Keep all covers and cabinet doors shut during operation.***



**CAUTION**

***Be aware that during operation, the product has electrically charged components and hot surfaces. Control and power cables can carry a high voltage, even when the motor is not rotating.***



**CAUTION**

***Never disconnect or connect the product while the power source is energized.***



**CAUTION**

***After removing the power source from the equipment, wait at least 2 minutes before touching or disconnecting sections of the equipment that normally carry electrical charges (e.g., capacitors, contacts, screw connections). To be safe, measure the electrical contact points with a meter before touching the equipment.***

## 1.1 UNPACKING AND INSPECTING

Open the box and remove all the contents. Check to ensure there is no visible damage to any of the equipment.



**CAUTION**

*Use proper procedures when handling electronic components to avoid damage to equipment.*



**CAUTION**

*Remove all packing material and equipment from the shipping container. Be aware that some connector kits and other equipment pieces may be quite small and can be accidentally discarded. Do not dispose of shipping materials until the packing list has been checked.*



**NOTE**

*Upon receipt of the equipment, inspect components to ensure that no damage has occurred in shipment. If damage is detected, notify the carrier immediately. Check all shipping material for connector kits and documentation.*

## 1.2 PART NUMBER

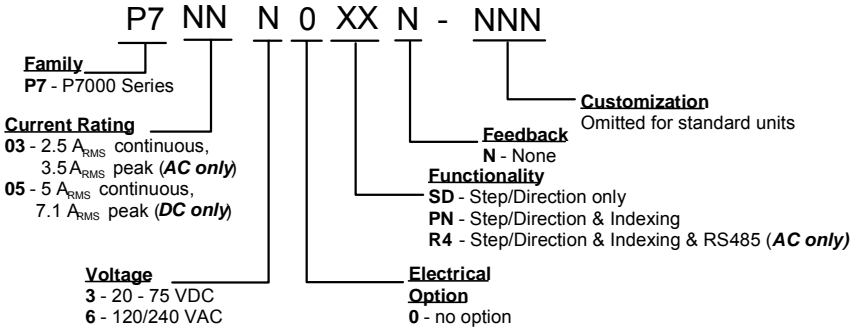



## 1.3 ACCESSORIES

768-026902-03	26-pin D-Sub connector to terminal block adapter
P7S2-232-9D	RS-232 Serial cable RJ12 to 9 pin D-Sub connector 6 feet

## 1.4 SPECIFICATIONS



**NOTE**

*Unless otherwise specified, specifications are worst-case limits and apply over the specified operating ambient temperature and over the specified operating line voltage.*

### 1.4.1 DRIVE POWER

Specification	P70530
Max Output Current (0-40° C)	5 A <sub>RMS</sub>
Max Output Power at 5 A max average	350 W at 72 V 240 W at 48 V 120 W at 24 V
Power Dissipation at 3.5 A	9 W max at 5 A <sub>RMS</sub> /motor phase 5 W max at 3 A <sub>RMS</sub> /motor phase 1.8 W typ. at disabled
Motor Inductance Range	2-15 mH nom.
Maximum Motor Cable Length (24 AWG)	20 m
Power Supply 20 - 75 VDC recommended design center isolated unregulated type (or regulated + bus cap)	20 – 75 VDC 5 A average (max)
Bus cap min scale as ratio of (motor current/5A) scale as ratio of (72 V/supply voltage) for multiple drives on supply scales as (number of drives) locate within 10 ft. of drive (#16 AWG twisted)	6,000 µf at 5 A motor, 72 V
Bus Under Voltage Fault	18 VDC
Bus Over Voltage Fault	91 VDC
Inrush Current & Fusing	
Peak Current	15 A
Inrush Pulse Width	4 ms
Recommended Fusing	10 A Slow Blow
5 VDC Internal Supply	50 mA
Time delay for "reduced idle current" to return to the system's "full current"	< 1 ms (typ)



**NOTE**

*See Appendix A for information on power supply bus capacitance.*

## 1.4.2 I/O SPECIFICATIONS

<b>Step, Direction, &amp; Enable Inputs</b>	
<b>Step/Dir J4-1-J4-6</b>	
Step Input Voltage & Current Range	3 V - 6 V, 16 mA at 5 V (See Note below)
Direction Input Voltage & Current Range	3 V - 6 V, 16 mA at 5 V (See Note below)
Enable Input Voltage & Current Range	3 V - 6 V, 3-6 mA at 5 V (See Note below)
Step Minimum on/off time	800 ns
Step Input Max Frequency	2 MHz
Direction minimum set up Time	50 $\mu$ s

<b>General Purpose I/O</b>	
<b>DIN1-DIN9 (J4-10-J4-18)</b>	
Input Voltage Range	4 - 6 VDC (See Note below)
Input Current Range (Internally Controlled)	1 mA at 5 VDC
Response Time	$\leq$ 250 $\mu$ s
<b>GPO J4-7, J4-8, J4-21, J4-22</b>	
Maximum Output Voltage	30 VDC
Clamp Voltage	30 VDC
Maximum Output Current	5 mA
On Voltage	0.4 VDC
Response Time	$\leq$ 250 $\mu$ s



### NOTE

**Higher voltages may also be used if an appropriately sized current limit resistor is installed external to the drive (Reference sections 0, 2.2.1.3, and 2.2.1.4).**

## 1.4.3 ENVIRONMENTAL

Operating Temperature	0 - 45° C unmounted
Pollution Degree	II
Storage Temperature °C	-20 to + 70° C
Humidity (% non-condensing)	90%
Altitude	<1500 m (5000 ft)

## 1.5 ***DC MOUNTING***

Mount the P70530 to a cold plate using either 8x32 or M4 screws. This drive can be mounted either vertically or horizontally.

1. For convection cooling allow a minimum of 1 in (25.4 mm) of space around all sides.
2. If the heat sink temperature exceeds 70 °C the drive shuts down due to overheating. Fan cooling or a lower ambient temperature may be required to allow the drive to run properly.

## 1.5.1 DC BASE DRIVE MOUNTING DIMENSIONS

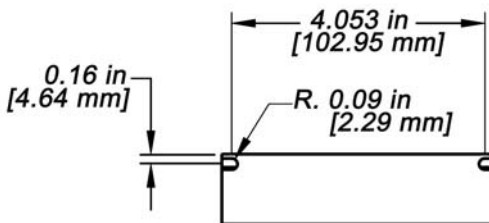
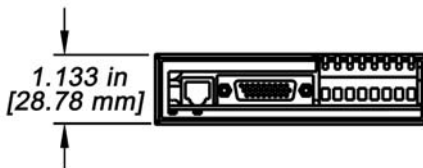
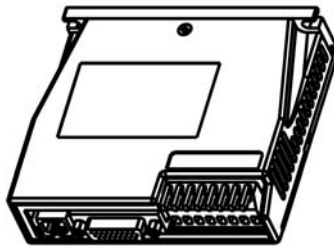
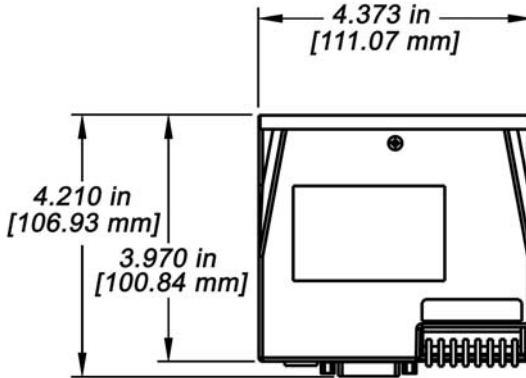

## 2. WIRING

### 2.1 CONNECTOR LOCATIONS

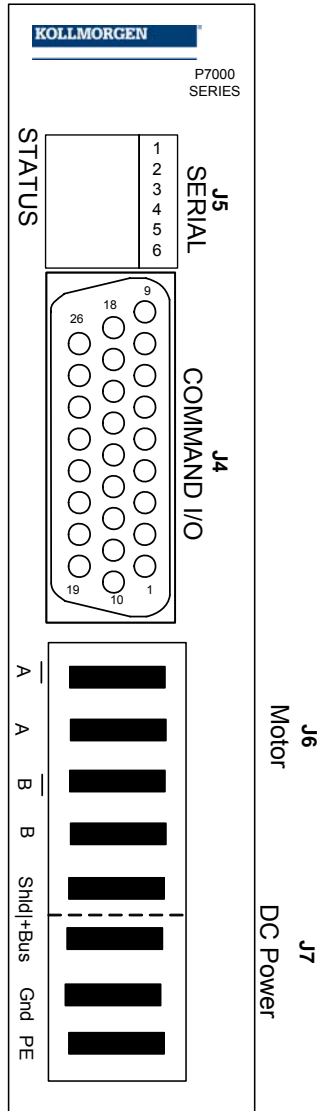

## 2.2 FUNCTIONS BY CONNECTOR

### 2.2.1 J4 CONNECTOR – COMMAND I/O

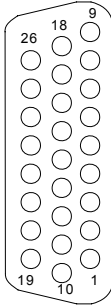

**J4 is a 26-Position High Density D subminiature female connector. (Connector is shown as viewed from the front of the drive.)**

Pin	Description
J4-1	STEP + Opto
J4-2	STEP - - Pulse
J4-3	DIR + Opto
J4-4	DIR - <u>DIR</u>
J4-5	ENABLE + Opto
J4-6	ENABLE - AWO
J4-7	FAULT +
J4-8	FAULT -
J4-9	Gnd
J4-10	DIN1 (MVSEL 1)*
J4-11	DIN2 (MVSEL 2)*
J4-12	DIN3 (MVSEL 3)*
J4-13	DIN4 (MVSEL 4)*

Pin	Description
J4-14	DIN5 (Jog +)*
J4-15	DIN6 (Jog -)*
J4-16	DIN7 (EOT +)*
J4-17	DIN8 (EOT -)*
J4-18	DIN9 (Fault Reset)*
J4-19	+ 5 V I/O Power Source
J4-20	Pull Up/Dn
J4-21	OUT + (Motion Node Active)*
J4-22	OUT - (Motion Node Active)*
J4-23	NC
J4-24	RS-232 RX
J4-25	5 V Return I/O Power Source
J4-26	RS-232 TX

\*Default I/O Assignments



#### NOTE

**MVSEL (Move Select) is available in –PNN (Motion Node) units only. The same is true for MOTION NODE ACTIVE outputs.**

#### 2.2.1.1. Step, Direction, and Enable Inputs

##### Step Input

**J4 1, 2** The P70530 increments its internal step counter on the ON-to-OFF transition of the LED in an opto isolator. Minimum ON and minimum OFF times are both 250 ns. This results in a maximum step input frequency of 2 MHz. Pulses that do not meet minimum times may be ignored by the drive's electronics. **The input circuitry is suitable for use with 5-volt logic (single ended or**

**differential). It is best to drive the input to both logic states rather than utilize open collector transistors**

**The STEP input is sensitive to high frequency noise and should be supplied through shielded cable.**

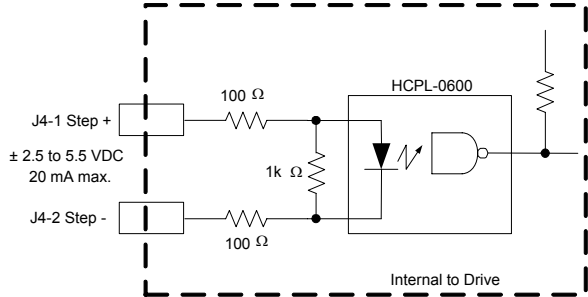

### Direction Input

**J4 3, 4** The DIRECTION input is similar to the step input except that it employs a slower opto isolator. Allow for a 55  $\mu$ s setup time from changes at the DIR input prior to transition of the STEP input. Failure to meet setup time can result in the drive misinterpreting the intended direction of a step.

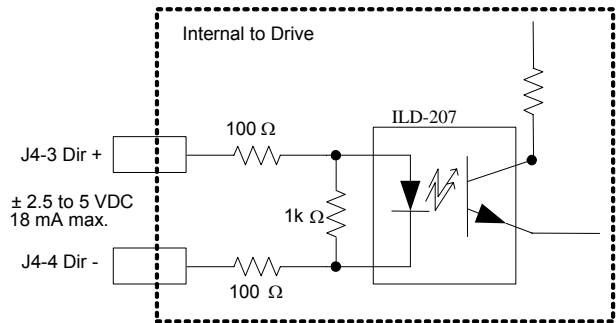

### Enable Input

**J4 5, 6** The ENABLE input removes current from the motor windings so the axis can be externally moved. The polarity of the ENABLE logic is configurable using P7000Tools. Factory default is ENABLE = ACTIVE OPEN. If the inputs are left open, the drive is enabled.

**The input is enabled with 5 mA of current. It is suitable for use with 3 to 5 volt logic.** The ENABLE input is digitally filtered and internally de-bounced.

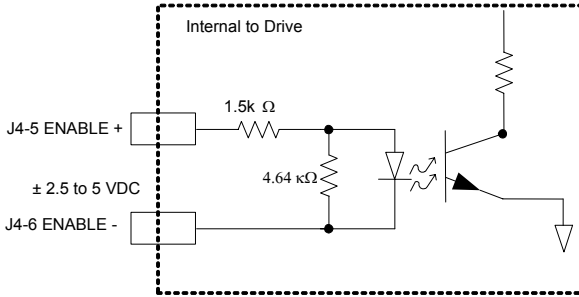

**Do not depend on the ENABLE input as a safety or E-STOP mechanism. Internal drive failure could result in motion. When disabled, the winding terminals are not at safe potential. The power output from the drive is electrically safe only when the drive is disconnected from the power source.**

**NOTE**

*For step and direction inputs, refer to Section 1.4.2, I/O Specifications.*

### 2.2.1.2. Connection Scheme for Differential Step and Direction Signals

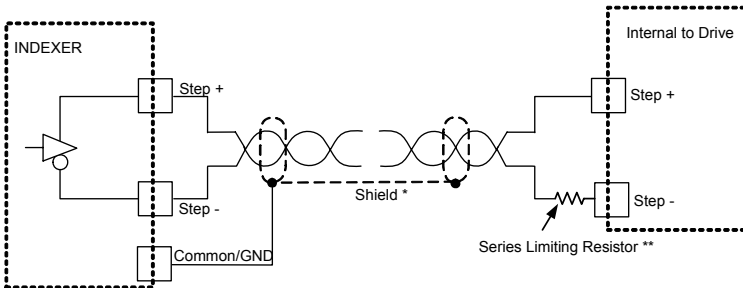
**NOTE**

*\*Always use shielded, twisted pair cable to step and direction signals. Route away from motor leads.*

**NOTE**

*\*\*Use series limiting resistor for pull-up voltages greater than 5 VDC. Size according to:  $R_{CL} = (V_S - 5)100$*



### 2.2.1.3. Connection Scheme for Open-Collector Single-Ended Step and Direction Signals

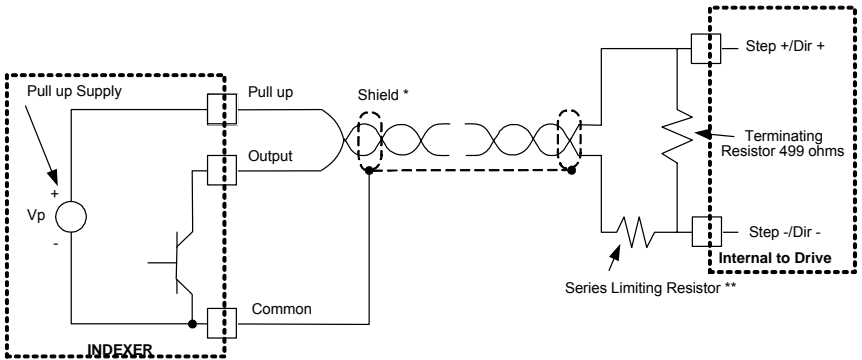

**\*Always use shielded, twisted pair cable to step and direction signals. Route away from motor leads.**

**NOTE**



**\*\*Use series limiting resistor for pull-up voltages greater than 5 VDC. Size according to:  $R_{CL} = (V_S - 5)100$**

**NOTE**

### 2.2.1.4. General Purpose Inputs

There are nine configurable General Purpose Inputs (GPI's) on the P70530 drive. All the inputs share a common optically isolated bus (Pull Up/Down). The common bus simplifies the wiring allowing a common point to connect either sinking or sourcing input devices.

#### Typical Input Schematic

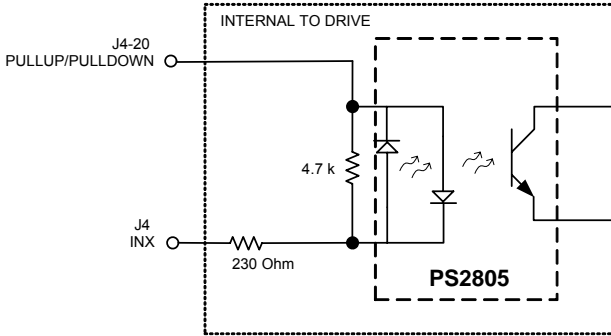

#### Configuration

Sourcing input device using P7000 internal 5 VDC supply

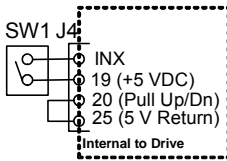

Sourcing input device using external supply (+5 VDC)

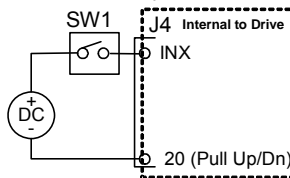

Sinking input device using P7000 internal 5 VDC supply

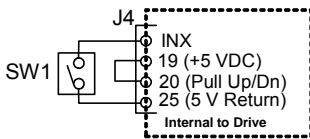

Sinking input device using external supply (+5 VDC)

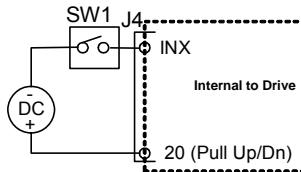

**SW1 Input device is shown as NORMALLY OPEN. It may also be configured via the user interface as NORMALLY CLOSED.**



**NOTE**

**For voltages greater than 5 VDC (24 VDC max), install a current limiting resistor in series with the input.**

**Size according to:  $R_{CL} = (V_S - 5) 100$**

### 2.2.1.5. Fault Output (J4-7, 8)



**This output is from an optoisolator able to support no more than 5 mA before increasing  $V_{CE_{SAT}}$ .**

#### NOTE

**Dedicated Fault Output** indicates that the drive has sustained a latched condition. Whenever the fault output is asserted, the front panel LED blinks a Fault Code repeatedly. FAULT+ and FAULT- are the isolated (collector-emitter) terminals of an optocoupler. They must be attached to a pull-up and signal common of the machine control system. The output pair is normally conducting and becomes an open circuit during a fault.

Faults are cleared in three ways:

1. Power cycle – Power must remain disconnected for approximately 10 seconds to effect reset.
2. Software reset – Use the Reset button on the toolbar.
3. I/O pin – Any of the nine I/O pins may be configured as a Fault Reset. (See schematic in section 2.2.1.6)

### 2.2.1.6. General Purpose Output (J4-21, 22)



**This output is from an optoisolator able to support no more than 5 mA before increasing  $V_{CE_{SAT}}$ .**

#### NOTE

The P70530 includes one optically isolated output that can be configured to indicate:

- EOT latched
- Motor Moving
- Motion Node Active
- No Function
- Stalled

The input may be powered by the on-board 5 VDC logic supply (J4-19) or from a remote supply ranging from 5 - 24 VDC.

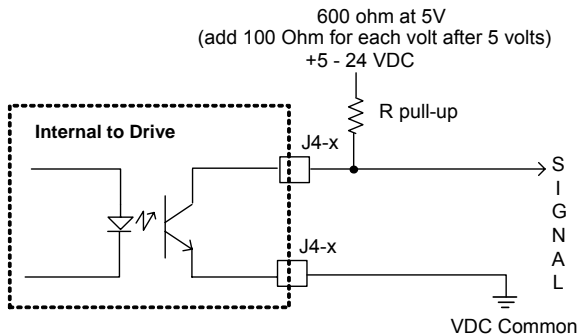

## 2.2.2 J5 SERIAL CONNECTOR (RS-232)



**P7S2-232-9D**  
RJ12/RJ11 Phone Style  
Standard RJ12/RJ11 Plug

RJ12/RJ11 Phone Style	
Pin	Description
J5-1	No Connection
J5-2	RX232
J5-3	I/O RTN
J5-4	No Connection
J5-5	TX232
J5-6	No Connection

Parameter	Specification
Baud rate	19,200
Electrical interface	RS-232, Full duplex
Transfer format	UART, 1 start bit (mark), 8 data bits, even parity bit and 1 stop bit (space), no flow control.

Cable wiring diagrams for connecting to either 9 or 25 pin serial ports of most computers are also shown below.



**NOTE**

***Pinouts vary among computer manufacturers. Check the hardware reference manual for your machine before wiring.***

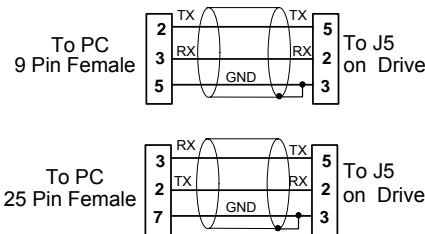

***P7000 Stepper drives are MODbus RTU compatible. Please refer to the P7000 MODbus Application note.***

**Warning:**

***The P7000 products automatically update non-volatile memory when a variable is changed. Designing a system that changes one or more variables on a repetitive basis could exceed the storage device's life expectancy of 1,000,000 writes. Exceeding the specification will cause a drive failure - requiring repair. Please see P7000 MODbus Application note for details***



**NOTE**

## 2.2.3 J6 MOTOR

### 2.2.3.1. Connecting A Motor

Kollmorgen offers a number of standard stepper motors designed to provide optimum performance when matched with the P70530. The motors are offered with a 4-flying lead configuration. If your motor has 6 or 8 leads, you should consult your distributor or the factory for assistance.

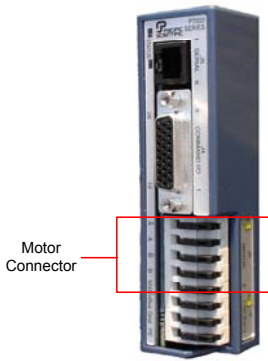

Motor Connector

Danaher Motion's Pacific Scientific Flying Lead Motor Wiring For T2x, N3x, K3x, N4x, and K4x Series Motors.

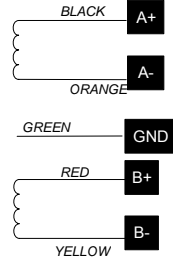

**Do not hot-plug the motor connector.**  
**Avoid "whiskers" from stranded phase leads protruding from the motor plug.**

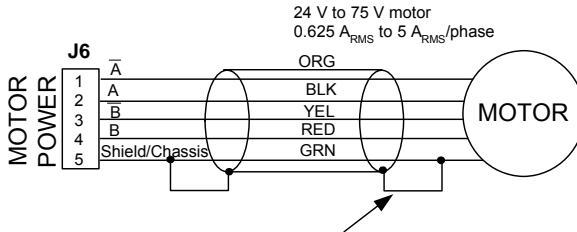

To avoid electrical shock, motor ground must be connected to protective earth.

Typical Kollmorgen stepper wire color code:

Ā	Orange	Motor Phase A
A	Black	(twisted pair)
B̄	Yellow	Motor Phase B
B	Red	(twisted pair)
PE	Green/Yellow Stripe	Cable Shield/Motor Case
		(J6-5 connects to J7-3 inside drive)

**To reverse direction of motor rotation:**

**Switch  $\bar{A}$  with A**

**OR**

**Switch  $\bar{B}$  with B**

**OR**

**Switch  $\bar{A}$ , A with  $\bar{B}$ , B**

**OR**

**Switch rotation polarity in the user interface**



**NOTE**



**NOTE**

***Kollmorgen recommends the use of insulated wire ferrels to prevent shorting and add strain relief.***

## 2.2.4 J7 DC POWER

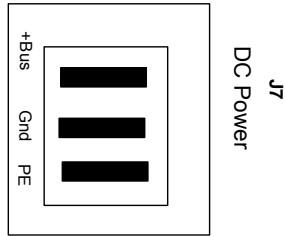

(Connector view from front of drive)

Pin	Description	
J7-1	Plus power supply terminal	20 V – 75 V 5 A av max isolated, unregulated (or regulated) power supply
J7-2	Negative power supply terminal Negative power supply terminal/ Bus Gnd is normally earthed <i>Note: Maximum allowable voltage between Bus Gnd (J7-2) and Chassis (J7-3) is 100 V peak.</i>	
J7-3	Connect to PE (Protective Earth) (J7-3) connects to J6-5 inside drive	



**NOTE**

**Kollmorgen recommends the use of insulated wire ferrels to prevent shorting and add strain relief.**

## 3. CONFIGURE THE DRIVE WITH SWITCHES



### NOTE

*The drive is configured by either using P7000Tools or the switches on the top of the drive. The instructions that follow detail how to configure the drive using the switches.*

### 3.1 MOTOR SELECTION

Configure the drive for a motor type via switch settings on the top of the drive. Valid settings are:

MOTOR	S1	S2-1	MOTOR	S1	S2-1
GUI Select	0	OFF	CTM33...47	0	ON
T2H...H (parallel)	1	OFF	N31...J (parallel)	1	ON
T21H...H (parallel)	2	OFF	N32...J (parallel)	2	ON
T22...G (parallel)	3	OFF	N33...J (parallel)	3	ON
T23...H (parallel)	4	OFF	N34...J (parallel)	4	ON
CTP20...17	5	OFF	K31...J (parallel)	5	ON
CTP20...27	6	OFF	K32...J (parallel)	6	ON
CTP21...39	7	OFF	K33...J (parallel)	7	ON
CTM21...39	8	OFF	K34...J (parallel)	8	ON
CTP22...50	9	OFF	N41...J (parallel)	9	ON
CTM22...50	A	OFF	N42...K (parallel)	A	ON
CTP31...45	B	OFF	K41...J (parallel)	B	ON
CTM31...45	C	OFF	K42...K (parallel)	C	ON
CTP32...73	D	OFF	CTP10...10*	D	ON
CTM32...73	E	OFF	CTP11...11*	E	ON
CTP33...47	F	OFF	CTP12...10	F	ON



### CAUTION

*CTP motor parameters require the use of a heat sink with the thermal dissipation equivalent of a 4-1/8" x 4-1/8" x 1/4" aluminum plate mounted to the motor face. If an equivalent heat sink is not used, reduce the default drive current for these motors by 25% to avoid overheating.*



**NOTE**

***Motor selection table is only valid for firmware version 2.10 or higher.***

**NOTE**

***For non-system motors, configure the drive with the P7000Tools GUI Wizard. The motor inductance range is 2 – 15 mH.***

***Motor type zero is used for other motors.***

***Using incorrect settings results in zero current (motor will not operate).***

***If you change the motor type, you MUST cycle power to the drive for the changes to take effect.***

## 3.2 **STEP RESOLUTION**

<b>Step Resolution</b>			
<b>Resolution</b>	<b>S2-2</b>	<b>S2-3</b>	<b>S2-4</b>
200	ON	ON	ON
400	OFF	ON	ON
5,000	ON	OFF	ON
10,000	OFF	OFF	ON
18,000	ON	ON	OFF
25,000	OFF	OFF	OFF
25,400	OFF	ON	OFF
50,000	ON	OFF	OFF

## 3.3 **LOAD INERTIA**

The P7000 eliminates resonance, typical of step motors, with high-speed, digital processing of motor electrical activity. To use this feature, you must set three switches based on the load-to-rotor inertia ratio. These switches select the gain parameter for the drive to use to stabilize the motor.

<b>Load Inertia Ratio</b>			
<b>Load-Rotor</b>	<b>S2-5</b>	<b>S2-6</b>	<b>S2-7</b>
0-1	OFF	OFF	OFF
1-1.5	ON	OFF	OFF
1.5-2.5	OFF	ON	OFF
2.5-5.0	ON	ON	OFF
5.0-7.0	OFF	OFF	ON
7.0-12.0	ON	OFF	ON
12.0-20.0	OFF	ON	ON
20.0-32.0	ON	ON	ON

### 3.4 **DYNAMIC SMOOTHING™**

Dynamic smoothing is a temporal filter ( 2nd- Order, Low-pass) applied to the command sequence to reduce jerk. It helps reduce overshoot and lessens the excitation of mechanical resonance in the system. It filters from slightly below the resonant frequency up to well above resonance to remove spectral content would be misrepresented in the motor output and may also excite other parts of the machine.

Dynamic Smoothing		
Smoothing	S2-8	S2-9
Minimal	OFF	OFF
Moderate	ON	OFF
Heavy	OFF	ON
Aggressive	ON	ON

### 3.5 **CURRENT REDUCTION**

Reduces drive and motor heating by invoking standby current reduction via Switch S2-10. When enabled, the reduction mode cuts motor current to 75% of its commanded value 100 ms after receipt of the last step pulse or the end of a stored move. The reduction proportion and the delay can be set to other values using P7000Tools.

Current Reduction	S2-10	ON=Disabled
-------------------	-------	-------------

### 3.6 **MULTI-STEPPING™**

Multi-Stepping™ is similar to dynamic smoothing™ except that it is a much more aggressive use of the filter. Typically, it results in a filter that begins to roll off a couple octaves below the resonant frequency. This is intended for use with course resolution (full/half step input pulses) to smooth out the big steps into a continuous train of microsteps.

Multi-Stepping	S2-11	ON=Enabled
----------------	-------	------------

## 3.7 **ENCODERLESS STALL DETECTION™**

The P70530 drive is uniquely designed to sense the motor shaft position at all times. The drive monitors the commanded position and compares it to the actual position. As with any two-phase step motor, when the shaft position and commanded position are greater than two full steps apart a stall will be detected and the drive will fault.

Stall Detection	S2-12	ON=Enabled
-----------------	-------	------------

Encoderless stall detection uses an internal motor model for stall detection. Motors in the *P7000 Data Publication* work well. Other motors may not work as well as the algorithm is subject to constraints. No guarantees of reliability of this feature are made when using other motors.

## 4. USING P7000TOOLS

### 4.1 **INSTALLING P7000TOOLS**

When you install P7000Tools, the Installation Wizard will check to see if you have a previous version of P7000Tools on your system. If found, it will uninstall it. After this, you will need to run the installation again to install the new version on your system.

If you do not have a previous version of P7000Tools on your system, you only need to run the installation once.

### 4.2 **SET-UP WIZARD**

Start **P7000Tools**. Follow the **Setup Wizard**. You will go through a series of screens to set up the motor, drive I/O, command structure and mechanical configuration.









When you successfully finish this set up, the front panel **LED** indicator is **Solid Green**. The motor has holding torque.



## 4.3 TOOLBARS





### Utilities Toolbar



	New Project	Creates a new project file in P7000 Tools
	Open Project	Opens an existing project file in P7000 Tools
	Save Project	Saves the current project to a file
	Print Configuration	Prints the selected drive configuration (active only when the Configuration view is selected)
	Send All	Sends the entire configuration to the currently connected drive
	Retrieve All	Retrieves the entire configuration from the currently connected drive*
	Reset Drive	Performs a soft drive reset equivalent to a power cycle (used for clearing fault conditions)
	Soft Disable Amplifier	Disables amplifier
	Scan for Connected	Scans the selected serial port for connected drives

### Motion Toolbar



	Jog Motor Negative	Jogs the motor in the negative direction at the selected velocity
	Jog Velocity Toggle	Selects the active jog velocity for the Jog arrow buttons (L designates Low Speed, H designates High speed)
	Jog Motor Positive	Jogs the motor in the positive direction at the selected velocity
	Stop Motion	Stops all Motion Node generated motion and breaks any active move sequence

\*Drive automatically uploads Parameter File when using "Scan For Connected Units" in toolbar or Setup Wizard.

## 4.4 **PRODUCT SELECTION**

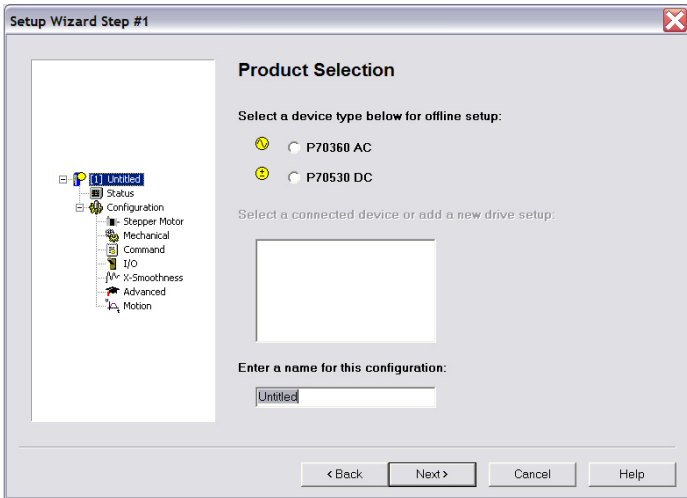

- Select either P70360 AC or P70530 DC unit.
- Add New Drive  
Add additional units.
- Enter a Name for this configuration  
This is the name for the unit or axis.

## 4.5 **CONFIGURATION AND UNIT ADDRESS**

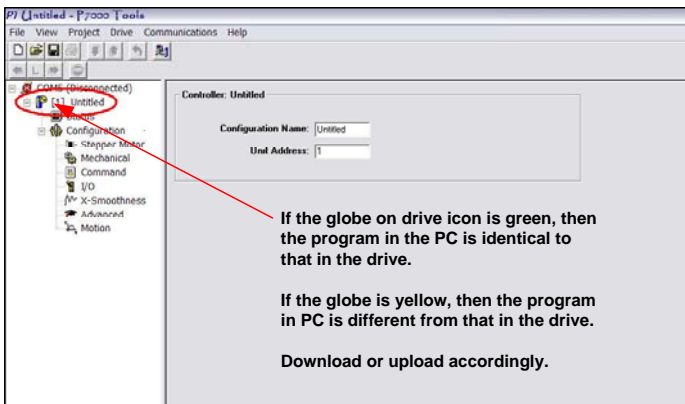

## 4.5.1 STATUS SCREEN

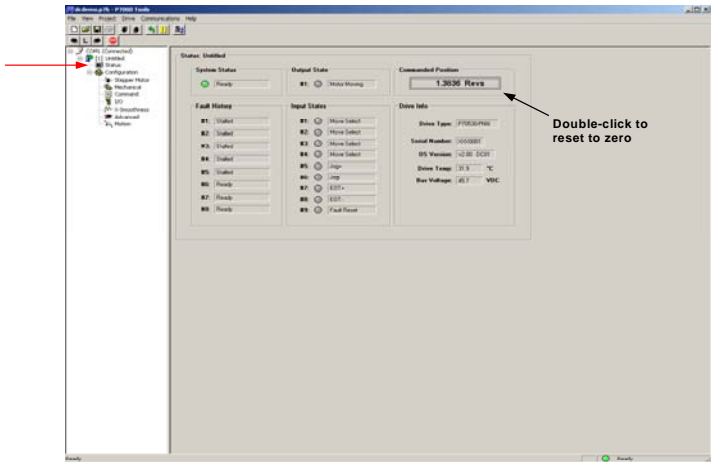

### System Status

- Disconnected** Not online with the drive. Indicator off.
- Disabled** Drive blinking green indicates online, but not enabled.
- Ready** Drive online and enabled. Solid green indicator.

### Output State

- Offline** Not connected to a drive. Indicator gray.
- Online** Indicator is green when programmed output condition is met.

**Fault History** List of the last nine drive faults. #1 being the most recent, #8 is the oldest.

**Input States** Indicator is green if the input is true, gray if false.

### Commanded Position

Actual motor position in user units (double-click in box to reset to zero).

### Drive Information

- Drive Type** Model number for this drive.
- Serial Number** Serial number for this drive.
- OS Version** Current firmware revision level.
- Drive Temp** Drive temperature in degrees Celsius.
- Bus Voltage** DC Bus voltage



## 4.5.2 CONFIGURATION SUMMARY

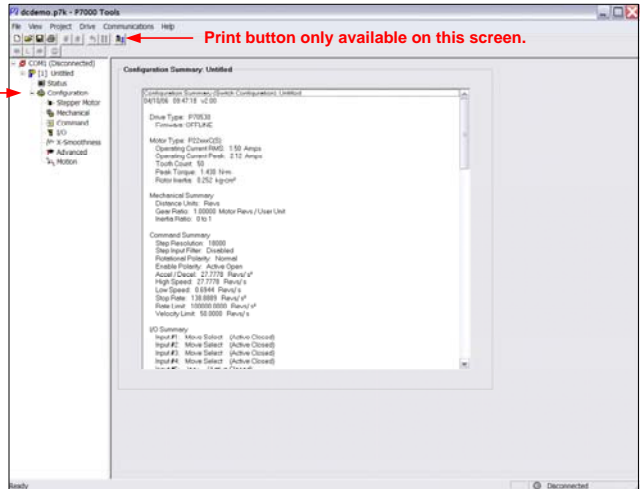

The configuration summary is displayed.

## 4.5.3 STEPPER MOTOR SCREEN

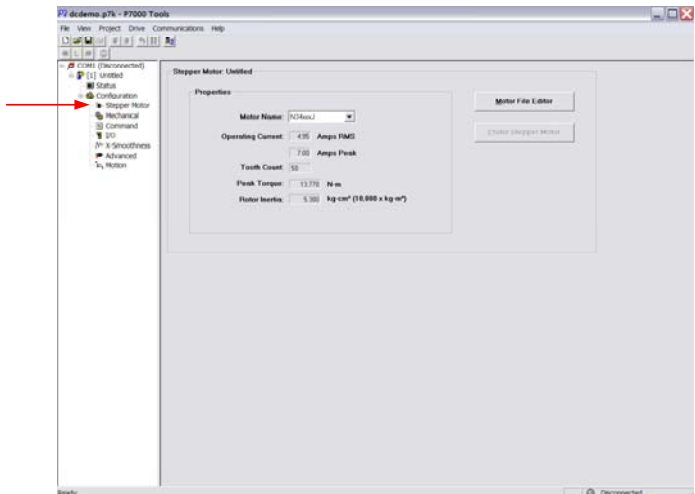

**Motor Name** Select from the list or create a custom file using Motor File Editor (see section 4.5.3.1 for details).

### Operating Current

**$I_{RMS}$**  Continuous current rating for the selected motor.

**$I_{PEAK}$**  Peak current rating for the selected motor. (Calculated by GUI based on continuous current rating).

**Tooth Count** Number of magnetic poles on the stator.

**Peak Torque** Peak torque capability of the motor N-m.

**Rotor Inertia** Rotor inertia of the motor kg-cm<sup>2</sup>.

### Probe Stepper

#### Motor

When a new motor is selected, you are prompted to allow a PROBE. This is similar to what an inductance meter does to measure inductance. The P7000 uses a more powerful test signal, which makes an audible tone in the motor. The probe action takes 10 to 20 seconds, during which time, the drive is gathering information needed to operate state observers. It may be desirable to manually start a probe using the PROBE STEPPER MOTOR button. This would be done if a motor were replaced by a unit of the same type.

### 4.5.3.1. Motor File Editor

#### Motor List

List box that contains all of the motor file configurations available in the database on this PC. Select a motor from this list to edit or select NEW to configure a new motor.

#### Properties:

This screen is where you will enter custom motor parameters. The steps to define a custom motor are:



#### NOTE

**The Properties box must be populated with values from a motor data sheet. All other values are calculated by the GUI software.**

- |                       |   |
|-----------------------|---|
| <b>Motor Name</b>     | Enter an appropriate motor name.  |
| <b>Motor Current:</b> | Continuous current rating of the motor ( $A_{RMS}$ ). $A_{PEAK}$ is automatically calculated by the GUI software. |
| <b>Tooth Count</b>    | Total number of magnetic poles on the motor stator. The default is 50.  |

**Peak Torque**  
**Rotor Inertia**

Peak output torque of motor in N-m.  
Inertia of motor rotor in  $\text{kg cm}^2$ .



**Frequency equations illustrated later use rotor inertia in units of  $\text{kg m}^2$**

### NOTE

The other screens in the Stepper Motor File Editor are referenced in the following sections: Dynamic Smoothing 4.5.8.3; X-Smoothness 4.5.7; Anit-Resonance 4.5.8.1

## 4.5.4 MECHANICAL

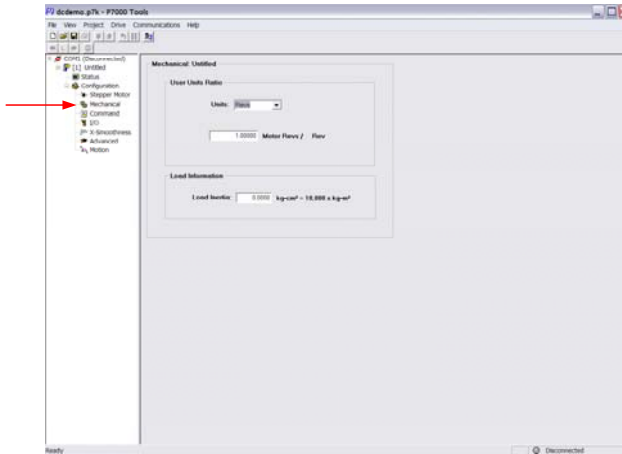

### 4.5.4.1. User Units Ratio



**These values are used as parameters by the Move Profile Editor.**

### NOTE

**Units** Can be set to one of the following:  
Steps  
Revolutions  
Millimeters  
Inches

**Motor revs/rev** This is a scaling function used in the Motion Node to accommodate a gearbox.

Example:

- 2:1 Gearbox
- Enter 2 motor revs/rev
- Enter a Distance of 1 rev in a given motion profile

Result:

The motor advances 2 revolutions to obtain 1 revolution of the gearbox.

#### 4.5.4.2. Load Information

The anti-resonance, stall detect, and dynamic smoothing features require the adjustment of various parameters, depending upon the ratio of Load-to-Rotor inertia. If the ratio is unknown, use an educated guess. The drive easily tolerates a 30% - 40% error.

If the selection is set unrealistically high, the anti-resonance damping may be ineffective. If set too low, dynamic performance may be somewhat reduced.

### 4.5.5 COMMAND CONFIGURATION

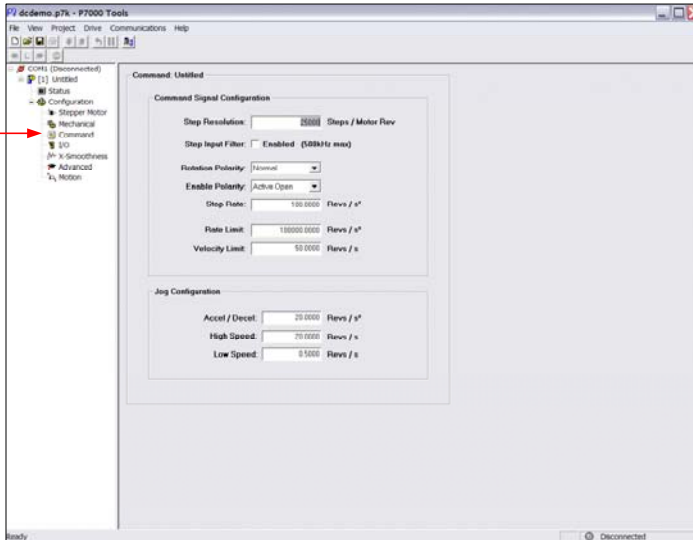

#### Command Signal Configuration

Here you can check the Step Resolution, Rotation Polarity, Enable Polarity, Stop Rate, Rate Limit, and Velocity Limit.

**Step Resolution** 200 to 50,000 steps per motor revolution.



#### NOTE

**When using a controller, set the drive resolution equal to the controller resolution. This is particularly important if there is position feedback to the controller.**

**Step Input Filter** Check to enable low pass cutoff filter at 500 kHz to reduce response to high frequency noise.

**Rotation Polarity** Changes direction of motor rotation for a given input command.

**Enable Polarity****Active Open**

Drive is enabled upon power up or external switch must **OPEN** to ENABLE drive.

**Active Closed**

External switch must **CLOSE** to ENABLE drive.

**Stop Rate**

Used by Motion Profile Generator to terminate a programmed move.

**Rate Limit**

Global limit on ACCEL/DECEL in programmed moves.

**Velocity Limit**

Global limit on the velocity of programmed moves and jog speeds.

**Jog Configuration**

Here you can set the Acceleration/Deceleration, High and Low speeds.

**NOTE**

*These parameters control ACCEL/DECEL and jog speeds that are generated by jog commands from within the user interface or the I/O.*

**ACCEL/DECEL**

Global limit on jog acceleration/deceleration.

**High Speed**

High jog.

**Low Speed**

Low jog.

## 4.5.6 I/O CONFIGURATION

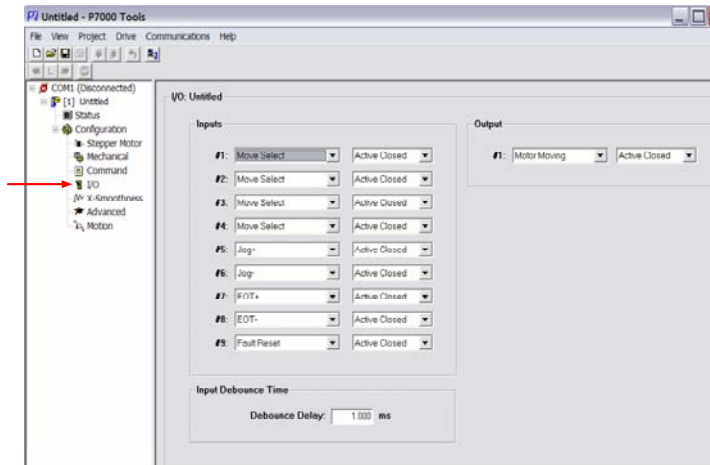

### 4.5.6.1. INPUTS

These nine configurable inputs can be configured as a group as either sinking or sourcing. Individually, they can be configured as either Active Closed or Active Open. All inputs, regardless of function, are subjected to digital debouncing and Debounce Delay is applied globally. Debounce logic requires an input state to persist for the programmed time before being recognized.

There are some assumptions about the use of these inputs when using them for Move Select that must be understood. Only the first six inputs may be configured as Move Select Inputs with DINP1 being the LSB (Least Significant Bit).

Input Function	Description
EOT+	Stops motion in a positive direction when transitioned from inactive to active.
EOT-	Stops motion in a negative direction when transitioned from inactive to active.
Home	A home input is used by the internal move engine during a Home maneuver.
Jog+	Jogs the motor in a positive direction.
Jog-	Jogs the motor in a negative direction
Jog Speed	Selects high or low jog speed.
Fault Reset	Clears latched fault condition and resets the position counter.
Move Select	Functions as one bit of a binary number (up to 6 bits) for selecting pre-programmed moves. The combination of states on the assigned Move Select inputs serves to define a SELECTED MOVE. (See section 4.5.9)
Start Move	Transition to active triggers the move engine to begin the selected move. If a Start Move input has not been assigned, moves are triggered by the appearance of a non-zero value at the Move Select inputs.
Start/Stop Move	Similar to Start Move except that this type of input automatically becomes a Stop input once motion is begun.
Stop Move	Transition to active causes the move engine to decelerate to a controlled stop.
Stop Move on Edge	Move stops on leading edge of input transition.
No Function	Input has no effect.

#### 4.5.6.2. *Input Debounce Time*

Requires an input state to persist for the programmed time before being recognized.

#### 4.5.6.3. *Output*

This output can be configured as Active Closed or Active Open.

Output Function	Description
EOT Latched	Indicates that an EOT has been encountered and the motor has not been moved back off the sensor.
Motor Moving	Motor is rotating.
Motion Node Active	Motion Node is still processing a move, including any programmed time delay.
Stalled	Indicates that the drive has detected a stall.
No Function	Output will not be asserted.

The GPO+ and GPO- are the isolated (collector – emitter) terminals of an optocoupler. They must be attached to a pull-up and signal common of the machine control system (see General Purpose Output (J4-21, 22) – section 2.2.1.6).

## 4.5.7 X-SMOOTHNESS

### Adjusting your Motor for Maximum Smoothness with the X-Smoothness Feature

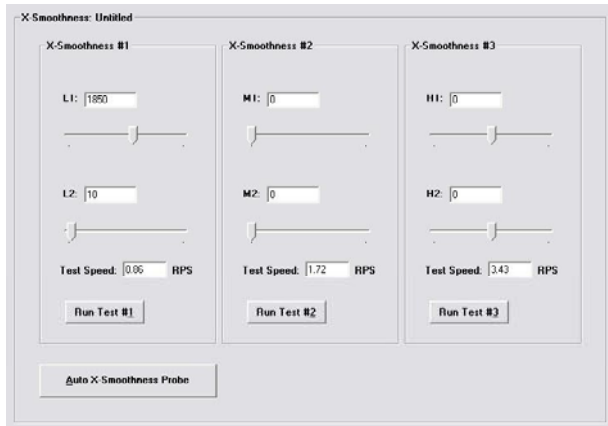

The X-Smoothness feature helps eliminate undesirable motor vibration effects due to the 3 major resonance frequency responses: Fundamental, 2<sup>nd</sup> Harmonic and 4<sup>th</sup> Harmonic. The X-Smoothness settings allow you to enter compensation values, which cancel these resonance responses.

#### X-Smoothness #1:

- L1 Amplitude adjustment for 4<sup>th</sup> harmonic
- L2 Phase adjustment for 4<sup>th</sup> harmonic



#### NOTE

*All Kollmorgen's standard motors, which have been characterized for use with the P7000 drive, have nominal values for L1 & L2 stored in the motor files. Variances in the materials and magnets of two-step motors of the same type can affect comparable motor performance by as much as  $\pm 10\%$ . Due to these variances, the nominal settings may not be the best possible settings for a given motor.*

#### X-Smoothness #2:

- M1 Amplitude adjustment for 2<sup>nd</sup> harmonic
- M2 Phase adjustment for 2<sup>nd</sup> harmonic

#### X-Smoothness #3

- H1 DC offset adjustment for phase A
- H2 DC offset adjustment for phase B

### Procedure for Achieving Optimum Performance

- Step 1:** Run the Auto X-Smoothness Probe **on the unloaded motor**. The X-Smoothness Probe typically comes within 95% of the best adjustment values and finds the exact test speeds for the given motor.
- Step 2:** Run each X-Smoothness group at the given test speed and verify the motor smoothness. You may find a better smoothing value by slightly moving the slider bars back and forth.

It is very important to make the X-Smoothness adjustments at the proper test speeds with an unloaded motor. Running at an incorrect test speed will not excite the motor at its peak resonance, making it more difficult to find proper adjustment values. Running the tests with a loaded motor moves the resonance frequency and the calculated test speeds no longer apply.

**Test Speed #1** Test speed which generates the excitation frequency for the X-Smoothness #1 compensation adjustment

$$\text{Test Speed \#1} = \sqrt{\frac{T_{\max \text{ N-M}}}{16 \bullet \text{Toothcount} \bullet J_{\text{Rotor kg} \cdot \text{m}^2}}}$$

**Test Speed #2** Test speed which generates the excitation frequency for the X-Smoothness #2 compensation adjustment

$$\text{Test Speed \#2} = \sqrt{\frac{T_{\max \text{ N-M}}}{4 \bullet \text{Toothcount} \bullet J_{\text{Rotor kg} \cdot \text{m}^2}}}$$

**Test Speed #3** Test speed which generates the excitation frequency for the X-Smoothness #3 compensation adjustment

$$\text{Test Speed \#3} = \sqrt{\frac{T_{\max \text{ N-M}}}{\text{Toothcount} \bullet J_{\text{Rotor kg} \cdot \text{m}^2}}}$$

## 4.5.8 ADVANCED SETUP

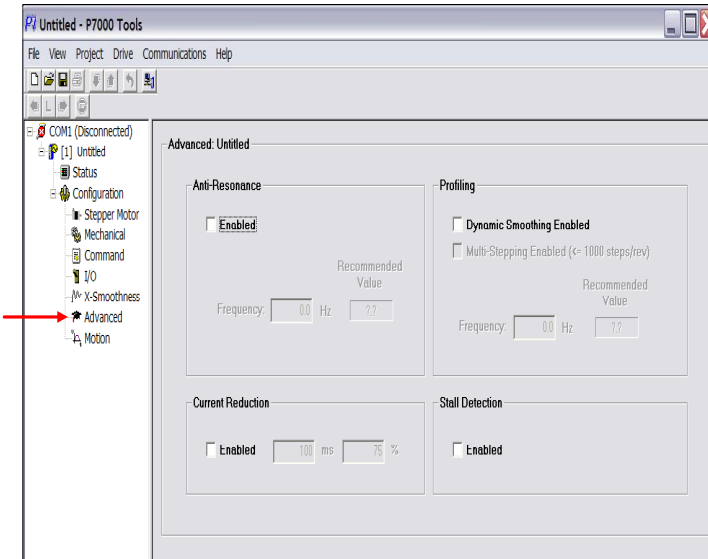



### 4.5.8.1. *Anti-Resonance*

Step motors are highly resonant, which results in vibration and ringing. The ringing utilizes a large fraction of the motor's available torque – thereby wasting performance. Furthermore, at mid-range velocities, the resonance can become so severe that the motor loses synchronization and stalls. The P7000 drives provide robust anti-resonance control to stop the vibrations and maintain equilibrium. This feature requires that the drive be configured with respect to the total inertia in the system. The rotor inertia and the Load-to-Rotor inertia ratio are set in the Mechanical screen. If set improperly, the effectiveness of the feature may be diminished.

The anti-resonance check box is used to invoke or disable the feature. It should be enabled unless the system configuration either does not need it or cannot tolerate it. A system with loose couplings or viscous loading generally does not need this feature. If a system has compliant (springy) coupling and is absent appreciably viscosity, it may not respond well to the active, anti-resonant loop in the drive. The anti-resonant feature is not designed to damp such a 4<sup>th</sup> order system. If the application of anti-resonance results in degradation or instability, it should be disabled (unchecked).

**Frequency** Break frequency of anti-resonance tuning filter. Typically set to 1/10 the resonant frequency of the motor.

$$\text{ARes Frequency} = \sqrt{\frac{\text{ToothCount} \cdot T_{\text{max N-M}}}{100 \cdot J_{\text{Rotor kg-m}^2}}}$$

**Amplitude** Set to 6500 nominal. Do not alter this value unless advised by technical support.

### 4.5.8.2. *Current Reduction*

Unlike a servo system, the step motor is left energized – even at rest. This leaves full torque available to oppose external disturbing influences and hold position precisely. However, many applications encounter vanishingly small load effects at rest and may benefit from the reduction of current when not moving. The reduced level is programmed as a percent of full current and the time delay is entered in milliseconds (ms). The drive will gently reduce the current to the programmed value after the motor has been at rest for a specified time. If the box is left unchecked, the numeric entries have no effect and full current is maintained at rest.

Motor heating is proportional to the square of the current. Thus, a reduction of 70% current represents a reduction to 50% power. Current reduction has little effect as long as the resting motor is not opposing a continuous torque as in lifting applications. If a disturbing torque is present, the current reduction will result in a small amount of movement. The current vector is restored to full value the instant an incoming step is received or the move engine begins a move.

### 4.5.8.3. Profiling

**Multi-stepping** refers to the process of altering the acceleration in the command sequence to reduce Jerk. Acceleration transients jar the application and may cause unwanted vibrations. When Dynamic Smoothing is enabled, the moment-to-moment move profile is passed through digital filters to smooth out the acceleration/deceleration transients. If the feature is enabled, a value is recommended for the frequency of the filters. This recommendation is based on the moment of inertia of the motor, the load-to-rotor inertia ratio, and torque production specified in the configuration. That recommendation should be accepted, unless it is desired to filter more aggressively. If the application uses coarse resolution such as 200 or 400 steps/rev, it may be quite helpful to invoke Multisteping (checkbox). This is a very aggressive use of the smoothing filter, which will make full stepping appear almost as smooth as microstepping.

Heavy filtering is accompanied by a small delay of the command sequence. All causal low-pass filters have group delay, which is inversely proportional to the bandwidth. In this case, the delay is  $0.22/BW$ . Multisteping cuts the bandwidth to 1/10 the value shown in the frequency box.

**Dynamic Smoothing** is the process whereby the incoming pulse train or move profile is filtered in such a way as to sharply reduce Jerk. This results in a more quiet system and reduces the excitation of mechanical resonances.

The more heavily the filtering is applied, the smoother the commanded motion becomes. Heavy filtering is necessarily accompanied by group delay.

The drive uses information about load-to-rotor inertia ratio to predict the resonant frequency  $f_r$  of the system. The various levels of filtering introduce a second-order, low-pass filter into the command sequence, according to the following table.

#### Dynamic Smoothing:

**Frequency:** Break frequency of a second order command input filter. Typically set to 1/3 the natural frequency of the motor.

$$\text{Smoothing Frequency} = \sqrt{\frac{\text{ToothCount} \cdot T_{\max N-M}}{9 \cdot J_{\text{Rotor kg} \cdot \text{m}^2}}}$$

### 4.5.8.4. Stall Detection

Stall Detection is enabled and disabled using the check box. Stall detection should be disabled if it failed to operate correctly and rendered nuisance stall indications. This may occur with non-standard motors from other vendors. If an application is suspected of causing nuisance stall indications, try disabling the feature and running the move sequence. If the system makes the move without losing synchronism, then it is likely that nuisance trips have occurred.

## 4.5.9 MOTION PROFILE GENERATOR

Once the system is configured you can select Motion Generator by double clicking on the motion folder.

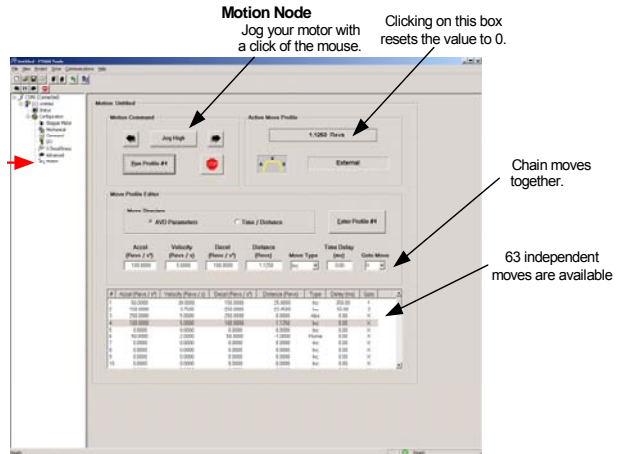

The Motion Profile Generator selects the Move Structure (Acceleration-Velocity-Distance [AVD] or Time-Distance [T/D]), and enters the parameters for a stored move. Once a move has been composed, it must be entered using the Enter Profile button.

Moves may be entered in any order and edited at will. A move profile is brought to the edit line by clicking on it in the move list. To enter a new move, click on it in the list and select a structure (AVD or T/D). Enter the various parameters represented in user unites as defined in the Mechanical screen.



### NOTE

***If the Enter Profile button is not clicked, the move is not stored and is lost. Once a move is stored, its parameters appear in the move list.***

The most popular move structure is AVD. The programmer must specify both acceleration and deceleration rates along with velocity, distance, move type, time delay, and GoTo index, if needed.

For convenience, a move may be copied, pasted, or deleted by right-clicking on the target in the move list. Moves are anchored to the index at which they are entered. Deleting a move does not cause the others to shift up to fill the gap. The only way to relocate a move is to copy, paste, and then delete from the original position.

It is impossible to enter a set of move parameters that are inconsistent. For instance, it may be impossible to reach the target velocity using the specified acceleration in the programmed distance. If the programmed parameters do not define an attainable trapezoidal move, the Generator offers to collapse the move into a triangular profile by adjusting the velocity. The move engine cannot execute moves that have inconsistent parameters.

Individual Motion Profiles are executed in the following manner:

Up to six of the digital inputs may be programmed as Move Select. These inputs now function as binary coded decimal bits. Inputs must be programmed for this function, starting with the LSB-Input #1 and proceeding sequentially until the desired number of inputs are programmed for Move Select.

Input	Binary	Decimal
1	$2^0$	1
2	$2^1$	2
3	$2^2$	4
4	$2^3$	8
5	$2^4$	16
6	$2^5$	32

Initiating a programmed move from a controller works by one of the following methods:

- METHOD 1:**
1. Assert a logic signal on the appropriate MOVE SELECT inputs. For example, to execute Move #3, assert a logic signal on MOVE SELECT inputs 1 and 2.
  2. Assert a logic signal on START MOVE. The drive scans the MOVE SELECT inputs and executes the selected move. This input is edge triggered.
  3. MOVE SELECT input signals may now be terminated along with the START MOVE input.

**METHOD 2:** You may initiate a move without using START MOVE. You are limited to the following moves: 1, 2, 4, 8, 16, 32. To do this, configure as many MOVE SELECT inputs as required and **DO NOT** configure an input as START MOVE. Triggering the appropriate MOVE SELECT input initiates the selected move.



**NOTE**

*Method 1 requires that one input be programmed as Start Move. Method 2 does not.*



**NOTE**

*You need not configure more inputs for Move Select than you actually need. For example, if you have only four programmed moves, configure only Inputs 1, 2, and 3 for Move Select.*



**NOTE**

*Move Select inputs must be consecutive. It is suggested to start with input 1 and work down.*

## 5. TROUBLESHOOTING

### 5.1 COMMON PROBLEMS

Problems	Possible Fixes
Motor spins in wrong direction	Reverse wires on one phase. Change direction polarity using P7000Tools
Motion Profiles in table will not execute	The P7000 Drive is the SDN version not the PNN version,
Drive Overheats	Lower ambient temperature. Provide fan cooling. Reduce system throughput.

### 5.2 STATUS DISPLAY

There are 7 faults that may occur with the P7000 drive. The fault output latches when they occur. Determine the type of fault by viewing the front panel or through the serial port. The front panel LED turns red and blinks according to the table below.

LED Color	Blinks	Description	Cause	Solution
Green	Solid	System OK	NA	NA
Green	1	Amplifier is disabled	The enable input (J4-5 & J4-6) is not asserted if ENABLE is configured ACTIVE CLOSED or the enable input is asserted if ENABLE is configured ACTIVE OPEN.	De-assert the enable input or disable the soft shutdown from P7000Tools.
Red	Solid	FLASH memory fault	A FLASH memory checksum validation has failed indicating corruption of the operating system. This typically occurs during firmware download.	Without attempting to connect to the drive, download the most current firmware file from the P7000Tools menu option Drive->Update Operating System.... If the FLASH download utility fails, contact technical support.
Red	1	Stall Fault	The Encoderless Stall Detection feature has detected that the motor has slipped or stalled.	Reduce move profile acceleration, velocity, deceleration or load inertia. Power cycle or reset drive via Fault Reset input or P7000Tools.
Red	2	Over-current Fault	An event has occurred which caused the amplifier output current to exceed 5.6 amps.	Check motor wiring for shorts. Power cycle or reset drive via Fault Reset input or P7000Tools.
Red	3	Over-voltage Fault	A regenerative event has occurred which forced the bus voltage above 91 VDC. Incoming AC line voltage too high.	Reduce deceleration, load inertia, or reduce deceleration duty cycle to allow enough time for the power dump circuit to recover. Power cycle or reset drive via Fault Reset input or P7000Tools.
Red	4	Drive Over-temp Fault	The temperature of the heatsink has exceeded 70° C.	Reduce ambient temperature or system duty cycle. Power cycle or reset drive via Fault Reset input or P7000Tools.

LED Color	Blinks	Description	Cause	Solution
Red	5	System Fault	An error occurred while attempting to converge on a solution while running the Motor Probe or Auto X-Smoothness Probe.	Power cycle or reset drive via Fault Reset input or P7000Tools.
Red	6	Under-voltage Fault	Attempting to operate the unit at a bus voltage below 10 VDC. Incoming Power Supply voltage too low.	Power cycle or reset drive via Fault Reset input or P7000Tools.
Red	7	EEPROM Checksum Fault	User non-volatile memory checksum validation has failed indicating user setup corruption.	Restore default configuration from the P7000Tools menu option Drive->Restore Default Configuration...
Red	8	Open Phase Fault	A motor phase is open	Check continuity of motor cable and motor windings.
Red	Constant Blinking	Processor Fault	Illegal Address	Contact technical support.
Alternating Red & Amber	Multi	Processor Fault	Internal system error.	Contact technical support.
Alternating Red & Green	Fast	Motor being probed	Part of setup process.	
Alternating Red & Green	Slow	End of Travel	An End of Travel input has been activated	Determine cause of activation.

The blinking continues until the drive is reset by one of the following methods:

- Power Cycle
- GUI Control
- Fault Reset (Configurable General Purpose Input)

## 5.3 SAFETY

As the user or person applying this unit, you are responsible for determining the suitability of this product for the application. In no event will Kollmorgen be responsible or liable for indirect or consequential damage resulting from the misuse of this product.

Read this manual completely to effectively and safely operate the P7000.

### Comply with the applicable European standards and Directives.

#### In Germany, these include:

- DIN VDE 0100 (instructions for setting up power installations with rated voltages below 1000 V).
- DIN - EN 60204 - Part 1, (VDE 0113, part 1) instructions relative to electric equipment in machines for industrial use.
- DIN EN 50178, (VDE 0160) instructions relative to electronic equipment for use in power installations.

Insure that the motor's case is connected to PE ground. The fifth wire in the motor cable connecting J6,5 to the motor case accomplishes this.

### Motor case grounding



#### CAUTION

*If the motor is not properly grounded, dangerous voltages can be present on the motor case due to capacitive coupling between the motor windings and case.*

### Requirements for Safe Operation of the Drive

It is the machine builder's responsibility to insure that the complete machine complies with the Machine Directive (EN60204). The following requirements relate directly to the stepper controller:

### Emergency Stop



#### CAUTION

*If personal injury can result from motor motion, the user must provide an external hardwired emergency stop circuit outside the drive. This circuit must simultaneously remove power from the drive's motor power terminal J6- $\bar{A}$ , J6-A, J6- $\bar{B}$ , and J6-B.*

*Note: The motor will coast under this condition with no braking torque.*

*Note: The drive must be disabled at least 1 ms prior to interrupting motor conductors*

### Avoiding Unexpected Motion



#### CAUTION

*Always remove power from J7 and wait 2 minutes before working on the machine or working anywhere where injury can occur due to machine motion.*

### Avoiding Electrical Shock



#### CAUTION

*Never power the stepper drive with the cover removed or with anything attached to circuitry inside the cover.*

*If the drive must be removed from the cabinet, wait at least five minutes after turning off power before removing any cables from the drive or removing the drive from the mounting panel. To be safe, measure the electrical contact points with a meter before touching the equipment.*

*Never connect or disconnect any wiring to the drive while power is applied. Always power down and wait two minutes before connecting or disconnecting any wires to the terminals.*

## Avoiding Burns



*The temperature of the drive's heat sink and housing may exceed 70°C. Therefore, there is a danger of severe burns if these regions are touched.*

### **CAUTION**

#### **Preventing Damage to the Drive**

Follow these guidelines to prevent damage to the stepper drive during operation:

- Never plug or unplug connectors with power applied.
- Never connect or disconnect any wires to terminals with power applied
- If the drive indicates a fault condition, find the cause of the fault and fix it prior to resetting the fault or power-cycling the drive.

## 5.4

## **FIRMWARE UPGRADE PROCEDURES**

1. Note the current operating system version is the Status screen.
2. Check Kollmorgen's website to see if a new version is available.
3. Download the new version (if appropriate) and move it into the P7000 directory.
4. Perform the following steps in P7000Tools:



### **NOTE**

*Save your current drive configuration file and rename it or it will be erased during this process*

- a. Establish communication between the PC and the drive.
- b. Select DRIVE.
- c. Select DRIVE OPERATING SYSTEM.
- d. Review and answer YES to the first prompt if you wish to proceed.
- e. Review and answer YES to the second prompt if you wish to proceed.
- f. Select the version of firmware you wish to load. If your current version is vXXXpilt.dcv, select the newer version of the vXXXpilt.dcv. If your current version is vXXXB\_A1.dcv, select the newer version vXXXB\_A1.dcv.
- g. The loader will now execute the download to the drive.



# APPENDIX A

## A.1 POWER SUPPLY SELECTION

The power supply **MUST** have an output capacitor that meets the drive minimum requirements. In an unregulated supply the Cbus min requirements are normally met by the output filter capacitor built into the power supply. If a regulated power supply is used, Cbus min should be added across the output of the supply.

The DC P7000 drive has a small internal bus capacitor of 200  $\mu\text{f}$ . This absorbs most of the high frequency PWM ripple current, but it is not large enough to handle the peak power demands of the motor during rapid acceleration and deceleration.



→Do not skimp on Bus Capacitance.

### WARNING

Drives are difficult loads for supplies. Drives can have high peak power flows in and out as the load accelerates and decelerates. The DC P7000 does not have any internal means to dissipate regenerated motor energy. Energy regenerated back to the supply must be absorbed capacitively with a limited increase in bus voltage.

For a single drive load related energy flows in the bus are approximately proportional to motor current and bus voltage, so the minimum bus capacitor is selected so that capacitive energy storage scales with motor current and bus voltage. Capacitance rises as bus voltage drops to compensate for the fact that energy storage in a capacitor goes down as the square of voltage.

## A.2 CBUS MIN

Motor Current (rms per phase)	Bus Voltage		
	24 V nom	48 V nom	75 V nom
5 A	18,000 $\mu\text{f}$	9,000 $\mu\text{f}$	6,000 $\mu\text{f}$
3 A	10,800 $\mu\text{f}$	5,4000 $\mu\text{f}$	3,600 $\mu\text{f}$
1.5 A	5,400 $\mu\text{f}$	2,700 $\mu\text{f}$	1,800 $\mu\text{f}$

Capacitor type is a general purpose, 85C, aluminum electrolytic, screw terminal, can. For 75 V bus select a 100 V rated capacitor; for a 48 V bus select a 63 V or 75 V rated capacitor; for a 24 V bus select a 35 V or 40 V rated capacitor. For example, Cornell Dubilier DCMC, 85C, High Capacitance, Computer Grade, Aluminum.

6,000  $\mu\text{f}$ , 100 V DCMC602U100EA2B 1.75 in dia x 2.125 in

### Example of a Simple, Unregulated, Isolated Offline DC Power

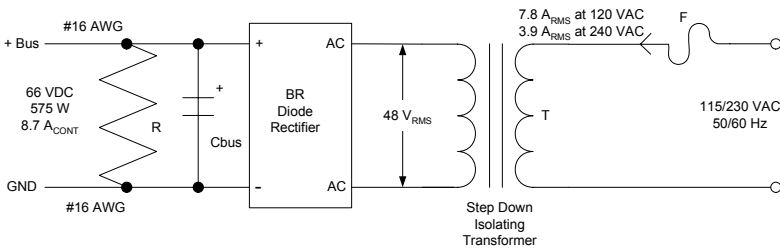

#### Vbus Spec

- 79 VDC at 0 W load, 264/132 VAC line
- 69 VDC at 0 W load, 230/115 VAC line
- 66 VDC at 575 W load, 230/115 VAC line
- 56 VDC at 489 W load, 195/98 VAC line

#### Materials

- T — 115/230 VAC to 24/48 VAC step down transformer, 900 VA, 4,000 V Isolation  
5.25 x 5.2 x 4.8, ht 20 lb, Signal MPI-900-48
- BR — 25 A, 200 V, single phase bridge rectifier, 1.14 x 1.14  
General Semiconductor GBPC2502
- Cbus — 20,000  $\mu\text{f}$ , 100 V aluminum capacitor, computer grade, 85C, 2 dia x 4.125 ht  
Cornell Dubilier DCMC203U100BC2B
- F — 250 VAC, Type 3AB, slo-blo fuse, 1.25 x 0.25  
115 VAC line: 15 A rated, Littlefuse 326015  
230 VAC line: 7 A rated, Littlefuse 326007
- R — 1 k, 10 W, wirewound, aluminum housed chassis mount resistor, 1.42 x 0.62  
Huntington Electric TMC-10-1-0K

For multiple drives on the same supply a conservative rule is to scale up the capacitance by the number of drives on the supply. For a large number of drives on the same supply with moves that are uncorrelated it may be adequate to increase the minimum capacitance by the square root of the number of drives.

$$C_{bus\ min} = 6,000\ \mu f \times (\text{motor } A_{RMS}/5A_{RMS}) \times (75\ \text{V}/\text{bus voltage}) \times (\# \text{ of Drives})$$

The recommended minimum capacitance will handle matched inertias with most motors, but if the application has high regenerated energy, then more bus capacitor than the minimum may be needed.

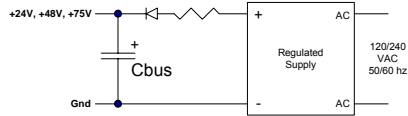

(Optional) Regulated, Isolated Supply

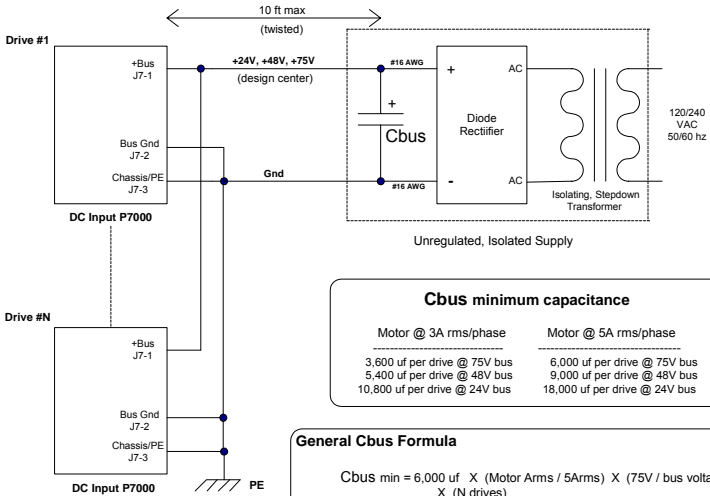



## A.3 REGULATORY INFORMATION

### A.3.1 USE CONFORMING REQUIREMENTS

The equipment described herein has been developed, produced, tested and documented in accordance with the corresponding standards. During use conforming with requirements, the equipment is not dangerous for people or equipment. Use conforming with requirements means that the safety recommendations and warnings detailed in this manual are complied with and that the applicable regulations for safety (machine directives, etc.) and noise suppression (EMC Directives) are observed while operating the drive.

At the end of its lifetime, dispose of or recycle the drive according to the regulations applicable at that time.

### A.3.2 CE-APPROVAL

The CE initials confirm that the P70360 drives satisfy all requirements of CE Directives.

The equipment is not ready to operate without additional installations (cable, motor, etc.). Thus, all necessary tests and measurements had to be made on a typical installation. The test installation with all peripheral devices, as well as the test results and measurements are recorded in detail in documentation that is available from the manufacturer on request. The test installation, to which the Declaration of Conformity refers to, is described in section A.3.3.

#### Drive CE EMC compliance and machine CE EMC compliance

***If the connection method on your machine is different from the one described in section A.2.1, or in the event of use of components other than those that we have specified, adherence to CE interference limit values cannot be guaranteed.***



#### **NOTE**

***The machine builder should incorporate good EMC installation and wiring practices in the machine design. Some machine designs will require more EMC consideration than others, for example a multi-axis machine will generate more noise than a single axis machine therefore it may require the incorporation of additional noise reduction techniques.***

### A.3.3 THE CE TEST SETUP CONSISTED OF THE FOLLOWING:

- Branch Circuit Protection – 240V, 20A UL listed breaker
- Line Filter - Corcom 6EQ1
- Drive – Kollmorgen's P70360
- Motor Power Cable (To J6) – Brad Harrison Cable Assembly 105000A03F5002, (foil shielded, #16 AWG, 5 conductor, 15m)
- Ferrite on Motor Power Cable – Steward 28A2029-0A0
- Motor – Kollmorgen's Powerpac N32HCLS-LEK-PF-02
- I/O Cable (To J4) – Belden 82509 (9 pair, #24 AWG, foil shielded, 1 m)
- Ferrite on I/O Cable – Fair-rite 0444167281
- Speed Controller (To J4 via I/O cable) – Kollmorgen Speedbox
- Serial Cable (To J5) – Not Populated, parallel connections wired through J4 connector

#### **Declaration of Conformity**

In our Declaration of Conformity, we affirm our compliance with Directive 73/23/EEC (Low voltage Directive) and with Directive 89/336/EEC (EMC Directive).

For the P70360-PNN and P70360-SDN EMC testing was done according to EN61800-3:1997 with the incorporation of amendment A11:2000 (Emission limits according to chapter 6.3.1 of that regulation, First environment / restricted distribution).

During assembly of our product in a machine, startup (that is, normal operation) is prohibited until the end-product complies with Directive 89/392/EEC (Machine Directive) and directive 89/336/EEC (EMC Directive).

The machine manufacturer must prove that the complete system conforms with all relevant European Directives.

Drive conformance to specified standards is certified by the Declaration of Conformity on the following page.

**KOLLMORGEN**<sup>™</sup>Doc. No. P7AF000ERev. No. 3**We, the company****Kollmorgen Corporation  
201 West Rock Road  
Radford, VA 24141****Hereby in sole responsibility declare the conformity of the product series****Kollmorgen Digital Stepper Drives**Which includes the models: **P70360 or P70530 followed by PN, SD, R4N.****With the following standards:**

- *Low Voltage Directive 73/23/EEC*
- *EMC Directive 89/336/EEC*

**European Harmonized, National, & International Standards****EN 50178****EN 61800-3**

*Product has been reviewed, tested, and found to be in conformity with the above standards. Product has also been reviewed per UL508C, IEC 721-3-2, and IEC 721-3-3.*

**For recommended configurations see the installation manual or instructions (M-SD-7AC-01 or M-SD-7DC-01).****This Declaration does not contain any assurance of properties in the meaning of product liability.****The notes on safety and protection in the operating instruction must always be observed.****The above-mentioned company has the following technical documentation for examination:**

- **Proper operating instruction**
- **Diagrams**
- **Other technical documentation (for EU authority only)**
- **Technical construction file (for EU authority only)**

**Signed:****Title:****Steven McClellan      February 2, 2012**  
Electronic Engineering Manager**Address:****Kollmorgen Corporation  
201 Rock Road  
Radford, VA 24141-4099**

<b>ECN:</b>		<b>Copy Code</b>	<b>T</b>				
-------------	--	------------------	----------	--	--	--	--

# INDEX

## A

AC Mounting, 5  
Accessories, 3

## C

Command I/O, 8

## D

Drive Configuration, 17  
  Current Reduction, 19  
  Dynamic Smoothing, 19  
  Load Inertia, 18  
  Motor Selection, 17  
  Multi-Stepping, 19  
  Stall Detection, 20  
  Step Resolution, 18

## G

General Purpose Inputs, 12  
Getting Started, 1  
Graphic User Interface  
  Custom Motor File, 26  
  I/O, 29  
  Toolbars, 22

## I

Inspecting, 2

## J

J2 & J3 Connector  
  RS485, 15, 16  
J4 Connector  
  Command I/O, 8

## M

Motor Connection, 8

## O

Outputs  
  Fault, 13  
Outputs  
  General Purpose, 13

## P

P70530  
  Cbus  
    formula for multiple drives, 43  
    single drive, 42  
  power supply  
    internal bus capacitor, 41  
    minimum bus capacitance, 41  
  unregulated, isolated offline DC power  
    example, 42  
Part Number, 2

## R

RS485, 15, 16

## S

Safety Requirements, 38  
Set-Up Wizard, 21  
Specifications, 3  
  Drive Power, 3  
  Environmental, 5  
  I/O, 4  
Step & Direction Inputs, 9

## T

Troubleshooting, 37  
  Common Problems, 37  
  Status display, 37

## U

Unpacking, 2  
Using P7000 Tools  
  GUI, 21



## W

Wiring, 7

Connector Locations, 7



## **Sales and Service**

Kollmorgen is committed to quality customer service. Our products are available world-wide through an extensive authorized distributor network. To serve in the most effective way, please contact your local sales representative for assistance. If you are unaware of your local sales representative, please contact us.

### **Europe**

#### **Kollmorgen Customer Service Europe**

Email: [sales.europe@kollmorgen.com](mailto:sales.europe@kollmorgen.com)

Phone: +49(0)203 9979 0

Fax: +49(0)203 9979 155

Web: [www.Kollmorgen.com](http://www.Kollmorgen.com)

### **North America**

#### **Kollmorgen Customer Service North America**

Email: [support@kollmorgen.com](mailto:support@kollmorgen.com)

Phone: 1-540-633-3545

Fax: 1-540-639-4162

Web: [www.Kollmorgen.com](http://www.Kollmorgen.com)

**KOLLMORGEN**®

---

*Because Motion Matters™*