

Panasonic[®]

Operating Instructions SD Video Camera

Model No. **SDR-S100**

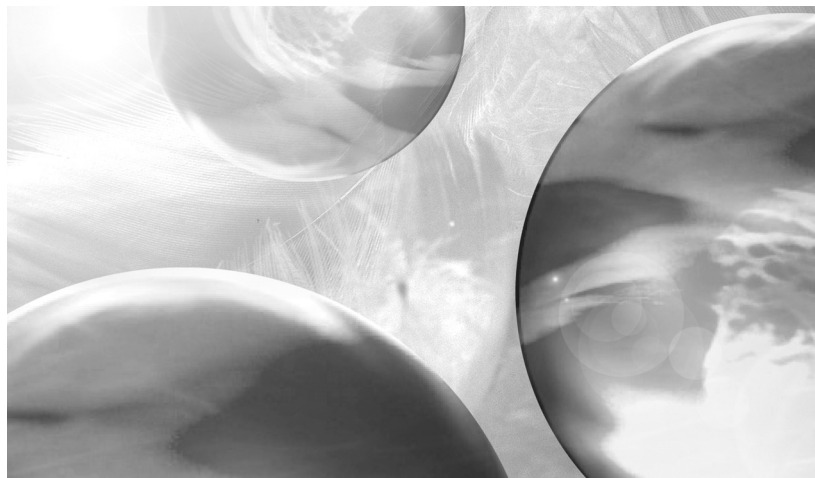

Before connecting, operating or adjusting this product, please read the instructions completely.



PictBridge

LEICA DICOMAR

For USA assistance, please call: 1-800-272-7033 or, contact us via the web at:
<http://www.panasonic.com/contactinfo>

For Canadian assistance, please call: 1-800-561-5505 or visit us at www.panasonic.ca

PP

VQT0T50

Before opening the CD-ROM package, please read the following.

End User License Agreement

You ("Licensee") are granted a license for the Software defined in this End User License Agreement ("Agreement") on condition that you agree to the terms and conditions of this Agreement. If Licensee does not agree to the terms and conditions of this Agreement, promptly return the Software to Matsushita Electric Industrial Co., Ltd. ("Matsushita"), its distributors or dealers from which you made the purchase.

Article 1 License

Licensee is granted the right to use the Software, including the information recorded or described on the CD-ROM, instruction manuals, and any other media provided to Licensee (collectively "Software"), but all applicable rights to patents, copyrights, trademarks and trade secrets in the Software are not transferred to Licensee.

Article 2 Use by a Third Party

Licensee may not use, copy, modify, transfer or allow any third party, whether free of charge or not, to use, copy or modify the Software, except as expressly provided for in this Agreement.

Article 3

Restrictions on Copying the Software

Licensee may make a single copy of the Software in whole or in part solely for back-up purpose.

Article 4 Computer

Licensee may use the Software only on one computer, and may not use it on more than one computer.

Article 5

Reverse Engineering, Decompiling or Disassembly

Licensee may not reverse engineer, decompile, or disassemble the Software, except to the extent either of them is permitted under law or regulation of the country where Licensee resides. Matsushita, or its distributors will not be responsible for any defects in the Software or damage to Licensee caused by Licensee's reverse engineering, decompiling, or disassembly of the Software.

Article 6 Indemnification

The Software is provided "AS-IS" without warranty of any kind, either expressed or implied, including, but not limited to, warranties of non-infringement, merchantability and/or fitness for a particular purpose. Further, Matsushita does not warrant that the operation of the Software will be uninterrupted or error free. Matsushita or any of its distributors will not be liable for any damage suffered by Licensee arising from or in connection with Licensee's use of the Software.

Article 7 Export Control

Licensee agrees not to export or re-export to any country the Software in any form without the appropriate export licenses under regulations of the country where Licensee resides, if necessary.

Article 8 Termination of License

The right granted to Licensee hereunder will be automatically terminated if Licensee contravenes any of the terms and conditions of this Agreement. Upon termination hereof, Licensee must destroy the Software and related documentation together with all the copies thereof at Licensee's own expense.

Contents

End User License Agreement	2
----------------------------------	---

Preparation

Information for your safety	5
Introduction	7
Accessories	9
Parts identification and handling	10
Inserting/Removing an SD card.....	14
Inserting/Removing the Battery	16
Charging the Battery.....	17
Turning the unit on/off.....	18
Selecting a mode.....	20
Using the LCD monitor	21
Using the cursor button	22
One-touch navigation	
Using the menu screen.....	26
Setting date and time.....	28
Adjusting LCD monitor.....	29

Recording

Check before recording.....	31
Motion picture recording (MPEG2 motion pictures).....	33
Zoom in/out function	36
This is for moving the zoom lever to adjust the magnification.	
Tele-macro function.....	37
This is for bringing only what you want to record into focus to take close-ups.	
Soft skin mode	38
This makes skin colors appear softer for a more attractive appearance.	
Backlight compensation function ...	39
This is for protecting a backlit subject from being darkened.	
Wind noise reduction function	40
This is for reducing the wind noise coming into the microphone when recording.	
Wide mode	40
This is for selecting the screen's aspect ratio when recording motion pictures.	

Image stabilizer function	41
This is for reducing image shakes during recording.	
MagicPix functions	42
This allows recording in dark locations.	
Scene mode	43
This is for recording in various situations.	
Manual focus adjustment.....	45
This allows subjects to be focused manually.	
White balance	46
This is for recording in natural colours.	
Manual shutter speed/aperture adjustment	48
Still picture recording (JPEG still pictures)	50
Built-in flash	54
Self-timer recording.....	56
This is for recording using the timer.	

Playback

Motion picture playback (MPEG2 motion pictures).....	57
Still picture playback (JPEG still pictures)	60
Deleting scenes.....	62
This is for deleting scenes recorded on SD cards.	
Locking scenes	64
This is for preventing scenes from being deleted by mistake.	
Formatting an SD card	65
This is for initializing (formatting) cards.	
DPOF setting	66
This is for writing the printing data on an SD card.	
PictBridge	67
This is for printing pictures by directly connecting to the printer.	
Playback on TV	70
Using this unit's recorded data on other devices	72
This is for copying recordings from a DVD recorder's SD card slot onto its hard disk.	

PC

With a PC.....	73
Installing MotionSD STUDIO	77
Installing the Web Camera Driver	78
Connection and recognition procedures	80
Using MotionSD STUDIO	82
Reading the MotionSD STUDIO operating instructions.....	83
Using the unit as a Web Camera.....	83
To disconnect USB cable safely	84
Software application uninstallation	85
Verifying the driver.....	86

Details

Approximate Number of Recordable Pictures on an SD Card	88
Menu list.....	89
Setup menu.....	91
Indications	92
Functions that cannot be used simultaneously.....	97
Troubleshooting	98

Others

About condensation.....	102
Explanation of terms.....	103
Cautions for Use.....	105
Specifications	108
Limited Warranty (For USA Only)	110
Customer Services Directory (For USA Only)	112
Warranty (For Canadian Customers).....	114
Index	115
Spanish Quick Use Guide/ Guía rápida para el usuario en español	116

Information for your safety

WARNING

TO REDUCE THE RISK OF FIRE OR SHOCK HAZARD AND ANNOYING INTERFERENCE, USE ONLY THE RECOMMENDED ACCESSORIES AND DO NOT EXPOSE THIS EQUIPMENT TO RAIN OR MOISTURE. DO NOT REMOVE THE COVER (OR BACK); THERE ARE NO USER SERVICEABLE PARTS INSIDE. REFER SERVICING TO QUALIFIED SERVICE PERSONNEL.

THE SOCKET OUTLET SHALL BE INSTALLED NEAR THE EQUIPMENT AND SHALL BE EASILY ACCESSIBLE.

CAUTION

Danger of explosion if battery is incorrectly replaced.

Replace only with the same or equivalent type recommended by the manufacturer.

Dispose of used batteries according to the manufacturer's instructions.

IMPORTANT

■ Carefully observe copyright laws

Whatever you have recorded and created can be used for your personal entertainment only. Under copyright laws, other materials cannot be used without obtaining permission from the holders of the copyrights.

- **Injury or material damage resulting from any kind of use that is not in accordance with the operating instructions are the sole responsibility of the user.**
- If the SD Video Camera is used continuously for a long time or used at a high ambient temperature, red, blue, green or white dots may appear on the screen and be recorded on a still picture. This is due to the temperature of the SD Video Camera increasing. This is not a malfunction. Under this condition, turn the SD Video Camera off and leave it for a while.
- The manufacturer shall in no event be liable for the loss of recordings due to malfunction or defect of this SD Video Camera, its accessories or Memory Card.
- Note that the SD Video Camera may not play the data recorded or created on another product and another product may not play the data recorded on the SD Video Camera.
- The nameplate of the SD Video Camera is fixed on the bottom of the battery compartment.

FCC Note: (U.S. only)

This equipment has been tested and found to comply with the limits for a Class B digital device, pursuant to Part 15 of the FCC Rules. These limits are designed to provide reasonable protection against harmful interference in a residential installation. This equipment generates, uses, and can radiate radio frequency energy and, if not installed and used in accordance with the instructions, may cause harmful interference to radio communications. However, there is no guarantee that interference will not occur in a particular installation. If this equipment does cause harmful interference to radio or television reception, which can be determined by turning the equipment off and on, the user is encouraged to try to correct the interference by one or more of the following measures:

- Reorient or relocate the receiving antenna.
- Increase the separation between the equipment and receiver.
- Connect the equipment into an outlet on a circuit different from that to which the receiver is connected.
- Consult the dealer or an experienced radio/TV technician for help.

FCC Caution:To assure continued compliance, follow the attached installation instructions and use only shielded interface cables with ferrite core when connecting to computer or peripheral devices.

Any changes or modifications not expressly approved by the party responsible for compliance could void the user's authority to operate this equipment.

Trade Name: Panasonic

Model No.: SDR-S100

Responsible party:

Panasonic Corporation of North America
One Panasonic Way, Secaucus, NJ 07094

Support Contact:

Panasonic Consumer Electronics Company
1-800-272-7033 This device complies with Part 15 of the FCC Rules. Operation is subject to the following two conditions: (1) This device may not cause harmful interference, and (2) this device must accept any interference received, including interference that may cause undesired operation.



This Class B digital apparatus complies with Canadian ICES-003.



A lithium ion/polymer battery that is recyclable powers the product you have purchased. Please call 1-800-8-BATTERY for information on how to recycle this battery.

U.S. Patent Nos. 4,631,603, 4,577,216, 4,819,098, and 4,907,093.

This product incorporates copyright protection technology that is protected by U.S. patents and other intellectual property rights. Use of this copyright protection technology must be authorized by Macrovision, and is intended for home and other limited consumer uses only unless otherwise authorized by Macrovision. Reverse engineering or disassembly is prohibited.

-If you see this symbol-

Information on Disposal in other Countries outside the European Union



This symbol is only valid in the European Union. If you wish to discard this product, please contact your local authorities or dealer and ask for the correct method of disposal.

Introduction

Dear Customer,

We would like to take this opportunity to thank you for purchasing this Panasonic SD Video Camera. Please read these Operating Instructions carefully and keep them handy for future reference.

■ Try out the SD Video Camera

Be sure to try out the SD Video Camera before recording your first important event and check that it records properly and functions correctly.

■ About the photographs and illustrations in these operating instructions

Please note that the actual controls and components, menu items, etc. of your SD Video Camera may look somewhat different from those shown in the illustrations in these Operating Instructions.

■ Pages for reference

Pages that you should refer to are shown as **(P00)**.

■ Use only the recommended accessories.

- Do not use any other multi cables and USB cables except the supplied one.
- When you use headphones which are sold separately, please make sure the total length of the headphones including the headphone adaptor is less than 3 m (9.9 feet).

■ Cards that you can use with this unit

On this unit, you can use SD Memory Cards of the following capacity (from 8 MB to 2 GB).

8 MB, 16 MB, 32 MB, 64 MB, 128 MB, 256 MB, 512 MB, 1 GB, 2 GB (Maximum)
--











Please confirm the latest information on the following website. (This website is in English only.)
--

http://panasonic.co.jp/pavc/global/cs/e_cam

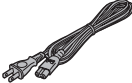
- Refer to page 34 for information about the kinds of SD Memory Cards that can be used for motion picture recording.
 - If the SD Memory Card is formatted on other equipment, the time spent for recording may become longer or the SD Memory Card may not be recognized. Format the SD Memory Card on this unit, in this case. **(Do not format it by Explorer on the PC.)**
 - This unit supports SD Memory Cards formatted in FAT12 system and FAT16 system based on SD Memory Card Specifications.
-
- You are not allowed to reproduce (copy), or transfer to a network, any part of the software applications supplied with this product for commercial purposes without written authorization.
 - Panasonic will in no way be liable for any damages sustained directly or indirectly from the use of this product or from any trouble occurring therein.
 - Panasonic will also in no way be liable for any losses of data caused by this product.
 - For the purposes of these operating instructions, the battery pack is referred to as “the battery” and the SD Memory Card as “the SD card.”
 - SD Logo is a trademark.
 - Microsoft and Windows are either registered trademarks or trademarks of Microsoft Corporation in the United States and/or other countries.
 - Leica is a registered trademark of Leica microsystems IR GmbH and Dicomar is a registered trademark of Leica Camera AG.
 - Screen shot(s) reprinted with permission from Microsoft Corporation.
 - Other names of systems and products mentioned in these instructions are usually the registered trademarks or trademarks of the manufacturers who developed the system or product concerned.

Accessories

Check the accessories before using this unit.

SD Memory Card (2 GB) RP-SDQ02G 	Wireless remote control N2QACC000008 Button-type battery CR2025 
Battery pack CGA-S303 	Hand strap VFC4127 
AC cable K2CA2CA00025 	USB cable VFA0454 
AC adaptor VSK0681 	Headphone cable K2KZ99Z00001 
Multi cable K2KZ9CB00001 	CD-ROM 

Optional Accessory

Battery Pack

CGA-S303

Parts identification and handling

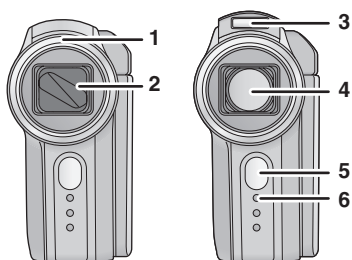

- 1 Lens hood (P11)
- 2 Lens cover
- 3 Built-in flash (P54)
- 4 Lens (LEICA DICOMAR)
- 5 Remote Control Sensor (P13)
- 6 Indication lamp (P32)
- 7 Tripod mount (P11)

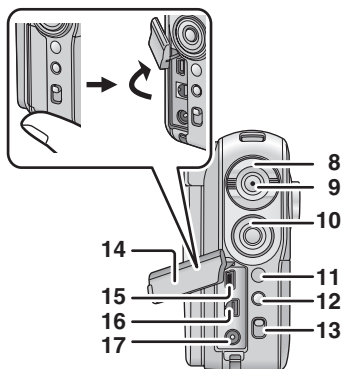
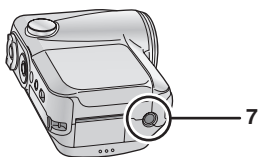

- 8 Zoom lever [W/T] (P36)
- Volume lever [+VOL-] (P58)
- 9 Record button (P33, 50)
- 10 Cursor button (P22)
 - Press up, down, left or right to select items.
 - Press the button in the center to enter the selection.
- 11 Menu button [MENU] (P26)
- 12 Delete button [] (P62)
- 13 Mode select switch [AUTO/MANUAL/ FOCUS] (P32, 43 to 48)
- 14 Terminal cover (P67, 70, 80)
- 15 USB terminal [] (P67, 80)
- 16 Multi-connector [MULTI] (P12, 70)
- 17 DC input terminal [DC IN 9.3V] (P17)

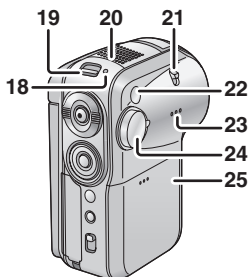

- 18 Status indicator (P17 to 19)
- 19 Power switch [ON/OFF] (P18)
- 20 Microphone (built-in, stereo)
- 21 Flash lever [OPEN] (P54)
- 22 White balance sensor (P47)
- 23 Speaker (P58)
- 24 Mode dial (P20)
- 25 Battery cover (P16)

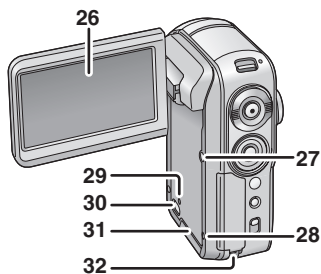

26 LCD monitor (P21, 107)

Due to limitations in LCD production technology, there may be some tiny bright or dark spots on the LCD monitor screen. However, this is not a malfunction and does not affect the recorded picture.

27 Power LCD button [POWER LCD] (P30)

28 Reset button [RESET] (P101)

29 Card access lamp [ACCESS] (P15)

30 Card slot open lever (P14)

31 Card slot cover (P14)

32 Strap fixture (P12)

Lens hood

- ❶ In order to remove the lens hood, rotate it counter-clockwise.
- ❷ In order to fit it, put into slot ^(A), and then rotate it clockwise.

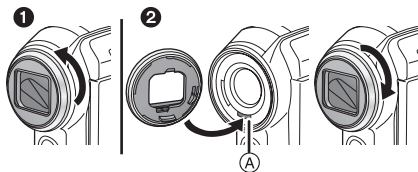

Tripod mount

This is a hole for attaching this unit to a tripod (optional). (Please carefully read the operating instructions for how to attach the tripod to the unit.) This unit does not have a hole for a tripod pin so attach it to a tripod without a tripod pin. If you try to forcibly attach this unit to a tripod with a fixed tripod pin, this unit may get scratched or damaged.

- When a tripod is used, you can perform operations easily using the remote control.
- When the tripod is used, the card slot cover and battery cover cannot be opened. Insert an SD card or the battery before attaching this unit to the tripod. (P14, 16)

- ❶ Camera base

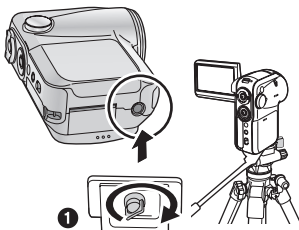

Multi-connector [MULTI]

Only connect the supplied multi cable and supplied headphone cable to this connector as the sound may not be output correctly if you connect other cords.

- **Connecting headphones ① (optional: \varnothing 3.5 mm stereo mini plug) using the headphone cable (supplied) ②**

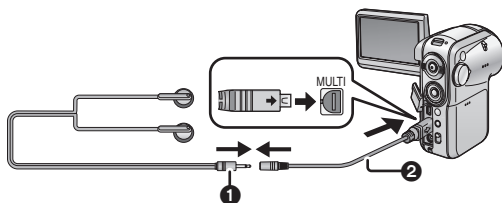

Hand strap fixture

We recommend using the hand strap (supplied) to prevent the unit from dropping.

- ① Hand strap

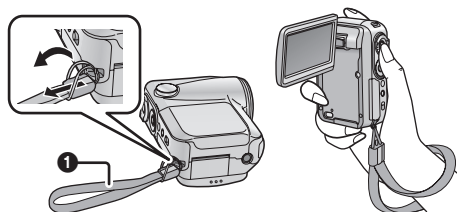

Remote control

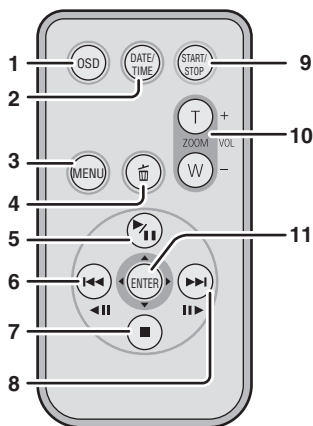

- 1 On-screen display button [OSD] (P71)
- 2 Date/time button [DATE/TIME] (P29)
- 3 Menu button [MENU] (P26)
- 4 Delete button [] (P63)
- 5 Playback/Pause button [] (P13, 57, 60)*
- 6 Fast-rewind button [] (P13, 57, 60)*
- 7 Stop button [] (P13, 57, 60)*
- 8 Fast-forward button [] (P13, 57, 60)*
- 9 Recording start/stop button [START/STOP]*
- 10 Zoom/volume button [T]/[W]*
- 11 Enter button [ENTER] (P13)

* Recording operations, playback operations and volume adjustment

These buttons work in the same way as the corresponding buttons on this unit.

■ Install a button-type battery (supplied) in the remote control

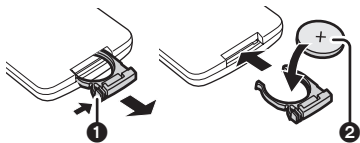

- 1) While pressing the stopper ❶, pull out the battery holder.
- 2) Set the button-type battery with its (+) mark facing upward ❷ and get the battery holder back in place.

■ About the button-type battery

- When the button-type battery runs down, replace it with a new battery (CR2025).
The battery typically lasts about one year; the actual life may be less with heavy use.
- Keep the button-type battery out of the reach of children.

Warning

Danger of explosion if battery is incorrectly replaced.

Replace only with the same or equivalent type recommended by the equipment manufacturer. Discard used batteries according to manufacturer's instructions.

Risk of fire, explosion and burns. Do not recharge, disassemble, heat above 100 °C (212 °F) or incinerate. Keep the Button-Type battery out of the reach of children. Never put Button-Type battery in mouth. If swallowed, call your doctor.

Replace battery with Panasonic PART NO. CR2025 only. Use of another battery may present a risk of fire or explosion. Caution: Battery may explode if mistreated.

Dispose of used battery promptly. Keep away from children.

Do not recharge, disassemble or dispose of in fire.

■ Remote control usable range

The distance between the remote control and the unit: Within approx. 5 m (15 feet)

Angle: Approx. 10° up and 15° down, left, and right

❶ Remote control sensor

- The remote control is intended for indoor operation. Outdoors or under strong light, this unit may not operate properly even within the usable ranges.

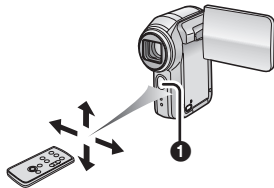

■ Operating with remote control (P26)

The menu screen transition is the same as when the buttons on the main unit are used.



1) Press the [MENU] button.

2) Select a menu item.

- The play/pause button [▶||], stop button [■], Fast-rewind button [◀◀], Fast-forward button [▶▶] and [ENTER] button can be used in place of pressing the cursor button up, down, left, right and the button in the center on this unit.

3) Press the [ENTER] button to exit the menu screen.

Inserting/Removing an SD card

Before inserting/removing an SD card, be sure to turn the power [OFF]. (P18)

If the SD card is inserted or removed with the power turned on, this unit may malfunction or the data recorded on the SD card may be lost.

1

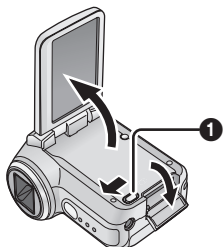

Open the LCD monitor and then slide the card slot open lever ① to open the card slot cover.

2

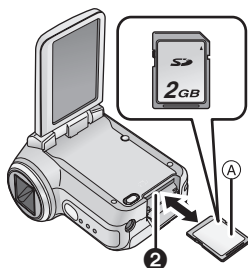

Insert/remove the SD card into/from the card slot ②.

Ⓐ Label side

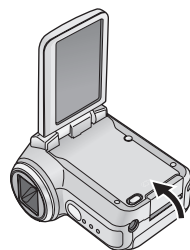

- When inserting an SD card, face the label side towards you and press it straight in with one stroke as far as it goes.
- When removing the SD card, open the card slot cover and press the center of the SD card and then pull it straight out.

3



Securely close the card slot cover.

■ About the SD Memory Cards that you can use

Recording mode	SD card capacity		
	8 MB, 16 MB	32 MB, 64 MB, 128 MB	256 MB, 512 MB, 1 GB, 2 GB (Maximum)
 Motion picture recording mode	Cannot be used.	Cannot be guaranteed in operation*	Refer to page 34.
 Still picture recording mode	Can be used.		

* The recording may suddenly stop during motion picture recording. (P35)

■ About the SD card

- Do not touch the terminals on the back of the SD card.
- Electrical noise, static electricity, or failure of this unit or the SD card may damage or erase the data stored on the SD card. We recommend saving important data on a PC by using the USB cable (supplied) or MotionSD STUDIO. (P73) (When saving images recorded using this unit to a PC, you must use MotionSD STUDIO.)
- When using an SD card on which data has been written many times, the remaining time left for recording may be reduced. (P35)

■ About the card access lamp

- When this unit accesses the SD card (reading, recording, playback, erasing, etc.), the access lamp lights up.
- If the following operations are performed when the access lamp is lit, then the SD card or the recorded data may be damaged or this unit may malfunction.
 - Opening the card slot cover and inserting or removing the SD card.
 - Operating the [ON/OFF] switch or the mode dial.

■ About the write protection switch on the SD Memory Card

- The SD Memory Card has a write protection switch  on it. If the switch is moved to [LOCK], you cannot write to the SD card, delete the data on it or format it. If it is moved back, you can.



Inserting/Removing the Battery

1

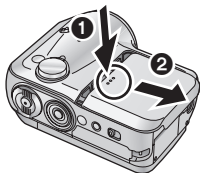

Remove the battery cover.

- 1 While pushing the battery cover,
- 2 slide it in the direction of the arrow.

2

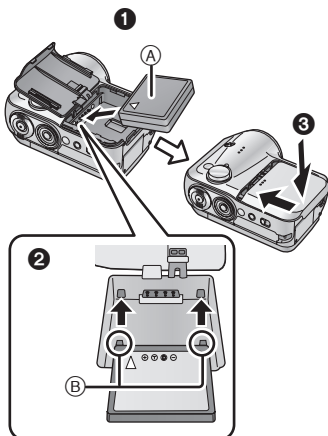

Insert the battery.

- 1 Place the battery label side up.
- 2 Insert the projecting parts of the battery in the holes on the unit.
- 3 Put the battery cover back in its original place.

- A Label
B Projecting parts

Removing the battery

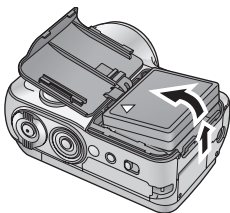

Remove the battery cover, then remove the battery.

- After removing the battery, put the battery cover back in its original place.

Charging the Battery

When this unit is purchased, the battery is not charged. Charge the battery before using this unit.

◇ **Set the power switch to [OFF]. (P18)**

Connect the AC adaptor (supplied) (A) to this unit and the AC outlet.

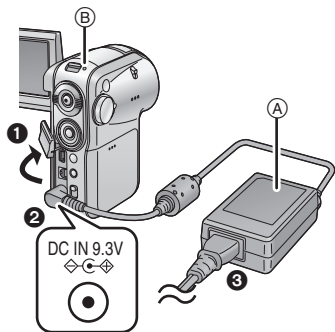

- ❶ Open this unit's terminal cover.
- ❷ Connect the AC adaptor to this unit's DC input terminal [DC IN 9.3V].
- ❸ Connect the AC mains lead to the AC adaptor, then the AC outlet.

The status indicator (B) starts blinking in red at intervals of about 2 seconds to signal that charging has commenced. Charging is completed when the lamp goes off.

- If the status indicator blinks faster or slower, refer to page 106.

The AC Cable is for use with this unit only. Do not use it with other devices or use the AC Cable for other devices with this unit.

■ Connecting to the AC outlet

If you turn on this unit while charging the battery using the AC adaptor, you can use the power supplied from the AC outlet to power the unit for use. (While it is in use, the battery will not be charged.)

■ Charging time and recordable time

The times shown in the table below show the times at a temperature of 25 °C (77 °F) and a humidity of 60%. This is just a guide. If the temperature is higher or lower than the specified value, the charging time will become longer.

- The intermittent recordable time refers to recordable time when the recording and stopping operations are repeated. In reality, it may be shorter than this.

Battery model number	Voltage/capacity	Charging time	Maximum continuously recordable time	Intermittent recordable time
Supplied battery/ CGA-S303 (optional)	7.4 V/ 760 mAh	Approx. 1 h 30 min	Approx. 1 h 20 min	Approx. 45 min

- "1h 30 min" indicates 1 hour 30 minutes.

- The recordable time will become shorter when you use this unit with the LCD monitor lit up by pressing the [POWER LCD] button.
- The batteries heat up after use or charging. The unit and the SD card also heat up during use. This is not a malfunction.

- Along with the reduction of the battery capacity, the display will change:

 . If the battery discharges, then () will flash.

Turning the unit on/off

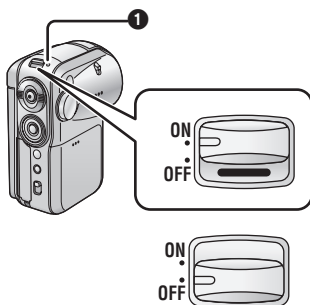

How to turn on the power Set the power switch to [ON].

The status indicator ❶ lights red and, in motion picture recording mode or still picture recording mode (P20), the lens cover opens.

How to turn off the power Set the power switch to [OFF].

The status indicator goes out and the lens cover closes.

- If the LCD monitor is closed in motion picture recording mode or still picture recording mode (P20), the power turns off.

Quick start

If quick start is set and then the LCD monitor is closed while the unit's power is still on, the unit will be ready for recording about 1.5 seconds after the LCD monitor is next opened.

Use the quick start function when stopping recording for a few moments.

- The quick start function can be set in the following cases.
 - In motion picture recording mode, when the SD card is inside this unit
 - In still picture recording mode, when the SD card is inside this unit

To set quick start function

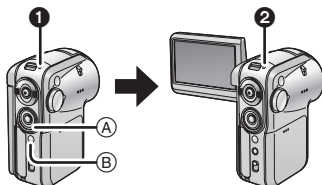
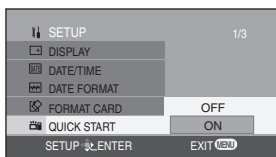

Press the menu button (B), use the cursor button (A) to select [] SETUP → [] QUICK START, and then set the function to [ON]. (P26)

When the LCD monitor is closed, the quick start standby mode is established.



- ❶ The status indicator lights green.
- If quick start is set, the lens cover does not close.

If the quick start function is set

When the LCD monitor is opened, the unit goes into recording standby.

- ❷ When the LCD monitor is opened, the status indicator lights red.

To cancel quick start

Press the menu button, use the cursor button to select [ SETUP] → [ QUICK START] → [OFF]. (P26)

- To cancel quick start standby, turn off the power.
- Quick start standby is canceled after 5 minutes have elapsed.
In this case, the unit cannot be quick-started and it takes longer for it to start operating.
- Quick start standby is canceled if the mode dial is switched to a mode other than motion picture recording mode or still picture recording mode.
- Since about half the power of normal recording is used in quick start standby, using quick start reduces the recordable time.
- If quick start is not set, it takes longer for this unit to start operating, but the amount of power consumed when the LCD monitor is closed is reduced.
- When the LCD monitor is opened in quick start standby status, the zoom magnification is set to the 1× (approximately). This may cause the size of the image to be different from the size before standby status was established.
- When this unit is quick-started with the white balance on automatic, it may take some time until the white balance is adjusted if the scene being recorded has a light source different from the scene last recorded. (When the MagicPix function is used, however, the white balance of the scene last recorded is retained.)

Selecting a mode

The Mode Dial is used to switch between recording and playback modes.
Rotate the mode dial slowly but surely.
Set the desired mode ❶.

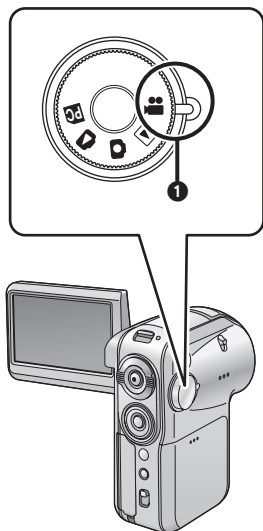

Rotate the mode dial, and set the desired mode pictograph to the position shown in the illustration.

Motion picture recording mode (P33)

Use this to record motion pictures (MPEG2).

The unit can be used as a Web camera when it is connected to a PC.



Motion picture playback mode (P57)

Use this to play back motion pictures recorded with this unit.

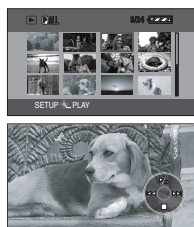

Still picture recording mode (P50)



Use this to record still pictures (JPEG).
The unit can be used as a Web camera when it is connected to a PC.

Still picture playback mode (P60)



Use this to play back still pictures recorded with this unit.

PC Connection mode (P73)

Use MotionSD STUDIO (This can be installed from the supplied CD-ROM.) to view an SD card's pictures on a PC or to import them to a PC.

Using the LCD monitor

Adjusting the monitor's angle

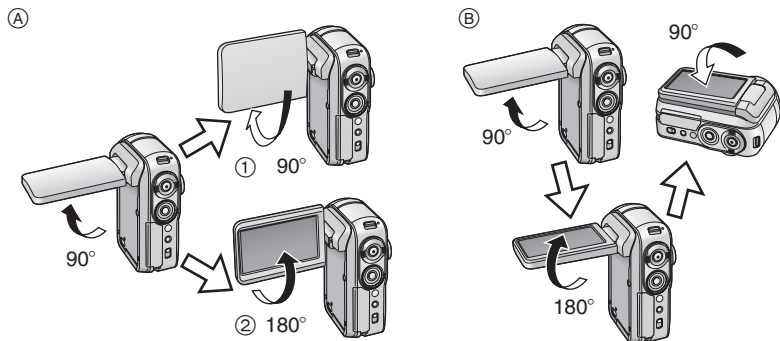

- (A) When recording
 - ① Face-to-face
 - ② Normal
- (B) When playing back

Rotating the LCD monitor beyond the angles given above may damage it.

■ About face-to-face recording

Turning the LCD monitor in direction ① is convenient for recording shots of yourself while viewing the monitor or allowing the person or persons whose shots are being recorded to watch what is being recorded.

- When using this unit for face-to-face recording, the left and right sides of the images appearing on the LCD monitor during recording are reversed.
Only some screen indications will appear on the LCD monitor. When [] appears, turn the LCD monitor in direction ②, and check the warning/alarm indications. (P94)
- When using this unit for face-to-face recording, you cannot operate the operation icons using the One-touch navigation (P22).



- The brightness and color level of the LCD monitor can be adjusted from the menu. (P29)
- If it is forcibly opened or rotated, this unit may be damaged or fail.
- Check that the card slot is closed, and then close the LCD monitor firmly.

Using the cursor button

One-touch navigation

This unit has a cursor button for selecting recording functions, performing playback operations, etc. so it is easy to operate this unit with one hand.

Press the cursor button while simultaneously viewing the screen.

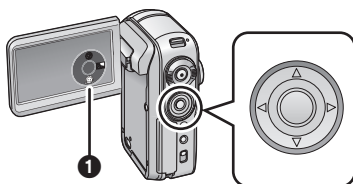

Press the cursor button to operate the operation icons **1** and menu screen **2** appearing on the LCD monitor.



Basic cursor button operations

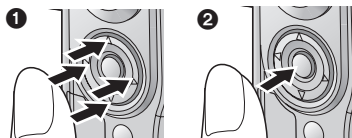

Press the cursor button up, down, left or right to select items or files **1**, and then press the button in the center to enter the selection **2**.

- Menu screen operations (P26)
- File playback selection (P57, 60)

In viewer style

When the LCD monitor is put back into place with its back facing out, the up, down, left and right positions of the cursor button change as shown in the illustration.

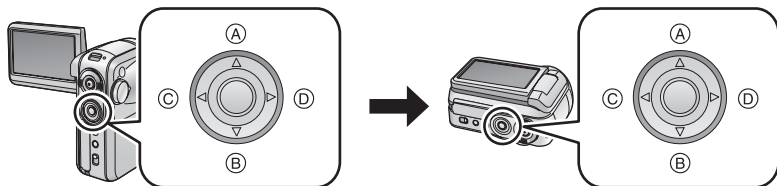

- (A) Up
- (B) Down
- (C) Left
- (D) Right

Using the recording function

◇ When the mode dial is at the  or  position

1

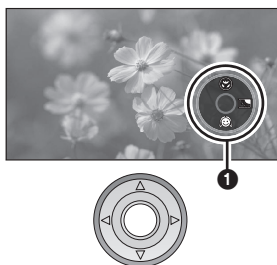

Press the button in the center.

① An operation icon appears on the LCD monitor.

While an operation icon is displayed, a blue border appears around the outside of the button in the centre of the cursor button.

- Each time the button in the center is pressed, the indication changes.

2



Press the cursor button up, down, left or right to make a selection.

Playback

◇ When the mode dial is at the  or  position

1



Press the cursor button up, down, left or right to select the file, and then press the button in the center.

All the scenes are displayed and an operation icon automatically appears.

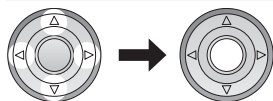

2



Press the cursor button up, down, left or right to proceed with the operation.



About the operation icons which are displayed

Each time the button in the center is pressed while an operation icon is displayed, the indication changes as shown below.

* The operation icon is off.

Motion picture recording mode ([AUTO/MANUAL/FOCUS] switch is set to [AUTO])

([AUTO/MANUAL/FOCUS] switch is set
to [MANUAL])

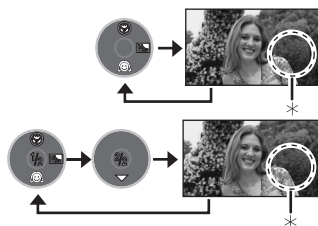

Motion picture playback mode

- The indication can also be changed during playback.



Still picture recording mode ([AUTO/MANUAL/FOCUS] switch is set to [AUTO])

([AUTO/MANUAL/FOCUS]
switch is set to [MANUAL])

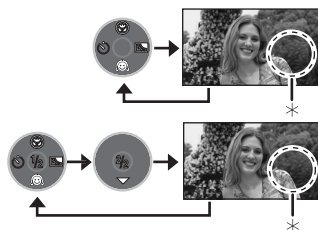

Still picture playback mode

- The indication can also be changed during playback.

































(When [PICTURE] is selected)



(When [SLIDE SHOW] is selected)



List of operation icons for each mode

Mode	Icon	Direction	Function
 Motion picture recording mode	— (1/2) 	 ▲	Tele-macro (P37)
		 ▼	Soft skin mode (P38)
		 ►	Backlight compensation (P39)
	(2/2)  (Only in [MANUAL])	 ▲	Manual adjustment mode (P47) (Only in manual white balance adjustment)
		 ▼	White balance (P46)
		 ▼	Shutter speed (P48)
		 ▼	Iris or gain value (P48)
 +  -	White balance mode selection, manual adjustments (P45, 46, 48)		
 Motion picture playback mode	— 	 ▲	Playback/pause (P57)
		 ▼	Stop playback and show thumbnails (P57)
		 ◀	Rewind, skip (during playback) (P57)
		 ◀	Reverse slow/frame playback (during pause) (P58)
		 ▶	Fast forward, skip (during playback) (P57)
		 ▶	Forward slow/frame playback (during pause) (P58)
 Still picture recording mode	— (1/2) 	 ▲	Tele-macro (P37)
		 ▼	Soft skin mode (P38)
		 ◀	Self timer (P56)
		 ►	Backlight compensation (P39)
	(2/2)	Same as motion picture recording mode (2/2)	
 Still picture playback mode	— 	 ▲	Slide show start/pause (P60) (Only when [SLIDE SHOW] has been selected.)
		 ▼	Stop playback and show thumbnails (P60)
		 ◀	Playback previous picture (P60)
		 ▶	Playback next picture (P60)

Using the menu screen

Refer to the “Menu list” (P89) for information about the menus.

1

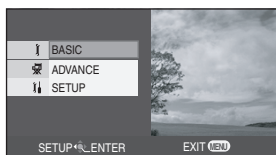

Press the [MENU] button.

The menu setting screen is displayed.
(The menu displayed differs depending on the position of the mode dial.)

- Do not switch the mode dial when the menu is displayed.
- The menu screen is not displayed during recording and playback. You also cannot record or play back while the menu screen is displayed.

2

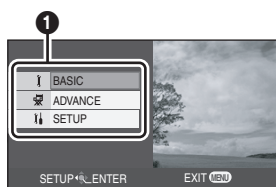

Press the cursor button up or down in order to select the desired top menu

1.

3

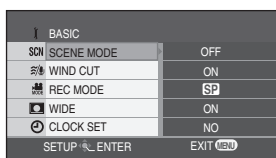

Press the cursor button right or press the button in the center.

4

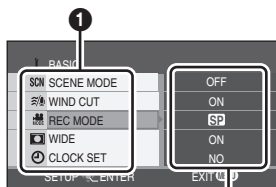

Press the cursor button up or down in order to select the submenu item.

1 Submenu

2 Current settings on menus

5

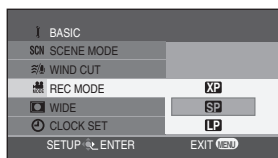

Press the cursor button right or press the button in the center.



6

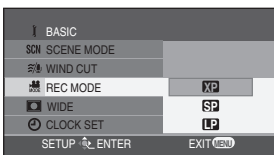

Press the cursor button up or down in order to select the desired item.

7



or



Press the button in the center to enter the selection or press the cursor button left to get back to the previous screen.

To exit the menu screen



Press the [MENU] button.

To get back to the previous screen



Press the cursor button left.

- If you change the settings for [WIDE] (P40), [PICTURE SIZE] (P52) or [TV ASPECT] (P71), the screen size changes. (If you change [PICTURE SIZE] to or from [HDTV], the size changes.)

Setting date and time



If the screen shows the incorrect date/time, then adjust it.

◇ Rotate the mode dial to select  or .

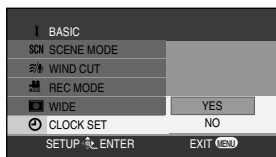
1



Press the menu button, then use the cursor button to select

[ BASIC] → [ CLOCK SET] → [YES]. (P26)

2

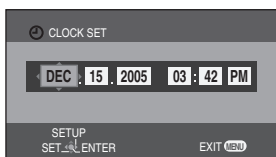

Press the cursor button left or right to select the item (year/month/day/hours/minutes) to be set. Then, press the cursor button up or down to set the desired value.

- The year will change as follows:
2000, 2001, ..., 2099, 2000, ...
- When [Y/M/D] or [D/M/Y] has been set for [DATE FORMAT], the 24-hour system is used to display the time. When [M/D/Y] has been set, the 12-hour system is used.

3

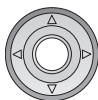



Press the button in the center to enter the selection.

- After pressing the Menu button to finish the setting, check the date and time display.
- The clock function starts at [00] seconds.

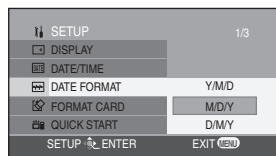
Changing the display style



Press the menu button, select [ SETUP] → [ DATE FORMAT], then use the cursor button to select the desired display style. (P26)

Display style	Screen display
Y/M/D	15:42 2005.12.15
M/D/Y	3:42 PM DEC 15 2005
D/M/Y	15:42 15.12.2005

Changing the date and time display style

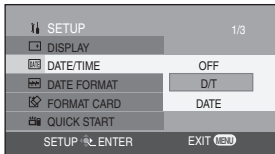

Press the menu button, select [SETUP] → [DATE/TIME], then use the cursor button to select the desired display style. (P26)

- The date and time display can also be changed by pressing the [DATE/TIME] button on the remote control.

[DATE]



[D/T]

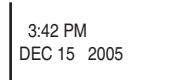

[OFF]



■ About date/time

- The date and time function are driven by a built-in lithium battery.
- Make sure to check the time before recording because the built-in clock is not very accurate.
- If [] or [--] is indicated when this unit is turned on, then the built-in lithium battery runs down. After charging the battery using the steps below, set the clock.

■ Charging the built-in battery for the date

- Connect the AC adaptor to this unit or place the battery on this unit, and the built-in lithium battery will be recharged. Leave this unit as is for approx. 24 hours, and the battery will save the date and time for approx. 6 months. (Even if the [ON/OFF] switch is set to [OFF], the battery is still being recharged.)

Adjusting LCD monitor

Adjusting the brightness and color level of the LCD monitor

1

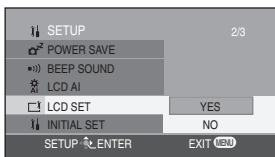

Press the menu button, then use the cursor button to set [SETUP] → [LCD SET] → [YES]. (P26)

2

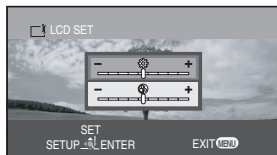

Press the cursor button up or down to select the item to be adjusted. Then, press the cursor button left or right to make the adjustment.

The bar display moves.

- : Brightness of the LCD monitor
- : Color level of the LCD monitor

- These settings will not affect the images actually recorded.

Changing the picture quality on the LCD monitor (LCD AI)

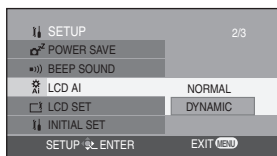

Press the menu button, then use the cursor button to select

[SETUP] → [LCD AI] → [DYNAMIC] or [NORMAL]. (P26)

- [DYNAMIC]:
The image on the LCD monitor becomes clear and vivid.
- [NORMAL]:
Switches to the standard picture quality.

- When [DYNAMIC] is set, the LCD monitor is set to the color level and brightness optimally suited for the particular scenes to be recorded. Crisp and bright images will be displayed.
- The effect will vary depending on the scene recorded.
- This function is automatically set to [DYNAMIC] when the brightness of the LCD monitor is increased (when [] is displayed) and cannot be set to [NORMAL] independently.
- This will not affect the images to be recorded.

In order to increase the brightness of the entire LCD monitor

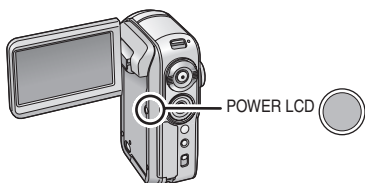

Press the [POWER LCD] button.

- [] appears on the LCD monitor.
- If the [POWER LCD] button is pressed, the entire LCD monitor will become approx. twice as bright as the normal.
- LCD stands for Liquid Crystal Display, and in this context refers to the LCD monitor.

- When the button is pressed again, [] goes off, and the original brightness is restored to the LCD monitor.
- This will not affect the images to be recorded.
- When the AC adaptor is used, [] appears automatically and the monitor becomes brighter when the power is turned on.

Check before recording

First, format the SD card if one which has been used on another device is going to be used for the first time on this unit. (P65) When the SD card is formatted, all of the recorded data (files) is deleted. Once the data is deleted, it cannot be restored. Copy valuable data onto a PC or other device before proceeding with the formatting. When copying images recorded using this unit to a PC, you must use MotionSD STUDIO. (P73)

Depending on the TV connected, the sides of the images (the part outside the dotted line) being played may not appear. We recommend widening the recording range of the objects you want to record beforehand.



- ① 16:9 screen
- ② 4:3 screen

This unit is compatible with wide-screen TVs (16:9) and set to wide mode at the time of purchase. To watch images on normal TVs (4:3), change the wide mode setting before recording (P40) or when playing back the images on the TV screen (P71).

■ Basic camera holding

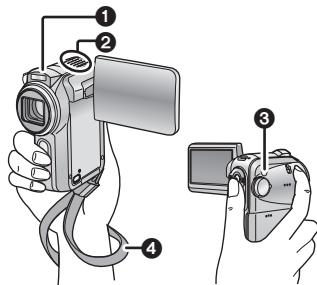

- Open the LCD monitor.
Recording cannot start when the LCD monitor is closed. However, even if the LCD monitor is closed during recording, the power does not turn off until recording is ended.
- The angle of the LCD monitor can be adjusted to suit what you want to record.
- We recommend attaching the hand strap ④ (supplied) to prevent the camera from dropping.
- Do not cover the White balance sensor ③ with your fingers, etc.
- Do not cover the lens, the front of the flash ① or the built-in stereo microphone ② with your fingers.



Check before recording (continued)

■ About the indication lamp ①

The indication lamp flashes when signals from the remote control are sensed and during self-timer operation.

When [ REC LAMP] in [ ADVANCE] is set to [ON], the lamp lights during recording. You can therefore confirm recording when this unit is attached to a tripod or when using the remote control.

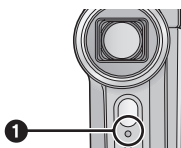

■ About the auto mode

- Set the [AUTO/MANUAL/FOCUS] switch to [AUTO], and color balance (white balance) and focusing will be adjusted automatically.

(The [] indication appears on the screen.)

- Automatic white balance: P103
- Auto focus: P104

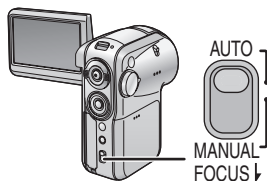

Motion picture recording (MPEG2 motion pictures)

Record motion pictures onto an SD card.

1

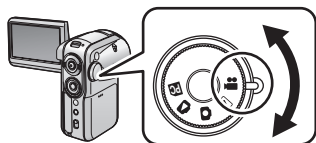

Rotate the mode dial to select .

The lens cover now opens automatically.

2

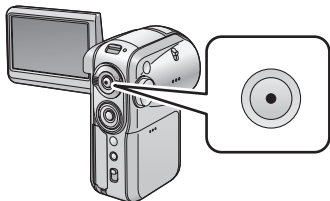



Press the record button to start recording.



Ending the recording

Press the record button again.

- 1  and  are red during recording.
- 2 Do not move this unit until  is green.



■ About the screen indications in the motion picture recording mode

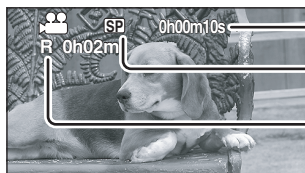

1 Recording time elapsed

2 Quality of motion picture

3 Remaining time left for recording

(When the remaining time on the SD card is less than 1 minute, [R 0h00m] flashes red.)

Changing the recording mode of the motion picture

1

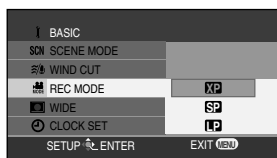

Press the menu button, then use the cursor button to select the desired recording mode by selecting [] BASIC]→[REC MODE]. (P26)

- **XP** :
Motion pictures can be recorded with the highest picture quality.
- **SP** :
Motion pictures can be recorded with normal picture quality.
- **LP** :
Motion pictures can be recorded for longer.

■ About the kinds of SD cards that can be used

We recommend using the following SD Memory Cards made by Panasonic for motion picture recording.

SD card memory	Pro High Speed SD Memory Card	Super High Speed SD Memory Card	High Speed SD Memory Card
256 MB	—	RP-SDH256	—
512 MB	RP-SDK512	RP-SDH512*	—
1 GB	RP-SDK01G	RP-SDH01G*	RP-SDQ01G
2 GB	RP-SDK02G	—	Supplied SD card/ RP-SDQ02G

* No longer made.

- Operation in motion picture recording is not guaranteed with an SD card memory from 32 MB to 2 GB except the cards above. (The recording may suddenly stop during motion picture recording.) Please confirm the latest information about SD cards that can be used for motion picture recording on the following website.

http://panasonic.co.jp/pavc/global/cs/e_cam

(This website is in English only.)

Approximate recording times of motion pictures per SD card made by Panasonic

SD card memory	XP	SP	LP
256 MB	Approx. 3 min	Approx. 6 min	Approx. 12 min
512 MB	Approx. 6 min	Approx. 12 min	Approx. 25 min
1 GB	Approx. 12 min	Approx. 25 min	Approx. 50 min
2 GB	Approx. 25 min	Approx. 50 min	Approx. 1 h 40 min

- “1h 40min” indicates 1 hour 40 minutes.

This unit records in VBR. VBR is an abbreviation for Variable Bit Rate. VBR recording automatically varies the bit rate (amount of data in a fixed time) depending on the subject being recorded. This means if a subject with sharp movements is recorded, the recording time per SD card is reduced.

■ When recording stops suddenly during motion picture recording

When using an SD card on which data has been written many times and the data writing speed has reduced, the recording may suddenly stop during motion picture recording. At this time, the following message will appear:

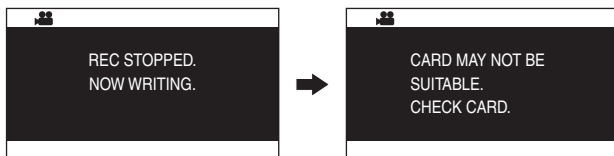



When using an SD card (P34) that can be used for motion picture recording

When this kind of message appears, it is recommended that you format the SD card being used. (P65) When an SD card is formatted, all the data recorded on it will be deleted so copy valuable data to the PC prior to formatting. (P80) (When copying data recorded using this unit, you must use MotionSD STUDIO. (P73))

When using any other card

When motion pictures are to be recorded, use a Panasonic SD card or another SD card which can be used to record motion pictures. (P34)

● Recordable time using the battery (P17)

- 8 MB and 16 MB SD cards cannot be used for motion picture recording.
- If the write protection switch on the SD card is set to [LOCK], it cannot be used for recording. (P15)
- Even if there is available memory for recording on the SD card, it may not be possible to record.
- The sound is recorded in stereo.
- The recorded scenes are recorded on the SD card as one motion picture scene.
- When recording is resumed after it was stopped, the scenes will be saved in a different scene.
- When recording motion pictures, do not remove the battery or disconnect the AC adaptor. Also do not remove the SD card while the [ACCESS] lamp is lit. If you do either of the above, a restore motion picture scene message is displayed when the SD card is next inserted or the power is turned back on. Be sure to restore the motion picture scene. (P96)
- Mosaic-pattern noise may appear on a playback image in the following cases.
 - When there is a complicated pattern in the background
 - When the unit is moved too much or too fast
 - When a subject with sharp movements has been recorded (Particularly if [ REC MODE] was set to [] during recording.)

Zoom in/out function

This is for moving the zoom lever to adjust the magnification.

You can make people and objects appear closer and landscapes can be recorded in wide angle. You can zoom in up to 10× optically.

◇ Rotate the mode dial to select  or .

1

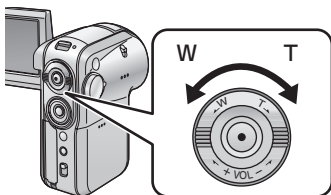

Move the zoom lever.

- **T side:** To bring distant people or objects appear closer for recording (zoom in)
- **W side:** To make sights appear more distant for recording (zoom out)





- When zooming in and taking a picture while holding this unit by hand, we recommend using the image stabilizer function. (P41)
- When distant subjects are brought closer, they are focused at about 1 m (3.3 feet) or more.
- When the zoom speed is high, the subject may not be focused easily.
- When the zoom magnification is 1×, this unit can focus on a subject approx. 4 cm (1.6 inch) distant from the lens. (Macro function)
- The zoom speed varies depending on the range over which the zoom lever is moved.

This brings distant subjects even closer for recording (digital zoom)

If the zoom magnification exceeds 10×, then the digital zoom function will be activated. The maximum magnification provided by the digital zoom can be switched.

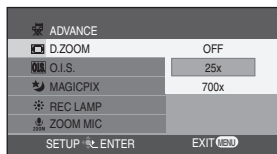
◇ Rotate the mode dial to select .



Press the menu button, use the cursor button to select [ ADVANCE] → [ D.ZOOM], then set the desired magnification. (P26)

- OFF: Optical zoom only (Up to 10×)
- [25×]: Up to 25×
- [700×]: Up to 700×

- The larger the digital zoom magnification, the more the image quality is degraded.
- This function cannot be used in still picture recording mode.

■ To use the zoom microphone function

Interlocked with the zooming operation, the microphone will collect sounds clearly far away with the tele-shot or those in the vicinity with the wide-angle shot.

◇ Rotate the mode dial to select .

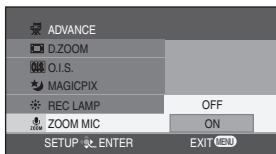

Press the menu button, then use the cursor button to select

[ ADVANCE] → [ ZOOM MIC] → [ON].
(P26)

Tele-macro function

This is for bringing only what you want to record into focus to take close-ups.

By focusing only on the subject and blurring the background, the image can be impressive. This unit can focus on the subject at a distance of approx. 50 cm (20 inch).

◇ Rotate the mode dial to select or .

1



Press the button in the center of the cursor button to display the icon shown in the illustration.

2



Press the cursor button up, then select the [] tele-macro icon.

- If the magnification is 10× or less, then it is automatically set to 10×.
- The [] icon flashes orange, then lights white.

To cancel the tele-macro function

Select the [] icon again.

- If a sharper focus cannot be achieved, adjust the focus manually. (P45)
- In the following cases, the tele-macro function is canceled automatically.
 - The zoom magnification becomes lower than 10×.
 - The power is turned off or the mode dial is set to a mode other than motion picture recording mode or still picture recording mode.

Soft skin mode

This makes skin colors appear softer for a more attractive appearance.

This is more effective if you record the bust image of a person.

◇ Rotate the mode dial to select  or .

1



Press the button in the center of the cursor button to display the icon shown in the illustration.

2



Press the cursor button down, then select the [] soft skin icon.

- The [] icon flashes orange, then lights white.

To cancel the soft skin mode

Select the [] icon again.

- If the background or anything else in the scene has colors similar to the skin color, they will also be smoothed.
- If the brightness is insufficient, the effect may not be clear.

Backlight compensation function

This is for protecting a backlit subject from being darkened.

Use this function when the light is emanating from behind the subject and the subject appears dark.

◇ Rotate the mode dial to select  or .

1



Press the button in the center of the cursor button to display the icon shown in the illustration.

2



Press the cursor button right, then select the  backlight compensation icon.

- The  icon flashes orange, then lights white.
- The image on the screen will become brighter.

To return to normal recording

Select the  icon again.

- In the following case, the backlight compensation is canceled automatically.
 - The power is turned off or the mode dial is set to a mode other than motion picture recording mode or still picture recording mode.

Wind noise reduction function

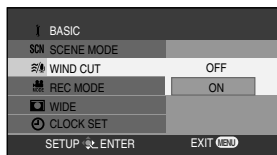

This is for reducing the wind noise coming into the microphone when recording.

- ◇ Rotate the mode dial to select .



Press the menu button, then use the cursor button to select [ BASIC] → [ WIND CUT] → [ON]. (P26)

To cancel the wind noise reduction function

Press the menu button, then use the cursor button to select [ BASIC] → [ WIND CUT] → [OFF]. (P26)

- This function's default setting is [ON].
- Reduces the wind noise depending on the wind strength. (If this function is activated in strong winds, the stereo effect may be reduced. When the wind weakens, the stereo effect will be restored.)

Wide mode

This is for selecting the screen's aspect ratio when recording motion pictures.

This allows you to record images compatible with wide-screen TVs (16:9) and regular TVs (4:3).

■ Recording images with a 16:9 aspect ratio

- ◇ Rotate the mode dial to select .

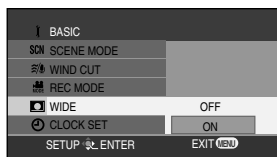

Press the menu button, then use the cursor button to select [ BASIC] → [ WIDE] → [ON]. (P26)

■ Recording images with a 4:3 aspect ratio

- ◇ Rotate the mode dial to select .

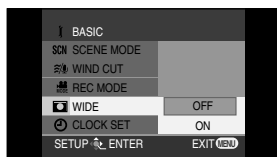

Press the menu button, then use the cursor button to select [ BASIC] → [ WIDE] → [OFF]. (P26)

Image stabilizer function



This is for reducing image shakes during recording.

Reduces the image shaking due to hand movement when recording.

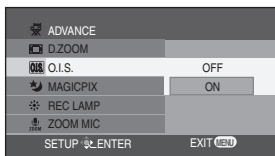
◇ Rotate the mode dial to select  or .



Press the menu button, then use the cursor button to select

[ ADVANCE] → [ O.I.S.] → [ON].
(P26)

To cancel the image stabilizer function

Press the menu button, then use the cursor button to select

[ ADVANCE] → [ O.I.S.] → [OFF]. (P26)

- In still picture recording mode, pressing the record button halfway increases the effect of the image stabilizer function. (MEGA OIS)
- When a tripod is used, we recommend that you turn the image stabilizer off.
- It may not be possible to compensate for image shake when the unit is shaken greatly or the person recording is chasing a fast-moving subject to record it.
- In the following case, the image stabilizer function may not work effectively.
 - When the digital zoom is used

MagicPix functions

This allows recording in dark locations.

This function allows you to record color subjects in dark locations to stand out against the background.



Attach this unit to a tripod, and you can record images free from vibration.

- Recorded scene is seen as if frames were missed.

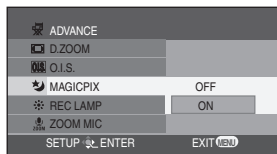
◇ Rotate the mode dial to select .



Press the menu button, then use the cursor button to select

[ ADVANCE] → [ MAGICPIX] → [ON]. (P26)

After exiting the menu screen, the unit is in manual focus mode. Press the cursor button left or right to bring the subject into focus manually. (P45)

In the following cases, press the button in the center of the cursor button twice to display the manual focus indication and then focus the subject.

- If MagicPix is set to [ON] when it has already been set to [ON].
- If the mode is changed when MagicPix is set to [ON].

To cancel the MagicPix function

Press the menu button, then use the cursor button to select

[ ADVANCE] → [ MAGICPIX] → [OFF]. (P26)

- If set in a bright place, the screen may become whitish for a while.
- The MagicPix function makes the signal charging time of CCD up to approximately 30× longer than usual, so that dark scenes invisible to the naked eye can be recorded brightly. For this reason, bright dots that are usually invisible may be seen, but this is not a malfunction.
- If you turn off the power, the MagicPix function is canceled.

Scene mode

This is for recording in various situations.

When you record images in different situations, this mode automatically sets optimum shutter speeds and apertures.

◇ Rotate the mode dial to select  or .

1

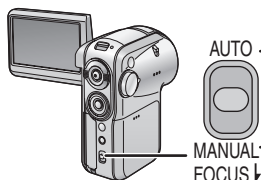



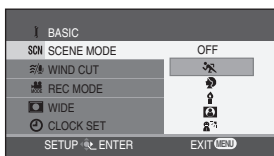

Set the [AUTO/MANUAL/FOCUS] switch to [MANUAL].

2



Press the menu button, use the cursor button to select [ BASIC] → [SCN SCENE MODE], then select the desired mode. (P26)

Indication	Mode	Recording conditions
	Sports	To record sports scenes or scenes where there are quick motions
	Portrait	To make persons stand out against the background
	Low light	To make the scene lighter at dusk or other dark times
	Spotlight	To make the subject under a spotlight look more attractive
	Surf & snow	To record images at dazzling places such as ski slopes and beaches

To cancel the scene mode function

Press the menu button, then use the cursor button to select

[ BASIC] → [SCN SCENE MODE] → [OFF]. (P26)

- You can also cancel the scene mode function by setting the [AUTO/MANUAL/FOCUS] switch to [AUTO].

Sports mode

- For slow-motion playback or playback pause of recorded scenes, this mode prevents camera shakes.
- During normal playback, the scene movement may not look smooth.
- Avoid recording under fluorescent light, mercury light or sodium light because the color and brightness of the playback scene may change.
- If you record a subject illuminated with strong light or a highly reflective subject, vertical lines of light may appear.
- If the brightness is insufficient, the sports mode does not function. The [] indication flashes.
- If this mode is used indoors, the screen may flicker.

Portrait mode

- If this mode is used indoors, the screen may flicker. If this happens, change the scene mode setting to [OFF].

Low light mode

- Extremely dark scenes may not be able to be recorded finely.

Spotlight mode

- If the recording subject is extremely bright, the recorded scene may become whitish and the periphery of the recorded scene extremely dark.

Surf & snow mode

- If the recording subject is extremely bright, the recorded scene may become whitish.

Manual focus adjustment

This allows subjects to be focused manually.

If auto focusing is difficult due to the conditions, then manual focusing is available.

◇ Rotate the mode dial to select  or .

1

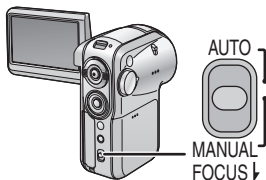

Set the [AUTO/MANUAL/FOCUS] switch to [MANUAL].

2



Move the switch down and set it to the [FOCUS] position.

- The manual focus indication [▶MF] will be displayed.

3



Press the cursor button left or right to bring the subject into focus.

- When focused with a wide angle, the subject may not be in focus when zoomed in. First, zoom in on the subject, and then focus on it.

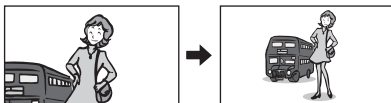

To restore to the automatic adjustment

Move the [AUTO/MANUAL/FOCUS] switch down again to the [FOCUS] position.

- You can also restore the auto focusing by setting the [AUTO/MANUAL/FOCUS] switch to [AUTO].

White balance

This is for recording in natural colours.

The automatic white balance function may not reproduce natural colours depending on the scenes or lighting conditions. If so, you can adjust the white balance manually.

◆ Rotate the mode dial to select  or .

1



Set the [AUTO/MANUAL/FOCUS] switch to [MANUAL].

The icon shown in the illustration is displayed automatically.

2

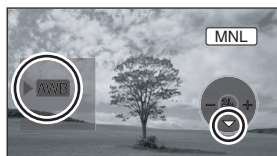

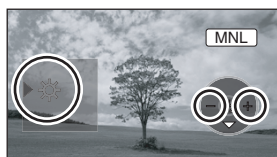

Press the cursor button down to select the white balance indication (such as **AWB**).

3



Press the cursor button left or right to select the white balance mode.

Indication	Mode	Recording conditions
AWB	Auto white balance adjustment	
	Indoor mode (for recording under incandescent lamps)	Incandescent lights, halogen lamps
	Outdoor mode	Outdoors under a clear sky
	Manual adjustment mode	Mercury-vapor lamps, sodium lamps, some fluorescent lights Lights used for wedding receptions at hotels, stage spotlights in theatres, sunrise, sunset, etc.



To restore to the automatic adjustment

Set the white balance mode to [**AWB**].

- You can also restore the automatic adjustment by [AUTO/MANUAL/FOCUS] switch to [AUTO].

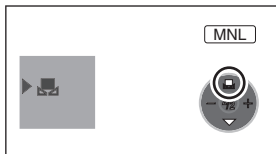
To set the white balance manually



Select [] mode, fill the screen with a white subject and then press the cursor button up to select the [] indication.

- When the [] display changes from flashing to on, setting is complete.

About flashing of the [] indication

When the manual adjustment mode is selected

- Flashing indicates that the white balance previously adjusted is stored. This setting is stored until the white balance is adjusted again.

When white balance cannot be set in the manual adjustment mode

- White balance may not be adjusted properly in the manual adjustment mode in dark places. If so, use the auto white balance mode.

During setting in the manual adjustment mode

- The [] indication flashes while settings are being performed in set mode. Upon completion of the settings, it stops flashing and lights instead.

■ About the white balance sensor

Do not cover the white balance sensor **1** during recording, or it may not function properly.

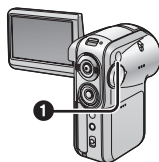

■ About the black balance adjustment

This is one of the 3CCD system functions that automatically adjusts the black when the white balance is set in the manual adjustment mode. When the black balance is adjusted, the screen will temporarily be black. (The black balance cannot be adjusted manually.)

- 1** Black balance adjustment in progress (flashes)
- 2** White balance adjustment in progress (flashes)
- 3** Adjustment completed (lights)

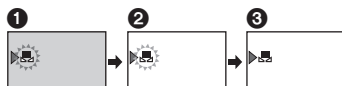

-
- When setting both the white balance and the iris/gain, set the white balance first.
 - Whenever recording conditions change, re-set the white balance for correct adjustment.

Manual shutter speed/aperture adjustment

Shutter Speed

Adjust it when recording fast-moving subjects.

Aperture

Adjust it when the screen is too bright or too dark.

◇ Rotate the mode dial to select  or .

1



Set the [AUTO/MANUAL/FOCUS] switch to [MANUAL].

The icon shown in the illustration is displayed automatically.

2



Press the cursor button down several times and select the shutter speed indication (such as 1/60) or iris/gain indication (such as F2.0, 0dB).

3

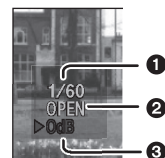

Press the cursor button left or right to make the adjustment.

① Shutter speed:

 1/60 to 1/8000

 1/30 to 1/2000

- The shutter speed closer to 1/8000 (1/2000) is faster.

② Iris value:

CLOSE → (F16 to F2.0) → OPEN

- The closer to "OPEN" the value selected, the brighter the iris value becomes.

③ Gain value: 0dB → 18dB

- If the value does not become "OPEN", you cannot adjust the gain value.

To restore to automatic adjustment

Set the [AUTO/MANUAL/FOCUS] switch to [AUTO].

■ When recording fast-moving objects, then playing them back as still pictures for viewing

General guidelines for the shutter speed

- For recording golf swings or tennis shots: 1/500 to 1/2000
 - For recording volleyball matches: 1/100 to 1/350
 - For recording jet coaster rides: 1/500 to 1/1000
-

<Manual shutter speed adjustment>

- Avoid recording under fluorescent light, mercury light or sodium light because the colour and brightness of the playback image may change.
- If you increase the shutter speed manually, the sensitivity lowers and accordingly the gain value increases automatically, which may increase the noises on the screen.
- You may see vertical lines of light in the playback image of a brightly shining subject or highly reflective subject, but this is not a malfunction.
- During normal playback, image movement may not look smooth.
- When recording in an extremely bright place, the screen may change color or flicker. If so adjust the shutter speed manually to 1/60 or 1/100.

<Manual iris/gain adjustment>

- If the gain value is increased, the noise on the screen increases.
- Depending on the zoom magnification, there are iris values that are not displayed.
- When setting both the shutter speed and the iris/gain value, set the shutter speed and then set the iris/gain value.

Still picture recording (JPEG still pictures)

For the number of still pictures to be recorded on an SD card, refer to P88.

1

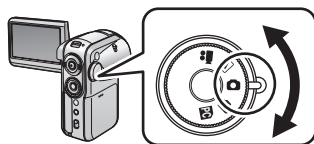

Rotate the mode dial to select .

The lens cover opens automatically.

2

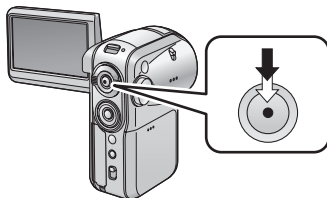

Press the record button halfway (not all the way down) to bring the subject into focus. (In auto focusing mode only)

① Shutter chance mark

② Focus area

③ Shutter speed

④ Iris/gain

The shutter speed and the iris/gain value are fixed and the unit focuses on the subject automatically.

• When the record button is pressed halfway, the shutter chance mark is indicated as follows.

– ○ (The white lamp flashes.):

Focusing

– ● (The green lamp lights up.):

When in focus (Beeps twice)

– No mark: When focusing is unsuccessful (2 beeps 4 times)

• If you set [O.I.S.] to [ON] (P41), then the image stabilizer function will be more effective. ([MEGA] will be indicated.)

• The shutter chance mark is indicated as follows when the record button is not pressed halfway. Please use it as a guide for recording.

– ● (The green lamp lights up.):

When in focus and a good picture can be recorded

– ○ (The white lamp lights up.):

Almost in focus

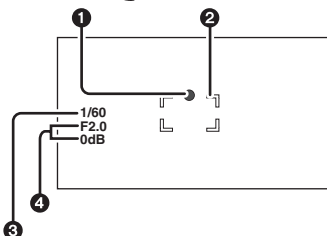

3

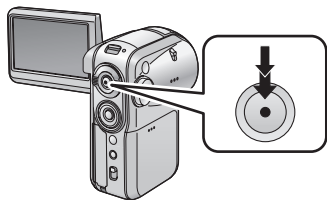

Press the record button all the way down (as far as it will go) to record.

To record still pictures clearly

- When zooming in on the subject with a magnification of 4× to 10×, it is difficult to reduce the slight shaking from holding this unit by hand. We recommend decreasing the zoom magnification and approaching the subject when recording.
- You can record stable pictures without shaking by using a tripod and the remote control.

- The sound cannot be recorded.
- When the access lamp is lit, do not operate the mode dial.
- When the access lamp is lit, do not insert or remove an SD card.
- If the write protection switch on the SD card is set to [LOCK], it cannot be used for recording. (P15)
- Another product may degrade or not play back still pictures recorded on this unit.
- If set [PICT. QUALITY] to [], mosaic-pattern noise may appear on a playback image depending on the picture content.
- When the [PICTURE SIZE] is set to other than [640], the mega pixel recording mode is set.

■ Screen indications in still picture recording mode

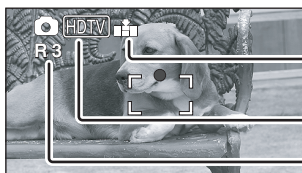

- 1 Quality of still pictures
- 2 Size of still pictures
- 3 Remaining number of still pictures
(Flashes red when [R 0] appears.)



■ Number of pixels and picture quality for still picture recording

PICTURE SIZE

Changing the recording size

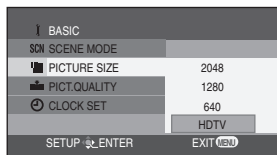
1



Press the menu button, use the cursor button to select [ BASIC] → [ PICTURE SIZE], then set the desired size. (P26)

- 2048: 2048×1512 pixels
- 1280: 1280×960 pixels
- 640: 640×480 pixels
- HDTV: 1920×1080 pixels



(still pictures recorded at 16:9 aspect ratio)

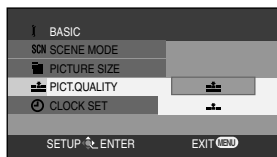

PICT. QUALITY

Selecting the picture quality

1



Press the menu button, use the cursor button to select [ BASIC] → [ PICT. QUALITY], then set the desired picture quality. (P26)



-  : Still pictures with a high picture quality are recorded.
-  : Priority is given to the number of still pictures recorded. Still pictures are recorded in normal picture quality.

- When you purchase this unit, [PICTURE SIZE] is set to [HDTV]. The sides of pictures recorded when [HDTV] is set may be cut at printing. Check before printing. When using the printer with a trimming feature or other feature which cuts out both edges of the pictures, cancel the feature for printing. (Refer to the operating instructions of the printer for details.)

Recording with a shutter operation effect

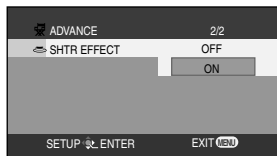
You can add a shutter operation simulating sound.



Press the menu button, then use the cursor button to select [ ADVANCE] → [ SHTR EFFECT] → [ON]. (P26)

■ About the shutter chance mark

- The shutter chance mark does not appear in manual focus mode.
- When the subject is not easily focused, focus on the subject manually. (P45)
- You can record still pictures on the SD card even if the shutter chance mark does not appear, but pictures may be recorded without being focused.
- The shutter chance mark does not appear or is difficult to display in the following cases.
 - When the zoom magnification is high.
 - When this unit is shaken.
 - When the subject is moving.
 - When the subject stands against the light source.
 - When close subjects and far subjects are included in the same scene.
 - When the scene is dark.
 - When there is a bright part in the scene.
 - When the scene is filled with only horizontal lines.
 - When the scene lacks contrast.

■ About the focus area

When there is a contrasting object ahead or behind the subject in the focus area, the subject may not be focused. If so, move the contrasting object out of the focus area.

Built-in flash

Use the built-in flash in order to record still pictures in dark places.

◆ Rotate the mode dial to select .

1

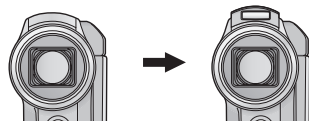
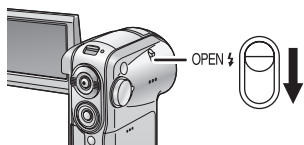



Slide the [OPEN⚡] flash lever.

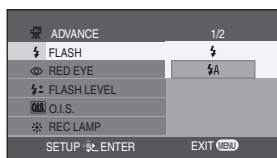

The flash rises.

- The flash will flash when the record button is pressed.

Setting the flash mode



Press the menu button, then use the cursor button to select [ ADVANCE] → [ FLASH] and then select the desired setting. (P26)

- []: Forced flash
- [ A]: Auto



- When [ A] is set, the ambient brightness is automatically detected, and only when the flash is judged necessary will it flash.

When the flash is not used

Close the flash by pressing it with your fingers until it clicks back into place.

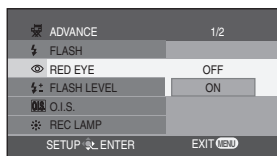
Red eye reduction function



Press the menu button, then use the cursor button to select [ ADVANCE] → [ RED EYE] → [ON]. (P26)

The [] indication appears.

- Red eye phenomenon may appear depending on the recording conditions.

To adjust the brightness of the flash

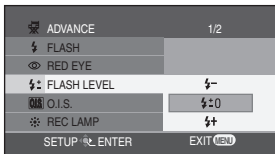

Press the menu button, use the cursor button to select

[**ADVANCE**] → [**FLASH LEVEL**], then set the desired brightness level. (P26)

- [**FLASH-**]: If the brightness is too high ([**FLASH-**] or [**FLASH A-**] indication will appear.)
- [**FLASH 0**]: In normal recording ([**FLASH**] or [**FLASH A**] indication will appear.)
- [**FLASH+**]: If the brightness is insufficient ([**FLASH+**] or [**FLASH A+**] indication will appear.)

- Do not accidentally press or cover the flash with your fingers when holding the camera.
- Store the flash when it is not being used.
- The unit, even when its flash has been closed, automatically determines if the flash is necessary by detecting the ambient brightness. (If it determines that the flash is necessary, the [**FLASH**] indication flashes yellow.)
- When the [**FLASH**] ([**FLASH+**]/[**FLASH-**]) indication or the [**FLASH A**] ([**FLASH A+**]/[**FLASH A-**]) indication is displayed, the flash can be lit. If the indication is flashing or not displayed, the flash cannot be lit.
- The available range of the flash is approx. 1 m to 2 m (3.3 feet to 6.6 feet) in a dark place. Pictures will appear dark or reddish when they are recorded by using the flash at distances greater than 2 m (6.6 feet).
- When setting the flash to [**FLASH A**] and adjusting the shutter speed or iris/gain at the same time, the indication [**FLASH A**] etc. may disappear and the flash may not flash.
- Using the flash fixes the shutter speed of 1/750 or faster to 1/500.
- The picture may become out of focus in a dark place. If so, adjust the focus manually. (P45)
- The picture may appear dark if flash is lit in front of a white background.
- Keep the flash stored in locations where using a flash is prohibited.

Self-timer recording

This is for recording using the timer.

You can record still pictures on an SD card using the timer.

◇ Rotate the mode dial to select .

1







Press the button in the center to display the icon shown in the figure.

2



Press the cursor button left to select the [] self-timer icon.



The []₁₀] icon flashes orange, then lights white.

- Each time the left cursor button is pressed, the indication changes by one setting in the following order: []₁₀]→[]₂]→setting cancelled.
- []₁₀] : Starts recording after 10 seconds
- []₂] : Starts recording after 2 seconds

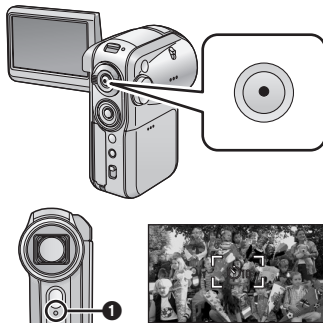
3



Press the record button.

After the indication lamp and the []₁₀] or []₂] indication flash for the time which has been set, recording will start. After recording, the self-timer is cancelled.

- ① Indication lamp
- When the record button is pressed halfway and then all the way, the subject will be brought into focus when the record button was pressed halfway.
- When the record button is pressed all the way at once, the subject will be focused just before the recording.

To stop the timer midway through

Press the [MENU] button. (The self-timer setting is cancelled.)

- By operating the [ON/OFF] switch or mode dial, the self-timer standby mode is canceled.
- Depending on the time taken to bring the subject into focus, the recording may take longer than set to start.
- Setting the self-timer to []₂] is a good way to prevent image shake when the record button is pressed while using a tripod etc.

Motion picture playback (MPEG2 motion pictures)

1

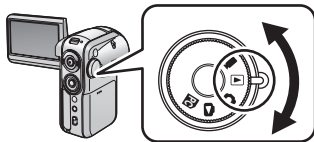

Rotate the mode dial to select .

The lens cover closes automatically.

The motion pictures (up to 12 scenes) recorded on the SD card are displayed as thumbnails.

2

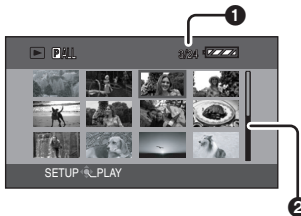

Press the cursor button up, down, left or right to select the scene to be played back.

① Scene number

② Bar graph display

The selected scene will be encircled by a red frame.

- When 13 or more scenes have been recorded, the next (or previous) page is displayed by pressing the cursor button.

- If you press and hold the cursor button up or down, you can advance 12 scenes at a time. The screen will not change at this time, but the scene numbers and bar graph display will change so release the button when you have arrived at the page with the scene you want to playback.

3



Press the button in the center of the cursor button.

The selected scene is played back on the full screen.

The operation icon is automatically displayed on the LCD monitor.

① The date/time display reflects the recording start date and time so it will remain unchanged during recording.

4





Press the cursor button up, down, left or right to operate.

Playback/Pause: Press .

Review playback: Continue to press .

Cue playback: Continue to press .

Stop the playback, and show the thumbnails:
Press .

- When the  or  button is pressed briefly, you can review or cue to the beginning of scenes (skip playback).
- No sound will be heard during review playback or cue playback.

- When the amount of time recorded on the scene is short, playback may not be possible.

Slow-motion playback

The motion pictures will be played back at a speed approx. 1/5 the normal speed.



- 1) Press the cursor button up during motion picture playback to pause the playback.
- 2) Keep pressing the cursor button right. (Slow-motion pictures will be played back in reverse when you keep pressing the cursor button left.)
 - Normal playback is restored when the cursor button up is pressed.
 - The sound is muted during slow-motion playback.

Frame-by-frame playback

The motion picture is advanced one frame at a time.



- 1) Press the cursor button up during motion picture playback to pause the playback.
- 2) Press the cursor button right. (The frames will be advanced one at a time in the reverse direction when you press the cursor button left.)
 - Normal playback is restored when the cursor button up is pressed.

To adjust volume

Adjusting the speaker volume, or the headphone volume when using headphones (optional), during playback.

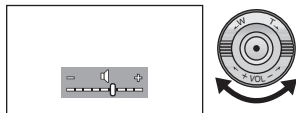

Move the volume lever to change the volume level.

- Towards [+]: increases the volume
 - Towards [-]: decreases the volume
- The further the [] indication moves to the right (towards the "+" end), the higher the volume level becomes.
 - When the adjustment is completed, the volume indication will disappear.

Playing back motion pictures by date

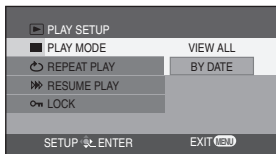

- 1) Press the menu button, then use the cursor button to select [] **PLAY SETUP**] → [] **PLAY MODE**] → [] **VIEW ALL**] → [] **BY DATE**]. (P26)

- When [PLAY MODE] is set to [VIEW ALL], all recorded motion pictures will be played back in succession. ([] ALL) is displayed.)

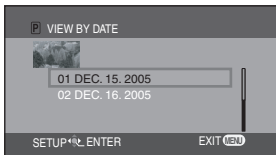

- 2) Press the cursor button up or down to select the date for playback, then press the button in the center.

- Once the playback of one motion picture is started, any other motion pictures recorded on the same day will then be played back in succession. ([] 01) etc. is displayed.)

Repeat playback

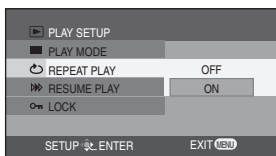

Press the menu button, then use the cursor button to select

- [[] **PLAY SETUP**] → [] **REPEAT PLAY**] → [] **ON**]. (P26)

The [] indication appears on the thumbnail and full screen views.

- In order to cancel the repeat playback mode, set [REPEAT PLAY] to [OFF].

Resuming the previous playback

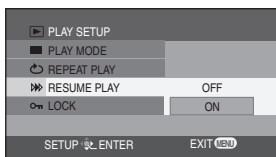

Press the menu button, then use the cursor button to select

- [[] **PLAY SETUP**] → [] **RESUME PLAY**] → [] **ON**]. (P26)

- If playback of a motion picture is stopped, [R] appears on the thumbnail view of the stopped scene.

- If playback is stopped at any point during a motion picture while [RESUME PLAY] is set to [OFF], the next time the motion picture is played back, it will be from the beginning.
- [RESUME PLAY] is set to [OFF] if an SD card with the write protection switch at the [LOCK] position is inserted. (P15)

■ About motion picture mode compatibility

- This unit can play back MPEG2 formatted files.
- This unit is based on the SD-Video standard.
- This unit may degrade or not play back motion pictures recorded or created on another product and another product may degrade or not play back motion pictures recorded on this unit.
- Motion pictures less than approximately 2 seconds cannot be played back.
- The thumbnails of motion pictures that cannot be played back are displayed in shades of blue and white. (P101)

Still picture playback (JPEG still pictures)

1

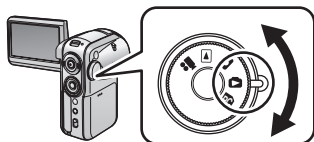

Rotate the mode dial to select .

The lens cover closes automatically.
The still pictures (up to 12 scenes) recorded on the SD card are displayed as thumbnails.

2



Press the cursor button up, down, left or right to select the scene to be played back.

- ① Scene number
- ② Bar graph

The selected scene will be encircled by a red frame.

- When 13 or more scenes have been recorded, the next (or previous) page is displayed by pressing the cursor button.
- If you press and hold the cursor button up or down, you can advance 12 scenes at a time. The screen will not change at this time, but the scene numbers and bar graph display will change so release the button when you have arrived at the page with the scene you want to display.

3



Press the button in the center of the cursor button.





The selected scene is played back on the full screen.

The operation icon is automatically displayed on the LCD monitor.

4



Press the cursor button up, down, left or right to operate.

-  : Slide show (playback of the still pictures on the SD card in numerical order) start/pause. *
-  : Plays back the previous picture.
-  : Plays back the next picture.
-  : Stops the playback, and shows the thumbnails.

* Only when SLIDE SHOW has been selected. (P61)

Playing back still pictures as a slide show

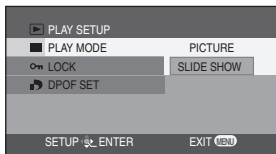

Press the menu button, then use the cursor button to select

[▶] [PLAY SETUP] → [■] [PLAY MODE] → [SLIDE SHOW]. (P26)

- Still pictures will not be played as a slide show when [PICTURE] is selected.

■ About still picture compatibility

- This unit is compliant with the unified standard DCF (Design rule for Camera File system) established by JEITA (Japan Electronics and Information Technology Industries Association).
 - The file format supported by this unit is JPEG. (Not all JPEG formatted files will be played back.)
 - If an out-of-specs still picture is played back, the folder/file name may not be displayed.
 - This unit may degrade or not play back still picture recorded or created on another product and another product may degrade or not play back data recorded on this unit.
-
- Do not operate the mode dial during the slide show.
 - When the access lamp is lit, do not insert or remove an SD card.
 - It takes time to display the still picture depending on the number of pixels of the still picture.
 - If you attempt to play back still pictures recorded in a different format or still picture data is defective, the whole display becomes grayish and the "UNPLAYABLE CARD." indication may appear as warning.
 - When playing back a still picture recorded on other equipment, the date and time display is different from when it was recorded.
 - When playing back a still picture recorded on other equipment, its size and that of this unit may appear differently. (P93)

Deleting scenes

This is for deleting scenes recorded on SD cards.



The deleted scenes cannot be restored.

■ Deleting multiple files from the thumbnail display.

◇ Rotate the mode dial to select  or .

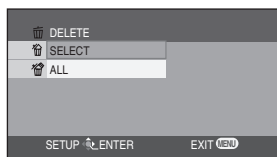
1



Press the menu button, then use the cursor button to select [ DELETE] → [ SELECT] or [ ALL]. (P26)

When [SELECT] is selected, the motion picture or still picture scenes will be displayed as thumbnails.

- When [ALL] is selected, proceed to step 4.

2

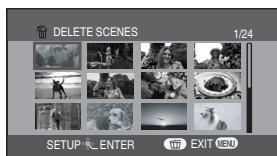

(Only when [SELECT] is selected in step 1)

Use the cursor button to select the scene to be deleted, then press the button in the center.

The selected scene will be encircled by a yellow frame.

- When the button in the center is pressed again, the selected scene will be canceled.
- Up to 12 scenes displayed on a page can be set in succession.

3

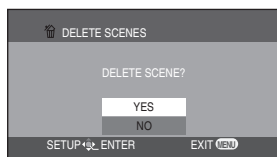

(Only when [SELECT] is selected in step 1)

Press the [] button.

- If no file is selected in step 2 and the [] button is pressed, the scene encircled by a red frame is deleted.

4

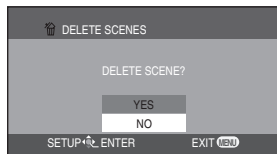

When the confirmation message appears, use the cursor button to select [YES], then press the button in the center.

- To stop deleting, select [NO].

■ Deleting scenes one at a time

◇ Rotate the mode dial to select  or .

1



Press the [] button during playback.

2



When the confirmation message appears, use the cursor button to select [YES], then press the button in the center.

- To stop deleting, select [NO].

■ Deleting still picture files recorded on an SD card by other equipment

A still picture file (other than JPEG) that cannot be played back on this unit may be erased.

- Do not open the card slot cover while deleting. The deletion will stop.
- Scenes displayed as thumbnails in shades of blue and white cannot be deleted. (P101)
- Scenes that are locked cannot be deleted.
- If the write protection switch on an SD card is set to [LOCK], the scenes on the card cannot be deleted. (P15)
- When "CARD FULL." is shown during recording, delete unnecessary scenes. If there are no scenes to be deleted, it means that the memory is full so insert a new SD card.
- In case of [ALL], the deletion may take time if there are many scenes on the SD card.
- Do not turn off this unit while deleting.
- When you delete scenes, use a battery with sufficient battery power or use the AC adaptor.
- If scenes conforming to DCF standard are deleted, all the data related to the scenes will be deleted.

Locking scenes

This is for preventing scenes from being deleted by mistake.



Scenes recorded on an SD card can be locked so that they may not be deleted by mistake. (However even if you lock some scenes on an SD card, formatting the card will delete all the scenes.)

◇ Rotate the mode dial to select  or .

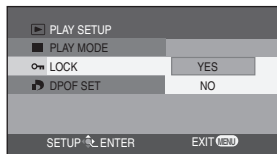
1



Press the menu button, then use the cursor button to select

[ PLAY SETUP]→
[ LOCK]→[YES]. (P26)

2

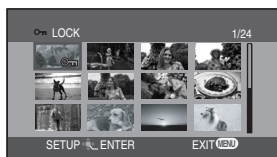

Press the cursor button up, down, left or right to select the scene to be protected, then press the button in the center.

[] indication appears and the selected scene is locked.

- Press the button in the center again to release the lock setting.

To complete the settings

Press the [MENU] button.

- Scenes displayed as thumbnails in shades of blue and white cannot be locked. (P101)
- If the write protection switch on an SD card is set to [LOCK], the scenes on the card cannot be locked. (P15)

Formatting an SD card



This is for initializing (formatting) cards.

Please be aware that if an SD card is formatted, then all the data recorded on the card will be erased. Store important data on a PC, etc. When saving scenes recorded using this unit to a PC, you must use MotionSD STUDIO. (P73)

◇ Rotate the mode dial to select , ,  or .

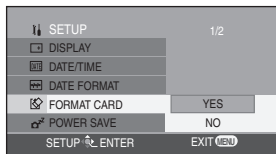
1



Press the menu button, then use the cursor button to select [ SETUP] → [  FORMAT CARD] → [YES]. (P26)

2

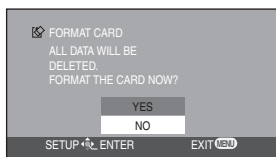

When the confirmation message appears, use the cursor button to select [YES], then press the button in the center.

- To cancel formatting, select [NO].

- Use this unit to format SD cards. If an SD card is formatted on other equipment (such as a PC), the time spent for recording may become longer and you may not be able to use the SD card.
- During formatting, do not turn this unit off.
- When you format the SD card, use a battery with sufficient battery power or the AC adaptor.
- Depending on the type of SD card being used, it may take time to format.
- Do not remove the SD card while formatting.
- If the write protection switch on an SD card is set to [LOCK], it cannot be formatted. (P15)

DPOF setting

This is for writing the printing data on an SD card.

You can write the data of pictures to be printed, number of copies, and other information (DPOF data) onto the SD card.

◇ Rotate the mode dial to select .

1

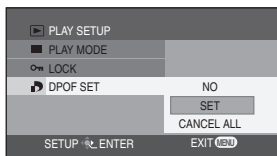

Press the menu button, then use the cursor button to select [ PLAY SETUP] → [ DPOF SET] → [SET]. (P26)

2

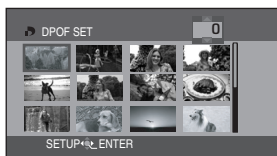

Press the cursor button up, down, left or right to select a scene to be set, then press the button in the center.

The number of prints set to be in DPOF is displayed.

3



Press the cursor button up or down to select the number of prints, then press the button in the center.



- You can select from 0 to 999. (Selected number of pictures can be printed as you set the number of prints with the printer supporting DPOF.)
- The function can be cancelled by setting the number of pictures to [0].

To complete the settings

Press the [MENU] button.

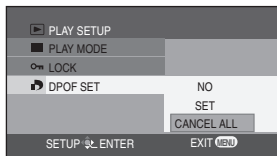
To return the total number of pictures to [0]



Press the menu button, then use the cursor button to select [ PLAY SETUP] → [ DPOF SET] → [CANCEL ALL]. (P26)

- When the confirmation message appears, use the cursor button to select [YES], then press the button in the center.

■ What is DPOF?

DPOF stands for Digital Print Order Format. This enables picture printing information to be written onto an SD card so that it can be used on a system supporting DPOF.

- The DPOF setting can be established for up to 999 scenes.
- DPOF setting made on another camera may not be recognized by this unit. Please perform the DPOF settings on this unit.
- You cannot add the recording date to pictures to be printed with the DPOF settings.
- If the write protection switch on an SD card is set to [LOCK], the DPOF setting cannot be set. (P15)

PictBridge

This is for printing pictures by directly connecting to the printer.

To print pictures by directly connecting this unit to the printer, use a printer compatible with PictBridge. (Read the operating instructions for the printer.)

◇ **Connect this unit to the AC adaptor.**

◇ **Rotate the mode dial to select .**

1

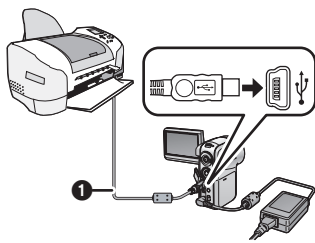

Open the terminal cover, then firmly plug one end of the USB cable  (supplied) into the unit's USB terminal and the other end into the terminal on the printer.

Insert the plugs as far as they will go. The images recorded on the SD card are displayed as thumbnails.

- When no SD card is inserted in this unit, the [**PictBridge**] indication does not appear. (You cannot print any pictures.)
- When this unit and the printer are not connected properly, the [**PictBridge**] indication keeps blinking. (It will blink for over approx. 1 minute.) Connect the cable or check the printer.
- Do not use any other USB cables except the supplied one. (Operation is not guaranteed with any other USB cables.)

2

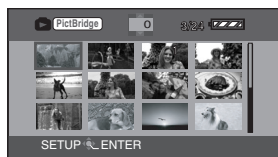

Press the cursor button up, down, left or right to select a scene to be printed, then press the button in the center.

The number of pictures set is displayed.

3



Press the cursor button up or down to select the desired number of prints, then press the button in the center.

- You can set up to 9 prints.
- The function can be canceled by setting the number of pictures to [0].
- Up to 12 scenes displayed on a page can be set in succession by repeating steps 2 and 3.

4

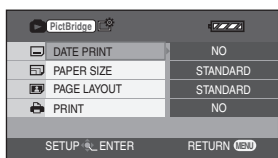

Press the menu button to display the menu screen.

5

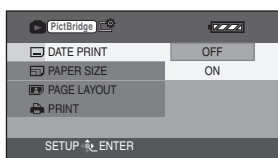

Use the cursor button to select [DATE PRINT], then press the cursor button right to enter the date print setting.

- If the printer is not capable of date printing, this setting is unavailable.

6

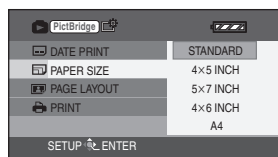

Use the cursor button to select [PAPER SIZE], then press the cursor button right to enter the paper size setting.

- **STANDARD:** Size specific to the printer
- **4x5 INCH:** L size
- **5x7 INCH:** 2L size
- **4x6 INCH:** Postcard size
- **A4:** A4 size
- You cannot set paper sizes not supported on the printer.

7

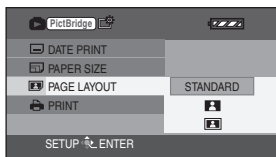

Use the cursor button to select [PAGE LAYOUT], then press the cursor button right to enter the layout setting.

- **STANDARD:** Layout specific to the printer
- : No frame print
- : Frame print
- You cannot set page layouts not supported on the printer.

8

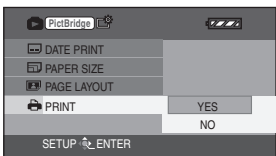

Use the cursor button to select [PRINT], then press the cursor button right to select [YES]. The pictures are printed.

- Exit PictBridge by disconnecting the USB cable (supplied) after the pictures have been printed.

When you stop printing halfway

Press the cursor button down.

- A confirmation message appears. If [YES] is selected, the settings are cancelled and the screen returns to the thumbnails. If [NO] is selected, the settings made in steps 5 to 7 are kept and the screen returns to the thumbnails.
-
- Avoid the following operations during printing. These operations disable proper printing.
 - Disconnecting the USB cable
 - Removing the SD card
 - Switching the mode dial
 - Turning off the power
 - Check the settings for the paper size, quality of print, etc. on the printer.
 - You cannot print pictures that cannot be played on this unit.
 - When the unit is connected directly to the printer, the DPOF settings cannot be used.

Playback on TV

Images recorded by this unit can be played back on a TV.

◆ Insert an SD card with recordings into the unit.

1

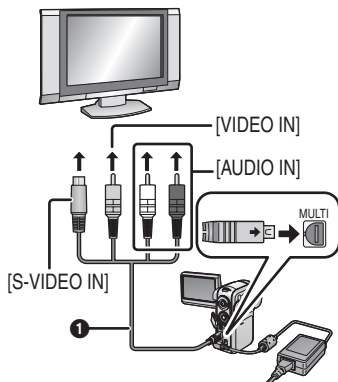

Open the terminal cover and then connect the multi cable (supplied) to the multi-connector terminal [MULTI] and the TV.

❶ Multi cable (supplied)

Insert the plugs as far as they will go.

- If the TV has an S-Video terminal, then also connect an S-Video plug. It allows you to enjoy more beautiful images. (You must also connect the Video/Audio input terminals.)
- Use the AC adaptor to free you from worrying about the battery running down.

2

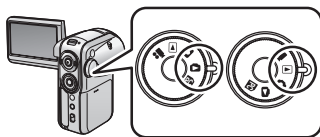

Turn on this unit, then set the mode to [▶] or [▶].

3 Change the input channel on the TV.

<TV setting>

Example: Set the channel to "VCR2" etc. (The channel set will differ depending on the terminal to which the cable is connected.)

4 Start playback on this unit. (P57, 60)

The image and audio are output on the TV.

■ If the image or audio from this unit is not output on the TV

- Check that the plugs are inserted as far as they go.
- Check the connected terminal.
- You cannot playback motion pictures recorded to SD card on this unit by inserting the SD card into a TV with a built-in SD card slot.
- **Check the TV's input setting (input switch).** (For more information, please read the operating instructions for the TV.)



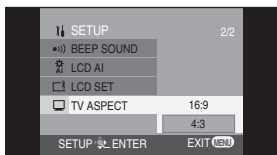

Connecting to a TV with a 4:3 TV aspect ratio

When motion pictures recorded with a 16:9 aspect ratio (the motion picture recording menu's [WIDE] setting is [ON]) or still pictures recorded with the same aspect ratio (the still picture recording menu's [PICTURE SIZE] setting is [HDTV]) are played back on a TV with a 4:3 aspect ratio, the images shown on the LCD monitor may be elongated vertically. In this case, you can play them back with their original aspect ratio by changing the menu setting. (Depending on the settings of the TV, the images may not be shown correctly. Refer to the operating instructions of the TV.)

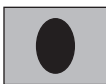

Press the menu button, then use the cursor button to select
[] [] SETUP] → [] TV ASPECT] → [4:3].
(P26)

Examples showing images with a 16:9 aspect ratio displayed on the TV screen

		Aspect ratio of TV screen		
		4:3	16:9	
[] TV ASPECT]	16:9	① 	③ 	① The images are elongated vertically. ② Black bands appear at the top and bottom of the screen. ③ The regular images are displayed. ④ Black bands appear at the top, bottom, left and right of the screen.
	4:3	② 	④ 	

■ When watching the recorded motion pictures on TV

Depending on the TV connected, the sides of the images (the part outside the dotted line) being played may not appear. We recommend widening the recording range of the objects you want to record beforehand.

- ① 16:9 screen
- ② 4:3 screen



To display the on-screen information on the TV

The information displayed on the LCD monitor (operation icon and mode indication, etc.), date and time (P28) can be displayed on the TV.



Press the [OSD] button on the remote control.

- Press the button again to erase the OSD information.
- The LCD monitor display does not change.

Using this unit's recorded data on other devices

This is for copying recordings from a DVD recorder's SD card slot onto its hard disk.

To prevent accidental deleting of images recorded, or when the SD card is full, record the files on the SD card to the DVD recorder's hard disk or DVD-RAM.

Depending on the type of DVD recorder used, it may not be possible to copy motion pictures (MPEG2) recorded with this unit onto a hard disk, etc.

- For further details, refer to the operating instructions of the DVD recorder.

1

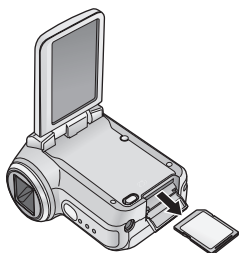

Remove the SD card with the recorded images from this unit. (P14)

- Set this unit's power switch to [OFF] then remove the SD card from it.

2



Insert the SD card into the DVD recorder's SD card slot.

- For details on how to record the images onto the hard disk, refer to the operating instructions of the DVD recorder.

- The images recorded on the hard disk or DVD-RAM are converted to the DVD video recording format. Once converted, you cannot copy them at high speed onto a DVD-R or copy them onto an SD card using the MPEG2 format.

With a PC

When the CD-ROM (supplied) is inserted into the PC, the CD launcher starts.



Video editing software MotionSD STUDIO 1.0E

This software allows pictures to be acquired from this unit, edited and output.

You can also send a picture acquired from this unit by e-mail, and edited pictures can be written to the DVD drive.

For information about how to use MotionSD STUDIO 1.0E, read the PDF operating instructions.

Web Camera Driver

When the unit is connected to a PC, you can send pictures and audio from the unit over the Internet to the person you are communicating with. Alternatively, you can use the PC's speakers to configure a kind of Internet TV phone for communicating.

Acrobat Reader

To view the installed operating instructions of MotionSD STUDIO, Adobe Acrobat Reader 5.0 or later is required.

If Adobe Acrobat Reader is not installed in the PC used, click the desired language in the setup screen (or open a folder of which name is the name of the desired language in [Adobe] folder and then double-click [AR505XXX.exe] or [AR500XXX.exe] file. "XXX" (the last 3 characters in the name of the file) varies depending on the language folder you selected) and follow the message on the screen to install Adobe Acrobat Reader.

DirectX

You will need Microsoft DirectX 9.0b in order to use MotionSD STUDIO or the Web camera functions. (It can also be installed when you install the MotionSD STUDIO or Web camera driver.) If DirectX is not installed on your PC because you cancelled its installation when installing the software, click [DirectX] in the CD launcher, and follow the on-screen messages to install it.

- Depending on the operating environment, software applications supporting the old version of DirectX may not run properly after DirectX 9.0b has been installed. If this happens, contact the manufacturer of these applications.
(Your PC must support DirectX 9.0)

With a PC (continued)

- Even if the system requirements mentioned in these operating instructions are fulfilled, some personal computers cannot be used.
- This software is not Macintosh compatible.
- This software is not compatible with Microsoft Windows 3.1, Windows 95, Windows 98, Windows Me and Windows NT.
- Operation is not guaranteed on an upgraded OS.
- Operation on an OS other than the one pre-installed is not guaranteed.
- When 2 or more USB devices are connected to a PC, or when devices are connected through USB hubs or by using extension cables, proper operation is not guaranteed.
- Use the supplied USB cable when connecting to the PC. (Operation is not guaranteed with any other USB cables.)
 - IBM and PC/AT are registered trademarks of International Business Machines Corporation of the U.S.
 - Intel®, Pentium® and Celeron® are registered trademarks or trademarks of Intel Corporation in the United States and other countries.
- To upgrade the Windows Service Pack (SP1, SP4 etc.), select [start] (→[All Programs (Programs)])→[Windows Update]. (Internet connection is required for this.)

Operating environment for MotionSD STUDIO 1.0E (Video Editing Software)

Personal computer	IBM PC/AT compatible personal computer
OS	Microsoft Windows 2000 Professional SP4/Microsoft Windows XP Home Edition SP2/Microsoft Windows XP Professional SP2
CPU	Intel Pentium III 800 MHz or higher (including compatible CPU) (Intel Pentium 4 1.6 GHz or higher recommended)
RAM	256 MB or more (512 MB or more recommended)
Display	High Color (16 bit) or more (32 bit recommended) Desktop resolution of 1024×768 pixels or more (1280×1024 pixels or more recommended) Graphics card complying with DirectX 9.0b or 9.0c, and DirectDraw overlay
Free hard disk space	Ultra DMA—33 or more (100 or more is recommended) 640 MB or more When writing to DVD, the same amount of free space as the disc is necessary.
Necessary software	DirectX 9.0b or 9.0c (If you install the software in a personal computer that is not compatible with DirectX 9.0b or 9.0c, the personal computer may stop operating properly. If you are unsure if your personal computer is compatible, contact the maker.) Windows Media Player 6.4 to 10
Sound	DirectSound Support
Drive	CD-ROM drive—required to install this program (When writing to DVD, a compatible drive and media are necessary.)
Interface	USB port (USB 2.0 High Speed recommended)
Other requirements	Mouse or equivalent pointing device

MotionSD STUDIO

- This software is not compatible with a multi-boot environment.
- This software is not compatible with a multi-CPU environment.
- Operation is not guaranteed on Microsoft Windows XP Media Center Edition, Tablet PC Edition and not compatible with 64-bit computers.

Operating environment for using the unit as a Web camera

Personal computer	IBM PC/AT compatible personal computer
OS	Microsoft Windows 2000 Professional SP4/Microsoft Windows XP Home Edition SP1 or SP2/Microsoft Windows XP Professional SP1 or SP2 (The standard driver of OS is used after Windows XP SP2.)
CPU	Intel Pentium III 450 MHz or higher or Intel Celeron 400 MHz or higher
RAM	128 MB or more (256 MB or more recommended)
Display	High Color (16 bit) or more Desktop resolution of 800×600 pixels or more
Free hard disk space	250 MB or more
Necessary software	DirectX 9.0b or 9.0c Windows Messenger 5.0 or 5.1/MSN Messenger 7.0
Drive	CD-ROM drive
Interface	USB port
Other requirements	Mouse or equivalent pointing device

To use this unit as a Web Camera, the following conditions must be met.

- For information about how to use Windows Messenger/MSN Messenger, read the help file.
- The other parties also need to use the same software during the communication.
- Depending on the PC's security settings, proper communication may not be possible.

Installing MotionSD STUDIO

- Before attempting to start up the CD launcher, close all other software applications which are running.
- Do not perform any other operations on your PC while MotionSD STUDIO is being installed.

1



Insert the CD-ROM into the PC.

The CD launcher starts.

(Refer to page 79 if the CD launcher fails to start automatically after the CD-ROM has been inserted into the PC.)

2



Click [MotionSD STUDIO 1.0E].

- The software application may not run properly if you cancel the installation at any point e.g. by pressing [Cancel].

3



Click [Next].

- Continue to follow the on-screen messages to install it.

4

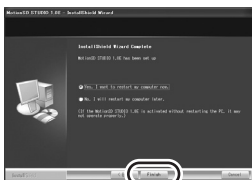

Click [Finish].

- After the application has been installed, the PC will reboot automatically.
- Depending on the operating environment, you may be required to install DirectX 9.0b. If so, click [Yes], and install it.

- If you install the software in a PC that is not compatible with DirectX 9.0b or 9.0c, the PC may stop operating properly. If you are unsure whether or not your PC is compatible, contact the maker.
- If you are unsure whether or not your PC is compatible, contact the maker of your PC.

Installing the Web Camera Driver

- Before attempting to start up the CD launcher, close all other software applications which are running.
- Install the driver if you are using Windows XP SP1 or Windows 2000 SP4. (With Windows XP SP2, the driver does not need to be installed because the Web camera is run using the operating system's standard driver.)
- If you are using Windows XP, installation may take some time depending on the environment.

Before proceeding with the installation, do not connect the USB cable. If you connect the USB cable, you will not be able to install the Web camera driver properly.

1



Insert the CD-ROM into the PC.

The CD launcher starts.

(Refer to page 79 if the CD launcher fails to start automatically after the CD-ROM has been inserted into the PC.)

2



Click [Web Camera Driver].

- The software application may not run properly if you cancel the installation at any point e.g. by pressing [Cancel].

3

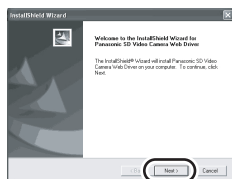

Click [Next].

4

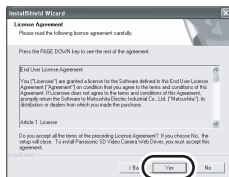

Read carefully through the terms and conditions shown on the screen for the [License Agreement], then click [Yes].

- You cannot install the application if you click [No].
 - After the application has been installed, the PC will reboot automatically.
 - Depending on the operating environment, you may be required to install DirectX 9.0b. If so, click [Yes], and install it.
- After the PC has rebooted, the installation of the Web camera driver starts from step 3.

5

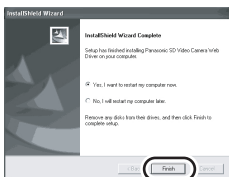

Click [Finish].

The PC must be rebooted for the driver to work.

■ **If the CD launcher fails to start automatically after the CD-ROM has been inserted into the PC**

Select [start] → [My Computer] (or double-click [My Computer] on the desktop), and double-click [PANASONIC]. (The CD launcher can also be started up by opening [PANASONIC] and double-clicking [autorun (.exe)]).

Connection and recognition procedures

After the driver and software applications are installed, the unit must be connected to the PC and be correctly recognized by the PC.

- Connect after installing the driver and software applications.
If you connect this unit to a PC before installation, this unit may not be properly recognized.
- If a CD-ROM is inserted in the PC, remove it. (If the CD launcher is running, wait until it finishes, then remove the CD-ROM.)
- If the recognition procedure is not accomplished properly, operation will not be possible after connecting the unit to the PC.
- If the unit fails to operate normally, it may mean that you have not conducted the installation or recognition procedure properly.
- Use AC adaptors as the power supply for the unit and the equipment connected to it.

◆ Connect this unit to the AC adaptor.

1

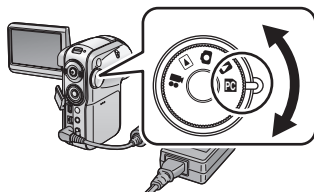

Select this unit's operation mode.

Motion picture recording	Web camera (P78)
Motion picture playback	Unavailable
Still picture recording	Web camera (P78)
Still picture playback	Unavailable
PC Connection mode	MotionSD STUDIO (P82) Card reader/writer function

- When this unit is in still picture playback mode, connect it to a printer supporting PictBridge. (P67)

2

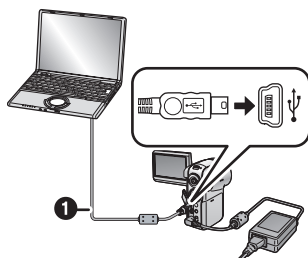

Open this unit's terminal cover, then firmly plug one end of the USB cable ① (supplied) into the USB terminal and the other end into the terminal on the PC.

- Insert the plugs as far as they will go. The unit and PC will not operate properly if they are not inserted fully.
 - Do not use any other USB cables except the supplied one. (Operation is not guaranteed with any other USB cables.)
- **When the unit is set to PC Connection mode and connected to a PC, the operation mode cannot be changed and its power cannot be turned off.** In this case, unplug the USB cable (P84), change the operation mode and then turn off its power.

When this unit is in motion picture recording mode or still picture recording mode, verify the driver. (P86)

- If you are running Windows 2000, the message shown on the right may appear the first time you connect this unit to the PC (the first time you use motion picture recording mode or motion picture playback mode). This has no effect on operation so click [Yes].
 - [Panasonic SD Video Camera Web Camera Device] is displayed.
 - The recognition procedure is completed automatically, and there may be no need to conduct any further steps. (You may proceed straight away to using this unit and PC.)



In PC Connection mode

[Removable disk] is displayed on [My Computer].

■ Folder structure of a removable disk

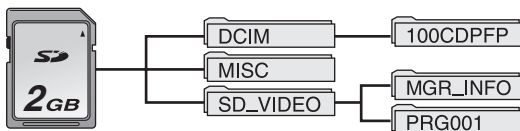

- The scenes recorded by this unit are stored in the following folders.

	Folder (example)	Scene (example)
Motion pictures	PRG001	MOV001.MOD
Still pictures	100CDPFP	IMGA0001.JPG

- Do not use the PC to delete the SD card's folders. Otherwise, it may no longer be possible for this unit to read the SD card.
- Always use this unit to format SD cards.
- When data not supported by this unit has been recorded on a PC, it will not be recognized by this unit.
- Up to 999 scenes can be recorded in the [100CDPFP] or other such folder.
- Up to 99 scenes can be recorded in the [PRG001] or other such folder.
- The DPOF setting scenes are recorded in the [MISC] folder.

**Do not acquire the files recorded on this unit by Internet Explorer etc.
Use MotionSD STUDIO to acquire them. (P82)**

Using MotionSD STUDIO

- Before initial use, select the software's [Read this first] from the start menu, then read through the additional instructions or updated information.
- The End User Licence Agreement is displayed when the software is first started so read carefully through its terms and conditions, then click [I agree].

■ Starting MotionSD STUDIO

1



Select [start]→
[All Programs (Programs)]→
[Panasonic]→
[MotionSD STUDIO 1.0E]→
[MotionSD STUDIO].

[Let's Try MotionSD STUDIO] is displayed on the screen.

■ Closing MotionSD STUDIO

1

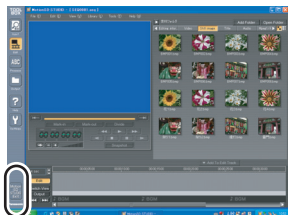

Click [MotionSD STUDIO Exit] at the very bottom of [TOOL BOX].

- MotionSD STUDIO can be closed by selecting [File]→[Exit] on the MotionSD STUDIO menu.

- If you use MotionSD STUDIO to edit images and then output them to an SD card, use an SD card made by Panasonic or one that allows motion picture recording. (P34)
- If you use MotionSD STUDIO to output a large number of scenes to an SD card, DVD R/RW or DVD-RAM, the scenes may be displayed as thumbnails or it may take time to output.

Reading the MotionSD STUDIO operating instructions

For details on how to use MotionSD STUDIO, read the PDF instructions or the help files.

1



Select [start]→
[All Programs (Programs)]→
[Panasonic]→
[MotionSD STUDIO 1.0E]→
[Manual (PDF format)].

- After starting the software, on the menu select [Help]→[Help] to display the help files.
- You will need Adobe Acrobat Reader 5.0 or later to read the PDF operating instructions. (P73)

Using the unit as a Web Camera

When the unit is connected to a PC, you can send pictures and audio from the unit over the Internet to the person you are communicating with. Alternatively, you can use the PC's speakers to configure a kind of Internet TV phone for communicating.

<Outline view of equipment configuration when using the unit as a Web camera>

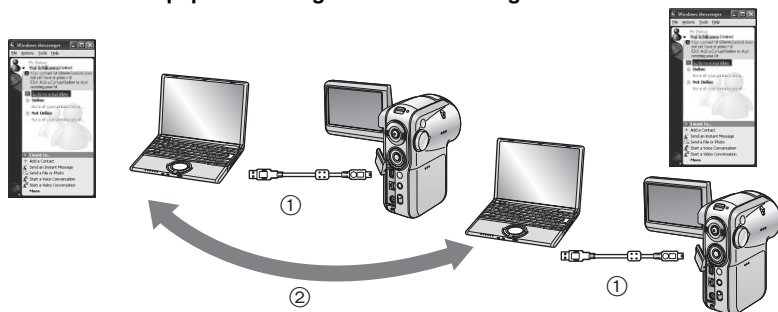

- ① Unit used as a Web Camera
- ② Computers connected via the Internet

- You must use AC adaptors as the power supply for all the equipment.
- You can use the PC's microphone instead of the unit's microphone. (Set it using PC.)
- Depending on the communication environment and the performance of the PC, the pictures and/or audio may break up during communication.

Using the unit as a Web Camera (continued)

■ Software that can be used when using the unit as a Web Camera

(○: Available, —: Not available)

			②		
			Windows XP		Windows 2000
			Windows Messenger	MSN Messenger	MSN Messenger
①	Windows XP	Windows Messenger	○	—	—
		MSN Messenger	—	○	○
	Windows 2000	MSN Messenger	—	○	○

Refer to page 76 for information about the operating environment.

① Your own PC

② Other person's PC

■ Connections

Before connecting the unit to the PC, you must install [Web Camera Driver]. (P78)

1) Turn on the unit's power, then set it to motion picture recording mode or still picture recording mode.

2) Connect the unit to the PC via the USB cable. (P80)

- Do not use any other USB cables except the supplied one. (Operation is not guaranteed with any other USB cables.)

3) Select [start] → [All Programs (Programs)] → [Windows Messenger] or [MSN Messenger].

To disconnect USB cable safely

1) Double click the  icon in task tray.

Hardware disconnect dialogue appears.

- Depending on your PC's settings, this icon may not be displayed.

2) Select [USB Mass Storage Device] and click [Stop].

3) Verify [MATSHITA SD Video Camera USB Device] is selected and click [OK].

- Click [OK], and you can safely disconnect the cable.

Software application uninstallation

Follow the steps below to uninstall any software applications that you no longer require.

1

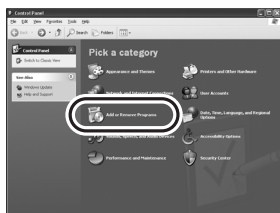

Click [start] → ([Settings] →) [Add or Remove Programs (Applications)] in [Control Panel].

2



Click here. Select the software application to be deleted, then click [Change/Remove] ([Change or Remove] or [Add/Remove]).

- Proceed with the uninstallation by following the on-screen instructions.
- Select [Panasonic SD Video Camera Web Driver] to uninstall the Web camera driver.
- To remove the Web camera driver from the PC's device manager, verify the driver by referring to "Verifying the driver" (P86), then delete the driver manually.

Verifying the driver

If the driver does not work properly, follow the steps below to verify if it has been recognized properly. Select the unit's mode, connect the unit to the PC via the USB cable, then verify the driver. (P80)

- With some PCs including those made by NEC, the Device Manager may not be displayed if a mode that places restrictions on the functions has been established. Consult the manufacturer or follow the steps in your PC's operating instructions to establish a mode in which all the functions can be used, then proceed with operation.

1

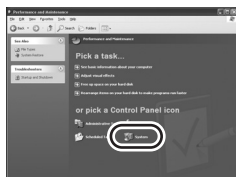

Select [start]→([Settings]→) [Control Panel]→([Performance and Maintenance]→) [System].

2



Display [Device Manager], and check whether the driver has been installed properly.

- Click the [Hardware] tab, then click [Device Manager].

■ If the driver has been recognized properly (When the unit is in the motion picture recording or still picture recording mode) Windows XP:

[USB compound device] is displayed at [USB controller] and [USB video device] at [Imaging device].

- If two, three or more SD video cameras are connected, [USB video device #X (X: number)] may appear.

Windows 2000:

[Panasonic SD Video Camera Web Camera Device] appears at [Imaging device].

(When the unit is in PC Connection mode)

[USB Mass Storage Device] appears at [USB (Universal Serial Bus) controller].

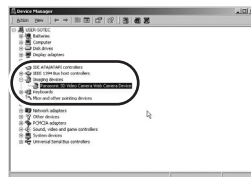

■ If the driver has not been recognized properly

[!] or [Unknown device] appears at [USB (Universal Serial Bus) controller] or [Other devices], etc.

(Where the display will appear depends on the type of PC you are using.)

Disconnect the USB cable, uninstall then re-install the [Web Camera Driver] (P78) and connect the USB cable again.

In the following cases, the Web camera driver has not been installed properly.



- When an exclamation [!] mark appears at [USB compound device] under [USB (Universal Serial Bus) controller] or at [USB video device] under [Imaging device]
- When [Web Camera] is displayed at [Other devices]



Remove the driver from Device Manager, uninstall it (P85), re-install [Web Camera Driver] (P78), then conduct the connection procedure once more.



Approximate Number of Recordable Pictures on an SD Card



Number of recordable pictures



■ Picture quality and number of recordable pictures (using SD Memory Cards)

Picture size	[2048] (2048×1512)	
Picture quality		
8 MB	2	4
16 MB	7	12
32 MB	18	28
64 MB	38	61
128 MB	75	120
256 MB	155	250
512 MB	310	490
1 GB	630	990
2 GB	1280	2010

[1280] (1280×960)	
	
7	12
20	32
45	73
96	155
185	300
390	620
770	1230
1550	2470
3160	5030

Picture size	[640] (640×480)	
Picture quality		
8 MB	37	75
16 MB	92	185
32 MB	200	410
64 MB	430	850
128 MB	820	1640
256 MB	1710	3410
512 MB	3390	6780
1 GB	6790	13580
2 GB	13820	27640

[HDTV] (1920×1080)	
	
3	6
10	16
23	37
50	80
98	155
210	320
410	640
820	1290
1670	2630

- The number of recordable pictures depends on whether [] and [] are used together and on the subject being recorded.
- The numbers shown in the table are approximations.

Menu list

Motion picture recording menus

■ [BASIC]

BASIC	
[SCN] SCENE MODE	OFF
[WIND] WIND CUT	ON
[REC] REC MODE	SP
[WIDE] WIDE	ON
[CLOCK] CLOCK SET	NO
SETUP [ENTER]	EXIT [MENU]

[SCN] **SCENE MODE**] (P43)

[WIND] **WIND CUT**] (P40)

[REC] **REC MODE**] (P34)

[WIDE] **WIDE**] (P40)

[CLOCK] **CLOCK SET**] (P28)

■ [ADVANCE]

ADVANCE	
[D.ZOOM] D.ZOOM	25x
[O.I.S.] O.I.S.]	ON
[MAGICPIX] MAGICPIX	OFF
[REC LAMP] REC LAMP	OFF
[ZOOM MIC] ZOOM MIC	OFF
SETUP [ENTER]	EXIT [MENU]

[D.ZOOM] **D.ZOOM**] (P36)

[O.I.S.] **O.I.S.]** (P41)

[MAGICPIX] **MAGICPIX**] (P42)

[REC LAMP] **REC LAMP**] (P32)

[ZOOM MIC] **ZOOM MIC**] (P37)

■ [SETUP]

SETUP 1/3	
[DISPLAY] DISPLAY	ON
[DATE/TIME] DATE/TIME	D/T
[DATE FORMAT] DATE FORMAT	M/D/Y
[FORMAT CARD] FORMAT CARD	NO
[QUICK START] QUICK START	OFF
SETUP [ENTER]	EXIT [MENU]

[DISPLAY] **DISPLAY**] (P91)

[DATE/TIME] **DATE/TIME**] (P29)

[DATE FORMAT] **DATE FORMAT**] (P28)

[FORMAT CARD] **FORMAT CARD**] (P65)

[QUICK START] **QUICK START**] (P18)

[POWER SAVE] **POWER SAVE**] (P91)

[BEEP SOUND] **BEEP SOUND**] (P91)

[LCD AI] **LCD AI**] (P30)

[LCD SET] **LCD SET**] (P29)

[INITIAL SET] **INITIAL SET**] (P91)

[DEMO] **DEMO MODE**] (P91)

Still picture recording menu

- For [ SETUP] items, refer to the motion picture recording menus.

■ [BASIC]

BASIC	
[SCN] SCENE MODE	OFF
[PICTURE SIZE] PICTURE SIZE	HDTV
[PICT.QUALITY] PICT.QUALITY	[]
[CLOCK SET] CLOCK SET	NO
SETUP [ENTER]	EXIT [MENU]

[SCN] **SCENE MODE**] (P43)

[PICTURE SIZE] **PICTURE SIZE**] (P52)

[PICT.QUALITY] **PICT.QUALITY**] (P52)

[CLOCK SET] **CLOCK SET**] (P28)

■ [ADVANCE]

ADVANCE 1/2	
[FLASH] FLASH	[]
[RED EYE] RED EYE	OFF
[FLASH LEVEL] FLASH LEVEL	[]
[O.I.S.] O.I.S.]	ON
[REC LAMP] REC LAMP	OFF
SETUP [ENTER]	EXIT [MENU]

[FLASH] **FLASH**] (P54)

[RED EYE] **RED EYE**] (P54)

[FLASH LEVEL] **FLASH LEVEL**] (P55)

[O.I.S.] **O.I.S.]** (P41)

[REC LAMP] **REC LAMP**] (P32)

[SHTR EFFECT] **SHTR EFFECT**] (P52)

▶ Motion picture playback menus

■ [🗑️] DELETE]

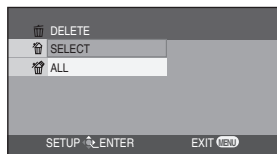

[🗑️ SELECT] (P62)

[🗑️ ALL] (P62)

■ [▶] PLAY SETUP]

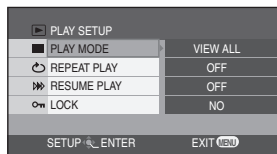

[■ PLAY MODE] (P59)

[↺ REPEAT PLAY] (P59)

[⏪ RESUME PLAY] (P59)

[🔒 LOCK] (P64)

■ [⚙️] SETUP]

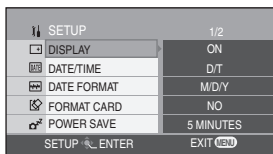

[☐ + DISPLAY] (P91)

[🕒 DATE/TIME] (P29)

[📅 DATE FORMAT] (P28)

[📄 FORMAT CARD] (P65)

[⏻ POWER SAVE] (P91)

[🔔 BEEP SOUND] (P91)

[🌟 LCD AI] (P30)

[☐ LCD SET] (P29)

[☐ TV ASPECT] (P71)

▶ Still picture playback menus

- For [🗑️]DELETE] and [⚙️]SETUP] items, refer to the motion picture playback menus.

■ [▶] PLAY SETUP]

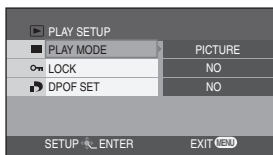

[■ PLAY MODE] (P59)

[🔒 LOCK] (P64)

[📄 DPOF SET] (P66)

Setup menu

■ [DISPLAY]

- OFF
- ON

The screen indications are selected as shown in the illustration below.

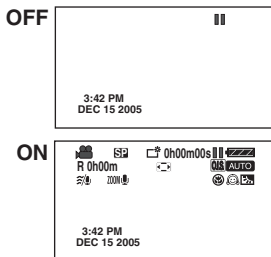

■ [BEEP SOUND]

- OFF
- ON

This allows operations such as starting and ending recording to be signalled by a beep.

When [OFF] is set, no beep is heard when an operation such as recording is started or ended.

1 Beep

When you start recording or turn on the power. Also when deleting files, when the confirmation message appears while formatting and when this unit is recognized by the PC or the printer.

2 Beeps

When you pause recording or turn off the power.

2 Beeps 4 times

If you insert an SD card with the write protection switch set to [LOCK] when a recording mode has been selected. If you select a recording mode when an SD card with the write protection switch set to [LOCK] has been inserted. Check the sentence displayed on the screen. (P94)

■ [POWER SAVE]

- OFF
- 5 MINUTES

[OFF]: The power saving function is not activated.

[5 MINUTES]:

When about 5 minutes passed without any operation, this unit automatically turns off to prevent the battery from running down. When you use this unit, turn it on again.

- In the following cases, the power may not turn off even when set [POWER SAVE]→[5 MINUTES].
 - When connecting to the AC outlet (When using the AC adaptor)
 - When connecting the unit to a PC or printer via the USB cable

■ [INITIAL SET]



- YES
- NO

When there is a menu that cannot be selected depending on a combination of functions, set to [YES] for changing the menu settings back to the initial shipping condition.

■ [DEMO MODE]

- OFF
- ON

This item is used to start the unit demonstration.

(Only when the mode dial is at the  or  position)

- If you set to [DEMO MODE]→[ON] without inserting an SD card, this unit is automatically set to the demonstration mode for introducing its functions. If any button is pressed or operated, the demonstration mode is canceled. If no operations take place for approx. 10 minutes, the demonstration mode automatically starts. To terminate the demonstration mode, insert an SD card, or set to [DEMO MODE]→[OFF]. For normal use, set this function to [OFF].

Indications

Recording indications

1 Motion picture recording

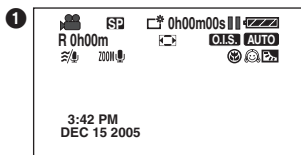

2 Still picture recording

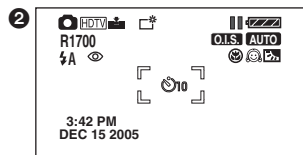

	Remaining battery power
R 0h00m	Remaining time left for recording
0h00m00s	Time code
12:30 PM DEC 15 2005	Date/Time indication
	Recording
	Recording pause
	Digital zoom
AUTO	Auto mode
MNL	Manual mode
MF	Manual focus
2×	Zoom magnification indication
	Back light mode
O.I.S.	Image stabilizer
	Power LCD
1/60	Shutter speed
OPEN/F2.4	F number
6dB	Gain value
WEB	WEB CAMERA mode
	Soft skin mode
	Tele macro
	MagicPix function
ZOOM	Zoom microphone
	Wind noise reduction
XP, SP, LP	Motion picture recording mode

	Sports mode
	Portrait mode
	Low light mode
	Spotlight mode
	Surf & snow mode
AWB	Auto white balance
	Indoor mode (recording under incandescent lamp)
	Outdoor mode
	Manual adjustment mode
	Video flash
	Red eye reduction
	Shutter chance mark
	Self-Timer recording
MEGA	MEGA OIS
	Number of recording pixels for still pictures
2048	2048×1512
1280	1280×960
640	640×480
HDTV	1920×1080
	Still picture quality
R 18	Remaining number of still pictures (Flashes in red when [R 0] appears.)

Playback indications

1 Motion picture playback

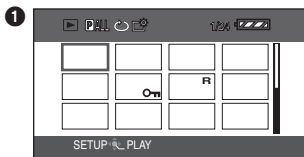

	Playback
	Pause
	Cue/Review playback
	Last/first file paused
	Skip playback
	Slow motion playback
	Frame-by-frame playback
0h00m00s	Motion picture playback time
	Select playback
	Volume adjustment
	Slide show playback
100-0001	Still picture folder/Scene number display
No. 10	File number
	When a printer compatible with PictBridge is connected
000	Number of DPOF Setting
1	DPOF already set (to more than 1)
On	Lock setting
R	Resume playback
	Repeat playback
	Number of recording pixels for still pictures
	2048×1512
	1280×960
	640×480
	1920×1080

2 Still picture playback

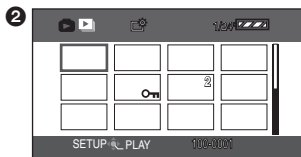

	2048 pixels or more
	1600 or more, less than 2048 pixels
	1280 or more, less than 1600 pixels
	1024 or more, less than 1280 pixels
	800 or more, less than 1024 pixels
	640 or more, less than 800 pixels (The size is not displayed at under 640 pixels.)
For pictures not recorded with this unit, the size display is determined as follows according to the number of horizontal pixels. If this number is 2048, 1280 or 640, then [2048], [1280] or [640] will be displayed respectively regardless of the number of vertical pixels.	

Confirmatory indications

	The built-in battery is low. (P29)
	<ul style="list-style-type: none"> The warning/alarm indication appears in face-to-face recording style. Return the direction of the LCD monitor in normal position and check the warning/alarm indication. (P21) The warning/alarm indication appears during Web camera operations. For details of the warning, refer to the Troubleshooting. (P101)
	No SD card is inserted/ unusable card.

Confirmatory indications

CANNOT RECORD.	Data writing to the SD card has failed.
CHECK CARD.	This card is not compatible or it cannot be recognized by the unit.
THIS CARD CANNOT RECORD IN VIDEO MODE.	An 8 MB or 16 MB SD card has been inserted in motion picture recording mode.
CARD LOCKED.	The write protection switch on the SD Memory Card is set to [LOCK]. (P15)
SCENE NUMBER IS FULL.	The number of still pictures or motion picture scenes (program) that can be recorded on 1 card is exceeded. Delete unnecessary scenes or insert a new SD card. (P14, 62)
PROGRAM NUMBER IS FULL.	
NO CARD.	No SD card is inserted. (P14)
CARD DOOR OPENED.	The unit is being operated with the card slot open.
CARD FULL.	The SD card is full. No further data can be recorded. Delete motion picture files or insert a new SD card. (P14, 62)
UNPLAYABLE CARD.	The data on the SD card cannot be played back.
FILE LOCKED.	You are attempting to erase protected files. (P15)
NOW ACCESSING. PLEASE DO NOT REMOVE CARD.	Data processing is now underway. Close the card slot and wait a few moments.
NO DATA.	There are not any still pictures and motion pictures recorded on the SD card.
CARD ERROR. PLEASE REFORMAT.	SD card formatting has failed.
CANNOT SET DPOF.	Writing of the DPOF setting to the SD card has failed.
CONTROL INFORMATION DIFFER. CANNOT USE THIS CARD IN VIDEO MODE.	The data on the card differs from the Video Mode standard. Save the data on a PC and then format the card before use.
SCENE IN PROTECTED PROGRAM OR PLAYLIST.	You are attempting to erase a protected scene or a scene in a play list created on another device.
LOW BATTERY.	The battery is low. Recharge it. (P17)
PUSH THE RESET SWITCH.	An irregularity in the equipment has been detected. Remove the SD card then press the reset switch to restart the unit. (P101)

CHANGE TO MANUAL MODE.	You have set the [AUTO/MANUAL/FOCUS] switch to [AUTO] and are attempting to set [SCENE MODE] from the menu screen.
CANCEL MAGICPIX MODE.	You are attempting to set [SCENE MODE] from the menu screen while MAGICPIX is set. (P42)
TURN OFF POWER LCD.	You are attempting to set [LCD AI] from the menu screen when the [POWER LCD] button has been pressed to brighten the LCD monitor.
NO INK IN PRINTER.	Check the connected printer.
NO PAPER IN PRINTER.	
PRINTER ERROR.	
PLEASE CONNECT AC ADAPTOR AND BATTERY.	The AC adaptor has not been connected or the battery has not been inserted while the unit is connected to the PC in PC Connection mode.
CHANGE MODE TO USE USB.	The USB cable is connected in the motion picture playback mode.
DISCONNECT USB CABLE.	Another mode has been selected from the PC Connection mode while the USB cable was still connected.
	Disconnect the USB cable and ensure that the battery has been inserted in the unit. Then connect the AC adaptor and the USB cable.
	This indication appears if the USB cable remains connected for more than 5 minutes when a printer or the PC is connected.
	The unit's power cannot be turned off which the unit is connected to the PC.

■ About recovery

When the SD card was accessed, you tried to playback a file displayed as a thumbnail in shades of blue and white (P101) or faulty control information or a play list created on another device was read, a control information recovery message or play list delete message such as those shown below may be displayed. (After recovery starts, it may take time depending on the error.)

REPAIRING CONTROL DATA. PLEASE
CONNECT AC ADAPTOR.



DATA ERROR OCCURRED. REPAIR SD
DATA NOW?



YES/NO

YES

When connecting to AC adaptor or the remaining capacity of the battery is enough:
[FINISHED]

When the remaining capacity of the battery is low:
[PLEASE CONNECT AC ADAPTOR OR CHANGE BATTERY.]

NO

[CANNOT USE THIS CARD IN VIDEO MODE WITHOUT REPAIRING DATA ERROR.]

- When you recover files or delete play lists, you can record or play motion pictures again. Therefore, be sure to follow the instruction.
- When data recorded on another device is recovered, it may not be possible to play back the data on this unit or the other device. Always use this unit to recover data recorded on it.
- In the case that recovery fails, format the SD card with this unit (in still picture recording mode or still picture playback mode) or MotionSD STUDIO (P73).

PLAYLIST ERROR. DELETE THIS
PLAYLIST?/PLAYLIST ERROR. DELETE
ALL PLAYLISTS?



YES/NO

YES

When connecting to AC adaptor or the remaining capacity of the battery is enough:
[FINISHED]

When the remaining capacity of the battery is low:
[PLEASE CONNECT AC ADAPTOR OR CHANGE BATTERY.]

NO

[CANNOT USE THIS CARD IN VIDEO MODE WITHOUT REPAIRING DATA ERROR.]

Functions that cannot be used simultaneously



Some functions in this unit are disabled or cannot be selected due to the unit's specifications. The table below shows examples of functions restricted by various conditions.

Functions	Conditions which disable the functions
Digital zoom MagicPix	<ul style="list-style-type: none"> • In still picture recording mode
Backlight compensation	<ul style="list-style-type: none"> • When the MagicPix function is used • When the iris/gain is set
Flash	<ul style="list-style-type: none"> • In motion picture recording mode • During demo mode
Scene mode	<ul style="list-style-type: none"> • When setting the [AUTO/MANUAL/ FOCUS] switch to [AUTO] • When the MagicPix function is used
Zoom	<ul style="list-style-type: none"> • When the record button is pressed halfway in still picture recording

Functions	Conditions which disable the functions
Change of white balance	<ul style="list-style-type: none"> • When digital zoom (10× or higher) is used • When the MagicPix function is used
Adjusting the shutter speed, iris/gain	<ul style="list-style-type: none"> • When the MagicPix function is used • When the scene mode is used
Deleting files	<ul style="list-style-type: none"> • When the write protection switch on the SD card is set to [LOCK] (P15) • When the file is protected
Formatting	<ul style="list-style-type: none"> • When the write protection switch on the SD card is set to [LOCK] (P15)
DPOF setting	
LOCK setting	





Troubleshooting

Problem	Check points
This unit cannot be turned on.	<ul style="list-style-type: none"> ● Is the battery fully charged? → Charge the battery using the AC adaptor. (P17)
This unit is turned off automatically.	<ul style="list-style-type: none"> ● If you do not use the unit for approximately 5 minutes, the power is automatically turned off to conserve the battery charge. (P91) To resume recording, turn the power back on. The power will not turn off automatically when the power save function (P91) is set to [OFF].
This unit does not stay on long enough.	<ul style="list-style-type: none"> ● Is the battery low? → If the remaining battery power indication is flashing or the message "LOW BATTERY." is displayed, the battery has run down. Charge the battery. (P17)
Battery runs down quickly.	<ul style="list-style-type: none"> ● Is the battery fully charged? → Charge it with the AC adaptor. (P17) ● Are you using the battery in an extremely cold place? → The battery is affected by ambient temperature. In cold places, the operating time of the battery becomes shorter. ● Has the battery worn out? → The battery has a limited life. If the operating time is still too short even after the battery is fully charged, depending on the usage, the battery has worn out and can no longer be used.
This unit cannot be operated though powered up. This unit does not operate normally.	<ul style="list-style-type: none"> ● Press the [RESET] button. (P101) If normal conditions are not restored yet, remove the battery or disconnect the AC adaptor, wait about 1 minute and then reinsert the battery or reconnect the AC adaptor. Then, about 1 minute later, turn on the power again. (Conducting the above operation when the access lamp is on may destroy the data on the SD card.)
The remote control does not function.	<ul style="list-style-type: none"> ● Has the button-type battery of the remote control run out? → Replace it with a new button-type battery. (P13)
The screen has changed suddenly.	<ul style="list-style-type: none"> ● Has the demonstration started? → If you set [DEMO MODE] to [ON] without inserting an SD card in motion picture recording mode or still picture recording mode, the unit is automatically set to the demonstration mode for introducing its functions. Normally this should be set to [OFF]. (P91)

Problem	Check points
Recording does not start although power is supplied to this unit and the SD card is correctly inserted.	<ul style="list-style-type: none"> ● Has the SD card's write protect switch been set to [LOCK]? → No recording is possible while the write protect switch is set to [LOCK]. (P15) ● Is the SD card's memory full? → If the card has no more available memory, free up some memory by copying some scenes to a PC (P80) and then deleting unnecessary scenes. (P62) ● Is the unit set to the motion picture recording mode or still picture recording mode? → No recording is possible unless the mode dial is at  or . (P20) ● Is the card cover open? → If the cover is open, this unit may not operate normally. Close the card cover. (P14)
Motion picture recording stops suddenly.	<ul style="list-style-type: none"> ● Can the SD card be used for motion picture recording? → Use an SD card that can be used for motion picture recording. (P34, 35)
Auto focus function does not work.	<ul style="list-style-type: none"> ● Is manual focus mode selected? → If auto mode is selected, focus is automatically adjusted. (P32) ● Are you trying to record a scene which is hard to bring into focus in auto focus mode? → There are some recording subjects and surroundings for which the auto focus does not operate correctly. (P104) If so, use the manual focus mode to adjust the focus. (P45) ● Is the MagicPix set? → When the MagicPix is working, focusing shifts into the manual mode. (P45)
A sentence is displayed in the screen center.	<ul style="list-style-type: none"> ● Read the contents and respond to them. (P93)
A function indication such as mode indication, remaining time indication, or time code indication is not shown.	<ul style="list-style-type: none"> ● If you set [SETUP]→[DISPLAY]→[OFF], indications other than warnings and date indications disappear.
Sound is not played back from the built-in speaker of this unit.	<ul style="list-style-type: none"> ● Is the volume too low? → During playback, move the volume lever to display the volume indication and adjust it. (P58)

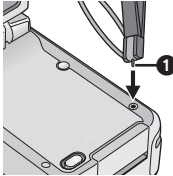
Troubleshooting (continued)

Problem	Check points
Although this unit is correctly connected to a TV, playback images cannot be seen.	<ul style="list-style-type: none"> Have you selected video input on the TV? → Please read the operating instructions of your TV and select the channel that matches the input used for the connection.
Playback image is not clear. Sound breaks up or noise affects the picture and/or sound.	<ul style="list-style-type: none"> Noise may interfere with the picture and/or sound when the multi cable terminal becomes dirty. Wipe off any dirt with a soft cloth, then connect to the multi-connector.
Images played back on TV are cut.	<ul style="list-style-type: none"> Depending on the TV connected, the sides of the images being played may not appear. We recommend widening the recording range of the objects you want to record beforehand.
Recorded pictures are not clear.	<ul style="list-style-type: none"> Are you trying to record small or finely detailed objects with [PICT.QUALITY] set at []? → If you try to record small or finely detailed objects with [PICT.QUALITY] set at [], the images may break up into a mosaic-like pattern. Record with [PICT.QUALITY] set at [] instead. (P52)
A scene recorded on an SD card cannot be deleted.	<ul style="list-style-type: none"> Is the scene locked? → Locked scenes cannot be deleted. (P64) For the SD Memory Card, if its write protect switch is set to [LOCK], then deletion is disabled. (P15)
The images on the SD card do not look normal.	<ul style="list-style-type: none"> The data may be destroyed. It may have been destroyed by static or electromagnetic waves. Record important data on a PC or other equipment as well. (P80)
During playback, [UNPLAYABLE CARD.] is displayed.	<ul style="list-style-type: none"> Data with different formats or destroyed data is being played back.
The indication disappears. The screen is frozen. No operation can be performed.	<ul style="list-style-type: none"> Turn off the power to this unit. If the power cannot be turned off, press the [RESET] button. You can also remove the battery and then reinsert it or disconnect the AC adaptor and then reconnect it. After that, turn on the power again. If normal operation is still not restored, detach the power connected, and consult the dealer who you purchased this unit from.
Even if an SD card is formatted, it cannot be used.	<ul style="list-style-type: none"> Either this unit or the SD card may be damaged. Please consult a dealer.

Problem	Check points
<p>The scenes are not correctly displayed in thumbnails.</p>	<ul style="list-style-type: none"> Scenes displayed as thumbnails in shades of blue and white cannot be played back or deleted. If the scenes are unnecessary, format the SD card to erase the data. Please be aware that if an SD card is formatted, then all the data recorded on the card will be erased. Store important data on a PC, etc. When saving scenes recorded using this unit to a PC, you must use MotionSD STUDIO. (P73) 
<p>“PUSH THE RESET SWITCH.” is displayed.</p>	<ul style="list-style-type: none"> The unit has automatically detected an error. To protect the data, remove the SD card and then press the [RESET] button with the projecting part ❶ of the hand strap. This will restart the unit. When you press the [RESET] button, the date and time setting will also be reset. Set the date and time again. Even after you press the [RESET] button, the indication may still appear repeatedly. If so, this unit needs repair. Detach the power connected, and consult the dealer who you purchased this unit from. Do not attempt to repair the appliance by yourself. 
<p>Even if connected by the USB cable, this unit is not recognized by the PC.</p>	<ul style="list-style-type: none"> Have you installed the Web camera driver? → Install the driver, then check the connections. Have you set this unit to the correct mode? → The unit is not recognized if it is set to motion picture playback mode. (P80) Select another USB terminal on the PC. Check the operating environment. (P75, 76) Turn on the power to this unit.
<p>When the USB cable is disconnected, an error message will appear on PC.</p>	<ul style="list-style-type: none"> To disconnect the USB cable safely, double-click the  icon in the task tray and follow the instructions on the screen.
<p>The warning/alarm indication  appears when this unit is operated in the WEB camera mode.</p>	<ul style="list-style-type: none"> Did you press the record button or any other button? → You cannot record onto the card in the WEB camera mode. Have you installed the Web camera driver? → Install the driver, then check the connections.
<p>The [] indication flashes when this unit is connected to a PC.</p>	<ul style="list-style-type: none"> The unit is connected to a Windows XP PC in still picture playback mode. → Connect with a printer supporting PictBridge.
<p>The [] indication appears when the unit is connected to the printer.</p>	<ul style="list-style-type: none"> The unit is connected to the printer in motion picture recording mode or still picture recording mode. → Change the mode to still picture playback mode.

About condensation

When condensation forms on the unit, the lens will cloud up and the unit may not work properly. Make every effort to ensure that condensation does not form. If it does form, take the actions described below.

Causes of condensation

Condensation takes place when the ambient temperature or humidity is changed as follows.

- When this unit is brought inside from the cold (e.g. a ski slope) to a warm room.
- When this unit is moved from an air-conditioned car to outside.
- When a cold room has been warmed up quickly.
- When cool wind from an air conditioner is directly blown onto this unit.
- After summer afternoon showers of rain.
- When this unit is in a very humid place where the air is thick with steam. (e.g. a heated swimming pool)

When this unit is taken to a location with a significant temperature difference such as from a cold place to a hot place.

If, for example, you have used this unit for recording on a ski slope and are taking it into a heated room, place the unit inside a plastic bag, remove as much of the air from inside the bag as possible, then seal the bag. Leave the unit for about an hour in the room so the temperature of the unit is close to the ambient temperature of the room, then use it.

What to do with the lens is fogged up.

Remove the battery or disconnect the AC adaptor and leave the unit for about 1 hour. When the unit becomes close to the ambient temperature, the fog disappears naturally.

Explanation of terms

Automatic white balance

White balance adjustment recognizes the colour of light and adjusts so the white colour will become a purer white. The unit determines the hue of light that comes through the lens and white balance sensor, thereby judging the recording condition, and selects the closest hue setting.

This is called automatic white balance adjustment.

However, since the unit only stores white colour information under several light sources, automatic white balance adjustment does not function normally under other light sources.

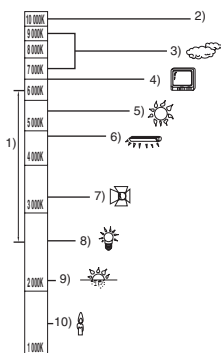

The illustration above shows the range over which the auto white balance functions.

- 1) The effective range of automatic white balance adjustment on this unit
- 2) Blue sky
- 3) Cloudy sky (rain)
- 4) TV screen
- 5) Sunlight
- 6) White fluorescent lamp
- 7) Halogen light bulb
- 8) Incandescent light bulb
- 9) Sunrise or sunset
- 10) Candlelight

Outside of the effective range of automatic white balance adjustment, the

image will become reddish or bluish.

Even within the effective range of automatic white balance adjustment, the automatic white balance adjustment may not function properly if there is more than one light source. For light outside the functional auto white balance adjustment range, use the manual white balance adjustment mode.

White balance

The images recorded by the unit may become bluish or reddish under the influence of certain light sources. To avoid such phenomena, adjust the white balance.

White balance adjustment determines the white colour under different light sources. By recognizing which is the white colour under sunlight and which is the white colour under a fluorescent light, the unit can adjust the balance among the other colours.

Since the white colour is the reference for all the colours (that make up light), the unit can record pictures in a natural hue if it can recognize the reference colour white.

Auto focus

The lens is moved forward or backward automatically to bring the subject into focus.

Auto focus has the following characteristics.

- Adjusts so that the vertical lines of a subject are seen more clearly.
- Attempts to bring an object with higher contrast into focus.
- Focuses on the screen center only.

Due to these characteristics, auto focus does not work correctly in the following situations. Record pictures in the manual focus mode.

Recording distant and close-up objects at the same time

Since the unit focuses on whatever is at the center of the screen, it is difficult to bring the background into focus when close-up objects are placed in focus. When recording people with distant mountains in the background, you cannot focus on both the subject which is close-up and the objects which are in the distance.

Recording a subject behind dirty or dusty window

The subject behind the window will not be focused because the focus is on the dirty window.

Similarly, when recording something on the opposite side of a road with heavy traffic, a vehicle that happens to pass by may be brought into focus.

Recording a subject that is surrounded by objects with glossy surfaces or by highly reflective objects

Since whatever is shiny or glistens is brought into focus, it is hard to focus on the subject to be recorded. The focus may become blurry when recording subjects at the seashore, in night views or in scenes involving fireworks or special lights.

Recording a subject in dark surroundings

The unit cannot focus correctly because the light information that comes through the lens decreases considerably.

Recording a fast-moving subject

As the focus lens-inside moves mechanically, it cannot keep up with a fast-moving subject.

When, for example, recording a sports event with fast moving subjects, the focus may lose its sharpness.

Recording a subject with little contrast

It is easy to bring subjects with a sharp contrast or vertical lines or stripes into focus. This means that a subject with little contrast, such as a white wall, may become blurry because the unit achieves focus based upon the vertical lines of an image.

Concerning MPEG2 motion pictures

“MPEG” stands for Moving Pictures Experts Group. It refers to a format for compressing video.

MPEG2 enables motion pictures to be played back more smoothly and attractively by sending the image data at a rate of 30 frames per second.

Cautions for Use

About this unit

Read the operating instructions before use.

- The unit and SD Memory Card become warm after long operation, but this is not a malfunction.

Keep the unit away from magnetized equipment/mobile phones, microwave ovens, TVs and video game equipment.

- If you use the unit on or near a TV, the images or sound may be disturbed due to electromagnetic wave radiation.
- Do not use near cell phone because doing so may cause noise to adversely affect the picture and sound.
- Recordings may be damaged, or images may be distorted, by the strong magnetic fields created by speakers or large motors.
- Electromagnetic wave radiation generated by digital circuits including microprocessors may adversely affect the unit, causing the disturbance of images and sounds.
- If the unit is affected by such equipment and does not function properly, remove the battery or disconnect the AC adaptor. Then insert the battery again or connect the AC adaptor again.

Do not use the unit near radio transmitters or high-voltage cables.

- If you record pictures near radio transmitters or high-voltage cables, recorded images or sounds may be adversely affected.

Make sure to use the supplied cords and cables. If you use optional accessories, use the cords and the cables supplied with them.

Do not extend the cords and the cables.

Do not spray insecticides or volatile chemicals onto the unit.

- If the unit is sprayed with such chemicals, its body may be marred and the surface finish may peel off.

- Do not leave rubber or plastic products in contact with the unit for a long time.

When you use the unit in a sandy or dusty place such as a beach, do not let sand or fine dust get into the body and terminals of the unit.

Also, keep the unit away from sea water.

- Sand or dust may damage the unit. (Care should be taken when inserting and removing an SD card.)
- If sea water splashes onto the unit, wipe off the water with a well rung cloth. Then wipe the unit again with a dry cloth.

When carrying the unit, do not drop or bump it.

- A strong impact can break the unit's casing, causing it to malfunction.

Do not use benzene, paint thinner or alcohol for cleaning the unit.

- Before cleaning, detach the battery or pull out the AC mains lead from the AC mains socket.
- The camera body may be discoloured and the surface finish may peel off.
- Wipe the unit with a soft dry cloth to remove dust and fingerprints. To remove stubborn stains, thoroughly ring a cloth that has been soaked in a neutral detergent diluted with water and wipe the unit with it. Afterwards, wipe it with a dry cloth.
- When you use a chemical dust cloth, follow the instructions.

Do not use the unit for surveillance purposes or other business uses.

- If you use the unit for a long time, heat will build up inside it and this may cause a malfunction.
- The unit is not intended for business use.

When you are not going to use the unit for an extended time

- When storing the unit in a cupboard or cabinet, it is recommended that you put a desiccant (silica gel) in with it.

About the battery

The battery used in this unit is a rechargeable lithium-ion battery. It is susceptible to humidity and temperature and the effect increases the more the temperature rises or falls. In cold areas, the full charge indication may not appear or the low battery indication may appear about 5 minutes after starting use. At high temperatures, the protection function may be triggered, making it impossible to use the unit.

Be sure to detach the battery after use.

- If the battery is left inserted, a minute amount of current continues to flow even if the unit's power is off. Keeping the unit in this state may result in over discharge of the battery. The battery may become unusable after it is charged.

Prepare spare batteries when going out for recording.

- In cold places such as a ski resort, the period during which you can record pictures is shortened.
- When you travel, do not forget to bring an AC adaptor (supplied) so that you can recharge the batteries at your destination.

If you drop the battery accidentally, check to see if the terminals are damaged.

- Attaching a battery with damaged terminals can damage the unit.

Tips for storing the battery

- The battery should be stored in the vinyl bag so metal does not come into contact with the terminals.
- The battery should be stored in a cool place free from humidity, with as constant temperature as possible. (Recommended temperature: 15 °C to 25 °C (59 °F to 77 °F), Recommended humidity: 40% to 60%)
- Extremely high temperatures or low temperatures will shorten the life of the battery.

- If the battery is kept in high-temperature, high-humidity, or oily-smoky places, the terminals may rust and cause malfunctions.
- To store the battery for a long period of time, we recommend you charge it once every year and store it again after you have completely used up the charged capacity.
- Dust and other matter attached to the battery terminals should be removed.

Do not throw old battery into fire.

- Heating a battery or throwing it into a fire may result in an explosion.
- If the operating time is very short even after the battery has been recharged, the battery has worn out. Please purchase a new battery.

About the AC adaptor

- Be sure to use the supplied AC adaptor.
- If you use the AC adaptor near a radio, radio reception may be disturbed. Keep the AC adaptor 1 m (3.3 feet) or more away from the radio.
- When using the AC adaptor, it may generate whirring sounds. However, this is normal.
- After use, be sure to disconnect the AC adaptor. (If it is left connected, about 0.1 W of current is consumed at most.)
- Always keep the electrodes of the AC adaptor and battery clean.

Put this unit near the outlet to make it easy for the interrupting device (plug) to reach it.

About charging errors

When the status indicator flashes rapidly or slowly, one of the following situations may be to blame.

When the status indicator flashes at intervals of about 6 seconds (on for about 3 sec. and off for about 3 sec.):

- The battery may have excessively discharged. It can be recharged but in some cases it may take several hours until regular charging commences.

When the status indicator flashes at intervals of about 0.5 second (on for about 0.25 sec. and off for about 0.25 sec.):

- The battery has not been recharged. Remove the battery from the unit, and try charging it again.
- The battery temperature or ambient temperature may be extremely high or low. Wait until the appropriate temperature is restored before charging the battery again. If the battery still fails to charge, something may be wrong with the unit, battery, AC adaptor etc. Contact your dealer.

When the status indicator is off:

- Charging is completed.
- Although charging is completed, trouble may have occurred in the AC adaptor or battery when the status indicator is off. Contact your dealer.

About the SD card

- The memory capacity indicated on the label of an SD Card is the total of the capacity for copyright protection and management and the capacity which can be used on the unit, a PC etc.
- During prolonged use, the unit's surfaces and the SD card will heat up slightly: This is normal.



When inserting or removing the SD card, always set the [ON/OFF] switch to [OFF].

When the access lamp is illuminated (During access to the SD card), do not open the card slot cover to pull out the SD card, turn off the power, or cause any vibrations or impacts.

Do not leave the SD card in places where there is high temperature or direct sunlight, or where electromagnetic waves or static electricity are easily generated. Moreover, do not fold or drop the SD card, and do not strongly vibrate it.

- The SD card may break or the contents of the card may be destroyed or erased.

After use, be sure to eject the SD card, and store it away.

- After use, or when storing or carrying the SD card, put it in the storage case (supplied).
- Do not allow dust, water, or foreign substances to adhere to the terminals on the back of the SD card. Moreover, do not touch the terminals with your hand.
- Keep the SD Memory Card out of reach of children to prevent swallowing.

LCD monitor

- When the LCD monitor gets dirty, wipe it with a dry soft cloth.
- In a place with drastic temperature changes, condensation may form on the LCD monitor. Wipe it with soft dry cloth.
- When the unit has become very cold, for example due to storage in a cold area, its LCD monitor will be slightly darker than usual immediately after the power is turned on. The normal brightness will be restored when the unit's internal temperature rises.

Extremely high precision technology is employed to produce the LCD Monitor screen featuring a total of approximately 210,000 pixels. The result is more than 99.99% effective pixels with a mere 0.01% of the pixels inactive or always lit. However, this is not a malfunction and does not affect the recorded picture.

Specifications

SD Video Camera: Information for your safety

Power source:	DC 9.3 V (AC adaptor)/7.4 V (Battery)
Power consumption:	When recording: 3.9 W (AC adaptor)/3.5 W (Battery)

Signal system	EIA Standard: 525 lines, 60 fields NTSC color signal
Image sensor	1/6-inch 3CCD image sensor Total pixels approx. 800 K×3 Effective pixels Motion picture: approx. 640 K×3 (4:3)/ approx. 540 K×3 (16:9) Still picture: approx. 710 K×3 (4:3)/ approx. 540 K×3 (16:9)
Lens	Auto iris, 10× power zoom F1.8 to F2.8 (f = 3.0 mm to 30.0 mm) 35 mm equivalent Motion picture: 45.6 mm to 456 mm (4:3)/ 46.7 mm to 467 mm (16:9) Still picture: 43.4 mm to 434 mm (4:3)/ 47.0 mm to 470 mm (16:9) Tele-macro function provided (full range AF)
Filter diameter	37 mm
Zoom	10× optical zoom, 25/700× digital zoom
Monitor	2.8" wide LCD monitor (approx. 210 K pixels)
Microphone	Stereo (with a zoom function)
Speaker	1 dynamic type
White balance adjustment	Auto tracking white balance system
Standard illumination	1,400 lx
Minimum required illumination	12 lx (1 lx in MagicPix mode)
Recording media	SD Memory Card (8 MB/16 MB/32 MB/64 MB/128 MB/ 256 MB/512 MB/1 GB/2 GB (Maximum)) (FAT12 and FAT16 format corresponding)
Video output level	1.0 Vp-p 75 Ω
S-Video output level	Y Output: 1.0 Vp-p, 75 Ω C Output: 0.286 Vp-p, 75 Ω
Audio output level (Line)	316 mV, 600 Ω
Headphones output level	77 mV, with 32 Ω load

USB	Card reader/writer function (No copyright protection support) USB 2.0 compliant (Hi-Speed) PictBridge-compliant Web Camera function
Flash	GN 4.5 Available flash range: approx. 1 m to 2 m (3.3 feet to 6.6 feet)
Dimensions	Approx. 49.9 mm (W) × 96.7 mm (H) × 80.4 mm (D) Approx. 1 31/32 inch (W) × 3 13/16 inch (H) × 3 3/16 inch (D) (excluding the projecting parts)
Mass	Approx. 242 g (8.54 oz)
Mass in operation	Approx. 282 g (9.95 oz) (with supplied battery and SD Memory Card)
Operating temperature	0 °C to 40 °C (32 °F to 104 °F)
Operating humidity	10% to 80%
Battery operation time	See page 17.

Motion pictures

Compression	MPEG2 (SD-Video standard compliant)
Picture size	704×480
Transfer rate	XP : Approx. 10 Mbps (VBR), 30 fps SP : Approx. 5 Mbps (VBR), 30 fps LP : Approx. 2.5 Mbps (VBR), 30 fps
Audio compression	MPEG1-Layer2 compliant (stereo)

Still pictures

Compression	JPEG (Design rule for Camera File system, based on Exif 2.2 standard), DPOF corresponding
Picture size	2048×1512, 1280×960, 640×480, 1920×1080 (HDTV)

WEB camera

Compression	Motion JPEG-compliant
Picture size	320×240 pixels (QVGA)
Frame rate	Approx. 6 fps

AC adaptor: Information for your safety

Power source:	AC 100 V to 240 V, 50/60 Hz
Input capacitance:	0.25 A
Output:	DC 9.3 V 1.0 A

Battery pack: Information for your safety

Maximum voltage:	DC 8.4 V
Nominal voltage:	DC 7.4 V
Rated capacitance:	760 mAh

Limited Warranty (For USA Only)

Panasonic Consumer Electronics Company, Division of Panasonic Corporation of North America
One Panasonic Way, Secaucus, New Jersey 07094

Panasonic Puerto Rico, Inc.
Ave. 65 de Infantería, Km. 9.5, San Gabriel Industrial Park, Carolina, Puerto Rico 00985

PANASONIC SD Products Limited Warranty

Limited Warranty Coverage

If your product does not work properly because of a defect in materials or workmanship, Panasonic Consumer Electronics Company or Panasonic Puerto Rico, Inc. (collectively referred to as “the warrantor”) will, for the length of the period indicated on the chart below, which starts with the date of original purchase (“warranty period”), at its option either (a) repair your product with new or refurbished parts, or (b) replace it with a new or a refurbished product. The decision to repair or replace will be made by the warrantor.

Product or Part Name	Parts	Labor
SD Multi AV Device, SD Mobile Printer (except items listed below)	One (1) year	Ninety (90) days
CCD Image Sensor	Six (6) months	Ninety (90) days
Rechargeable Battery Pack, SD Memory Card, AC Adaptor, USB Reader-Writer (in exchange for defective item)	Ninety (90) days	Not Applicable

During the “Labor” warranty period there will be no charge for labor. During the “Parts” warranty period, there will be no charge for parts. You must carry-in or mail-in your product during the warranty period. If non-rechargeable batteries are included, they are not warranted. This warranty only applies to products purchased and serviced in the United States or Puerto Rico. This warranty is extended only to the original purchaser of a new product which was not sold “as is”.

A purchase receipt or other proof of the original purchase date is required for warranty service.

Carry-In or Mail-In Service

For Carry-In or Mail-In Service in the United States call 1-800-272-7033.

For assistance in Puerto Rico call Panasonic Puerto Rico, Inc.

(787)-750-4300 or fax (787)-768-2910.

Limited Warranty Limits And Exclusions

This warranty ONLY COVERS failures due to defects in materials or workmanship, and DOES NOT COVER normal wear and tear or cosmetic damage. The warranty ALSO DOES NOT COVER damages which occurred in shipment, or failures which are caused by products not supplied by the warrantor, or failures which result from accidents, misuse, abuse, neglect, mishandling, misapplication, alteration, faulty installation, set-up adjustments, misadjustment of consumer controls, improper maintenance, power line surge, lightning damage, modification, or commercial use (such as in a hotel, office, restaurant, or other business), rental use of the product,

service by anyone other than a Factory Servicenter or other Authorized Servicer, or damage that is attributable to acts of God.

THERE ARE NO EXPRESS WARRANTIES EXCEPT AS LISTED UNDER “LIMITED WARRANTY COVERAGE”. THE WARRANTOR IS NOT LIABLE FOR INCIDENTAL OR CONSEQUENTIAL DAMAGES RESULTING FROM THE USE OF THIS PRODUCT, OR ARISING OUT OF ANY BREACH OF THIS WARRANTY. (As examples, this excludes damages for lost time, travel to and from the servicer, loss of media or images, data or other memory content. The items listed are not exclusive, but are for illustration only.) ALL EXPRESS AND IMPLIED WARRANTIES, INCLUDING THE WARRANTY OF MERCHANTABILITY, ARE LIMITED TO THE PERIOD OF THE LIMITED WARRANTY.

Some states do not allow the exclusion or limitation of incidental or consequential damages, or limitations on how long an implied warranty lasts, so the exclusions may not apply to you.

This warranty gives you specific legal rights and you may also have other rights which vary from state to state. If a problem with this product develops during or after the warranty period, you may contact your dealer or Servicenter. If the problem is not handled to your satisfaction, then write to the warrantor's Consumer Affairs Department at the addresses listed for the warrantor.

PARTS AND SERVICE WHICH ARE NOT COVERED BY THIS LIMITED WARRANTY ARE YOUR RESPONSIBILITY.

Customer Services Directory (For USA Only)

For Product Information, Operating Assistance, Literature Request, Dealer Locations, and all Customer Service inquiries please contact:

1-800-272-7033, Monday-Friday 8:30am-8pm EST.

Web Site: <http://www.panasonic.com/consumersupport>

You can purchase parts, accessories or locate your nearest servicer by visiting our Web Site.

Accessory Purchases:

Purchase Parts, Accessories and Instruction Books online for all Panasonic Products by visiting our Web Site at:

<http://www.pasc.panasonic.com>

or, send your request by E-mail to:
npcparts@us.panasonic.com

You may also contact us directly at:

1-800-332-5368 (Customer Orders Only)

Panasonic Services Company 20421 84th Avenue South, Kent, WA 98032

(6 am to 5 pm Monday - Friday; 6 am to 10:30 am Saturday; PST)

(Visa, MasterCard, Discover Card, American Express, Check)

Product Repairs

Centralized Factory Servicer

MAIL TO :

Panasonic Services Company

410B Airport Road

Elgin, IL 60123

Attention: Digital Camcorder Repair Dept.

Please carefully pack and ship, prepaid and insured, to the Elgin Centralized Factory Servicer.

Customer's in Puerto Rico, please ship or carry in to location below ("Service in Puerto Rico").

Service in Puerto Rico

Panasonic Puerto Rico, Inc.:

Ave. 65 de Infantería, Km. 9.5, San Gabriel Industrial Park, Carolina, Puerto Rico 00985

Phone (787) 750-4300 Fax (787) 768-2910

As of November 2004

Please photocopy this form when making a request for service notice, in the unlikely event this product needs service.

Request for Service Notice:

- Please include your **proof of purchase.**
(Failure to do so will delay your repair.)
 - To further speed your repair, please provide an explanation of what is wrong with the unit and any symptom it is exhibiting.
-
-
-
-

Mail this completed form and your Proof of Purchase along with your unit to:
Panasonic Services Company
410B Airport Road
Elgin, IL 60123
Attn: Digital Camcorder Repair Dept.

Please write the displayed above Self Diagnostic number here.

Warranty (For Canadian Customers)

FOR CANADA

Panasonic Canada Inc.

PANASONIC PRODUCT – LIMITED WARRANTY

Panasonic Canada Inc. warrants this product to be free from defects in material and workmanship and agrees to remedy any such defect for a period as stated below from the date of original purchase.

SD Video Camera	One (1) year, parts and labour
Digital Photo Peripherals	One (1) year, parts and labour
SD Video Camera Accessories	Ninety (90) days, parts and labour

In-home Service will be carried out only to locations accessible by roads and within 50 km of an authorized Panasonic service facility.

LIMITATIONS AND EXCLUSIONS

This warranty does not apply to products purchased outside Canada or to any product which has been improperly installed, subjected to usage for which the product was not designed, misused or abused, damaged during shipping, or which has been altered or repaired in any way that affects the reliability or detracts from the performance, nor does it cover any product which is used commercially. Dry cell batteries are also excluded from coverage under this warranty.

This warranty is extended to the original end user purchaser only. A purchase receipt or other proof of date of original purchase is required before warranty service is performed.

THIS EXPRESS, LIMITED WARRANTY IS IN LIEU OF ALL OTHER WARRANTIES, EXPRESS OR IMPLIED, INCLUDING ANY IMPLIED WARRANTIES OF MERCHANTABILITY AND FITNESS FOR A PARTICULAR PURPOSE.

IN NO EVENT WILL PANASONIC CANADA INC. BE LIABLE FOR ANY SPECIAL, INDIRECT OR CONSEQUENTIAL DAMAGES.

In certain instances, some jurisdictions do not allow the exclusion or limitation of incidental or consequential damages, or the exclusion of implied warranties, so the above limitations and exclusions may not be applicable.

WARRANTY SERVICE

FOR PRODUCT OPERATION ASSISTANCE, please contact:

Our Customer Care Centre:

Telephone #: (905) 624-5505 1-800 #: 1-800-561-5505

Fax #: (905) 238-2360

Email link: "Contact Us" on www.panasonic.ca

FOR PRODUCT REPAIRS, please locate your nearest Authorized Servicentre at www.panasonic.ca :

Link : "Servicentres™ locator" under "Customer support"

Panasonic Factory Service:

Richmond, British Columbia

Panasonic Canada Inc.
12111 Riverside Way
Richmond, BC V6W 1K8
Tel: (604) 278-4211
Fax: (604) 278-5627

Mississauga, Ontario

Panasonic Canada Inc.
5770 Ambler Drive
Mississauga, ON L4W 2T3
Tel: (905) 624-8447
Fax: (905) 238-2418

IF YOU SHIP THE PRODUCT TO A SERVICENTRE

Carefully pack and send prepaid, adequately insured and preferably in the original carton. Include details of the defect claimed, and proof of date of original purchase.

Index

- A**
AC adaptor 17, 106
Adobe Acrobat Reader 73
Aperture/Gain 48
Auto focus 104
Auto mode 32
Automatic white balance 103
- B**
Backlight Compensation 39
Battery 16, 17, 106
Beep sound 91
Black Balance 47
Built-in flash 54
- C**
Card 8, 14, 15, 107
Charging time 17
Cursor button 22
- D**
Date and time display style 29
Deleting scenes 62
Demo mode 91
Digital zoom 36
DirectX 73
Display 91
Display style 28
DPOF setting 66
- F**
Face-to-face recording 21
Focus 45
Focus area 53
Formatting an SD card 65
Frame-by-frame playback 58
- H**
Headphone cable 12
- I**
Image stabilizer function 41
Indication lamp 32
Initial setting 91
- J**
JPEG 50, 60
- L**
LCD 30
LCD AI 30
LCD monitor 21, 29, 30, 107
LCD monitor adjustment 29, 30
Locking scenes 64
- M**
MagicPix functions 42
Manual adjustment mode
(White balance) 47
Manual Focus 45
MEGA OIS 50
Menu 26
Menu list 89
- Motion picture playback 57
Motion picture recording 33
MPEG2 33, 57, 104
- N**
Number of recordable pictures 88
- O**
One-touch navigation 22
Operation icons 24
- P**
PictBridge 67
Picture quality 52
Picture size 52
PLAY MODE 59, 61
Playing back motion pictures by date 59
Power save 91
- Q**
Quick start 18
- R**
Record button 33
Recording mode of the motion pictures 34
Recording time elapsed 33
Red eye reduction function 54
Remaining number of still pictures 51
Remaining time left for recording 33
Remote control 12
Repeat Playback 59
Resuming the previous playback 59
- S**
Scene mode 43
Self-timer recording 56
Setting date and time 28
Shutter chance mark 50, 53
Shutter effect 52
Shutter speed 48
Skip playback 57
Slide show 61
Soft Skin Mode 38
Still picture playback 60
Still picture recording 50
Still pictures 61
- T**
Tele-Macro function 37
TV aspect ratio 71
- V**
Volume adjustment 58
- W**
White balance 46, 103
Wide mode 40
Wind noise reduction function 40
- Z**
Zoom 36
Zoom microphone 37

Spanish Quick Use Guide/Guía rápida para el usuario en español

■ Cómo insertar/quitar una tarjeta SD

Antes de insertar/quitar una tarjeta SD, asegúrese haber apagado la unidad [OFF].

Si se inserta o se quita la tarjeta SD con la unidad encendida, esta unidad podría no funcionar bien o los datos grabados en la tarjeta SD podrían perderse.

1

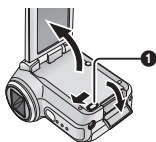

Abra el monitor LCD y luego deslice la palanca de apertura de la ranura de la tarjeta **1** para abrir la tapa de la ranura de la tarjeta.

2

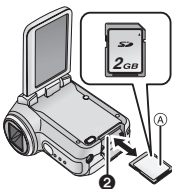

Inserte/quite la tarjeta SD en/de la ranura de la tarjeta **2**.

(A) Lado etiqueta

- Cuando inserta una tarjeta SD, el lado de la etiqueta tiene que estar hacia usted y tiene que introducirla completamente de un golpe.
- Cuando quita una tarjeta SD, abra la tapa de la ranura de la tarjeta y pulse el center de la tarjeta SD y luego tire de ella hacia fuera.

3

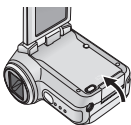

Cierre firmemente la tapa de la ranura de la tarjeta.

■ Cómo insertar/quitar la batería

1

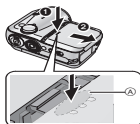

Quite la tapa de la batería.

- 1** Mientras aprieta la tapa de la batería,
- 2** deslícela en la dirección de la flecha.

2

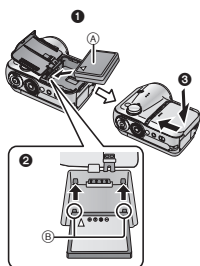

Inserte la batería.

- 1** Coloque la etiqueta de la batería con la cara hacia arriba.
 - 2** Inserte las partes salientes de la batería en los orificios en la unidad.
 - 3** Vuelva a poner la tapa de la batería en su lugar.
- (A) Etiqueta
(B) Partes salientes

Cómo quitar la batería

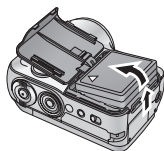

Quite la tapa de la batería, luego extraiga la batería.

- Después de quitar la batería, vuelva a poner la tapa de la batería en su lugar.

■ Recarga de la batería

◇ Ponga el interruptor de encendido en [OFF].

1

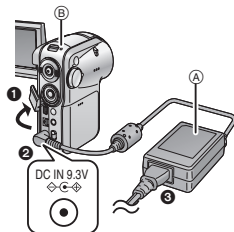

Conecte el adaptador CA (A) (suministrado) a esta unidad y a la toma CA.

- 1 Abra la tapa del terminal de esta unidad.
- 2 Conecte el adaptador CA al terminal de entrada DC de esta unidad [DC IN 9.3V].
- 3 Conecte el cable principal CA al adaptador CA, luego a la toma CA.

El indicador de estado (B) empieza a parpadear de color rojo a intervalos de unos 2 segundos para señalar que la carga ha empezado. La carga está completa cuando la luz indicadora se apaga.

■ Encendido/apagado de la unidad

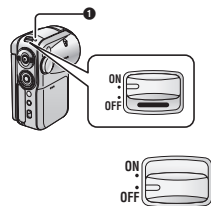

Cómo encender la unidad

Ponga el interruptor de encendido en [ON].

El indicador de estado (1) se ilumina de color rojo, en el modo de grabación de imágenes dinámicas o en el modo de grabación de imágenes fijas, la tapa del objetivo se abre.

Cómo apagar la unidad

Ponga el interruptor de encendido en [OFF].

El indicador de estado se apaga y la tapa del objetivo se cierra.

- Si el monitor LCD se cierra en el modo de grabación de imágenes dinámicas o en el modo de grabación de imágenes fijas, se apaga.

■ Selección del modo

El selector de modo se utiliza para pasar del modo grabación al modo reproducción.

Gire el selector de modo lentamente pero seguramente.

Ponga el modo deseado (1).

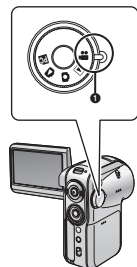

Gire el selector del modo y ponga la pictografía del modo deseado en la posición mostrada en la ilustración.

■ Grabación de imágenes dinámicas

1



Gire el selector de modo para seleccionar



Ahora la tapa del objetivo se abre automáticamente.

2

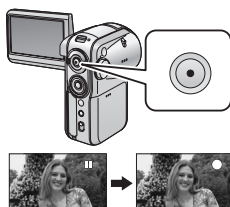

Pulse el botón de grabación para empezar la grabación.

Fin de la grabación

Pulse de nuevo el botón de grabación.

- [●] y [■] son de color rojo durante la grabación. No mueva esta unidad hasta que [■] sea de color verde.

■ Grabación de imágenes fijas

1



Gire el selector de modo para seleccionar



La tapa del objetivo se abre automáticamente.

2

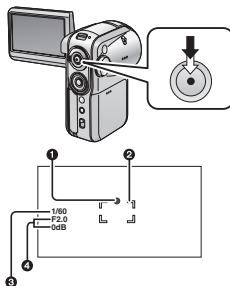

Pulse el botón de grabación a medias (no completamente) para enfocar al sujeto. (Solo en el modo de enfoque automático)

- El valor de iris/ganancia queda fijado y esta unidad enfoca al sujeto automáticamente.

- 1 Señal de obturador posible
- 2 Área de enfoque
- 3 Velocidad del obturador
- 4 Iris/ganancia

La velocidad del obturador y el valor de iris/ganancia son fijos y la unidad enfoca al sujeto automáticamente.

- Cuando se pulsa a medias el botón de grabación, la señal de obturador posible se indica de la siguiente manera.
 - ○ (La luz indicadora blanca parpadea.): Enfocando
 - ● (La luz indicadora verde se enciende.): Enfoque efectuado
 - Ninguna señal:
 - Si el enfoque no ha tenido éxito

3

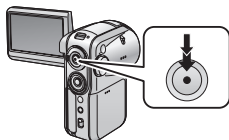

Pulse completamente el botón de grabación (hasta el máximo) para grabar.

■ Reproducción de imágenes dinámicas

1



Gire el selector de modo para seleccionar .
La tapa del objetivo se cierra automáticamente.

2



Pulse los botones de las flechas hacia arriba, hacia abajo, hacia la izquierda o hacia la derecha para llevar a cabo las distintas operaciones.

Reproducción/Pausa: Pulse .

Reproducción de revisión: Siga pulsando .

Reproducción a partir de un punto marcado: Siga pulsando .

Para detener la reproducción y mostrar las miniaturas: Pulse .

■ Reproducción de imágenes fijas

1



Gire el selector de modo para seleccionar .

La tapa del objetivo se cierra automáticamente.

2



Pulse los botones de las flechas hacia arriba, hacia abajo, hacia la izquierda o hacia la derecha para llevar a cabo las distintas operaciones.

: La exposición de diapositivas (reproducción de las imágenes en la tarjeta SD en orden numérico) inicia/se interrumpe.*

: Reproduce la imagen anterior.

: Reproduce la imagen siguiente.

: Detiene la reproducción y muestra las miniaturas.

* Solo si se ha seleccionado SLIDE SHOW.

Panasonic Consumer Electronics Company,
Division of Panasonic Corporation of North America
One Panasonic Way, Secaucus, NJ 07094

Panasonic Puerto Rico, Inc.
Ave. 65 de Infantería, Km. 9.5, San Gabriel Industrial Park,
Carolina, Puerto Rico 00985

Panasonic Canada Inc.
5770 Ambler Drive, Mississauga, Ontario, L4W 2T3

© 2005 Matsushita Electric Industrial Co., Ltd.



VQT0T50
F0805Mk0 (500 Ⓐ)

