

Panasonic

BUSINESS

AV-HS6000

2ME Live Switcher



**2ME Live Switcher with complete system adaptability,
intuitive operations, high reliability, and advanced 4K
compatibility***



* Firmware Ver. 4 or later required.



Excellent Live Operability Meets Creativity

Excellent Value System Capability

32 SDI and two DVI inputs, 16 SDI outputs*

Despite its compact 3RU body, this mainframe provides wide variety of inputs/outputs with frame synchronizer, format converter, and color correctors.

Colors can be adjusted to correspond to different video source formats, camera properties, and displays, enabling trouble-free production.

[Input]

- 34 inputs in total, with 32 SDI and two DVI inputs.
- All SDI inputs are provided with a 10 bit frame synchronizer.
- Eight inputs equipped with color correctors.
- Four inputs equipped with up-converters. Signals can be delayed by up to eight frames.

[Output]

- 16 SDI outputs with two outputs per channel.
- Four outputs equipped with color correctors.
- Two outputs equipped with downconverters.

*Some functions differ when 3G/4K mode is selected. See page 5 for details.

Control Panel Rear Terminal



Supported Formats

	Input			Output SDIx16
	SDIx32	DVI-Dx2		
SDI	480/59.94i, 576/50i	●	—	●
	1080/59.94i, 50i	●	—	●
	720/59.94p, 50p	●	—	●
	1080/24PsF	●	—	●
	1080/23.98PsF	●	—	●
	1080/25PsF, 29.97PsF	●	—	●
	1080/59.94p, 50p (3G mode)	*	—	*
	2160/59.94p, 50p (4K mode)	*	—	*
DVI-D	XGA 60Hz	—	●	—
	WXGA 60Hz	—	●	—
	SXGA 60Hz	—	●	—
	WSXGA+ 60Hz	—	●	—
	UXGA 60Hz	—	●	—
	WUXGA 60Hz	—	●	—
	1080/59.94p, 50p	—	●	—
	1080/59.94i, 50i	—	●	—
720/59.94p, 50p	—	●	—	

Mainframe Rear Terminal



System Functionality*1

32 SDI and two DVI inputs and 16 SDI outputs, with a wide variety of keyers and DVEs. Versatile transition modes and extensive video production features are achieved with high cost effectiveness. Functions are scalable using plug-in software.

Operability

Intuitive operation is realized by Multi-Selection Panel, cross point buttons with color grouping function, and a OLED source name display panel. These function to enhance visibility helps quick and accurate switching.

Reliability

The power supply for the mainframe and control panel is redundant. Up to three panels can be operated through an IP connection to provide stable system operation.

*1: Some functions differ when 3G/4K mode is selected. See page 5 for details.



2ME Live Switcher
AV-HS6000



Two types of Control Panels

Control Panel AV-HS60C2



Control Panel AV-HS60C4



Model no.	ME Number	XPT	Power Supply	Width
AV-HS60C2	2 ME	24 XPT	Redundant Power Supply	980 mm (38-19/32 inches)
AV-HS60C4	2 ME	16 XPT	Redundant Power Supply	656 mm (25-13/16 inches)

Effects to Enhance Your Creativity

Diverse DVE Transitions*1

In addition to wipe, mix, and cut transitions, DVE transitions with 3D DVE 2ch, such as size reduction and sliding, can be performed. Diverse rendering of image effects such as mosaic or defocus are possible.

- 4ch of 3D DVE and 2ch of 2D DVE systems are provided to support background and keys for each ME. *1: Some functions differ when 3G/4K mode is selected. See page 5 for details.

Various Keyers*2

Featuring variety of keyers, HS6000 supports creative live content creation. A luminance key, linear key, chroma key, full key, and PinP are provided for 4ch per ME (8ch in total), plus 4ch of DSK, for a total 12keyers, with 4ch of upstream key (USK).

- **Chroma key:** By implementing the Primatte®³ algorithm, real time and high quality key composition are possible.
- **PinP:** 4ch per ME (8ch total). Through the flying key effect, move, expand and shrink the input key signals using DVE effects.
- **Key preset:** Key Preset function allows easy store and recall of the settings for key. Four settings for each channel of key and four settings for each channel of DSK can be registered.
- **Upstream key:** 4ch of USK are convenient for usage such as adding the CG sources to fill the gap of 4:3 image to 16:9 image.
- **Downstream key:** 4ch are available. Can be assigned to PGM1/PGM2.

*2: Some functions differ when 3G/4K mode is selected. See page 5 for details.

Key Types

	USK	KEY	DSK
Luminance key	✓	✓	✓
Linear key	✓	✓	✓
Chroma key		✓	
Full key		✓	
Picture in Picture		✓	

Available Functions

	<KEY1>	<KEY2>	<KEY3>	<KEY4>	DSK1-4
Transition	CUT/MIX/WIPE	CUT/MIX/WIPE	CUT/MIX/WIPE	CUT/MIX/WIPE	CUT/MIX
Chroma key	Standard	optional	optional	optional	N/A
PinP ⁴	3D effect	3D effect	2D effect	2D effect	N/A

Key Formation

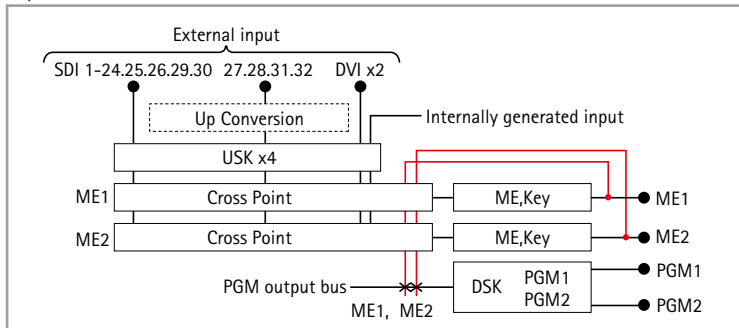

*3: Primatte® is a registered trademark of IMAGICA DIGIX Inc. The copyright of Primatte® belong to IMAGICA DIGIX Inc. The patents for Primatte® belong to IMAGICA DIGIX Inc.

*4: Includes the flying key effect.

Transitions and Effects Display Example

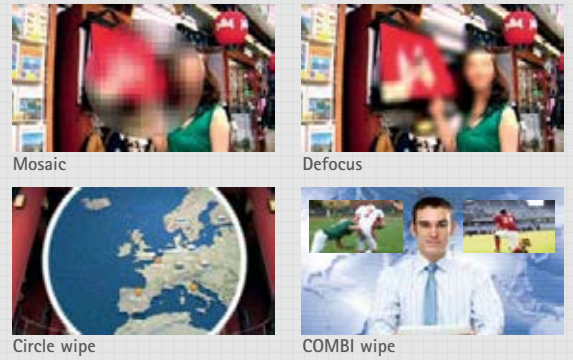

Sample of four keyers in use



Primatte® High-Quality Chroma Key (picture simulated)

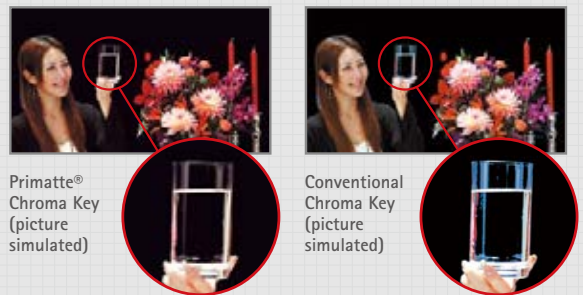

Display Example of Using Upstream Key

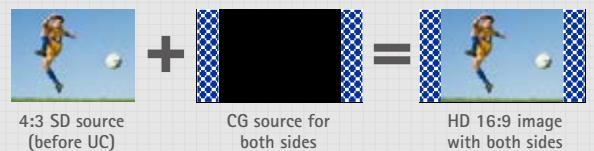

Display Example of using Downstream Key (Example of multi-language broadcasting)

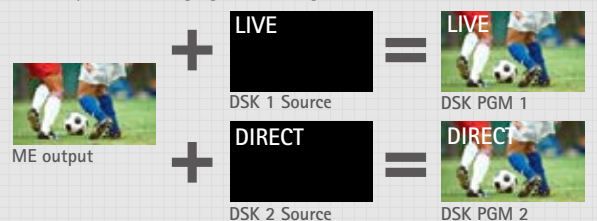

Memory Functions*1

Using memory function, setting, video and effects can be easily stored and recalled. It allows quick operation of switching and recalling effects in live video production, supports efficient operation and making it easy to perform video effects for more complicated operations.

- **Shot memory:** This function recalls background transition patterns or other video effects, including PinP size, position, border width, and key on (maximum of 81 memories). Effect dissolve can be set to ensure smooth switching from the current effect to the next effect registered in shot memory.
- **Event memory:** This function allows continuous image effects to be registered and played back in a timeline.
- **Macro memory:** This function allows record and playback of a series of operations on the Control Panel. It can also record and playback setting information, such as input/output and keyers. Macro memories can be played back by assigning them to the cross point buttons, such as macro bus, PGM, and PST.
- **Video memory:** Moving image (Clip) and still image (Still) can be recorded in 4ch each (maximum of 81 memories*2) for use as video sources. Maximum 60 seconds of moving images can be saved in standard mode, and Maximum 30 seconds in high image quality mode. Moving image (Clip) allows audio recording and playback.

*1: Some functions differ when 3G/4K mode is selected. See page 5 for details.

*2: Storage module is required separately.

Intuitive Switching

- **Multi-Selection Panel:** A color panel that can display thumbnail images with high visibility. The switches provide a tactile response which allows quick and precise memory operation.
- **Animation wipe:** With moving images (clip) and still images (still) recorded in video memory, animation wipes can be created easily.

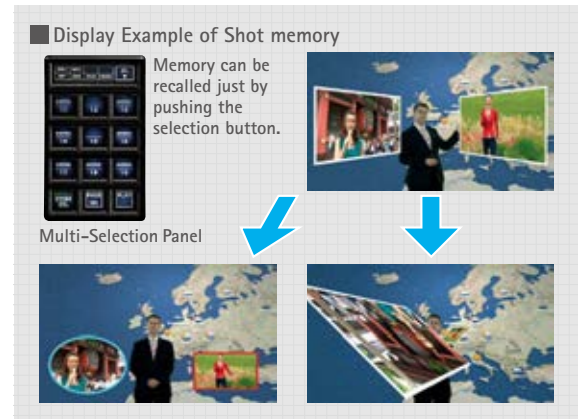

Animation Wipe Examples



Split Screen Outputs to Fit the Setup

Built-in 4ch MultiViewer Function*3

An independent 4ch MultiViewer output function is provided as standard, enabling displays of up to 16 split screens (a total of nine patterns). All of these functions are available without the need for a specialized device.

- MultiViewer can be selected from a total of nine patterns, including four split, five split (two patterns), six split (two patterns), nine split, 10 split (two patterns), and 16 split.
- Source names, tallies, audio level meters, clock and safety markers can be displayed.
- Select between fit mode, in which the video image is the same size as the split frame, and squeeze mode, which places the source name and level meter outside the image.

*3: Some functions differ when 3G/4K mode is selected. See page 5 for details.

Fit mode display example



Squeeze mode display example



MultiViewer examples

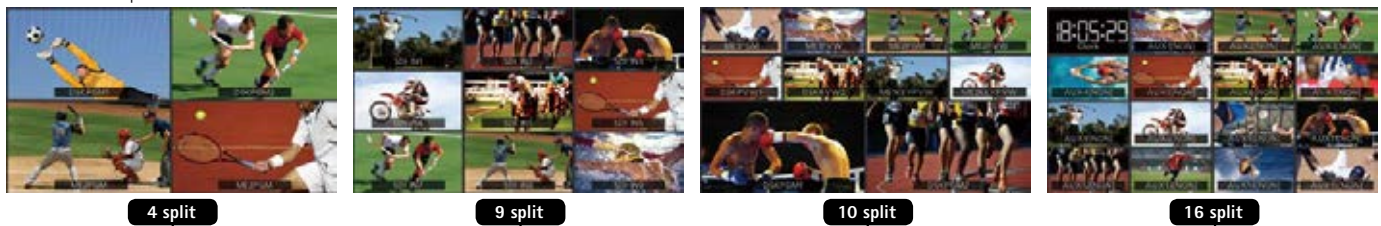

Five additional patterns can be selected.

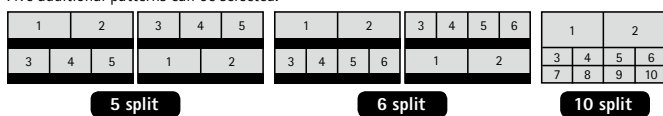

Four-system MV (split screens)



Flexible Scalability and Secure Operability

System Scalability*1

*1: Some functions differ when 3G/4K mode is selected. See "3G/4K format compatibility" for details.

- 16 AUX buses are provided. MIX transition is available from the AUX1 to AUX4 buses.
- Menu operations can be performed from a PC or tablet via a network connection.
- Various interfaces and plug-in software installation capability to expand the connectivity with other devices. Seven plug-in software is provided and customized plug-in software can be created using SDK.

Plug-in software

* For information on downloading plug-in software, see "Software download" on the Panasonic website (<http://pro-av.panasonic.net/en/>).

EXT_Control

This software allows sending and receiving information on source switching or source name for AV-HS6000 buses between external devices such as system controllers or tally interfaces connected via network. Control can be done via router control systems from Evertz and Utah Scientific.²

Evertz	Utah Scientific
MAGNUM Router Control System	SC-4 System Controller

*2: Please inquire with the individual manufacturer regarding router system settings.

P2_Control

This software allows connection and control of Panasonic P2 devices via RS-422 serial communications.

GVG200

This software allows control such as crosspoint switching or transition on GVG200 protocol compliant external controllers, editors, etc. by RS-422 serial communications. (External controllers and control software are sold separately.)

AUX_IP

This software allows crosspoint switching from a remote operation panel (VS-R45) via an IP network. (VS-R45 is a product of Venetex Corp.)

Serial TALLY

This software provides tally output and source names to an external tally display or interface by RS-422 serial communications with UMD protocol Ver. 3.1 compliant devices.

EXT_PANEL_IP

This software allows crosspoint switching, executing transitions, and controlling macro playback from a remote operation panel via an IP network. Control can be done from LAWO LBP series remote operation panel³

*3: Please inquire with LAWO regarding remote operation panel settings.

CAM_Control

This software enables the preset memory recall and PAN/TILT/ZOOM/FOCUS/IRIS control of the AW-HE/UE series integrated camera. Up to 10 cameras can be controlled.

Backup System for Peace of Mind

- A redundant power supply is provided for the mainframe and control panel.
- Operation of up to three control panels is possible through an IP connection.
- ME rows can be switched by swapping the ME panel and changing the output of the system when ME faults.
- A web browser is provided to allow access to the GUI menu from a remote PC.
- System settings and memory information can be stored on SD cards, PC's, and other optional storage devices.

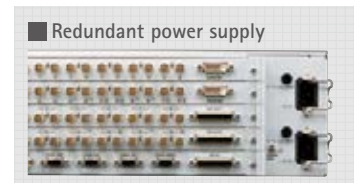

3G/4K format compatibility (Advanced support for high-definition)

This advanced switcher can be used to produce 4K*4 high-definition video as well as HD/SD-SDI and 3G-SDI by switching between three use modes.

*4: Firmware Ver. 4 or later required. For details, see "Service and Support" on the Panasonic website (<http://pro-av.panasonic.net/en/>).

Functions supported by format

		Standard mode	3G mode	4K mode
Input function	Number of SDI inputs	32	16(3G Level A/B ⁵)	8(SQD/2SI 3G Level A/B ⁵ × 4)
	Number of DVI inputs	2	Not possible	Not possible
	Number of up-converter channel	4	-	8
	Dot by Dot	Possible	-	-
	Number of delay function channel	4	2	-
	Number of color corrector channel	8	4	-
Output function	Number of SDI output	16	8	3(SQD 3G Level B × 4)
	Number of down-converter channel	2	2 ⁶	2 ⁷
	Number of color corrector channel	4	2	-
ME1 function	Number of utility bus	2	1	1
	BKGD transition pattern	MIX / WIPE / DVE	MIX / WIPE	MIX / WIPE
ME2 function	IMAGE	Possible	Not possible	Not possible
	Number of keyer	4	Not possible	Not possible
	Number of utility bus	2	Not possible	Not possible
Number of DSK keyer		4	2	2 ⁸
Number of still image (Still) memory channel		4	2	2 ⁸
Moving image (Clip) memory function	Number of channel	4	2	2 ⁸
	Recording time per channel (standard image quality)	Approximately 60 seconds	Approximately 30 seconds	Approximately 30 seconds
Number of MultiViewer	Recording time per channel (high image quality)	Approximately 30 seconds	Approximately 15 seconds	Approximately 15 seconds
	Number of AUX	16	8	8 ⁸

*5: When FS function is active and 3G-SDI Level A signal is input, it is converted to Level B signal to perform signal processing. When FS function is off and 3G-SDI Level A signal is input, a black screen will be displayed. FS function is always ON when in 4K mode. *6: SDI OUT 14 outputs down-converted HD-SDI signal of SDI OUT 13, and SDI OUT 16 outputs down-converted HD-SDI signal of SDI OUT 15. *7: Same video output on SDI OUT 13(3G-SDI) and SDI OUT 14 (HD-SDI). Same video output on SDI OUT 15(3G-SDI) and SDI OUT 16 (HD-SDI). *8: 2K resolution video scaled to 4K resolution.

Easy Direct Switching by Touch and Mouse Operations

Software Control Panel AV-SF6000G (Free download for Mac and Windows)

The AV-HS6000 control panel is also available as a PC based application software. Equipped with the MJPEG codec, it allows display of video and image in the application. Intuitive and simple operations while viewing source video or using the display as a sub-panel is possible.

* For information on downloading software control panel, see "Software download" on the Panasonic website (<http://pro-av.panasonic.net/en/>).

System Composition Example

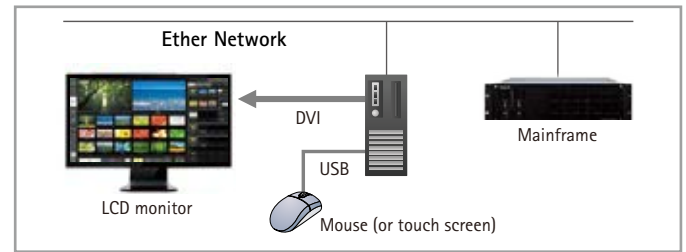

Mode selection part

- Switches between Control Mode, Menu Panel, and Video Status modes.
- Displays mainframe communications status and error status.
- Switches between connected mainframes by inputting the IP address.
- Allows free arrangement of sources displayed on the input and output windows.

Control Mode screen



Input and output windows

- Displays PGM and PST for the selected ME.
- Displays DSK PGM1 for PGM when PGM (+DSK) button is selected.
- Displays Next Transition setting status superimposed on window for PST.

Page button

- Switches display of operation panel part.

Operation panel part-1

- Operates transitions (fader, AUTO, CUT).
- Selects key type and transition type for KEY 1 to 4 and sets transition time.
- Sets key type for DSK 1 to 4.
- Displays thumbnail for source assigned to KEY and DSK.

Operation menu part

- Switches ME to be operated.
- Selects PST, PGM, UTIL 1 to 2, and KEY 1 to 4.

Source assignment part

- Selects movie to be assigned to the bus selected with operation menu part.
- A total of 54 sources can be displayed on three pages by displaying 18 sources on one page and switching pages.
- Displays tally status in red and green frames.

Operation panel part-2

- Controls shot memory, event memory, and macro memory.
- Video memory (still/clip) can be controlled.
- Stills and clips can be loaded from the built-in SSD or a PC.

Examples of Other Major Screens

Menu Panel screen



Displays menu panel operation display, showing ME1, ME2 and PGM on left side. It is possible to operate menu panel or to check the result while checking the PGM output.

Video Status screen



Video sources of all inputs, all outputs, ME/DSK/AUX buses, and MultiView screen are displayed in a list.

Macro Edit screen



Added editing function which are adding and deleting operations, wait time setting, etc., recorded Macro memory for more convenience.

Maintenance screen



This function searches for IP addresses of AV-HS6000 on the same network and easily connects to the software control panel.

Operability Enhanced with Ergonomically Designed Panels

The graphical user interface combines excellent visibility with ease of operation

Control Panel

AV-HS60C2 (redundant power supply model)



ME1 KEY bus selector buttons (KEY BUS DELEGATION)

- Switches bus column and functions operated by ME1 KEY bus
- 1. Select KEY 1 to 4 key source/key fill bus (key source/key fill link coupling function available)
- 2. Select AUX1 to 16 bus (AUX1 to 4 support the MIX transition function)
(AUX bus 1/2 to 15/16 have the crosspoint link coupling function)
- 3. Select Display <DISP> bus¹ (*1: This bus selects images to be displayed on Menu Panel (AV-HS60C3))
- 4. Select Utility bus² (*2: This bus selects sources to be inserted in border background or key edge)
- 5. Select MACRO bus³ (*3: This bus plays back the macro memory)



Crosspoint area

Multi-Selection Panel area

Crosspoint buttons

1. Eight colors can be used for grouping to matched sources
2. Switching is possible among 24 crosspoints x four pages
(96 total crosspoints)
3. Assign and play back the macro memory

Source name display panel

- Displays crosspoint numbers, source display names, and macro names. Bit map characters can be displayed for source names

KEY bus crosspoint buttons

- Select source for the bus switched with KEY bus select buttons
- Can playback macro memory

ME2 KEY bus selector buttons (KEY BUS DELEGATION)

- Switches bus column and functions operated by ME2 KEY bus
- 1. Select KEY 1 to 4 key source/key fill bus (key source/key fill link coupling function available)
- 2. Select DSK 1 to 4 key source/key fill bus (can be assigned to PGM1/PGM2)
- 3. Select Utility bus²
(*2: This bus selects sources to be inserted in the border background or key edge)
- 4. Select MACRO bus³
(*3: This bus plays back the macro memory)

Large and easy-to-use touch panel

Menu Panel

AV-HS60C3G

- 10.1-type(256.5 mm) Menu Panel with touch screen allows quick and easy menu operation
- Display mode can be selected for either full screen or split screen(WFM/VECT).
- On-screen software keyboard/numerical keypad available
- General-purpose DVI monitor can be used instead of Menu Panel

*When using software control panel AV-SF6000G, menu panel and DVI monitor do not display moving video, WFM, or VECT.

<Output screen to DVI monitor>



Menu Panel

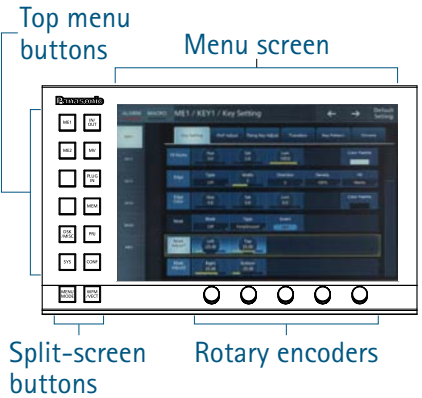

Positioner area



Memory Card Slot

- Settings and log data can be stored/ accessed on an SD memory card or SDHC memory card
- *SD memory card and SDHC card are sold separately

Positioner

- Provides cursor operation for positioning WIPE/PinP, size adjustment, chroma key

Transition

1. Background/key transition: operate fader, AUTO, or CUT transitions
2. Select transition type: select from WIPE, MIX, or NAM transitions
3. Switch on/off the macro memory attachment function (macro attach): enable/disable the macro memory play back trigger assigned to PGM bus, PST bus, or AUX bus buttons
4. Fader play back of the event memory (EMEM link): performs fader operation of the event memory
5. ME change: switches the Control Panel ME1/ME2 columns

Transition area

KEY / DSK operation area

Multi-Selection Panel

- Easy-to-use colored switches with tactile response
- Wipe patterns, Event memory, Shot memory, Video memory (CLIP/STILL) can be registered and recalled



Wipe Pattern Event memory Shot memory Video memory (CLIP) Video memory (STILL)

Key, DSK operation

1. KEY/DSK transition: operates KEY 1 to 4, DSK 1 to 4 AUTO, CUT transition of each ME
2. Key preset: For KEY 1 to 4 and DSK 1 to 4 of each ME, register and access key preset

AV-HS6000 Block Diagram (Standard mode)

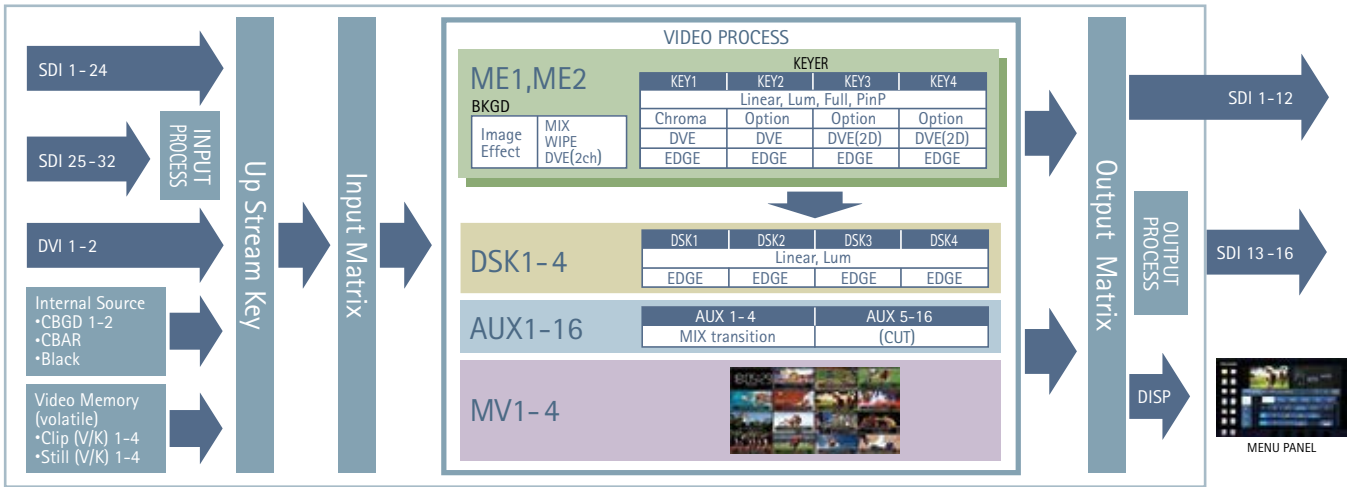

AV-HS6000 Block Diagram (3G mode)

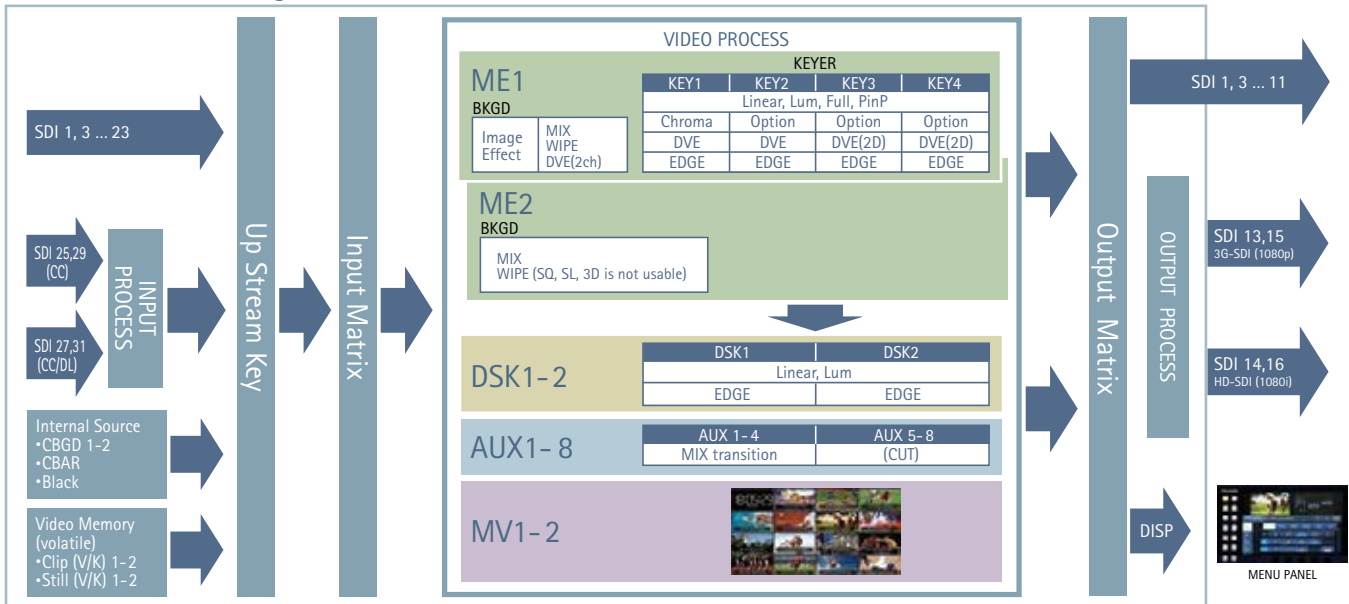



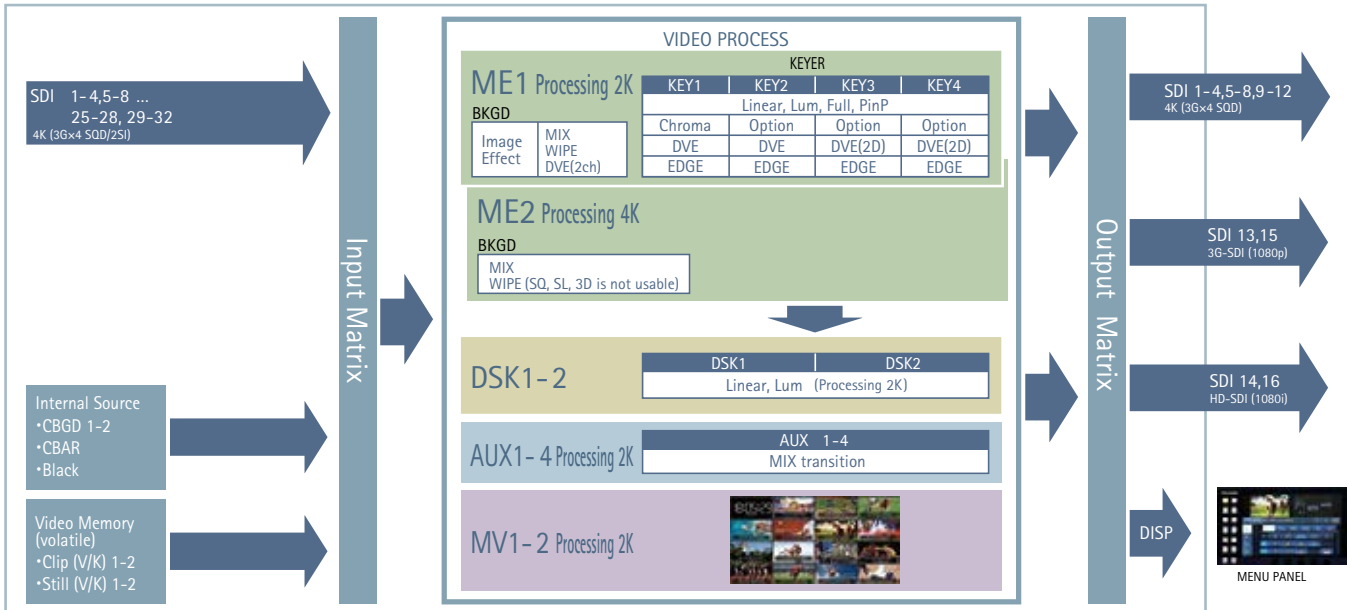

* Input and output is by odd-numbered terminals only. * 1080i format signals where half of the lines are thinned out from OUT13 and OUT15 (1080p) format signals are output from OUT14 and OUT16 terminals.

AV-HS6000 Block Diagram (4K mode)



* 1080i format signals where half of the lines are thinned out from OUT13 and OUT15 (1080p) format signals are output from OUT14 and OUT16 terminals.

AV-HS6000 Series Composition

			Model no.
Mainframe		Redundant Power Supply Model	AV-HS60U2P/AV-HS60U2E
Control Panel		Redundant Power Supply Model	AV-HS60C2P/AV-HS60C2E
		Redundant Power Supply Model	AV-HS60C4P/AV-HS60C4E
Menu Panel			AV-HS60C3G
Storage Module			AV-HS60D1G
Chroma Key Software			AV-SFU60G

Dimensions: mm (inch)

Control Panel AV-HS60C2P/AV-HS60C2E

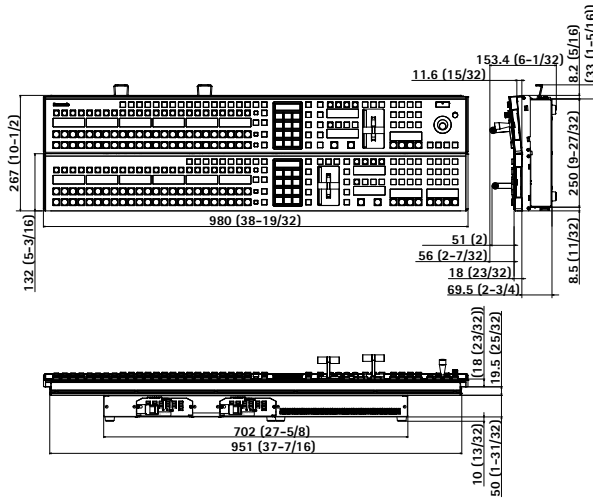

Control Panel AV-HS60C4P/AV-HS60C4E

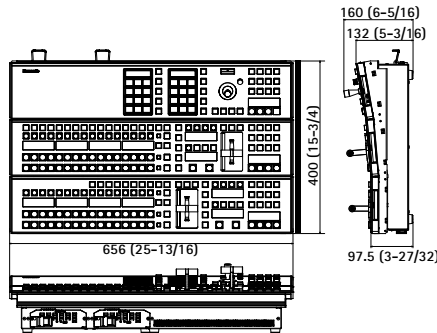

Menu Panel

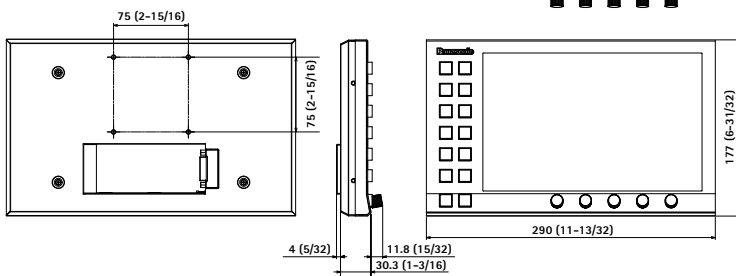

Mainframe

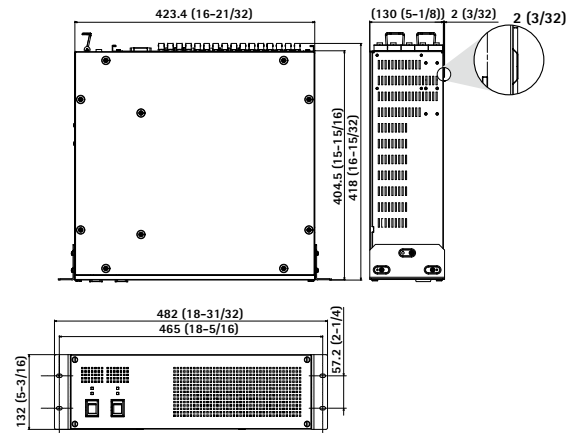

Mainframe AV-HS60U2P/E

Power Supply	AC100 V to 240 V, 50 Hz/60 Hz (AV-HS60U2 supports redundant power supply)
Power Consumption	110 W
Ambient Operating Temperature	0°C to 40°C (32°F to 104°F)
Operating Ambient Humidity	10% to 90% (no condensation)
Storage Temperature	0°C to 40°C (32°F to 104°F)
Storage Humidity	10% to 90% (no condensation)
Weight	Approx. 13.5 kg (29.7 lbs.)(excluding accessories)
Dimensions (WxHxD)	482 mmx132 mmx418 mm (18-31/32 inchesx5-3/16 inchesx16-15/32 inches)(excluding protrusions)

Video Terminal

SDI IN 1 to SDI IN 32 Terminals	During Standard mode 32 lines <ul style="list-style-type: none"> Connectors: BNCx32 SDI IN 27, SDI IN 28, SDI IN 31, SDI IN 32 terminals are equipped with up-converters. SDI IN 25 to SDI IN 32 terminals are equipped with color correctors. 	
	HD-SDI	SMPTE292M (BTA S-004) standard compliant <ul style="list-style-type: none"> 0.8 V [p-p]±10% (75 Ω) Automatic equalizer 100 m (328 ft) (when 1.5 Gbps/5C-FB cable is used)
	SD-SDI	SMPTE259M standard compliant <ul style="list-style-type: none"> 0.8 V [p-p]±10% (75 Ω) Automatic equalizer 200 m (656 ft) (when 5C-2V cable is used)
	During 3G mode 16 lines <ul style="list-style-type: none"> Connector: BNCx16 (only the odd numbered terminals can be used) The even numbered terminals <SDI IN 2>, <SDI IN 4> ... <SDI IN 32> cannot be used. <SDI IN 25>, <SDI IN 27>, <SDI IN 29>, and <SDI IN 31> terminals are equipped with color correctors. 	
	During 4K mode 4K signal x 8 lines <ul style="list-style-type: none"> Connector: BNC x 32 (3G-SDI x 4 SQD/2SI) Can use the 4K signal in SQD format and 2SI format 	
	3G-SDI	3G serial digital, SMPTE424M standard compliant <ul style="list-style-type: none"> 0.8 V [p-p]±10% (75 Ω) Automatic equalizer 100 m (328 ft) (when 3 Gbps/5C-FB cable is used) 3G-SDI Level B 3G-SDI Level A (FS ON)
DVI-D IN 1 to DVI-D IN 2 Terminals	2 lines Digital RGB:XGA (1024x768), WXGA (1280x768), SXGA (1280x1024), WSXGA+ (1680x1050),UXGA (1600x1200), WUXGA (1920x1200) Vertical frequency: 60 Hz Video format inputs: 1080/59.94p, 1080/50p, 1080/59.94i, 1080/50i, 720/59.94p, 720/50p <ul style="list-style-type: none"> Connectors: DVI-Dx2 The terminals do not support HDCP. The DVI-I connector cable cannot be used. For the DVI-D connector cable, use a cable with a length of up to 5 m.(16.4 ft) <DVI-D IN1>/<DVI-D IN2> terminals cannot be used during 3G mode and 4K mode. 	
SDI OUT 1 to SDI OUT 16 Terminals	During Standard mode 16 lines (2 distributed outputs per line) <ul style="list-style-type: none"> Connectors: BNCx32 ME1PGM, ME1PVW, ME1CLN, ME1KEYPVW, ME2PGM, ME2PVW, ME2CLN, ME2KEYPVW, DSKPGM1, DSKPGM2, DSKPVW1, DSKPVW2, DSK1CLN, DSK2CLN, DSK3CLN, DSK4CLN, SEL KEYPVW, MV1 to MV4, and AUX1 to AUX16 can be assigned. 	
	HD-SDI	SMPTE292M (BTA S-004) standard compliant <ul style="list-style-type: none"> Output level: 0.8 V [p-p]±10%
	SD-SDI	SMPTE259M standard compliant <ul style="list-style-type: none"> Output level: 0.8 V [p-p]±10%
	During 3G mode 3G-SDI output: 8 lines (2 distribute outputs per line) HD-SDI output: 2 lines (2 distribute outputs per line) <ul style="list-style-type: none"> Connector 3G-SDI: BNCx16 (odd numbered terminals only) HD-SDI: BNCx4 (<SDI OUT 14> and <SDI OUT 16> terminals only) 3G-SDI signal is not output from the even numbered terminals. No signal is output from the <SDI OUT 2>, <SDI OUT 4> ... <SDI OUT 12> terminals. The HD-SDI signal converted to the 1080i format is output from the <SDI OUT 14> and <SDI OUT 16> terminals. This signal is converted to the 1080i format by decimating the 1080p signal from the <SDI OUT 13> and <SDI OUT 15> terminals. <SDI OUT 13> and <SDI OUT 15> terminals are equipped with color correctors. The same color corrector setting is also applied to <SDI OUT 14> and <SDI OUT 16> terminals. ME1PGM, ME1PVW, ME1CLN, ME1KEYPVW, ME2PGM, ME2PVW, ME2CLN, DSKPGM1, DSKPGM2, DSKPVW1, DSKPVW2, DSK1CLN, DSK2CLN, SEL KEYPVW, MV1 to MV2, and AUX1 to AUX8 can be assigned. 	

SDI OUT 1 to SDI OUT 16 Terminals	During 4K mode 4K signal output: 3 lines (two distribute outputs per line) 2K signal output: 2 lines (two distribute outputs per line) <ul style="list-style-type: none"> Connector 3G-SDI (for 4K signal): BNC x 24 (terminal number 1 to 12) 3G-SDI (for 2K signal): BNC x 4 (terminal number 13 and 15) HD-SDI (for 2K signal): BNC x 4 (terminal number 14 and 16) The 4K signal is output in SQD format. The HD-SDI signal converted to the 1080i format is output from the <SDI OUT 14> and <SDI OUT 16> terminals. This signal is converted to the 1080i format by decimating the 1080p signal output from the <SDI OUT 13> and <SDI OUT 15> terminals. ME1PGM, ME1PVW, ME1CLN, ME1KEYPVW, ME2PGM, ME2PVW, ME2CLN, DSKPGM1, DSKPGM2, DSKPVW1, DSKPVW2, DSK1CLN, DSK2CLN, SEL KEYPVW, MV1 to MV2, and AUX1 to AUX8 can be assigned. 	
	3G-SDI	3G serial digital, SMPTE424M standard compliant <ul style="list-style-type: none"> Output level: 0.8 V [p-p] ±10% 3G-SDI Level B Mapping
Signal Formats	SD	480/59.94i, 576/50i
	HD	1080/59.94i, 1080/50i, 720/59.94p, 720/50p, 1080/24PsF, 1080/23.98PsF, 1080/25PsF, 1080/29.97PsF,
	3G	1080/59.94p, 1080/50p <Level B>
	4K	2160/59.94p, 2160/50p(SQD)
Signal Processing	Y:Pb:Pr	4:2:2 10 bit
	R:G:B	4:4:4 8 bit
ME Number	2 ME	

Synchronous Terminal

REF Terminal	<ul style="list-style-type: none"> Connectors: BNC Same field frequencies as those of the system formats supported In Genlock mode: Black burst or Tri-level Sync input signals (with loop-through) If the loop-through output is not used, provide a 75 Ω termination. In the 1080/24PsF and 1080/23.98PsF formats, only Genlock mode supported In the 1080/23.98PsF format, black burst signals with 10 Field ID (SMPTE318M standard compliant) or Tri-level Sync signals supported In the 1080/24PsF format, Tri-level Sync signals supported In internal sync mode: Black burst output signal x2 	
LTC IN Terminal	This is the LTC (linear time code) input terminal. <ul style="list-style-type: none"> Connectors: BNC Impedance: 1 kΩ Level: 1 to 2 V [p-p] 	
Video Delay Time	During Standard mode	
	1 line (H)	When the frame synchronizer is set to "Off" and the up-converter is set to "Off"
	2 field (V)	When the frame synchronizer is set to "On", or the up-converter is set to "On"
	<ul style="list-style-type: none"> When the signals have passed through PinP, DVE, MultiView, down-converter, or DVI-IN, a maximum delay of 1 frame is applied in each case. 	
	During 3G mode	
	2 line (H)	When the frame synchronizer is set to [Off]
2 frame (V)	When the frame synchronizer is set to [On]	
<ul style="list-style-type: none"> Maximum of 2 frame delay is added to each when passed through PinP, DVE, or MultiView. 		

Control Terminal

LAN Terminal	Compatible with 100Base-TX and AUTO-MDIX (For IP control) <ul style="list-style-type: none"> Connection cable: LAN cable (CAT5E), max. 100 m (328 ft), STP (Shielded Twisted Pair) cable recommended Connector: RJ-45 	
PANEL Terminal	Compatible with 100Base-TX and AUTO-MDIX (For Control Panel AV-HS60C2/AV-HS60C4 connection) <ul style="list-style-type: none"> Connection cable (supplied with AV-HS60C2/AV-HS60C4): LAN cable (CAT5E), straight cable, STP (Shielded Twisted Pair), 10 m (32.8 ft) Connector: RJ-45 	
COM1(M)/COM2(M)/COM3(M)Terminals	RS-422 Control Terminal For master connection for controlling external devices <ul style="list-style-type: none"> Connector: D-sub 9-pin (female) x 3, inch screw 	
COM4(M/S) Terminal	RS-422 Control Terminal For master/slave connection for controlling external devices <ul style="list-style-type: none"> Connector: D-sub 9-pin (female), inch screw Switchable between master connection and slave connection via menu 	
GPI IN Terminal	GPI IN: 18 inputs, general-purpose, photocoupler sensing ALARM OUT: 1 output, open collector output (negative logic) <ul style="list-style-type: none"> Connector: D-sub 25-pin (female), inch screw 	
GPI OUT1/GPI OUT 2 terminal	GPI OUT: 48 outputs, selected from general purpose, tally Open collector output <ul style="list-style-type: none"> Connector: D-sub 25-pin (female) x 2, inch screw 	
Accessories	<ul style="list-style-type: none"> AC cable AV-HS60U2P: 2 cables AV-HS60U2E: 4 cables Rack-mounted rear panel support bracket Screws for the rack-mounted rear panel support bracket: 8 screws Operating Guide for the AV-HS6000 series (Excerpted Version) 	

Control Panel AV-HS60C2P/E

Power Supply	AC100 V to 240 V, 50 Hz/60 Hz (AV-HS60C2 supports redundant power supply)
Power Consumption	40 W
Operating Ambient Temperature	0°C to 40°C (32°F to 104°F)
Operating Ambient Humidity	10% to 90% (no condensation)
Storage Temperature	0°C to 40°C (32°F to 104°F)
Storage Humidity	10% to 90% (no condensation)
Weight	Approx. 13.9 kg (30.6 lbs.)(excluding accessories)
Dimensions(WxHxD)	980 mm×153.4 mm×267 mm (38-19/32 inches×6-1/32 inches×10-1/2 inches) (excluding protrusions)

Control Terminal

Mainframe Terminal	Compatible with 100Base-TX and AUTO-MDIX (For Mainframe AV-HS60U2 connection) Connection cable (supplied with AV-HS60C2): LAN cable (CAT5E), Straight cable, STP (Shielded Twisted Pair), 10 m(32.8 ft) • Connector: RJ-45 When connected to the <LAN> terminal, no video will be displayed on the Menu Panel AV-HS60C3G.
MENU PANEL Terminal	Used only for the Menu Panel AV-HS60C3G • Connector: DVI-D • Because an independent signal format is used, cannot be displayed on a DVI-D monitor. • Cannot be used concurrently with a DVI-D monitor (computer) connected to the <DVI-D> terminal. Select with the display selector switch.
DVI-D Terminal	Used for displaying menus to the DVI monitor • Connector: DVI-D • Monitor resolution: 1366×768 compatible monitor • Cannot be used concurrently with the <MENU PANEL> terminal. Select with the display selector switch.
USB Terminal	For DVI monitor menu operation • Connector: USB (type A, female) • Cannot be used for the Menu Panel AV-HS60C3G.
Display Selector Switch	Switch for selecting <MENU PANEL> terminal or <DVI-D> terminal
COM1(M) Terminal	RS-422 Control Terminal For master connection for controlling external devices • Connector: D-sub 9-pin (female), inch screw
COM2(RS-232) Terminal	RS-232 Control Terminal For external device control connections • Connector: D-sub 9-pin (male), inch screw
GPI I/O Terminal	GPI IN: 8 inputs, general-purpose, photocoupler sensing ALARM OUT: 1 output, open collector output (negative logic) GPI OUT: 10 outputs, selected from general purpose, tally Open collector output • Connector: D-sub 25-pin (female), inch screw
ME Number	2 ME

Accessories	<ul style="list-style-type: none"> • AC Cable AV-HS60C2P: 2 cables AV-HS60C2E: 4 cables • LAN Cable: 1 cable (used to connect with the Mainframe AV-HS60U2) • Switch blank cap (large): 24 caps • Switch blank cap (small): 12 caps
-------------	---

Control Panel AV-HS60C4P/E

Power Supply	AC100 V to 240 V, 50 Hz/60 Hz (Supports redundant power supply)
Power Consumption	40 W
Operating Ambient Temperature	0°C to 40°C (32°F to 104°F)
Operating Ambient Humidity	10% to 90% (no condensation)
Storage Temperature	0°C to 40°C (32°F to 104°F)
Storage Humidity	10% to 90% (no condensation)
Weight	Approx. 15.0 kg (33.0 lbs.) (excluding accessories)
Dimensions(WxHxD)	656 mm×160 mm×400 mm (25-53/64 inches×6-19/64 inches×15-3/4 inches) (excluding protrusions)

Control Terminal

Mainframe Terminal	Compatible with 100Base-TX and AUTO-MDIX (For Mainframe AV-HS60U2 connection) Connection cable (supplied with AV-HS60C4): LAN cable (CAT5E), Straight cable, STP (Shielded Twisted Pair), 10 m (32.8 ft) • Connector: RJ-45 When connected to the <LAN> terminal, no video will be displayed on the Menu Panel AV-HS60C3G.
--------------------	--

MENU PANEL Terminal	Used only for the Menu Panel AV-HS60C3G • Connector: DVI-D • Because an independent signal format is used, cannot be displayed on a DVI-D monitor. • Cannot be used concurrently with a DVI-D monitor connected to the <DVI-D> terminal. Select with the display selector switch.
DVI-D Terminal	Used for displaying menus to the DVI monitor • Connector: DVI-D • Monitor resolution: 1366×768 compatible monitor • Cannot be used concurrently with the <MENU PANEL> terminal. Select with the display selector switch.
USB Terminal	For DVI monitor menu operation • Connector: USB (type A, female) • Cannot be used for the Menu Panel AV-HS60C3G.
Display Selector Switch	Switch for selecting <MENU PANEL> terminal or <DVI-D> terminal
COM1(M) Terminal	RS-422 Control Terminal For master connection for controlling external devices • Connector: D-sub 9-pin (female), inch screw
COM2(RS-232) Terminal	RS-232 Control Terminal For external device control connections • Connector: D-sub 9-pin (male), inch screw
GPI I/O Terminal	GPI IN: 8 inputs, general-purpose, photocoupler sensing ALARM OUT: 1 output, open collector output (negative logic) GPI OUT: 10 outputs, selected from general purpose, tally Open collector output • Connector: D-sub 25-pin (female), inch screw
ME Number	2 ME

Accessories

- AC Cable: 2 cables
- LAN Cable: 1 cable (used to connect with the Mainframe AV-HS60U2)
- Switch blank cap (large): 16 caps
- Switch blank cap (small): 8 caps

Menu Panel AV-HS60C3G

Power Supply	DC12 V/0.54 A (Supplied from AV-HS60C2/AV-HS60C4 using the supplied cable)
Power Consumption	6.48 W
Operating Ambient Temperature	0°C to 40°C (32°F to 104°F)
Operating Ambient Humidity	10% to 90% (no condensation)
Storage Temperature	0°C to 40°C (32°F to 104°F)
Storage Humidity	10% to 90% (no condensation)
Weight	Approx. 1.7 kg (3.7 lbs.) (excluding accessories)
Dimensions (WxHxD)	290 mm×177 mm×46.1 mm (11-13/32 inches×6-31/32 inches×1-13/16 inches) (excluding protrusions) 4RU

Control Terminal

Control Panel Terminal	Used only for the Control Panel AV-HS60C2/AV-HS60C4 • Connectors: DVI-D • Because an independent signal format is used, DVI-D source cannot be displayed. • Cannot be used concurrently with a DVI-D monitor connected to the <DVI-D> terminal of the Control Panel AV-HS60C2/AV-HS60C4. Set the display selector switch of the Control Panel AV-HS60C2 /AV-HS60C4 to the <MENU PANEL> terminal side.
------------------------	--

Accessories

- Connecting cable (with ferrite core) for the Control Panel AV-HS60C2
/AV-HS60C4 : 1 cable
- Bracket for mounting the Control Panel AV-HS60C2/AV-HS60C4
- Screws for the bracket for mounting the Control Panel AV-HS60C2
/AV-HS60C4 : 6 screws

Storage Module AV-HS60D1G

Weight	Approx. 7.0 g (0.3 ozs.)
Dimensions (WxHxD)	29.85 mm×4.0 mm×50.8 mm (1-3/16 inches×5/32 inches×2 inches)

Accessories

- AV-HS60D1 Installation Guide

Due to device characteristics, the storage module AV-HS60D1G is subject to data damage and overwriting restrictions.

Backup of important data is recommended.

*Specifications are subject to change without notice.

Please refer to the latest Non-linear Compatibility Information, P2 Support, Download and Service Information, etc. at the following Panasonic web site.



<http://pro-av.panasonic.net/>

Panasonic®

Panasonic Corporation
AVC Networks Company
 1-15 Matsuo-cho, Kadoma, Osaka 571-8504
 Japan
<http://pro-av.panasonic.net/>

[Countries and Regions]

Argentina	+54 11 4122 7200	Malaysia	+60 3 7809 7888	U.A.E. (for All Middle East)	+971 4 8862142
Australia	+61 (0) 2 9491 7400	Mexico	+52 55 5488 1000	Ukraine	+380 44 4903437
Brazil	+55 11 3889 4035	Mongolia	+976 70115577	U.K.	+44(0)1344 70 69 13
Canada	+1 905 624 5010	Netherlands, Belgium	+31 73 640 2729	U.S.A.	+1 877 803 8492
China	+86 10 6515 8828	New Zealand	+64 9 272 0100	Vietnam	+65 6277 7284
Hong Kong	+852 2313 0888	Norway	+47 67 91 78 00		
Czech Republic	+421 (0) 903 447 757	Pakistan	+92 21 111 567 111		
Denmark	+45 43 20 08 57	Palestine	+972 2 2988750		
Egypt	+20 2 23938151	Panama	+507 229 2955		
Finland, Latvia, Lithuania, Estonia	+358 (9) 521 52 53	Philippines	+65 6277 7284		
France	+33 (0) 1 47 91 64 00	Poland	+48 (22) 338 1100		
Germany, Austria, Switzerland	+49 (0) 6103 313887	Portugal	+351 21 425 77 04		
Greece	+30 210 96 92 300	Romania, Albania, Bulgaria, Macedonia	+40 (0) 729 164 387		
Hungary	+36 (1) 382 60 60	Russia & CIS	+7 495 9804206		
India	+91 1860 425 1860	Saudi Arabia	+966 (1) 4790499		
Indonesia	+65 6277 7284	Singapore	+65 6277 7284		
Iran	+98 21 2271463	Slovak Republic, Croatia, Serbia, Bosnia, Montenegro, Slovenia	+421 (0) 903 447 757		
(Vida)	+98 21 2271463	South Africa	+27 11 3131622		
(Panasonic Office)	+98 2188791102	Spain	+34 (93) 425 93 00		
Italy	+39 02 6788 367	Sweden	+46 (8) 680 26 41		
Jordan	+962 6 5859801	Taiwan	+886 2 2227 6214		
Kazakhstan	+7 727 298 0891	Thailand	+662 731 8888		
Korea	+82 2 2106 6641	Turkey	+90 216 578 3700		
Kuwait	+96 522431385				
Lebanon	+96 11665557				



Factories of AVC Networks Company have received ISO14001:2004-the Environmental Management System certification. (Except for 3rd party's peripherals.)