

Comba

ComFlex 600 Series

DISTRIBUTED ANTENNA SYSTEM

USER MANUAL

ComFlex 6100 1W QE: 1-0-0

Comba Telecom Ltd.

The information contained herein is the responsibility of and is approved by the following, to whom all enquiries should be directed in the first instance:

This is an unpublished work the copyright in which vests in Comba International ("Comba"). All rights reserved.

The information contained herein is confidential and the property of Comba and is supplied without liability for errors or omissions. No part may be reproduced, disclosed or used except as authorised by contract or other written permission. The copyright and the foregoing restriction on reproduction and use extend to all media in which the information may be embodied.

0.1 CONTENTS

Section	Page
0.1 CONTENTS	3
0.2 INDEX TO FIGURES AND TABLES	4
0.3 HISTORY.....	6
0.4 GLOSSARY OF TERMS.....	7
0.5 SAFETY NOTICES AND ADMONISHMENTS	8
1 GENERAL INFORMATION	9
2 EQUIPMENT DESCRIPTION.....	11
2.1 SYSTEM DIAGRAM	11
2.2 TYPICAL APPLICATION	11
2.3 EQUIPMENT CONSTITUTION	12
2.4 KIT OF PART	13
3 INSTALLATION	15
3.1 WARNINGS AND ALERTS.....	15
3.2 SITE PLANNING CONSIDERATIONS	16
3.3 INSTALLATION PROCEDURES	18
3.4 EQUIPMENT CONNECTORS	26
3.5 EQUIPMENT CONNECTION	29
4 COMMISSIONING	34
4.1 PRE-COMMISSIONING TASKS	34
4.2 LED INDICATORS	34
4.3 DIGITAL DISPLAY INDICATORS	35
4.3.1 DIGITAL DISPLAY ON RFU	35
4.3.2 DIGITAL DISPLAY ON FOU.....	35
5 WEB GUI	37
5.1 WEB GUI CONNECTION	37
5.2 WEB GUI INTRODUCTION	38
5.2.1 [DEVICES]	38
5.2.2 [COMMISSIONING]	42
5.2.3 [FIRMWARE]	43
5.2.4 [MANAGEMENT]	44
5.3 COMMISSIONING PROCEDURE	50
6 ALARMS AND TROUBLESHOOTING	58
6.1 ALARMS.....	58
6.2 TROUBLESHOOTING	59
7 APPENDICES	60
7.1 APPENDIX A: TOOLS FOR INSTALLATION AND MAINTENANCE.....	60
7.2 APPENDIX B: RMA (RETURN MATERIAL AUTHORIZATION)	61

0.2 INDEX TO FIGURES AND TABLES

Figure 1: Master Unit (MU)	9
Figure 2: Remote Unit (RU)	10
Figure 3: System Diagram	11
Figure 4: Typical Application	11
Figure 5: ComFlex Master Unit	18
Figure 6: RF Unit Installation	19
Figure 7: FOU Installation	19
Figure 8: PSU Installation	20
Figure 9: Mounting Rack	20
Figure 10: Angle Iron Installation	21
Figure 11: MU Installation	21
Figure 12: Secure the Enclosure	21
Figure 13: Finish Installaiton	22
Figure 14: Wall Drilling Dimensions of RU	23
Figure 15: Install Mounting Rack on the Wall	23
Figure 16: Hang RU onto the Mounting Rack	24
Figure 17: Tighten the Screws at the Bottom of RU	24
Figure 18: Tighten Two Hexagon Screws	24
Figure 19: Install PSU on RU	25
Figure 20: Wall Drilling Dimensions of PSU	25
Figure 21: Install PSU on the Wall	26
Figure 22: MU Front Panel Connectors	26
Figure 23: MU Rear Panel Connectors	27
Figure 23: Mini Din Female Dimension	27
Figure 24: RU Connectors	28
Figure 25: MU Grounding (MU Rear Panel)	29
Figure 26: RU Grounding	30
Figure 27: Fiber Optical and RF Port Connection	30
Figure 28: MU Power Connection (Rear Panel)	31
Figure 29: RU Fiber Optical and RF Port Connection	32
Figure 30: PSU Power Port Connection	32
Figure 31: Pins Allocation for "EXT_ALM" Port for RU	33
Figure 32: Pins Allocation for "BTS_ALM" Port	33
Figure 33: RFU Digital Display	35
Figure 34: Optical Port No. and Digital Display	36
Figure 35: PC IP Address Setting	37
Figure 36: Input IP Address	37
Figure 37: Input User Name and Password	38
Figure 38: Web GUI Main Screen	38
Figure 39: [Devices] Sceen	39
Figure 40: MU Device - Monitoring Unit	39
Figure 41: MU Device - Optical Unit	40
Figure 42: MU Device - RF Unit	40
Figure 43: RU Device	41
Figure 44: RU Device – 700	41
Figure 45: RU Device – External Alarm	42
Figure 46: [Commissioning] Screen	42
Figure 47: [Firmware] Screen - Upgade	43
Figure 48: [Firmware] Screen – Pop-up Window 1	43
Figure 49: [Firmware] Screen – Pop-up Window 2	43
Figure 50: [Firmware] Screen - Swap	44
Figure 51: [Management] Sceen	44
Figure 52: Management – Import&Export	45

Figure 53: Management – IP Setting	46
Figure 54: Management – SNMP Setting.....	46
Figure 55: Management – Security	47
Figure 56: Modify Password.....	47
Figure 57: Management – Device Reset.....	48
Figure 58: Management – PA Reset.....	48
Figure 59: Management – Device Info.....	49
Figure 60: Management – Device Scanning.....	49
Figure 61: Management – Device Remove	50
Figure 62: Commissioning Procedure - Start.....	50
Figure 63: Commissioning Procedure – Device Scan.....	51
Figure 64: Commissioning Procedure – Params Setting.....	51
Figure 65: Dev Info & Date/Time	52
Figure 66: Commissioning Procedure – MU Calibration.....	53
Figure 67: Commissioning Procedure – MU Calibration Finish	53
Figure 68: Commissioning Procedure – RU Calibration	54
Figure 69: Commissioning Procedure – RU Calibration Finish.....	54
Figure 70: Commissioning Procedure – MU Setup	54
Figure 71: MU Frequency Band Table.....	55
Figure 72: Commissioning Procedure – RU Setup.....	55
Figure 73: RU Frequency Band Table	56
Figure 74: Commissioning Procedure – Finish	56
Table 1: MU Components.....	12
Table 2: RU Components	12
Table 3: Master Unit (MU) KOP	13
Table 4: Remote Unit (RU) KOP	14
Table 5: MU Connections	27
Table 6: RU Connections.....	28
Table 7: Pin Definition of “EXT_ALM” Port for RU	33
Table 8: Pin Definition of “BTS_ALM” Port.....	33
Table 9: MU LED Indications	34
Table 10: RU LED Indications.....	34
Table 11: RFU Digital Display	35
Table 12: FOU Digital Display.....	36
Table 13: Import/Export Parameters.....	45
Table 14: MU Alarm List	58
Table 15: RU Alarm List.....	58
Table 16: MU Alarms Diagnosis	59
Table 17: RU Alarms Diagnosis.....	59

0.3 HISTORY

Change No.	ENU	Details Of Change
1	1-0-0	This user manual first created in Sep 2013.

0.4 GLOSSARY OF TERMS

ALC	Automatic Level Control
ATT	Attenuation
BDA	Bi-direction Amplifier
BS	Base Station
BTS	Base Transceiver Station
DL	Downlink
DT	Donor Terminal
FOU	Fiber Optical Unit
GUI	Graphic User Interface
ID	Identification
LNA	Low Noise Amplifier
MCU	Main Control Unit
MT	Mobile Terminal
MTBF	Mean Time Between Failures
MU	Master Unit
NC	Normally Closed
NF	Noise Figure
NO	Normally Open
OMC	Operation & Maintenance Center
OMT	Operation & Maintenance Terminal
OP	Optical Fiber
OPEX	OperatingExpense
PA	Power Amplifier
PIM	Passive Inter Modulation
PLL	Phase Locked Loop
POI	Point of Interconnects
PSU	Power Supply Unit
RF	Radio Frequency
RFU	Radio Frequency Unit
RU	Remote Unit
SMA	Sub-Miniature "A" Connector
TX/RX	Transmit/Receive
UL	Uplink
VAC	Volts Alternating Current
VSWR	Voltage Standing Wave Ratio
WCDMA	Wideband Code Division Multiple Access

0.5 SAFETY NOTICES AND ADMONISHMENTS

This document contains safety notices in accordance with appropriate standards. In the interests of conformity with the territory standards for the country concerned, the equivalent territorial admonishments are also shown.

Any installation, adjustment, maintenance and repair of the equipment must only be carried out by trained, authorized personnel. At all times, personnel must comply with any safety notices and instructions.

Specific hazards are indicated by symbol labels on or near the affected parts of the equipment. The labels conform to international standards, are triangular in shape, and are coloured black on a yellow background. An informative text label may accompany the symbol label.

Hazard labeling is supplemented by safety notices in the appropriate equipment manual. These notices contain additional information on the nature of the hazard and may also specify precautions.

Warning:

These draw the attention of personnel to hazards that may cause death or injury to the operator or others. Examples of use are cases of high voltage, laser emission, toxic substances, point of high temperature, etc.

WARNING! To comply with FCC RF exposure compliance requirements, each individual antenna used for this transmitter must be installed to provide a separation distance greater than 64 cm or more from all persons during normal operation and must not be co-located with any other antenna for meeting RF exposure requirements.

The design of the antenna installation needs to be implemented in such a way so as to ensure RF radiation safety levels and non-environmental pollution during operation.

Note: Antennas, feeders and couplers are not included in the packing list, solution provider should consider consider these accessories according to site conditions.

WARNING! Antenna gain should not exceed 12.5 dBi.

WARNING! The design of the antenna installation needs to be implemented in such a way so as to ensure RF radiation safety levels and non-environmental pollution during operation.

WARNING! For 1710-1755 MHz, installation must comply with 27.50(d)(4) max 1 W EIRP and fixed station ABSOLUTE max 10 m antenna height above earth.

WARNING! This is **NOT** a **CONSUMER** device. It is designed for installation by **FCC LICENSEES** and **QUALIFIED INSTALLERS**. You **MUST** have and **FCC LICENSE** or express consent of an FCC License to operate this device. Unauthorized use may result in signification forfeiture penalties, including penalties in excess of \$100,000 for each continuing violation.

Alert:

These draw the attention of personnel to hazards that may cause damage to the equipment. An example of use is the case of static electricity hazard.

Caution notices may also be used in the handbook to draw attention to matters that do not constitute a risk of causing damage to the equipment but where there is a possibility of seriously impairing its performance, e.g. by mishandling or gross maladjustment. Warnings and Cautions within the main text do not incorporate labels and may be in shortened form.

End of Section

1 GENERAL INFORMATION

The ComFlex 600 Series Distributed Antenna System (hereinafter called “ComFlex”) consists of Master Unit (MU) and Remote Unit (RU). The MU includes the MU Chassis, Power Supply Unit (PSU), Fiber Optical Unit (FOU) and RF Unit (RFU). With a modular design, it can support up to 8 independent RF inputs and 8 Remote Units. The Remote Unit is designed with a compact and slim form factor for easy installation; it is an integrated design which supports 5 independent bands, 700MHz (lower ABC)/700MHz (upper C), 850MHz, 1900MHz and AWS band.

The low signal transmission loss of optical fiber is applicable for long distance transmission. ComFlex can support the optical transmission of up to 6.5dBo optical loss, equivalent to 8 miles fiber length.

Main feature:

- Industry’s first DAS system with superior PIM performance MINI-DIN RF connectors.
- Independent coupling port for uninterrupted network testing.
- Modularized Master Unit supports flexible field upgrade and maintenance.
- Independent gain control for each RF source.
- High MTBF and low noise design with modular PSU and convection cooling.
- RF module supports both simplex and duplex.
- Compact slim Remote Unit for OPEX saving.
- Supports multi-operator and mix mode application.
- Optical link auto gain control.
- Web based GUI for intelligent commissioning and configuration.

The figures below show the ComFlex Master and Remote unit enclosure.



Figure 1: Master Unit (MU)



Figure 2: Remote Unit (RU)

End of Section

2 EQUIPMENT DESCRIPTION

2.1 SYSTEM DIAGRAM

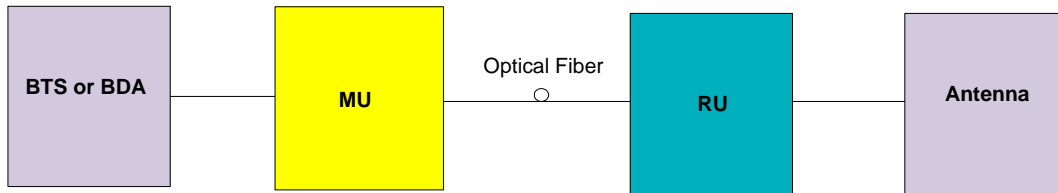

Figure 3: System Diagram

On the DL, signals from the BTSs or BDA are converted into optical signals after amplification in the MU. Then the optical signals are transmitted to the RU via optical fiber. The Optical TX/RX Module of RU converts the DL optical signals into RF signals. After amplification, the signals are transmitted from RU ANT port to the service antenna using 50Ohm coaxial cable.

On the UL, the signals transmitted by the mobile are converted into optical signals, and then via the UL optical fiber, the signals are transmitted to MU, which then converts the optical signals back to RF signals and send to BTS or BDA via 50Ohm coaxial cable.

2.2 TYPICAL APPLICATION

Shown below are the typical SISO and MIMO applications of MU and RUs.

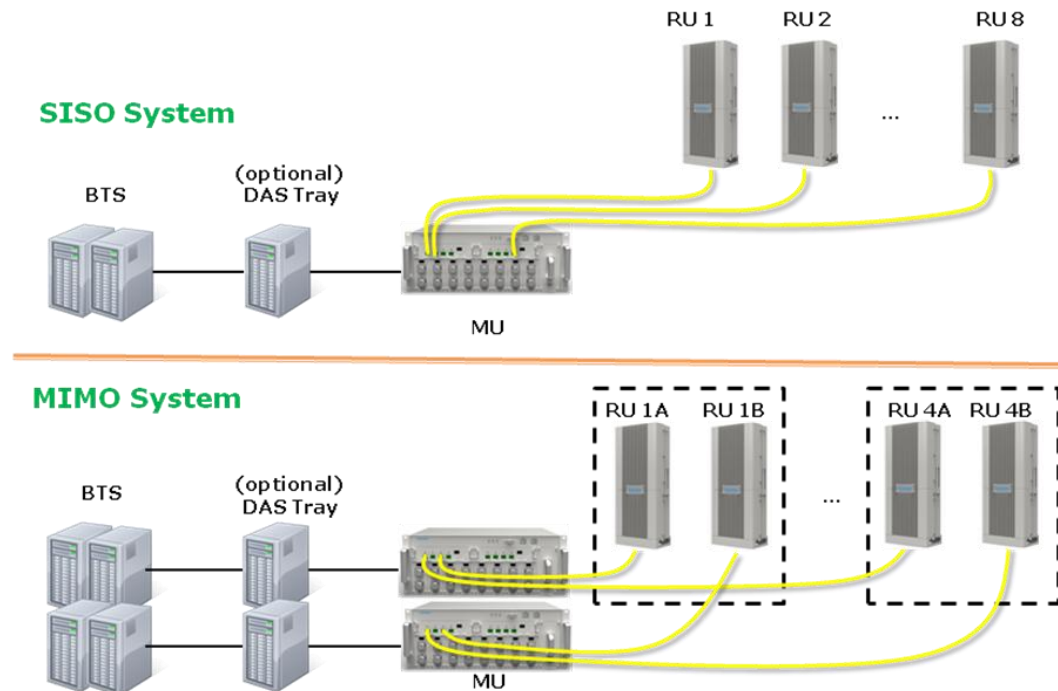

Figure 4: Typical Application

2.3 EQUIPMENT CONSTITUTION

MU consists of the following parts:

Table 1: MU Components

Module	Description
MU01-RACK	Master Unit Chassis includes eight slots for RF Unit, two slots for Fiber Optical Unit, and one slot for Power Supply Unit.
MU01-PSU	iDAS Master Unit Power Supply Unit (PSU) converts the input voltage into stable DC to supply power for other modules of Master Unit.
MU01-FOU	Master Unit Fiber Optical Unit (FOU) completes optical signal and RF signal conversion. One FOU has four optical ports, which means each FOU can support up to four RUs.
MU01-RFU	Master Unit RF Unit completes separation and combination of uplink and downlink signal with independent gain control, supports either simplex or duplex.

RU consists of the following parts:

Table 2: RU Components

Module	Description
LRU01-6100	Remote Unit; A compact and slim design which supports 5 bands, including 700MHz (lower ABC, upper C), 850MHz, 1900MHz and AWS band.
LRU01-PSU	Remote Unit Power Supply Unit (PSU) converts the input AC voltage into stable DC, to supply power for Remote Unit. It can be installed on RU or on wall beside RU.

2.4 KIT OF PART

Table 3: Master Unit (MU) KOP







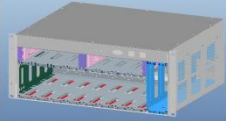

Item	Qty	Image
MU Chassis	1	
RF Unit (RFU)	1~8	
Fiber Optical Unit (FOU)	1~2	
Power Supply Unit (PSU)	1	
Power Supply Cable (13 Feet 1 inch)	1	
Communication Cable	1	
Right Angle Bracket (for MU 19" rack mounting)	1	
Left Angle Bracket (for MU 19" rack mounting)	1	

Table 4: Remote Unit (RU) KOP

Item	Qty	Image
Remote Unit	1	
RU Power Supply Unit (with 1 foot 9 inches. DC cable and 13 feet 1 inch AC cable)	1	
Mounting Rack (for RU wall mounting)	1	
Masonry Bolt (set) M8x80 (for RU concrete wall mounting)	4	
Masonry Bolt (set) M8x80 (for PSU concrete wall mounting)	2	
Nuts M6x10, Spring Washers $\Phi 6$, Plain Washers $\Phi 6$ (for PSU mounting on RU)	2 pieces each	
Nuts M6x10, Spring Washers $\Phi 6$, Plain Washers $\Phi 6$ (for RU grounding)	2 pieces each	
GND Cable (for RU grounding)	1	
Nuts M6x10, Spring Washers $\Phi 6$, Plain Washers $\Phi 6$ (for PSU grounding)	2 pieces each	
GND Cable (for PSU grounding)	1	

End of Section

3 INSTALLATION

3.1 WARNINGS AND ALERTS

Laser

Laser light can cause damage to eyes. Laser light is not visible. Viewing it directly does not cause pain. The iris of the eye will not close when viewing a bright light. Consequently, serious damage to the retina of the eye is possible. NEVER LOOK INTO THE END OF A FIBER WHICH MAY HAVE A LASER COUPLED TO IT.

Radio Frequency Energies

There may be situations, particularly for workplace environments near high-powered RF sources, where recommended limits for safe exposure of human beings to RF energy could be exceeded. In such cases, restrictive measures or actions may be necessary to ensure the safe use of RF energy.

High Voltage

The equipment has been designed and constructed to prevent practicable danger, as far as reasonably possible. Any work activity on or near equipment involving installation, operation or maintenance must be free from danger, as far as reasonably possible.

Where there is a risk of damage to electrical systems involving adverse weather, extreme temperatures, wet, corrosive or dirty conditions, flammable or explosive atmospheres, the system must be suitably installed to prevent danger.

Protective Earthing

Equipment provided for the purpose of protecting individuals from electrical risk must be suitable for the purpose and properly maintained and used.

Handling Precautions

This covers a range of activities including lifting, lowering, pushing, pulling, carrying, moving, holding or restraining an object or person. It also covers activities that require the use of force or effort, such as pulling a lever, or operating power tools.

Electrostatic Discharge (ESD)

Observe standard precautions for handling ESD-sensitive devices. Assume that all solid-state electronic devices are ESD-sensitive. Ensure the use of a grounded wrist strap or equivalent while working with ESD-sensitive devices. Transport, store, and handle ESD-sensitive devices in static-safe environments.

3.2 SITE PLANNING CONSIDERATIONS

3.2.1 SITE PLANNING

Site Considerations

The MU is designed to be located indoors to facilitate coupling of BTS signals and power supply connections. The input range of MU RF unit is 10~30 dBm.

The site consideration for RU is listed below:

- The distance between the service antenna of RU and coverage area should satisfy line of sight requirements for maximum coverage area.
- The maximum fiber length is 8 miles, with a maximum path loss of 6.5dB_o.
- The system delay of the optical system must be taken into consideration when there are neighboring BTS sites overlapping in coverage.

Installation Location

Mounting surface shall be capable of supporting the weight of the equipment.

In order to avoid electromagnetic interference, a proper mounting location must be selected to minimize interference from electromagnetic sources such as large electrical equipment.

Environmental

Humidity has an adverse effect on the reliability of the equipment. It is recommended to install the equipment in locations having stable temperature and unrestricted air-flow.

The installation location for the system should be well ventilated. The equipment has been designed to operate at the temperature range and humidity level as stated in the product specifications.

Powering

The power supply unit (PSU) provides power to all modules within the equipment. Depending on the product variant, it is recommended that the PSU operates on a dedicated AC circuit breaker or fused circuit.

Grounding Requirement

Verify that the equipment has been well grounded. This includes antennas and all cables connected to the system. Ensure lightning protection for the antennas is properly grounded.

Cable Routing

Depending on equipment configuration, a variety of types of cables are connected to the MU and RU: coaxial cables, optical fibers, power cable, communication cable, and commissioning cable. Where applicable, ensure cables are properly routed and secured so that they are not damaged.

Manual Handling

During transportation and installation, take necessary handling precautions to avoid potential physical injury to the installation personnel and the equipment.

3.2.2 SYSTEM INSTALLATION CHECKLIST

- Working space available for installation and maintenance for each mounting arrangement. Ensure unrestricted airflow.
- Ensure earthing point is within reach of the ground wire. (2m; 6 ft. 10 in.).
- Ensure a power source is within reach of the power cord and the power source has sufficient capacity.
- Where appropriate, ensure unused RF connectors are terminated.
- Where appropriate, ensure unused optical fiber connectors are protected.
- Do not locate the equipment near large transformers or motors that may cause electromagnetic interference.
- Reduce signal loss in feeder cable by minimizing the length and number of RF connections.
- Ensure the equipment will be operated within the stated environment (refer to datasheet).
- Where needed, couple BTS RF signal with a coupler to prevent damaging the equipment.
- Where appropriate, confirm availability of suitably terminated grade of RF and optical fiber.
- Observe handling of all cables to prevent damage.

3.3 INSTALLATION PROCEDURES

3.3.1 GOODS INWARDS INSPECTION

ComFlex was factory tested, inspected, packed, and delivered to the carrier with utmost care. Do not accept shipment from carrier which shows damage or shortage until the carrier's agent endorses a statement of the irregularity on the face of the carrier's receipt. Without documentary evidence, a claim cannot be processed.

Open and check each package against the packing list. For any shortage, contact Comba Telecom Systems. Do not remove items from packing materials until installation.

3.3.2 TOOLS

See Appendix A for a full list of tools required for installation and maintenance.

3.3.3 PREPARATION

Optical Fiber:

- Fiber optic cables require proper handling. Do not stretch, puncture, or crush the fiber cable(s) with staples, heavy equipment, doors, etc.
- Always maintain the minimum bending radius specified by the cable manufacturer. The minimum bend radius is usually 10 times the cable's outer diameter. In the case of single optical fiber that is not in a cable, the minimum bending radius to be observed is 3cm. (1.2")

3.3.4 MU ASSEMBLING

ComFlex Master Unit consists of 4 parts: Chassis, RFU, FOU and PSU. All the units are packed separately. Follow the steps below to assemble.

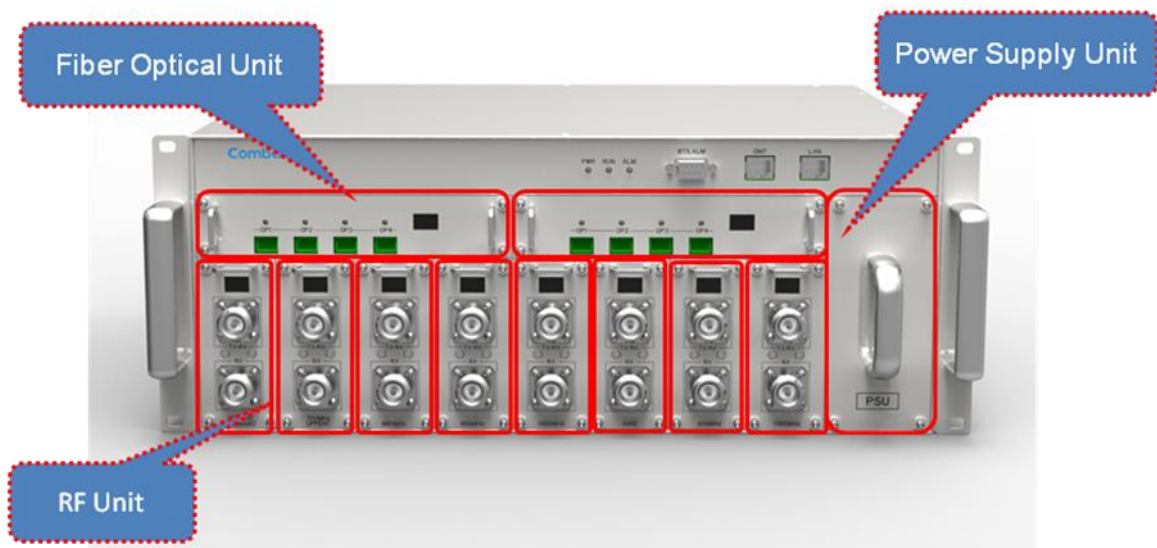

Figure 5: ComFlex Master Unit

Step1: RF Unit installation: Remove RFU slot cover plate on Chassis, insert RFU and fasten the screws. (Each Unit can be installed in any one of eight RFU slots)

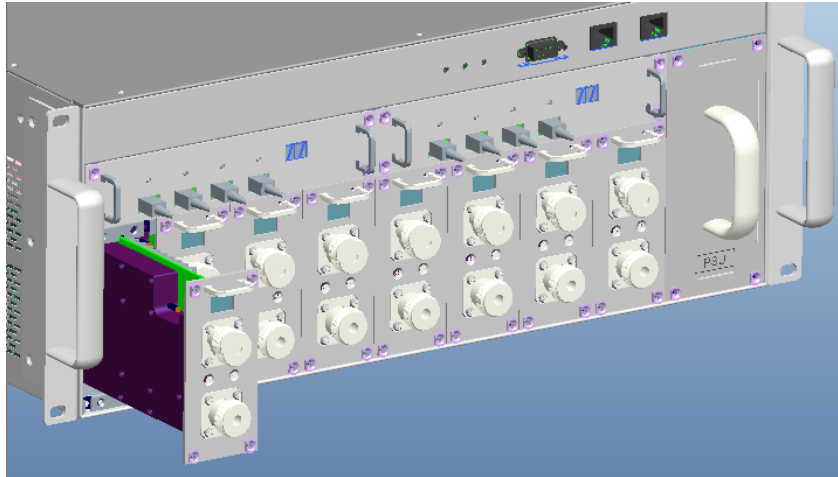

Figure 6: RF Unit Installation

Step2: FOU installation: Remove FOU slot cover plate on Chassis, insert FOU and fasten the screws. (Each Unit can be installed in either one of two FOU slots)

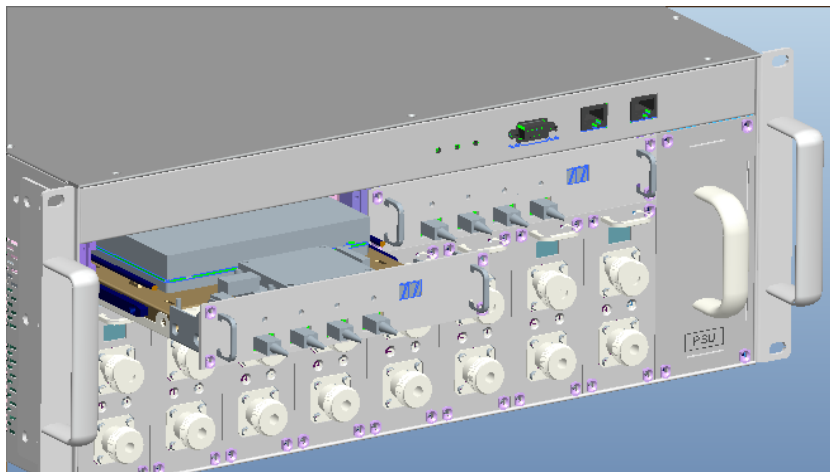

Figure 7: FOU Installation

Step3: PSU installation: Remove PSU slot cover plate on the right side of Chassis, insert PSU and fasten the screws.

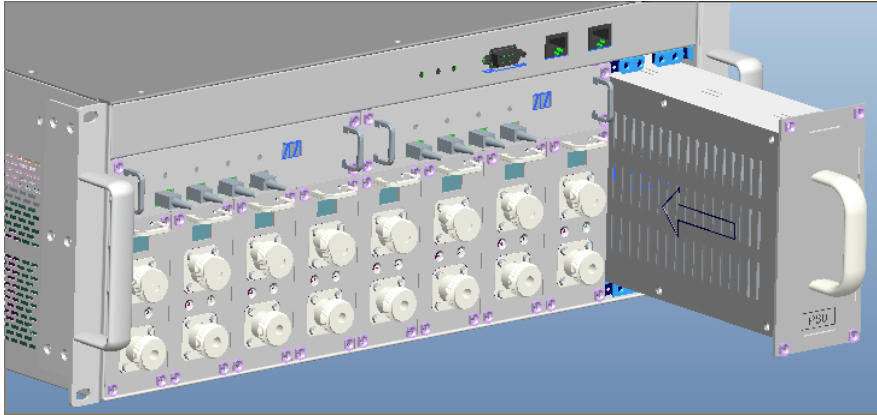

Figure 8: PSU Installation

3.3.5 MU IN 19" RACK MOUNTING

MU is an indoor type device; the installation procedures are shown as below:

Step 1: Install right angle bracket and left angle bracket on back of the mounting rack. (Rack nuts and screws are not provided.) Use rack nuts and screws as recommended by rack manufacturer.

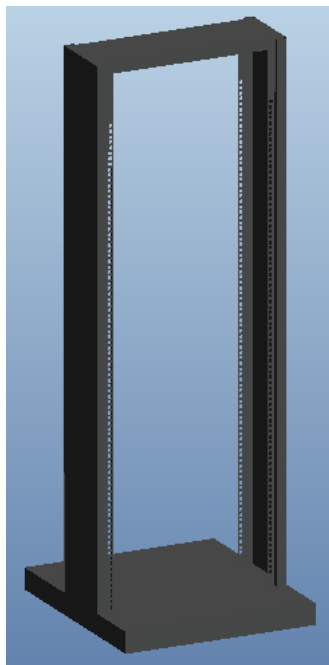

Figure 9: Mounting Rack

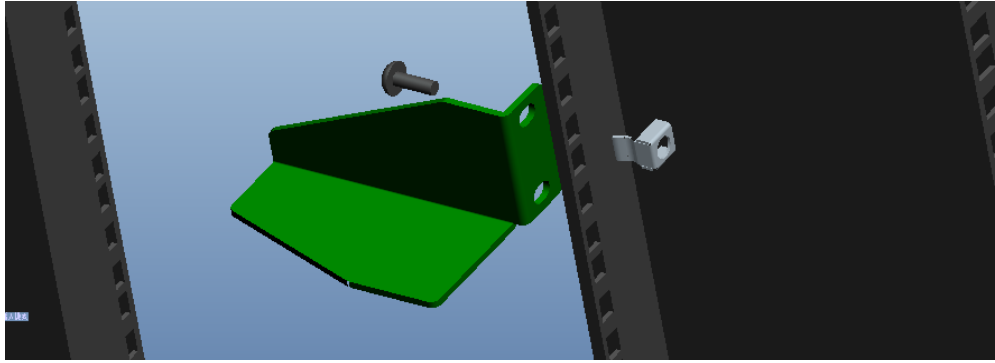

Figure 10: Angle Iron Installation

Step2: Slide the MU on to the angle brackets and confirm it is level.

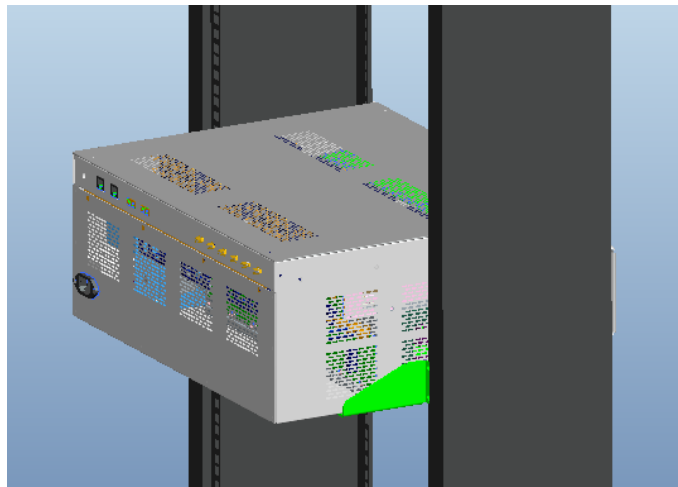

Figure 11: MU Installation

Step 3: Attach the MU onto the rack with the recommended rack screws.

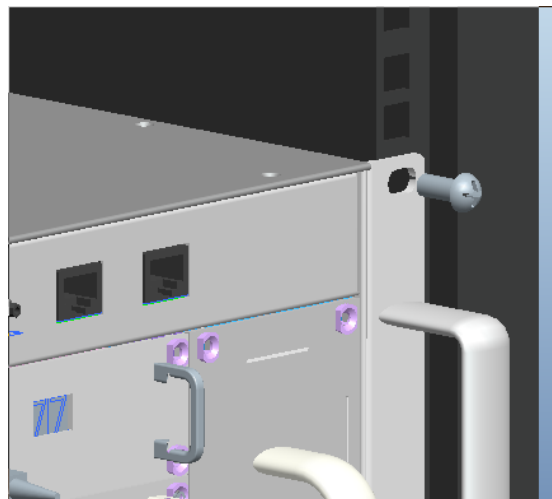

Figure 12: Secure the Enclosure

Step 4: Finish installation.

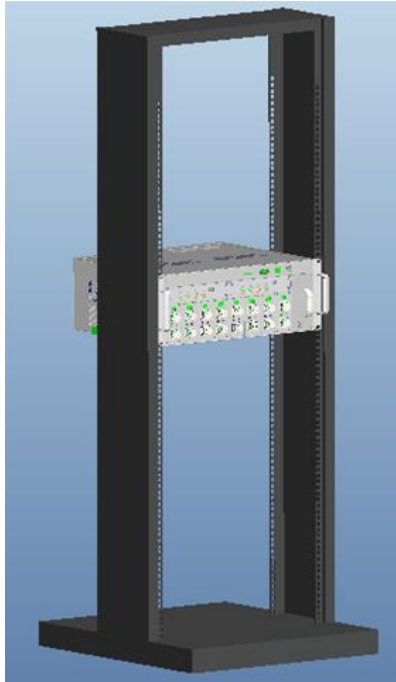

Figure 13: Finish Installaiton

3.3.6 RU WALL MOUNTING

RU wall mounting steps are shown below.

Step 1: Select the wall mount location according to the following criteria:

- General surroundings
- If mounting on dry wall, 0.75 In (min) plywood backboard is required to support the weight of the equipment.
- Ventilated and easy-to-reach area (for maintenance and on-site inspection)
- Proximity to DAS antenna in order to minimize cable loss

Step 2: Measure and mark the locations of 4 holes on the wall. Refer to Fig 14 for the wall drilling dimensions of RU. Use a $\Phi 10$ drill bit for masonry bolts.

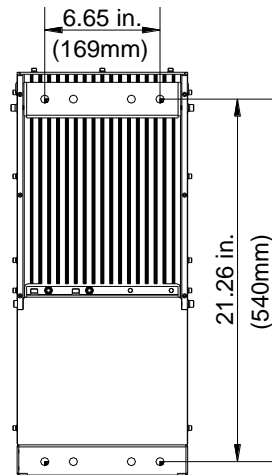

Figure 14: Wall Drilling Dimensions of RU

Step 3: Attach the mounting rack on a wall. If a concrete wal, use the 2 M8x80 masonry bolts. (Bolts are provided; lag bolts or screws are not provided for plywood mounting)

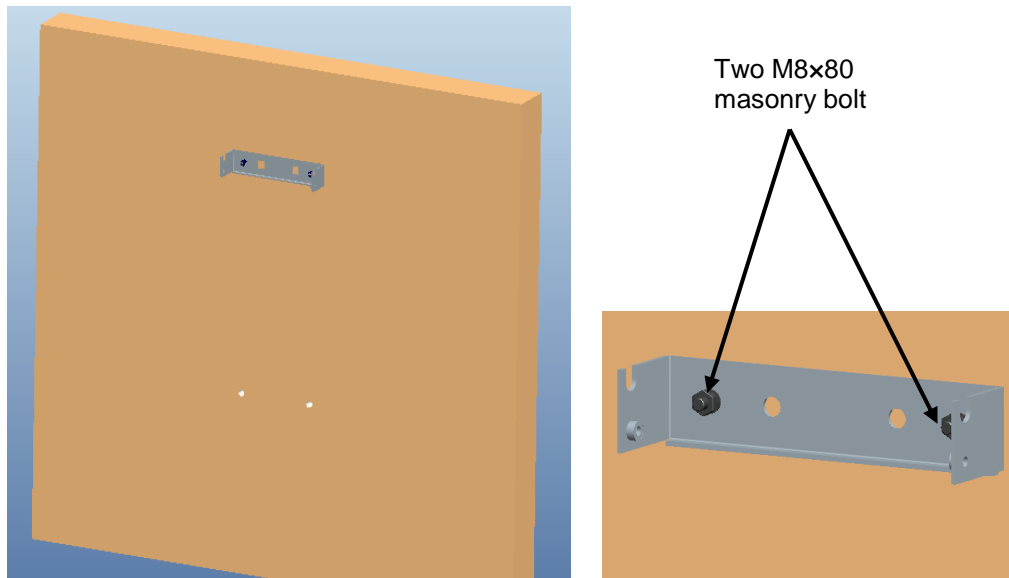

Figure 15: Install Mounting Rack on the Wall

Step 4: Ensure the antenna and other connectors are facing down, hang RU onto semicircle slot of mounting rack.

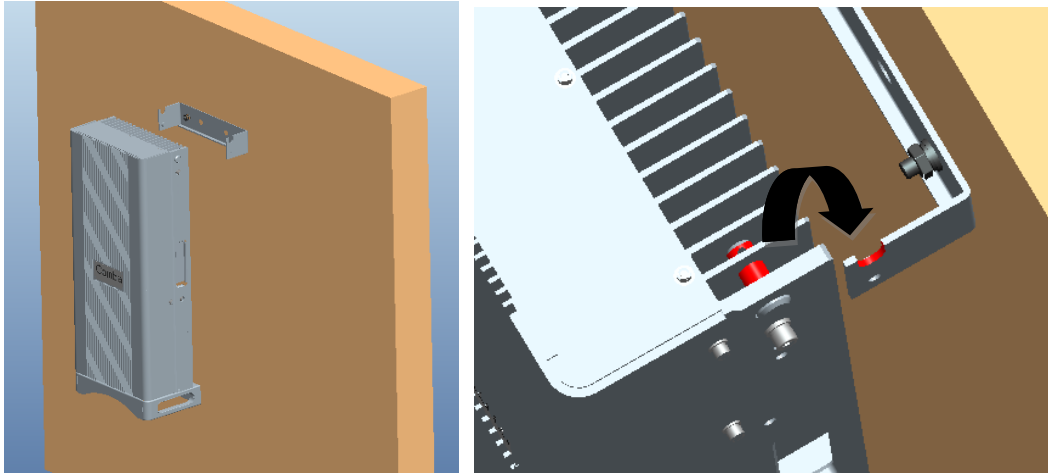

Figure 16: Hang RU onto the Mounting Rack

Step 5: Tighten the bottom two M8x80 masonry bolts on RU.

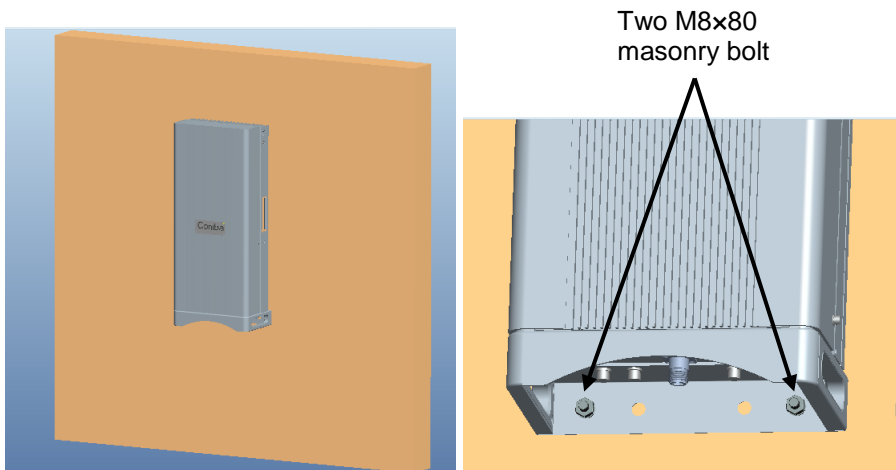

Figure 17: Tighten the Screws at the Bottom of RU

Step 6: Tighten M6x20 hexagon screws on the left and right sides of RU to fasten it with mounting rack.

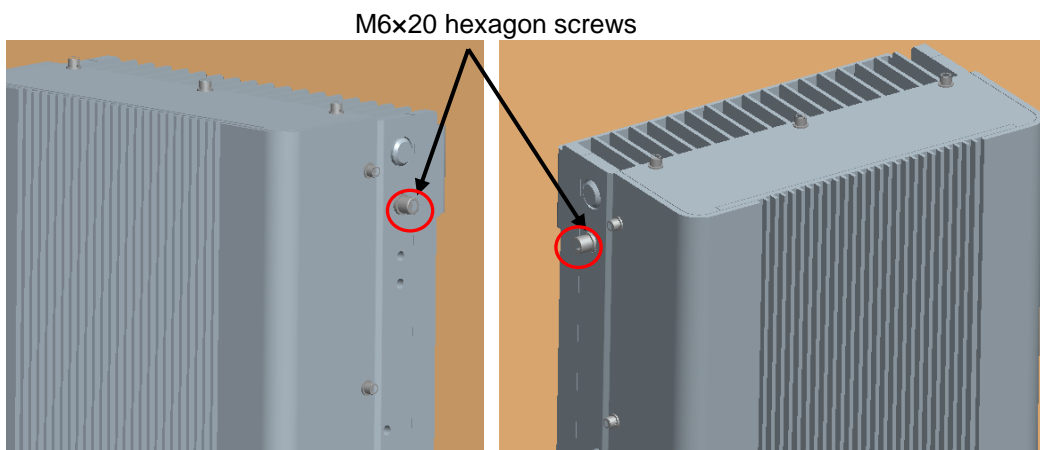

Figure 18: Tighten Two Hexagon Screws

3.3.7 PSU INSTALLATION

RU Power Supply Unit should be installed after the RU is mounted. RU Power Supply Unit can be installed in two ways – attached to RU or mounted on wall.

PSU attached to RU

Attach the PSU on the right of the RU with two M6x10 hexagon screws (screws are provided).



Figure 19: Install PSU on RU

PSU mounted on wall

Step 1: Measure and mark the locations of 2 holes on the wall close to RU. Use $\Phi 10$ drill head.
 (NOTE: DC cable is 1 foot 9 inches; AC cable is 13 feet 1 inch)

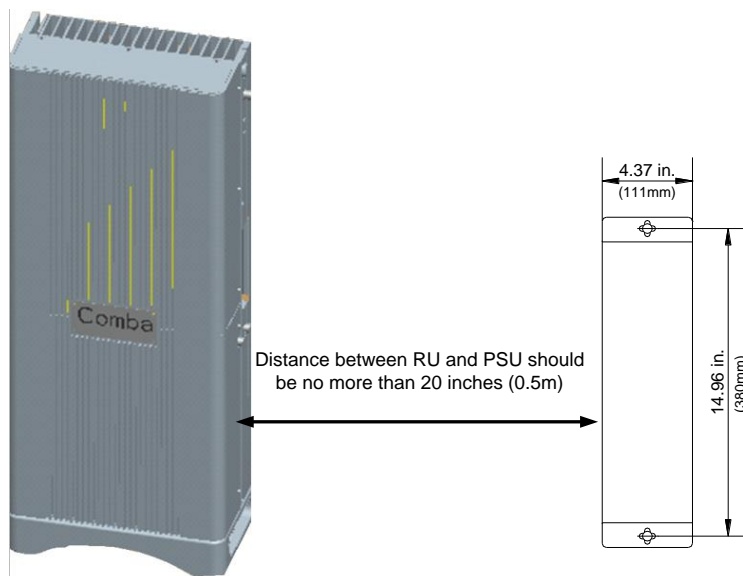

Figure 20: Wall Drilling Dimensions of PSU

Step 2: Attach the PSU on the wall with two M8x80 hexagon screws (Screws are provided)

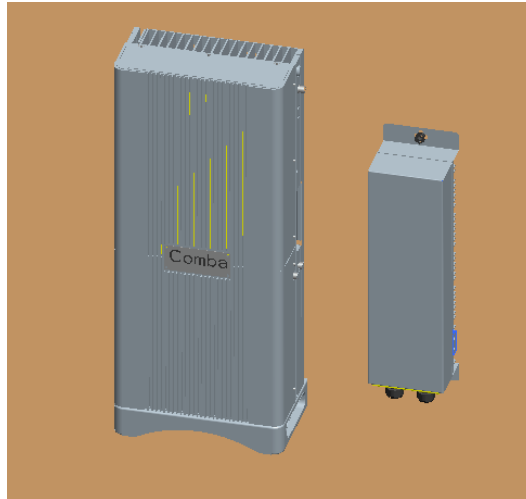

Figure 21: Install PSU on the Wall

3.3.8 DRIP-LOOP

Comba recommends that every horizontal cable entry to the equipment forms a 'U' before it's entry to the equipment. Any accumulated water on the cable will drip down at the bottom of the loop and will not climb up to the equipment.

3.4 EQUIPMENT CONNECTORS

The figures below present the connectors of ComFlex MU.

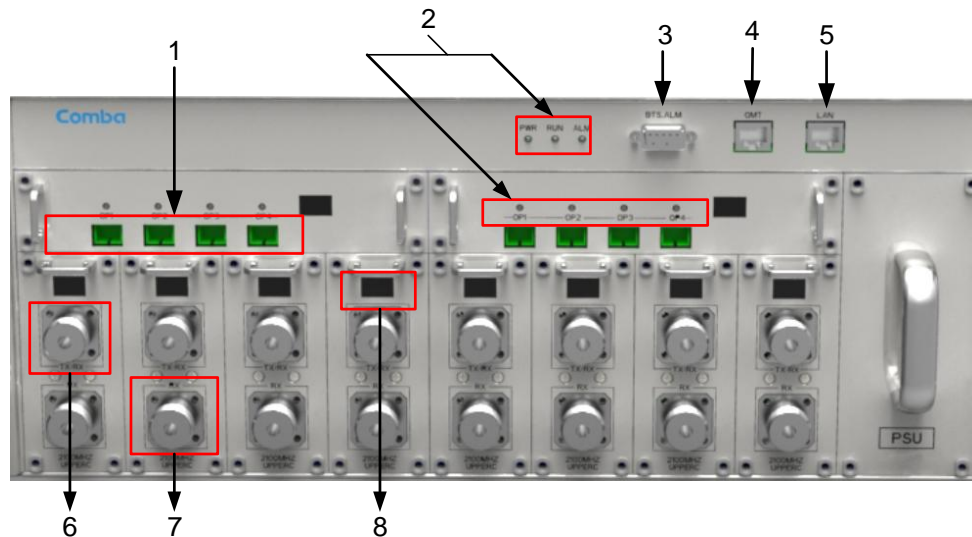

Figure 22: MU Front Panel Connectors

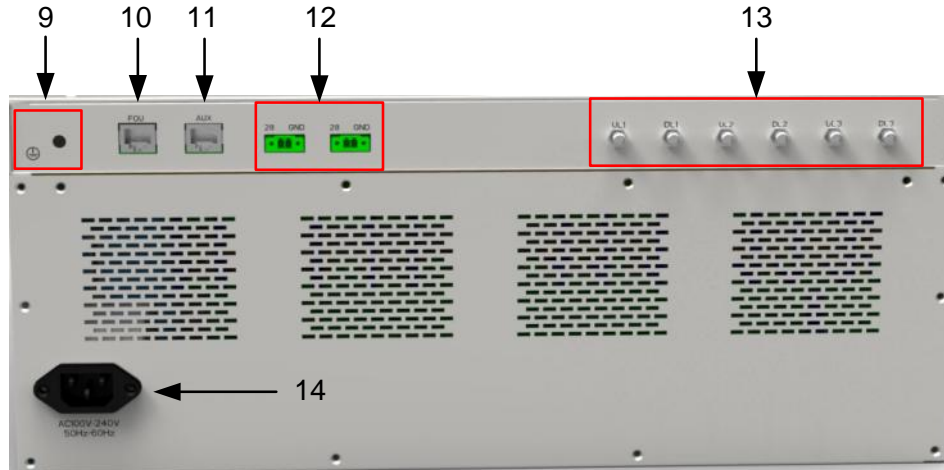

Figure 23: MU Rear Panel Connectors

Table 5: MU Connections

Identifier	Functional Description
1. OP1~OP4	SC/APC optical fiber access port
2. LED indicator	LED indicator. See Chapter 4 for the description of each indicator.
3. BTS_ALM	DB9-F connector for BTS alarm.
4. OMT	RJ45 connector connects PC with equipment for local and remote monitoring.
5. LAN	Reserved RJ45 port for remote monitoring.
6. TX/RX	RF access port, Mini Din* female connector.
7. RX	RF access port, Mini Din female connector.
8.	Digital display tube. See chapter 4 for the detailed description.
9.	Grounding connector.
10. FOU	Communication port with extension optical unit.
11. AUX	Reserved interface for source calibration unit.
12. 28 GND	Provide 28V power supply for extension units (FOU and source calibration unit).
13. UL1,DL1; UL2,DL2; UL3,DL3	QMA female connector, reserved for RF interface of extended FOU and single source calibration unit.
14. AC100~240V	AC power supply connector.

*Mini Din Female Dimension is shown in figure below.

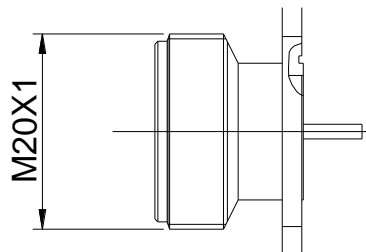

Figure 24: Mini Din Female Dimension

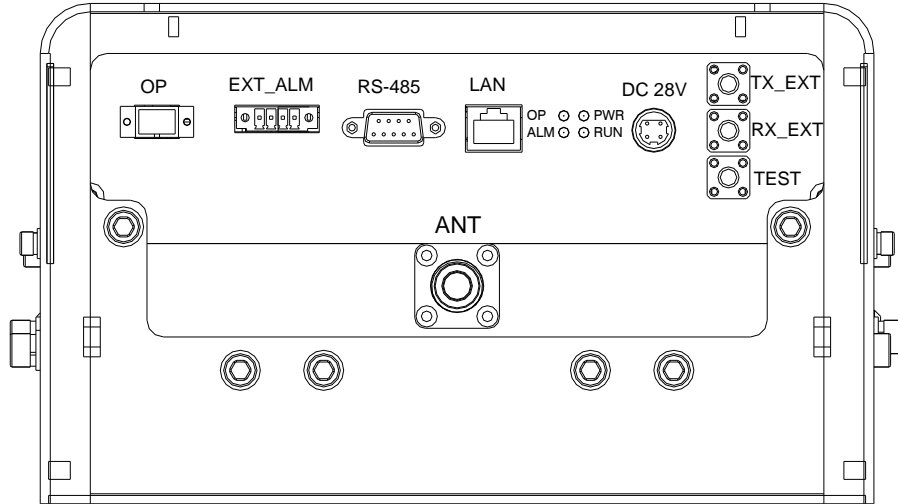

Figure 25: RU Connectors

Table 6: RU Connections

Identifier	Functional Description
ANT	MINI Din female cable connector, antenna system connection port
OP	SC/APC optical fiber access port
EXT_ALM	External alarm port. It provides an alarm report interface for other devices to report their alarms to CMS.
RS-485	Reserved.
LAN	Reserved.
DC28V	Power supply interface, connects with Power Supply Unit.
TX_EXT	QMA female connector, downlink RF coupling port.
RX_EXT	QMA female connector, uplink RF coupling port.
TEST	QMA female connector, downlink output power test port.

3.5 EQUIPMENT CONNECTION

3.5.1 GROUNDING CONNECTION

⚠ WARNING!

This unit must always be grounded. Consult an appropriate electrical inspection authority or an electrician if you are uncertain that suitable grounding is available.

Do not connect power before grounding.

3.5.2 MU GROUNDING CONNECTION

Step 1: Connect the GND cable to the GND connector and the building EARTH. Recommended GND cable size is # 12 AWG.

Step 2: Ensure the GND cable is connected to building GND.

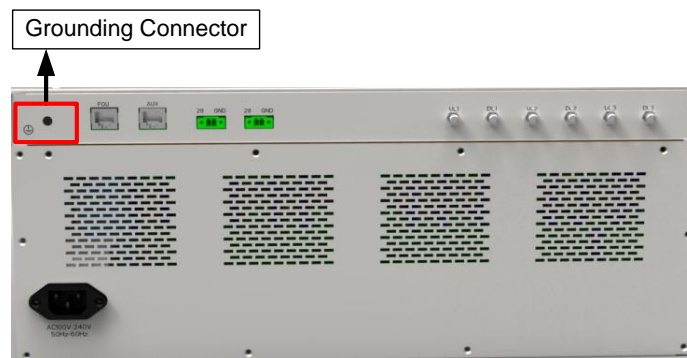

Figure 26: MU Grounding (MU Rear Panel)

3.5.3 RU GROUNDING CONNECTION

Step 1: Connect one side of the supplied copper wire GND cable to right side of RU with two M6×10 hexagon Screws (screws are provided). Connect the other side of the supplied copper wire GND cable to the building EARTH with two M6 screws (screws are not provided).

Step 2: Connect one side of the supplied copper wire GND cable to RU with two M6×10 hexagon Screws (screws are provided). Connect the other side of the supplied copper wire GND cable to the building EARTH with two M6 screws (screws are not provided).

Note: There are two GND ports on both sides of PSU, users can use one of them according to real situation.

Step 3: Ensure all GND cables are well grounded to building GND.

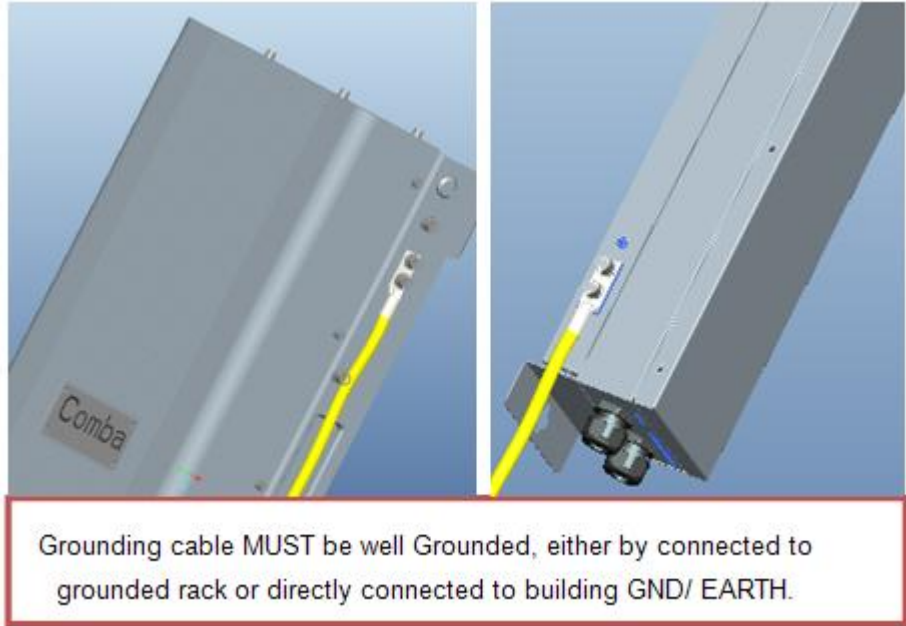

Figure 27: RU Grounding

3.5.4 MU CONNECTIONS

Step1: Connect the MU OP (optical) port to one of the RU OP port. (NOTE: requires Single Mode fiber with SC/APC connectors; MAXIMUM OPTICAL LOSS = 6.5dB)

Step 2: For duplex application, connect the MU RFU TX/RX port to the RF Source (BTS or BDA) using 50Ohm coaxial cable. For simplex application, connect the MU RFU TX/RX port to the RF Source downlink, and then connect MU RFU RX port with RF Source uplink. (NOTE: Coaxial cable must be mini-DIN Male on the MU side)

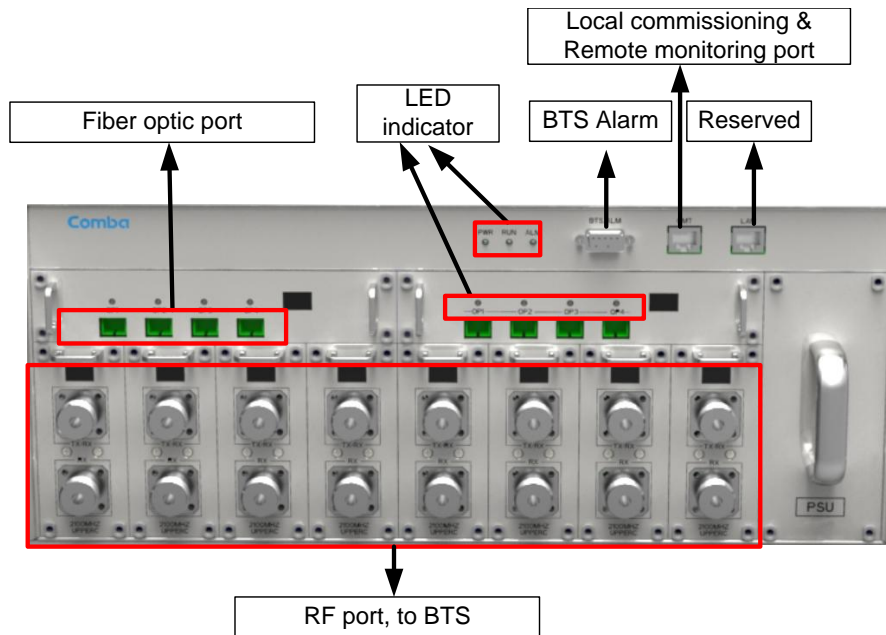

Figure 28: Fiber Optical and RF Port Connection

Step 3: Connect the power cable to the power supply port (100-240VAC, 1Amp maximum).

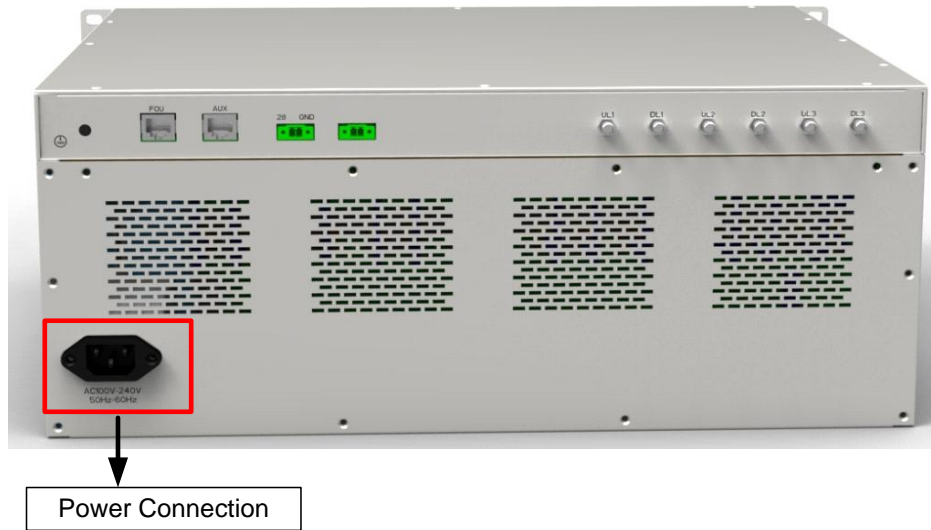

Figure 29: MU Power Connection (Rear Panel)

3.5.5 RU CONNECTION

Step 1: Connect the RU OP (optic) port to one of the OP port located on MU FOU front panel.

Step 2: Connect ANT port to a broadband antenna using 50Ohm coaxial cabel. Note: coaxial cable must be mini-D male on the RU side, antenna shoule be 50Ohm.

Step 3: Connect DC 28V port to RU Power Supply Unit DC 28V port.

Step 4: Connect power cable on PSU with the public power grid (110~220VAC, 3Amp maximum).

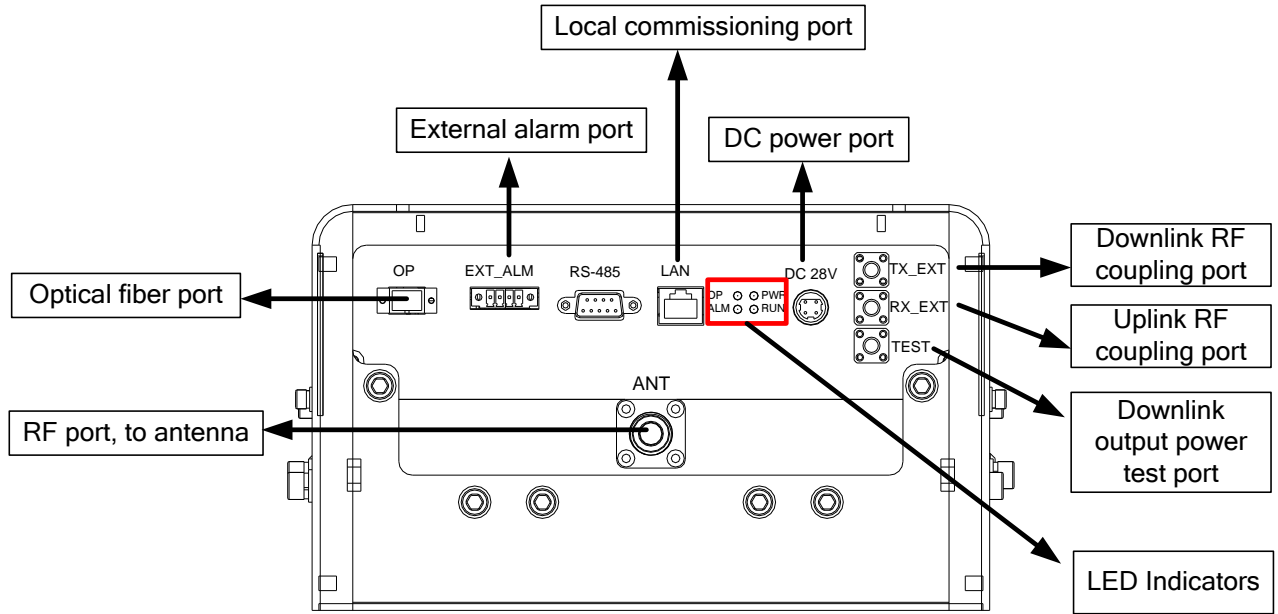

Figure 30: RU Fiber Optical and RF Port Connection

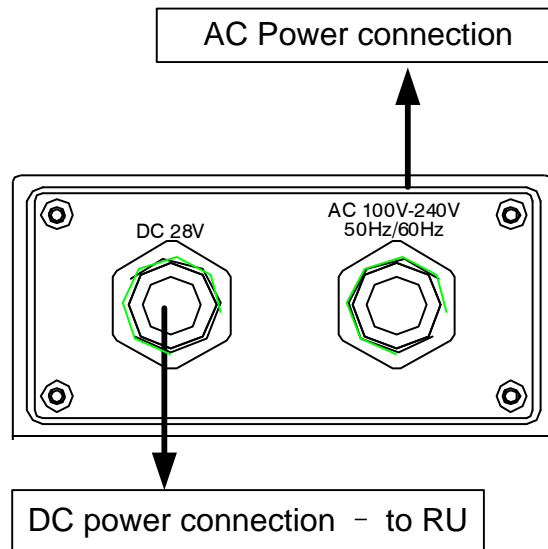

Figure 31: PSU Power Port Connection

3.5.6 RU EXTERNAL ALARM CONNECTION

For RU, this is a 4-pin connector. The following figure and table show the pin allocation and definition. Pin numbering are shown looking-into the connector on the enclosure.

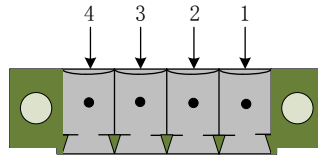

Figure 32: Pins Allocation for “EXT_ALM” Port for RU

Table 7: Pin Definition of “EXT_ALM” Port for RU

Pin number	1	2	3	4
Alarm definition	EXT. Alarm 1	GND	EXT. Alarm 2	GND

Note: Users need to configure Ext Alm 1~2 on WEB GUI to realize External Alarm (Refer to Chapter 5).

3.5.7 MU BTS ALARM CONNECTION

The equipment alarms can be signaled to the BTS via voltage-free relay contacts. The voltage-free relay connections are connected to the DB-9 port “BTS_ALAM” located on the MU. The following figure and table show the pin allocation and definition.

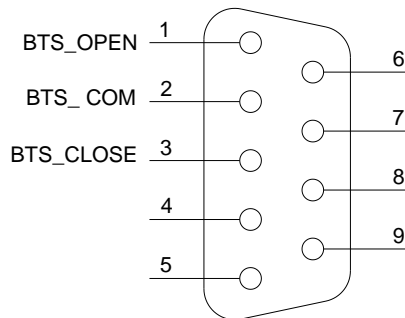

Figure 33: Pins Allocation for “BTS_ALM” Port

Table 8: Pin Definition of “BTS_ALM” Port

Pin Number	Definition	Description
1	BTS_OPEN	Connects to the open terminal of the voltage free relay.
2	BTS_COM	Connects to the common terminal of the voltage free relay.
3	BTS_CLOSE	Connects to the close terminal of the voltage free relay.
4 ~ 9	NC	Reserved.

3.5.8 CONNECT TO PC

The local commissioning and management for MU and RU is achieved through connecting to the WEB base GUI.

Connect MU to PC

Connect MU “OMT” port (RJ45) to the RJ45 port of PC with supplied Ethernet cable to achieve local monitoring and management.

End of Section

4 COMMISSIONING

4.1 PRE-COMMISSIONING TASKS

After equipment installation, perform the following steps before equipment powering and commissioning, check that the expected voltage, current, and power levels do not violate any ratings. Double check all connections including ground before applying power. Do not manipulate circuits or make changes when power is applied:

- Visually inspect the power connection within the equipment. Ensure that all cables are correctly and securely connected, including power cables, grounding wires, RF cables and optical cables.
- Check grounding connection and verify that the ground resistance is less than 5Ω.
- Connect the equipment to the PC.
- Power on MU and RU.
- Monitor the initialization of the MU and RU through the LEDs on the panel. Refer to detailed LEDs information in the next section.

4.2 LED INDICATORS

Diagnostic LEDs are located on the MU front panel and RU bottom panel; each indicates the status of a particular function:

Table 9: MU LED Indications

LED Indicator	Normal Status	Indication
PWR	Steady green	Power indicator. If LED is off, it indicates the system has no power.
RUN	Flashing green (1 time/sec)	MU operation indicator. After initialization (1~2 minutes), the LED should flash at once per sec. (When upgrade firmware, LED will flash rapidly)
ALM	OFF	Alarm indicator. If LED is RED, there is an alarm.
OP	Steady green	Located on Fiber Optical Unit (FOU), it is an indicator for receive optical power. If LED is off, it indicates the receiving optical power is less than -10dBm.

Table 10: RU LED Indications

LED Indicator	Normal Status	Indication
PWR	Steady green	Power indicator. If LED is off, it indicates the system has no power.
RUN	Flashing green (1 time/sec)	RU operation indicator. After initialization (1~2 minutes), the LED will flash once per sec. (When upgrade firmware, LED will flash rapidly)
ALM	off	Alarm indicator. If LED is RED, there is an alarm.
OP	Steady green	Located on Fiber Optical Unit (FOU), it is an indicator of Receiving optical power. If LED is off, it indicates the receiving optical power is less than -10dBm.

4.3 DIGITAL DISPLAY INDICATORS

4.3.1 DIGITAL DISPLAY ON RFU

The digital display tube on RFU shows the DL input power. The range of DL input power shown on the display tube is from -19 to 33 (dBm), when DL input power is lower than -19dBm, it will show L, when DL input power is higher than 33, it will display H.



Figure 34: RFU Digital Display

Table 11: RFU Digital Display

Figure	DL Input Power Level
L	< -19dBm
-19~33	-19~33dBm
H	> 33dBm

4.3.2 DIGITAL DISPLAY ON FOU

The digital display tube on optical module has two digits.

The first digit will display A, b, C and d which presents the No. of optical port. Refer to below figure for the relationship.

The second digit will display the optical loss of each port. See the following table for the relationship of figure and optical loss.

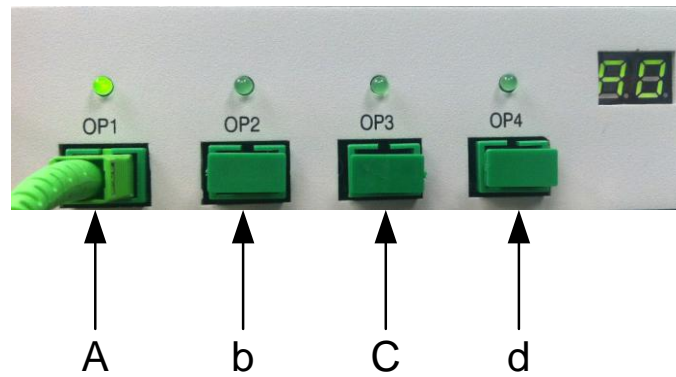

Figure 35: Optical Port No. and Digital Display

Table 12: FOU Digital Display

Figure	Optical Loss
0~9	0~9dBo
H	> 9dBo

End of Section

5 WEB GUI

ComFlex can be monitored and controlled by WEB GUI, follow below contents to achive system parameter setting and commissioning.

5.1 WEB GUI CONNECTION

Step 1: Connect MU OMT port to PC RJ45 port with the supplied Ethernet cable to set up a physical connection.

Step 2: Go to laptop Control Panel\Network and Internet\Local Area Connection. Right click it and click Properties. Then follow the steps shown in figure below.

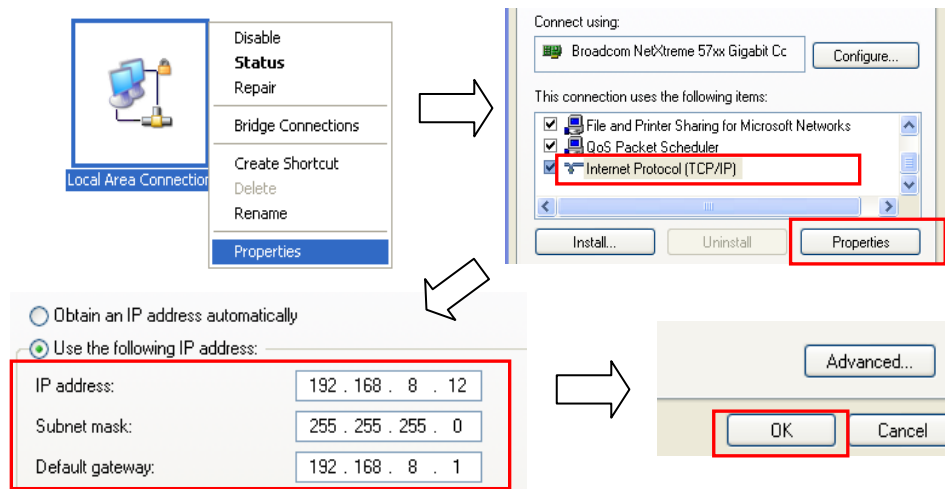

Figure 36: PC IP Address Setting

Step 3: Open browser (browser IE7.0, IE8.0, Chrome or Firefox, suggest disply resolution is 1024x768), input Web GUI **IP address: 192.168.8.101**, click [Enter].

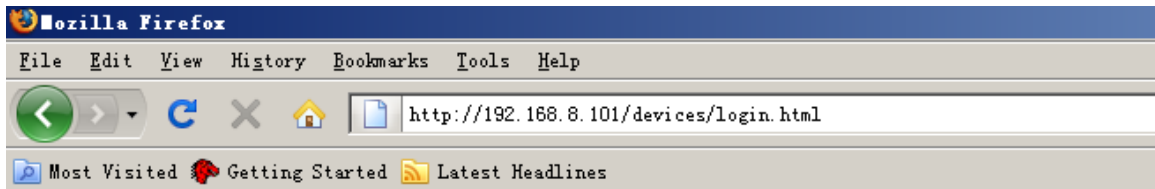

Figure 37: Input IP Address

Step 2: Input **User Name: admin; Password** (default password: **admin**). Click [Log in].



Figure 38: Input User Name and Password

5.2 WEB GUI INTRODUCTION

After log in, the Web GUI main screen will appear.



Figure 39: Web GUI Main Screen

On Comba Web GUI Home page, there are four Menu bars:

[Devices], [Commissioning], [Firmware] and [Management].

5.2.1 [DEVICES]

The [Devices] page shows the actual connection diagram of MU and RU.

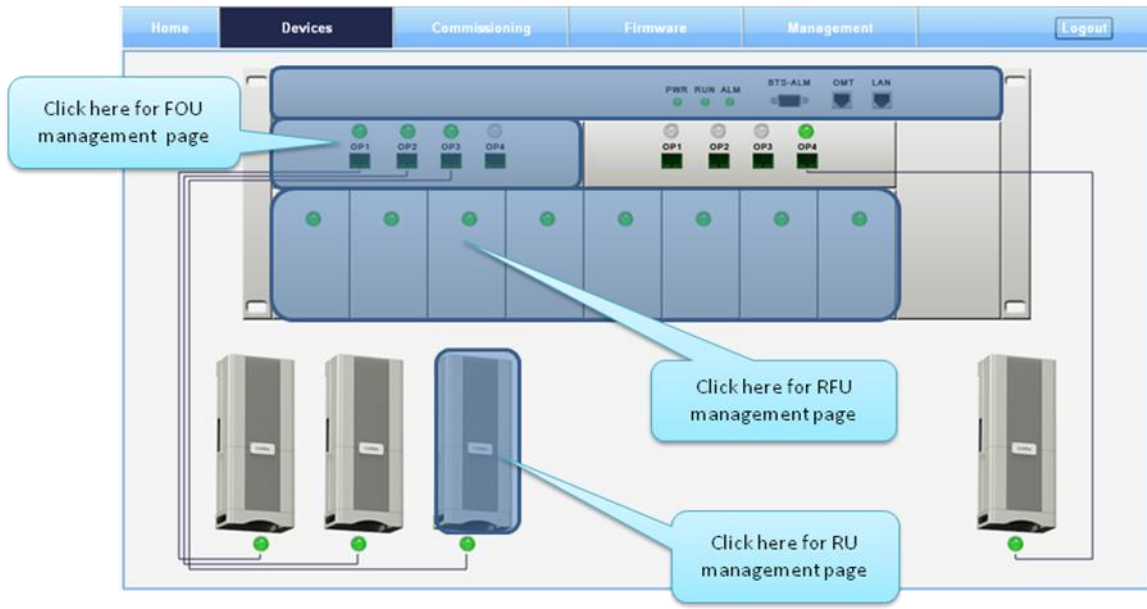

Figure 40: [Devices] Screen

MU Main Management Screen

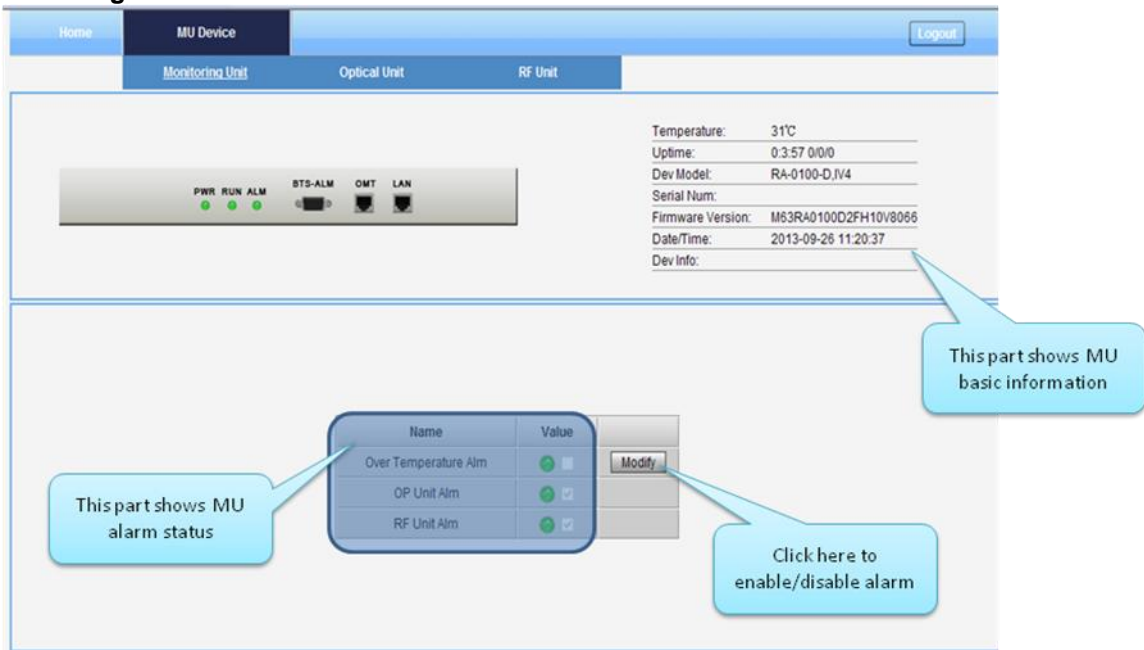

Figure 41: MU Device - Monitoring Unit

Optical Unit Management Screen

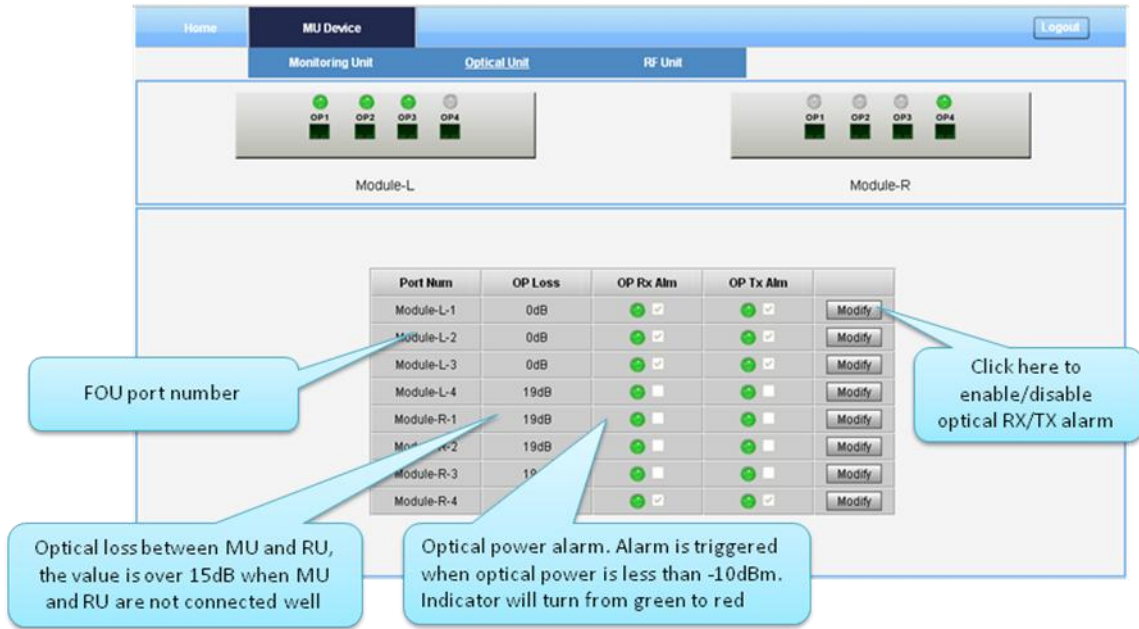

Figure 42: MU Device - Optical Unit

Note: MU transmit optical power is -4~-2dBm.

RF Unit Management Screen

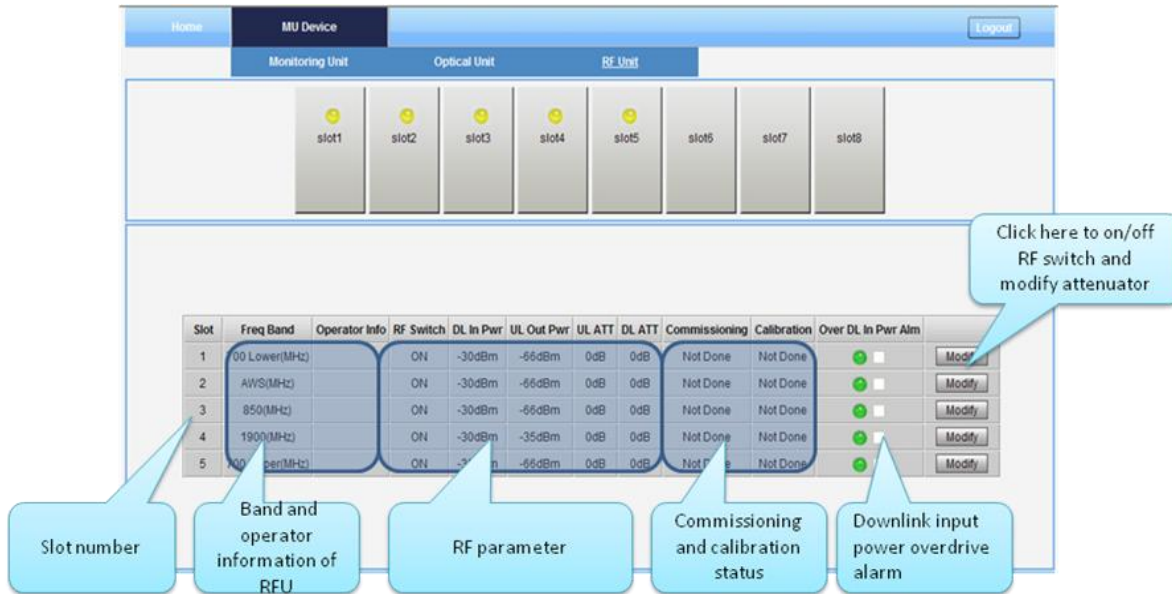

Figure 43: MU Device - RF Unit

Remote Unit Management Screen

Click RU photo, users can visit RU directly. Make sure two steps are done before visit RU:

- ✓ RU and MU are connected by optical fiber.
- ✓ RU device scanning is done. Note: Go to [Commissioning] page or [Management] page for device scanning.

This part shows RU basic information

Select band to check relative band information

Band information table

RU common information table

Name	700	800&850	1900	AWS
DL Output Power	-15dBm	-13dBm	-14dBm	-15dBm
UL LNA Alm	<input checked="" type="checkbox"/>	<input checked="" type="checkbox"/>	<input checked="" type="checkbox"/>	<input checked="" type="checkbox"/>
DL PA Alm	<input checked="" type="checkbox"/>	<input checked="" type="checkbox"/>	<input checked="" type="checkbox"/>	<input checked="" type="checkbox"/>
Over DL Out Pwr Alm	<input checked="" type="checkbox"/>	<input checked="" type="checkbox"/>	<input checked="" type="checkbox"/>	<input checked="" type="checkbox"/>
Protection Shutdown Alm	<input checked="" type="checkbox"/>	<input checked="" type="checkbox"/>	<input checked="" type="checkbox"/>	<input checked="" type="checkbox"/>
Commissioning	Success	Success	Success	Not Done
Calibration	Success	Success	Success	Not Done
PA Service Status	Normal	Normal	Normal	Normal

Name	Value
OP Loss	0dB
OP Tx Power	3.7dBm
OP Rx Power	-3.8dBm
UL ALC Switch	ON <input type="button" value="Modify"/>
Over Temperature Alm	<input checked="" type="checkbox"/> <input type="button" value="Modify"/>
OP Rx Alm	<input checked="" type="checkbox"/> <input type="button" value="Modify"/>
OP Tx Alm	<input checked="" type="checkbox"/> <input type="button" value="Modify"/>

Figure 44: RU Device

NOTE: There are three statuses for PA Service: **Normal**, **Recovery** and **Shutdown**. If PA output power or reflected power exceeds the threshold (32dBm), software will trigger Recovery:

- It will reset PA and then re-detect the PA output power and reflected power, if they are normal, the PA Service Status will turn to **Normal**, if PA output power or reflected power is still over the threshold, PA Service Status will turn to **Recovery** again.
- If PA output power or reflected power is still over the threshold after six times of PA Recovery, PA Service status will be **Shutdown** which will need to be reset manually. Reset at Management > PA Reset.

Click on a specific band on the left side of RU Device page, the corresponding band information will show.

Select 700MHz band

700MHz RF parameter setting table

700MHz alarm information and configuration table

Name	Value
DL Output Power	-15dBm
RF Switch	ON <input type="button" value="Modify"/>
UL ATT(LowerABC)	0dB <input type="button" value="Modify"/>
UL ATT(UpperC)	0dB <input type="button" value="Modify"/>
DL PA Alm	<input checked="" type="checkbox"/> <input type="button" value="Modify"/>
Over DL Out Pwr Alm	<input checked="" type="checkbox"/> <input type="button" value="Modify"/>
Protection Shutdown Alm	<input checked="" type="checkbox"/> <input type="button" value="Modify"/>

Figure 45: RU Device – 700

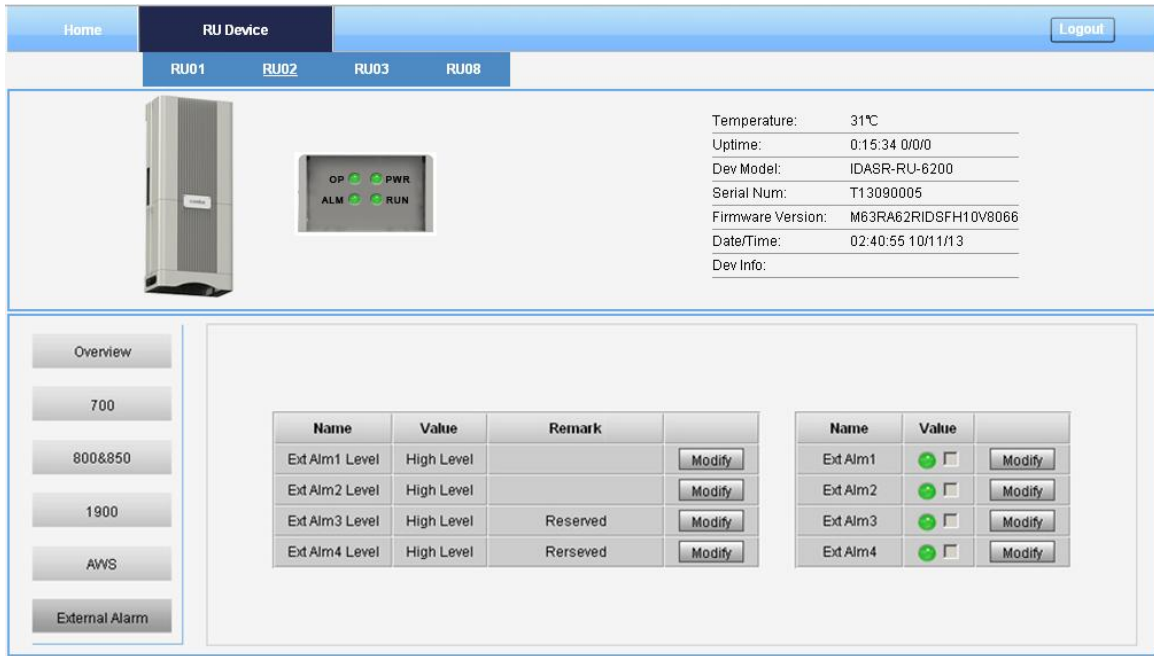

Figure 46: RU Device – External Alarm

5.2.2 [COMMISSIONING]

A work flow of the commissioning process is shown on [Commissioning] page. Click the [Start] button, the software will guide you through the commissioning step by step. For details, please refer to chapter 5.3.

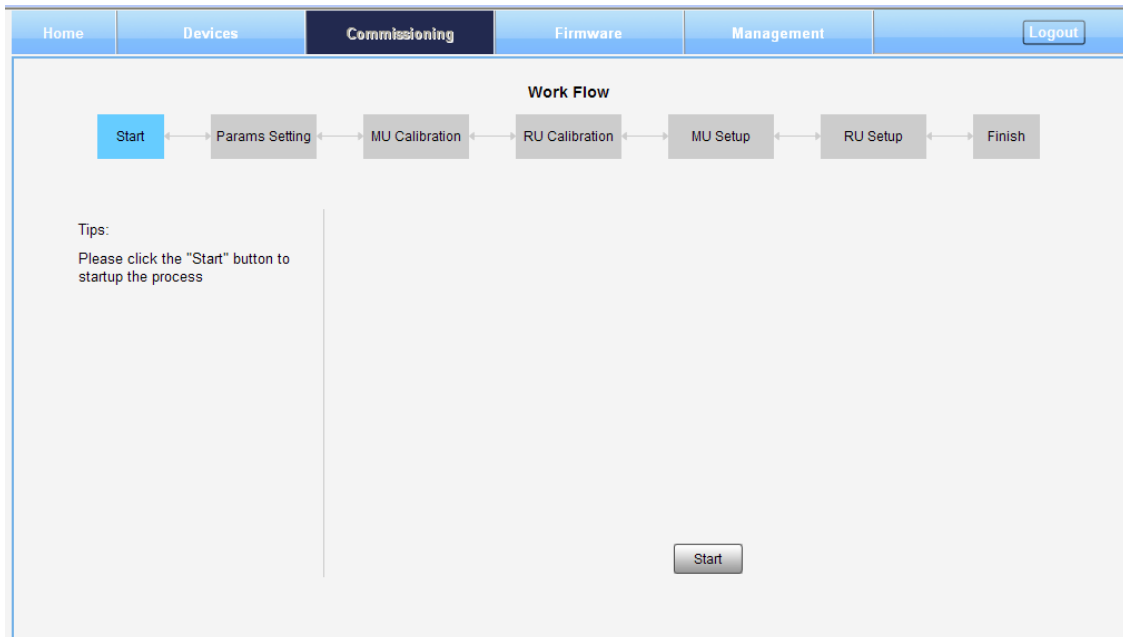

Figure 47: [Commissioning] Screen

5.2.3 [FIRMWARE]

There are two functions on the [Firmware] bar: [upgrade] and [swap]. [Upgrade] is used to upgrade software, and [Swap] is to replace current firmware version to the previous one.

Follow steps shown in below figure to upgrade firmware.

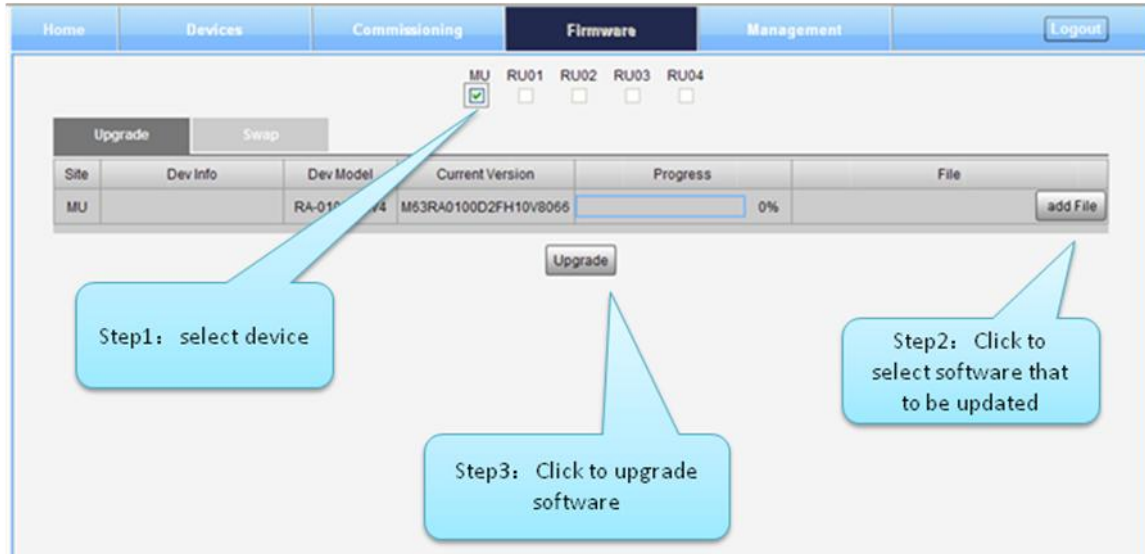

Figure 48: [Firmware] Screen - Upgrade

Step 4: After clicking , a window will pop up and click .

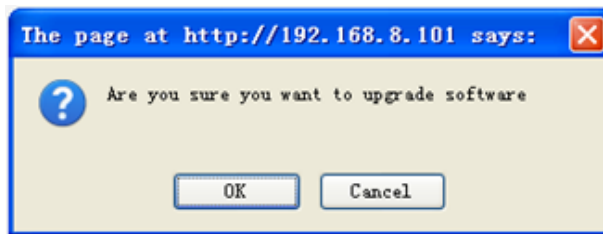

Figure 49: [Firmware] Screen – Pop-up Window 1

Step 5: Wait for 2~4 minutes while MU/RU is being reset.

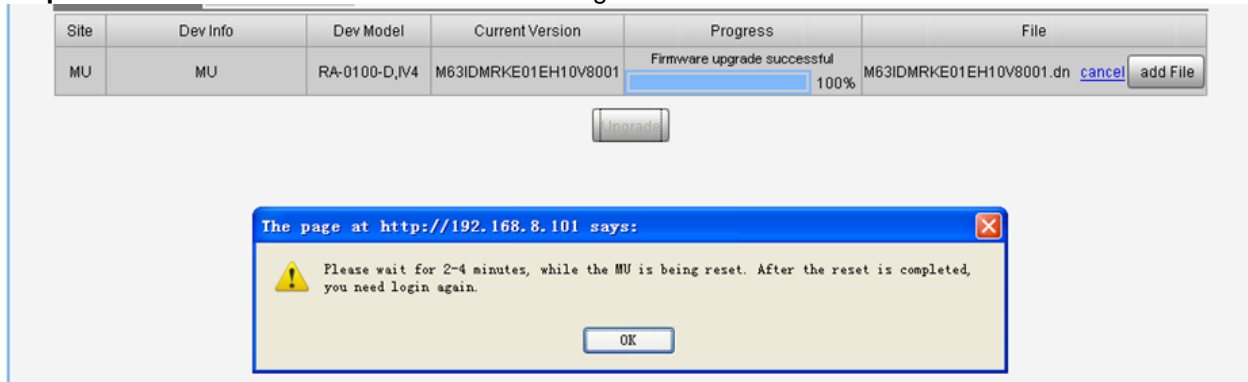

Figure 50: [Firmware] Screen – Pop-up Window 2

Step 6: Clear browsing history and cookies from browser.

NOTE: For MU software upgrade, users need to re-login Web GUI after reset is done.

Follow steps shown in below figure to Swap firmware.

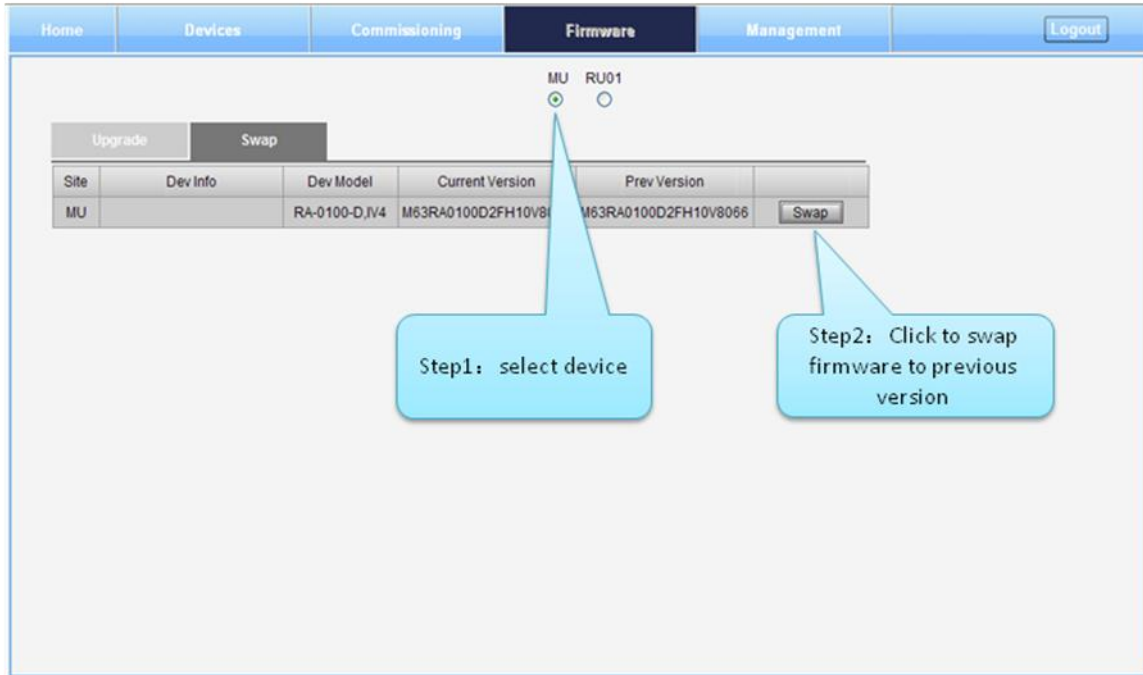

Figure 51: [Firmware] Screen - Swap

5.2.4 [MANAGEMENT]

Other parameters can be configured on [Management] page.

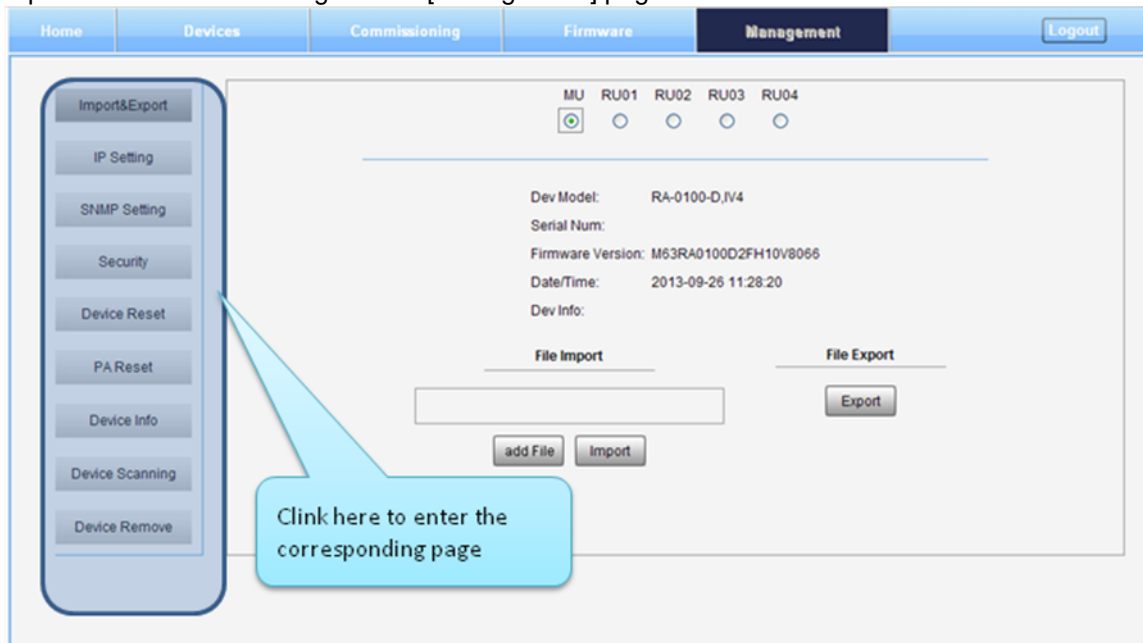

Figure 52: [Management] Screen

There are nine function bar list in the left side of the [Management] page. Below figures are the introduction of each function bar.

➤ **Inport&Export**

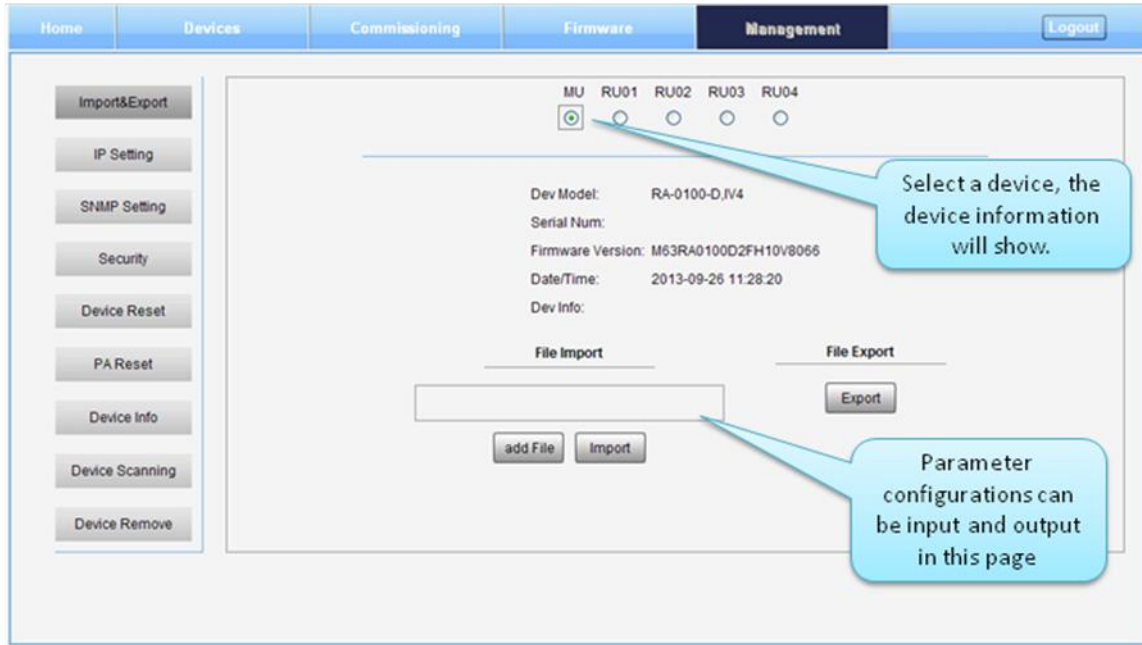

Figure 53: Management – Import&Export

Blow table list the parameters that can be import/export:

Table 13: Import/Export Parameters

Device	Paremeter	Device	Parameter
MU	Alarm Enable	RU	Alarm Enable
	ATT value		ATT value
	RF Switch		RF Switch
	SNMP parameter		Over temperature alarm threshold
			DL over output power threshold
			External Alarm level

Import and Export can help users quickly configure MU and RU parameters. For example, if one MU/RU finished configuration, users can export its parameters and save as a file in PC, and then import this file to other MU/RU to fast finish the MU/RU parameter setting.

➤ IP Setting

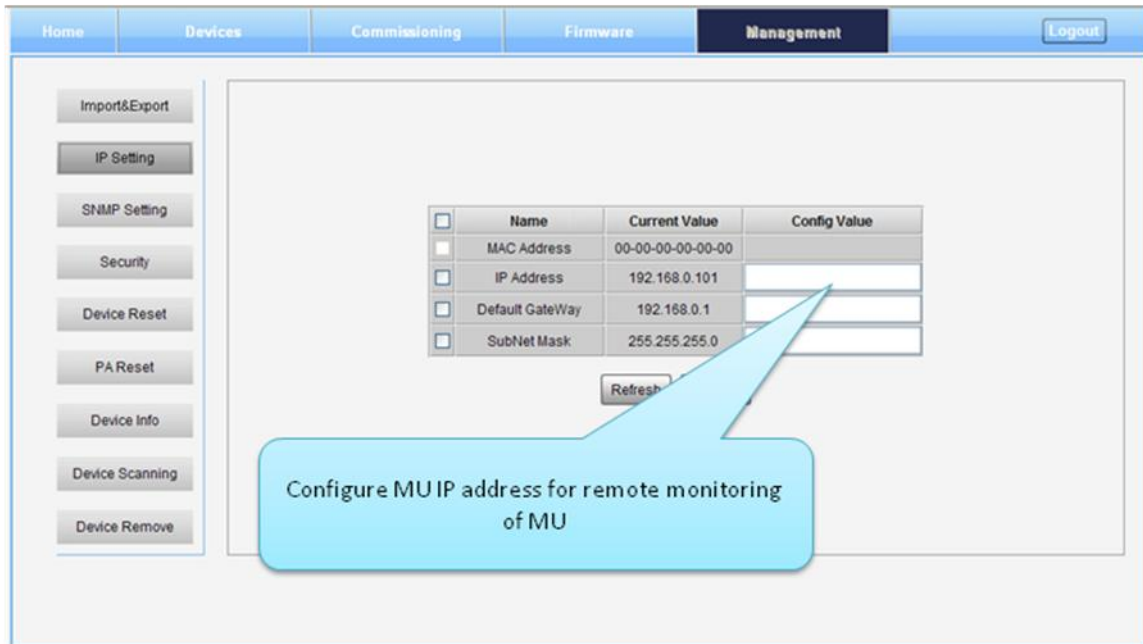

Figure 54: Management – IP Setting

Note: For remote monitoring, the IP Address must be set correctly according to the location IP of remote connection. If more than one equipment is connected to the public network through the same router, the router's local IP **CANNOT** be set as 192.168.8.*.

➤ SNMP Setting

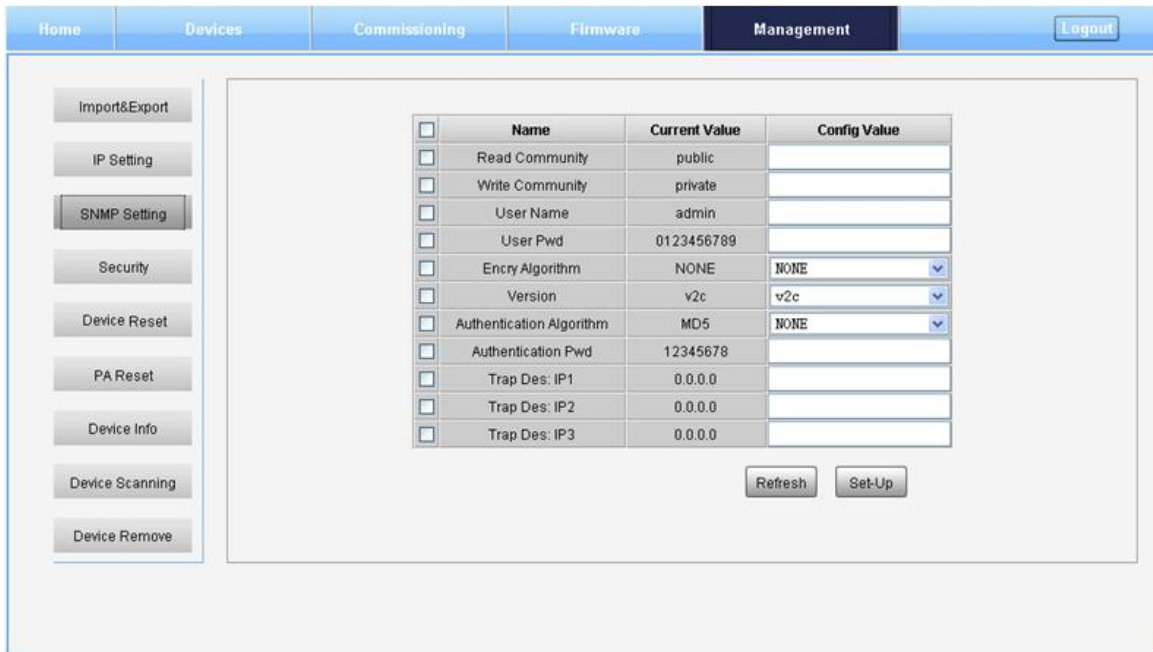

Figure 55: Management – SNMP Setting

➤ Security

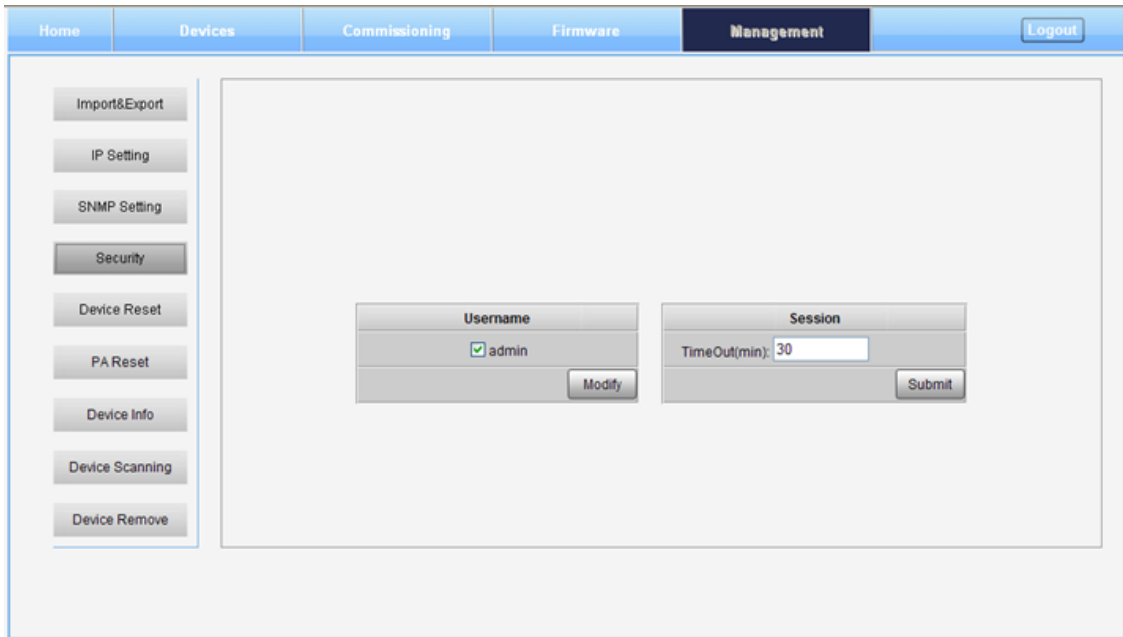

Figure 56: Management – Security

Click , [Modify Password] window will pop-up.

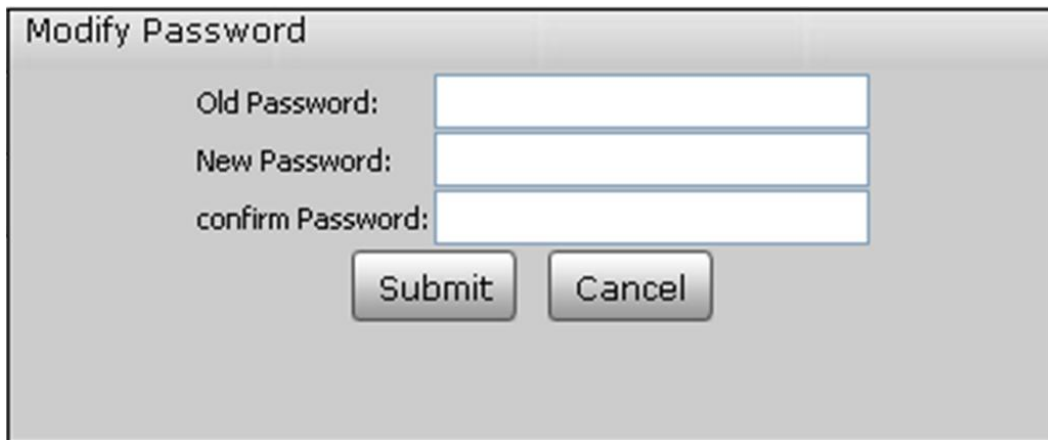

Figure 57: Modify Password

Note: Username cannot be modified.

➤ **Device Reset**

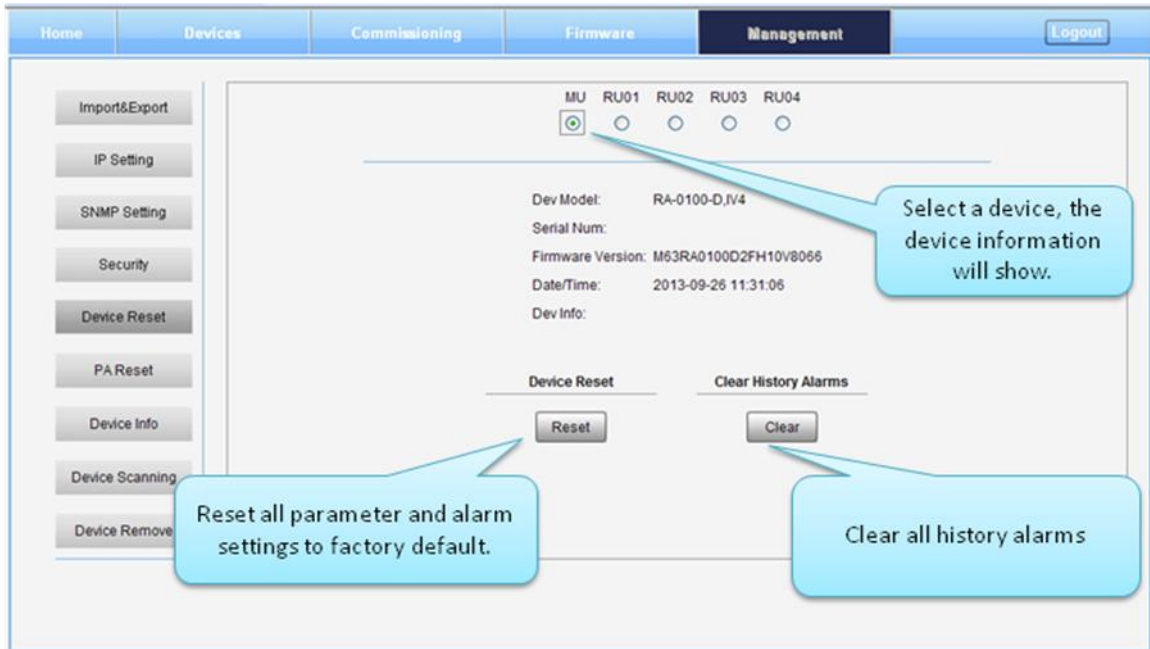

Figure 58: Management – Device Reset

Note: Device Reset process will last about 2~4 minutes. For MU monitor reset, users need to re-login WEB GUI.

➤ **PA Reset**

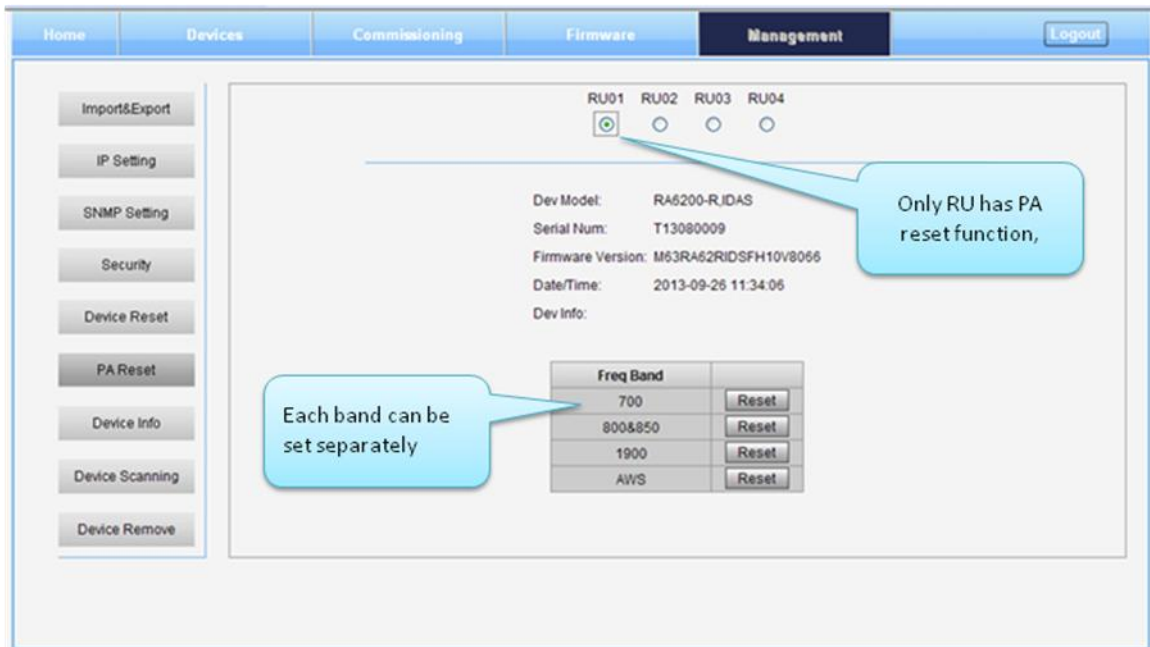

Figure 59: Management – PA Reset

Note: PA will be turned off by software when PA output power or (VSWR) reflected power is exceed the threshold. Users need to reset PA after debugging.

➤ **Device Info**

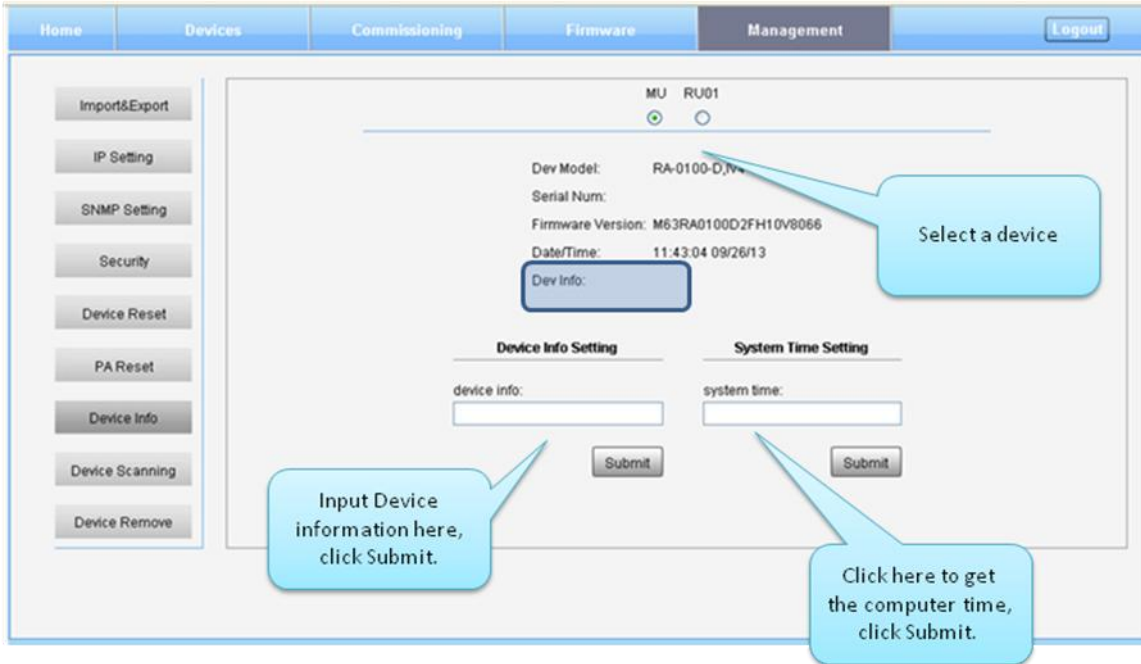

Figure 60: Management – Device Info

Note: Users can input maximum 30 bytes characters in Device Info.

➤ **Device Scanning**

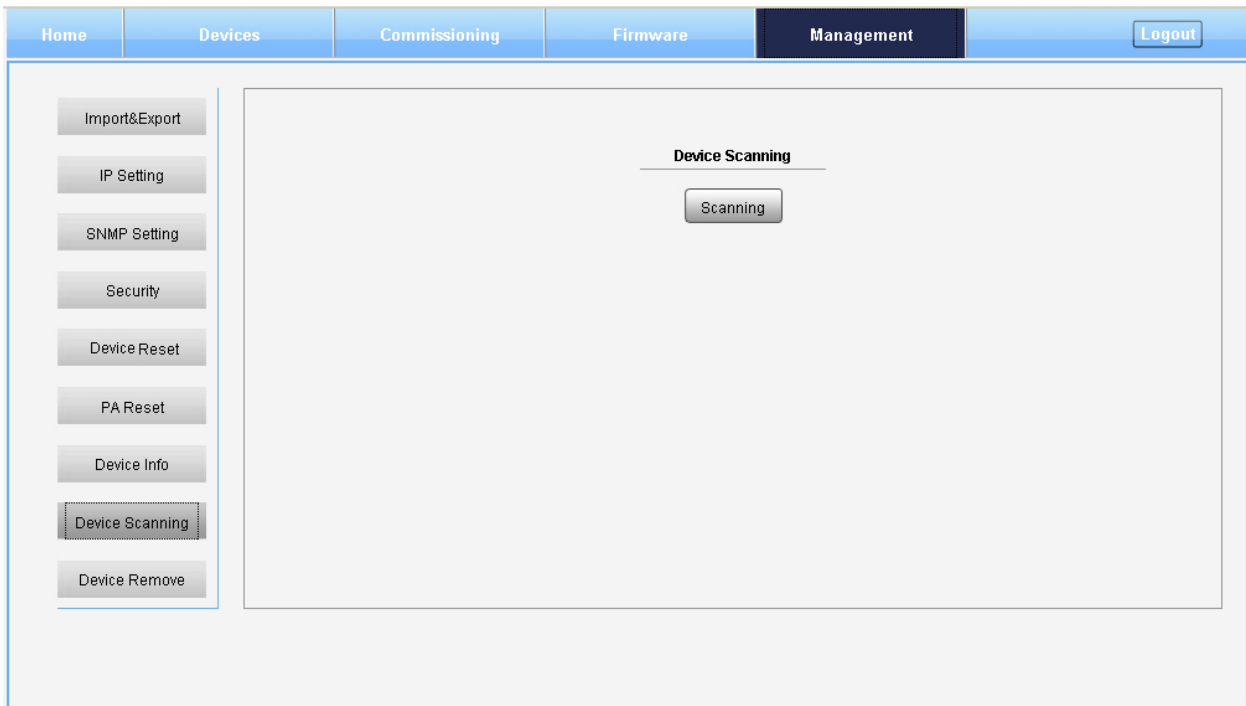

Figure 61: Management – Device Scanning

Note: This Step is the same as step1 of [Commissioning]. Running scanning, software will allocate an ID to RU so that MU can identify and visit it.

➤ **Device Remove**

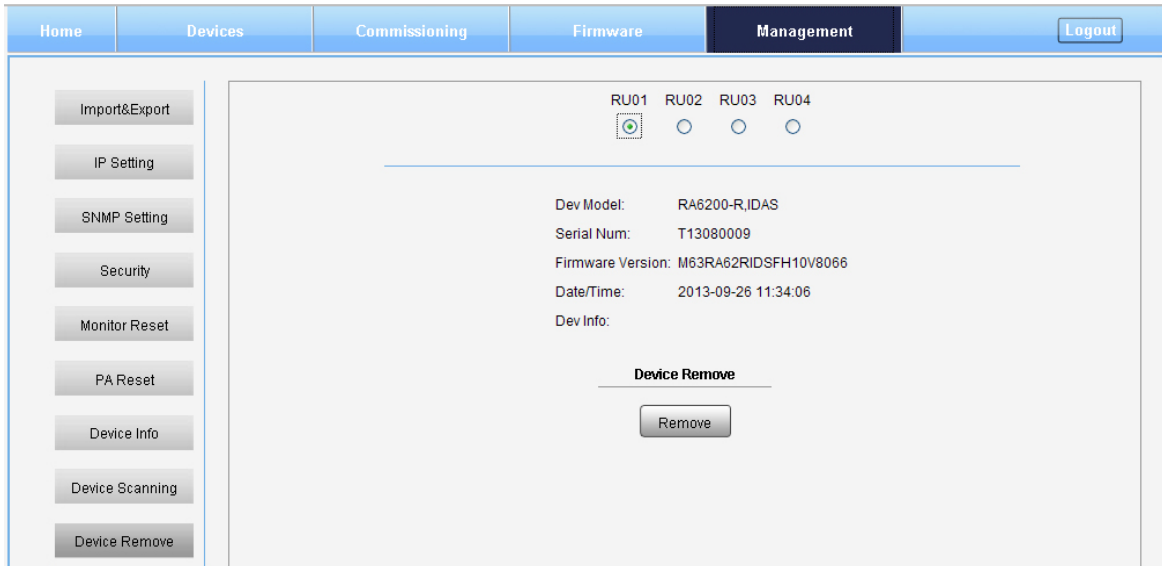

Figure 62: Management – Device Remove

Note: If the RU has been scanned and identified by MU, to remove the RU from the system, users **must** remove this RU on this [Device Remove] page, otherwise, RU will still be shown on the Home page and will trigger optical alarm.

5.3 COMMISSIONING PROCEDURE

To complete the installation and commissioning, users need to follow the steps below.

Step 1: Click Menu bar [Commissioning] on home page, a work flow will show up.

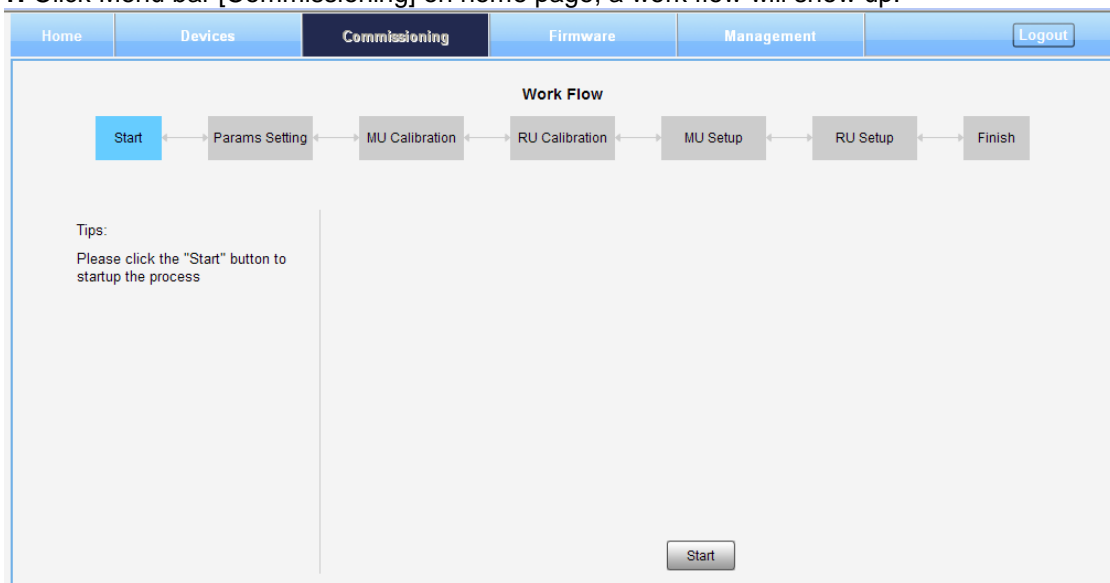



Figure 63: Commissioning Procedure - Start

Step 2: Click  to start RU device scan, this step will take about 1 minute.

Working Flow

Start → Params Setting → MU Calibration → RU Calibration → MU Setup → RU Setup → Finish

Tips:
Scanning Finish

RU	Serial Num	State
FF		Abnormal
FF		Abnormal
FF		Abnormal
FF		Abnormal
FF		Non Exist
FF		Non Exist
FF		Non Exist
FF		Non Exist



Scanning Before

RU	Serial Num	State
FF		Abnormal
02	T13080001	Normal
03	T13080002	Normal
04	T13080003	Normal
FF		Non Exist
FF		Non Exist
FF		Non Exist
FF		Non Exist

Scanning After

Back Next

Figure 64: Commissioning Procedure – Device Scan

Step 3: Click  to enter to Params Setting page. Click , users can set the device information and system time.

Work Flow

Start → Params Setting → MU Calibration → RU Calibration → MU Setup → RU Setup → Finish

Tips:
1 Modify devices information
2 After modification, please click "Next" button

Site	Dev Info	Date/Time	
MU		2013-09-26 11:24:01	Modify
RU01		2013-09-26 11:25:56	Modify
RU02		2013-09-26 11:20:56	Modify
RU03		2013-09-26 11:26:20	Modify
RU04		2013-09-26 11:26:20	Modify

Back Next

Figure 65: Commissioning Procedure – Params Setting

Commissioning			
<input type="checkbox"/>	Name	Current Value	Config Value
<input type="checkbox"/>	Dev Info		<input type="text"/>
<input type="checkbox"/>	Date/Time	2013-09-26 11:25:56	<input type="text"/>

Figure 66: Dev Info & Date/Time

Dev Info mainly used to record device location and Date/Time provide a time reference. Mouse click the Config Value of Date/Time to auto receive the computer time.

NOTE: Make sure all the ANT ports of RUs are connected with dummy load or antenna system before proceeding to step 4.

Step 4: Click to enter to MU Calibration page after finishing Params Setting.

- ✓ Select a frequency band that need to calibrate from the table in the middle of the page.
- ✓ Read Tip1 on the left side and click of Tip 1
- ✓ Input signal to a RF port of RFU which you want to calibrate.
- ✓ Read Tip2 on the left side and enter the input power in the box (Suggested input power 10-30dBm). Input power has to be >10dBm for successful calibration.
- ✓ Click .
- ✓ Tip of MU calibration finish will show up on the left of the page, and calibration results will show in the table.
- ✓ NOTE: Each RFU needs to be calibrated; click "More" at last step of process to calibrate next RFU.

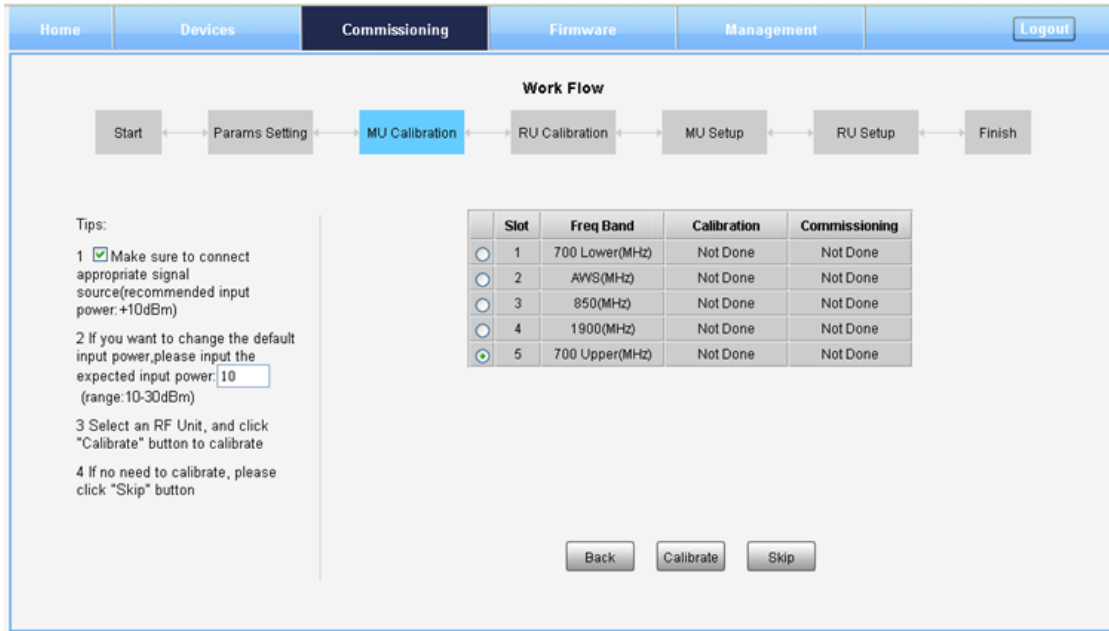

Figure 67: Commissioning Procedure – MU Calibration



Figure 68: Commissioning Procedure – MU Calibration Finish

NOTE1: Calibration is to adjust MU and RU gain to assure that make sure system gain is 20dB, if the band have been calibrated, users can click to skip the process; if the band never been calibrated, users click in the step of MU Calibration and RU Calibration, software can still procede to the next step of MU and RU setup, but the system gain will be a little deviation with 20dB, so the final output power will be not same with the target DL output power.

NOTE2: If there are more than one same band access to MU, then each access need to be calibrated in MU Calibration step, while in RU Cablibration step, users only need to calibrate the band one time, because all the same band shares the same PA.

Step 5: Click to enter to RU Calibratiion page, refer to step 4 to finish RU calibration.

NOTE1: Make sure the ANT port of RU is connected with dummy load or antennas before Calibration. Several RU can be calibrated simultaneously.

NOTE2: You can calibrate one RU or calibrate all the RUs at one time. Click "site" in RU table to select all RUs.

Work Flow

Start → Params Setting → MU Calibration → **RU Calibration** → MU Setup → RU Setup → Finish

Tips:

- 1 Make sure to connect appropriate signal source(recommended input power:+10dBm)
- 2 If you want to change the default input power,please input the expected input power: 10 (range:10-30dBm)
- 3 Make sure the MU has been calibrated, if not, RU can not be calibrated
- 4 Select RU, and click "Calibrate" button to calibrate
- 5 If not need to calibrate, please click "Skip" button

Freq Band:700 Upper(MHz)

<input type="checkbox"/>	Site	Serial Num	OP AGC	Calibration	Commissioning
<input checked="" type="checkbox"/>	RU01	T13080009	Success	Not Done	Not Done
<input type="checkbox"/>	RU02	T13080001	Success	Not Done	Not Done
<input type="checkbox"/>	RU03	T13080002	Success	Not Done	Not Done
<input type="checkbox"/>	RU04	T13080003	Success	Not Done	Not Done

Buttons: Back, Calibrate, Skip

Figure 69: Commissioning Procedure – RU Calibration

Tips:

RU calibration finished

Freq Band:700 Upper(MHz)

<input type="checkbox"/>	Site	Serial Num	OP AGC	Calibration	Commissioning
<input checked="" type="checkbox"/>	RU01	T13080009	Success	Success	Not Done
<input type="checkbox"/>	RU02	T13080001	Success	Not Done	Not Done
<input type="checkbox"/>	RU03	T13080002	Success	Not Done	Not Done
<input type="checkbox"/>	RU04	T13080003	Success	Not Done	Not Done

Figure 70: Commissioning Procedure – RU Calibration Finish

Step 6: Click to enter to MU Setup page after finishing RU calibration.

Work Flow

Start → Params Setting → MU Calibration → RU Calibration → **MU Setup** → RU Setup → Finish

Tips:

- 1 Click the "Setup" button to set commissioning parameters
- 2 If no need to setup, please click "Next" button

Freq Band:700 Upper(MHz)

Operator Info	RF Switch	DL Input Power	Commissioning
	ON	10dBm	Not Done

Buttons: Back, Next

Figure 71: Commissioning Procedure – MU Setup

Click  to set band related information.

Commissioning

<input type="checkbox"/>	Name	Current Value	Config Value
<input type="checkbox"/>	Operator Info		<input type="text"/>
<input type="checkbox"/>	RF Switch	ON	ON <input type="button" value="v"/>
<input type="checkbox"/>	DL Input Power	10dBm	<input type="text"/>

Figure 72: MU Frequency Band Table

Three parameters need to be set in this step.

- ✓ Operator Info: record the operator information of this RU unit.
- ✓ RF Switch: Set the RF switch status of this RF unit.
- ✓ DL Input Power: Input Power of the BTS signal access to this RF unit. Note: ComFlex system reaches its rated output power (30dBm) when input power is +10dBm, if DL Input Power is over 10dBm, software will autoadjust the internal attenuator to make RU output power reach rated Power. (Input power range: 10-30dBm).

Step 7: Click  to enter to RU Setup page after finishing MU setup.

Home Devices **Commissioning** Firmware Management

Work Flow

↔ ↔ ↔ ↔ ↔ ↔

Tips:
1 Click the "Setup" button to set commissioning parameters per RU

Freq Band: 700 Upper(MHz)

Site	RF Switch	Target DL Output Power	Commissioning	
RU01	ON	30dBm	Not Done	<input type="button" value="Setup"/>
RU02	ON	30dBm	Not Done	<input type="button" value="Setup"/>
RU03	ON	30dBm	Not Done	<input type="button" value="Setup"/>
RU04	ON	30dBm	Not Done	<input type="button" value="Setup"/>

Figure 73: Commissioning Procedure – RU Setup

Click  to set band related information of RU.

Commissioning			
<input type="checkbox"/>	Name	Current Value	Config Value
<input type="checkbox"/>	RF Switch	ON	ON
<input type="checkbox"/>	Target DL Output Power	30dBm	

Figure 74: RU Frequency Band Table

Two parameters need to be set in this step.

- ✓ RF Switch: Set the RF switch status of Remote Unit.
- ✓ Target DL Output Power: Expected DL output power setting. Note: Rated output power of ComFlex system is 30dBm, when Target DL Output Power is set less than 30dBm, software will auto adjust RU gain to make the RU output power reach the expected Power.

Step 8: Click to enter to [Finish] page after finishing RU setup. Click to calibrate other bands. Click if all bands' clibration is done.

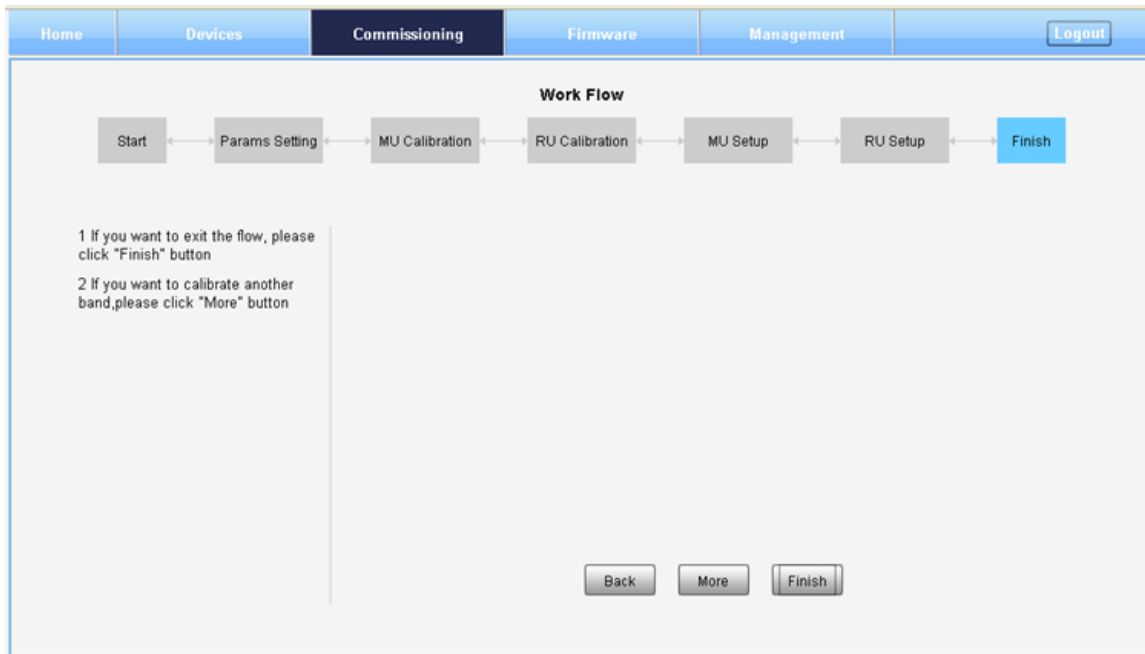

Figure 75: Commissioning Procedure – Finish

Note:

As the system calibration process is calibrated for single channel, so if there is more than one same band input, because of the power superposition, the band total output power will higer than target DL output power after the calibration is complete.

The calibration work is mainly to set device to reach it's theoretical gain, so when there are two or more same bands access into and they have the same input power level, each channel will reach it's rated

power, so the total output power will be $(\text{input A} + \text{gain}) + (\text{input B} + \text{gain}) + \dots + (\text{input N} + \text{gain})$. For example, if there are two 1900MHz bands access to MU, each has 10dBm input power, the total output power of RU 1900MHz will be $30\text{dBm} + 30\text{dBm} = 33\text{dBm}$.

For Multi-channel same band access, 800+850 (which share the same PA) access and 700 Uper C + LowerABC (also shared PA), they all will have power superposition. In this situation, users need to adjust system gain manually; otherwise, the output power will be higher than 32dBm which will trigger alarms (See Chapter 6 for details).

Refer to the method below for the gain adjustment:

Suppose a band with N independent inputs, each input signal power are all X dBm. Apparently, there exists the following relationship between input and output after finished auto communication on WEB GUI: $X \text{ dBm} + \text{Gain} = 30\text{dBm}$, then the total output power for N channels access is $X \text{ dBm} + \text{Gain} + 10 * \text{Log}(N) = 30 + 10 * \text{Log}(N)$, so Users need to set $10 * \text{Log}(N)$ RFU ATT on WEB GUI for each channel.

End of Section

6 ALARMS AND TROUBLESHOOTING

6.1 ALARMS

Table 14: MU Alarm List

Alarm List	Alarm Condition
Over-Temperature Alarm	<ul style="list-style-type: none"> Alarm when equipment temperature is higher than the threshold, otherwise normal; Alarm judgment period: 3 minutes by default; Alarm threshold : 80°C by default.
Optical Tx Alarm	<ul style="list-style-type: none"> Alarm when Optical Transmitting power is lower than the threshold, otherwise normal; Alarm judgment period: 3 minutes by default; Alarm threshold: -7dBm by default.
Optical Rx Alarm	<ul style="list-style-type: none"> Alarm when Optical received power is lower than the threshold, otherwise normal; Alarm judgment period: 3 minutes by default; Alarm threshold: -10dBm by default.
DL Input Power Overload Alarm	<ul style="list-style-type: none"> Alarm when DL input power is higher than the threshold, otherwise normal; Alarm judgment period: 3 minutes by default; Alarm threshold: 32dBm by default.

Table 15: RU Alarm List

Alarm List	Alarm Condition
External Alarm	<ul style="list-style-type: none"> Alarm status when the external terminals have the same H/L level with alarm level, otherwise normal; Alarm period: 10s by default.
Over-Temperature Alarm	<ul style="list-style-type: none"> Alarm when equipment temperature is higher than the threshold, otherwise normal; Alarm judgment period: 3 minutes by default; Alarm threshold : 80°C by default.
Optical Tx Alarm	<ul style="list-style-type: none"> Alarm When optical transmitting power is lower than the threshold, otherwise normal; Alarm judgment period: 3 minutes by default; Alarm threshold: 0dBm by default.
Optical Rx Alarm	<ul style="list-style-type: none"> Alarm When optical receiving power is lower than the threshold, otherwise normal; Alarm judgment period: 3 minutes by default; Alarm threshold: -14dBm by default.
PA Alarm	<ul style="list-style-type: none"> Alarm when any one of the PA Current Alarm, PA Over-temperature Alarm, PA DL output power overload Alarm, Reflection Power Alarm happens, otherwise normal; Alarm judgment period: 3 minutes by default.
DL Output Overload Alarm	<ul style="list-style-type: none"> Alarm when the DL output power is higher than the threshold, otherwise normal; Alarm judgment period: 3 minutes by default; Alarm threshold: 32dBm.
Shutdown Alarm	<ul style="list-style-type: none"> Alarm when the PA status is off, otherwise normal; Alarm judgment period: 10s by default.
LNA Alarm	<ul style="list-style-type: none"> Alarm when LNA have problems, otherwise normal; Alarm judgment period: 3 minutes by default.

6.2 TROUBLESHOOTING

Following installation and commissioning, occasional operation tasks to handle alarms may be required:

Table 16: MU Alarms Diagnosis

Alarm condition	Diagnosis
Over-Temperature alarm	<ul style="list-style-type: none"> Check device temperature on WEB GUI If device temperature is over threshold, make sure environment temperature is within the environment temperature range that MU supported (0~40°C). Apply climatic protection to the system under severe environment.
Optical TX Alarm	<ul style="list-style-type: none"> Test MU transmit optical power Replace FOU if transmit optical power is less than -7dBm
Optical RX Alarm	<ul style="list-style-type: none"> Use Optical Power Meter to test received optical power If received optical power is lower than -10dBm, test whether RU transmit optical power is normal (3~5dBm) Check if optical loss of fiber link is higher than 6.5dBo Clean fiber connector with absolute ethanol
DL Input Power Overload Alarm	Test DL input power of MU, if it is higher than +33dBm, choose proper coupler to ensure the input power to MU is lower than +33dBm.

Table 17: RU Alarms Diagnosis

Alarm condition	Diagnosis
External Alarm	Check to make sure if the external device connected is working normally
Over-Temperature alarm	<ul style="list-style-type: none"> Check device temperature on WEB GUI If device temperature is over threshold, make sure environment temperature is within the environment temperature range that RU supported (-20~50°C). Apply climatic protection to the system under severe environment.
Optical TX Alarm	<ul style="list-style-type: none"> Test RU transmit optical power Replace FOU if transmit optical power is less than 0dBm
Optical RX Alarm	<ul style="list-style-type: none"> Use Optical Power Meter to test received optical power If received optical power is lower than -14dBm, test whether MU transmit optical power is normal (-4~-2dBm) Check if optical loss of fiber link is higher than 6.5dBo Clean fiber connector with absolute ethanol
DL PA alarms	<p>Check PA Service Status on WEB GUI RU page,</p> <ul style="list-style-type: none"> If it is [Recovery], reset PA on WEB GUI Management page, then read RU output power: If output power is exceed threshold, need to reduce gain or input power; if output power is normal, check whether antenna port VSWR is too high. If it is [Shutdown], Refer to PA Shutdown Alarm
DL Output Power Overload Alarm	<ul style="list-style-type: none"> Check if output power is exceed the threshold (32dBm) Decrease the gain to reduce the output power
PA Shutdown Alarm	<ul style="list-style-type: none"> Make Sure the environment temperature is -20~50°C Reset PA, if PA service status turns to [Recovery], and then refer to DL PA Alarms. If PA still shutdown, the PA module maybe damaged, please contact with Comba to replace the RU.
LNA Alarm	Uplink LNA modual damaged, please contact with Comba to replace the RU.

End of Section

7 APPENDICES

7.1 APPENDIX A: TOOLS FOR INSTALLATION AND MAINTENANCE

The following tools (not included in package) are required for installation or routine maintenance:

- Power Drill (for wall mount)
- Adjustable Wrench (0.31 inch~0.79 inch)
- Philips Screwdriver
- Allen wrench (M6)
- Signal generator support output power 10dB.
- Site Master

7.2 APPENDIX B: RMA (RETURN MATERIAL AUTHORIZATION)



Comba Telecom Ltd.
 611 East Wing, No. 8 Science Park West Avenue, Hong Kong Science Park, Tai Po, Hong Kong
 Tel: +852 2636 6861 Fax: +852 2637 0966

RMA Request Form
 Date: _____

From: _____
 Address: _____
 Tel: _____ Fax: _____
 E-Mail: _____
 ATTN: _____

Product Information:

Item	Model	Serial Number	Return Category	Qty	Problem Description
1					
2					
3					
4					
5					
6					
7					
8					
9					
10					

Notes:
 1. For 'Return Category' column, please select from **A:** Return of Defective Product, **B:** Return of Trial Sample, or **C:** Return of New and Unused Product.
 2. If **A** or **C** category of return product is chosen, please give short description of the problem or reason for returning.

Transportation Information:
 Location of Product: _____
 Transportation Method: _____
 Shipping Forwarder: _____

Note: Location of Product must be stated, while 'Transportation Method' or 'Shipping Forwarder' can be left blank if not determined.

Signature:

For Comba Use (Only)
 Return Merchandise Authorization Number (RMA#): _____
 Recommended Action: _____
 Shipment and Handling Cost to be paid by: _____

Approved by: _____

Date: _____

End of Section

End of Document

FOR NAM OFFICE EMAIL, PLEASE INSERT: support.us@comba-telecom.com



North America Office

Comba Telecom Inc.

235 Charcot Ave, San Jose, CA 95131, USA

Tel: +1 866 802 7961

Fax: +1 408 526 0181

Email: customer.nam@comba-telecom.com

Corporate Headquarters

Comba Telecom Systems Holdings Ltd

611 East Wing, No.8 Science Park West Avenue, Hong Kong Science Park, Hong Kong

Tel: +852 2636 6861

Fax: +852 2637 0966 / +852 2116 6055

www.comba-telecom.com