

Comba

mBDA-200S

BAND SELECTIVE WIRELESS REPEATER

USER MANUAL

MBDA-200S QE: 1-0-0

Comba Telecom Ltd.

The information contained herein is the responsibility of and is approved by the following, to whom all enquiries should be directed in the first instance:

This is an unpublished work the copyright in which vests in Comba International ("Comba"). All rights reserved.

The information contained herein is confidential and the property of Comba and is supplied without liability for errors or omissions. No part may be reproduced, disclosed or used except as authorised by contract or other written permission. The copyright and the foregoing restriction on reproduction and use extend to all media in which the information may be embodied.

0.1 CONTENTS

Section	Page
0.1 CONTENTS	3
0.2 INDEX TO FIGURES AND TABLES	5
0.3 HISTORY	7
0.4 GLOSSARY OF TERMS.....	8
0.5 SAFETY NOTICES AND ADMONISHMENTS.....	9
1 GENERAL INFORMATION	10
2 EQUIPMENT DESCRIPTION.....	11
2.1 SYSTEM DIAGRAM.....	11
2.2 EQUIPMENT LAYOUT	12
2.3 EQUIPMENT CONSTITUTION.....	13
2.4 KIT OF PART	13
3 INSTALLATION	14
3.1 WARNINGS AND ALERTS.....	14
3.2 SITE PLANNING CONSIDERATIONS.....	15
3.3 INSTALLATION PROCEDURES	16
3.4 EQUIPMENT CONNECTORS	26
3.5 EQUIPMENT CONNECTION	27
4 COMMISSIONING	29
4.1 PRE-COMMISSIONING TASKS.....	29
4.2 LED INDICATORS.....	29
4.3 COMMISSIONING PROCEDURE	30
5 WEB GUI	32
5.1 WEB GUI CONNECTION.....	32
5.2 WEB GUI INTRODUCTION	33
5.2.1 [DEVICES].....	33
5.2.2 [COMMISSIONING]	35
5.2.3 [FIRMWARE]	36
5.2.4 [MANAGEMENT].....	37
5.3 COMMISSIONING PROCEDURE	43
6 MAINTENANCE	49

7 APPENDICES 50

7.1 APPENDIX A: TOOLS FOR INSTALLATION AND MAINTENANCE..... 50

7.2 APPENDIX B: RMA (RETURN MATERIAL AUTHORIZATION) 51

0.2 INDEX TO FIGURES AND TABLES

Figure 1: mBDA-200S	10
Figure 2: 2 Bands System Diagram for Example	11
Figure 3: Layout of mBDA	12
Figure 4: mBDA Screen	17
Figure 5: mBDA Rack.....	17
Figure 6: Remove Cover Plates.....	18
Figure 7: PMU Installation	18
Figure 8: RF Unit Installation.....	19
Figure 9: mBDA Installation Finish	19
Figure 10: Equipment Cabinet with Pallet	20
Figure 11: mBDA Installation	21
Figure 12: Secure the Screws.....	21
Figure 13: Finish Installaiton	22
Figure 14: Mounting Rack.....	23
Figure 15: Angle Iron Installation.....	23
Figure 16: mBDA Installation	24
Figure 17: Secure the Enclosure	24
Figure 18: Finish Installaiton	25
Figure 19: mBDA Front Panel Connectors	26
Figure 20: mBDA Rear Panel Connectors	26
Figure 21: mBDA Grounding (mBDA Rear Panel).....	27
Figure 22: mBDA Power Connection (Rear Panel)	28
Figure 23: Pins Allocation for “EXT_ALM” Port for mBDA.....	28
Figure 24: Commissiong Flow Chart.....	30
Figure 25: Input IP Address.....	32
Figure 26: Input Domain Name.....	32
Figure 27: Input User Name and Password.....	32
Figure 28: Web GUI Main Screen	33
Figure 29: [Devices] Sceen	33
Figure 30: Power & Monitoring Unit	34
Figure 31: RF Unit.....	34
Figure 32: RF Unit Detail Information	35
Figure 33: [Commissioning] Screen	35
Figure 34: [Firmware] Screen – Upgrade	36
Figure 35: [Firmware] Screen – Pop-up Window 1	36
Figure 36: [Firmware] Screen - Swap	37
Figure 37: [Management] Sceen	37
Figure 38: Management – Import&Export	38
Figure 39: Management – IP Setting	38
Figure 40: Management – SNMP Setting.....	39
Figure 41: Management – Security	39
Figure 42: Modify Password.....	40
Figure 43: Management – Device Reset.....	40
Figure 44: Management – PA Reset.....	41
Figure 45: Management – Device Info.....	41
Figure 46: Management – Isolation.....	42
Figure 47: Management – Report.....	42
Figure 48: Commissioning Procedure – Start.....	43
Figure 49: Commissioning Procedure – Site Info. Setting.....	43
Figure 50: Dev Info & Date/Time	44
Figure 51: Commissioning Procedure – Isolation Detective.....	45
Figure 52: Commissioning Procedure – Isolation Detective Confirm.....	45
Figure 53: Commissioning Procedure –Isolation Detection Failed.....	45

Figure 54: Commissioning Procedure –Isolation Detection Finish.....	46
Figure 55: Commissioning Procedure – Subband bandwidth and Switch Setting.....	46
Figure 56: Commissioning Procedure – DL Output Power Setting Screen	47
Figure 57: Commissioning Procedure – DL Output Power Setting	47
Figure 58: DL Output Power Over Exceed	48
Figure 59: Commissioning Procedure – Finish	48
Table 1: mBDA Components	13
Table 2: KOP	13
Table 3: mBDA Connections.....	27
Table 4: Pin Definition of “EXT_ALM” Port for mBDA	28
Table 5: LED Indications.....	29
Table 6: Commissioning Procedure	31

0.3 HISTORY

Change No.	ENU	Details Of Change
1	1-0-0	This user manual first created in Aug 2014.

0.4 GLOSSARY OF TERMS

ALC	Automatic Level Control
ATT	Attenuation
BDA	Bi-direction Amplifier
BS	Base Station
BTS	Base Transceiver Station
DL	Downlink
DT	Donor Terminal
FOU	Fiber Optical Unit
GUI	Graphic User Interface
ID	Identification
LNA	Low Noise Amplifier
MCU	Main Control Unit
MT	Mobile Terminal
MTBF	Mean Time Between Failures
MBDA	Master Unit
NC	Normally Closed
NF	Noise Figure
NO	Normally Open
OMC	Operation & Maintenance Center
OMT	Operation & Maintenance Terminal
PA	Power Amplifier
POI	Point of Interconnects
PSU	Power Supply Unit
RF	Radio Frequency
RFU	Radio Frequency Unit
RU	Remote Unit
SMA	Sub-Miniature "A" Connector
TX/RX	Transmit/Receive
UL	Uplink
VAC	Volts Alternating Current
VSWR	Voltage Standing Wave Ratio
WCDMA	Wideband Code Division MBDAItriple Access

0.5 SAFETY NOTICES AND ADMONISHMENTS

This document contains safety notices in accordance with appropriate standards. In the interests of conformity with the territory standards for the country concerned, the equivalent territorial admonishments are also shown.

Any installation, adjustment, maintenance and repair of the equipment must only be carried out by trained, authorized personnel. At all times, personnel must comply with any safety notices and instructions.

Specific hazards are indicated by symbol labels on or near the affected parts of the equipment. The labels conform to international standards, are triangular in shape, and are coloured black on a yellow background. An informative text label may accompany the symbol label.

Hazard labeling is supplemented by safety notices in the appropriate equipment manual. These notices contain additional information on the nature of the hazard and may also specify precautions.

WARNING! This is **NOT** a **CONSUMER** device. It is designed for installation by **FCC LICENSEES** and **QUALIFIED INSTALLERS**. You **MUST** have an **FCC LICENSE** or express consent of an FCC Licensee to operate this device. Unauthorized use may result in significant forfeiture penalties, including penalties in excess of \$100,000 for each continuing violation.

Note: The grantee is not responsible for any changes or modifications not expressly approved by the party responsible for compliance. Such modifications could void the user's authority to operate the equipment.

This device complies with Part 22 and 24 of the FCC Rules. Operation is subject to the following two conditions: (1) this device may not cause harmful interference, and (2) this device must accept any interference received, including interference that may cause undesired operation.

For compliance with the general population RF exposure limits, each individual antenna used for this transmitter must be installed to provide a separation distance greater than 41.73cm or more from all persons during normal operation and must not be co-located with any other antenna for meeting RF exposure requirements.

Alert:

These draw the attention of personnel to hazards that may cause damage to the equipment. An example of use is the case of static electricity hazard.

Caution notices may also be used in the handbook to draw attention to matters that do not constitute a risk of causing damage to the equipment but where there is a possibility of seriously impairing its performance, e.g. by mishandling or gross maladjustment. Warnings and Cautions within the main text do not incorporate labels and may be in shortened form.

The application antenna and RF cable are not provided. The antenna gain should not exceed 10 dBi.

Fixed, mobile, and portable (hand-held) stations operating in the 1710-1755 MHz band and mobile and portable stations operating in the 1695-1710 MHz and 1755-1780 MHz bands are limited to 1 watt EIRP.

Fixed stations operating in the 1710-1755 MHz band are limited to a maximum antenna height of 10 meters above ground.

End of Section

1 GENERAL INFORMATION

The mBDA-200S Band Selective Wireless Repeater is designed for operation in 700MHz, 700MHz, 850MHz, 1900MHz, AWS and 2600MHz networks. Digital band-specific linear amplifier amplifies the desired BTS carriers and provides superior out-of-band rejection. Typical units with adjustable bandwidth are programmed to specific requirements of the network. Remote configuration and surveillance is possible through Comba's remote control and monitoring system, via PC or Ethernet to the OMC.

Main feature:

mBDA-200S is a high quality repeater with the following features:

- Supports GSM, CDMA, WCDMA and LTE operating.
- Supports multi operator configurations and up to 3 sub bands per band.
- Adjustable sub band via Web OMT software.
- Friendly and easy Web OMT interface via RJ45 connection.
- Integrated network card for remote configuration, monitoring and control.

The figure below shows the enclosure.



Figure 1: mBDA-200S

NOTE: RF module is slot independent.

End of Section

2 EQUIPMENT DESCRIPTION

2.1 SYSTEM DIAGRAM

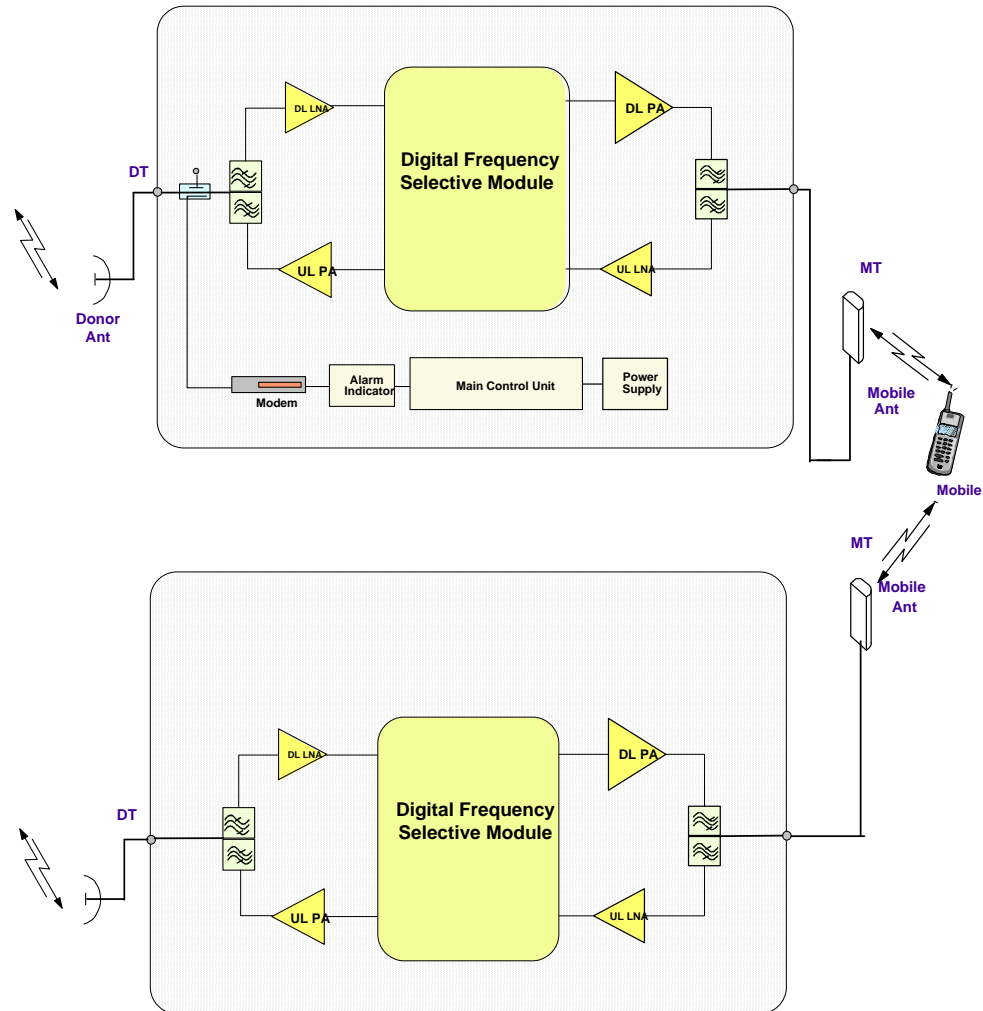

Figure 2: 2 Bands System Diagram for Example

In the downlink, the BTS signals are received by donor antenna of the repeater. After the duplexer, the signals are sent to the LNA module for pre-amplification and digital RF integrated module for digital filtering and frequency conversion. Then the DL signals will be sent to downlink PA to amplify power and filter via duplexer. After amplification, the signals are transmitted via the MT port to the service antenna.

In the uplink, the mobile signals are received by the service antenna. After the MT port integrated duplexer, the signals are sent to the LNA, integrated module for digital filtering, then to PA for power amplification and to duplexer. After that, the uplink signals are sent to the donor antenna for transmission back to the BTS.

2.2 EQUIPMENT LAYOUT

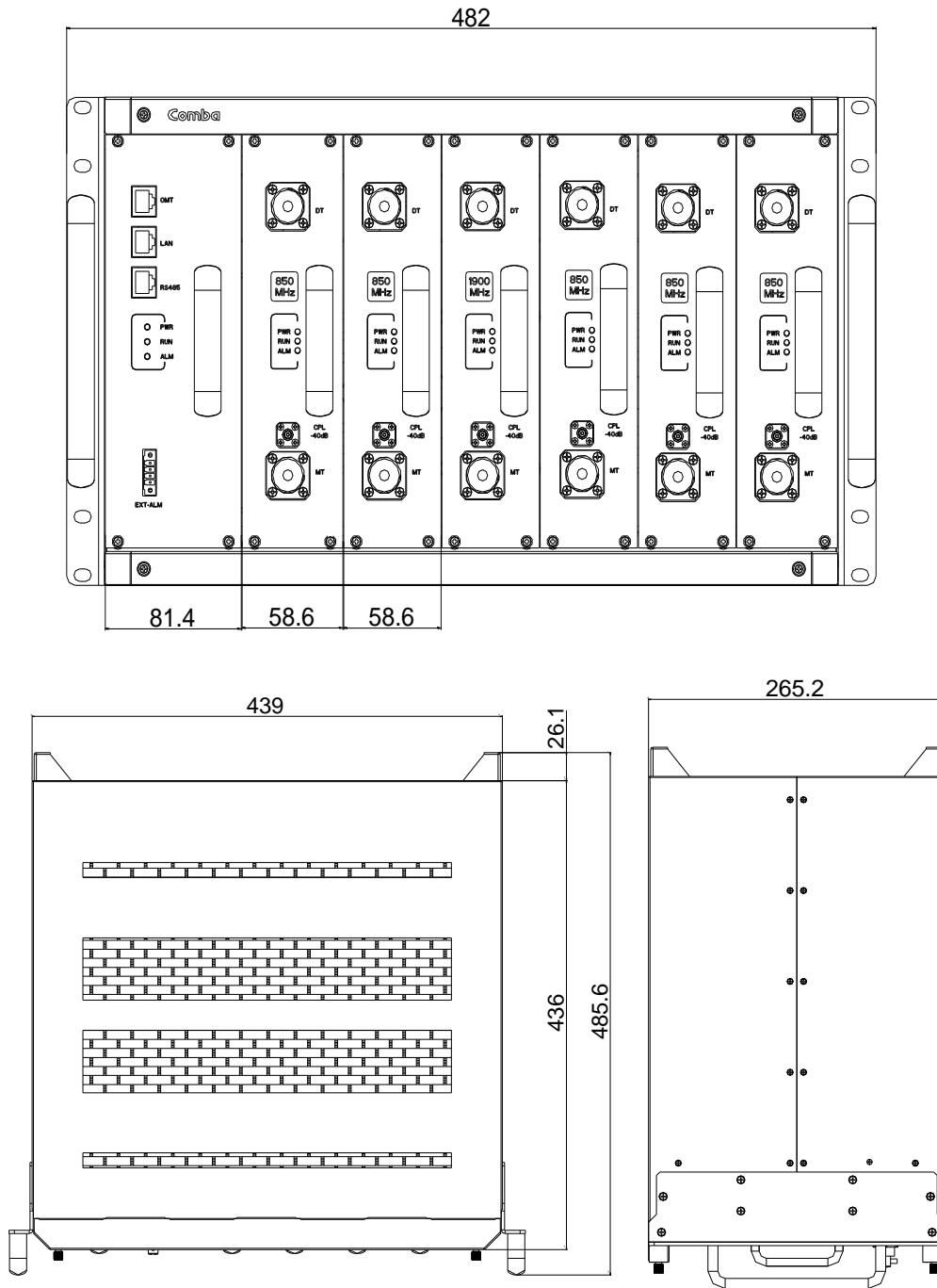

Figure 3: Layout of mBDA

2.3 EQUIPMENT CONSTITUTION



mBDA consists of the following parts:

Table 1: mBDA Components

Module	Description
mBDA-RACK	There are total 7 slots in the main chassis, where six slots for RF Units and Combiner Units, first slot is for Power & Monitoring Unit.
mBDA-PMU	Power & Monitoring Unit (PMU) converts the input voltage into stable DC to supply power for each RF module and provides monitor control.
mBDA-RFU	RF Unit processes UL/DL signal and amplifies the signal for coverage.

2.4 KIT OF PART

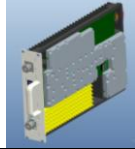
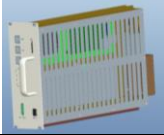
Table 2: KOP

Item	Qty	Image
Rack	1	
RF Unit (RFU) (Packing separately)	1~2	
Power & Monitoring Unit (PMU) (Packing separately)	1	
Power Supply Cable (13 Feet 1 inch)	1	
Communication Cable	1	

End of Section

3 INSTALLATION

3.1 WARNINGS AND ALERTS

Radio Frequency Energies

There may be situations, particularly for workplace environments near high-powered RF sources, where recommended limits for safe exposure of human beings to RF energy could be exceeded. In such cases, restrictive measures or actions may be necessary to ensure the safe use of RF energy.

High Voltage

The equipment has been designed and constructed to prevent practicable danger, as far as reasonably possible. Any work activity on or near equipment involving installation, operation or maintenance must be free from danger, as far as reasonably possible.

Where there is a risk of damage to electrical systems involving adverse weather, extreme temperatures, wet, corrosive or dirty conditions, flammable or explosive atmospheres, the system must be suitably installed to prevent danger.

Protective Earthing

For the purpose of protecting individuals from electrical risk, the equipment provided must be safety in design and properly maintained and used.

Handling Precautions

This covers a range of activities including lifting, lowering, pushing, pulling, carrying, moving, holding or restraining an object or person. It also covers activities that require the use of force or effort, such as pulling a lever, or operating power tools.

Electrostatic Discharge (ESD)

Observe standard precautions for handling ESD-sensitive devices. Assume that all solid-state electronic devices are ESD-sensitive. Ensure the use of a grounded wrist strap or equivalent while working with ESD-sensitive devices. Transport, store, and handle ESD-sensitive devices in static-safe environments.

3.2 SITE PLANNING CONSIDERATIONS

3.2.1 SITE PLANNING

Site Considerations

There may be situations, particularly for workplace environments near high-powered RF sources, where recommended limits for safe exposure of human beings to RF energy could be exceeded. In such cases, restrictive measures or actions may be necessary to ensure the safe use of RF energy.

Installation Location

Mounting surface shall be capable of supporting the weight of the equipment.

In order to avoid electromagnetic interference, a proper mounting location must be selected to minimize interference from electromagnetic sources such as large electrical equipment.

Environmental

Humidity has an adverse effect on the reliability of the equipment. It is recommended to install the equipment in locations having stable temperature and unrestricted air-flow.

The installation location for the system should be well ventilated. The equipment has been designed to operate at the temperature range and humidity level as stated in the product specifications.

Powering

The power & monitoring unit (PMU) provides power to all modules within the equipment. Depending on the product variant, it is recommended that the PMU operates on a dedicated AC circuit breaker or fused circuit.

Grounding Requirement

Verify that the equipment has been well grounded. This includes antennas and all cables connected to the system. Ensure lightning protection for the antennas is properly grounded.

Cable Routing

Depending on equipment configuration, a variety of types of cables are connected to the equipment: coaxial cables, power cable, communication cable, and commissioning cable. Where applicable, ensure cables are properly routed and secured so that they are not damaged.

Manual Handling

During transportation and installation, take necessary handling precautions to avoid potential physical injury to the installation personnel and the equipment.

3.2.2 SYSTEM INSTALLATION CHECKLIST

- Working space available for installation and maintenance for each mounting arrangement. Ensure unrestricted airflow.
- Ensure earthing point is within reach of the ground wire. (2m; 6 ft. 10 in.).
- Ensure a power source is within reach of the power cord and the power source has sufficient capacity.
- Where appropriate, ensure unused RF connectors are terminated.
- Where appropriate, ensure unused optical fiber connectors are protected.
- Do not locate the equipment near large transformers or motors that may cause electromagnetic interference.
- Reduce signal loss in feeder cable by minimizing the length and number of RF connections.
- Ensure the equipment will be operated within the stated environment (refer to datasheet).
- Where appropriate, confirm availability of suitably terminated grade of RF.
- Observe handling of all cables to prevent damage.

3.3 INSTALLATION PROCEDURES

3.3.1 GOODS INWARDS INSPECTION

mBDA was factory tested, inspected, packed, and delivered to the carrier with utmost care. Do not accept shipment from carrier which shows damage or shortage until the carrier's agent endorses a statement of the irregularity on the face of the carrier's receipt. Without documentary evidence, a claim cannot be processed.

Open and check each package against the packing list. For any shortage, contact Comba Telecom Systems. Do not remove items from packing materials until installation.

3.3.2 TOOLS

See Appendix A for a full list of tools required for installation and maintenance.

3.3.3 ASSEMBLING

mBDA consists of one Rack and three different modules including PMU ,RFUs and CBs (CB is optional). All the units are packed separately. Follow the steps below to assemble.



Figure 4: mBDA Screen

Step1: The rack with cover plates is shown as Figure 5. Please remove the cover plates, before installing related modules. Show as Figure 6. PMU must be installed at the first left slot; RF Units are slot independent, and can be installed to other six slots. Below is dual bands system installation for example.



Figure 5: mBDA Rack

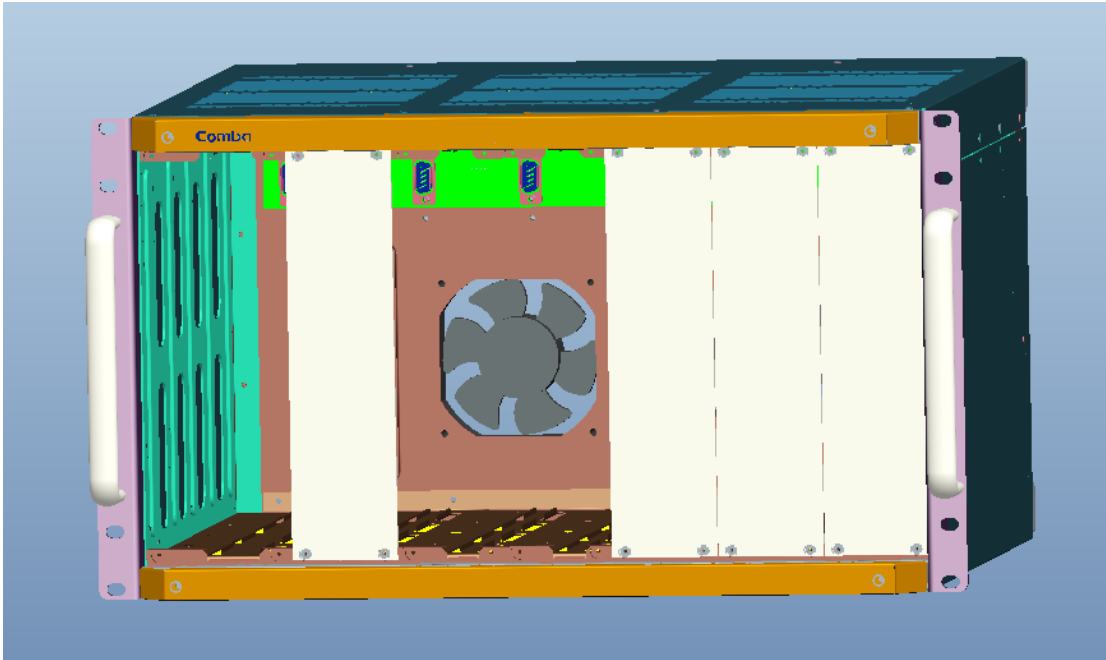

Figure 6: Remove Cover Plates

Step 2: PMU installation: Insert PMU and fasten the screws.

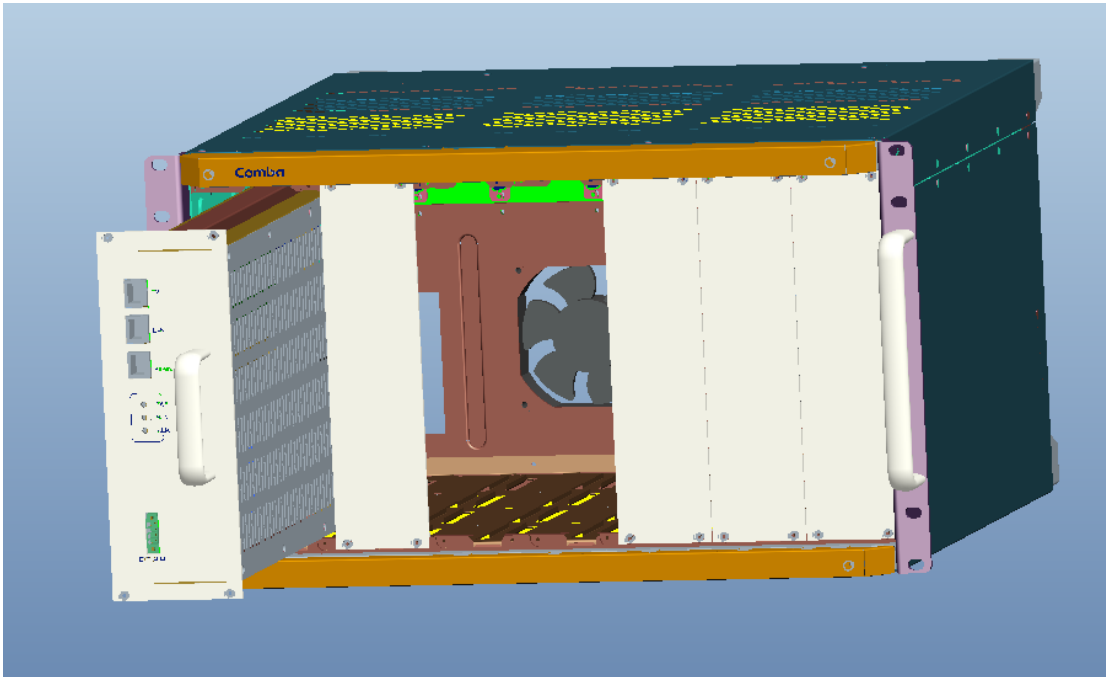

Figure 7: PMU Installation

Step 3: RF Units installation: Insert RFUs and fasten the screws.

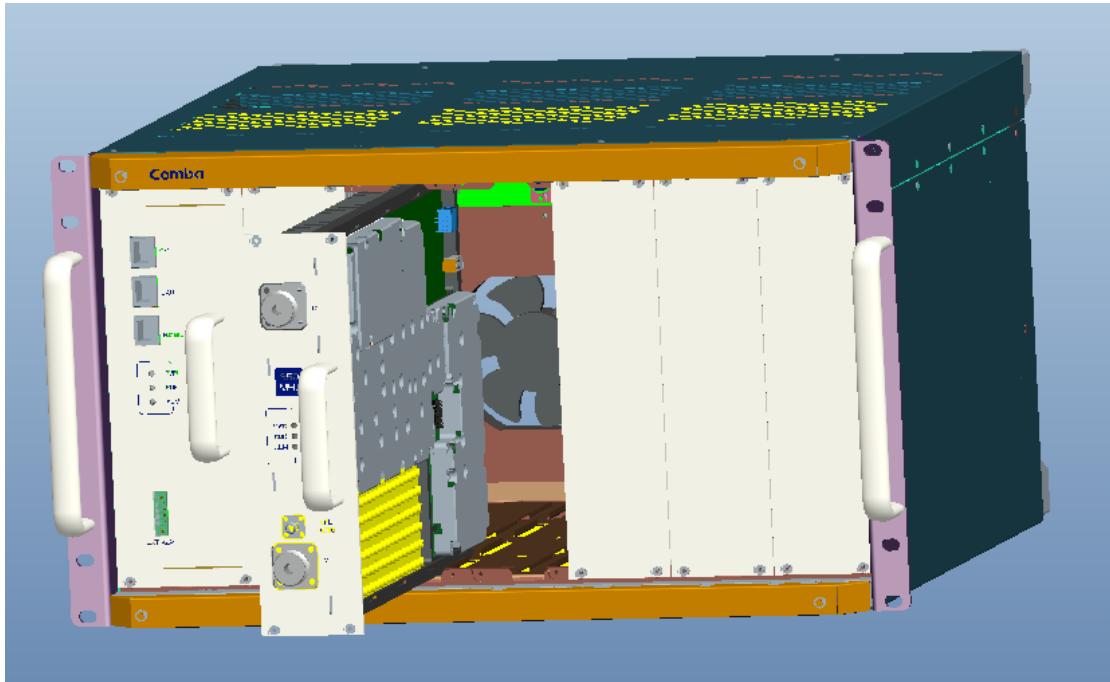

Figure 8: RF Unit Installation

Step 4: Finish Installation.

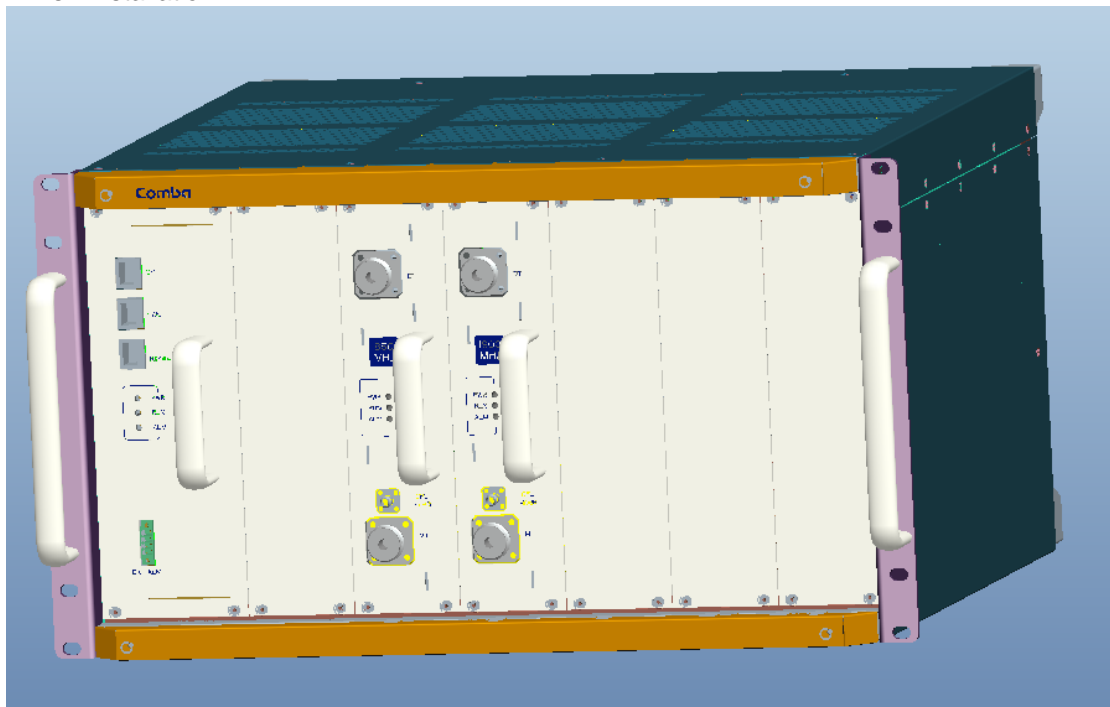

Figure 9: mBDA Installation Finish

3.3.4 mBDA IN NORMAL EQUIPMENT CABINET

mBDA is an indoor type device. It can be installed in normal equipment cabinet, the installation procedures are shown as below:

Step 1: Make sure the equipment cabinet is available with pallet, and the pallet is fixed steadily (Equipment Cabinet nuts, screws and pallet are not provided.). Use cabinet nuts, screws and pallet as recommended by rack manufacturer.

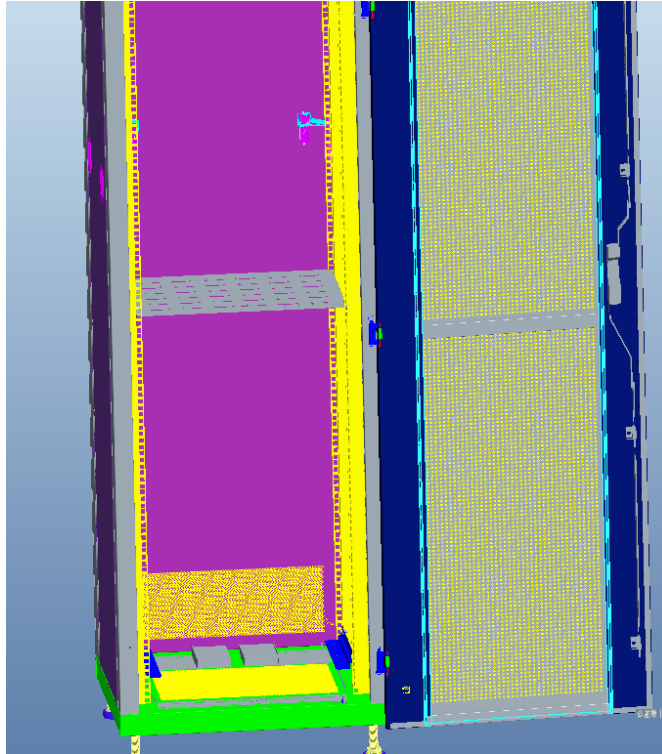

Figure 10: Equipment Cabinet with Pallet

Step 2: Install the mBDA on to the pallet.

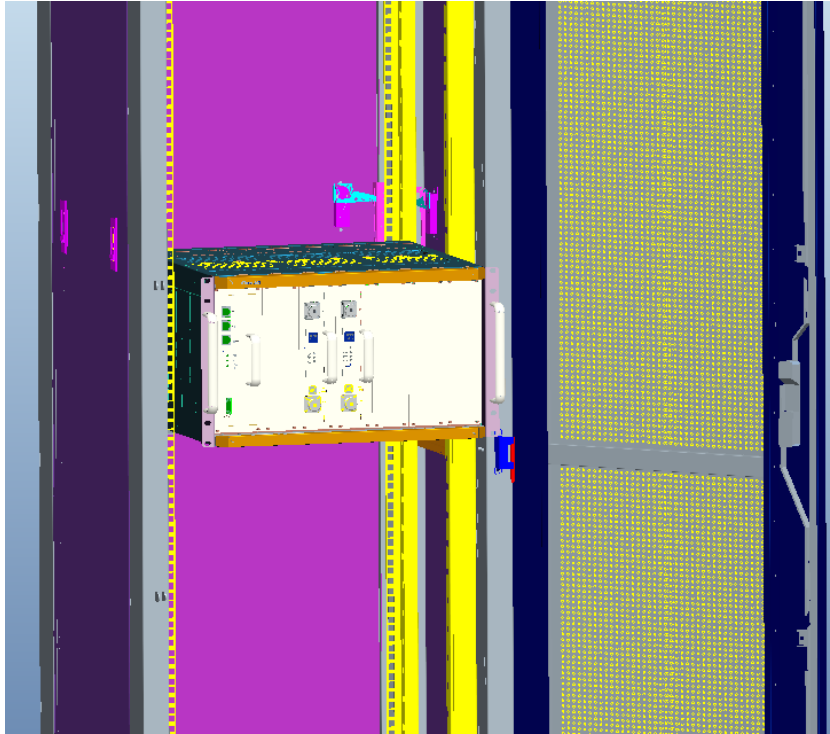

Figure 11: mBDA Installation

Step 3: Attach the mBDA onto the cabinet with the recommended rack screws.

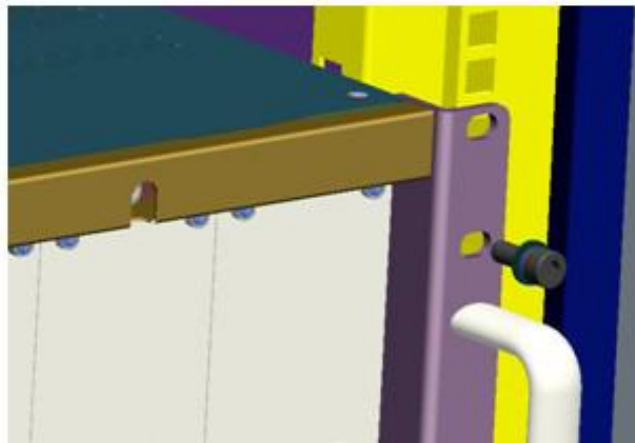

Figure 12: Secure the Screws

Step 4: Finish installation.

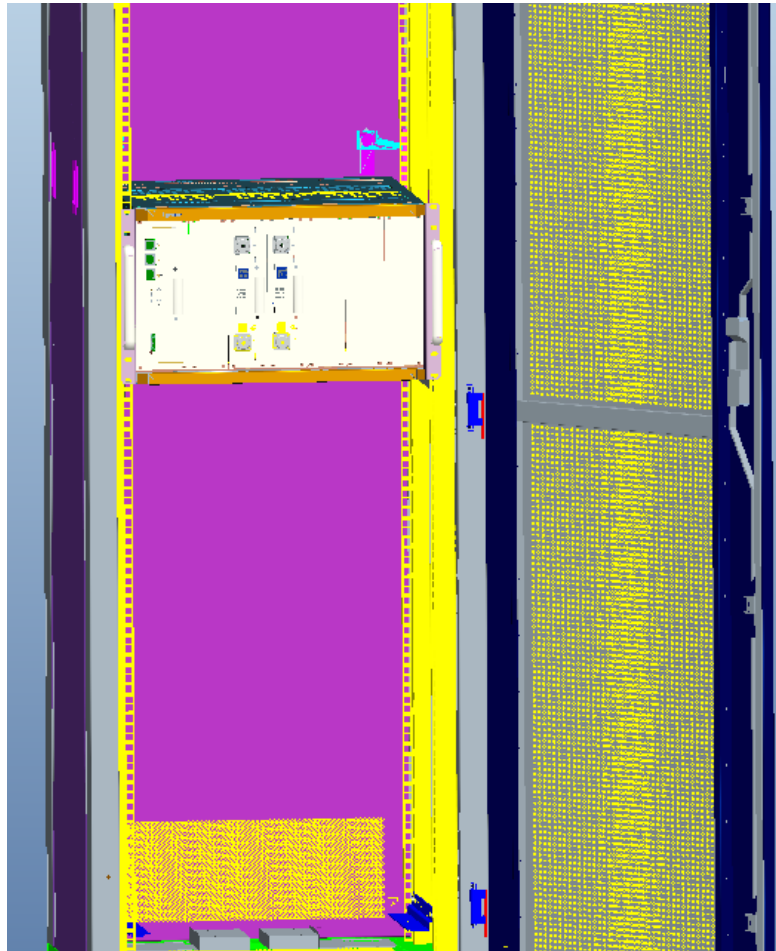

Figure 13: Finish Installaiton

3.3.5 mBDA IN 19" RACK MOUNTING

mBDA can also be installed in 19" rack mounting, the installation procedures are shown as below:

Step 1: Install right angle bracket and left angle bracket on back of the mounting rack. (19" Rack nuts, screws and Angel Iron are not provided.) Use rack nuts and screws as recommended by rack manufacturer. The Angle Iron is an optional assesory.

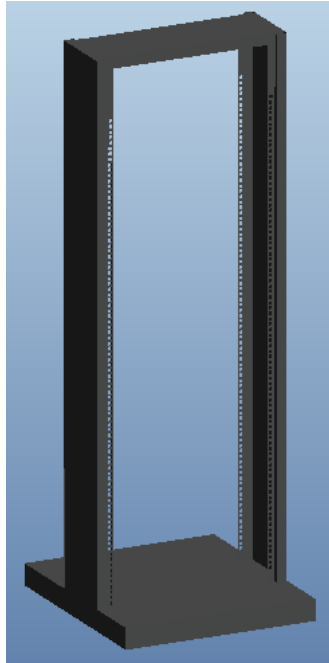

Figure 14: Mounting Rack

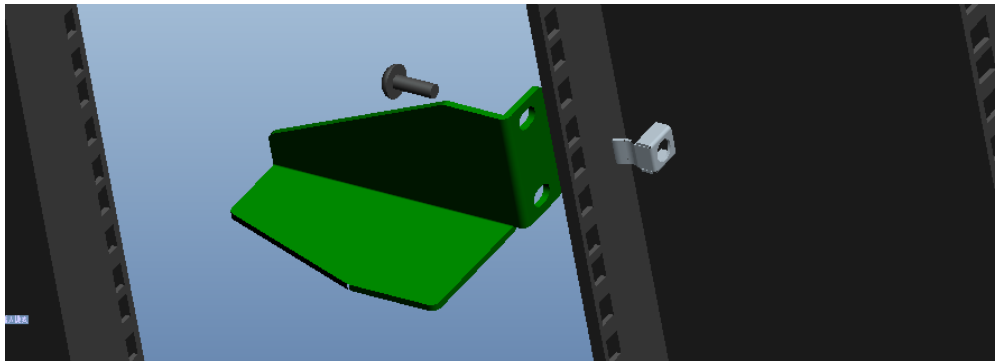

Figure 15: Angle Iron Installation

Step2: Slide the mBDA on to the angle brackets and confirm it is level. The left and right angle brackets need to be ordered separately.

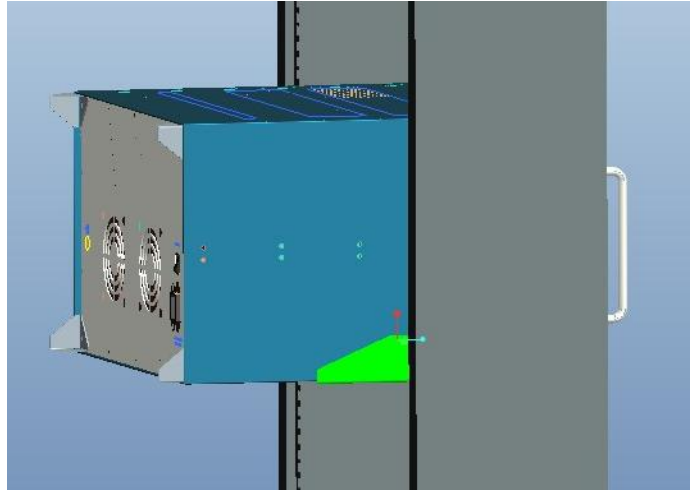

Figure 16: mBDA Installation

Step 3: Attach the mBDA onto the rack with the recommended rack screws.

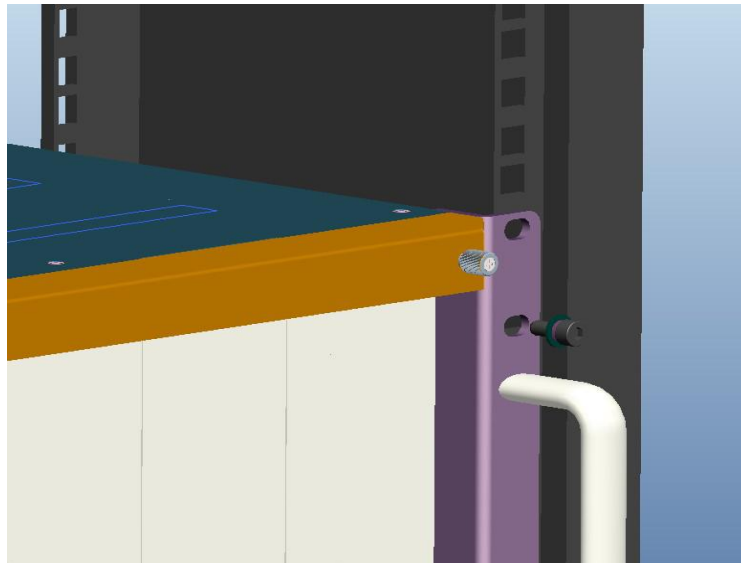

Figure 17: Secure the Enclosure

Step 4: Finish installation.

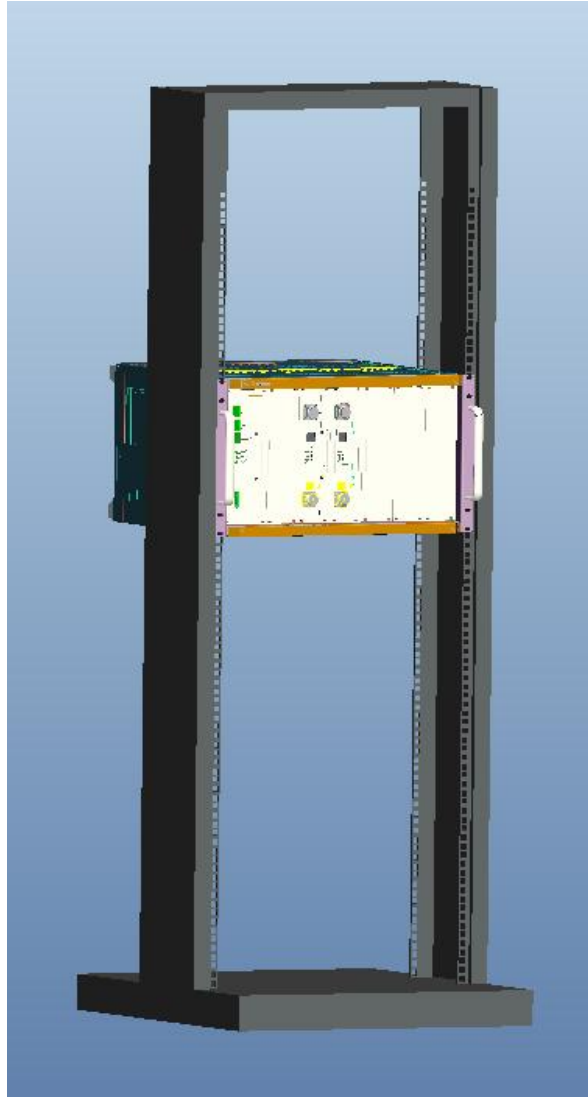

Figure 18: Finish Installaiton

3.4 EQUIPMENT CONNECTORS

The figure below presents the connectors of mBDA.



Figure 19: mBDA Front Panel Connectors



Figure 20: mBDA Rear Panel Connectors

Table 3: mBDA Connections

Identifier	Functional Description
1. OMT/LAN/RS485	OMT port is for local commissioning; LAN port is for remote connection; RS485 is for extension connection when adding extended equipment.
2. LED indicator	LED indicator. Refer to Table 5 for the detailed information.
3.EXT_ALM	External alarm connector with 4 pins. Refer to Table 4 for the detailed information.
4.DT	RF input port, Mini Din female
5.CPL	Output coupler port, -40dB, QMA female
6.MT	RF output port, Mini Din female
7. Ⓧ	Grounding connector.
8. FAN	Fan inside
9. POWER	Power switch.
10. AC100~240V	AC power supply connector.

3.5 EQUIPMENT CONNECTION

3.5.1 GROUNDING CONNECTION

⚠ WARNING!

This unit must always be grounded. Consult an appropriate electrical inspection authority or an electrician if you are uncertain that suitable grounding is available.

Do not connect power before grounding.

3.5.2 mBDA GROUNDING CONNECTION

Step 1: Connect the GND cable to the GND connector and the building EARTH. Recommended GND cable size is # 12 AWG.

Step 2: Ensure the GND cable is connected to building GND.

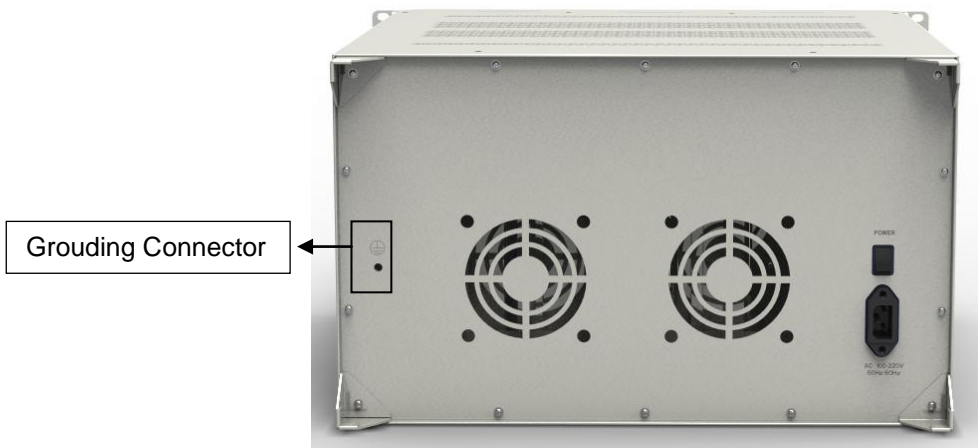

Figure 21: mBDA Grounding (mBDA Rear Panel)

3.5.3 mBDA CONNECTIONS

Step1: Connect the mBDA DT port to the RF Source downlink, and then connect mBDA MT port with RF Source uplink.

Step 2: Connect the power cable to the power supply port (100-240VAC, 1Amp maximum).

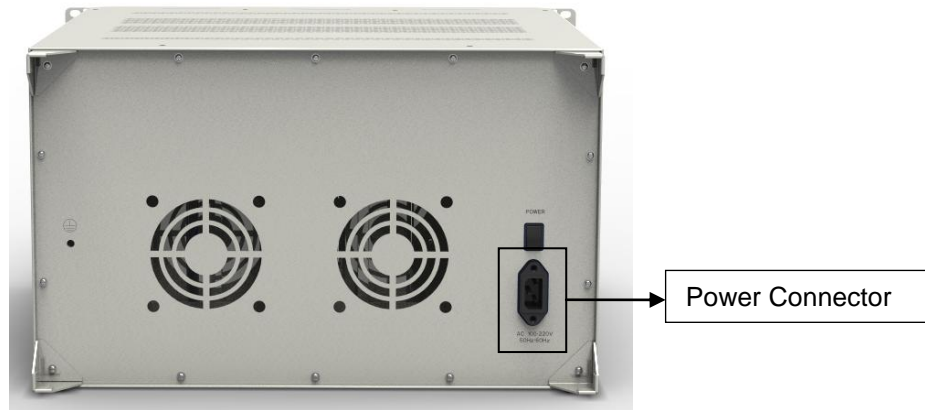

Figure 22: mBDA Power Connection (Rear Panel)

3.5.4 EXTERNAL ALARM CONNECTION

For EXT-ALM, this is a 4-pin connector. The following figure and table show the pin allocation and definition. Pin numbering are shown looking-into the connector on the enclosure.

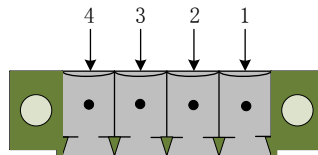

Figure 23: Pins Allocation for “EXT_ALM” Port for mBDA

Table 4: Pin Definition of “EXT_ALM” Port for mBDA

Pin number	1	2	3	4
Alarm definition	EXT. Alarm 1	GND	EXT. Alarm 2	GND

Note: Users need to configure Ext Alm 1~2 on WEB GUI to realize External Alarm (Refer to Chapter 5).

3.5.5 CONNECT TO PC

The local commissioning and management for mBDA is achieved through connecting to the WEB based GUI.

Connect mBDA to PC

Connect mBDA “OMT” port (RJ45) to the RJ45 port of PC with supplied Ethernet cable to achieve local monitoring and management.

End of Section

4 COMMISSIONING

4.1 PRE-COMMISSIONING TASKS

After equipment installation, perform the following steps before equipment powering and commissioning, check that the expected voltage, current, and power levels do not violate any ratings. Double check all connections including ground before applying power. Do not manipulate circuits or make changes when power is applied:

- Visually inspect the power connection within the equipment. Ensure that all cables are correctly and securely connected, including power cables, grounding wires and RF cables.
- Check grounding connection and verify that the ground resistance is less than 5Ω.
- Connect the equipment to the PC.
- Power on equipment.
- Monitor the initialization of the equipment through the LEDs on the panel. Refer to detailed LEDs information in the next section.

4.2 LED INDICATORS

Diagnostic LEDs are located on the equipment front panel; each indicates the status of a particular function:

Table 5: LED Indications

LED Indicator	Normal Status	Indication
PWR	Steady green	Power indicator. If LED is off, it indicates the system has no power.
RUN	Flashing green (1 time/sec)	mBDA operation indicator. After initialization (1~2 minutes), the LED should flash at once per sec. (When upgrade firmware, LED will flash rapidly)
ALM	OFF	Alarm indicator. If LED is RED, there is an alarm.

4.3 COMMISSIONING PROCEDURE

System commissioning can commence after the monitoring system has completed self initialization. The commissioning procedure is shown below:

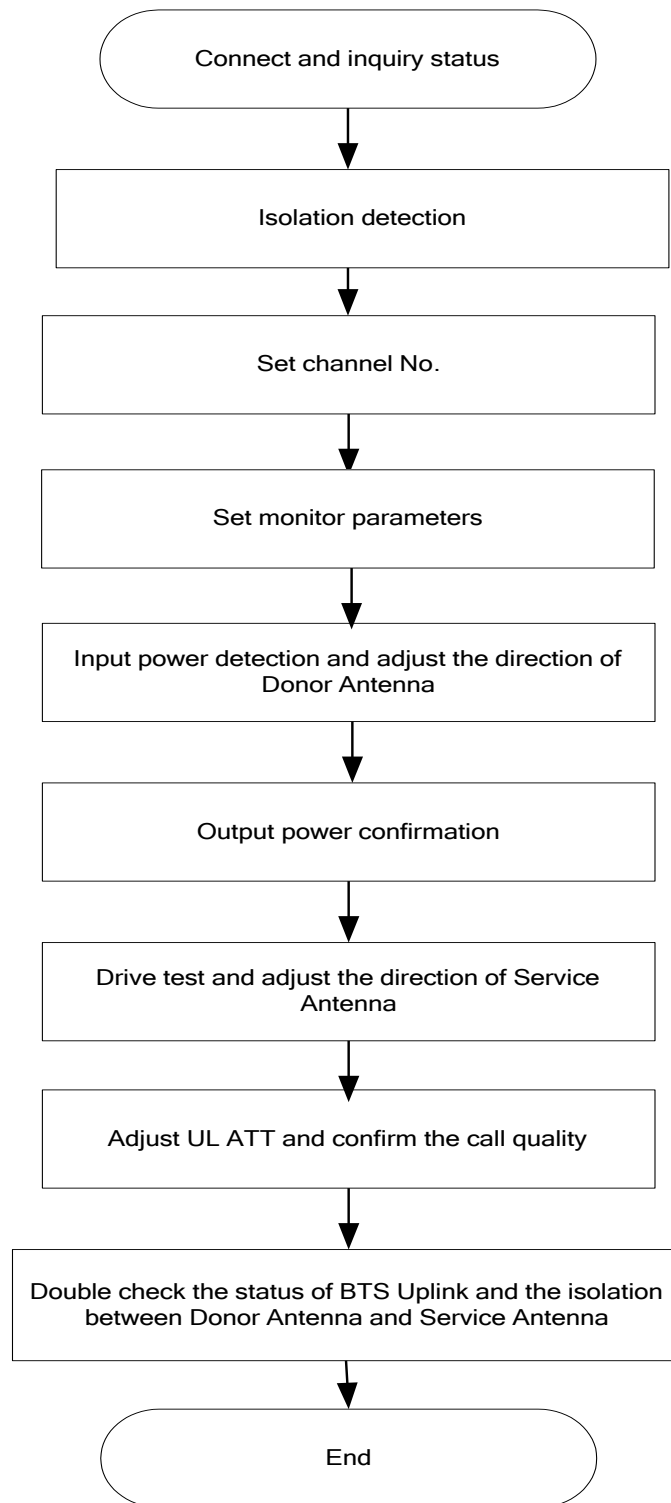

Figure 24: Commissioning Flow Chart

Table 6: Commissioning Procedure

Commissioning Tasks	Observation
1. On-line and Inquiry status	<ul style="list-style-type: none"> ● Activate the OMT Main window. The system Initialization will completed in about 2 minutes. ● Click “Connect” button to enquire the repeater’s status. Proceed if there is no alarm; else check the failure and attend to the alarm.
2. Isolation detection	<ul style="list-style-type: none"> ● Detect isolation of service antenna and donor antenna.
3. Set Channel No.	<ul style="list-style-type: none"> ● Keep RF switch ON and set the channel number of the repeater’s operating frequency.
4. Adjust Downlink Output Power and align donor antenna	<ul style="list-style-type: none"> ● Observe DL input power from measured value. Align the direction of donor antenna until the DL input power reading is maximized. ● Note: To ensure that the measured DL input power is accurate, one should set the DL ATT to “0” before performing the check.
5. Configure [Equipment ID]	<ul style="list-style-type: none"> ● Go to [Properties Info] and set [Equipment ID].
6. Comm. Config	<ul style="list-style-type: none"> ● Enable the power supply by selecting “On” in [RF] -> [Switch]; go to [Properties Info.] -> [Comm. Config.] and set OMC Phones No. , the service No. of SMSC, Report Mode.
7. Select Monitoring Parameters	<ul style="list-style-type: none"> ● Select the equipment controlled and monitored parameters. ● If the external devices are connected to the equipment for management, please enable in the [External Alarm Info.] Interface.
8. Test coverage area field intensity and adjust service antenna.	<ul style="list-style-type: none"> ● Use test-handset to verify field intensity within the coverage area. If needed, realign the service antenna to achieve the desired coverage. ● Note: If during operation, the equipment gain could not be set to maximum or the output power is not high enough due to insufficient donor and service antennas isolation, then the antennas’ position should be changed to increase isolation. If the output power is too high and ALC is activated, then adjust the DL ATT to achieve optimal DL Gain.
9. Verify UL gain and ensure test call produces good voice quality and there is no interfering BTS	<ul style="list-style-type: none"> ● Adjust UL gain and perform test calls. Typically, the UL gain is set around 5dB less than DL gain. Perform test calls in the coverage area while adjusting UL gain if required. ● Note: If the repeater is near the BTS and the test call performance is poor, this may be due to UL noise interference to the BTS. Users can calculate and determine if the repeater UL noise will interfere with the BTS. ● Verify again that there is no unacceptable interference to BTS.

End of Section

5 WEB GUI

mBDA can be monitored and controlled by WEB GUI, follow below contents to achieve system parameter setting and commissioning.

5.1 WEB GUI CONNECTION

Step 1: Connect PMU OMT port to PC RJ45 port with the supplied Ethernet cable to set up a physical connection.

Step 2: Open browser (browser IE7.0, IE8.0, Chrome or Firefox, suggest display resolution is 1024x768), input Web GUI **IP address: 192.168.8.101**, click [Enter].

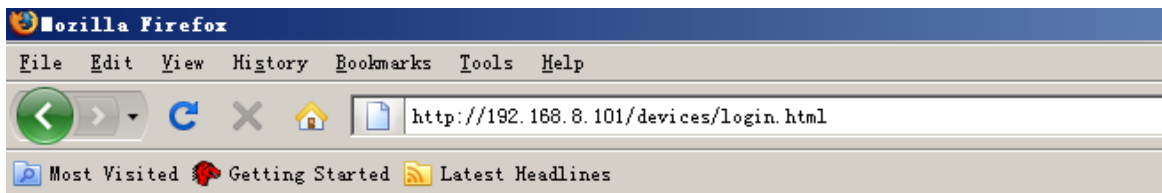

Figure 25: Input IP Address

NOTE: DHCP and DNS are also available to login Web GUI. The domain name is: www.combaomt.com. Input **User Name: admin**; **Password** (default password: **admin**). Click [Log in].

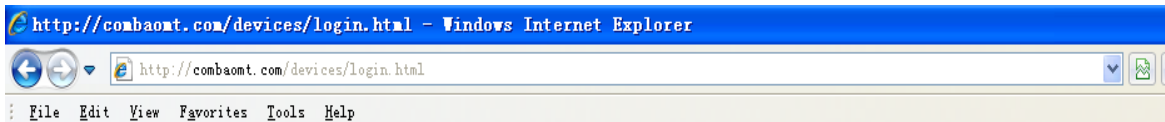

Figure 26: Input Domain Name

A screenshot of the Comba System Management Platform login page. The page has a blue header with the "Comba" logo and the text "System Management Platform". Below the header, there are two input fields: "username: admin" and "password: [masked]". A "Log In" button is located to the right of the password field.

Figure 27: Input User Name and Password

5.2 WEB GUI INTRODUCTION

After log in, the Web GUI main screen will appear. We take dual bands products for example.

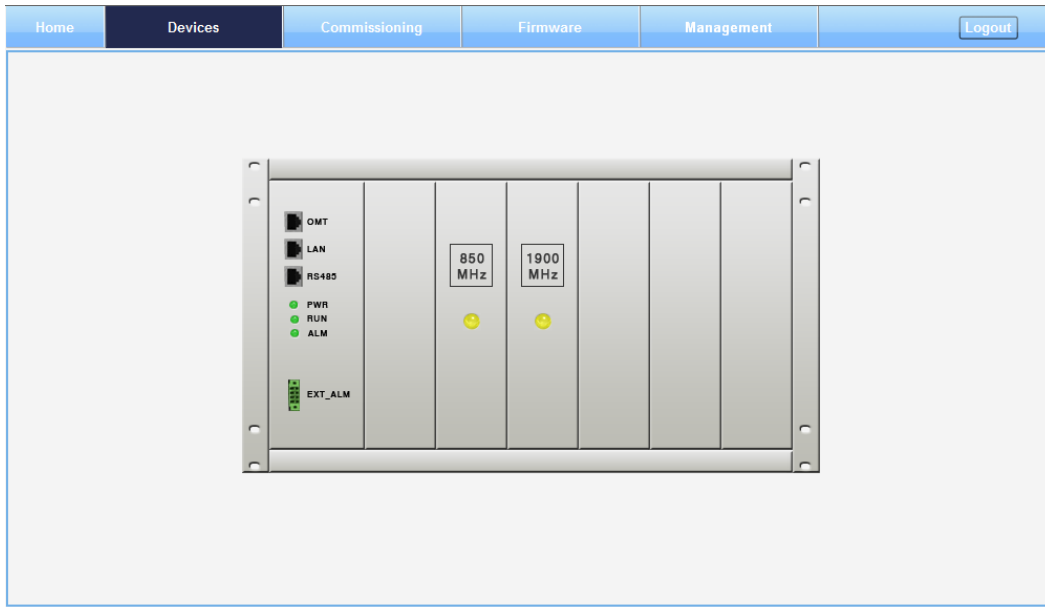

Figure 28: Web GUI Main Screen

On Comba Web GUI Home Screen, there are four Menu bars: **[Devices]**, **[Commissioning]**, **[Firmware]** and **[Management]**.

5.2.1 [DEVICES]

The [Devices] Screen shows the actual active modules of mBDA.

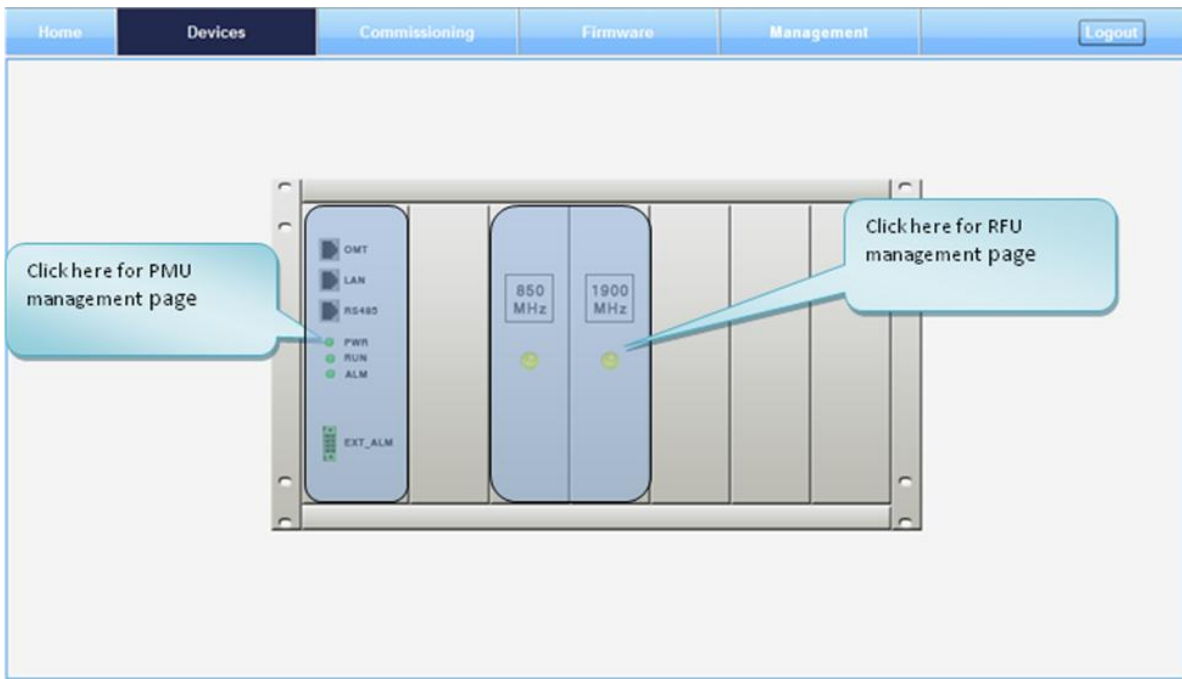

Figure 29: [Devices] Screen

PMU Main Management Screen

The screenshot shows the PMU Main Management Screen. At the top, there are navigation tabs for 'Home', 'Device', and 'Logout'. Below this, there are sub-tabs for 'Monitoring Unit' and 'RF Unit'. The main content area is divided into several sections:

- Left Panel:** Contains status indicators for OMT, LAN, RS485, PWR, RUN, ALM, and EXT_ALM. Below these is a table of basic information:

Dev Model:	mBDA
Uptime:	0:5:13 0/0/0
Date/Time:	09:48:57 01/17/14
Temperature:	34°C
Serial Num:	AA20140110025
Dev Info:	GZ BuildingE-6
Firmware Version:	M75mBDAUSH10V8001
- Right Panel (Top):** A table showing PMU alarm status:

Name	Value	
RF Unit Alm	ON	Modify
Ext Alm1	ON	Modify
Ext Alm2	ON	Modify
Fan Alm1	ON	Modify
Fan Alm2	ON	Modify
Over Temperature Alm	ON	Modify
- Right Panel (Bottom):** A table showing configuration of PMU external alarm:

Name	Value	Remark	
Ext Alm1 Level	High Level	Ext Alm01	Modify
Ext Alm2 Level	High Level	Ext Alm02	Modify

Callouts provide additional context: 'This part shows PMU alarm status' points to the top table; 'Click here to enable/disable alarm' points to the 'Modify' buttons; 'This part shows configuration of PMU external alarm' points to the bottom table; and 'This part shows PMU basic information' points to the left panel's table.

Figure 30: Power & Monitoring Unit

RF Unit Management Screen

The screenshot shows the RF Unit Management Screen. At the top, there are navigation tabs for 'Home', 'Device', and 'Logout'. Below this, there are sub-tabs for 'Monitoring Unit' and 'RF Unit'. The main content area is divided into several sections:

- Top Panel:** Shows frequency selection buttons for 850 MHz (slot2) and 1900 MHz (slot3).
- Left Panel:** Contains an 'Overview' section with buttons for 850MHz and 1900MHz. A callout 'RFU overview display' points to this section.
- Right Panel:** A table showing RF parameters for two slots:

Slot	Freq Band	DL P_in1	DL P_in2	DL P_in3	DL P_out	RF Switch	Commissioning	PA Status
2	850(MHz)	<-80dBm	<-80dBm	<-80dBm	<-10dBm	ON	Not Done	Normal
3	1900(MHz)	<-80dBm	<-80dBm	<-80dBm	<-10dBm	ON	Not Done	Normal

Callouts provide additional context: 'Slot information of RFU' points to the 'Slot' column; 'RFU frequency band' points to the 'Freq Band' column; 'RF parameter' points to the power level columns; 'Commission information of RFU' points to the 'Commissioning' column; and 'PA information of RFU' points to the 'PA Status' column.

Figure 31: RF Unit

NOTE: There are three statuses for PA Service: **Normal**, **Recovery** and **Shutdown**. If PA output power or reflected power exceeds the threshold, software will trigger Recovery:

- It will reset PA and then re-detect the PA output power and reflected power, if they are normal, the PA Service Status will turn to **Normal**, if PA output power or reflected power is still over the threshold, PA Service Status will turn to **Recovery** again.
- If PA output power or reflected power is still over the threshold after six times of PA Recovery, PA Service status will be **Shutdown** which will need to be reset manually. Reset at Management > PA Reset.

Sub Band	Network	Freq Low	Freq High	DL P_in	Switch	UL ATT	DL ATT	Over DL P_in Alm
1	GSM	869MHz	870MHz	<-80dBm	ON	0dB	0dB	● <input type="checkbox"/>
2	GSM	880MHz	885MHz	<-80dBm	ON	3dB	3dB	● <input type="checkbox"/>
3	GSM	890MHz	894MHz	<-80dBm	ON	3dB	3dB	● <input type="checkbox"/>

Name	Value
RF Switch	ON
PLL Alm	● <input type="checkbox"/>
LNA Alm	● <input type="checkbox"/>
DL PA Alm	● <input type="checkbox"/>
VSWR Alm	● <input type="checkbox"/>
Protection Shut Alm	● <input type="checkbox"/>

Figure 32: RF Unit Detail Information

5.2.2 [COMMISSIONING]

A work flow of the commissioning process is shown on [Commissioning] Screen. Click the [Start] button, the software will guide you through the commissioning step by step. For details, please refer to chapter 5.3.

Work Flow

Start → Site Info Setting → Isolation Detection → RF Setting → Finish

Tips:
Please click the "Start" button to startup the process.

Start

Figure 33: [Commissioning] Screen

5.2.3 [FIRMWARE]

There are two functions on the [Firmware] bar: [upgrade] and [swap]. [Upgrade] is used to upgrade software, and [Swap] is to replace current firmware version to the previous one.

Follow steps shown in below figure to upgrade firmware.

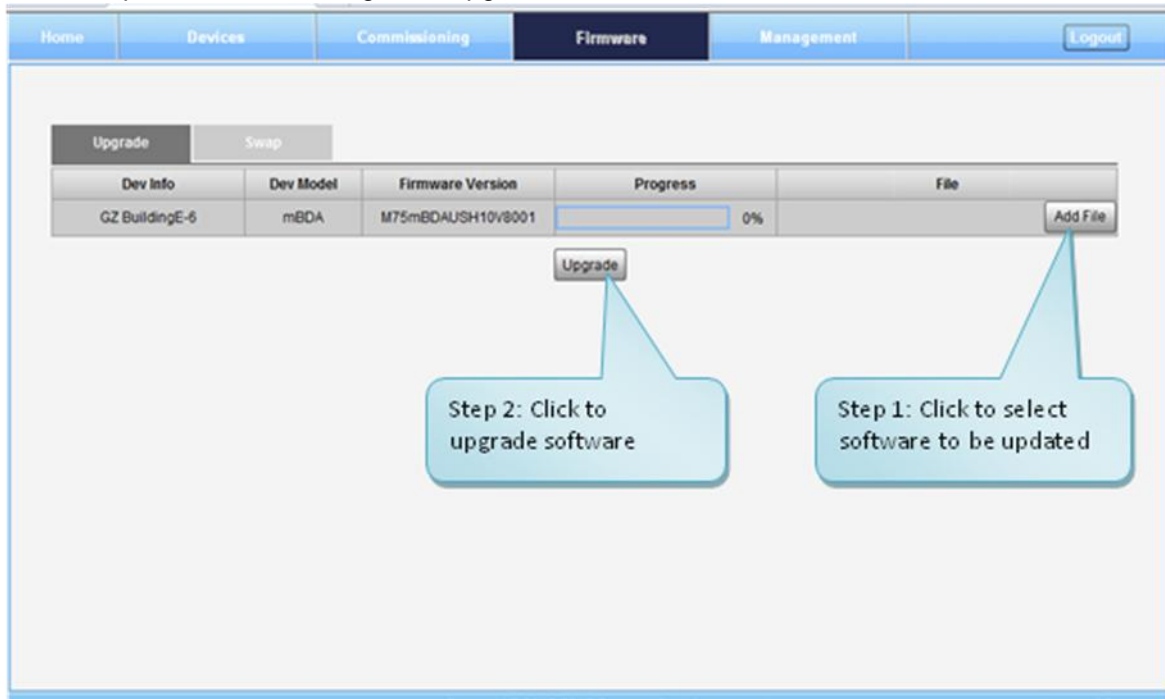

Figure 34: [Firmware] Screen – Upgrade

Step 4: After clicking , a window will pop up and click .

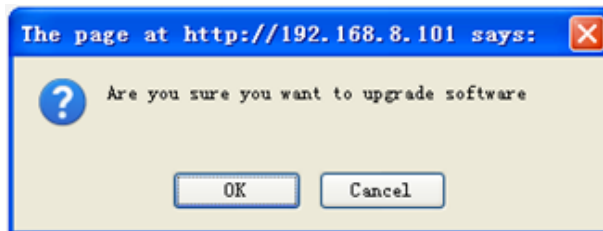

Figure 35: [Firmware] Screen – Pop-up Window 1

Step 5: Wait for 2~4 minutes while mBDA is being reset. Click to continue.

Step 6: Clear browsing history and cookies from browser.

NOTE: For PMU software upgrade, users need to re-login Web GUI after reset is done.

Follow steps shown in below figure to Swap firmware.

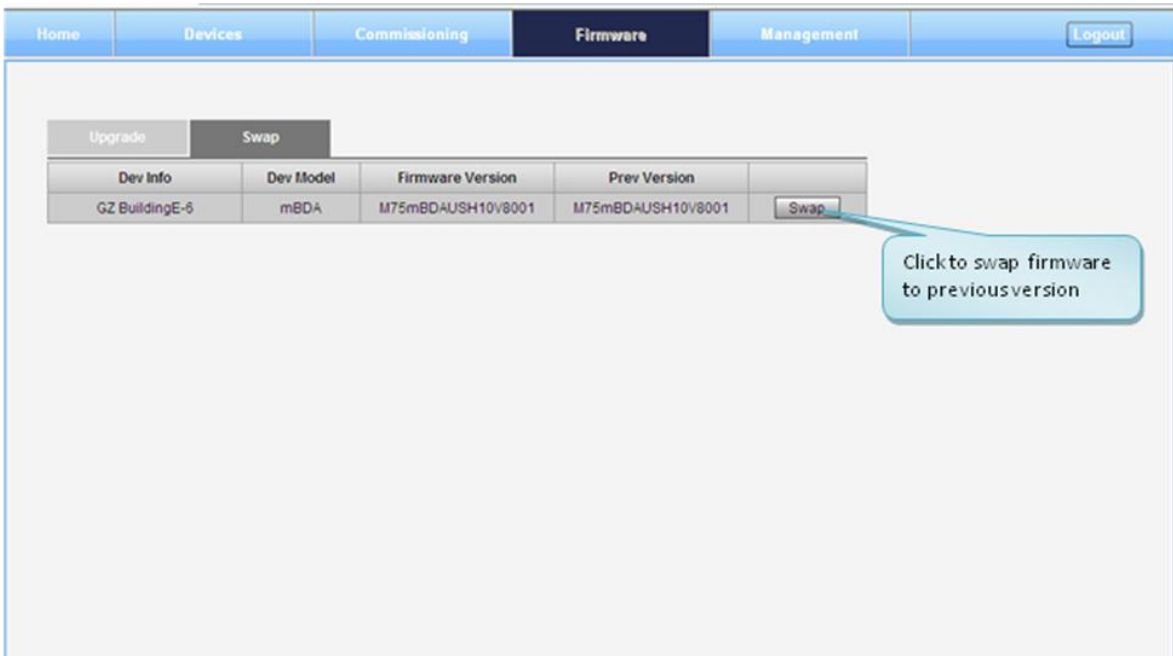

Figure 36: [Firmware] Screen - Swap

5.2.4 [MANAGEMENT]

Other parameters can be configured on [Management] Screen.

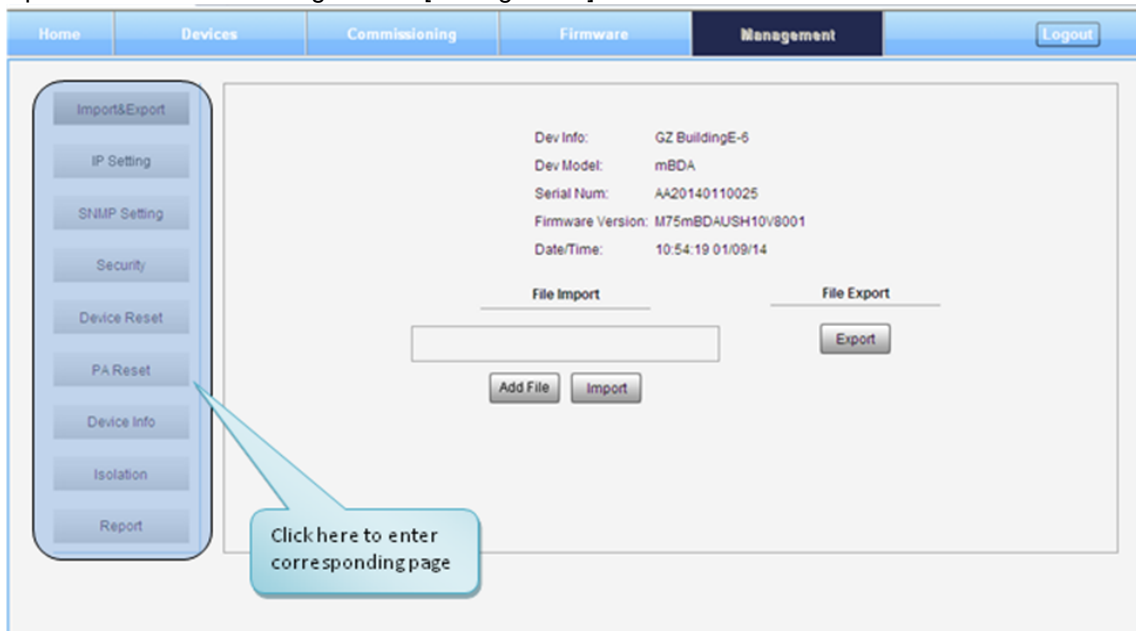

Figure 37: [Management] Screen

There are nine function bars list in the left side of the [Mangement] Screen. Below figures are the introduction of each function bar.

➤ Inport&Export



Figure 38: Management – Import&Export

The parameters that can be import/export as below: sub band, alarm enable, ATT value, RF switch, DL output power and so on.

Import and Export can help users quickly configure mBDA parameters. For example, if one mBDA finished configuration, users can export its parameters and save as a file in PC, and then import this file to other mBDA to fast finish the device parameter setting.

➤ IP Setting

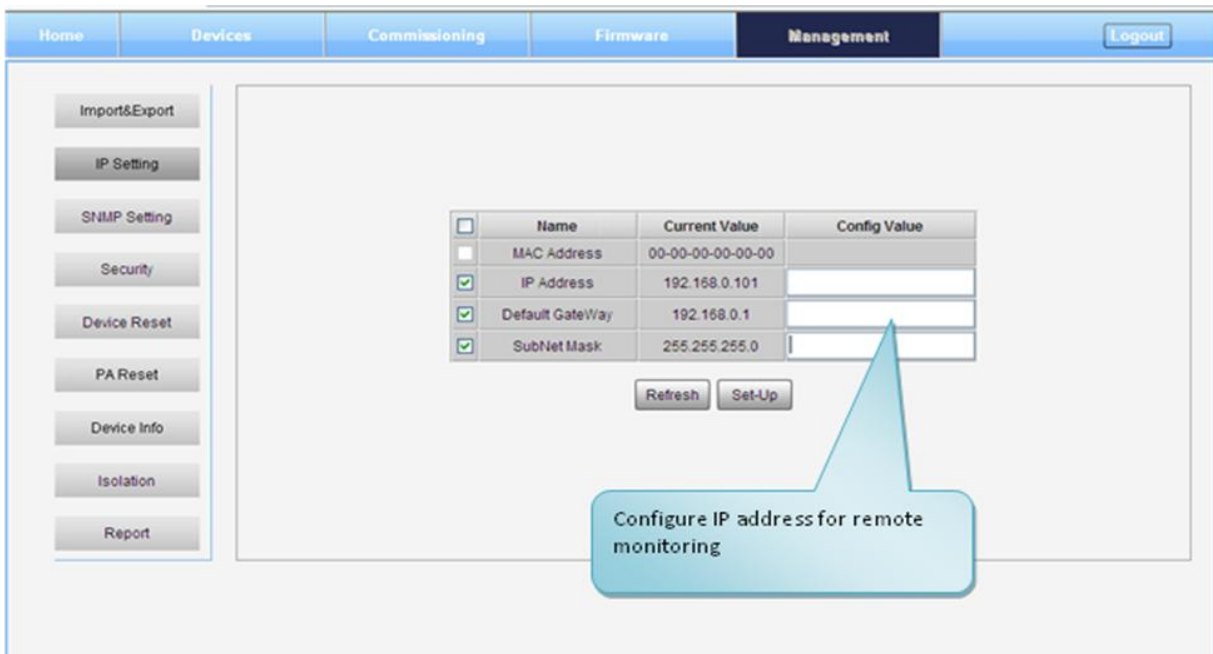

Figure 39: Management – IP Setting

Note: For remote monitoring, the IP Address must be set correctly according to the location IP of remote connection. If more than one equipment is connected to the public network through the same router, the router's local IP **CANNOT** be set as 192.168.8.*.

➤ **SNMP Setting**

<input type="checkbox"/>	Name	Current Value	Config Value
<input type="checkbox"/>	Trap Des: IP1	192.168.8.100	<input type="text"/>
<input type="checkbox"/>	Trap Des: IP2	4.252.80.175	<input type="text"/>
<input type="checkbox"/>	Trap Des: IP3	1.2.3.4	<input type="text"/>
<input type="checkbox"/>	Port Num	161	<input type="text"/>
<input type="checkbox"/>	Read Community	public	<input type="text"/>
<input type="checkbox"/>	Write Community	private	<input type="text"/>
<input type="checkbox"/>	User Name	admin	<input type="text"/>
<input type="checkbox"/>	User Pwd	0123456789	<input type="text"/>
<input type="checkbox"/>	Encry Algorithm	NONE	<input type="text" value="NONE"/>
<input type="checkbox"/>	Version	v2c	<input type="text" value="v2c"/>
<input type="checkbox"/>	Authentication Algorithm	NONE	<input type="text" value="NONE"/>
<input type="checkbox"/>	Authentication Pwd	12345678	<input type="text"/>

Figure 40: Management – SNMP Setting

➤ **Security**

Figure 41: Management – Security

Click , [Modify Password] window will pop-up.

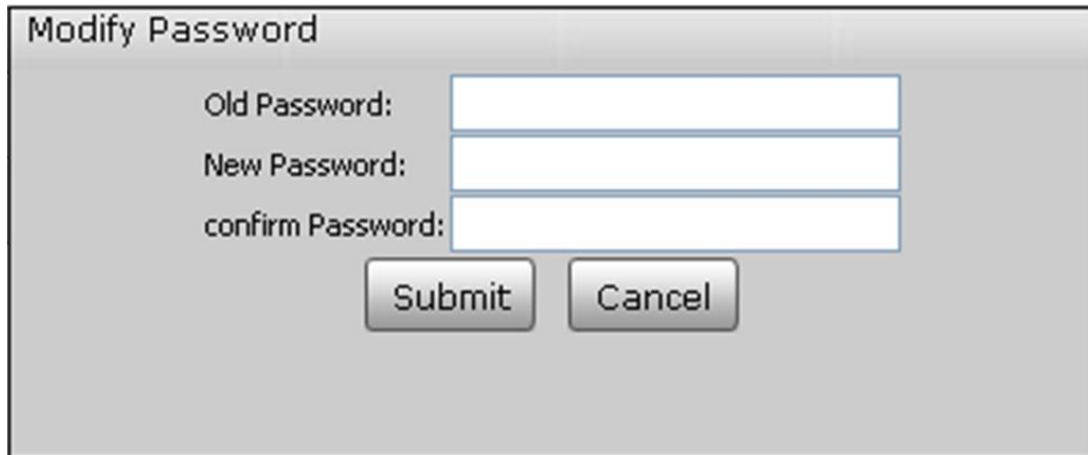

Modify Password

Old Password:

New Password:

confirm Password:

Figure 42: Modify Password

Note: Username cannot be modified.

➤ Device Reset

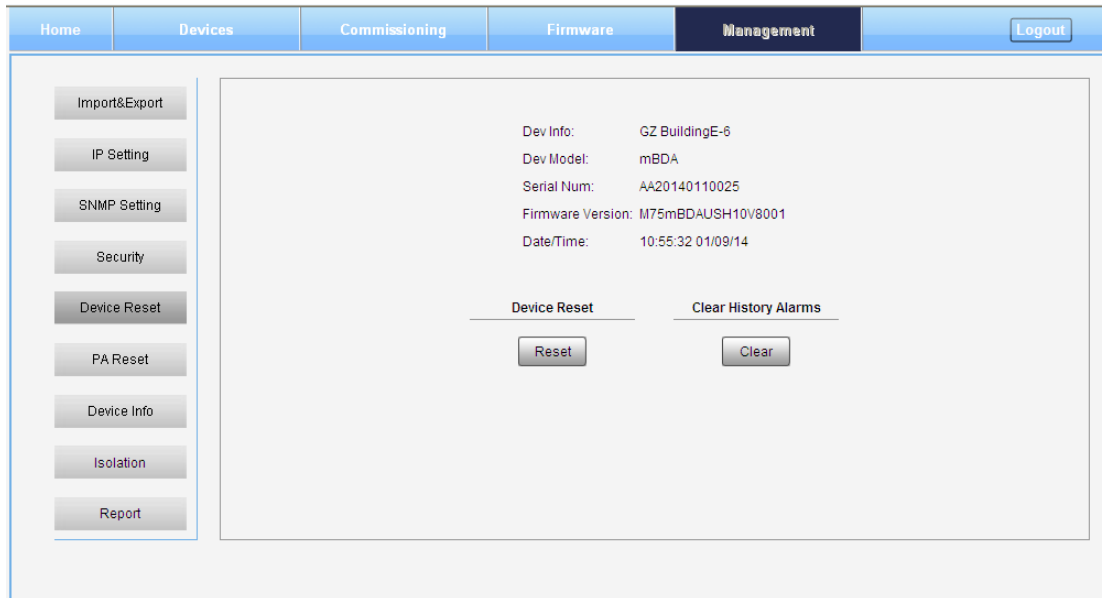

Home Devices Commissioning Firmware Management Logout

Import&Export
IP Setting
SNMP Setting
Security
Device Reset
PA Reset
Device Info
Isolation
Report

Dev Info: GZ BuildingE-6
Dev Model: mBDA
Serial Num: AA20140110025
Firmware Version: M75mBDAUSH10V8001
Date/Time: 10:55:32 01/09/14

Device Reset Clear History Alarms

Reset Clear

Figure 43: Management – Device Reset

Note: If users click , all the parameter and alarm will set to factory default value. Device Reset process will last about 2~4 minutes. For PMU monitor reset, users need to re-login WEB GUI.

➤ PA Reset



Figure 44: Management – PA Reset

Note: PA will be turned off by software when PA output power or (VSWR) reflected power is exceed the threshold. Users need to reset PA after debugging.

➤ Device Info



Figure 45: Management – Device Info

Note: Users can input maximum 30 bytes characters in Device Info.

➤ **Isolation**



Figure 46: Management – Isolation

Note: This Step is the same as step3 of [Commissioning]. Users can check isolation again by clicking Check button.

➤ **Report**

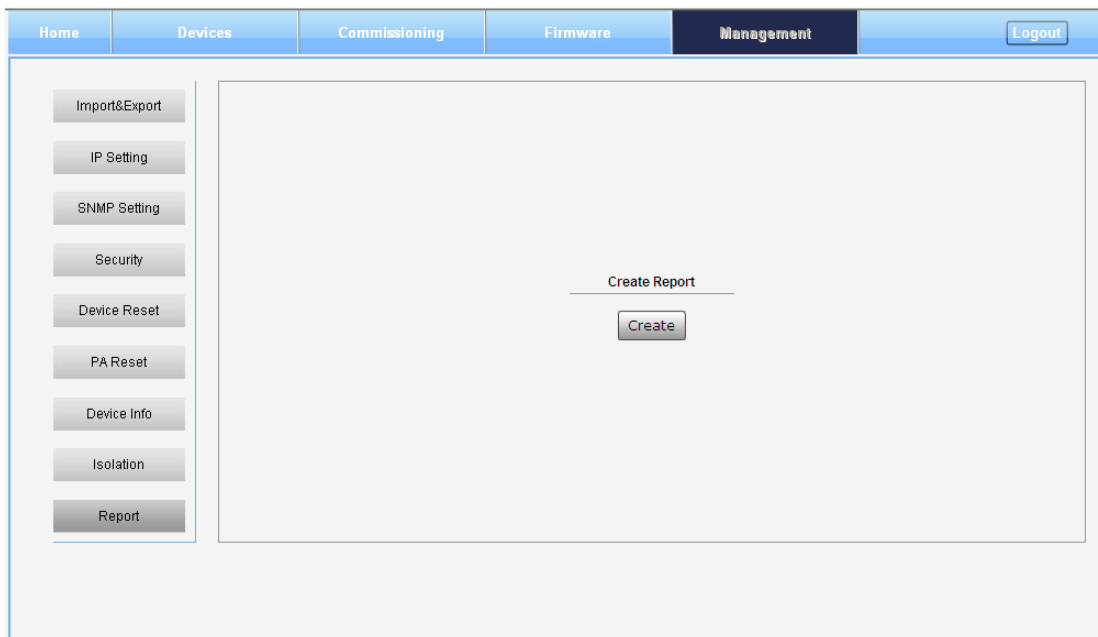

Figure 47: Management – Report

Note: Click Create to create report (The report can't create in IE browser.) and make sure the computer has installed PDF Reader software. If no, users will see nothing.

5.3 COMMISSIONING PROCEDURE

To complete the installation and commissioning, users need to follow the steps below.

Step 1: Click Menu bar [Commissioning] on home screen, a work flow will show up.

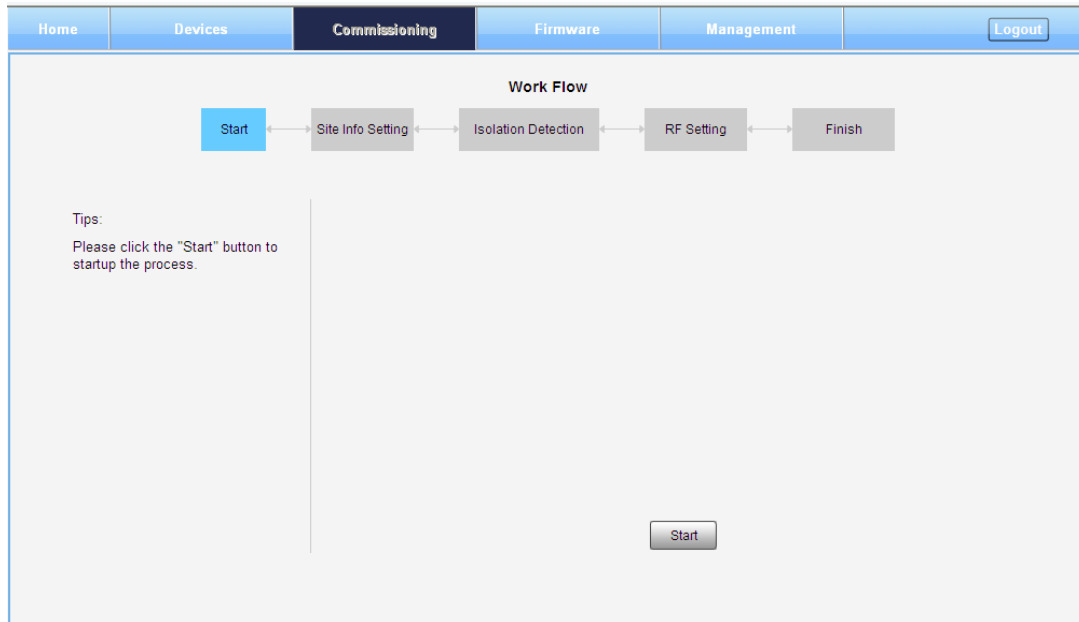

Figure 48: Commissioning Procedure – Start

Step 2: Click  to start the process.

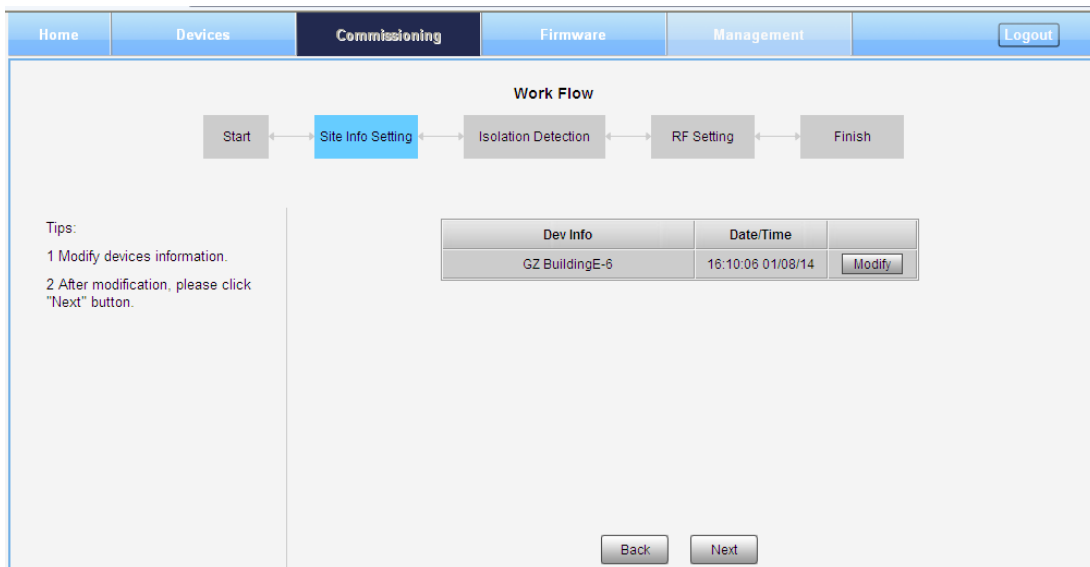
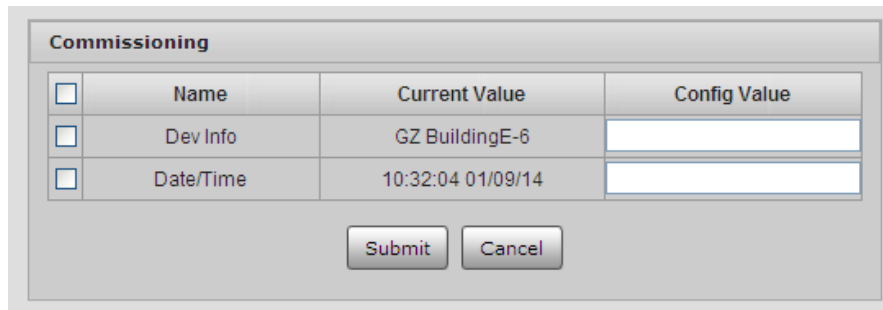

Figure 49: Commissioning Procedure – Site Info. Setting

Step 3: Click , users can set the site information.



<input type="checkbox"/>	Name	Current Value	Config Value
<input type="checkbox"/>	Dev Info	GZ BuildingE-6	
<input type="checkbox"/>	Date/Time	10:32:04 01/09/14	

Figure 50: Dev Info & Date/Time

Dev Info mainly used to record device location and Date/Time provide a time reference. Click the Config Value of Date/Time, will update Date/time automatically.

NOTE: Make sure the device is connected with appropriate donor and service antennas before proceeding to step 4.

Step 4: Click to enter to Isolation Detection Screen shown as Figure 52.

- ✓ Select a frequency band (RFU) that need to commission.
- ✓ Click to start Isolation Detecting, then [Confirm] window will pop-up shown as Figure 53.
- ✓ Click to continue. If isolation detection success, the process will go to RF Setting Screen shown as Figure 55. If failed, a Tips window will pop-up shown as Figure 54, users need to check whether the system isolation is very weak.

NOTE: At the end of first frequency band commissioning, user can start other frequency band commission.

Home | Devices | **Commissioning** | Firmware | Management | Logout

Work Flow

Start ↔ Site Info Setting ↔ **Isolation Detecting** ↔ RF Setting ↔ Finish

Tips:
1 Make sure to connect appropriate donor and service antennas.

	Slot	Freq Band(MHz)	RF Switch	Commissioning
<input type="radio"/>	2	850(MHz)	ON	Not Done
<input type="radio"/>	3	1900(MHz)	ON	Not Done

Back Next

Figure 51: Commissioning Procedure – Isolation Detective

Confirm

Are you sure to connect appropriate donor and service antennas?

Ok Cancel

Figure 52: Commissioning Procedure – Isolation Detective Confirm

Tips:

Isolation detection failed

Ok

Figure 53: Commissioning Procedure –Isolation Detection Failed

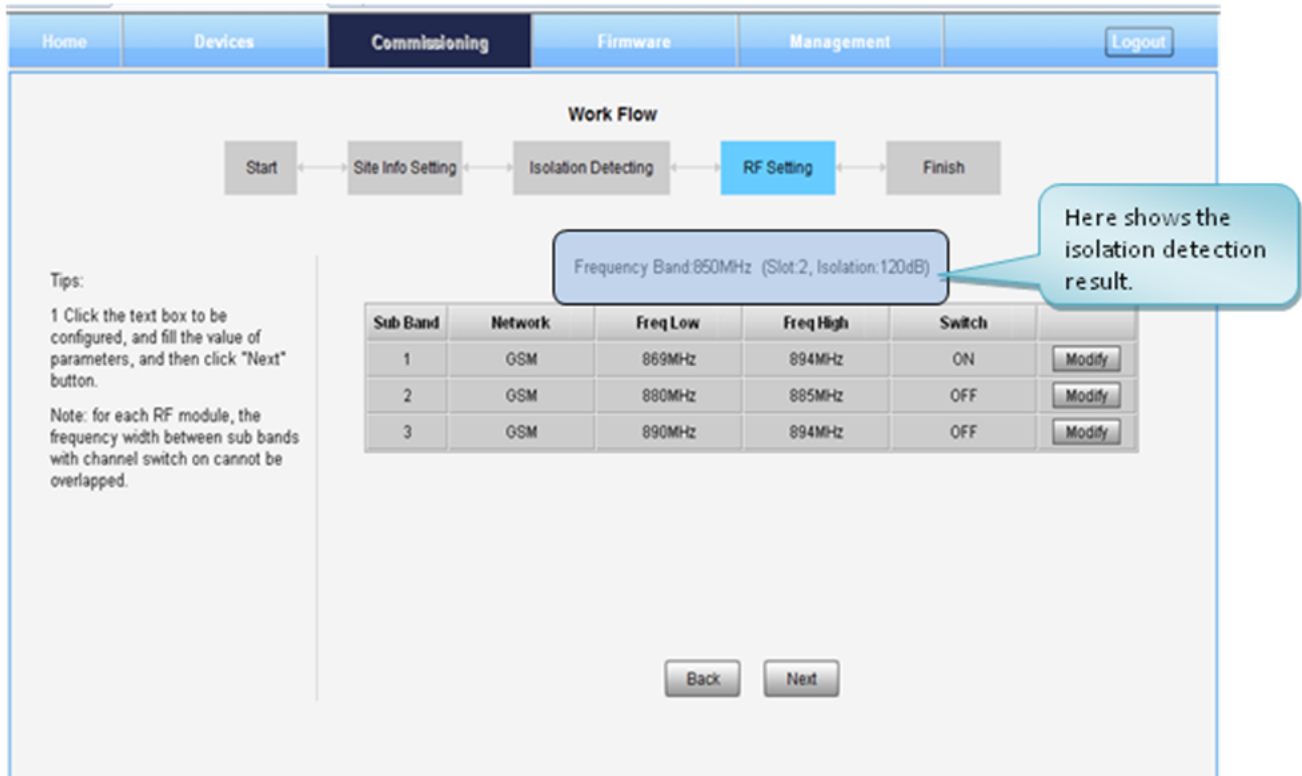

Figure 54: Commissioning Procedure –Isolation Detection Finish

Step 5: RF Setting Screen for setting subband bandwidths and switches.

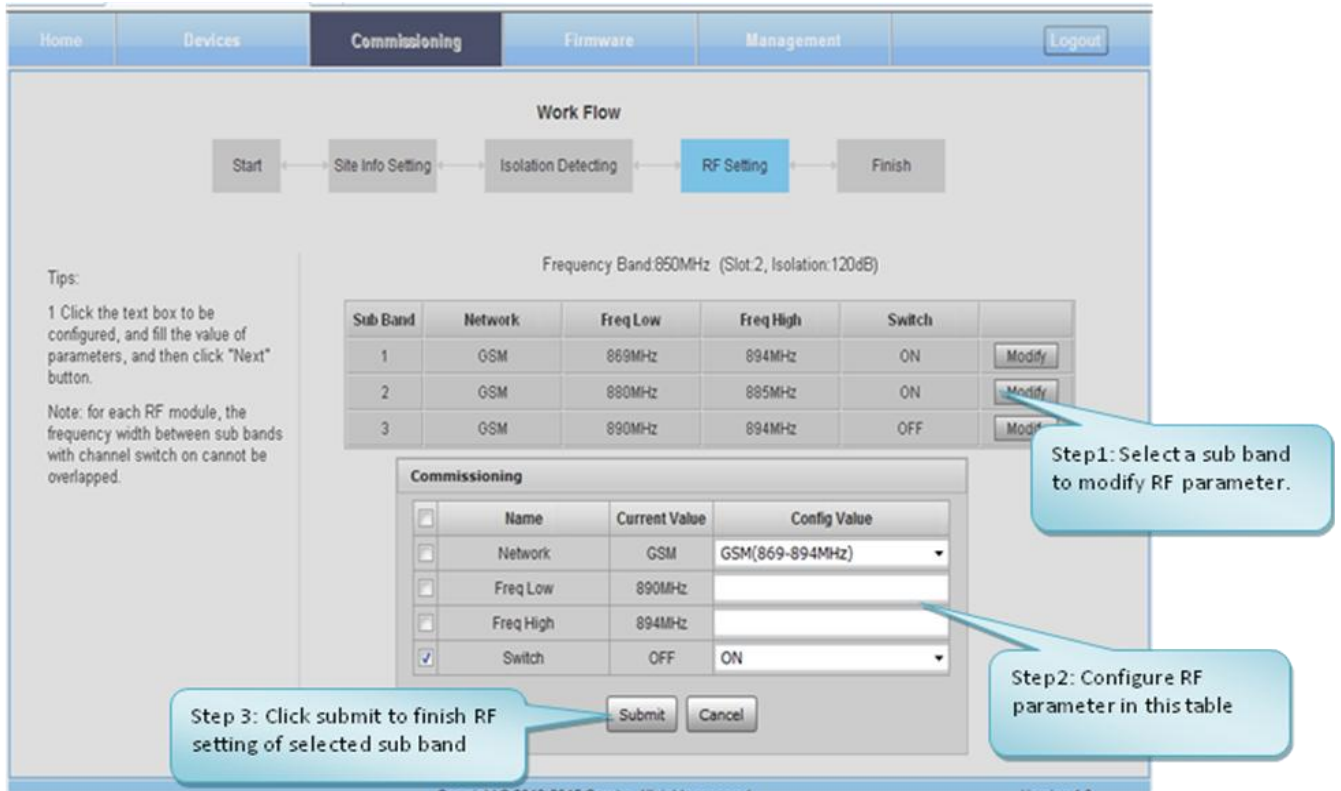

Figure 55: Commissioning Procedure – Subband bandwidth and Switch Setting

NOTE: For each RF module, the 3 subband bandwidth setting should not be overlap each other, if yes, only 1 subband can be turn on, other overlap subband is forbidden to switch on by equipment.

Step 6: Click to enter to DL output power setting after finishing subband bandwidths and switches setting.

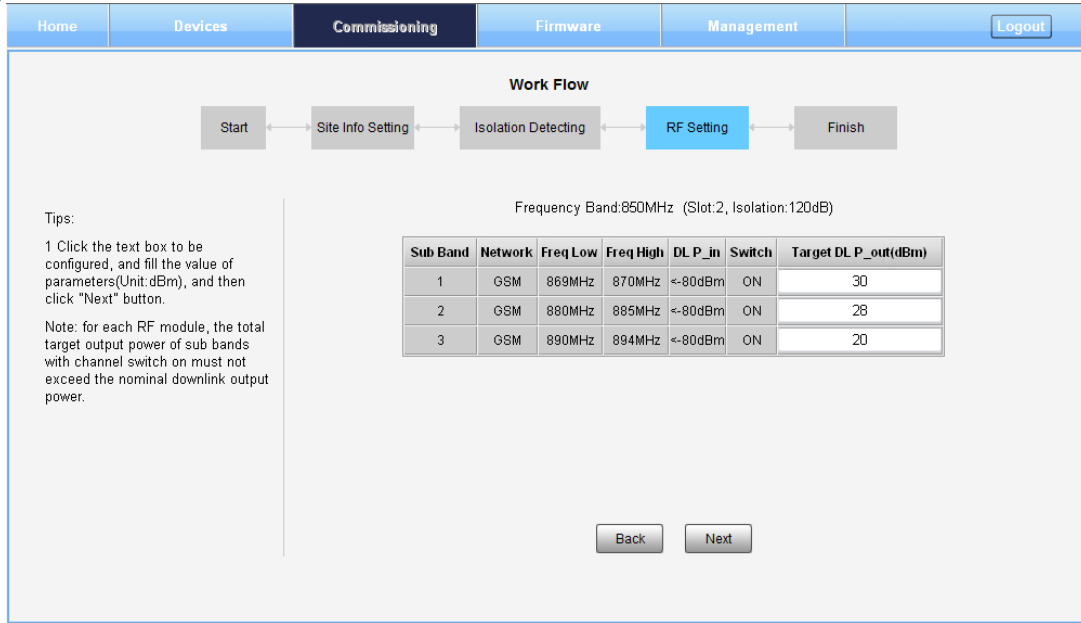

Figure 56: Commissioning Procedure – DL Output Power Setting Screen

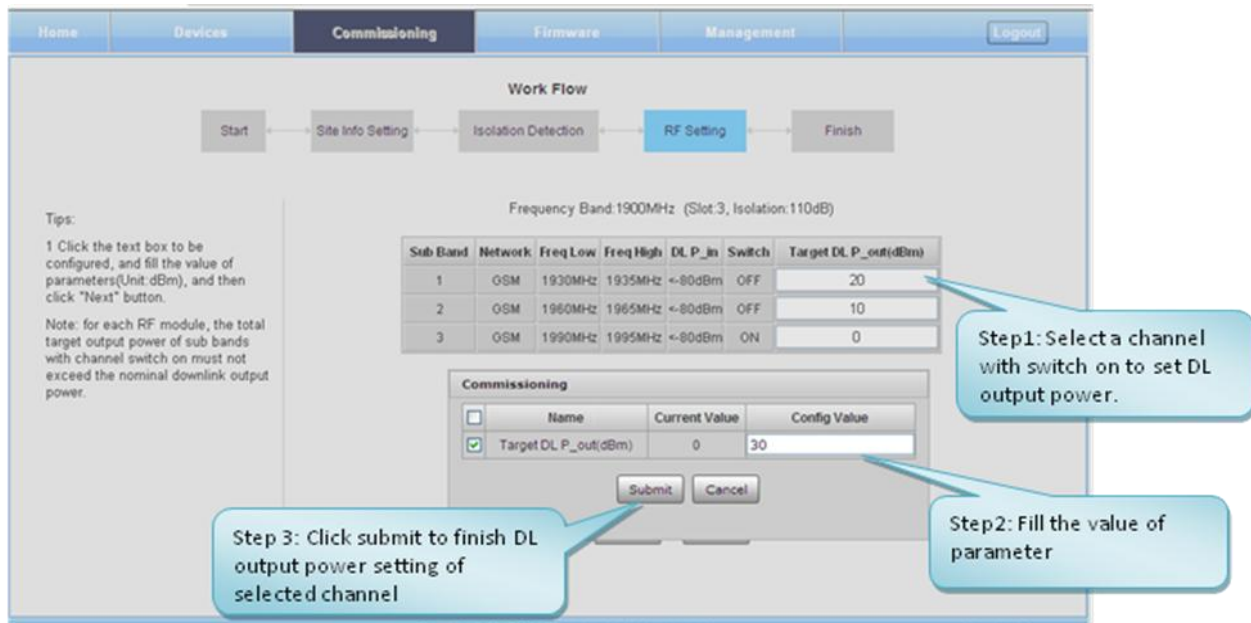

Figure 57: Commissioning Procedure – DL Output Power Setting

NOTE: For each RF module, the total target output power of all subbands which channel switch is on must not exceed the nominal downlink output power (27, 30, 33dBm); if yes, Tips window will pop-up shown as Figure 59. Finish the output power setting, click button , go to Finish Screen shown as Figure 60.

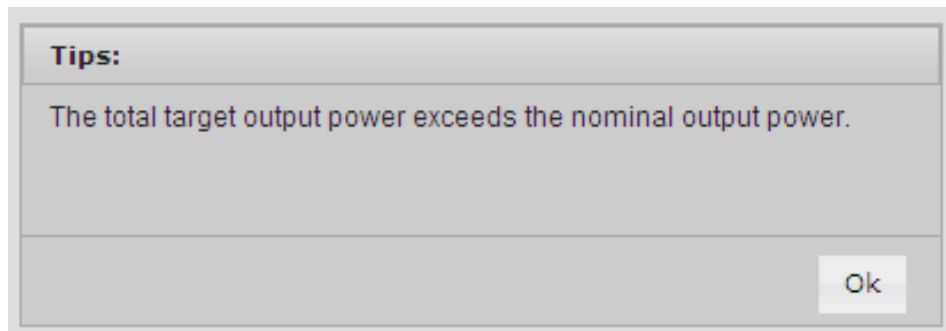

Figure 58: DL Output Power Over Exceed

Step 7: Click **More** to commission other RFUs parameters. Click **Finish** to finish the commissioning.

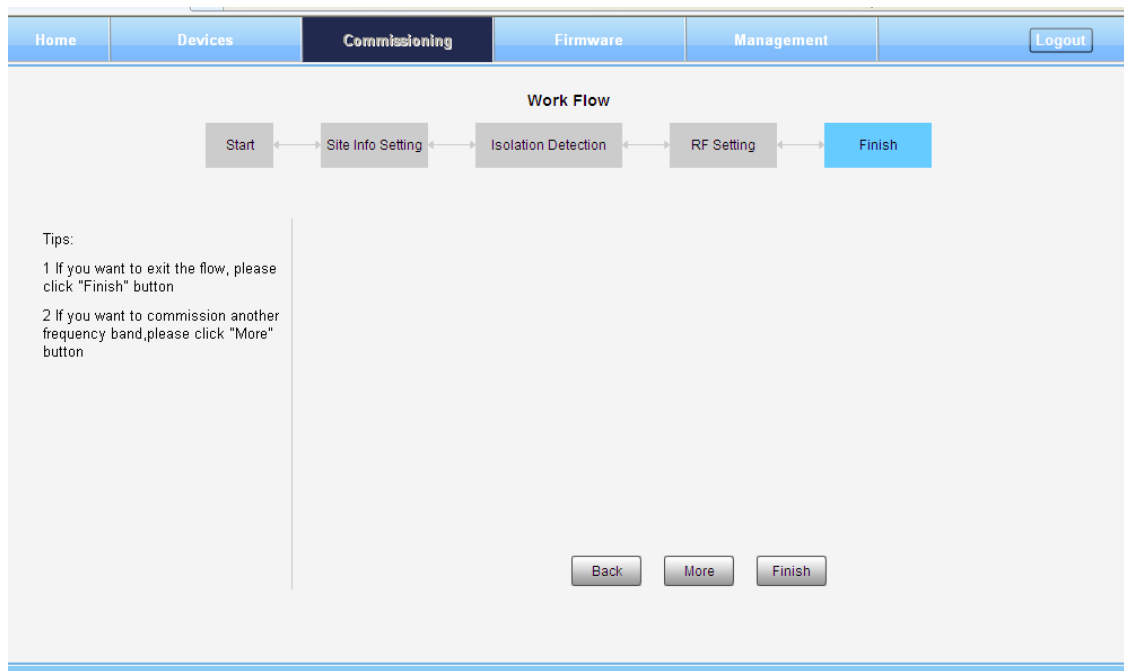

Figure 59: Commissioning Procedure – Finish

End of Section

6 MAINTENANCE

The mBDA is designed for trouble-free operation and generally does not need maintenance. Maintenance activities should only be carried out by trained personnel.

The equipment operation status can be observed remotely through OMC.

Periodic inspection of the repeater equipment(s) is recommended, the recommended tasks includes:

- Inspect and record operation status and output power of the repeater from OMC or OMT.
- Verify the direction and position of antennas. Re-align if necessary.
- Make sure the cable gland and sealing on the RF cable connectors are not damaged.
- Verify lightning and grounding protection is in good condition.

End of Section

7 APPENDICES

7.1 APPENDIX A: TOOLS FOR INSTALLATION AND MAINTENANCE

The following tools (not included in package) are required for installation or routine maintenance:

- Power Drill (for wall mount)
- Adjustable Wrench (0.31 inch~0.79 inch)
- Philips Screwdriver
- Allen wrench (M6)
- Signal generator support output power 10dBm.
- Site Master

7.2 APPENDIX B: RMA (RETURN MATERIAL AUTHORIZATION)



Comba Telecom Ltd.
 611 East Wing, No. 8 Science Park West Avenue, Hong Kong Science Park, Tai Po, Hong Kong
 Tel: +852 2636 6861 Fax: +852 2637 0966

RMA Request Form
 Date: _____

From: _____
 Address: _____
 Tel: _____ Fax: _____
 E-Mail: _____
 ATTN: _____

Product Information:

Item	Model	Serial Number	Return Category	Qty	Problem Description
1					
2					
3					
4					
5					
6					
7					
8					
9					
10					

Notes:
 1. For 'Return Category' column, please select from **A:** Return of Defective Product, **B:** Return of Trial Sample, or **C:** Return of New and Unused Product.
 2. If **A** or **C** category of return product is chosen, please give short description of the problem or reason for returning.

Transportation Information:
 Location of Product: _____
 Transportation Method: _____
 Shipping Forwarder: _____

Note: Location of Product must be stated, while 'Transportation Method' or 'Shipping Forwarder' can be left blank if not determined.

Signature:

For Comba Use (Only)
 Return Merchandise Authorization Number (RMA#): _____
 Recommended Action: _____
 Shipment and Handling Cost to be paid by: _____

Approved by: _____

Date: _____

End of Section

End of Document

FOR NAM OFFICE EMAIL, PLEASE INSERT: support.us@comba-telecom.com



North America Office

Comba Telecom Inc.

235 Charcot Ave, San Jose, CA 95131, USA

Tel: +1 866 802 7961

Fax: +1 408 526 0181

Email: customer.nam@comba-telecom.com

Corporate Headquarters

Comba Telecom Systems Holdings Ltd

611 East Wing, No.8 Science Park West Avenue, Hong Kong Science Park, Hong Kong

Tel: +852 2636 6861

Fax: +852 2637 0966 / +852 2116 6055

www.comba-telecom.com