

Instructions for use

Comfort Digisystem Microphone DM90



Contents

I. User guide.....	7
1. Introduction.....	9
Your device.....	9
2. Getting started.....	15
Charge.....	15
Start up.....	17
Use the neckloop.....	17
Navigate the menu.....	19
Pair a Bluetooth device.....	20
3. Usage.....	23
Telephone conversations.....	23
Conversations and smaller meetings.....	25
External audio sources.....	25
II. For professionals.....	27
1. Basic setup.....	29
Change the menu language.....	29
Wireless transmitter.....	29
Neckloop receiver.....	30
2. Pairing Comfort Digisystem devices.....	31
The pairing button.....	31
Change channel.....	32
Send pairing information.....	33
Receive pairing information.....	34

3. Advanced features.....	37
Microphone modes.....	37
Volume limits.....	38
Bluetooth settings.....	39
Lock the buttons.....	41
Name the device.....	41
PIN code settings.....	41
Reset all settings.....	43
III. Product information.....	45
1. Menu overview.....	47
Back.....	47
Bluetooth.....	47
Key Lock.....	48
Advanced.....	48
2. Function indicator.....	49
3. Optional accessories.....	51
4. Technical specifications.....	53
IV. Miscellaneous.....	55
1. Radio.....	57
Channel planning.....	57
Radio range.....	57
2. Battery maintenance.....	59
3. Troubleshooting.....	61

Service and warranty.....	63
Contact information.....	65
Product symbols.....	67

I. User guide

1. Introduction

Thank you for choosing Microphone DM90!

Microphone DM90 is part of *Comfort Digisystem™* that uses digital wireless technology to give you the best sound quality available, together with secured transmission to prevent eavesdropping.

To get the most out of your new product, please read these instructions before using it for the first time. Take special notice to the printed document *Important Safety Instructions* included in the box.

Your device

Microphone DM90 is a telephone solution for your hearing aid. It can be used either in conjunction with one of Comfort Audio's ear level receivers, or by it self with the accompanying neckloop. Consult your hearing care professional to decide which option is right for you.

It also doubles as a conversation amplifier for the occasions when your hearing aid alone is not sufficient.

Bluetooth®





Thanks to Bluetooth technology this product can be used as a wireless handsfree for any Bluetooth equipped phone. It also supports audio streaming from devices such as smart phones and computers.

SST™

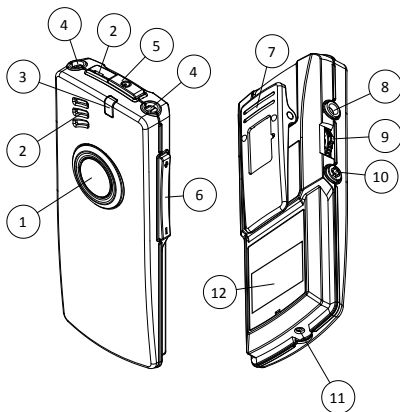
SecureStream Technology (SST) is Comfort Audio's proprietary digital transmission technology. It lets you communicate securely and latency free with other Comfort Digisystem devices.

Overview



1. Answer button 
2. Microphone
3. Function indicator
4. Neckloop output
5. Power button 
6. Volume button 
7. Clip
8. Aux input and output
9. Menu controller 
10. Pairing button 
11. Charger input
12. Display

Display

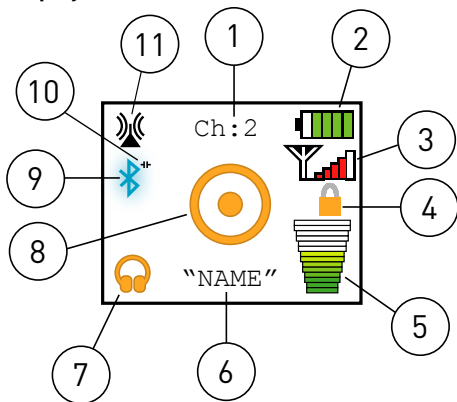

1. Current channel
2. Battery status
3. Signal strength
4. Key lock padlock
5. Volume bar
6. Unit name
7. Current aux setting
8. Current microphone mode
9. Bluetooth enabled
10. Bluetooth connection status
11. Current SST mode

Included accessories

Microfibre pouch

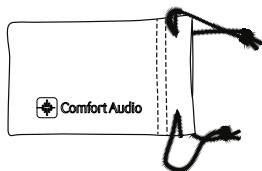

Clip on microphone

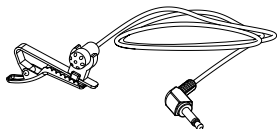

Power supply

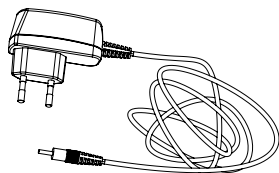

Cable split



Neck loop Digisystem

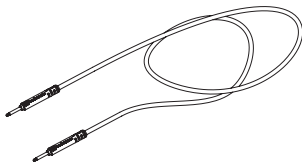

Audio-kit

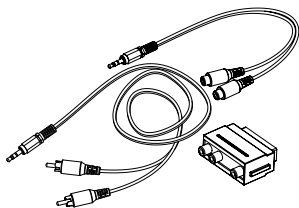

Car charger incl USB

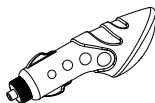

2. Getting started

This section will teach you how to perform the basic steps needed to get started.

Charge

Charging can be done at any time. If you make it routine to charge the unit whenever you do not use it, the unit is always ready for use when you need it.

1. Insert the supplied charger into the charger input.

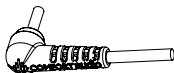

Caution: Only use the charger supplied by Comfort Audio AB. Using any other type of charger might damage your device.

2. Plug the charger into the wall socket.

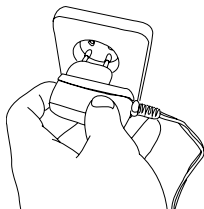

The function indicator turns red to indicate charging.



Note: *The unit might become warm during charging, this is entirely normal. The unit is equipped with overcharging- and temperature monitoring to protect the batteries.*

The charging is done when the function indicator turns green.

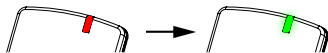

Start up

Press  until the start up bar is fully lit.

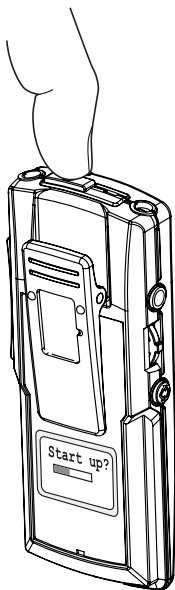

Use the neckloop

If you are going to use your product with a hearing aid or hearing implant in the T- or M/T-position, you need to connect the neckloop and wear it around your neck.

1. Connect one end of the neckloop to the sockets on top of the unit.

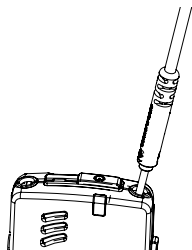

2. Place the neckloop behind your neck.

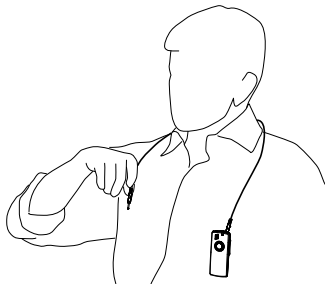

3. Connect the other end of the neckloop.



Important: Make sure the neckloop is inserted properly. Improper insertion might cause you to drop the device or damage the connections.

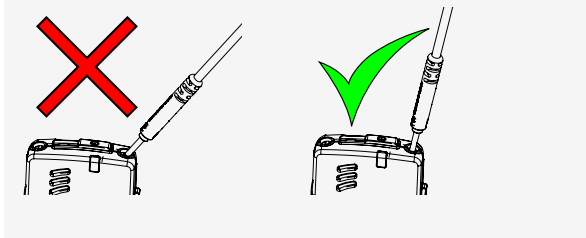

4. Switch your hearing aid or hearing implant into its T- or M/T-position.

You should now hear the sound come through your hearing aid.

Navigate the menu

You can use  on the side of the unit to navigate your way through the menu.

1. Press  to activate the menu.



2. Flick the controller up or down to select the desired menu option.



3. Press  to enter the selected sub menu or activate the selected menu option.
4. When done, use the **Back** option to move to the previous menu.

Pair a Bluetooth device

Microphone DM90 and the Bluetooth device needs to be *paired* before they can be used together.

1. From Microphone DM90, select **Bluetooth > Pair BT**.
The pairing sequence will start, which means that the unit is discoverable by any Bluetooth device.



2. Search for new equipment on your Bluetooth device (please refer to your user manual).
3. When found, select DM90 in the list of found devices.
4. If asked for a PIN, enter the PIN code shown in the display of your Comfort Digisystem unit.

If the pairing is successful `Paired with` and the name of your Bluetooth device will appear in the display.

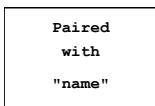

3. Usage

Your product is highly flexible and well suited for several situations where good speech perception is important.

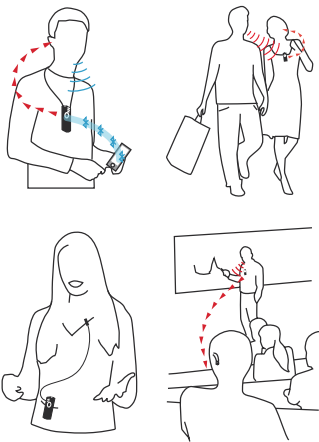

Telephone conversations

Hearing on the phone is often difficult when using hearing aids. Your Microphone DM90 can help you hear clearly on a Bluetooth enabled phone.

Answer a call

When the phone rings, the text *Answer?* will be shown in the display.

1. To answer, press .



2. When done talking, hang up by pressing  again, or by using your phone.

Make a call

Microphone DM90 needs to be paired with your telephone.

On most phones you can initiate a call from the phone or via the Bluetooth headset.

1. Use *one* of the following methods to make a call:

Option	Description
Use your phone to dial the number.	The sound will automatically be transferred to Microphone DM90.
Re-dial the last called number.	Press  for approx. 2 sec.
Activate voice dialing.	Press  briefly, approx 1/2 sec.



Note: *The different dialing options is dependent on the phone being used. Please refer to the user manual of your phone.*

2. When done talking, hang up by pressing  again, or by using your phone.

Conversations and smaller meetings

A hearing aid is usually not enough if you are to hear well at work. Background noise such as murmur, telephone signals, and the scrape of chairs makes it difficult to hear what your colleagues are saying.

Use as a conversation amplifier

The built-in microphone lets you use your product as a conversation amplifier to amplify the voices of persons within close range.

1. Make sure the neckloop is connected and hung around your neck.
2. Switch your hearing aid into the appropriate program.

Option	Description
FM or FM/M	If you are using a mini receiver.
T or M/T	If you are using a neckloop.

3. Adjust the volume by using  till you find a suitable level.



Tip: The built-in microphone can be toggled on and off at any time by pushing  downward for 3 sec.

External audio sources

You can connect any sound source that has a line out socket to your device. This lets you listen to radio, conference telephones,

voice recorders and the like. It is also possible to connect an external microphone, such as the included clip-on microphone, or a pair of headphones.

Connect an external audio source

Connecting an external audio source will bring up a menu where you can select the type of device you have connected.

- 1.** Connect your external audio source to the aux output.
For line sources you can use the supplied audio cable.
- 2.** Select the option that corresponds to the device you have connected.

Option	Description
Line In	Computer, TV, music player etc.
Extern Mic	Boom microphone, clip on microphone etc.
Head Phones	Headphones or earphones.

- 3.** Adjust the volume by using  till you find a suitable level.

II. For professionals

The following sections covers advanced features and procedures primarily intended for professionals and advanced users.

1. Basic setup

Before setting up the product, you should decide whether it should be used as a transmitter or a receiver. You should also make sure that the menu is set to the preferred language.

Change the menu language

The default menu language is English. You can change language from the menu **Settings**.

1. Select **Advanced > Settings > Language**.
2. Select the language you want from the list of available languages.

Wireless transmitter

When used together with an ear level receiver, such as Micro Receiver DT20 or Receiver DE10, Microphone DM90 can be set to transmit the sound wirelessly by radio. The built in microphone will then act as a close range microphone that can be used as a conversation amplifier or, for example, a lecture microphone at meetings.

This option is likely to provide the best sound quality as there is no risk of interference from stray magnetic fields.

Configure Microphone DM90 as a transmitter

If you opt for an ear level receiver, your unit should be configured as transmitter.

1. Select **Advanced > SST Radio > Mode**.
2. Check **Transmitter**.

3. Adjust the volume by using  till you find a suitable level.

Neckloop receiver

If the hearing aid used with Microphone DM90 is equipped with a telecoil, the microphone can act as a neckloop receiver for other Comfort Digisystem microphones. This lets you combine it with a range of microphones that provides solutions for several common problem areas. This solution is convenient if, for example, the hearing aid does not have a DAI connection.

Configure Microphone DM90 as a receiver

By configuring Microphone DM90 as a receiver for a Comfort Digisystem microphone, the sound will be transferred to the hearing aid through the neckloop.

1. Select **Advanced > SST Radio > Mode**.
2. Check **Receiver**.

2. Pairing Comfort Digisystem devices

By pairing two or more Comfort Digisystem devices you ensure that they can communicate securely with each other.

Comfort Digisystem is a digitally encrypted communication system that relies on unique *code keys* to provide transmission security. Any units that are to be used together needs to be set to the same channel and share the same code key.

When you perform a pairing procedure you send information about the channel and code key from one unit to one or several others. This lets you create a channel and code key combination on one unit and distribute it to other units to form a system.

The information about the channel and code key is referred to as *pairing information*. Microphone DM90 is able to both send and receive pairing information.



Important: *At delivery all units share the same factory code key. To make the system secure, you need to generate a new code key.*

The pairing button

All Comfort Digisystem units are equipped with a pairing button. The pairing button gives you quick access to the pairing features of the device.



Table 1: Pairing short cuts accessible through the pairing button.

Option	Description
A single press.	Takes you to the pairing menu.
A long press.	Sets the unit to receive pairing information. (For units with more than one channel, this affects the transmitter channel only.)
A double press.	Sends pairing information. (For units with more than one channel, this affects the transmitter channel only.)

Change channel

If a channel does not suit your setup, or if you are experiencing interference from some other radio source, you can change to a different channel via the **Channel** menu.

1. Select **Advanced > SST Radio > Channel**.
2. Choose the channel you wish to use in the channel list.

Back
1 863.250 MHz 
2 864.000 MHz 
3 864.750 MHz 

The green circle next to the frequency indicates that the channel is free from interference. If the channel is occupied the circle will be grey.

Available channels



Comfort Digisystem has a total of 38 channels to choose from. These channels should not require a license in North America. However, always verify with the local frequency assignment authority which channels are free to use and which require a licence.

Send pairing information

By sending pairing information from Microphone DM90 you can synchronise its channel and code key with another unit. Any existing pairing information in the other unit will be overwritten.

1. Select **Advanced > SST Radio > Pair**
2. Set the unit or units that you would like to pair with Microphone DM90 to receive pairing information.

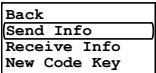
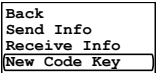
3. To send the pairing information, select *one* of the following options:

Option	Description
<p>Send Info</p>  <p>Back Send Info Receive Info New Code Key</p>	<p>Send the <i>existing</i> code key.</p>
<p>New Code Key</p>  <p>Back Send Info Receive Info New Code Key</p>	<p>Generate and send a <i>new</i> code key.</p> <p> Important: This will break the pairing with any previously paired units.</p>

When the info is sent the text `Info sent!` will appear in the display.

Receive pairing information

When the unit is set to receive pairing information its current channel and code key will be overwritten by the received information.

1. Set the unit to receive information by selecting **Advanced** > **SST Radio** > **Pair**.
2. Select **Receive Info**.
3. Send pairing information from the unit you are pairing with Microphone DM90.

If the pairing is successful, the word OK will appear in the display of Microphone DM90.

3. Advanced features



This product has several features and settings that lets you tailor the unit to the user's specific needs.

Microphone modes

The product features two different microphones modes; one *omni directional*, which picks ups sound from all directions and a *zoom mode*, which picks up sound primarily from the forward direction. The zoom mode is useful in noisy environments or if there is a need to isolate a particular sound source. The zoom mode is the default mode for telephony.

The active microphone mode is indicated by the symbol in the center of the display.

Table 2: Microphone mode symbols

Symbol	Description
	Omni directional mode. Default for conversations.
	Zoom mode. Default for telephony.

Disable the zoom mode for telephony

If you prefer the omni directional mode you can disable the zoom mode for the Bluetooth units.

You can disable the zoom mode for each unit separately. This allows you to use different settings for different applications.

1. Select **Bluetooth > BT Units**.
2. Select the BT unit that you like to adjust.
3. Clear the **Zoom Mic** check box.

Enable the zoom microphone for conversations

If you prefer the zoom microphone during conversations you can enable it from the audio settings.

Check **Advanced > Audio > Zoom Mic**.

Volume limits

Setting the volume too loud can be unpleasant and potentially cause damage to the hearing. This product is equipped with a maximum volume feature that limits the loudness to a predefined level that you deem safe. You can also set a fixed volume level if you prefer control of the volume from the hearing aid only.

Set a maximum volume level

To prevent the volume from being turned up too loud by accident, you can set a maximum allowed volume level.

1. Select **Advanced > Audio > Max Volume**.
2. Select **Settings** under **Max Volume**.
3. Adjust the volume to the desired level.
4. Press  to confirm your choice.

Set a fixed volume level

If there is no need of a user adjustable volume, you can lock the volume to a fixed level.

1. Select **Advanced > Audio > Max Volume**.

2. Select **Settings** under **Fix Volume**.
3. Adjust the volume to the desired level.
4. Press  to confirm your choice.

Bluetooth settings

Each of the paired Bluetooth units has their own settings that let you customise things such as call volume and microphone sensitivity. This is useful if for example a particular phone does not produce enough output volume or if the receiving party finds the voice output too weak or strong. The settings can be adjusted during a phone call.



Set the default unit

The Bluetooth device set as the default unit will be used for phone specific features such as voice dialing.

1. Select **Bluetooth > BT Units**.
2. Select the BT unit you want to set as default and check **Default Unit**.

Adjust the volume for the user



To compensate for differences between telephones, you can fine tune the sound level from the phone. This affects the sound that the user hears.

1. Select **Bluetooth > BT Units**.
2. From the list of paired devices, select the BT unit that you like to adjust.
3. Select **Sound Lev.** and adjust the level by flicking  up or down.
4. Press  to confirm your choice.

Adjust the volume for the receiving party

If the receiving party finds the volume to be unsatisfactory you can fine tune the microphone sensitivity by ± 6 dB.

The output volume can vary between different telephones and brands, so it is advisable to verify that you have an acceptable volume for each of the paired telephones.

1. Select **Bluetooth > BT Units**.
2. From the list of paired devices, select the BT unit that you like to adjust.
3. Select **Mic Sens.** and adjust the level by flicking  up or down.
4. Press  to confirm your choice.

Activate voice monitoring

Hearing your own voice during telephone calls can prevent you from talking to loud or feeling confined. Monitoring can be activated for each of the paired BT units separately.

1. Select **Bluetooth > BT Units**.
2. From the list of paired devices, select the BT unit that you like to adjust.
3. Select **Settings**.
4. Check **Own Voice**.

Delete a Bluetooth unit

Microphone DM90 can be paired to a maximum of two Bluetooth units. If you need to pair a third unit, you have to delete one of the previous units.

1. Select **Bluetooth > BT Units**.

2. Select the unit you wish to delete.
3. Select **Delete Unit**.

Lock the buttons



If you want to avoid accidental button presses it is possible to lock all functions by activating the key lock. (You can always use the power button regardless of the key lock.)

Select **Key Lock**.

An orange padlock symbol will appear in the display of Microphone DM90

Name the device

To help identify the device, you can enter a name that will be shown in the display and during Bluetooth pairing.



1. Select **Advanced > Settings > Name**.
2. Use  to scroll through the list of characters. Press  to enter the selected character.
3. When done select ✓. (To cancel, select X instead.)

PIN code settings

To prevent tampering or unintentional changes of the settings, you can lock the product with a four digit PIN code.

Set a PIN Code

1. Select **Advanced > Settings > PIN Code**.
2. Check **Enabled**.

- Use  to scroll through the list of characters. Press  to enter the selected character.

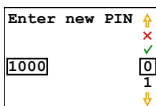

- When done select ✓. (To cancel, select X instead.)



Important: Make note of the PIN code. If you forget the PIN, contact your point of purchase.

Choose which functions to lock

By selecting which functions to lock with the PIN code you can allow access to commonly used functions while preventing access to others.

- Select **Advanced > Settings > PIN Code > Lock Select.**
- Select the functions you want to lock:

Option	Description
Advanced	Lock access to the advanced menu.
All Menus	Lock access to all menus.

Change PIN code

- Select **Advanced > Settings > PIN Code.**

2. Enter the current PIN code.
3. Select **Change PIN**.
4. Enter the new PIN code.
5. Select ✓ to confirm PIN.

Disable the PIN code

If you no longer wish to lock access to the unit, you can disable the PIN code. The PIN will be reset and a new code will have to be entered if you choose to enable it again.

1. Select **Advanced > Settings > PIN Code**.
2. Enter the current PIN code.
3. Uncheck the **Enabled** option.

Reset all settings

If you need to reset all settings to their default values, you can do a factory reset.

Select **Advanced > Settings > Factory Reset**.



Important: All settings will be lost. Any pairing needs to be redone.

III. Product information

1. Menu overview

Back

Bluetooth

Back

Enable

Mix level

Pair BT

BT Units

Key Lock

Advanced

Back

Aux in/out

Audio

SST Radio

Settings

About

Back

Leave the current menu.

Bluetooth

This menu contains Bluetooth options and lets you pair the unit with other Bluetooth devices.

Enable

Activate and deactivate the Bluetooth function.

Mix level

Set the level of your own voice during phone calls.

Pair BT Start the Bluetooth pairing procedure.

BT Units List your paired Bluetooth devices and access their settings.

Key Lock

Manually activate the key lock.

Advanced

The menu **Advanced** contains advanced settings that lets you adapt the product to your specific needs.

Aux in/out Various level adjustments and settings for sound sources connected to the aux socket.

Audio Settings for maximum volume and tone controls.

SST Radio Settings for radio channels and pairing.

Settings General settings.

About Information about the firmware version.

2. Function indicator

The *function indicator* gives you information about the units current status.



Table 3: Pairing indications

Status	Indication
Ready to receive pairing information	//... ■ ■ ■ ■ ■ ■ ■ ■ ...//
Pairing information sent.	// ■ ■ ■ ■ ■ ■ ■ ■ //
Information received	// ██████████ //





Table 4: Charging indications

Status	Indication
Charging in progress	//... ██████████ ...//
Charging complete	//... ██████████ ...//
Low battery	//... ■ ...//... ■ ...//... ■ ...//



Note: If the unit is on while charging the function indicator stays red even when the battery is fully charged.

Table 5: Bluetooth indications

Status	Indication
Pairing mode active	//...  ...//
Pairing successful	//  //
Call in progress	//...  ...  ...//
Settings cleared	//  //

3. Optional accessories

The following accessories can be used with your product:

Soft case



Charging stand

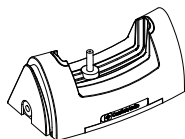
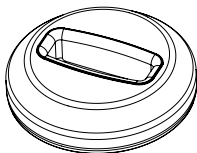
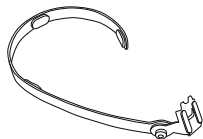

Table stand



Neckholder



Boom microphone, black

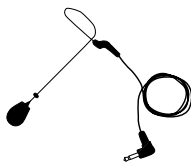

Boom microphone, beige

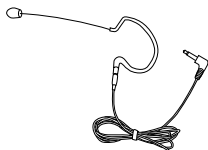

4. Technical specifications

Type of transmitter/receiver	SST - SecureStream Technology
Range	Approx. 30 m
Dimensions	97 x 41 x 17 mm
Weight	55 g
Frequency range transmitter	904.65 - 926.85 MHz
Frequency range receiver	904.65 - 926.85 MHz
Antennas	Built-in
Operating time	Approx. 9 hours. Dependent on usage conditions. Measured with factory settings.
Charging time	Approx. 3 hours.
Microphone	Built-in microphones, directional and omnidirectional
Connections	Mic, Line in, headphones, neckloop
Bluetooth protocol	Version 2.1
Supported profiles	<i>Handsfree Profile (HFP), Headset Profile (HSP), Advanced Audio Distribution Profile (A2DP)</i>

IV. Miscellaneous

1. Radio

Comfort Digisystem relies on radio technology to transfer the sound between transmitters and receivers. Like all radio systems, it communicates on specific channels. If you use two transmitters on the same channel, or neighbouring ones, there may be interference. Other electronic equipment can also interfere with radio transmissions.

Channel planning

To achieve optimal radio performance you need to take into account the distance between transmitters and their frequencies. A longer distance between transmitters allows you to use frequencies that are closer together.

If several transmitting frequencies are being used in the same room, the frequency differences between the units should be at least 1 MHz for optimal operation.

Radio range

The radio range between the units is around 30 metres. However, this may vary depending on the particular environment you are in.

2. Battery maintenance

This product has a built in Lithium-Ion Polymer battery. Lithium-Ion batteries do not suffer from so called memory effects and do not need to be routinely discharged to preserve performance.

The battery's capacity will degrade over time. This is normal for all rechargeable batteries. Battery lifetime is dependent on usage patterns. The battery is preferably charged little and often; it will reach 90% of its capacity after half its charging time. If stored for long periods of time, the battery is best left semi-charged. Contact your point of purchase when it is time to change the battery.

Operating times vary depending on which features are used. Features such as Bluetooth can be disabled to extend operating times.

3. Troubleshooting

Consult the following guide if you have problems with your equipment. If you still have questions, please contact your point of purchase.

Symptom	Cause	Solution
<ul style="list-style-type: none">The device does not start.	<ul style="list-style-type: none">The battery is depleted.⏻ is released too soon.	<ul style="list-style-type: none">Charge the battery.Press ⏻ for at least 2 sec.
<ul style="list-style-type: none">Poor speech intelligibility.	<ul style="list-style-type: none">The microphone and/or receiver is muted.The distance between the microphone and the person speaking is too long.	<ul style="list-style-type: none">Unmute the microphone and/or receiver.Reduce the distance to the speaker.
<ul style="list-style-type: none">Poor range and/or static interference.	<ul style="list-style-type: none">The distance between the microphone and the receiver is too long.	<ul style="list-style-type: none">Reduce the distance to the receiver. Maximum distance is approx. 30 metres.
<ul style="list-style-type: none">Loud hissing noise (no sound transfer).	<ul style="list-style-type: none">The units are not paired.	<ul style="list-style-type: none">Redo the pairing procedure. See <i>Pairing Comfort Digisystem devices</i> on page 31
<ul style="list-style-type: none">The Bluetooth device will not pair with Microphone DM90.	<ul style="list-style-type: none">The Bluetooth device does not support the necessary profiles.	<ul style="list-style-type: none">Make sure that your Bluetooth device supports any of the necessary profiles. See <i>Technical Specifications</i>.

Symptom	Cause	Solution
<ul style="list-style-type: none">• No sound is heard.	<ul style="list-style-type: none">• The microphone is muted.• The transmitter and receiver channel does not match.• The volume is turned down.	<ul style="list-style-type: none">• Unmute the microphone.• Redo the pairing procedure. See <i>Pairing Comfort Digisystem devices</i> on page 31• Rise the volume.

Service and warranty

Comfort Audio AB accords a limited warranty for two years as of the date of delivery. This covers all defects of manufacture and materials. For accessories the warranty period is 90 days as of the date of delivery. Local agreements or regulations may exist. Defects caused by careless handling or intervention inside the product or its accessories are not covered by the warranty.

If you are in a need of service on your device, please contact your point of purchase. You are always welcome to contact Comfort Audio if you have any questions.

Contact information

Head office

SWEDEN

Comfort Audio AB

Box 154

SE-301 05 Halmstad

Phone +46 35 260 16 00

info@comfortaudio.com

www.comfortaudio.com

Subsidiaries

DENMARK

Comfort Audio ApS

Benediktevej 5, 1.sal

DK-3480 Fredensborg

Phone: +45 33 78 03 02

info@comfortaudio.dk

www.comfortaudio.dk

NORWAY

Comfort Audio AS

Postboks 304

NO-3201 Sandefjord

Phone: +47 959 87 910

info@comfortaudio.no

www.comfortaudio.no

GERMANY

Comfort Audio GmbH
Curiestraße 2
DE-70563 Stuttgart
Phone: +49 711 67 400 224
info@comfortaudio.de
www.comfortaudio.de

BENELUX

Comfort Audio BV
Nieuwe Steen 20
NL-1625 HV Hoorn
Phone: +31 229-87 01 10
info@comfortaudio.nl
www.comfortaudio.nl

USA

Comfort Audio Inc.
411 E. Business Center Drive
Suite 109
Mount Prospect, IL 60056, USA
Phone: +1 888 421-0843
usa@comfortaudio.com
www.comfortaudio.us

Product symbols



The product complies with the European directive 93/42/EEC, including amendments, concerning medical devices. The product complies with the essential requirements of the European Directive 1999/5/EC, including amendments, concerning Radio and Telecommunications terminal equipment.



The product is covered by the European directive 2002/96/EC, including amendments, concerning Waste Electrical and Electronic Equipment (WEEE). Recycle the product and its accessories according to national regulations.



Direct current.



Restriction of usage related to transmitted frequencies may apply, due to national regulations.



Connector for battery charger.



Indoor use only.



Class II equipment.



Aux in.

Trademark and copyright notices

Bluetooth® is a registered trademark of Bluetooth SIG, inc.

Comfort Digisystem™ is a trademark of Comfort Audio AB.

SecureStream Technology™ is a trademark of Comfort Audio AB.

Comfort Audio™ is a trademark of Comfort Audio AB.

MA0445
130225

© Comfort Audio AB. All rights reserved. All content is subject to change without notice.

Comfort Audio AB

Box 154

SE-301 05 Halmstad, Sweden

Phone: +46 35 260 16 00

info@comfortaudio.com

www.comfortaudio.com