

Instructions for use

Comfort Digisystem Microphone DM30



Contents

| | |
|---|-----------|
| I. User guide..... | 7 |
| 1. Introduction..... | 9 |
| Your device..... | 9 |
| SST™..... | 9 |
| Overview..... | 10 |
| Included accessories..... | 12 |
| 2. Getting started..... | 13 |
| Charge..... | 13 |
| Start up..... | 15 |
| Use the neckloop..... | 16 |
| Navigate the menu..... | 17 |
| 3. Usage..... | 19 |
| Use the device as a teacher unit..... | 20 |
| Use the device as a student unit..... | 21 |
| External audio sources..... | 22 |
| Connect an external audio source..... | 22 |
| II. For professionals..... | 25 |
| 4. Basic setup..... | 27 |
| Change the menu language..... | 27 |
| Master Unit..... | 27 |
| Configure the device as a master unit..... | 28 |
| Companion Unit..... | 28 |
| Configure the device as a Companion Unit..... | 28 |
| Configure the function button..... | 29 |

| | |
|---|-----------|
| 5. Pairing Comfort Digisystem devices..... | 31 |
| The pairing button..... | 31 |
| Change channel..... | 32 |
| Available channels..... | 33 |
| Send pairing information..... | 33 |
| Receive pairing information..... | 34 |
| 6. Advanced features..... | 37 |
| FCR..... | 37 |
| Enable FCR..... | 38 |
| Enable the FCR indicator..... | 39 |
| Input levels..... | 39 |
| Adjust the level of the built-in microphone..... | 39 |
| Adjust the level of the external microphone..... | 40 |
| Adjust the level of the line input..... | 40 |
| Volume limits..... | 40 |
| Set a maximum volume level..... | 40 |
| Set a fixed volume level..... | 41 |
| Lock the buttons..... | 41 |
| Name the device..... | 41 |
| PIN code settings..... | 42 |
| Set a PIN Code..... | 42 |
| Choose which functions to lock..... | 43 |
| Hide the PIN entry dialogue..... | 43 |
| Change the PIN code..... | 43 |
| Disable the PIN code..... | 44 |
| Reset all settings..... | 44 |
| III. Product information..... | 45 |
| 7. Menu overview..... | 47 |
| Back..... | 48 |

| | |
|---|-----------|
| Communication | 48 |
| Mode | 48 |
| Sound | 49 |
| Settings | 49 |
| Key Lock | 50 |
| About | 50 |
| | |
| 8. Function indicator | 51 |
| | |
| 9. Optional accessories | 53 |
| | |
| 10. Technical specifications | 55 |
| | |
| IV. Miscellaneous | 57 |
| | |
| 11. Radio | 59 |
| Channel planning..... | 59 |
| Radio range..... | 59 |
| | |
| 12. Battery maintenance | 61 |
| | |
| 13. Troubleshooting | 63 |
| Service and warranty | 65 |
| Contact information | 67 |
| Product symbols | 69 |

I. User guide

This part of the instruction manual covers day-to-day tasks that a user of the product should be familiar with.

1. Introduction

Thank you for choosing Microphone DM30!

Microphone DM30 is part of *Comfort Digisystem™* that uses digital wireless technology to give you the best sound quality available, together with secured transmission to prevent eavesdropping.

To get the most out of your new product, please read these instructions before using it for the first time. Take special notice to the printed document *Important Safety Instructions* included in the box.

Your device





Microphone DM30 is as a combined transmitter and receiver that is especially designed for use in schools. It allows for two-way communication and is configurable as teacher or student microphone, according to your needs.

SST™

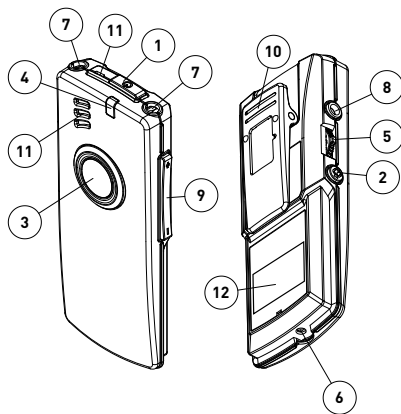
SecureStream Technology (SST) is Comfort Audio's proprietary digital transmission technology. It lets you communicate securely and latency free with other Comfort Digisystem devices.

Overview



1. Power button 
2. Pairing button 
3. Function button
4. Function indicator
5. Menu controller 
6. Charger input
7. Neckloop output
8. Aux input and output
9. Volume button 
10. Clip
11. Microphone
12. Display

Display

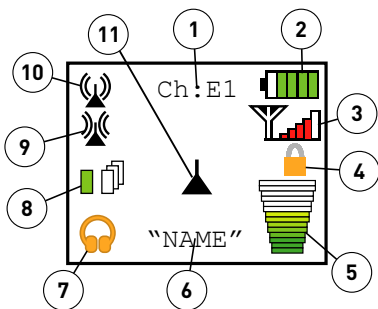

1. Current channel
2. Battery status
3. Signal quality
4. Key lock padlock
5. Volume bar
6. Unit name
7. Current aux setting
8. Unit mode
9. Receiver status
10. Transmitter status
11. Current button mode

Included accessories

Microfibre pouch

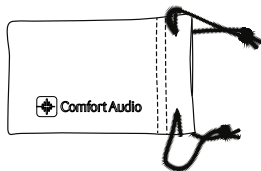

Power supply

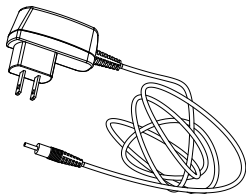

Cable split



Neck loop Digisystem

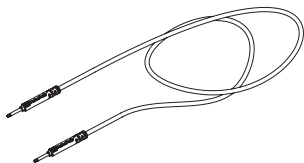

2. Getting started

This section will teach you how to perform the basic steps needed to get started.

Charge

Charging can be done at any time. If you make it routine to charge your product whenever you do not use it, it is always ready for use when you need it.

1. Insert the supplied charger into the charger input.

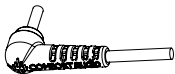

Caution: Only use the charger supplied by Comfort Audio AB. Using any other type of charger might damage your device.

2. Plug the charger into the wall socket.

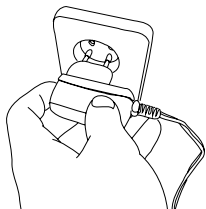

The function indicator turns red to indicate charging.



Note: *The unit might become warm during charging, this is entirely normal. The unit is equipped with overcharging- and temperature monitoring to protect the batteries.*

The charging is done when the function indicator turns green.

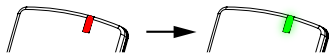

Start up

Press  until the start up bar is fully lit.

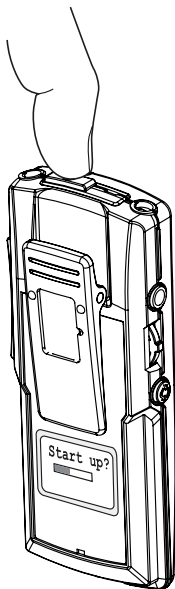

Use the neckloop

If you are going to use your product with a hearing aid or hearing implant in the T- or M/T-position, you need to connect the neckloop and wear it around your neck.

1. Connect one end of the neckloop to the sockets on top of the unit.

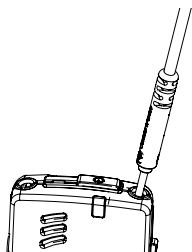

2. Place the neckloop behind your neck.

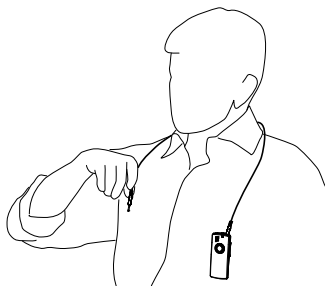

3. Connect the other end of the neckloop.



Important: Make sure the neckloop is inserted properly. Improper insertion might cause you to drop the device or damage the connections.

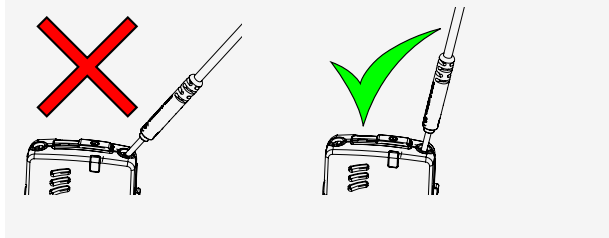

4. Switch your hearing aid or hearing implant into its T- or M/T-position.

You should now hear the sound come through your hearing aid.

Navigate the menu

You can use  on the side of the unit to navigate your way through the menu.

1. Press  to activate the menu.

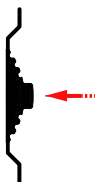

2. Flick the controller up or down to select the desired menu option.



3. Press  to enter the selected sub menu or activate the selected menu option.
4. When done, use the **Back** option to move to the previous menu.

3. Usage

Microphone DM30 is purpose made to be used with other units of the same type. Together with the other units it forms a system for two-way communication among teacher and students.

A typical set-up consists of one unit configured as a teacher unit, and one or several units configured as student units. This set-up allows each student to hear the teacher and fellow students that are using the push-to-talk feature.

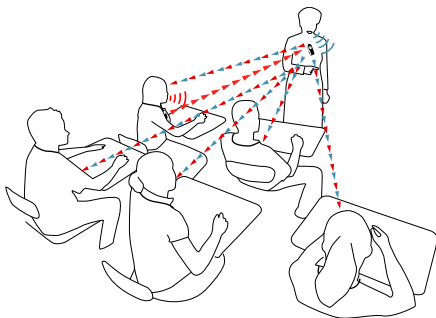

Figure 1: The teacher's voice is mixed with the voice of the student pushing the function button and sent back out to the rest of the class.

Alternatively, two units can be used together to allow team-teaching. A secondary unit, worn by the assistant teacher, then transmits sound via the primary teacher's unit to the student's units.

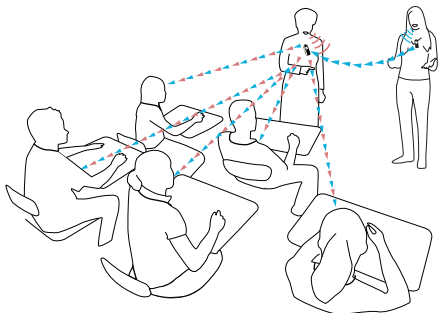



Figure 2: The teacher's voice is mixed with the voice of the assistant teacher and sent back out to the class.

Use the device as a teacher unit

Use Microphone DM30 as a teacher unit to transfer the voice of the teacher, mixed with the sound from another unit in the system, directly to the students.

Use a unit configured as a Master Unit. Verify that the -symbol is visible in the display. For information on configuring the device see *Basic setup* on page 27.

1. Have the teacher attach the unit to his or her clothes with the clip, or use a necklace to hang it around the neck.

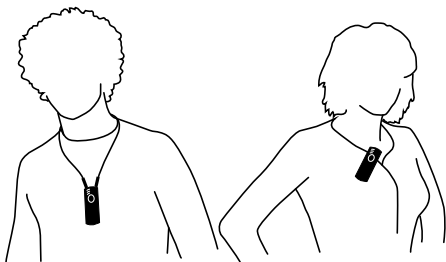

For optimum sound quality the unit should be placed no more than 30 cm (12 in.) from the mouth.

2. Let the teacher talk into the microphone in a normal voice and make sure the students can hear.
3. If the teacher is using head phones or a neckloop for monitoring, he or she can use ◀ to adjust the volume to a suitable level.

Use the device as a student unit

Students can use the device to listen and talk to other persons wearing Microphone DM30 devices.

Use a unit configured as a Companion Unit. Verify that -symbol is visible in the display. For information on configuring the device see *Basic setup* on page 27.

1. Have the student wear the unit around the neck using the neckloop.

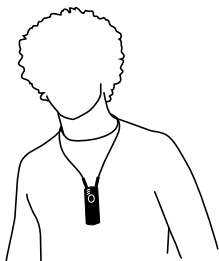

2. Let someone talk into the teacher microphone and let the student use  to adjust the volume to a suitable level.
3. Optional: Ask the student to talk into the microphone and use the function button to turn the transmission on or off.

External audio sources

You can connect any sound source that has a line out socket to the device. This lets you listen to television, conference telephones, voice recorders and the like. It is also possible to connect an external microphone, such as a clip-on microphone, or a pair of headphones.

Connect an external audio source

Connecting an external audio source will bring up a menu where you can select the type of device you have connected.

1. Connect your external audio source to the aux socket.
For line sources you can use the supplied audio cable.
The **Socket** menu will be shown automatically.
2. Select the option that corresponds to the device you have connected.

| Option | Description |
|--------------|--|
| Line In | Computer, TV, music player etc. |
| External Mic | Boom microphone, clip on microphone etc. |
| Head Phones | Headphones or earphones. |



Note: When Line-in is activated and a cable is connected, the unit switches automatically to continuous transmission, even if **Push to talk** or **Mic. On/Off** is activated.

3. Adjust the volume by using  till you find a suitable level.

II. For professionals

The following sections covers advanced features and procedures primarily intended for professionals and advanced users.

4. Basic setup

Before setting up the product you should make sure that the menu is set to the preferred language. You should also decide whether it should be used as a Master Unit or as a Companion Unit.

Change the menu language

The default menu language is English. You can change language from the menu **Settings**.

1. Select **Settings > Language**.
2. Select the language you want from the list of available languages.

Master Unit

The *Master Unit* is the device in a system that acts as a mixer for other paired Microphone DM30 units. It receives sound from another unit and mixes it with the sound from the built-in microphone. The mixed audio is transmitted on a separate master channel to any paired receivers. Listeners will hear both the Master Unit and the second unit on that channel. This lets two persons talk freely without forced interruptions.

By using push-to-talk microphones, the Master Unit can be used with multiple microphones. Such a set-up is useful in classroom situations where the students take part in discussions and need to hear the classmates and the teacher.

Configure the device as a master unit

You typically configure the device as a Master Unit when it is going to be used by a teacher or lecturer. With this set-up the device will mix the voices of the teacher and student and broadcast them to the class.

1. Select **Mode**.
2. Check **Master Unit**.

When the unit is programmed as Master Unit, the display shows .

Companion Unit

A *Companion Unit* will let the user listen to the master channel and communicate with other Companion Units by relaying sound through the Master Unit.

A Companion Unit is typically used with the push-to-talk feature enabled to let several users take turn transmitting sound to the Master Unit.

Configure the device as a Companion Unit

The Companion Unit setting is normally used if the device is used by a student. It lets the student hear both the teacher and fellow students.

1. Select **Mode**.
2. Check **Companion Unit**.

When the unit is programmed as Companion Unit, the display shows .

Configure the function button

The function button on the unit can be configured for different purposes through the menu option **Mode**. For example, it can be set to push-to-talk, to allow the use of several microphones on a single channel, or as a mute switch to temporarily mute the sound when having a private conversation.

1. Select **Mode > Button Mode**.
2. Select one of the following options:

| Option | Description |
|-----------------------|---|
| None | The button has no function. |
| Push to talk | The microphone is on while the button is pushed and muted on release. |
| Mic. On/Off | The microphone is toggled on and off with each press of the button. |
| Mute switch | The microphone is muted while the button is pushed and active on release. (Master Units only.) |
| Receiv. On/Off | The built-in receiver is toggled on and off with each press of the button. (Master Units only.) |

5. Pairing Comfort Digisystem devices

By pairing two or more Comfort Digisystem devices you ensure that they can communicate securely with each other.

Comfort Digisystem is a digitally encrypted communication system that relies on unique *code keys* to provide transmission security. Any units that are to be used together needs to be set to the same channel and share the same code key.

When you perform a pairing procedure you send information about the channel and code key from one unit to one or several others. This lets you create a channel and code key combination on one unit and distribute it to other units to form a system.

The information about the channel and code key is referred to as *pairing information*. Microphone DM30 is able to both send and receive pairing information.



Important: *At delivery all units share the same factory code key. To make the system secure, you need to generate a new code key.*

The pairing button

All Comfort Digisystem units are equipped with a pairing button. The pairing button gives you quick access to the pairing features of the device.

Table 1: Pairing short cuts accessible through the pairing button.

| Option | Description |
|-----------------|--|
| A single press. | Takes you to the pairing menu. |
| A long press. | Sets the unit to receive pairing information. (For units with more than one channel, this affects the transmitter channel only.) |
| A double press. | Sends pairing information. (For units with more than one channel, this affects the transmitter channel only.) |

Change channel

If a channel does not suit your setup, or if you are experiencing interference from some other radio source, you can change to a different channel via the **Channel** menu.

1. Select **Communication > Channel**.
2. Choose the channel you wish to use in the channel list.

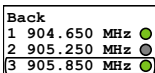

The green circle next to the frequency indicates that the channel is free from interference. If the channel is occupied the circle will be grey.

Available channels

Transmitter



Comfort Digisystem has a total of 38 channels to choose from. These channels should not require a license in North America. However, always verify with the local frequency assignment authority which channels are free to use and which require a licence.

Send pairing information

By sending pairing information from Microphone DM30 you can synchronise its channel and code key with another unit. Any existing pairing information in the other unit will be overwritten.

1. Select **Communication > Pair**
2. Set the unit or units that you would like to pair with Microphone DM30 to receive pairing information.

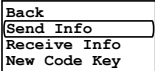
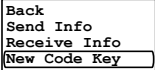
3. To send the pairing information, select *one* of the following options:

| Option | Description |
|--|--|
| <p>Send Info</p>  | <p>Send the <i>existing</i> code key.</p> |
| <p>New Code Key</p>  | <p>Generate and send a <i>new</i> code key.</p> <p></p> <p>Important: <i>This will break the pairing with any previously paired units.</i></p> |

When the info is sent the text `Info sent!` will appear in the display.

Receive pairing information

When the unit is set to receive pairing information its current channel and code key will be overwritten by the received information.

1. Set the unit to receive information by selecting **Communication > Pair**.
2. Select **Receive Info**.
3. Send pairing information from the unit you are pairing with Microphone DM30.

If the pairing is successful, the word OK will appear in the display of Microphone DM30.

6. Advanced features

This product has special features and settings that lets you tailor the unit to the user's specific needs.

FCR

Free Channel Request (FCR) blocks transmission when the selected channel is occupied. This eliminates problems with interference that can occur when multiple microphones are used simultaneously, as in push-to-talk configurations.

A student pushes the push-to-talk button to respond to a question and all other microphones with FCR enabled are blocked. As soon as the button is released the other students are free to use their microphones. The teacher is using a separate channel to be able to talk freely without interrupting the students.

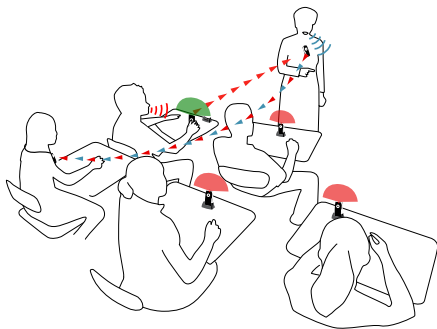

Figure 3: The student microphones shine red to indicate that someone else is using the channel.

Enable FCR

FCR can be enabled to avoid interfering with other microphones when using push-to-talk.

Make sure the unit is configured as a Companion Unit with push-to-talk enabled.

1. Select **Mode > Button Mode**.
2. Check **FCR**.

Enable the FCR indicator

You can activate the FCR Indicator to get visual feedback when the FCR feature blocks transmission. The function indicator will turn red to indicate blocked transmission.

1. Select **Mode > Button Mode**.
2. Check **FCR indicator**.

Input levels

The sensitivity of the various inputs are adjustable so you can match the levels to different audio sources and situations.



***Tip:** Use a low input sensitivity and a short microphone distance to reduce the risk of acoustic feedback when the device is used with a speaker system.*

Adjust the level of the built-in microphone

Adjust the sensitivity of the built-in microphone to cater for different acoustic situations.

1. Select **Sound**.
2. Select **Level** under **Internal Mic**.
3. Adjust the volume to the desired level.
4. Press  to confirm your choice.

Adjust the level of the external microphone

Adjust the input level of the external microphone to compensate for different microphone sensitivities.

1. Select **Sound > Socket**.
2. Select **Level** under **External Mic**.
3. Adjust the volume to the desired level.
4. Press  to confirm your choice.

Adjust the level of the line input

If needed, adjust the sensitivity of the line input to match the output level of the connected device.

1. Select **Sound > Socket**.
2. Select **Level** under **Line In**.
3. Adjust the volume to the desired level.
4. Press  to confirm your choice.

Volume limits

Setting the volume too loud can be unpleasant and potentially cause damage to the hearing. This product is equipped with a maximum volume feature that limits the loudness to a predefined level that you deem safe. You can also set a fixed volume level if you prefer control of the volume from the hearing aid only.

Set a maximum volume level

To prevent the volume from being turned up too loud by accident, you can set a maximum allowed volume level.

1. Select **Sound > Socket > Max/Fix Vol..**
2. Select **Settings** under **Max Volume.**
3. Adjust the volume to the desired level.
4. Press  to confirm you choice.

Set a fixed volume level

If there is no need of a user adjustable volume, you can lock the volume to a fixed level.

1. Select **Sound > Socket > Max/Fix Vol..**
2. Select **Settings** under **Fix Volume.**
3. Adjust the volume to the desired level.
4. Press  to confirm you choice.

Lock the buttons

If you want to avoid accidental button presses it is possible to lock all functions by activating the key lock. (You can always use the power button regardless of the key lock.)



Select **Key Lock.**

An orange padlock symbol will appear in the display of the device.

Name the device

To help identify the device, you can enter a name that will be shown in the display and during Bluetooth pairing.



1. Select **Settings > Name.**

- Use  to scroll through the list of characters. Press  to enter the selected character.
- When done select ✓. (To cancel, select X instead.)

PIN code settings

To prevent tampering or unintentional changes of the settings, you can lock the product with a four digit PIN code.

Set a PIN Code

- Select **Settings > PIN Code**.
- Check **Enabled**.
- Use  to scroll through the list of characters. Press  to enter the selected character.

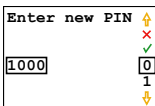

- When done select ✓. (To cancel, select X instead.)



Important: Make note of the PIN code. If you forget the PIN, contact your point of purchase.

Choose which functions to lock

By selecting which functions to lock with the PIN code you can allow access to commonly used functions while preventing access to others.

1. Select **Settings > PIN Code > Lock Select**.
2. Select the functions you want to lock:

| Option | Description |
|------------------|-------------------------------|
| Mode | Lock access to the Mode menu. |
| Pair | Lock access to the Pair menu |
| Sound | Lock access to the Sound menu |
| All Menus | Lock access to all menus. |

Hide the PIN entry dialogue

To reduce the temptation to guess the PIN, the PIN entry dialogue can be hidden. The user then has 3 seconds from start up to access the dialogue before it is hidden.

1. Select **Settings > PIN Code > Lock Select**.
2. Select **Hide PIN Entry**.

Change the PIN code

1. Select **Settings > PIN Code**.
2. Enter the current PIN code.
3. Select **Change PIN**.
4. Enter the new PIN code.

5. Select ✓ to confirm PIN.

Disable the PIN code

If you no longer wish to lock access to the unit, you can disable the PIN code. The PIN will be reset and a new code will have to be entered if you choose to enable it again.

1. Select **Settings** > **PIN Code**.
2. Enter the current PIN code.
3. Uncheck the **Enabled** option.

Reset all settings

If you need to reset all settings to their default values, you can do a factory reset.

1. Select **Settings** > **Factory Reset**.
2. Select **Yes**.



Important: All settings will be lost. Any pairing needs to be redone.

III. Product information

7. Menu overview

Back

Communication

Back
Channel
Pair

Mode

Back
Master Unit
Companion Unit
Button Mode
Receiver On/Transmitter On

Sound

Back
Loop
Socket
Internal Mic

Settings

Back
PIN Code
Charge
Language
Name
Func.Indicator
Factory Reset
Time out TX
LBT

Key Lock

About

Back

Leave the current menu.

Communication

Settings for radio channels and pairing.

- Channel** Change the transmitting and receiving channel.
- Pair** Pair the unit with another Comfort Digisystem device. Allows you to generate a new code key to make the system secure.

Mode

Set the operating mode of the unit.

- Master Unit** Make the unit a Master Unit that receives sound from Companion Units.
- Companion Unit** Make the unit a Companion Unit that transmits sound to the Master Unit.
- Button Mode** Configure the function button.
- Receiver On** Enable the built-in receiver. Only available as Master Unit.
- Transmitter On** Enable the built-in transmitter. Only available as Companion Unit.

Sound

Settings related to the sound of the unit.

| | |
|---------------------|---|
| Loop | Enable the neckloop output. |
| Socket | Various level adjustments and settings for sound sources connected to the aux socket. |
| Internal Mic | Set the level of the built-in microphone. |

Settings

General settings.

| | |
|-----------------------|--|
| PIN Code | Lock the unit with a PIN code to prevent tampering. |
| Charge | When Auto Power Off is activated, the unit will turn <i>off</i> when charged. Auto Restart will start the unit when charging is interrupted. Default is to stay <i>on</i> during charging. |
| Language | Set the menu language. |
| Name | Give the unit a name to help identify it. |
| Func.Indicator | Toggle the function indicator on or off. |
| Factory Reset | Reset the unit to factory settings. All settings will be lost! |
| Time out TX | Automatically turn off transmission if no sound is detected during 1 minute. Transmission restarts when sound is detected. |

LBT

Verify that the selected channel is free before the transmission is started. This is done to avoid interference with any existing signals. If the selected channel is busy, the following text will appear: "This channel is busy, select a new channel".

Key Lock

Manually activate the key lock.

About

Information about the firmware version.

8. Function indicator

The *function indicator* gives you information about the units current status.



Table 2: Pairing indications

| Status | Indication |
|--------------------------------------|---------------------------|
| Ready to receive pairing information | //...■ ■ ■ ■ ■ ■ ■ ■...// |
| Pairing information sent. | // ■ ■ ■ ■ ■ ■ // |
| Information received | // ██████████ // |

Table 3: Charging indications

| Status | Indication |
|----------------------|-------------------------------|
| Normal operation | //...■...//...■...//...■...// |
| Charging in progress | //...██████████...// |
| Charging complete | //...██████████...// |
| Low battery | //...■...//...■...//...■...// |



Note: If the unit is on while charging the function indicator stays red even when the battery is fully charged.

9. Optional accessories

The following accessories can be used with your product:

Soft case



Charging stand

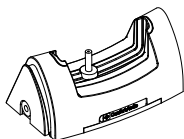
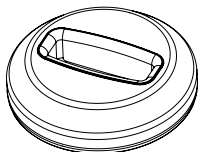
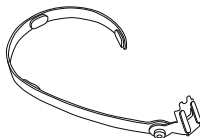

Table stand



Neckholder



Boom microphone, black



Boom microphone, beige

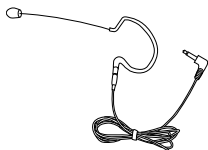

Clip on microphone

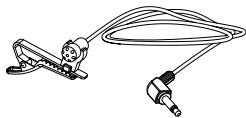

10. Technical specifications

| | |
|-------------------------------------|--|
| Type of transmitter/receiver | SST - SecureStream Technology |
| Range | Approx. 30 m (100 ft) |
| Dimensions | 97x41x17 mm (3.8x1.6x0.7 in.) |
| Weight | 51 g (1.8 oz) |
| Frequency range transmitter | 904 - 927 MHz, 2.40 - 2.48 GHz |
| Frequency range receiver | 904 - 927 MHz, 2.40 - 2.48 GHz |
| Antennas | Built-in |
| Operating time | Up to 10 hours. Dependent on usage conditions. Measured with factory settings. |
| Charging time | Up to 3 hours. |
| Microphone | Built-in microphone omnidirectional |
| Connections | Mic, Line in, headphones, neckloop |

IV. Miscellaneous

11.Radio

Comfort Digisystem relies on radio technology to transfer the sound between transmitters and receivers. Like all radio systems, it communicates on specific channels. If you use two transmitters on the same channel, or neighbouring ones, there may be interference. Other electronic equipment can also interfere with radio transmissions.

Channel planning

To achieve optimal radio performance you need to take into account the distance between transmitters and their frequencies. A longer distance between transmitters allows you to use frequencies that are closer together.

If several transmitting frequencies are being used in the same room, the frequency differences between the units should be at least 1 MHz for optimal operation.

Radio range

The radio range between the units is around 30 m (100 ft). However, this may vary depending on the particular environment you are in.

12. Battery maintenance

This product has a built in Lithium-Ion Polymer battery. Lithium-Ion batteries do not suffer from so called memory effects and do not need to be routinely discharged to preserve performance.

The battery's capacity will degrade over time. This is normal for all rechargeable batteries. Battery lifetime is dependent on usage patterns. The battery is preferably charged little and often; it will reach 90% of its capacity after half its charging time. If stored for long periods of time, the battery is best left semi-charged. Contact your point of purchase when it is time to change the battery.

Operating times vary depending on which features are used.

13.Troubleshooting

Consult the following guide if you have problems with your equipment. If you still have questions, please contact your point of purchase.

| Symptom | Cause | Solution |
|---|---|---|
| <ul style="list-style-type: none">• The device does not start. | <ul style="list-style-type: none">• The battery is depleted.• \odot is released too soon. | <ul style="list-style-type: none">• Charge the battery.• Press \odot for at least 2 sec. |
| <ul style="list-style-type: none">• Poor speech intelligibility. | <ul style="list-style-type: none">• The distance between the microphone and the person speaking is too long. | <ul style="list-style-type: none">• Reduce the distance to the speaker. |
| <ul style="list-style-type: none">• Poor range and/or static interference. | <ul style="list-style-type: none">• The distance between the microphone and the receiver is too long. | <ul style="list-style-type: none">• Reduce the distance to the receiver. Maximum distance is approx. 30 m (100 ft). |
| <ul style="list-style-type: none">• Loud hissing noise (no sound transfer). | <ul style="list-style-type: none">• The units are not paired. | <ul style="list-style-type: none">• Redo the pairing procedure. See <i>Pairing Comfort Digisystem devices</i> on page 31 |
| <ul style="list-style-type: none">• Device will not start during charging. | <ul style="list-style-type: none">• Auto Power Off is activated. | <ul style="list-style-type: none">• Disable Auto Power Off |
| <ul style="list-style-type: none">• No sound is heard. | <ul style="list-style-type: none">• The microphone is muted.• The transmitter and receiver channel does not match. | <ul style="list-style-type: none">• Unmute the microphone.• Redo the pairing procedure. See <i>Pairing Comfort Digisystem devices</i> on page 31 |

Service and warranty

Comfort Audio AB accords a limited warranty for two years as of the date of delivery. This covers all defects of manufacture and materials. For accessories the warranty period is 90 days as of the date of delivery. Local agreements or regulations may exist. Defects caused by careless handling or intervention inside the product or its accessories are not covered by the warranty.

If you are in a need of service on your device, please contact your point of purchase. You are always welcome to contact Comfort Audio if you have any questions.

Contact information

Head office

SWEDEN

Comfort Audio AB

Box 154

SE-301 05 Halmstad

 +46 35 260 16 00

 info@comfortaudio.com

 www.comfortaudio.com

Subsidiaries

DENMARK

Comfort Audio ApS

Benediktevej 5, 1.sal

DK-3480 Fredensborg

 +45 33 78 03 02

 info@comfortaudio.dk

 www.comfortaudio.dk

NORWAY

Comfort Audio AS

Postboks 304

NO-3201 Sandefjord

 +47 959 87 910

 info@comfortaudio.no

 www.comfortaudio.no

GERMANY

Comfort Audio GmbH

Curiestraße 2

DE-70563 Stuttgart

 +49 711 67 400 224

 info@comfortaudio.de

 www.comfortaudio.de

BENELUX

Comfort Audio BV

Nieuwe Steen 20

NL-1625 HV Hoorn

 +31 229-87 01 10

 info@comfortaudio.nl

 www.comfortaudio.nl

USA

Comfort Audio Inc.

411 E. Business Center Drive

Suite 109

Mount Prospect, IL 60056, USA

 +1 888 421-0843

 usa@comfortaudio.com

 www.comfortaudio.us

Product symbols



The product complies with the European directive 93/42/EEC, including amendments, concerning medical devices. The product complies with the essential requirements of the European Directive 1999/5/EC, including amendments, concerning Radio and Telecommunications terminal equipment.



The product is covered by the European directive 2002/96/EC, including amendments, concerning Waste Electrical and Electronic Equipment (WEEE). Recycle the product and its accessories according to national regulations.



Direct current.



Restriction of usage related to transmitted frequencies may apply, due to national regulations.



Connector for battery charger.



Indoor use only.



Class II equipment.

Trademark and copyright notices

Comfort Digisystem™ is a trademark of Comfort Audio AB.

SecureStream Technology™ is a trademark of Comfort Audio AB.

Comfort Audio™ is a trademark of Comfort Audio AB.

MA0506
130610

© Comfort Audio AB. All rights reserved. All content is subject to change without notice.

Comfort Audio AB

Box 154

SE-301 05 Halmstad, Sweden

Phone: +46 35 260 16 00

info@comfortaudio.com

www.comfortaudio.com