

Owner's Manual

COLOR VIDEO MONITOR

Contents

CERTIFICATIONS	1
SPECIAL NOTES ON LCD MONITORS	7
BEFORE YOU OPERATE THE MONITOR	7
FEATURES	7
PACKING LIST	7
INSTALLATION INSTRUCTIONS	8
CONTROLS AND CONNECTORS	8
ADJUSTING THE VIEWING ANGLE	9
OPERATING INSTRUCTIONS	10
GENERAL INSTRUCTIONS	10
HOW TO ADJUST A SETTING	12
ADJUSTING THE PICTURE	12-13
FEATURES	14
PLUG AND PLAY	15
TECHNICAL SUPPORT(FAQ)	16-17
ERROR MESSAGE & POSSIBLE SOLUTION	18
APPENDIX	19
SPECIFICATIONS	19-20
FACTORY PRESET TIMING TABLE	21
CONNECTOR PIN ASSIGNMENT	21

Notice:

Please read the following words before assembling and using this monitor. Any reference to an Legend[®] product, program or service is not intended to state or imply that only Legend's[®] product, program, or service may be used. Any functionally equivalent product, program, or service that does not infringe any of Legend's[®] intellectual property rights or other legally protectable rights may be used instead of the Legend[®] product, program, or service. Evaluation and verification of operation in conjunction with other products, programs, or services, except those expressly designated by Legend[®], are the user's responsibility. Legend[®] may have patents or pending patent applications covering subject matter in this document. The furnishing of this document does not give you any license to these patents.

Information in this document is subject to change without notice. Without the Permission of Legend (Beijing) Limited, no part of this manual may be reproduced or distributed in any form or by any means.

Legend[®] is a Legend (Beijing) Limited registered trademark.
ENERGY STAR[®] is a U.S. government registered trademark.
IBM is IBM Corporation registered trademark.

CE certificate



This shipped version of this device complies with the requirements of the EEC directive 89/336/EEC "Electromagnetic compatibility" and 73/23/EEC "Low voltage directive".

ENERGY STAR® Guidelines



As an ENERGY STAR Partner, **LEGEND (BEIJING) LIMITED** has determined that this product meets the ENERGY STAR guidelines for energy efficiency.

Federal Communications Commission (FCC) Statement

This equipment has been tested and found to comply with the limits for a Class B digital device, pursuant to Part 15 of the FCC Rules. These limits are designed to provide reasonable protection against harmful interference in a residential installation. This equipment generates, uses and can radiate radio frequency energy, and if not installed and used in accordance with the instructions, may cause harmful interference to radio communications. However, there is no guarantee that interference will not occur in a particular installation. If this equipment does cause harmful interference to radio or television reception, which can be determined by turning the equipment off and on, the user is encouraged to try to correct the interference by one or more of the following measures:

- Reorient or relocate the receiving antenna.
- Increase the separation between the equipment and receiver.
- Connect the equipment into an outlet on a circuit different from that to which the receiver is connected.
- Consult the dealer or an experienced radio/TV technician for help.

WARNING:

Use only shielded signal cables to connect I/O devices to this equipment.

You are cautioned that changes or modifications not expressly approved by the party responsible for compliance could void your authority to operate equipment.

PRECAUTIONS

- Do not use the monitor near water, e.g. near a bathtub, washbowl, kitchen sink, laundry tub, swimming pool or in a wet basement.
- Do not place the monitor on an unstable cart, stand, or table. If the monitor falls, it can injure a person and cause serious damage to the appliance. Use only a cart or stand recommended by the manufacturer or sold with the monitor. If you mount the monitor on a wall or shelf, use a mounting kit approved by the manufacturer and follow the kit instructions.
- Slots and openings in the back and bottom of the cabinet are provided for ventilation. To ensure reliable operation of the monitor and to protect it from overheating, be sure these openings are not blocked or covered. Do not place the monitor on a bed, sofa, rug, or similar surface. Do not place the monitor near or over a radiator or heat register. Do not place the monitor in a bookcase or cabinet unless proper ventilation is provided.
- The monitor should be operated only from the type of power source indicated on the label. If you are not sure of the type of power supplied to your home, consult your dealer or local power company.
- Cut off the power source during a lightning storm or when it will not be used for long periods of time. This will protect the monitor from damage due to power surges.
- Do not overload power strips and extension cords. Overloading can result in fire or electric shock.
- Never push any object into the slot on the monitor cabinet. It could short circuit parts causing a fire or electric shock. Never spill liquids on the monitor.
- Do not attempt to service the monitor yourself, opening or removing covers can expose you to dangerous voltages and other hazards. Please refer all servicing to qualified service personnel.
- To ensure satisfactory operation, configured receptacles marked between 100 - 240V AC, Min. 3.5A.
- The wall socket shall be installed near the equipment and shall be easily accessible.

SPECIAL NOTES ON LCD MONITORS

The following symptoms are normal with LCD monitor and do not indicate a problem.

NOTES

- Due to the nature of the fluorescent light, the screen may flicker during initial use. Turn off the Power and then turn it on again to make sure the flicker disappears.
- You may find slightly uneven brightness on the screen depending on the desktop pattern you use.
- The LCD screen has effective pixels of 99.99% or more. It may include blemishes of 0.01% or less such as a missing pixel or a pixel lit all of the time.
- Due to the nature of the LCD screen, an afterimage of the previous screen may remain after switching the image, when the same image is displayed for hours. In this case, the screen is recovered slowly by changing the image or turning off the Power for hours.
- The life of the fluorescent light used in the LCD monitor is approximately 20,000 hours. Contact your dealer or service center for replacement when the screen is dark, flickering or not lighting up. Never attempt to replace it by yourself.

BEFORE YOU OPERATE THE MONITOR

FEATURES

- 38cm(15") TFT Color LCD Monitor
- Crisp, Clear Display for Windows
- Supports Resolutions up to 1024 X 768@75Hz
- Screen Saver
- Ergonomic Design (TCO'95 Approved)
- Space Saving, Compact Case Design

CHECKING THE CONTENTS OF THE PACKAGE

The product package should include the following items:

1. LCD Monitor
2. Owner's Manual
3. Audio cable
4. Warranty Card
5. Warranty Guide

INSTALLATION INSTRUCTIONS

Power Source:

This LCD monitor has a universal power supply that allows operation in either 100/120V AC or 220/240V AC voltage area (No user adjustment is required.)

CONTROLS AND CONNECTORS

VIDEO CABLE

Connecting the Video Cable: the LCD monitor comes with a built-in video cable. Plug the signal cable's 15-pin connector into the computer's video port and tighten the two screws on the cable connector.

Caution: *If the AC outlet is not grounded, install the proper grounding adapter (not supplied).*

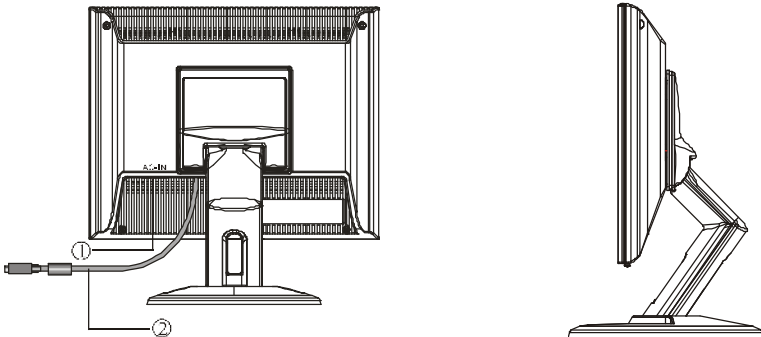

Figure 1 Connecting Cables

1	AC inlet	2	Signal Cable
---	----------	---	--------------

ADJUSTING THE VIEWING ANGLE

- For optimal viewing it is recommended to look at the full face of the monitor, then adjust the monitor's angle to your own preference.
- Hold the stand so you do not topple the monitor when you change the monitor's angle.
- You are able to adjust the monitor's angle from -3° to 15° .

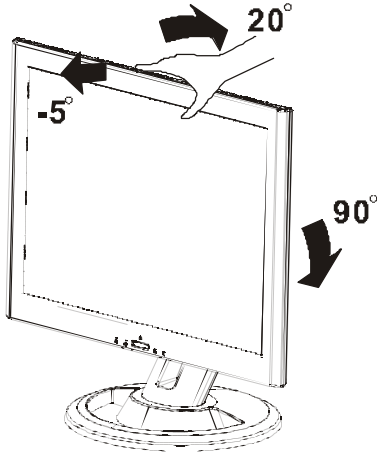

Figure 2

NOTES

- Do not touch the LCD screen when you change the angle. It may cause damage or break the LCD screen.
- Careful attention is required not to catch your fingers or hands when you change the angle.
- To avoid colliding with base, please tilt 20° backward before pivoting from landscape mode to portrait mode.

OPERATING INSTRUCTIONS

GENERAL INSTRUCTIONS

Press the power switch to turn the monitor on or off. The other control knobs are located at front panel of the monitor (See Figure 3). By changing these settings, the picture can be adjusted to your personal preferences.

- Connect the video cable from the monitor to the video card.
- Press the stand by power switch to turn on the monitor position. The power indicator will light up.

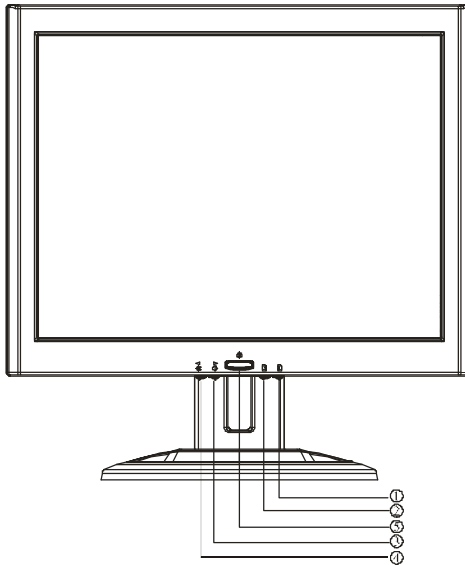

Figure 3 External Control Knob

EXTERNAL CONTROLS

1.	Auto Config / Exit	2.	◀ / Brightness
3.	▶ / Contrast	4.	MENU/Enter
5.	LED	6.	Power Key

FRONT PANEL CONTROL

- **Power Key:**

Press this knob to switch ON/OFF of monitor's power.

- **MENU/ENTER:**

Activate OSD menu or function adjusts confirmation.

- **Contrast**  /  :

Adjust contrast or function adjustment.

- **Brightness**  /  :

Adjust brightness or function adjustment.

- **Auto Config Key / EXIT:**

1. When OSD menu is in active status, this knob will act as EXIT-KEY (EXIT OSD menu)
2. When OSD menu is in off status, press this knob over 2 seconds to be in Auto Adjustment function.
The Auto Adjustment function is used to set the HPos, VPos, Clock and Focus automatically.

NOTES

- Do not install the monitor in a location near heat sources such as radiators or air ducts, or in a place subject to direct sunlight, or excessive dust or mechanical vibration or shock.
- Save the original shipping carton and packing materials, as they will come in handy if you ever have to ship your monitor.
- For maximum protection, repackage your monitor as it was originally packed at the factory.
- To keep the monitor looking new, periodically clean it with a soft cloth. Stubborn stains may be removed with a cloth lightly dampened with a mild detergent solution. Never use strong solvents such as thinner, benzene, or abrasive cleaners, since these will damage the cabinet. As a safety precaution, always unplug the monitor before cleaning it.

HOW TO ADJUST A SETTING

The monitor controls are accessed by pressing button MENU to enable OSD (On-Screen-Display). The main menu will be displayed as follows (see figure 4) .If OSD window is in English when power on (see figure 5), press the Contrast/UP Key or Brightness/Down Key to choosethe next window. Choose the Chinese, then press MENU Key for confirming. OSD window will display in Chinese.

1. Press the MENU-Key to show the OSD window. See figure 4.
2. Press ◀ or ▶ to select the adjusted item, then press the MENU-key.
3. Press ◀ or ▶ to change the settings of selected item. Press MENU-key when desired setting is done.
4. If you want to adjust any other items, repeat steps 2-4.
5. To exit and save the setting, press ◀ or ▶ to the exit item and press MENU-key, or leave the monitor alone for 10 seconds.
6. When the OSD window is active, it shows the input signal timing. The "H" stands for the horizontal frequency and "V" stands for the vertical frequency.

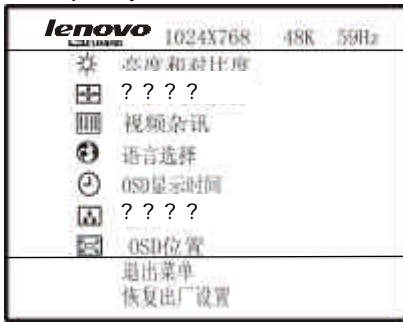

Figure 4 Chinese OSD Message

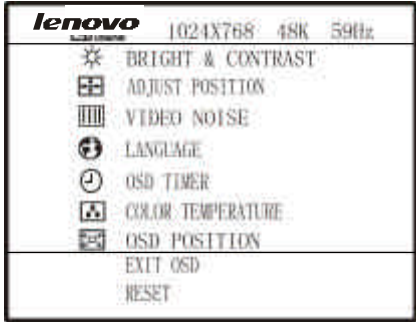

Figure 5 English OSD Message

ADJUSTING THE PICTURE

The description for function control LEDES

1. BRIGHTNESS & CONTRAST

1.1 BRIGHTNESS

Adjust the picture brightness.

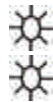

1.2 CONTRAST

Adjust the picture contrast.













2. ADJUST POSITION

1.1 HORIZONTAL POSITION

Adjust the horizontal position of the picture.



- 1.2 VERTICAL POSITION 
Adjust the vertical position of the picture.
3. VIDEO NOISE 
3.1 FOCUS 
Adjust the picture Focus.
- 3.2 CLOCK 
Adjust the picture Clock.
4. LANGUAGE 
Multi-Language selection.
5. OSD TIMER 
Choose OSD window display time.
6. COLOR TEMPERATURE 
6.1 7300K/9300K (COLOR TEMPERATURE)
The color temperature for 7300K is $x=0.301$, $y=0.317$ and 9300K is $x=0.283$, $y=0.297$. It presents two different color sets on the screen. You can select 9300K or 7300K by pressing MENU Key.
- 6.2 USER MODE (Red / Green/ Blue)
If the 9300K normal white or 7300K warmer white do not satisfy your desire, properly adjust R .G. B GAIN controls to obtain your optimum whiteness level.
7. OSD POSITION 
7.1 HORIZONTAL OSD 
Adjust the picture's horizontal size.
- 7.2 VERTICAL OSD 
Adjust the picture's vertical size.
8. EXIT OSD
Close OSD window.
9. RESET
Press RESET to restore the monitor to factory settings.

Active-off Mode

When both the H and V sync signals from the computer are off, the monitor enters into Active-off Mode which reduces the power consumption to less than 5W. The screen becomes dark, and the power indicator turns to orange. From Active-off Mode, the screen reappears instantaneously when the keyboard or the mouse is touched again.

- The power-saving mode can be indicated by the light-emitting diode (LED) on the front panel:

Mode	Signal		Power	
	Cable	Signal	Indicator	Consumption
On	Attached	Active	Green	= 25 W (For LXB-L15)
Off	Attached	Blank	Orange	= 3 W

FEATURES

Green monitor

- The monitor has a screen saver function that conforms to the VESA standard. This feature will only work if your PC is a green PC. This feature is similar to a screen saver, except that your monitor will turn it off instead of activating the screen saver.

To activate this feature in Windows® 98/2000/ME:

In Windows® 98/2000/ME, this feature can be activated and customized under the screen saver setting of the display properties.

1. Right click on the desktop and choose Properties.
2. Click on the tab that says Screen Saver. If your system supports Green PC, there will be a section entitled “Energy Saving Features of Monitor.” If there isn’t a section like that, then your PC does not support Green Monitor. The monitor will behave just like a normal monitor, so you will have to turn it off manually to save energy.
3. In the “Energy Saving Features of Monitor” sections are two boxes, Power on and Shut off. To activate either one, click the box next to each one.
4. You can specify the amount of inactive time before your monitor enters shuts off mode.

PLUG AND PLAY

Plug & Play DDC1/2B Feature

This monitor is equipped with VESA DDC1/2B capabilities according to the VESA DDC STANDARD. It allows the monitor to inform the host system of its identity and, depending on the level of DDC used, communicate additional information about its display capabilities. The communication channel is defined in two levels, DDC1 and DDC2B.

The DDC1 is a unidirectional data channel from the display to the host that continuously transmits EDID information. The DDC2B is a bidirectional data channel based on the I²C protocol. The host can request EDID information over the DDC2B channel.

THIS MONITOR WILL APPEAR TO BE NON-FUNCTIONAL IF THERE IS NO VIDEO INPUT SIGNAL. IN ORDER FOR THIS MONITOR TO OPERATE PROPERLY, THERE MUST BE A VIDEO INPUT SIGNAL.

This monitor meets the Green Monitor standards as set by the Video Electronics Standards Association (VESA) and/or the United States Environmental Protection Agency (EPA) and The Swedish Confederation Employees (NUTEK). This feature is designed to conserve electrical energy by reducing power consumption when there is no video-input signal present. When there is no video input signal this monitor, following a time-out period, will automatically switch to an OFF mode. This reduces the monitor's internal power supply consumption. After the video input signal is restored, full power is restored and the display is automatically redrawn. The appearance is similar to a "Screen Saver" feature except the display is completely off. The display is restored by pressing a key on the keyboard, or clicking the mouse.

TECHNICAL SUPPORT (FAQ)

Problem & Question	Possible Solution
Power LED is not on	*Check if the Power Switch is in the ON position
No Plug & Play	*Check if the PC system is Plug & Play compatible *Check if the Video Card is Plug & Play compatible *Check if the D-15 plug pin of Video Cable is bent
No picture	*Computer Power Switch should be in the ON position *Computer Video Card should be snugly seated in its slot *The Signal Cable should be completely connected to the computer *Check the color of the Power LED indicator. If it is orange, then the monitor and the PC system are in screen saver mode. You need press your keyboard or move the mouse to reactivate the system.
Picture is fuzzy	*Adjust the Contrast and Brightness Controls.
Picture bounces or a wave pattern is present in the picture	*Move electrical devices that may cause electrical interference.
Monitor is stuck in "Power Saving Mode"	*Make sure monitor's video cable is properly connected to the computer. *Inspect monitor's video cable and make sure none of the pins are bent. *Make sure computer is operational by hitting the CAPS LOCK key on the keyboard while observing the CAPS LOCK LED. The LED should either turn ON or OFF after hitting the CAPS LOCK key.
Missing one of the primary colors (RED, GREEN, or BLUE)	*Inspect the monitor's video cable and make sure that none of the pins are bent.

Screen image is not centered or sized properly.	*Adjust pixel frequency (CLOCK) and FOCUS or press hot-key (AUTO) .
Picture has color defects (white does not look white)	*Adjust RGB color or select color temperature
Poor brightness or contrast	*The life time of the back-light is limited.In 20000 Hours the luminance of the light has been reduced to half of its original value. Please send the monitor to an authorized service Agent for service.
Horizontal or vertical disturbances on the screen	*Use Win 95/98/2000/ME shutdown mode Adjust CLOCK and FOCUS or perform hot- key (AUTO-key).

CLOCK (pixel frequency) controls the number of pixels scanned by one horizontal sweep. If the frequency is not correct, the screen shows vertical stripes and the picture has not correct width.

FOCUS adjust the phase of the pixel clock signal. With a wrong phase adjustment the picture has horizontal disturbances in light picture.

For FOCUS and CLOCK adjustment use “dot-pattern” or Win 95/98/2000/ME shutdown mode pattern.

ERROR MESSAGE & POSSIBLE SOLUTION

CABLE NOT CONNECTED :

1. Check that the signal-cable is properly connected , If the connector is loose, tighten the connector's screws.
2. Check the signal-cable's connection pins for damage.

INPUT NOT SUPPORT :

Your computer has been set to unsuitable display mode ,Set the computer to display mode given in the following table.

UNSUPPORTED MODE TRY DIFFERENT VIDEO CARD SETTING:

Your computer resolution is out of VESA-SPEC

If the monitor is stuck in Power Saving mode:

1. Make sure monitor's signal-cable is properly connected to the computer.
2. The computer has switched the monitor into screen saver mode. Press any key in the computer keyboard to wake up the monitor.
3. Check that the computer is switched on
4. Check the computer resolution/ rate may be too high, out of LCD-MONITOR display mode range

APPENDIX

SPECIFICATIONS

LCD Panel	Driving system	TFT Color LCD
	Size	38cm(15")
	Pixel pitch	0.297mm(H)x 0.297mm(V)
	Viewable angle	130° (H) 100° (V)
	Response time	35 ms
Input	Video	R,G,B Analog Interface
	Separate Sync.	H/V TTL
	H-Frequency	30kHz - 61kHz
	V-Frequency	55Hz-75Hz
Display Colors		16.7M Colors
Dot Clock		80MHz
Max. Resolution		1024 x 768
Plug & Play		VESA DDC1/2B™
Input Connector		D-Sub 15pin
Input Video Signal		Analog:0.7Vp-p(standard), 75 OHM, Positive
Maximum Screen Size		Horizontal : 12.0" (304.1mm) Vertical : 9.0" (228.1mm)
Power Source		100~240VAC,50~60Hz
Environmental Considerations		Operating Temp: 32°F to 104°F (0°C to +40°C) Storage Temp. -13°F to 140°F (-25°C to 60°C) Operating Humidity : 10% to 85%
Weight (N. W.)		3.7kg

External Controls:	Switch	<ul style="list-style-type: none"> • Auto Adjust Key • ◀ / Brightness • ▶ / Contrast • Power Key • MENU
	Functions	<ul style="list-style-type: none"> • Contrast • Brightness • Focus • Clock • H-Position • V-Position • Language • 6500K • 7800K • RGB Color temperature • Recall • Exit
Power Consumption		25 Watts (For normal model only)
		35 Watts (For USB model only)
Regulatory Compliance		UL, FCC,MPRII,CE,CCC

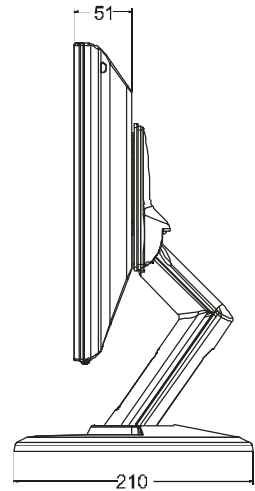
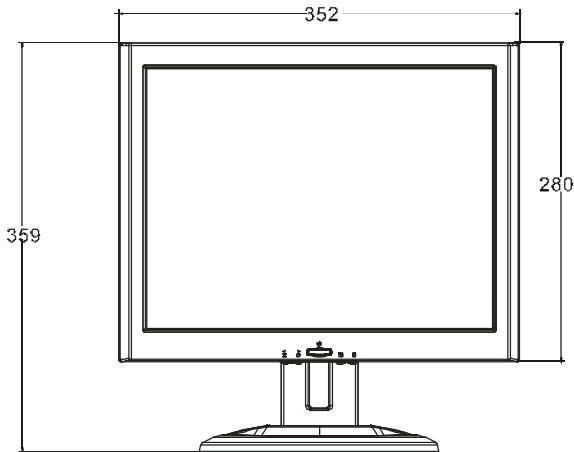

FACTORY PRESET TIMING TABLE

STANDARD	RESOLUTION	HORIZONTAL FREQUENCY	VERTICAL FREQUENCY
VGA	640 × 480	31.469kHz	59.94Hz
	640 × 480	37.861kHz	72.809Hz
	640 × 480	37.5kHz	75.00Hz
TV	NTSC	31.469kHz	59.940Hz
	PAL	31.25kHz	50Hz
DOS	720 × 350	31.47kHz	70.09Hz
DOS	720 × 400	31.469kHz	70.087Hz
SVGA	800 × 600	35.156kHz	56.25Hz
	800 × 600	37.879kHz	60Hz
	800 × 600	48.077kHz	72.188Hz
	800 × 600	46.875kHz	75.0Hz
XGA	1024 × 768	48.363kHz	60.0Hz
	1024 × 768	56.476kHz	70.069Hz
	1024 × 768	60.023kHz	75.029Hz

CONNECTOR PIN ASSIGNMENT

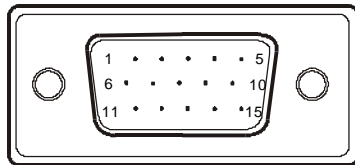

15 - Pin Color Display Signal Cable

PIN NO.	DESCRIPTION	PI N NO.	DESCRIPTION
1.	Red	9.	+5V
2.	Green	10.	PC Detect
3.	Blue	11.	Ground
4.	Ground	12.	DDC-Serial Data
5.	Ground	13.	H-Sync
6.	R-Ground	14.	V-Sync
7.	G-Ground	15.	DDC-Serial Clock

8.	B-Ground		
----	----------	--	--