

TOSHIBA Pocket PC e830

TOSHIBA
Pocket PC e830
User's Manual

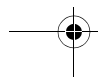
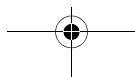
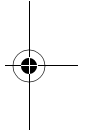
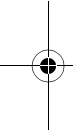
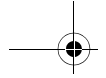

Safety instructions

All safety instructions must be read carefully and must be fully understood, before attempting to use your Toshiba Pocket PC. This manual contains the safety instructions that must be observed in order to avoid potential hazards that could result in personal injuries or could damage your computer. The safety instructions have been classified according to the seriousness of the Risk, as follows:

Signal Word	Meaning
DANGER	Indicates an imminently hazardous situation which, if not avoided, will result in death or serious injury.
WARNING	Indicates a potentially hazardous situation which, if not avoided, could result in death or serious injury.
CAUTION	Indicates a hazardous situation, which will or can cause minor personal injury or property damage if the safety instruction is ignored.
NOTE	Provides you with important but not hazard-related information.

WARNING

Always request and obtain prior consent and approval of an authorized airline representative before using your Pocket PC aboard an aircraft. Always follow the instructions of the airline representative whenever using your Pocket PC aboard an aircraft, to prevent any possible interference with airborne electronic equipment. Your Pocket PC produces low levels of RF energy due to the generation of digital timing pulses by its clock oscillator circuits. Your Pocket PC has been equipped with internal shielding to minimize any stray emissions of RF energy. Airlines may nevertheless prohibit the on-board use of all portable PCs (and all other portable electronic devices that could potentially emit stray RF energy), particularly during take-offs and landings, to prevent any possible interference with the reception of signals by airborne electronic navigational devices.

WARNING

Certain locations, such as hospitals, may restrict the use of Pocket PCs and other devices that emit low-level RF energy.

Always comply with posted prohibitions of the use of RF-emitting devices, such as in hospitals. Failure to follow such directives could result in the interference with medical equipment and/or devices.

Never come closer than 16 cm (6 inches) to a person with a heart pacemaker implant when using this Pocket PC in combination with a mobile cellular telephone. Failure to do so could result in interference with the function of the pacemaker.

WARNING

Never use a Pocket PC while driving an automobile or any other moving vehicle. Always pull out of traffic and come to a stop in a legally permissible and safe location before using your Pocket PC. Failure to do so could result in serious bodily injury in a traffic accident.

Never use your Pocket PC while walking. Usage while walking could result in bodily injury caused by inattention to automobile traffic or other pedestrian hazards.

WARNING

Never allow metallic objects, such as staples and paper clips, to enter inside your Pocket PC. Metallic objects, such as staples and paper clips, if allowed to enter your Pocket PC, could cause the generation of excess heat or fire.

Never connect terminals (metal parts) to metallic objects (such as wires). Connecting terminals to metal objects could cause excessive heat or fire.

Always immediately turn the battery switch to the "off" position and disconnect the AC Adaptor from the power outlet in the event the Pocket PC emits an unusual odor or sound or generates smoke.

WARNING

Never use or store your Pocket PC in the following locations:

Anywhere it may be exposed to water, such as a bathroom or sauna;

In conditions of high humidity, such as in the rain or fog; Where your Pocket PC will be exposed to high temperatures, such as near a fire or equipment that emits high temperatures; In direct sunlight; or In a sealed automobile left in the sun and subject to high temperatures.

Never drop your Pocket PC or subject it to severe shock. Dropping your Pocket PC or subjecting it to severe shock could cause the battery to leak, ignite and/or rupture.

Always immediately remove your Pocket PC from the vicinity of any open flame in the event the battery leaks liquid or emits an unusual odor.

Continued use of your Pocket PC under either of these conditions could cause ignition (i.e., fire) of the leaked battery liquid, or rupture.

Never touch any fluid that might leak from the battery. Such liquid when in contact with the eyes or skin, could cause injury to the skin or eyes. Should the liquid come into contact with the eyes, irrigate the eyes thoroughly with clean water and immediately seek medical attention. In the event the liquid comes into contact with the skin or clothing, wash it away immediately with clean water.



Never attempt to disassemble, repair or make any modification to your Pocket PC. Disassembly, modification or any attempt at repair could cause bodily injury or property damage, as well as damage to the Pocket PC itself.

Failure to follow the above directions concerning use and storage could result in damage to your Pocket PC or bodily injury and property damage due to battery liquid leakage, fire, or rupture.

CAUTION

Never raise the sound volume level to high when using your Pocket PC with earphones. An excessive sound volume level could cause damage to your hearing.

Never touch the liquid that might leak from a broken liquid crystal display. Contact with this liquid could cause a skin rash. If the crystal display liquid should come into contact with the skin or clothing, wash it immediately with clean water.

Never allow infants or small children within reach of your Pocket PC. Infants or small children could injure themselves if allowed access to your Pocket PC.

WARNING

Never attempt to disassemble or repair an AC Adaptor, and never alter their Power Supply Cables or plugs as exposure to electric shock hazards could result.

Always contact an authorized service provider, if repair or replacement is required.

WARNING

Always use the AC Adaptor that has been provided with your Pocket PC.

Bodily injury or property damage could occur as a result of the use of an unauthorized and incompatible AC Adaptor in violation of this Warning.

Never connect or disconnect the AC Adaptor with wet hands. Connecting or disconnecting the AC Adaptor to a power source with wet hands could cause electric shock.

WARNING

Never attempt to connect or disconnect the power plug with damp or wet hands. Connecting or disconnecting the power plug with damp or wet hands could result in an electric shock.

Never leave an open container, such as a cup or glass, containing a liquid near the AC Adaptor. Spilled liquid coming in contact with the AC Adaptor could cause a fire or electric shock.

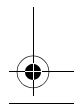
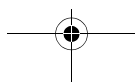
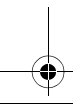
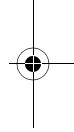
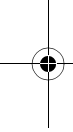



WARNING

Always ensure the power plug pins are clean and free of dust or other foreign material by wiping the pins with a clean dry cloth. Dust or other foreign material accumulation on the power plug pins could cause fire.

Always unplug the power plug from an outlet by grasping the power plug itself. Never pull on the Power Supply Cable to disconnect the Power Supply Cable from an outlet. Pulling on the Power Supply Cable could cause a fire or electric shock as a result of damage to the Power Supply Cable.

Never use a worn or damaged AC Adaptor Power Supply Cable or plug, or a worn or damaged extension cord or plug. The use of a worn or damaged Power Supply Cable or plug could result in electric shock or fire. Always contact an authorized service provider immediately to obtain a suitable Power Supply Cable replacement.

CAUTION

Never place an AC Adaptor on a wooden surface (or any other surface that could be marred by exposure to heat) while it is in use, since its surface temperature increases during normal use. Always rest it on a suitable heat-insulating material.

Never cover the AC Adaptor with any object while it is in use, and never place it adjacent to a heat source. An excessive temperature increase could detrimentally affect its performance.

Never place a Power Supply Cable near a heat source, as damage to the cord or to its insulation could result.

Always use a surge protector when utilizing the AC Adaptor during an electrical storm. Otherwise, a power surge could result in the loss of stored data.

Insert the power plug to a household electric outlet.

When travelling abroad, never plug the AC Adaptor into a power source that does not correspond to both the voltage and the frequency specified on the rating plate of the unit, as equipment damage will result.

CAUTION

Never bend or twist a Power Supply Cable, and never pull on a Power Supply Cable in an attempt to remove a plug from an outlet. Always grasp the plug directly when unplugging a Power Supply Cable to avoid causing any damage to the cord.

Never plug the AC Adaptor into an overloaded multiple outlet, power strip or surge protector to prevent blowing a fuse or tripping a circuit breaker.

Never place heavy objects on a Power Supply Cable, as that could result in damage to the cord.

Always confirm that the AC Adaptor plug (and the extension cord and plug, if any) have been fully inserted into the receptacle, to assure a secure electrical connection.

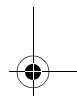
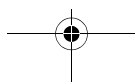
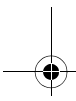
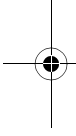

CAUTION

Under certain conditions, data may be lost, including:

Misuse of your Pocket PC; Subjecting the main unit of your Pocket PC to static electricity and/or noise; Total loss of electric charge in the battery; and Servicing of your Pocket PC.

Avoid connecting your Pocket PC to an external device such as a computer in an environment likely to be affected by static electricity. For example during low-humidity weather, shuffling your shoes upon a rag can produce static electricity. Before you handle your computer, you should touch a grounded object to discharge any static electricity from your body.

Avoid using your Pocket PC in environments that are likely to be affected by static electricity or are prone to high electrical noise. If you connect your Pocket PC to a computer via the optional docking cradle for data transfer or data restoration purposes, Toshiba will not be responsible for any Pocket PC or computer malfunction, problems with data transfer or data modifications/loss that may occur in these environments.

Use your Pocket PC only in locations with the following ambient environmental conditions:

Under normal operational use with temperatures between 0°C and 40°C (32°F and 104°F); With humidity of 30% to 80%; and When charging the battery with temperatures between 5°C and 40°C (41°F and 104°F).

Do not store or use your Pocket PC in the following locations:

Those subject to extremely high or low temperatures; Dusty locations; and Locations or sites subject to strong vibration.

Use or storage in these location, sites or areas can result in product failure, malfunction or loss of data.

Do not subject your Pocket PC to sudden and severe temperature changes. This could result in moisture condensation in the Pocket PC that could cause damage to your Pocket PC, computer function loss, and/or the loss of data. In the event of moisture condensation, allow your Pocket PC to dry out completely.

It is normal for the AC Adaptor to become warm when charging.

Disconnect the power plug from the outlet when not in use.

Take care not to sit on your Pocket PC when it is located in the back pocket of trousers, etc. This could cause damage to your Pocket PC or malfunction of the Pocket PC functions.

Do not place objects on top of your Pocket PC or drop them on top of your Pocket PC. This could cause damage to your Pocket PC and/or malfunction.

Clean terminals (metallic parts) on a regular basis with a cotton swab. Dirty terminals could affect battery charging.

Never use organic solvents such as benzene or paint thinner to clean your Pocket PC. Use of these solvents can cause deformation or discoloration.



Do not wipe the display with a damp or wet cloth or touch the display with damp or wet hands. Wiping or touching the display under this condition can cause product failure or malfunction. Always use a soft dry cloth to wipe the display.

When using the SD memory card, be sure to read the relevant instruction manual and ensure that you know the proper procedures for their use.

Never subject the card to any severe shock while connected to your Pocket PC. Such a shock can cause damage to the card and a malfunction.

Do not carry your Pocket PC with the card connected to it. This can result in the damage or loss of the card.

Never connect the optional cradle terminals with metallic objects, such as wires. Connecting these terminals with metallic objects may cause the production of excess heat, burns and damage to the charger and/or your Pocket PC.

Lithium-Ion batteries are recyclable. Never dispose of the battery with ordinary waste.

Never bend or twist your Pocket PC. This could cause damage to your Pocket PC or malfunction of the Pocket PC functions.

Limitation of liability

- Toshiba Corporation is in no way liable for any damage resulting from earthquakes, lightning, wind, flood; or fire, actions on the part of a third party, or other accidents beyond the control of Toshiba Corporation; intentional acts, negligence or misuse on the part of the user, or any usage under abnormal conditions.
- Toshiba Corporation is in no way liable for any damage, including but not limited to change or loss of stored data, loss of business profit, loss of earnings, interruption of business, or lost communication opportunities that are caused by use or nonuse of this product.
- Toshiba Corporation is in no way liable for any damage resulting from failure to comply with the contents of this user's guide.
- Toshiba Corporation is in no way liable for any damage resulting from malfunction due to use with connection devices or software other than those provided by Toshiba Corporation.
- Toshiba Corporation cannot guarantee any data recorded in memory devices, such as internal memory and memory cards, regardless of the cause of damage or malfunction.

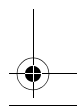
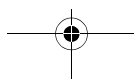
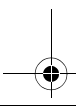
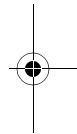
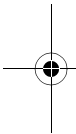



Usage conditions for Bluetooth

The Bluetooth was not developed or produced for use with equipment in systems that directly support the medical welfare of individuals or systems that are critical for the maintenance of public welfare and safety. Do not use the Bluetooth for these purposes.

1. These include life-support systems, surgery room equipment, and other medical devices.
2. These include the main equipment control systems and safety protection systems at nuclear power facilities, other critical safety systems, fleet transportation operating control systems, and air traffic control systems.

Do not disassemble, modify or try to service this product yourself.

This may cause injury. Unapproved changes or modifications to this product could void your authority to operate this product. Please contact the dealer from whom you purchased this product and request repair service.

Do not use this product in areas where the use of electrical devices is prohibited, such as on board an aircraft and in a hospital.

If you are uncertain whether electrical devices are prohibited, please consult the proper authorities and follow all instructions. Usage in prohibited areas can cause an accident due to radio interference with equipment such as aviation and medical equipment.

Do not use the Bluetooth within 9 inches (22 cm) of persons with a heart pacemaker implant or defibrillator implant.

Failure to maintain this distance can cause a malfunction of the pacemaker due to radio interference.

Do not use the Bluetooth near an automated controlling device, such as an automatic door or fire alarm.

Failure to do so can cause an accident due to radio interference with the automated controlling device.

Immediately discontinue use of the Bluetooth if it causes radio interference with other devices.

Continued use of the Bluetooth can cause other devices to malfunction and thereby create an accident.

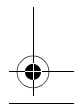
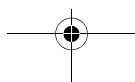
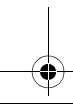
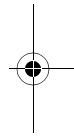
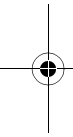



Keep the product out of the reach of children, as it may be accidentally swallowed or cause injury.

Supplementary Information:	“The product complies with the requirements of the Low Voltage Directive 73/23/EEC and the EMC Directive 89/336/EEC.”
Weitere Informationen:	“Das Produkt entspricht den Anforderungen der Niederspannungsrichtlinie Richtlinie 73/23/EG und der EMC-Richtlinie 89/336/EG.”
Informations complémentaires:	“Ce produit est conforme aux exigences de la directive sur les basses tensions 73/23/CEE et de la directive EMC 89/336/CEE.”
Información complementaria:	“El Producto cumple los requisitos de baja tensión de la Directiva 73/23/CEE y la Directiva EMC 89/336/CEE.”
Ulteriori informazioni:	“Il prodotto é conforme ai requisiti della direttiva sulla bassa tensione 73/23/EG e la direttiva EMC 89/336/EG.”
Ytterligare information:	“Produkten uppfyller kraven enligt lågspänningsdirektiver 73/23/EEC och EMC-direktiv 89/336/EEC.”

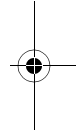
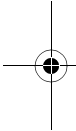

Working environment

This product was designed to fulfill the EMC (electromagnetic compatibility) requirements for “residential, commercial and light industry environments”.

Toshiba does not approve the use of this product in working environments other than “residential, commercial and light industry environments”.

For example, the following environments are not approved:

- Industrial Environments (environments with a main voltage >230V~)
- Medical Environments
- Automotive Environments
- Aircraft Environments

Any consequences resulting from the use of this product in working environments that are not approved are not the responsibility of Toshiba Corporation.

The consequences of the use of this product in non-approved working environments may be:

- Interference with other devices or machines in the nearby surrounding area
- Malfunction of, or data loss from, this product caused by disturbances generated by other devices or machines in the nearby surrounding area

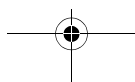
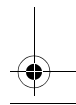
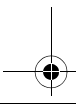

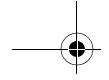

Therefore Toshiba strongly recommends that the electromagnetic compatibility of this product be suitably tested in all non-approved working environments before use. In the case of automobiles or aircraft, the manufacturer or airline respectively should be asked for permission before use of this product.

Furthermore, for general safety reasons, the use of this product in environments with explosive atmospheres is not permitted.

CE compliance

This product and the original options are designed to observe the related EMC (Electromagnetic compatibility) and safety standards. However, Toshiba cannot guarantee that this product still observes these EMC standards if options or cables not produced by Toshiba are connected or implemented. In this case the persons who have connected/implemented those options/cables have to make sure that the system (PC plus options/cables) still fulfils the required standards. To avoid general EMC problems, the following advice should be observed:

- Only CE marked options should be connected/implemented
- Only best shielded cables should be connected

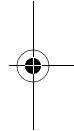
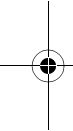

Only peripherals complying with the FCC class B limits may be attached to this equipment. Operation with non-compliant peripherals or peripherals not recommended by Toshiba is likely to result in interference to radio and TV reception. Shielded cables must be used between the external devices and the computer's USB ports, external monitor port, PS/2 keyboard port and PS/2 mouse port. Changes or modifications made to this equipment, not expressly approved by Toshiba or parties authorized by Toshiba could void the user's authority to operate the equipment.

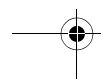
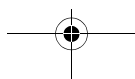
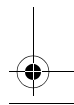
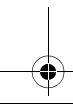

TOSHIBA Pocket PC e830

Table of Contents

<i>Chapter 1</i>	Getting Started	
	Welcome	1-1
	Where to Find Information	1-1
<i>Chapter 2</i>	Basic Skills	
	Parts Names and Function	2-1
	Battery Charging	2-7
	How to Attach/Detach the Main Battery Pack	2-8
	How to Use the Optional High Capacity Battery Pack	2-10
	How to Use the Optional Presentation Pack	2-12
	Program	2-19
	Customize Your Toshiba Pocket PC	2-20
	Setting a Password	2-23
	System Information	2-24
<i>Chapter 3</i>	Microsoft ActiveSync	
<i>Chapter 4</i>	Bluetooth	
	Specifications	4-1
	Bluetooth Settings	4-3
	Bluetooth Environmental Settings	4-4
	Preparing to Connect with Bluetooth	4-6
	Using COM Service	4-8
	Using DUN/LAP Service	4-9
	Using PAN Service	4-9
	Using OPP Service	4-11
	Using FTP Service	4-14
	The Bluetooth Settings Screen	4-16
<i>Chapter 5</i>	Optional Functions	
	How to Make a Backup	5-1
	Carrying Out the Restore Operation	5-3
	Using TOSHIBA Text to Speech for Pocket PC	5-7
	Using Voice Command	5-12



Chapter 6 **Additional Information**

Troubleshooting	6-1
Resetting	6-4
Clear Memory	6-4
Troubleshooting for Wi-Fi	6-5
FAQ for Wi-Fi	6-6
Troubleshooting for Toshiba IP Phone for Pocket PC	6-12
Glossary for Bluetooth	6-14
Specifications	6-17

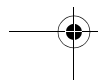
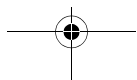
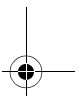
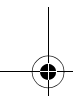
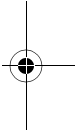
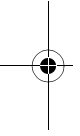

Chapter 1

Getting Started

Welcome

Congratulations on purchasing your Toshiba Pocket PC. Due to the size and capabilities of this device, you can keep your most important business and personal information up-to-date and close at hand. Microsoft® ActiveSync® increases the power of your device by allowing you to synchronize the information on your desktop or laptop computer with your device.

Where to Find Information

This book describes your Pocket PC hardware, provides an overview of the programs on your Pocket PC, and explains how to connect your Pocket PC to a computer, a network, or the Internet. For instructions on setting up your Pocket PC and installing ActiveSync, see information to help you use your Pocket PC

For information on:	See this source:
Programs on your Pocket PC	This User's Guide and device Help To view Help, tap  and then Help.
Additional programs that can be installed on the Pocket PC	The Pocket PC Companion CD.
Connecting to and synchronizing with a computer	The Quick Start Card or Active Sync Help on your computer. To view Help, open the Microsoft Active Sync application, and then click Help.



Getting Started



For information on:

See this source:

Last-minute updates and detailed technical information

The Read Me files, located in the Microsoft Active Sync folder on the computer and on the Pocket PC Companion CD.

Up-to-date information on your Toshiba Pocket PC

<http://www.toshiba.co.jp/worldwide>

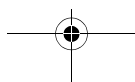
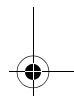
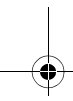
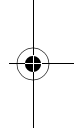
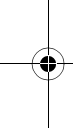

Chapter 2

Basic Skills



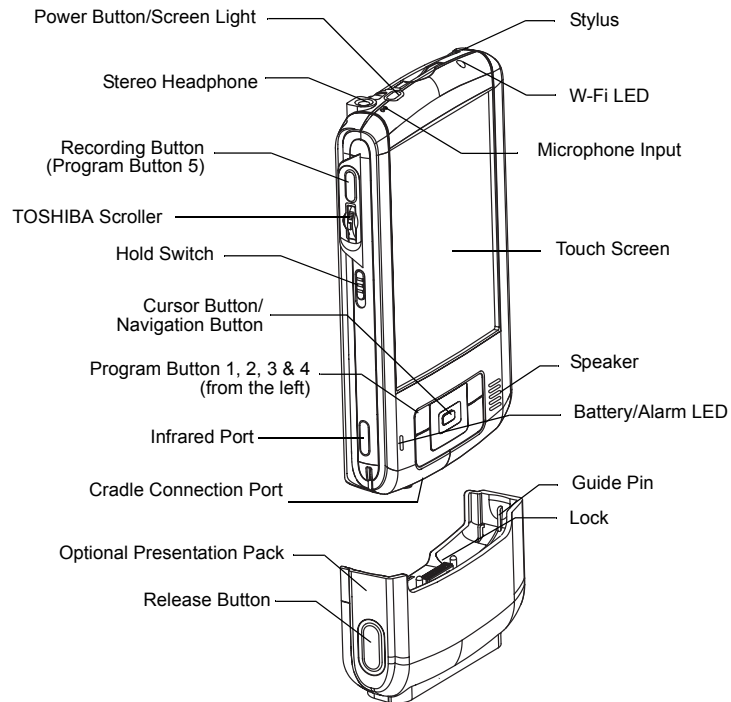

Your Toshiba Pocket PC e800 is easy to learn how to use. This chapter describes the use and customization of your Toshiba Pocket PC e800.

Parts Names and Function

Main unit (front view)



Program Button Initial Settings

- Program button 1 = Calendar 
- Program button 2 = Tasks 
- Program button 3 = Home 
- Program button 4 = Contacts 
- Program button 5 = Voice recorder 

Main unit (end view)

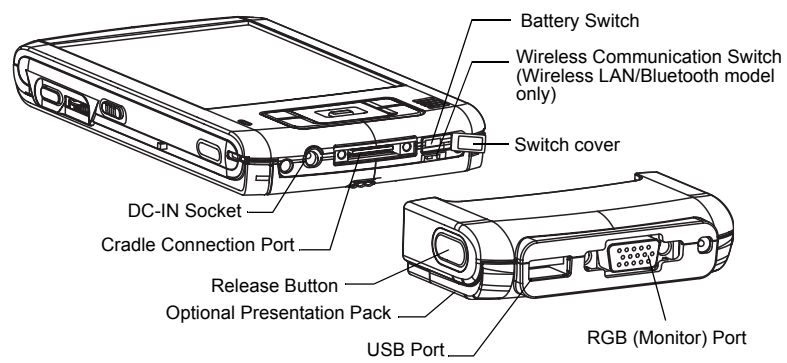

Cradle

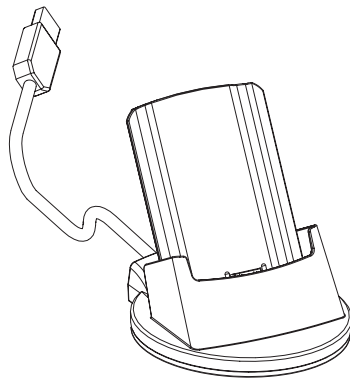

Main unit (back view)

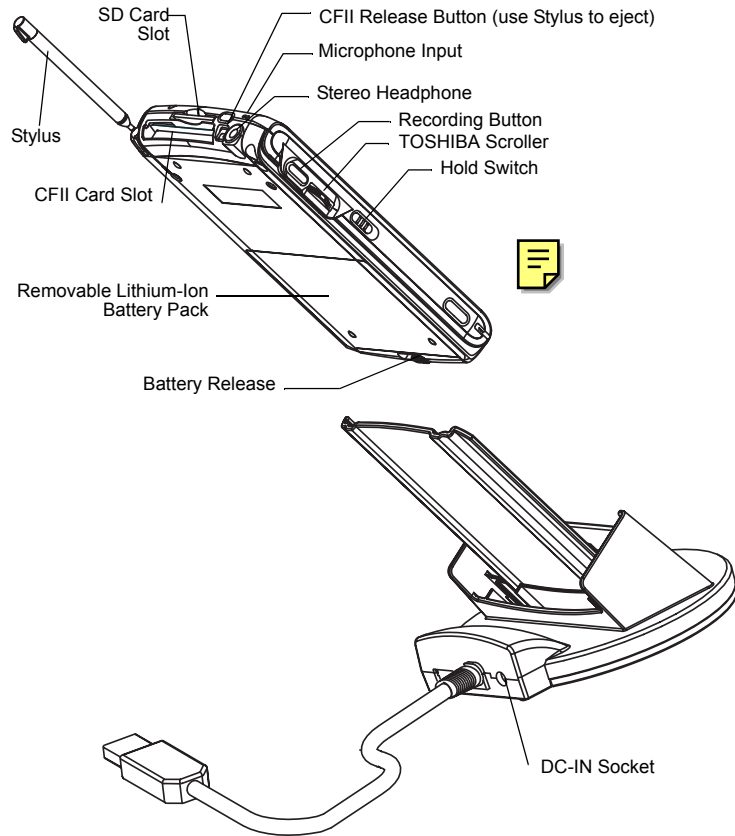

Power Button

The power button performs the functions described in the table below.

Power button	When the power is off	When the power is on
Press and hold.	The power turns on.	The screen light alternately turns on/off.
Press it quickly.	The power turns on.	The power turns off.

Battery Switch

The battery switch supplies/cuts off the battery power to the Toshiba Pocket PC e830.

Basic Skills

The setting of this switch at shipment is "stop". When using the Toshiba Pocket PC e830 for the first time, open the switch cover, then slide this switch to the left (the "supply" side) with the stylus



Switching the battery switch to the "stop" position at any time will lead to loss of data.

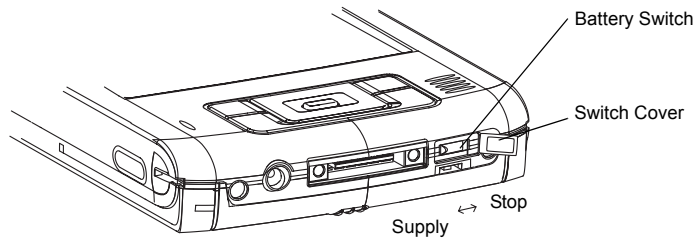

To turn on the battery switch:

1. Open Switch cover.
2. Slide the battery switch to the right.

Battery/Alarm LED

The Battery/Alarm LED indicates the machine condition

Flashing orange	When the preset alarm time, which was set through Calendar or Tasks, goes off, the lamp starts flashing.
Orange	Indicates charging of the battery.
Yellow	The battery charging process is stopped due to the ambient temperature being too high or low. Charge the battery in an ambient temperature of approximately 41°F to 104°F (5°C to 40°C).
Green	Indicates full charge of the battery.

Wireless Communication Switch

1. To enable Wireless module (Wireless LAN/Bluetooth models only), make sure the Wireless Communication Switch is turned on. (The default setting is Power Off. Open the switch cover, then slide the switch to the left to turn the power on.) If the switch is on, a window will pop up with a list of networks.
2. Select a network. On Windows Mobile 2003, if the switch is turned on, a window will pop up to show the list of existing networks you can join

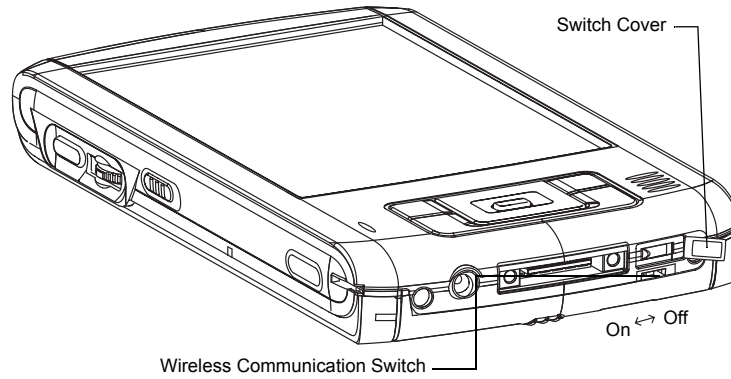

Wireless LED

LED indicates the status of the Wireless Communication Switch

LED	Status
Off	Wireless Communication Switch is turned OFF
Orange	Wireless Communication Switch is turned ON

Hold Switch

When the Hold switch is on, Program Buttons 1 through 5, Cursor Button, and Scroller will be disabled. The Hold switch icon  will be displayed on the navigation bar. On the contrary, when the Hold switch is off, these buttons will be enabled again.

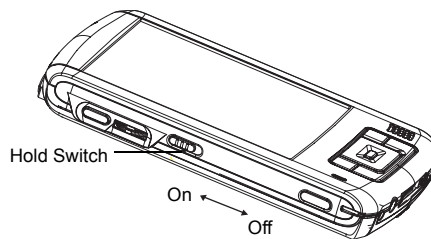

How to Use the Stylus

The stylus is used for menu selection or data input on the touch-screen of the Toshiba Pocket PC e830.

- **Tap:** Touch the screen once with the stylus to open items and select options.
- **Drag:** Hold the stylus on the screen and drag it across to select text and images. Drag in a list to select multiple items.
- **Tap and hold:** Tap and hold the stylus on an item to see a list of actions available for that item. On the pop-up menu that appears, tap the action you want to perform.



When you operate the touch screen of the Toshiba Pocket PC e830, use the supplied stylus.

If the tip of the stylus is damaged, do not use it. If you operate the touch screen with a damaged stylus or a ballpoint pen, the touch screen may be damaged.

When the stylus is damaged, please purchase a new one.

About the Cursor Button

There are 2 modes for cursor button control,

- 4-direction (upper, lower, right, or left)
- 8-direction (oblique angles are added).

You can select either of these two modes by tapping **Settings**, and then **Buttons**. In either mode, you can move a cursor (selection display) on the screen by pressing the upper, lower, right, or left part of the cursor button. You can select a program to launch by pressing the center part of the cursor button.



The cursor movement is different depending on the screen. When the cursor is at the right or the left side of the screen, it may not move.

About the Scroller

About the TOSHIBA Scroller

You can move the cursor on the screen by moving the scroller up and down, as well as launching a program by pressing the scroller.

You can also activate the previous window by holding down the scroller until the current window closes. To enable or disable this function, select the mode by tapping **Settings**, and then **Buttons**.



The cursor movement is different depending on the screen. When the cursor is at the right or the left side of the screen, it may not move.

Battery Charging

When using the Toshiba Pocket PC e830 for the first time, set the battery switch to the supply side, and then charge the removable battery with the supplied AC adapter.

Assembling the Cradle

Prior to charging the battery, the back plate that supports the Toshiba Pocket PC e800 while charging needs to be inserted into the base of the cradle. To do this, insert the transparent plate (side A facing the cradle connection port) into the cradle base to cradle position P1 as shown below. If your Toshiba Pocket PC e800 is equipped with a high capacity battery pack, insert the transparent plate into the cradle base to cradle position P2.

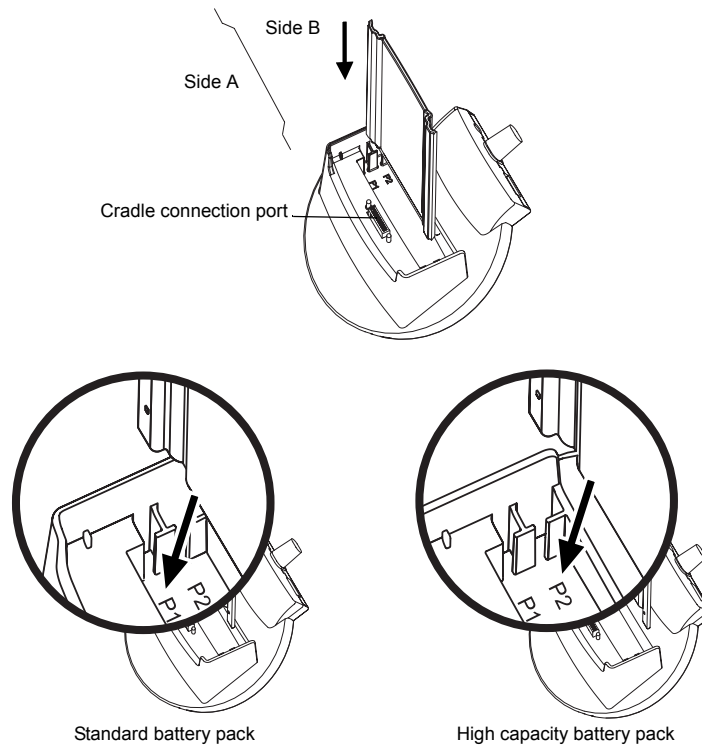

How to Charge the Battery

You can use the following charging methods:



Turn the unit off before connecting the AC Adapter and your Toshiba Pocket PC e830.

Basic Skills

Method 1:

Connect the supplied AC adapter and the Toshiba Pocket PC e830 as shown in the figure below.

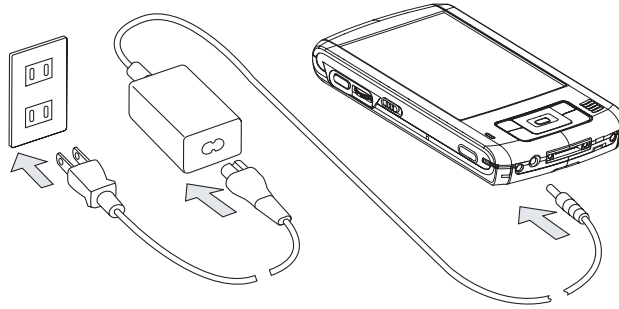

Handling the cord on this product will expose you to lead, a chemical known to the State of California to cause birth defects or other reproductive harm. Wash hands after handling.

Method 2:

Connect the supplied AC adapter and the cradle as shown in the figure below, and then insert the Toshiba Pocket PC e830 into the cradle.

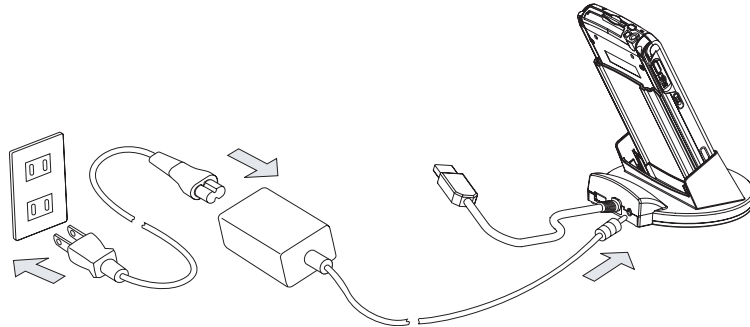

For charging the battery, maintain an ambient temperature from approximately 41°F to 104°F (5°C to 40°C).

When the lamp is lit in orange during the battery charging, you can use the Toshiba Pocket PC e830.

When the battery is completely charged, the LED alarm lamp color will change to green.

How to Attach/Detach the Main Battery Pack

1. Turn off the power.
2. Switch the Battery Pack Lock to release the battery pack.

3. Attach/Detach the battery from the Pocket PC

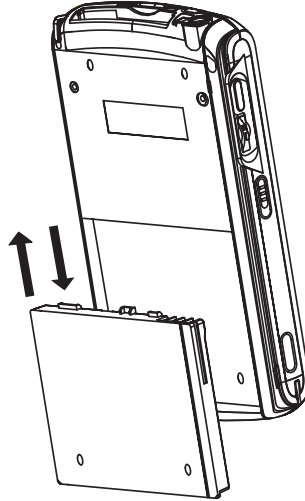

You cannot turn on the power if the Battery Pack Lock is in the Release Position.



You can change the main battery without data loss because the Toshiba Pocket PC e830 has a rechargeable backup battery. However, the capacity of the backup battery is limited, therefore when you change the main battery, attach the new main battery and switch the Battery Pack Lock to the lock side as soon as possible.

How to Use the Optional High Capacity Battery Pack

1. Turn off the power .
2. Detach the Main Battery.

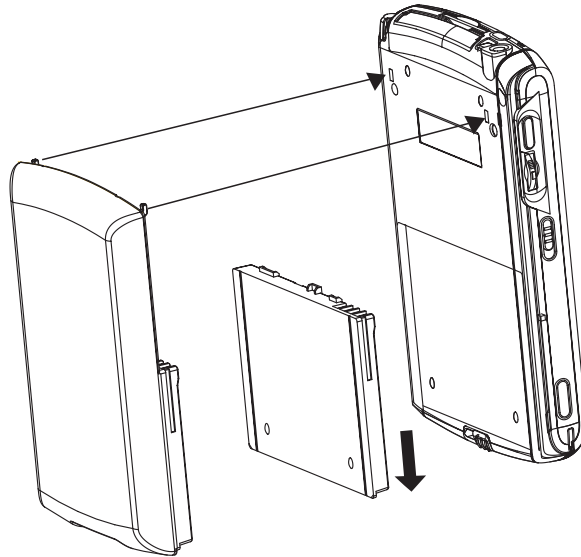

3. Attach the High Capacity Battery pack to the Pocket PC.



You cannot turn on the power if Battery Pack Lock is at the Release side.



You can replace the main battery with the High Capacity Battery pack without data loss because Toshiba Pocket PC e830 has a rechargeable backup battery. However, the capacity of the backup battery is limited, therefore when you replace the main battery, attach the new High Capacity Battery and switch the Battery Pack Lock to the lock side as soon as possible.

How to Prolong Battery Life

- Use the Toshiba Pocket PC e830 with the AC adapter.
Under the following conditions where the power consumption will be high, please use the AC adapter when:
 - Operating while connected to your computer.
 - Operating with a storage card or with any other optional equipment.
- In addition,
 - Select the short power-off time in the setting menu to shorten the time the unit will remain on if not used (see "Customize Your Toshiba Pocket PC" on page 2-20).
 - Turn off the screen light.
 - Set the screen brightness to power saving mode and shortening the light turn-off time (see "Customize Your Toshiba Pocket PC" on page 2-20).
 - Use your unit with an ambient temperature between 59°F and 77°F (15°C and 25°C). This temperature range is the most effective for the battery.
 - When you use the Toshiba Pocket PC e800 in high or low temperature environments, the operable time is shortened due to the decrease of the battery capacity.
 - You can save power if the wireless communication module is off.

Battery Life

The removable battery has a limited life. Repeated charging/discharging of the battery gradually decreases operable time. When the operable time has been diminished, it is time to replace the removable battery with a new one.

- Do not leave the Toshiba Pocket PC e800 in a place of high or low temperature. It may shorten battery life.



If you have not used the Toshiba Pocket PC e830 for several days, its battery charge level reading may be inaccurate. Fully recharge the battery before using.

Battery Charge Level and Stored Data Protection

If the battery charge level becomes extremely low, or the battery becomes completely discharged, the memory data stored in the Toshiba Pocket PC e830 could be lost.

Basic Skills

When the low battery status icon or the alarm message appears, immediately connect the AC adapter to the Toshiba Pocket PC e830 and charge the battery.

- The removable battery gradually discharges even if the device is not being used. When the Toshiba Pocket PC e830 is left for a long time, the removable battery of the Toshiba Pocket PC e830 may completely discharge.
- It is recommended to save the Toshiba Pocket PC e830's memory data to your computer or to a storage card.
- The manufacturer is not responsible for data change or clearance due to battery discharge.

How to Use the Optional Presentation Pack

You can use the Optional Toshiba Presentation Pack (as shown on page 1) together with the Toshiba Pocket PC e830 to connect to additional peripherals.

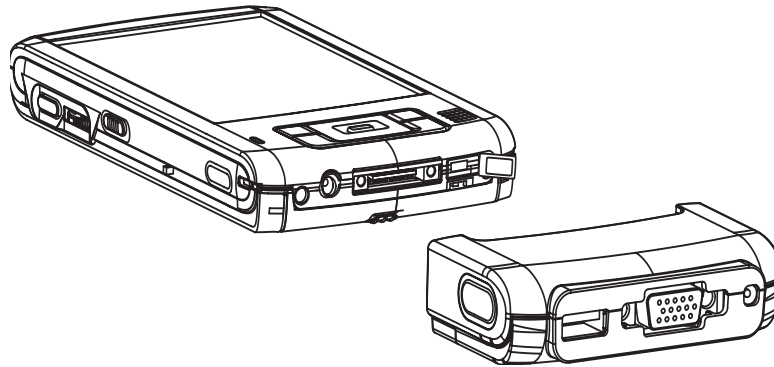

Parts and Functions of the Presentation Pack

The **Cradle Connection Port** allows you to connect the Presentation Pack to the Cradle. You can connect Cradle to PC via USB or Serial. Additionally, you can connect a USB keyboard to the Cradle so that you use a USB keyboard to enter text on your Toshiba Pocket PC e830.

The **RGB (Monitor) Port** is a standard 15-pin RGB port for connecting an external display device such as a monitor or projector (640 pixels x 480 pixels with 64K colors at 60 Hz and 800 pixels x 600 pixels with 64K colors at 60 Hz).



Only IA-Presenter and IA Screen Mirror (see your online manual) can output the image to the external monitor. Other applications cannot output the image to the external monitor.

The **USB Port** allows you to connect USB keyboard to the Pocket PC.



Use only a Microsoft® Pocket PC-compatible keyboard.

Release Button: When pressed, the **Release Button** releases the Presentation Pack from the Toshiba Pocket PC e830.

Connecting the Presentation Pack to the Pocket PC

1. Plug the **Guide Pins** into the corresponding jacks on the Toshiba Pocket PC e830. A light click is heard when the Presentation Pack is locked in place.



*The locks are based on foolproof design to help you connect the Presentation Pack to the Pocket PC with the right face-up, i.e. the face with the **Release Button**.*

Releasing the Presentation Pack from the Pocket PC

Press the **Release Button** on the Presentation Pack and gently remove the Pack from the Toshiba Pocket PC e830.

How to use the Optional USB Host Client Cable

The optional USB Host Cable allows you to connect a USB keyboard to the Pocket PC.

To connect a USB keyboard to the Pocket PC:

1. Turn off the power.
2. Plug the optional USB Host Cable to the Pocket PC.
3. Connect a USB keyboard to the USB Port of the optional USB Host Cable.



Charging the battery or connect AC adapter if the battery power is low. You cannot use a USB keyboard if the battery power is less than 15%.

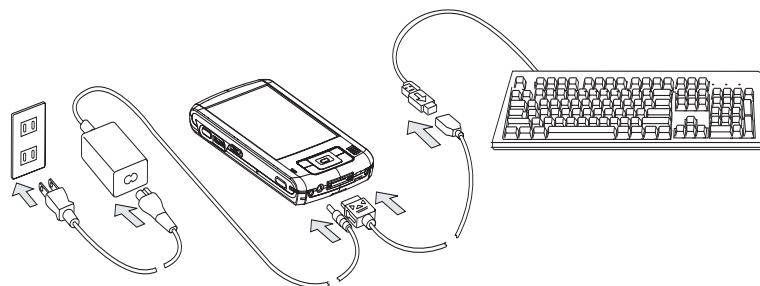

Use only a Microsoft Pocket PC-compatible keyboard.

Initial Setup

When using the Toshiba Pocket PC e830 for the first time, follow the initial setup procedures below, after the battery has been charged.

1. Move the battery switch to the "supply" position. The Toshiba Pocket PC e800 powers on automatically and the Welcome screen appears. Tap the screen to start the following setup.

2. Execute touch screen correction.

When the align screen appears, tap the center of the cross target with the stylus. The next target position changes upon tapping the target. Five taps completes the positioning correction. The screen then changes to the Stylus screen.

- If a finger or any other object touches the screen during correction, the correction will be cancelled. Repeat the correction procedure.

3. Read how to use the stylus.

- Read and understand the stylus operation, and then tap **NEXT**.



For more information on stylus operation, See "How to Use the Stylus" on page 6.

4. Learn the pop-up menu operation.

- Read the on-screen explanation and then follow the instructions. Display the pop-up menu, and cut and paste the data according to the screen instructions.

- After you finish the paste operation, this stage is completed. Tap **NEXT**.

5. Set the TIME ZONE.

- When tapping the right ▼ mark, the city and the time zone lists appear. Tap the desired city and time zone.

- When the setup is completed, tap **NEXT**.

6. To complete the initial setup.

- When the Complete screen appears, the initial setup is completed.

- After tapping the screen, you can use the Toshiba Pocket PC e830.



When you tap the Complete screen, the Today screen appears. For more information on the Today screen, see your online manual.

Inserting a CF II Card

1. Turn off the power.
2. Remove the dummy card.

3. Insert the CF II Card.

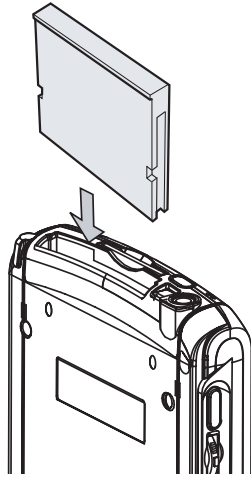

To remove a card:

1. Turn off the power.
2. Lightly press down the release button with the stylus. The button will pop out. Press down on the release button again. The card will withdraw slightly from the slot.
3. Pull the card straight up to remove.

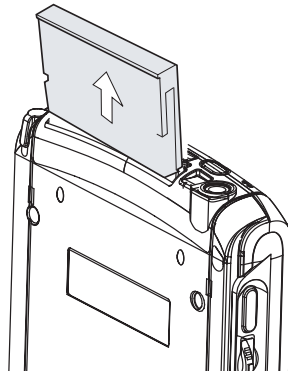

Use stylus to release the CF card.

Inserting an SD Card

1. Turn off the power.
2. Remove the dummy card.