

































Contents













FOR YOUR SAFETY 31











	<i>Traffic Safety</i>	31
	<i>Do Not Use in Hospitals</i>	31
	<i>Do Not Use in Airplanes</i>	31
	<i>Do Not Use in Gasoline Stations</i>	31
	<i>Do Not Use in Explosive Sites</i>	32
	<i>Operating Environment</i>	32
	<i>Standard Usage</i>	32
	<i>Accessories and Batteries</i>	32
	<i>Appropriate Maintenance</i>	32
	<i>Emergency Calls (SOS)</i>	32
	<i>Use with proper care to reduce electromagnetic interference (EMI)</i>	33

GETTING STARTED 34

	PHONE OVERVIEW	34
	INSTALLATION & REMOVAL	35









	<i>Installing the battery</i>	35
	<i>Removing the battery</i>	35
	<i>Inserting the SIM Card</i>	36
	<i>Removing the SIM Card</i>	36
	<i>Connecting the Charger</i>	37
	<i>Removing the Charger</i>	37
	KEYPAD DESCRIPTION	38
	ALPHANUMERIC MAPPING	41
	DISPLAY INDICATORS	42
	BASIC OPERATION 	43
	<i>Making a Call</i>	43
	<i>The SIM Card</i>	44
	<i>Battery and Charger</i>	44
	<i>Switching on the Phone</i>	45
	<i>PIN and PIN2 (4 to 8 digits)</i>	45
	<i>PUK1 and PUK2 (8 digits)</i>	45
	<i>Calling</i>	46
	<i>Dialing Emergency Numbers</i>	46
	<i>Correcting an Entry</i>	46
	<i>Answering a Call</i>	46





 <i>Recent Calls</i>	47
 <i>Quick Dial</i>	47
 <i>Holding a Call</i>	47
 <i>Multiparty Calls</i>	48
 <i>Input Methods</i>	49
1. Multitap ABC/abc	50
2. Smart ABC/abc (Smart Predictive Text Mode)	50
3. Symbols.....	51
5. Numeric.....	51
MENU FUNCTION 	52
 PHONE BOOK	52
 <i>Quick Search</i>	52
1. View	52
2. Edit.....	53
3. Delete	53
4. Copy.....	53
5. Move	53
6. Duplicate	53
 <i>Search Entry</i>	53
1. Search.....	53
 <i>Add New Entry</i>	54
 <i>Copy All</i>	55
 <i>Delete All</i>	55
1. From SIM.....	55
2. From Phone	55

3. One by One	56
 <i>Caller Group</i>	56
 <i>Extra Number</i>	56
 <i>Settings</i>	56
1. Memory Status	56
2. Preferred Storage.....	56
3. Fields.....	57
 MESSAGES	57
 <i>SMS</i>	57
1. Done.....	57
2. Cancel	57
3. Use Template.....	57
4. Insert Object.....	58
5. Format Text	58
<input type="radio"/> Text Size	58
<input type="radio"/> Text Style.....	58
<input type="radio"/> Alignment	58
<input type="radio"/> New Paragraph	58
6. Input Methods	58
 <i>Inbox</i>	58
 <i>Outbox</i>	59
 <i>Delete</i>	59
<input type="radio"/> Delete Inbox	59
<input type="radio"/> Delete Outbox.....	59
<input type="radio"/> Delete All.....	59
 <i>Template</i>	59
 <i>Message Settings</i>	60



⊙ Profile Settings	60
⊙ Common Settings	60
⊙ Memory Status.....	60
⊙ Preferred Storage	60
⊙ Pref. Bearer.....	60
 <i>MMS (Multimedia Messages)</i>	61
1. Write Message.....	61
A. Validity Time	61
B. Delivery Report	61
C. Read Report.....	61
D. Priority	61
2. Inbox	61
3. Outbox.....	62
4. Drafts.....	62
5. Templates	62
6. Message Settings	62
⊙ Sending.....	62
▶Validity Period.....	62
▶Delivery Report.....	62
▶Priority	62
▶Slide Timing.....	62
▶Delivery Time	62
⊙ Retrieval	62
▶Home Network.....	62
▶Roaming.....	62
▶Read report.....	63
▶Delivery Report.....	63
⊙ Filters.....	63
▶Anonymous	63
▶Max Size	63
▶Advertisement	63





⊙ Edit Profile.....	63
▶Rename Profile.....	63
▶Home Page	63
▶Data Account.....	63
▶Connection Type	64
▶Username	64
▶Password	64
⊙ Memory Status.....	64
 <i>Email</i>	64
1. Send and Receive	64
2. Write Email	64
⊙ Send.....	65
⊙ Send and Save.....	65
⊙ Save to Drafts	65
⊙ Quit without Saving.....	65
3. Inbox	65
⊙ Reply	65
⊙ Reply without Content.....	65
⊙ Reply All.....	65
⊙ Reply All without Content	66
⊙ Forward	66
⊙ Delete.....	66
4. Unsent	66
5. Sent	66
6. Drafts.....	66
7. Delete All Folder	66
8. Email Profile	66
⊙ Common Setting	66
> Profile Name.....	66
> Data Account	67
> Signature.....	67







> Signature Image.....	67
> Signature Text.....	67
⊙ Outgoing Server.....	67
⊙ Incoming Server	67
 <i>Voice Mail Server</i>	67
 <i>Broadcast Message</i>	68
⊙ Receive Mode.....	68
* Off.....	68
* List Only	68
* All Channels.....	68
⊙ Read Message.....	68
⊙ Languages.....	68
⊙ Channel Settings	68
 CALL HISTORY	69
 <i>Missed Calls</i>	69
1. View	69
2. Delete	69
3. Save to Phone book.....	70
4. Dial.....	70
5. Edit.....	70
 <i>Dialed Calls</i>	70
 <i>Received Calls</i>	70
 <i>Delete Call Log</i>	70
 <i>Call Time</i>	70
1. Last Call Time.....	70
2. Total Sent	70
3. Total Received.....	71
4. Reset All Time.....	71









 <i>Call Cost</i>	71
1. Last Call Cost.....	71
2. Total Cost.....	71
3. Reset Cost.....	71
4. Max Cost.....	71
5. Price Per Unit.....	71
 <i>SMS Center</i>	71
1. Sent.....	72
2. Received.....	72
 <i>GPRS Center</i>	72
1. Last Sent.....	72
2. Last Received.....	72
3. All Sent.....	72
4. All Received.....	72
5. Reset Center.....	72
 SETTINGS	72
 <i>Phone Setup</i>	72
1. Time and Date.....	72
⊙ Set Home City.....	72
⊙ Set Time/Date.....	73
⊙ Set Format.....	73
2. Schedule Power On/Off.....	73
⊙ Status.....	73
⊙ Power Settings.....	73
⊙ Time Settings.....	73
3. Language.....	74
4. Preferred Input Methods.....	74
5. Display Characteristic.....	74
⊙ Wallpaper.....	74
⊙ Screen Saver.....	74

* Settings	74
Status	74
Waiting	74
* Select	74
⊙ Show Date and Time	74
⊙ Show Owner Number	75
⊙ Show Operator Name	75
6. Contrast	75
7. Greeting Text	75
⊙ Status	75
⊙ Greeting Text	75
8. Speed Dial	75
⊙ Enable Speed Dial	75
⊙ Set Number	75
9. Shortcuts	76
10. Dedicated Key	76
11. Auto Update of Date and Time	76
 <i>Call Setup</i>	76
1. Caller ID	76
⊙ Set by Network	76
⊙ Hide ID	76
⊙ Send ID	76
2. Call Waiting	77
⊙ Activate	77
⊙ Deactivate	77
⊙ Query Status	77
3. Call Divert	77
⊙ Divert All Voice Calls	77
⊙ Divert If Unreachable	77
⊙ Divert If No Answer	77
⊙ Divert If Busy	77
⊙ Cancel All Divert	78
4. Call Barring	78

⊙ Outgoing Calls.....	78
⊙ Incoming Calls.....	78
⊙ Cancel All.....	78
⊙ Change Barring PW.....	78
5. Line Switching.....	78
6. Call Time Reminder.....	78
7. Call Time Display.....	78
8. Auto Redial.....	79
 <i>Network Setup</i>	79
1. Network Selection.....	79
2. Preferred Networks.....	79
⊙ Add from List.....	79
⊙ Create New.....	79
⊙ Change Priority.....	79
⊙ Delete.....	79
3. Band Selection.....	79
⊙ 900.....	80
⊙ 1900.....	80
⊙ Dual Band.....	80
4. GPRS Selection.....	80
⊙ When needed.....	80
⊙ Always.....	80
 <i>Security Setup</i>	80
1. SIM Lock.....	80
2. Phone Lock.....	80
3. Auto Keypad Lock.....	80
4. Fixed Dial.....	80
⊙ Mode.....	81
⊙ Fixed Dial List.....	81
5. Barred Dial.....	81
⊙ Mode.....	81
⊙ Barred Dial List.....	81

6. Change Password	81
⊙ PIN	81
⊙ PIN2	81
⊙ Phone Lock Password	81
 <i>Restore Factory Settings</i>	82
 MULTIMEDIA	82
 <i>Camera</i>	82
1. Send	82
2. Apply	82
3. Detail	82
4. Rename	82
5. Delete	83
 <i>To Image Viewer</i>	83
1. Send	83
2. Apply	83
3. Delete	83
4. Delete	83
5. Rename	83
6. View Detail	83
 <i>Audio Player</i>	84
1. Play	85
2. Detail	85
3. Add To Rings	85
4. Refresh List	85
5. Settings	85
⊙ List Auto Gen	85
⊙ Repeat	85
⊙ Shuffle	85
⊙ Background Play	86

 <i>Sound Recorder</i>	86
1. Record.....	86
2. Play.....	86
3. Append.....	86
4. Rename.....	87
5. Delete.....	87
6. Delete All.....	87
7. Settings.....	87
8. Forward.....	87
 <i>Melody Compose</i>	87
 <i>File Manager</i>	88
 FUN & GAMES.....	88
 <i>Game</i>	88
1. Riches.....	88
⊙ Resume.....	88
⊙ Start Game.....	88
⊙ Game Level.....	88
⊙ Best Grades.....	89
⊙ Game Help.....	89
2. Color Balls.....	89
⊙ Start Game.....	89
⊙ Game Level.....	89
⊙ Best Grades.....	89
⊙ Game Help.....	89
 <i>Game Setting</i>	89
1. Game Audio.....	89
2. Game Vibration.....	90
 USER PROFILES.....	90

 <i>General</i>	90
1. Activate	90
2. Customize	90
⊙ Tone Setup	90
⊙ Volume.....	91
⊙ Alert Type	91
Ring.....	91
Vibration Only.....	91
Vibra and Ring	91
⊙ Ring Type	91
⊙ Extra Tone.....	91
⊙ Answer Mode.....	92
⊙ LCD Backlight.....	92
 <i>Meeting</i>	92
 <i>Outdoor</i>	92
 <i>Indoor</i>	93
 <i>Headset</i>	93
 PIM	93
 Calendar.....	93
 To Do List.....	93
 Alarm	94
1. On/Off	94
2. Time Settings.....	94
3. Repeat	94
⊙ Once	94
⊙ Everyday.....	94
⊙ Days.....	94

 Calculator.....	94
 <i>World clock</i>	95
 SERVICES	95
BATTERY 	96
CARE AND MAINTENANCE 	97
☉ CONTACT YOUR NEAREST SERVICE STATION IF THE MOBILE PHONE IS OUT	97
OF ORDER. OUR WELL-TRAINED TECHNICIANS WILL PROVIDE YOU THE BEST	97
SERVICE.	錯誤! 尚未定義書籤。
FCC REGULATIONS	錯誤! 尚未定義書籤。
FCC RF EXPOSURE INFORMATION ...	錯誤! 尚未定義書籤。
<i>Body-worn Operation</i>	錯誤! 尚未定義書籤。

PhoneBook

- Quick Search
 1. Send SMS
 2. View
 3. Edit
 4. Delete
 5. Copy
 6. Move
 7. Duplicate
- Search Record
 1. Search
 - ⊙ Send SMS
 - ⊙ View
 - ⊙ Edit
 - ⊙ Delete
 - ⊙ Copy
 - ⊙ Move
 - ⊙ Duplicate
 2. Input Method
 - ⊙ Multitap ABC
 - ⊙ Multitap abc
 - ⊙ Smart ABC
 - ⊙ Smart abc
 - ⊙ Numeric
 - ⊙ Smart Thai
 - ⊙ Insert Symbols
- Add New Record
 1. To SIM
 - ⊙ Name
 - ⊙ Number
 2. To Phone

- ⊙ Name
- ⊙ Number
- ⊙ Home Number
- ⊙ Company Name
- ⊙ Email Address
- ⊙ Office Number
- ⊙ Fax Number
- ⊙ Associate Picture
- ⊙ Associate Sound
- ⊙ Caller Group
- Copy All
 - 1. From SIM
 - 2. From Phone
- Delete All
 - 1. From SIM
 - 2. From Phone
 - 3. One by One
- Caller Group
 - 1. Friends
 - 2. Family
 - 3. VIP
 - 4. Business
 - 5. Others
- ⊙ Name
- ⊙ Ring
- ⊙ Picture
- ⊙ Color Pattern
- ⊙ Member List
- Extra Number
 - 1. Owner Number
- ⊙ Edit
- ⊙ Erase
 - 2. Service Dial Number

- 3. SOS Number
- Settings
- 1. Memory Status
- 2. Preferred Storage
- ⊙ SIM
- ⊙ Phone
- 3. Fields
- ⊙ Home Number
- ⊙ Company Name
- ⊙ E-mail Address
- ⊙ Office Number
- ⊙ Fax Number
- ⊙ Associate Picture
- ⊙ Associate Sound
- ⊙ Caller Group

Messages

- SMS
- 1. Inbox
- ⊙ Reply
- ⊙ Delete
- ⊙ Edit
- ⊙ Forward
- ⊙ Use Number
- ⊙ Save Objects
- 2. Outbox
- ⊙ Send
- ⊙ Edit
- ⊙ Delete
- ⊙ Use Number
- 3. Write Message
- ⊙ Done
- ⊙ Use Template
- ⊙ Insert Object

- ⊙ Format Text
- ⊙ Input Method
- 4. Delete
 - ⊙ Delete Inbox
 - ⊙ Delete Outbox
 - ⊙ Delete All
- 5. Template
 - ⊙ Edit
 - ⊙ Erase
- 6. Messages Settings
 - ⊙ Profile Setting
 - ⊙ Common Setting
 - ⊙ Memory Status
 - ⊙ Preferred Storage
 - ⊙ Prefer Bearer
- MMS
 - 1. Write Message
 - ⊙ Send Only
 - ⊙ Save and Send
 - ⊙ Save to Drafts
 - ⊙ Send Options
 - ⊙ Exit
 - 2. Inbox
 - 3. Outbox
 - 4. Drafts
 - ⊙ View
 - ⊙ Properties
 - ⊙ Send
 - ⊙ Edit Message
 - ⊙ Delete
 - ⊙ Delete All
 - ⊙ Use Number
 - 5. Templates

- ⊙ View
- ⊙ Properties
- ⊙ Write Message
- 6. MMS Settings
- ⊙ Sending
- ⊙ Retrieval
- ⊙ Filters
- ⊙ Edit Profile
- ⊙ Memory Status
- Email
- 1. Send and Receive
- 2. Write Email
- ⊙ Send
- ⊙ Send and Save
- ⊙ Save to Drafts
- ⊙ Quit without Saving
- 3. Inbox
- ⊙ Reply
- ⊙ Reply without Content
- ⊙ Reply All
- ⊙ Reply All without Content
- ⊙ Forward
- ⊙ Delete
- 4. Unsent
- ⊙ Send
- ⊙ Send and Save
- ⊙ Save to Drafts
- ⊙ Quit without Saving
- 5. Sent
- ⊙ Forward
- ⊙ Delete
- 6. Drafts
- ⊙ Edit

- ⊙ Delete
- 7. Delete All Folder
- ⊙ Inbox
- ⊙ Unsent
- ⊙ Sent
- ⊙ Drafts
- ⊙ Delete All Folder
- 8. Email Profile
- ⊙ Activate
- ⊙ Edit
- ▶ Common Setting
- ▶ Outgoing Server
- ▶ Incoming Server
- Voice Mail Server
- 1. Voice Mail
- 2. Empty
- ⊙ Edit
- ⊙ Erase
- ⊙ Connect to Voice
- Broadcast Message
- 1. Receive Mode
- ⊙ Off
- ⊙ List Only
- ⊙ All Channel
- 2. Read Message
- ⊙ Read Message
- 3. Languages
- ⊙ All Languages
- 4. Channel Settings
- ⊙ Select
- ⊙ Add
- ⊙ Edit
- ⊙ Delete

Call List

- Missed Calls
 - 1. View
 - 2. Delete
 - 3. Save to Phone book
 - ⊙ To SIM
 - ⊙ To Phone
 - 4. Dial
 - 5. Edit
 - ⊙ To SIM
 - ⊙ To Phone
- Dialed Calls
 - 1. View
 - 2. Delete
 - 3. Save to Phone book
 - ⊙ To SIM
 - ⊙ To Phone
 - 4. Dial
 - 5. Edit
 - ⊙ To SIM
 - ⊙ To Phone
- Received Calls
 - 1. View
 - 2. Delete
 - 3. Save to Phone book
 - ⊙ To SIM
 - ⊙ To Phone
 - 4. Dial
 - 5. Edit
 - ⊙ To SIM
 - ⊙ To Phone
- Delete Call Log
 - 1. Missed Calls

- 2. Dialed Calls
- 3. Received Calls
- 4. Delete All
- Call Time
- 1. Last Call Time
- 2. Total Sent
- 3. Total Received
- 4. Reset All Time
- Call Cost
- 1. Last Call Cost
- 2. Total Cost
- 3. Reset Cost
- 4. Max Cost
- 5. Price Per Unit
- SMS Counter
- 1. Sent
- 2. Received
- GPRS Counter
- 1. Last Sent
- 2. Last Received
- 3. All Sent
- 4. All Received
- 5. Reset Counter

Settings

- Phone Setup
- 1. Time and Date
- ⊙ Set Home City
- ⊙ Set Time/Date
- ⊙ Set Format
- 2. Schedule Power On/Off
- ⊙ Four Schedule Sets
- 3. Language
- ⊙ English

- 4. Preferred Input Methods
 - Multitap ABC
 - Multitap abc
 - Numeric
 - Smart ABC
 - Smart abc
- 5. Display Characteristic
 - Wallpaper
 - Screen Saver
 - Show Date and Time
 - Show Owner Number
- 6. Contrast
- 7. Greeting Text
 - Status
 - Greeting Text
- 8. Speed Dial
 - Enable Speed Dial
 - Set Number
- 9. Shortcuts
- 10. Dedicated Key
 - Up
 - Down
 - Left
 - Right
- 11. Auto Update of Date and Time
 - Call Setup
 - 1. Caller ID
 - Set by Network
 - Hide ID
 - Send ID
 - 2. Call Waiting
 - Activate
 - Deactivate

- Query Status
- 3. Call Divert
 - Divert All Voice Calls
 - Divert If Unreachable
 - Divert If No Answer
 - Divert If Busy
 - Divert All Data Calls
 - Cancel All Divert
- 4. Call Barring
 - Outgoing Calls
 - Incoming Calls
 - Cancel All
 - Change Barring PW
- 5. Line Switching
- 6. Call Time Reminder
 - Off
 - Single
 - Periodic
- 7. Call Time Display
- 8. Auto Redial
 - Network Setup
 - 1. Network Selection
 - Automatic
 - Manual
 - 2. Preferred Networks
 - Network List
 - 3. Band Selection
 - 900
 - 1800
 - 1900
 - Dual Band
 - 4. GPRS Connection
 - When needed

- Always
- Security Setup
- 1. SIM Lock
 - On
 - Off
- 2. Phone Lock
 - On
 - Off
- 3. Auto Keypad Lock
 - None
 - 5 sec.
 - 30 sec.
 - 1 min.
 - 5 min.
- 4. Fixed Dial
 - Mode
 - Fixed Dial List
- 5. Barred Dial
 - Mode
 - Barred Dial List
- 6. Changed Password
 - PIN
 - PIN2
 - Phone Lock Password
- Restore Factory Settings

Multimedia

- Camera
- 1. To Image Viewer
 - View
 - Send
 - Apply
 - Detail
 - Rename

- ⊙ Delete
- ⊙ Delete All File
- ⊙ Sort
- 2. Camera Setting
 - ⊙ Image Size
 - ⊙ Effect Setting
 - ⊙ Add Frame
 - ⊙ Cont Shot
 - ⊙ Night Mode
 - ⊙ Delay Timer
- 3. Advance Setting
 - ⊙ White Balance
 - ⊙ Image Quality
 - ⊙ EV (Exposure Value)
 - ⊙ Shutter Sound
 - ⊙ Banding
- 4. Restore Default
 - Image Viewer
 - 1. View
 - 2. Send
 - 3. Apply
 - 4. Detail
 - 5. Rename
 - 6. Delete
 - 7. Delete All Files
 - 8. Sort
 - Audio Player
 - 1. Play
 - 2. Detail
 - 3. Add To Rings
 - 4. Refresh List
 - 5. Settings
- ⊙ List Auto Gen

- ⊙ Repeat
- ⊙ Shuffle
- ⊙ Background Play
- File Manager
 - 1. Audio
 - 2. Images
 - 3. Photos
- ⊙ Open
- ⊙ Create Folder
- ⊙ Rename
- ⊙ Delete
- ⊙ Sort
- ⊙ Format
- ⊙ Free Space
- Sound Recorder
 - 1. Record
 - 2. Play
 - 3. Append
 - 4. Rename
 - 5. Delete
 - 6. Delete All
 - 7. Settings
- ⊙ AMR
- ⊙ WAV
- 8. Forward
 - ⊙ To User Profile
 - ⊙ Via MMS
 - ⊙ Via E-Mail
- Melody Compose
 - 1. Play
 - 2. Edit
- ⊙ Play
- ⊙ Play Speed

- ⊙ Select Instrument
- ⊙ Save
- 3. Add
- ⊙ Play
- ⊙ Play Speed
- ⊙ Select Instrument
- ⊙ Save
- 4. Rename
- ⊙ Done
- ⊙ Cancel
- ⊙ Input Method
- 5. Delete
- 6. Delete All Files
- 7. Forward
- ⊙ To User Profile
- ⊙ Via MMS
- ⊙ Via E-Mail
- ⊙ Via EMS

Fun & Games

- Game
- 1. Riches
- ⊙ Start Game
- ⊙ Game Level
- ⊙ Best Grades
- ⊙ Game Help
- 2. Color Balls
- ⊙ Start Game
- ⊙ Game Level
- ⊙ Best Grades
- ⊙ Game Help
- Game Settings
- 1. Game Audio
- 2. Game Vibration

User Profile

- General
 - 1. Activate
 - 2. Customize
 - ⊙ Tone Setup
 - ▶ Incoming Call
 - ▶ Alarm
 - ▶ Power On
 - ▶ Power Off
 - ▶ Message Tone
 - ▶ Keypad Tone
 - ⊙ Volume
 - ⊙ Alert Type
 - ▶ Ring
 - ▶ Vibration Only
 - ▶ Vibra and Ring
 - ▶ Vibra Then Ring
 - ▶ Light Only
 - ⊙ Ring Type
 - ▶ Single
 - ▶ Repeat
 - ▶ Ascending
 - ⊙ Extra Tone
 - ▶ Warning
 - ▶ Error
 - ▶ Camping On
 - ▶ Connect
 - ⊙ Answer Mode
 - ▶ Any Key
 - ⊙ LCD Backlight
 - ▶ LCD Backlight
 - ▶ Status LED
- Meeting

- Outdoor
- Indoor
- Handset



- Calendar
 1. Jump to Date
 2. View Tasks
- To Do List
- Alarm
 1. On/Off
 2. Time Settings
 3. Repeat
- ⊙ Once
- ⊙ Everyday
- ⊙ Days
- World Clock



For Your Safety

Only proper operation can ensure your personal safety. Be sure to carefully read these simple guidelines before you use the phone. Breaking the rules may be dangerous or illegal. Further detailed information is given in this user manual.



Traffic Safety

Don't use a mobile phone while driving. For your safety, you should park the vehicle before making or answering a call. Using a handsfree car kit or earpiece is highly recommended.



Do Not Use in Hospitals

The use of mobile phones is prohibited and may cause interference with the functionality in medical devices in the hospitals. Check the laws and regulations or posted notices. To avoid electromagnetic interference (EMI) with medical devices, please switch off the phone near medical equipment.



Do Not Use in Airplanes

The use of mobile phones in an aircraft may disrupt radio transmissions and signals. This, therefore, can be dangerous to the operation of the aircraft. Be sure to switch off the phone while on board an aircraft. It is highly recommended to detach the battery pack from the handset to prevent accidentally switching on the phone by miss-touching the power key.



Do Not Use in Gasoline Stations

It is advisable that users switch off the phone at a refueling point. The threat mobile phones pose to gas stations and their users is primarily the result of their ability to produce sparks that can be generated by the high-powered battery inside the phone.



Do Not Use in Explosive Sites

The use of mobile phones should be restricted near potentially explosive atmosphere sites such as chemical plants, fuel storage, or the areas where blasting operations are in process. Observe restrictions, and follow any posted regulations or rules.



Operating Environment

Mobile radio transmitting equipment, including mobile phones, may be subject to interference and may cause danger. Therefore, it is highly recommended that you follow any special regulations in any area. Switch the phone off whenever the use is forbidden.



Standard Usage

For the satisfactory operation of the mobile phone, it should be used only in a normal operating position. Do not touch the antenna unnecessarily.



Accessories and Batteries

This phone can only be connected to approved accessories and batteries. Do not connect incompatible products.



Appropriate Maintenance

Only qualified and authorized personnel should service the phone equipment. Faulty installation or repair may be hazardous.



Emergency Calls (SOS)

An emergency call (SOS number) can be made with the phone in any circumstances, and even the phone is locked. When making an emergency call, you must be sure to give all the

necessary information, such as your name, your mobile phone number, the location and the emergency situation, as accurately as possible. In order to deliver the sufficient information to a rescue institute, do not disconnect your phone until told to do so.



Use with proper care to reduce electromagnetic interference (EMI)

This product has passed the inspection of the Directorate-General of Telecommunications, Ministry of Transportation and Communication. The highest reported SAR values which are: Head 0.45W/kg; Body-worn 0.77 W/kg are lower than the standard value at 1.6 W/kg, maximum. Mobile phones are apt to generate high frequency energy, electromagnetic wave before connection. In order to avoid EMI impact on human body, we strongly recommend you to listen to the phone after the line is connected.

Getting Started

Phone Overview

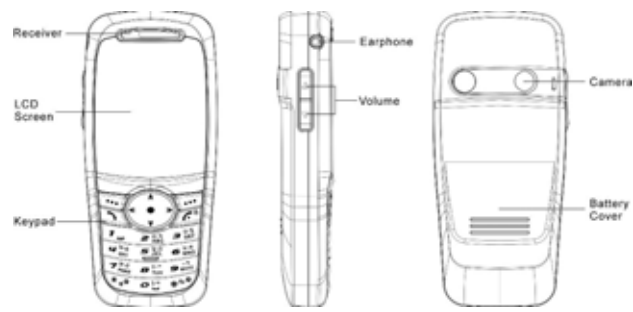

Figure 1

⚠ Warning: Please do not detach any parts of this mobile phone and only use original manufacturer components to guaranty the quality of transmission.

Installation & Removal



Installing the battery

1. Place the battery pack downward and gently slide its side corners into this handset's bottom fillister.
2. Hold and press the battery pack forward until it contacts to the handset. Make sure that the metallic connector is firmly facing the built-in hinged-type connectors on the handset.
3. Push and slide the battery cover forward so as to clasp the latch.

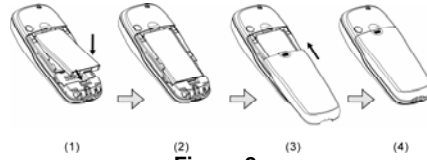

Figure 2



Removing the battery

1. Switch off the handset first and gently pushes the latch of the battery cover backward to separate it from the handset.
2. Press the battery pack's latch backward and the uplift the bottom of the battery pack and remove the battery from handset.

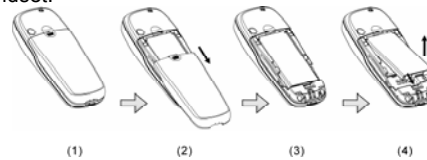

Figure 3

Important! : Notice the risk of explosion in case of incorrect use of unfit battery. Moreover, when the duration you remove the battery from the phone is over 20 seconds, the time won't be punctual.

Inserting the SIM Card

1. Find the SIM slot. Place your SIM card golden contact area downward.
2. Place the SIM card with leaning 30° and gently insert it into card slot until the card folder firmly clips the card in its place.

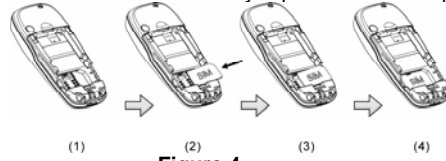

Figure 4

Important! : Before removing the cover, always switch off the power first and disconnect the handset from the charger or any other devices.

Removing the SIM Card

Switch off the power first and remove the battery cover. Press and slide SIM forward so as to remove SIM from the holder and slot as shown in figure 5.

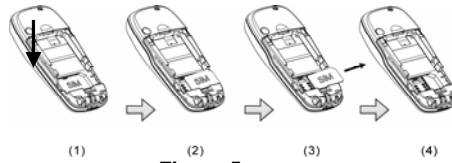

Figure 5

Important! : Keep all miniature SIM cards out of the reach of small children. The SIM card and its contacts can be easily damaged by scratches or bending, so be careful when handling, inserting and removing the cards.



Connecting the Charger

To connect the travel charger to the handset, you should install the battery first. Follow the travel charger instruction, and plug the connector with the **↑** sign upside into the handset as shown in figure 6.



Figure 6

Note:

1. Do not remove your battery or SIM card while charging.
2. Use a compatible or appropriate charger for the handset.
3. Manipulate the charger carefully, or the connector might be damaged easily.







Removing the Charger







When removing the charger from battery, disconnect the plug





from the electrical outlet.

Keypad Description

In the handset, there are two softkeys - left softkey and right softkey. Key functions are used in main menu / list menu / function window. The function definition of the handset is made in screen with left / right softkey. Keypad functions are described in the diagram as below:

Key	Description
	<p>Affirmative inputs: OK, select, call, save and reply.</p> <p>In main menu / submenu mode, press this key to enter the next submenu</p> <p>Press this key to answer an incoming call.</p> <p>Press it to put a call in hold; or call retrieve by pressing the key once again.</p> <p>Press this key as "Enter" key to access function menus, submenus and selection.</p> <p>In standby mode, press this key and  to lock/unlock the handset.</p> <p>When a call is in progress, press this key to hold, end, new call, phone book, SMS, sound recorder, mute and DTMF.</p>
	<p>Negative inputs: end, no, return, cancel, abort, and quit.</p> <p>In standby mode, press this key to instantly access phonebook list. If users press this key to quickly access phonebook, they can press  to switch input methods.</p> <p>Press this key to clear single character, number, or symbol from the right to left.</p>

Key	Description
	<p>Long press this key to clear all texts or phone numbers that are entered.</p> <p>In menu/submenu, press this key to return the previous level.</p> <p>Press this key to activate either earphone or loud speaker function for handsfree use during an incoming call.</p> <p>Press this key to reject an incoming call.</p>
	<p>Press this key to dial out a call.</p> <p>Press this key to answer a call.</p> <p>In standby mode, press it to view call log comprising incoming, outgoing, rejected and missed calls.</p>
	<p>Press this key to end / reject a call</p> <p>Press and hold it to switch on/off phone.</p> <p>Press it to return to standby mode while function menu is in progress.</p>
	<p>Four-way Navigation Key.</p> <p>Default Shortcut functions setup/selection in standby mode:</p> <p>Up – Tone Setup</p> <p>Down – Shortcuts</p> <p>Left – SMS Inbox</p> <p>Right – Alert Type</p>
	<p>The symbols of numerals and letters.</p> <p>Keypads 2~9 are set as speed dial. See on page 59.</p>
	<p>Press and hold this key for two seconds to launch voice mailbox function. Access the voice box number (generally 3 digits) of your telecom service provider before using this phone for the first time.</p>

Key	Description
	<p>In editorial mode, press this key to switch digit "0" and space.</p>
	<p>In standby mode, long press this key to switch between current activated mode and silent mode. When users long press this key to activate silent mode, vibrator function, meanwhile, is also activated.</p> <p>In editorial mode, press the key to switch entry methods among ABC, abc, 123, eZiABC and eZiabc.</p> <p>At ready window mode, long press this key could silence key tone.</p> <p>Press and hold this key to enable or disable vibration function.</p>
	<p>Press and hold this key for seconds to automatically display "*", "+", "P" and "W" in sequence in the screen. The symbol "+" represents an international dial-up code.</p> <p>Press and hold this key until the symbol "+" appears and then dial the rest phone number for an international call.</p> <p>In editorial mode, press this key to select symbols.</p> <p>Input a phone number first and then long press this key until a pop-up character "P" shows, and then input extension number and then press dialing key.</p>
	<p>Press this sidekey to adjust volume in idle / active mode.</p> <p>Press this sidekey to adjust volume in earpiece mode.</p> <p>Press this sidekey to adjust volume of loud speaker in handsfree mode.</p>



Alphanumeric Mapping

The alphabetical and numerical keypad mapping relations are listed on the following table:







	Upper Case Mode	Lower Case Mode
1	. , - ? ! ` @ : # \$ / _ 1	. , - ? ! ` @ : # \$ / _ 1
2	A B C 2	a b c 2
3	D E F 3	d e f 3
4	G H I 4	g h i 4
5	J K L 5	J k l 5
6	M N O 6	m n o 6
7	P Q R S 7	p q r s 7
8	T U V 8	t u v 8
9	W X Y Z 9	w x y z 9
0	space 0	space 0
*	Select symbols as below: . , ? ! ' " () @ \ / : _ ; + - * = % & < > £ \$ ¥ § € ¤ [] { } ~ #	Select symbols as below: . , ? ! ' " () @ \ / : _ ; + - * = % & < > £ \$ ¥ § € ¤ [] { } ~ #















	Upper Case Mode	Lower Case Mode
	space ↵	space ↵
#	Switch input methods among ABC, abc, 123, eZiABC and eZiabc.	Switch input methods among ABC, abc, 123, ZiABC and Ziabc.

Note:

1. In editorial mode, press  to switch between current input mode and symbol input mode.
2. In editorial mode, press  to switch inputs methods among ABC, abc, 123, eZiABC and eZiabc.
3. Pressing a number key in the editing mode will generate the corresponding character appearing on the display.
4. After releasing the key and wait for a second, the cursor will move to next spot for new input.
5. If there is any difference between the character sets listed in the table and on the phone, please refer to the displayed characters on the phone.



 **Display Indicators.**

Indicator	Description
	Battery power level indicator. The battery cells flashes from right and left while being charged.
	L1 Call forward is on.
	L2 Call forward is on.
	L1 and L2 Call forward are both on.
	The handset is locked.
	The icon of missed call.

Indicator	Description
	New SMS is in mailbox.
	New voice mail is received in L1.
	New voice mail is received in L2.
	New voice mail are received in both L1 and L2.
	The roaming function is activated
	The vibration call alert is activated
	Mute is active during a call.
	Ring is active.
	Vibrates then rings.
	Vibrates and rings.
	L1 is active.
	L2 is active.
	Alarm is activated.
	The signal strength of network connection at your current location. The more the bars are, the stronger the signal is received. (The total is four cells.)

Basic Operation

Making a Call

1. Switch off the power first and properly installs the SIM card.
2. The phone still can be connected with the travel charger and used normally even when the battery runs out of power,
3. Press and hold  for two seconds to switch on the phone. If the display indicates "Enter PIN ", please input the PIN number to unlock your SIM card, (please refer to the Manual provided by the telecom service provider for more details) and then press  to use this handset.
4. Input the area code and phone number, and press  to

dial the number.

Important! :

Check the signal strength before making a call. The signal indicator on the left side of the phone's screen shows the strength of the network radio signal. The indicator scrolls as the signal strength increases and decreases. To get the strongest signal, try moving your phone slightly. If you're inside a building, move toward a window.



The SIM Card

Your telecom service provider usually offers the SIM card. For the SIM installation, please see on to [page 27](#). This phone can be used only with legally issued SIM cards and receive or send the calls only within the SIM network service range.



Battery and Charger



The Li-ion battery that comes with this phone is rechargeable. Please use the charger and the battery provided by the original manufacturer to ensure safety and a long lifetime for the cellular phone.

1. Place the charger into an appropriate outlet that meets the requirements of this phone. The other end is connected to the phone. While the phone is being recharged, the screen will automatically show the current power recharge status of the battery via a flashing signal. The phone that is switched on can still function normally while being recharged. Once the recharging process is done, the flashing signal will terminate.
2. Once the recharging process is done, the charger can be disconnected from the phone and electrical outlet.
3. This is an international charger (Model is subject to change in different countries). Read instructions on the charger label before use.

4. A 'battery low' message will display on the screen to alert you to a battery low condition. The phone will automatically shut down when the battery is exceptionally low.
5. If the battery totally runs out of power, the battery needs to be recharged at least ten minutes. Otherwise, this phone may be difficult to be switched on.



Switching on the Phone

To switch on the phone, please hold  for around 2~3 seconds. If the message "Enter PIN:" shows on the screen, the "PIN:" code of the SIM card must be entered in (please refer to the Manual provided by the telecom service provider for more information). Then, press  to switch on the phone.



PIN and PIN2 (4 to 8 digits)

A PIN (Personal Identification Number) code is stored in your SIM card and is supplied by your SIM card network service provider. To prevent unauthorized use, you need to enter PIN1 code each time while you switch on your phone. Enter the correct PIN1 code and press .

Important! :

1. If a wrong PIN code is entered over limited trials regulated by system operators, the phone becomes locked or disabled. You must ask for your network provider to use the PUK code to unlock or enable the phone again.
2. PIN2 code is for other functions, such as certain number dialing and barring.





PUK1 and PUK2 (8 digits)

The PUK (Personal Unblocking Key) code is required to change a blocked PIN code. Check with your network provider for the

code. After getting the PUK1 code and unlocking the PIN1, you can reset your PIN1.



Calling

Enter the area code and phone number, the press  to dial out a call. The prompt dialing process to reach an extension number is to enter phone number first, pressing and holding

 and until "P" shows on the screen. Then you need to enter the extension number right this moment and press

 to dial out the phone number. Apply the dialing process will promptly reach the extension number.

Dialing Emergency Numbers



1. Please switch on the phone first. Enter an emergency number and press  to dial out.
2. Most networks allow users to make emergency calls without inserting a SIM card. In the case of no SIM card, you'll see the **SOS** indicator on the bottom-right corner after switching on your phone.
3. In the case of SIM card inserted, SOS sign will be displayed on the bottom-right corner and without enter SOS number, press  or  keys to dial out.

Correcting an Entry

Pressing  will erase the last letter or number which you entered.

Answering a Call

Your phone will ring or/and vibrate when receiving a call. Press

 or  to answer the call. Press  to terminate the call. If you are using an earpiece, you can press the button of the earpiece to answer or terminate the call.

Recent Calls

The phone will record all the recent calls in which you received, dialed, rejected and missed. Press  to access "Call

logs" and then scroll  to browse all recent calls. The recent calls can accommodate up to 30 numbers. Moreover,

you can scroll  to select a number in this option to dial

out by pressing . There are five options for you to operate: "View", "Delete", "Save to Phonebook", "Dial" and "Edit".

Quick Dial

You may quickly search and dial a phone number stored in SIM card after inputting the number address (SIM Card memory number will depend on its total memory storage) and pressing

 to get the symbol "# " displaying on the screen. Then,

press  to dial a call. Notice that the handset memory (NVM) doesn't support such function.

Holding a Call

Press  to put the on-line call on hold while you make another call. When the second call is connected, pressing

 allows you to switch between these two calls.





Multiparty Calls

The multiparty service provides you with the ability to have a simultaneous conversation with more than one caller, if your network service provider supports this feature.

A multiparty call can only be set when you have one active call and one call on hold, both calls having been answered. Once a multiparty call is set up, calls may be added, disconnected or separated (that is, removed from the multiparty call but still connected to you) by the person who set up the multiparty call. The maximum callers in a multiparty call are six. Once started, you are in control of the multiparty call, and only you can add calls to the multiparty. More to the point, this system allows a maximum of 6-party call.

Multiparty calls feature several functions including “Swap”, “Conference”, “Transfer”, “End Single”, “Phone book”, “SMS”, “Sound Recorder”, “Mute”, and “DTMF”. Here we briefly introduce the multiparty operation steps in common use as below:

1. Make a call until it is connected first (or when you are receiving an incoming call). Next, make a second call while you are already in a call.
2. When the two dialed calls are both connected, you can move the cursor and press  to swap between the two connected calls. When “**Swap**” function is activated, one call is on line and another is on hold.
3. You can connect a call on hold to the currently active call to form a multiparty call by select “**Conference**”.
4. When you assign a call and press  to select “**End Single**”, it means that the handset will terminate the active call.
5. If you want to terminate all active call, press  to select

“End All”.

6. When the multiparty call is active, you can press  to select “**SMS**” to edit and send a short message, or to select “**Phone Book**” to view phone book list.

7. Press  and select “**Sound Recorder**” allow you to record the conversation of the active multiparty.

8. The other part in the multiparty can hear your voice when you turn on “**Mute**” function.

9. When DTMF tones are turn on during a call, it allows your handset to make use of an automated switchboard.

10. To put the multiparty call on hold and only connect one party, you can press  to select “**Split**”.



Important! :
Make sure that you do not have a call on hold before making a multi-party call.



Input Methods





Please read the description of input methods below, and that can apparently help you to skillfully use input methods.

1. This phone supports various input methods. They are Multitap ABC, Multitap abc, Numeric (123), **Smart ABC**, **Smart abc**, and symbol. Of them, **Smart ABC** and **Smart abc** are smart word choosing input methods.
2. Only in editorial mode, you can enter desired content in different input methods such as letters, numbers and symbols. This mobile phone features various input fields such as name field of Phonebook, entry search, and content of Message and so forth.

3. Press  to switch among various text input methods including Multitap ABC, Multitap abc, 123, **Smart ABC** and **Smart abc**.
4. If you want to add symbols to input area, press  and scroll  to select your desired symbols.
5. In editorial mode, press this key to clear single character, number, or symbol from the right to left.
6. Long press this key to clear all texts or phone numbers that are entered.

1. Multitap ABC/abc

ABC/abc input methods are described as below:

- (1). Press a number key ( - ) repeatedly until the desired character appears.
- (2). If the next letter is located on the same key as the present one, wait until the cursor appears, and then input the letter.
- (3). Press  to change input methods.
- (4). Press  and then scroll  to select your desired symbols.

2. Smart ABC/abc (Smart Predictive Text Mode)

Smart ABC/abc input methods are described as below:

- (1). You can merely press letter key without selecting particular one because **Smart ABC/abc** input methods enable to smartly predict the words you want.
- (2). When the predicted word completely meets your demand, then you can press  to confirm. You can choose

Smart ABC or **Smart abc** first and use this input methods.



Example : sister

Input Method: **Smart abc**

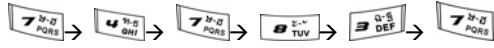
Press those keys as below :





The six input steps will bring about one word “sister” on the screen. You can press  to confirm and obtain this input consequence. If you find that your desired word doesn't appear on the screen, it means that there are probably two or more predicted word consequences. Then

you need to scroll  and release it and press  to confirm after your desired word appears on the screen.

If you want to re-highlight the whole wording, press  to recover it.

3. Symbols

(1). The most common punctuation marks are available by pressing  to launch symbol table.

(2). Next, scroll  to make the cursor reach the desired punctuation mark and press  to confirm.

(3). In editorial mode, if the symbol “€” is inputted, the sum of characters to be inputted will be changed from 612 to 268.

5. Numeric



Press the corresponding numeric key to generate a number on the screen.



Menu Function

Press  to enter and use menu functions to meet your needs.

Phone Book

This main menu allows users not only to save names / phone numbers in the SIM / handset, but also to proceed with the following submenu functions: Quick Search, Search Record, Add New Record, Copy All, Delete All, Caller Group, Extra Number, and Settings. The handset memory module has 10 fields, and SIM module 2 fields for content editing or new entry. You can



scroll  to move cursor to those fields to enter your desired content and then press to  save. If you want to access the

submenu, press . After entering the content, press  to save or press  to discard this record.



Quick Search

1. Press  to enter this submenu and you can view a phone number list.

2. Scroll  and then select one record saved in the phonebook and press  to execute the following functions:

1. View



Access this function to view a number record's detailed data saved in SIM or the handset memory. The saved data In SIM are name and number and in the handset include name, number,

home number, company name, e-mail address, office number, fax number, associate picture, associate sound and caller group.

2. Edit

All saved number records' detailed data are editable. Users can edit or revise those data and then press  to save. For details on Input Methods, please see [page. 40](#).

3. Delete

When you press  to select this option and want to delete a signal or all, the pop-up window will query if you want to delete the number record. You can press  to delete or press  to cancel.

4. Copy

You can select a single or all number records saved in SIM and press  to copy it to the handset memory and vice versa.

5. Move

You can select one number record saved in SIM and press  to move it to the handset memory and vice versa.

6. Duplicate

You can select one phone record and duplicate it to the same memory.



Search Entry

1. Search



Aside from quick search, this handset also enables users to search number records by inputting text to search phone. When the search entries are implemented, please press  to

search or select input methods. And then the handset screen will display the most similar or the same phone number. Please refer to Quick Search on [page 43](#) to execute the functions in this option.



Add New Entry

1. You need to select **SIM** or **phone** as the storage location of new number records.
2. New entries of a new number record in phone memory include name, number, home number, company name, e-mail address, office number, fax number, associate picture, associate sound and caller group. There are only two new fields to be inputted in SIM.
3. You will need to enter both the phone number and name since no data will be saved if you leave any of these two items in blank.
4. You can select and switch input methods in the fields of name, company name and E-mail address. For details on Input Methods, please see [page. 40](#).
5. You can add or select content in the fields of Home Number, Company Name, E-mail Address, Office Number, Fax Number, Associate Picture, Associate Sound and Caller Group. However, if you leave any of these above fields empty, no data can be saved.
6. Enter E-mail address into the field. Press  to search underscore "@", "_", and dot "." and input them into E-mail field.
7. When you want to add an associate picture in a new phone

number as a caller picture, you can scroll  to choose one of the default four pictures. Press  to view associate pictures.

8. You may assign an associate sound to a new phone number, and so you can identify it next time when it comes in. There are 20 default MIDI sounds accessible for your choice by

pressing  .

9. You may assign a caller group to a new phone number so you can identify it next time when it comes in. There are six default choices Friend, Family, VIP, Business, Others and None. Scroll

 to select one of them as a caller group.

10. When you edit and select all fields, press  to save and set a new phone number record.

Copy All

You may use this function to copy all phone records from SIM or handset memory. For example, when you select "From SIM", then all phone records saved in SIM will be copied to the phone.

Delete All

1. From SIM

Please input password before deleting all saved phone records from SIM.

2. From Phone

Please input password before deleting all saved phone records

from Phone. You need to input phone lock password before deleting all records from SIM or phone. Please refer to [page. 64.](#)

3. One by One

Access this option to delete saved phone records one by one.

Caller Group

In this option, users can select Friends, Family, VIP, Business and

Others as their caller groups. Scroll  and select one caller

group and press  to set. Select one caller group and set name, ringtone types, picture, color pattern and member list. When you are trying to change caller groups settings of one certain phone number, its sequence and content in phone book list won't be varied.

Extra Number

In this option, you can view, edit and erase Owner Number, Service Dial Number and SOS Number. Owner Number can be edited and erased.

Settings

1. Memory Status

This option provides inquiry about the total number of records and the empty spaces left for the phone records in the current SIM and the memory of the handset. At this stage, a maximum memory capacity is 250 sets in the handset. Note that the memory capacity of a SIM card supplied by various telecom service companies could be different.

2. Preferred Storage



In this option you can select SIM or Phone and press  as your preferred storage of phone records.

3. Fields

The option allows you to enable or disable the following field coming with Home Number, Company Name, E-mail Address, Office Number, Fax Number, Associate Picture, Associate Sound and Caller Group.



Messages

This phone allows you to enjoy sending and receiving a variety of messages. Please contact with your network and telecom service provider for more details on which services you can use. Press

 to access this menu and further press  to access the submenu's options as below.

SMS



1. Done

Press  to write a new message. When you have written the message already, you can press  (**Done**) to choose the further options including "**Send Only**", "**Save and Send**", "**Save**", "**Send to Many**", and "**Send by Group**". For details on Input Methods, please see on [page. 40](#).

2. Cancel



3. Use Template

This option provides you with a variety of templates (such as use of greetings or common expressions). You can simply scroll

 and press  to select your desired template type, and then press  to confirm.

4. Insert Object

If you would like to make your own message more interesting and

personalized, you can scroll  and then press  to insert objects (Pictures/ Predefined Animation/ Melody/ Predefined Sound) into the message. When you select the desired items, press  to confirm.

5. Format Text

Access this option to select and adjust these options below:

⊙ Text Size

Three text size options: **Small**, **Medium**, and **Large**.

⊙ Text Style

Four text style options: **Bold**, **Italics**, **Underline**, and **Strikethrough**.

⊙ Alignment

Four alignment options: **Automatic**, **Left**, **Center**, and **Right**.

⊙ New Paragraph





Four new-paragraph options: **Automatic**, **Left**, **Center**, and **Right**.

6. Input Methods

The input methods supplied by this handset include **Multitap ABC**, **Multitap abc**, **Smart ABC**, **Smart abc**, **Numeric** and **Insert Symbols**. For details on Input Methods, please see on [page. 40](#).



Inbox

When you access the inbox, you will see a list of all received messages (saved in the memory of both the phone and the SIM card) displayed on the screen, including the senders, sent time and the message content. All unread messages will be indicated with the  icon. Press  to select and display the content of a message on the screen. For multiple-page messages, you can scroll  to read the entire message. Press  to select more message options, including **Reply**, **Delete**, **Edit**, **Forward**, and **Use Number**.

Outbox

This option functions the same as inbox. After editing a message, you can select **send & save** to send and save it to SIM or the handset at your will. Or you can merely save this message by selecting **save**.

Delete

In this option, you can select delete messages as below:

- Delete Inbox
- Delete Outbox
- Delete All

Similar to the delete function above, press  and you will be prompted to confirm whether to delete the selected message from inbox or outbox.

Template

In this option you can select a template for use in delivering short messages. Or you can select one template to edit its content by your favorite input methods as your needs. For details on Input Methods, please see [page. 40](#).



Message Settings

⊙ Profile Settings

This option functions as service center (SMSC) that allows you to select SMSC 1 and SMSC 2. Next, you can enter either of the two profiles to edit and write the following items:

(1) Profile Name:

You can edit the profile name of the two SMSC and press



to confirm.

(2) SC (Service Center) Address:

You can change the SC address to a new one and press



to confirm.

(3) Valid Period:



You can scroll to select valid period ranging from 1hour, 12 hours, 1 day, 1 week and maximum/

(4) Message Type:

You can select your desired message types including Text, Fax, Page, and E-mail.

⊙ Common Settings

In this option you can enable/disable "Delivery Report" and "Reply Path". When you enable "Reply Path" function, your SMS receivers can know the SMS delivering service center as well as a tracking path and are able to reply your sent messages.

⊙ Memory Status

This option allows you to check the total percentage of used message storage currently on both the phone and the SIM card. Message will be saved into the phone by default, and will be saved into the SIM card once the phone is full.

⊙ Preferred Storage

You can assign SIM or phone (NVM) as your preferred message storage.

⊙ Pref. Bearer

Select **Prefer GPRS**, **Prefer GSM**, **GPRS only** or **GSM only** as your preferred bearer.



MMS (Multimedia Messages)

A multimedia message can contain text, sound and a picture or a video clip. The phone supports multimedia messages that are up to 100 KB in size. If the maximum size is exceeded, the phone may not be able to receive the message.

Depending on the network, you may receive a text message that includes an Internet address where you can view the multimedia message.

1. Write Message

You can select Add Number or Add E-mail in **TO** (Receiver), **CC** (Carbon Copy), and **BCC** (blind carbon copy) columns as your preferable MMS sending approaches. Write SB (Subject) and Content of a MMS at will. Press **Done** to confirm the content you input in each column. Next, manage this MMS by **Send Only**, **Save and Send**, **Save to Drafts**, or **Send Options**, or press **Exit** to leave the option. In Send Options, you need to set those items as below:

A. Validity Time

Set Max, 1 Hour, 12 Hours, 1 Day, or 1 Week as your preferable MMS validity time.

B. Delivery Report

Set this function as On/Off status.

C. Read Report

Set this function as On/Off status.

D. Priority

Set MMS priority as Normal, High, or Low.

2. Inbox

Select one MMS in this folder to **View**, **Properties**, **Reply**, **Reply to All**, **Forward**, **Delete**, **Delete All**, and **Use Number**.

3. Outbox

Select one MMS in this folder to **View**, **Properties**, **Send to Others**, **Delete**, **Delete All**, and **Use Number**.

4. Drafts

Select one MMS in this folder to **View**, **Properties**, **Send**, **Edit Message**, **Delete**, **Delete All**, and **Use Number**.

5. Templates

You can use one of the five available templates. Besides, you can select one template to **View**, **Properties**, or **Write Message**.

6. Message Settings

⊙ Sending

Enter this option to set the following features:

▶Validity Period

Set the features as Max, 1 Hour, 12 Hours, 1 Day, or 1 Week

▶Delivery Report

Set this feature as On/Off status.

▶Priority

Set this feature as On/Off status.

▶Slide Timing

Set slide timing (ranging from 1-60 seconds)

▶Delivery Time

Set this feature as Immediate, In one hour, In 12 hours, or In 24 hours

⊙ Retrieval

▶Home Network

Set this feature as Immediate, Delayed, Restricted

▶Roaming

Set this feature as As Home, Delayed, Restricted

▶Read report

Set this feature as On Request, Send, or Never Send.

▶Delivery Report

Set this feature as On / Off status.

⊙ Filters

▶Anonymous

You can set this feature as Allow or Reject status.

▶Max Size

The max size is 20 KB.

▶Advertisement

You can set this feature as Allow or Reject status.

⊙ Edit Profile



When you access to this option, you need scroll  to select you MMS service-supported operator and press **Ok** to **Activate** and **Edit** MMS Profile

▶Rename Profile

You can press **Edit** to access to editing mode to rename the MMS profile. When editing is finished, press **Option** to select **Done**, **Cancel** or **Input Method**.

▶Home Page

You can press **Edit** to access to editing mode to rename the Homepage. When editing is finished, press **Option** to select **Done**, **Cancel** or **Input Method**.

▶Data Account



Press **Select** and then scroll  and press **Ok** to confirm

MMS data account.

►Connection Type

Set connection type as **Connection-oriented**, **Connectionless**, or **HTTP**.

►Username

You can press **Edit** to access to editing mode to input Username. When editing is finished, press **Option** to select **Done**, **Cancel** or **Input Method**.

►Password

You can press **Edit** to access to editing mode to input Password. When editing is finished, press **Option** to select **Done**, **Cancel** or **Input Method**.

⊙ Memory Status

Enter this option to extract detailed memory info including Usage, Total, and Free memory.



Email

Like email fun usually made by PC or laptop, you can use this handset to write, send and receive emails via a email account you assigned. Therefore, you need to access to email profile to settings first before sending or receiving emails.

1. Send and Receive

Select this option and press **OK**, then the message "POP server is connecting" is indicating on the screen. Number of Sent and received mails will eventually display on the handset, followed by email service authorizing is done. If you don't connect POP server, press **Abort**.

2. Write Email

You can edit **TO** (Receiver) and/or **CC** (Carbon Copy) as your email receivers. Press **Ok** to confirm **Add** so as to access to Input Address window.

* Note: Be sure of email address you input is complete, otherwise

a prompt pop-up window "Invalid Email Address" will show on the screen.

Then, press **Option** to select **Done**, **Cancel**, **Search**, and **Input Method**. To get email addresses saved in Phonebook List in the phone, press **Search**. Press **Edit** to write **SB** (Subject) and **Content** for the email you will send out. When you have edited them, press **Option** to select **Done**, **Cancel**, and **Input Method**. Press Attachment to add files which you can **Edit**, **View/Play** and **Delete** from File Manager. **Priority** of delivering this email can be set as Normal, Low or High. When all items and content is edit and done, press **Done** to select those items as below.

Send

Press this option to simply send out an email.

Send and Save

Press this option to send out an email and save it in **Sent**.

Save to Drafts

Press this option to simply save an email in **Drafts**.

Quit without Saving

Press this option to by Write Email without saving an email you have written in the handset.

3. Inbox

Select one email in Inbox and press **Read** to view its information. Moreover, you can select following options:

Reply

Press this option to response the selected email to the sender with writing content.

Reply without Content

Press this option to response the selected email to the sender without writing content.

Reply All

Press this option to response the selected email to all receivers with writing content.

⊙ Reply All without Content

Press this option to response the selected email to all receivers without writing content.

⊙ Forward

Press this option to send the selected email to another receivers.

⊙ Delete

Press this option to delete the selected email.

4. Unsent

Emails in this folder mean their addresses are not organized completely so that they couldn't be successfully sent. Select one email and select **Send**, **Send and Save**, **Edit**, **Move to Drafts**, and **Delete**.

5. Sent

You can select one email in this folder to forward or delete it. To forward an email in **Sent**, please refer to Write Email on [P. 61](#).

6. Drafts

You can select one email in this folder to edit delete it. To edit an email in **Sent**, please refer to Write Email on [P. 61](#).

7. Delete All Folder

Enter this option to delete Inbox, Unsent, Sent, Drafts, or delete all folders in Email.

8. Email Profile

In this option you can create and personalize your emails profile at will as email management center in the handset. Before you **Activate** the Email Profile, you need first to set **Common Setting**, **Outgoing Server** and **Incoming Server**.

⊙ Common Setting

> Profile Name

Press **Edit** to create or rename the profile name. Please refer to

> Data Account

First, select **GSM Data** or **GPRS** as your data account. Then, press



Ok to scroll to select one operator GPRS system and press **Ok** to confirm your GPRS account setting.

> Signature



Scroll to select **On / Off** and press **Done** to set signature status. When the status is Off, users can't set Signature Image and Signature Text.

> Signature Image

The option allows you to **Select From File** from File Manager, **View** the image, or **Delete Reference**.

> Signature Text

Press **Edit** to access to text editing window, edit your desired signature text and then select **Done**, **Cancel**, or **Input Method** by pressing **Ok**.

⊙ Outgoing Server

Enter Outgoing Server to fill in **Outgoing Server name**, **Outgoing Port** (Default value: 25), **Display Name**, **E-Mail Address**, **SMTP Auth**, **Username**, and **Password**.

⊙ Incoming Server

Enter Incoming Server to fill in Protocol (set as **POP2** or **IMAP4**), **Incoming Server name**, **Incoming Port** (Default value: 110), **Username**, **Password**, Check Interval (set as Off, 5 min, 30 min, 1 hour, or 2 hours), and **Download Size** (max. up to 102400).



Voice Mail Server

There are a default voice mail servers for you to edit, erase, and connect to voice.



Broadcast Message

The network operator sends broadcast messages to all users in a certain area. Please contact your network operator for more details on whether they provide this service.

⊙ Receive Mode

You can set this option as the following modes:

* Off

If you select this menu, your phone will not receive broadcast messages any more.

* List Only

If you select this menu, your phone will receive broadcast messages sent only by those channels listed on the screen.

* All Channels

If you select this menu, your phone will receive broadcast messages sent by all channels.

⊙ Read Message

Enter this option to read broadcast message. If there is no message left, the pop-up window will display "Empty".

⊙ Languages



Enter this option to turn on / off all languages. Or you can select specific languages existing in the SIM card you are using. Please notice that various SIM cards provide various language options.

⊙ Channel Settings

Channels are selectable and can be set for users to receive their broadcast messages. The resources of those broadcast messages are provided by the telecom service companies themselves or come from their cooperated companies such as TV, radio stations, etc.

(1). Select:

You can set all channels or select a certain channel from channel list as the channel to receive your broadcasting messages.



- (2). Add:
You can add a new channel. Channel title and ID (3 digits) should be created.
- (3). Edit:
You can select one channel you set to edit its title and ID and press  to save.
- (4). Delete
You can select one channel you set and press  to delete it.

Call History

This menu records the charge info and the length of time or duration of all incoming and outgoing calls in hours, minutes, and seconds. Please contact with your telecom service provider for more charge information.

Missed Calls



In this menu, the screen will display all the missed calls. You can

scroll  to select missed calls and press  to execute the following optional functions comprising "view", "Delete", "Save to Phone book", "dial", and "edit".





1. View

in this option you can view the miss call info coming with date, time, phone number, and miss called times.

2. Delete

You can press yes key  to delete this missed call or press  to abort deletion.

3. Save to Phone book

Press  to save this missed call to SIM or phone. You can press  to edit the info and press  again, or press  to save it.

4. Dial

Move cursor to this option and press  to dial.

5. Edit

In this option you can edit the info and save it.



Dialed Calls

List all of dial-out calls. The function is the same with above.



Received Calls

List all of answered calls. The functions are the same with above.



Delete Call Log

In this option, you can select and delete call log as below: Missed Calls, Dialed Calls, Received Calls, and Delete All



Call Time

This menu records the charge info and the length of time or duration of all incoming and outgoing calls in hours, minutes, and seconds.

1. Last Call Time

This submenu displays the duration of the last call.

2. Total Sent

This submenu displays the total duration of all dialing calls.

3. Total Received

This submenu displays the total duration of all received calls.

4. Reset All Time

Access this option to reset all call time.



Call Cost

1. Last Call Cost

In this option you can view the last call cost info.

2. Total Cost

This submenu displays the total charge of all calls.

3. Reset Cost

You need to input correct PIN2 password number before reset cost.

4. Max Cost

This allows you to set a maximum limit to your total cost. You can't dial any number if you go over your limit until the total charge has been reset. As similar to total charge, you need to enter PIN2 for settings.

5. Price Per Unit

This allows you to enter the unit price. After entering your PIN 2

code you can input price and unit. Pressing  allows you to select different entry fields.



SMS Center

1. Sent

2. Received

 **GPRS Center**

1. Last Sent

2. Last Received

3. All Sent

4. All Received

5. Reset Center

 **Settings**

 **Phone Setup**

1. Time and Date

Set Home City

Select one city listed in the screen and press  to confirm.

⊙ Set Time/Date

Access this option and input time and date.

⊙ Set Format

You can set time and date format

Time Format:

12 Hours

24 Hours

Date Format:

DD / MM / YYYY

MM / DD / YYYY

YYYY / MM / DD

YYYY - MM - DD

MMM DD, YYYY

DD – MMM – YYYY

Important! :

A text window will pop up to remind users to input new time and date when the handset is powered off for a long time. This pop-up reminder can show up only when the SIM is inserted.

2. Schedule Power On/Off

There are four default schedules available to be setup power on or power off status. Select one schedule and execute the functions below

⊙ Status

You can enable or disable the schedule.

⊙ Power Settings



You can scroll  to set up power-on or power-off schedule.

⊙ Time Settings

You need to input time and press  to confirm the time settings.

Important! :
When the duration you remove the battery from the phone is over 20 seconds, the time won't be punctual.

3. Language

Access this option to select your preferred language used in the handset.

4. Preferred Input Methods

Select your preferred input methods from the list, including ABC, abc, Numeric, Smart ABC and Smart abc.

5. Display Characteristic

Select and set up the display characteristic as below description:

Wallpaper



Scroll to select your desired wallpaper from **Image 1-5, analog clock** and **digital clock**.

Screen Saver

* Settings

■ Status



Scroll to set up screen saver in **On** or **Off** status.

■ Waiting

Set up waiting time of 5 Sec., 15 Sec. or 30 Sec.

* Select

Select **Image 1-5, Analog Clock** or **Digital Clock** as your screen saver.

Show Date and Time

Press  to turn On/Off of the function

⊙ Show Owner Number

Press  to turn On/Off of the function

⊙ Show Operator Name

Press  to turn On/Off of the function

6. Contrast

Scroll  and press  to adjust the shading value of screen.



7. Greeting Text

In this option, you can setup the greeting text status and edit the content of the greeting text.

⊙ Status

Scroll  to set up greeting text in **On** or **Off** status.

⊙ Greeting Text

Press  to edit greeting text and press  again to select input methods or save it. For details on Input Methods, please see [page. 40](#).

8. Speed Dial

⊙ Enable Speed Dial

You need to setup **On** or **Off** to enable/disable speed dial function.

⊙ Set Number



There are eight default speed dial number settings in this option. You can assign number keys 2-9 and input phone numbers in them. When you have assigned and set up the numbers for speed

dial, you can long press one of the assigned number keys and speedily dial out the number you set in standby mode.

9. Shortcuts

You can select your favorite items as your shortcuts.

10. Dedicated Key

In this option you can scroll  Up, Down, Left and Right, and press  to select a total of 29 functions. For example, if you set audio profile as the up key shortcut, you can press the up key to promptly enter audio profile in standby mode.

11. Auto Update of Date and Time

You can press  to turn **On/Off** to enable/disable this function.

Call Setup

1. Caller ID

Caller ID represents your own phone number. You can set "hide ID" so that your number won't be seen. Oppositely, "Send ID" means your number will appear when you are making a call.

Set by Network

When you press  to select this option, you can set your phone number depending on two line service of line 1 and line 2.

Hide ID

You can press  to hide your phone ID when you dial.

Send ID

You can press  to send your phone ID when you dial.

2. Call Waiting



In this option you can scroll and select and set call waiting function from the following options below:

Activate

When activating call-waiting function, you will be alerted by audio and video signals right after another call is coming in during making a call.

Deactivate

If you deactivate this function, the phone won't alert you of another incoming call but directly divert that call to other number or your voice mailbox.

Query Status

It reports current status for Activate or Cancel.

3. Call Divert

Divert All Voice Calls

Diverts voice calls unconditionally. You can activate or deactivate this function. Or you can view the current status for this function.

Divert If Unreachable

Diverts voice calls when the phone is switched off or out of converge. You can activate or deactivate this function. Or you can view the current status for this function.

Divert If No Answer

Diverts voice calls that you do not answer. You can activate or deactivate this function. Or you can view the current status for this function.

Divert If Busy

Diverts voice calls when the phone is in use. You can activate or deactivate this function. Or you can view the current status for this function.

⊙ Cancel All Divert

You can access this option to cancel all call divert service.

4. Call Barring

⊙ Outgoing Calls

You can activate or deactivate this function to bar all out calls (except emergency call) with this function. Or you can view the current status for this function.

⊙ Incoming Calls

You can activate or deactivate this function to bar all ingoing calls with this function. Or you can view the current status for this function.

⊙ Cancel All

You can cancel all barred calls in this option.

⊙ Change Barring PW

When you want to change barring password, remember to press old password at first and then press a new password. And don't forget new password you have set up.

5. Line Switching

L1 and L2 mean there are two available phone numbers that both support dialing and receiving functions. Some telecom service companies provide SIM card with dual phone numbers. That is, if your SIM card has such function, you can enter this option to set your phone records into two groups (ex. Office and family) separately located in the two numbers of the same SIM card. And you can switch line1 or line 2 as your phone dialing line and answering line.

6. Call Time Reminder

In this option, you can select off, single or periodic as call time reminder.

7. Call Time Display

In this option you can turn On/Off to enable/disable call time

display.

8. Auto Redial

Turn On/Off to enable/disable auto redial.



Network Setup

1. Network Selection

You can set network selection by automatic or manual function in this option.

2. Preferred Networks

Network List

Add from List

You can add a preferred networking service provide from the list.

Create New

When you try to create a new network, you need to input **MCC/MNC** number and select **priority** level shown as below

* MCC/MNC:

Input the MCC/MNC number

* Priority:



Scroll to select priority 1 or priority 2.

Change Priority

When you have more than one network services, you can select one and change its priority.

Delete

In this option you can press  to select one network service.

3. Band Selection

Choose one of the band types below as your phone band.

- ⊙ 900
- ⊙ 1900
- ⊙ Dual Band

4. GPRS Selection

- ⊙ When needed
GPRS will be activated when need.
- ⊙ Always
GPRS will be activated always.

Security Setup

1. SIM Lock

You can access this option and input security password to lock SIM. This feature is designed to prevent somebody else from using your lost or stolen SIM card(s). When the SIM is locked, you

have to input SIM password and press  after pressing



to switch on the handset.

2. Phone Lock

If you want to activate phone lock function, please input phone

lock password and then press . Follow the step above to deactivate phone lock function.

3. Auto Keypad Lock

Access this option to select auto-keypad-lock modes include "None", "5 sec.", "30 sec.", "1 min." and "5 min.".

4. Fixed Dial

You can restrict your outgoing calls to selected phone numbers. The numbers are protected by your PIN2 code.

⊙ Mode

You need to input the correct **PIN2** to set **On** or **Off** for this function. When the Mode is On, only selected fixed phone numbers can be dialed.

⊙ Fixed Dial List

The default of the list is empty. You can add a new fixed dial phone numbers by writing the name and phone number and then inputting **PIN2**. You can edit and delete the records in the list. (It also needs the PIN2 number).

5. Barred Dial

Your SIM needs to support this function.

⊙ Mode

You need to input the correct PIN2 so as to enable this function.

⊙ Barred Dial List

There is a barred dial list where your can select one barred-dial number and dial it out. (It needs the PIN2 number).

6. Change Password

PIN is an abbreviation of Personal Identification Number used to prevent use by only unauthorized person. You can change the following passwords when necessary.

⊙ PIN

Make sure that you have PIN enabled. You need to input original PIN password first. Next, input new PIN code to verify them, and input new password again to ensure PIN is changed successfully.

⊙ PIN2

You need to input original PIN2 password first. Next, input new PIN2 code to verify them, and input new password again to ensure PIN2 is changed successfully.

⊙ Phone Lock Password

Please input old password and then change it to a new one.



Restore Factory Settings

In this option, you may decide whether you want to convert the settings of your handset to the reset settings. Notice that the original the original password for this option is "1122"



Multimedia



Press  to access this menu and use six multimedia functions coming with **Camera, Image Viewer, Audio Player, File Manager, Sound Recorder, and Melody Compose.**



Camera

To access Camera mode, press **OK**. Press **Option** to select **To Image Viewer, Camera Setting, Advanced Setting and Restore Default**. If you want to take a picture, press **Capture**. Capture then the screen will display the captured image. Next, press **Option** to select **Send, Apply, Detail, Rename, and Delete**. In Send option, scroll Send As Wallpaper, As Screen Saver, and

1. Send

You can send the captured picture as Wallpaper, Screen Saver, or Phonebook Thumbnail.

2. Apply

You can apply the captured picture via MMS, E-Mail or EMS.

3. Detail

Select this option to extract all info of the picture.

4. Rename

Press Edit to access to editing window to rename the photo name.

5. Delete

Enter this option to delete the picture you captured. Forward, Detail, Rename and Delete. You Camera Setting and Advanced Setting. Press  once more to enter submenus as below for more applications.



To Image Viewer

1. Send

You can send the captured picture as Wallpaper, Screen Saver, or Phonebook Thumbnail.

2. Apply

You can apply the captured picture via MMS, E-Mail or EMS.

3. Delete

Enter this option to delete the picture you captured.

4. Delete

Enter this option to delete all the pictures you saved.

5. Rename

Press Edit to access to editing window to rename the photo name.

6. View Detail

Select this option to extract all info of the picture.

You Camera Setting and Advanced Setting. Press  once more to enter submenus as below for more applications.

Apply

As Wallpaper

As Screen Saver

As Phonebook Thumbnail

Delete

Delete All







Rename
View Details
Sort
By Name
By Type
By Time
By Size
Camera Setting
Image Size 128 X 128 320 X 240 640 X 480
Photo Effect No Effect Grayscale Sepia Color invert Gray Invert
Blackboard Whiteboard
Add Frame Off Frame 1-10
Cont. Shot 1 shot 3 shots 5 shots
Night Mode Off On
Delay Timer Off 5 seconds 10 seconds
Advanced Setting
White balance Auto Daylight Tungsten Fluorescent Cloud
Incandescence
Image Quality Low Normal High
Exposure
+4 +3 +2 +1 0 -1 -2 -3 -4
Shutter Sound
Set as Off Sound 1 Sound 2 Sound 3
Banding
Auto, 50 Hz and 60Hz
Restore Default
Press Ok to set Camera to Restore default

 **Audio Player**

How to play a selected melody in audio player:

To access this menu, press  , and an audio player screen is launched. This screen shows the audio file name and played time.

Scroll  to select one melody to play. To **play** the melody

you chose, press  . To **pause** the melody, press  again. To **end** this melody, press  . To exit, press  . Scroll  to select one melody and press  to access **List** to use **Option** for more functions as below: Play, Detail, Add To Rings, Refresh List, and Settings.

1. Play

Please refer to **How to play a selected melody in audio player** on [page 71](#).

2. Detail

Melody memory **size** (ex. 720B) is shown in this option.

3. Add To Rings

Press  to add one selected melody as a new ring.

4. Refresh List

Press  to refresh one selected melody.

5. Settings

List Auto Gen

Scroll  to set this effect in **On/Off** status.

Repeat

Scroll  to set this effect in **Off / One / All** status.

Shuffle

Scroll  to set this effect in **On/Off** status.

⊙ **Background Play**



Scroll  to set this effect in **On/Off** status.

Sound Recorder





To access this menu, press , and recorded sound files saved in the handset are launched on the screen. The file info, including file size, file format, and recorded date is displayed on

the screen. Scroll  to move the cursor to one sound file you select and press  to access the further menu developed as below for more applications.

1. Record



To start sound **Record**, press . To **Pause / Continue**, press  once more. To **Stop**, press . When **Record** ends, press  again to select **Save**, **Cancel**, or **Input Method**. For use of Input Method, please see on page. [43](#)

2. Play





To start sound **Play**, press . To **Pause / Continue**, press  once more. To **Stop**, press . When **Play** ends, press  again.

3. Append

You can select this option to record a sound and add it to a saved

sound file. First select a saved sound file and press  to **Append** a new sound file. To **Pause / Continue**, press  once more. To **Stop**, press . The sound file you appended will play it original sound first and then the appended sound.

4. Rename

Press  to launch an editing-mode screen for **Rename**. To clear a character/letter/symbol, press . To erase the whole file name, press and hold  for around two seconds. When you finish **Rename**, press  to select **Done**, **Cancel** or **Input Method**. For use of Input Method, please see on page. [43](#)

5. Delete

To delete one appointed file, press .

6. Delete All

To delete all files, press .

7. Settings

Use  to set **AMR** or **WAV** as file format.

8. Forward



In this option, you can select “**To User Profile**”, “**To MMS**”, “**To E-mail**”, and “**To EMS**”.

Melody Compose

To access this menu, press . You can create a melody and

then press  once more to select "Play", "Play Speed", "Select Instrument", and "Save".

File Manager

To access this menu, press . Scroll  and select one file and then press  for more functions as below: **Open, Create Folder, Rename, Delete, and Sort.**

Fun & Games





Game

1. Riches

Resume

During the game, press  to pause and resume the game with one more press of this key.

Start Game



Press  to start this game. Use numeric keys  and  to move the box left and right. You should control your box carefully to catch correct objects (apples, cash bags, odd-shaped nuggets); otherwise you will lose scores or power. During the game you can press  to pause and resume the game with one more press of this key. Game over tone will sound and game scores will show on the screen right after this game ends.

Game Level

Scroll  and select one of the three game levels (Easy,

Normal and Hard) and then press  to confirm game level setting.

⊙ Best Grades





Press  to view the best score shown on the screen. If you need to reset best score, press . To exit, press .

⊙ Game Help



Please refer to detail info in this handset.

2. Color Balls



⊙ Start Game

Press  to start this game. Press  and  to move the launcher to shoot the falling color balls with the same color. To fire bullets, press . To change bullet color, press .

⊙ Game Level

Scroll  and select one of the three game levels (Easy, Normal and Hard) and then press  to confirm game level setting.

⊙ Best Grades



Press  to view the best score shown on the screen. If you need to reset the best score, press . To exit, press .

⊙ Game Help



Please refer to detail info in this handset.

Game Setting

1. Game Audio



 to set the game audio in On/Off status and press

 to confirm game audio setting.

2. Game Vibration



 to set the game vibration in On/Off status and
 press  to confirm game vibration setting.

User Profiles

There are five profiles (General, Meeting, Outdoor, Indoor and Headset) to meet your different needs. Select a desired profile and push "Activate" to enable profile function. If you want to personalize the profile, launch "**Customize**" menu and select the item you want to personalize.



General

You can change the settings of the follow profiles with this function.

1. Activate

Activate the settings of the profile you want.

2. Customize

⊙ Tone Setup

(1). The handset provides 10 types of rings and 20 sets of MIDI sounds and 5 replaceable empty files that you can add from file manager. You can select and set one tone type as your handset **Incoming Call** and **Alarm**.

(2). You can select silent mode or choose tone 1-10 to set **Power On**, **Power Off** and **Message Tone**.

(3). In Keypad Tone option, there are three modes for your setup selections: **Silent**, **Click**, and **Tone**.

⊙ Volume

Select **Ring Tone** or **Key Tone**, and then press  or up-down sidekey to adjust volume.

⊙ Alert Type

Select on of the four alert types below and press  to set.



- Ring
- Vibration Only
- Vibra and Ring
- Vibra Then Ring

⊙ Ring Type

Select on of the three ring types below and press  to set.

- Single
- Repeat
- Ascending

⊙ Extra Tone

You can press  to set On/Off of the four extra tones below. These tones can be set **On** to timely remind users of real condition of mobile phones. Pressing  **done** will save your resetting. There are four extra tones in the phone.

- Warning

Warning tone will sound when remind users of improper action such as pressing  to save a new phone record without

writing the name and inputting phone number in the blank fields.

- Error

Error tone will sound when an error step was taken, and a pop-on message with a punctuation mark “ ! “ is displayed on the screen.

- Camp on

This tone will sound when the handset is successfully connected to the telecom service company and reach the signal.

- Connect

This tone will sound when an incoming call comes.

- ⊙ Answer Mode

In this option, you can enable or disable **Any Key** function. When any key function is enabled, you can press any key to answer an incoming call. Pressing  **done** will save your resetting.

- ⊙ LCD Backlight

- 5 Sec

- 15 Sec

- 30 Sec

- 45 Sec



Meeting

The default tone of this profile is silence. All further settings and selections in the option are the same as General. Please refer to General.



Outdoor

All further settings and selections in the option are the same as General. Please refer to General.



Indoor

All further settings and selections in the option are the same as General. Please refer to General.



Headset

Plugging in earpiece can automatically activate “customize” menu functions.





PIM

A variety of functions are available as your personal convenient tools



Calendar

You may scroll  until the cursor moves to the desired date and press  to select View Task or Jump to Date. View Task allows you not only to survey task list, but also to edit or add your task as a memorandum (or a to-do list) with setting Date, Time, Note and Alarm. Jump to Date enables you to input the date you want to check. For more details to edit View Task, please refer to “To Do List” on [page 76](#).



To Do List



Scroll  to view all to do list. Select one memorandum in to do list and then choose “View”, “Add”, Edit Task”, “Delete Task” or “Delete All” as you need. You should set up task date, time, note and alarm while editing or adding a new memorandum. When you are editing note, you can select “Save”, “Use Template”, “Input Method”. Notice that the memorandum can't be saved if you leave the note blank. For details in use of templates, please see on

[page. 53.](#)



Alarm

There are three sets of alarm for your time settings. Select one

alarm and press  and then scroll  to execute start time settings as below:

1. On/Off

Scroll  to turn on/off alarm clock function.

2. Time Settings

Input the alarm time from hour (left) to minute (right).

3. Repeat

Press  to select repeats of alarm function as below.

Then you press **done** key  to set alarm repeat mode.

Press  to terminate the function.

Once

When you select once, the handset alarm will work only once.

Everyday

When you select Everyday, the handset alarm will work everyday.

Days

When you select Days, press  to set day alarm on/ off from Sunday to Saturday.



Calculator

With limited accuracy and designed for simple calculations, the calculator in your phone adds (+), subtracts (-), multiplies (x), and

divides (\div) the values you input as the four fundamental operations for arithmetic. This option provides memory calculation M+, M-, MR (Memory Recall) & MC (Memory Clear).

Main functions of calculators are explained in the following three steps:

1. Input the arithmetic numbers (0-9) and press four-way

navigation key  to select +, -, x, or \div to get the answer.

2. If your calculating values are not integers, you can input value

and press  to get a decimal dot point, and then input other values behind the decimal point and repeat step 1.

3. To erase a number you inputted, press **Clear**.

4. To start a new calculation, first press and hold **Clear**.



World clock

In this option, you may scroll  to browse the current time in different countries/cities all over the world.

Services

This menu can be displayed if your SIM card supports Value-added Services. Regarding the details referring to how to use SIM services, as well as price and other information, please contact your telecom service company.

Important:

Your telecom service provider offers the STK service. Your telecom service provider defines the name of menu, title, and content. Due to the content size may be too big to fit into the screen of your mobile phone; some of text may not be displayed.

Battery

- Ⓢ The battery is rechargeable up to hundreds of times, but its capacity will reduce. You may need to replace a new battery when the operation duration (calling and standing duration) reduces evidently.
- Ⓢ Remove charger from the source each time after charging. Over charging will shorten the life of the battery. Avoid charging a battery for over 24 consecutive hours.
- Ⓢ Use only batteries certified by the mobile phone manufacturer.
- Ⓢ Extreme temperatures will affect charging performance. The desirable ambient temperature for charging is 0°C-45°C (32°F-113°F).
- Ⓢ Do not use damaged or old batteries.
- Ⓢ Avoid contacts of the positive and negative poles of the battery with metals, such as coins, scissors, and pens. It will damage or cause short circuit to the battery. Place spare batteries in a safe place or wrap them up with insulated materials before putting inside your pocket or handbags.
- Ⓢ Extreme temperatures will reduce the capacity or shorten the life of batteries. Avoid placing batteries in extreme temperatures, such as inside vehicles or near air-conditioner outlets. The desirable battery storage temperature is 15°C-25°C (59°F-77°F). Batteries that have been charged may not work properly in extreme temperatures.
- Ⓢ Keep batteries away from water or fire.
- Ⓢ Dispose batteries according to local environmental regulations.

Care and Maintenance

Follow the instructions below to take care of your mobile phone. They will help you to enjoy life with this product.

- ⦿ Keep the mobile phone and its accessories out of children's reach.
- ⦿ Keep the mobile phone dry; away from rain, moisture and liquid contain minerals that will corrode the circuit of the mobile phone.
- ⦿ Keep the mobile phone away from dirt or dust.
- ⦿ Keep the mobile phone away from heat. Heat will shorten the lifespan of electronics, damage the batteries, or even deform or corrode the shell of the mobile phone.
- ⦿ Keep the mobile phone away from coldness. Condensation takes place and the moisture will damage the circuit board when the mobile phone resumes normal temperature.
- ⦿ Do not open the mobile phone. Non-professional treatment may cause damage to the mobile phone.
- ⦿ Avoid falling, impact or vibration of the mobile phone. Improper external force may damage the circuit of the mobile phone.
- ⦿ Do not clean the mobile phone with chemical solutions or detergents. Gently wipe the shell of the mobile phone with a soft cotton cloth and clear water or mild soap.
- ⦿ Use accessories and batteries from the manufacturer.
- ⦿ Contact your nearest service station if the mobile phone is out of order. Our well-trained technicians will provide you the best service.

FCC Regulations

Conditions of Use

Operation of this XGT mobile phone is subject to the following two conditions; (1) this device may not cause harmful interference, and (2) this device must accept any interference received, including interference that may cause undesired operation.

This XGT mobile phone generates, uses and can radiate radio frequency energy and, if not installed and used in accordance with the instructions, may cause harmful interference to radio communications. If this device does cause harmful interference to radio or television reception, which can be determined by turning the device on and off, the user is encouraged to try to correct the interference by one or more of the following measures:

- 1). Reorient or relocate the receiving antenna.
- 2). Increase the distance between the device and receiver.
- 3). Connect the device into an outlet on a circuit different from that to which the receiver is connected.
- 4). Consult the dealer or an experienced radio/TV technician for help.

The radiated output power of this internal wireless radio is far below the FCC radio frequency exposure limits. Nevertheless, the wireless radio shall be used in such a manner that the radio is 1.5 cm or further from the human body. However, the user of wireless radios may be restricted in some places or situations, such as aboard airplanes. If you are unsure of restrictions, you are encouraged to ask for authorization before turning on the wireless radio. Several restrictions and cautions of using mobile phone are listed in the **Safety**.

FCC RF Exposure Information

Read this information before using your handset

In August 1996 the Federal Communication Commission (FCC) of the United States with its action in Report and Order FCC 96-326 adopted an updated safety standard for human exposure to radio frequency (RF) electromagnetic energy emitted by FCC regulated transmitters. Those guidelines are consistent with the safety standard previously set by both U.S and international standards bodies. The design of this phone complies with the FCC guidelines and these international standards.

Use only the supplied or an approved antenna. Unauthorized antennas, modifications, or attachments could impair call quality, damage the phone, or result in violation of FCC regulations.

Do not use the phone with a damaged antenna. If a damaged antenna comes into contact with the skin, a minor burn may result. Please contact your local dealer for replacement antenna.

Body-worn Operation

This device was tested for typical body-worn operations. To comply with FCC RF exposure requirements, a minimum separation distance of 1.5 cm must be maintained between the user's body and the handset, including the antenna. Third-party belt-clips, holsters, and similar accessories used by this device should not contain any metallic components. Body-worn accessories that do not meet these requirements may not comply with FCC RF exposure requirements and should be avoided.

For more information about RF exposure, please visit the FCC website at www.fcc.gov

P/N : HDZL200100