

Lanner

Network Appliance Platforms

Hardware platforms for next generation networking infrastructure

FW-7551SE User Manual

Version: 1.1

Date of Release: 2018-12-04

Icon Descriptions

The icons are used in the manual to serve as an indication of interest topics or important messages. Below is a description of these icons:



Note: This mark indicates that there is a note of interest and is something that you should pay special attention to while using the product.



Warning: This mark indicates that there is a caution or warning and it is something that could damage your property or product.

Online Resources

The listed websites are links to the online product information and technical support.

Resources	URL
Lanner	http://www.lannerinc.com
Product Resource	http://www.lannerinc.com/download-center
RMA	http://eRMA.lannerinc.com

Copyright and Trademarks

This document is copyrighted © 2018. All rights are reserved. The original manufacturer reserves the right to make improvements to the products described in this manual at any time without notice.

No part of this manual may be reproduced, copied, translated or transmitted in any form or by any means without the prior written permission of the original manufacturer. Information provided in this manual is intended to be accurate and reliable. However, the original manufacturer assumes no responsibility for its use, nor for any infringements upon the rights of third parties that may result from such use.

Acknowledgment

Intel® and Intel® Atom™ are registered are trademarks or registered trademarks of Intel Corporation or its subsidiaries in the U.S. and/or other countries.

Intel® is a trademark of Intel Corporation or its subsidiaries in the U.S. and/or other countries.

Microsoft Windows and MS-DOS are registered trademarks of Microsoft Corp.

All other product names or trademarks are properties of their respective owners.

Compliances and Certification

Federal Communication Commission Interference Statement

This device complies with Part 15 of the FCC Rules. Operation is subject to the following two conditions:

(1) This device may not cause harmful interference, and (2) this device must accept any interference received, including interference that may cause undesired operation.

This equipment has been tested and found to comply with the limits for a Class B digital device, pursuant to Part 15 of the FCC Rules. These limits are designed to provide reasonable protection against harmful interference in a residential installation. This equipment generates, uses and can radiate radio frequency energy and, if not installed and used in accordance with the instructions, may cause harmful interference to radio communications. However, there is no guarantee that interference will not occur in a particular

installation. If this equipment does cause harmful interference to radio or television reception, which can be determined by turning the equipment off and on, the user is encouraged to try to correct the interference by one of the following measures:

- Reorient or relocate the receiving antenna.
- Increase the separation between the equipment and receiver.
- Connect the equipment into an outlet on a circuit different from that to which the receiver is connected.
- Consult the dealer or an experienced radio/TV technician for help.

FCC Caution: Any changes or modifications not expressly approved by the party responsible for compliance could void the user's authority to operate this equipment.

This transmitter must not be co-located or operating in conjunction with any other antenna or transmitter.

Operations in the 5.15-5.25GHz band are restricted to indoor use only.

This device meets all the other requirements specified in Part 15E, Section 15.407 of the FCC Rules.

Radiation Exposure Statement:

This equipment complies with FCC radiation exposure limits set forth for an uncontrolled environment. This equipment should be installed and operated with minimum distance 20cm between the radiator & your body.



Note: The country code selection is for the non-US model only and is not available to all US models. Per FCC regulation, all Wi-Fi products marketed in the US must be fixed to US operation channels only.

Safety Guidelines

Follow these guidelines to ensure general safety:

- ▶ Keep the chassis area clear and dust-free during and after installation.
- ▶ Do not wear loose clothing or jewelry that could get caught in the chassis. Fasten your tie or scarf and roll up your sleeves.
- ▶ Wear safety glasses if you are working under any conditions that might be hazardous to your eyes.
- ▶ Do not perform any action that creates a potential hazard to people or makes the equipment unsafe.
- ▶ Disconnect all power by turning off the power and unplugging the power cord before installing or removing a chassis or working near power supplies
- ▶ Do not work alone if potentially hazardous conditions exist.
- ▶ Never assume that power is disconnected from a circuit; always check the circuit.

Lithium Battery Caution:

- ▶ Risk of Explosion if Battery is replaced by an incorrect type. Dispose of used batteries according to the instructions.
- ▶ Installation only by a trained electrician or only by an electrically trained person who knows all English Installation and Device Specifications which are to be applied.
- ▶ Do not carry the handle of power supplies when moving to another place.

Operating Safety

- ▶ Electrical equipment generates heat. Ambient air temperature may not be adequate to cool equipment to acceptable operating temperatures without adequate circulation. Be sure that the room in which you choose to operate your system has adequate air circulation.
- ▶ Ensure that the chassis cover is secure. The chassis design allows cooling air to circulate effectively. An open chassis permits air leaks, which may interrupt and redirect the flow of cooling air from internal components.

- ▶ Electrostatic discharge (ESD) can damage equipment and impair electrical circuitry. ESD damage occurs when electronic components are improperly handled and can result in complete or intermittent failures. Be sure to follow ESD-prevention procedures when removing and replacing components to avoid these problems.
- ▶ Wear an ESD-preventive wrist strap, ensuring that it makes good skin contact. If no wrist strap is available, ground yourself by touching the metal part of the chassis.
- ▶ Periodically check the resistance value of the antistatic strap, which should be between 1 and 10 megohms (Mohms).

Mounting Installation Precaution

Environment:

- ▶ Do not install and/or operate this unit in any place that flammable objects are stored or used in.
- ▶ Elevated Operating Ambient - If installed in a closed or multi-unit rack assembly, the operating ambient temperature of the rack environment may be greater than room ambient. Therefore, consideration should be given to installing the equipment in an environment compatible with the maximum ambient temperature (T_{ma}) specified by the manufacturer.
- ▶ Reduced Air Flow - Installation of the equipment in a rack should be such that the amount of air flow required for safe operation of the equipment is not compromised. Mechanical Loading - Mounting of the equipment in the rack should be such that a hazardous condition is not created due to uneven mechanical loading.
- ▶ Mechanical Loading - Mounting of the equipment in the rack should be such that a hazardous condition is not achieved due to uneven mechanical loading.
- ▶ Circuit Overloading - Consideration should be given to the connection of the equipment to the supply circuit and the effect that overloading of the circuits might have on over-current protection and supply wiring. Appropriate consideration of equipment nameplate ratings should be used when addressing this concern.
- ▶ Reliable Earthing - Reliable earthing of rack-mounted equipment should be maintained. Particular attention should be given to supply connections other than direct connections to the branch circuit (e.g. use of power strips).
- ▶ Lanner Electronics Inc. shall not be held liable for any losses resulting from insufficient strength for supporting the unit or use of inappropriate installation components.

Consignes de sécurité

Suivez ces consignes pour assurer la sécurité générale :

- ▶ Laissez la zone du châssis propre et sans poussière pendant et après l'installation.
- ▶ Ne portez pas de vêtements amples ou de bijoux qui pourraient être pris dans le châssis. Attachez votre cravate ou écharpe et remontez vos manches.
- ▶ Portez des lunettes de sécurité pour protéger vos yeux.
- ▶ N'effectuez aucune action qui pourrait créer un danger pour d'autres ou rendre l'équipement dangereux.
- ▶ Coupez complètement l'alimentation en éteignant l'alimentation et en débranchant le cordon d'alimentation avant d'installer ou de retirer un châssis ou de travailler à proximité de sources d'alimentation.
- ▶ Ne travaillez pas seul si des conditions dangereuses sont présentes.
- ▶ Ne considérez jamais que l'alimentation est coupée d'un circuit, vérifiez toujours le circuit. Cet appareil génère, utilise et émet une énergie radiofréquence et, s'il n'est pas installé et utilisé conformément aux instructions des fournisseurs de composants sans fil, il risque de provoquer des interférences dans les communications radio.

Avertissement concernant la pile au lithium

- ▶ Risque d'explosion si la pile est remplacée par une autre d'un mauvais type.
- ▶ Jetez les piles usagées conformément aux instructions.
- ▶ L'installation doit être effectuée par un électricien formé ou une personne formée à l'électricité connaissant toutes les spécifications d'installation et d'appareil du produit.
- ▶ Ne transportez pas l'unité en la tenant par le câble d'alimentation lorsque vous déplacez l'appareil.
- ▶ La machine ne peut être utilisée qu'à un lieu fixe comme en laboratoire, salle d'ordinateurs ou salle de classe.

Sécurité de fonctionnement

L'équipement électrique génère de la chaleur. La température ambiante peut ne pas être adéquate pour refroidir l'équipement à une température de fonctionnement acceptable sans circulation adaptée. Vérifiez que votre site propose une circulation d'air adéquate.

- ▶ Vérifiez que le couvercle du châssis est bien fixé. La conception du châssis permet à l'air de refroidissement de bien circuler. Un châssis ouvert laisse l'air s'échapper, ce qui peut interrompre et rediriger le flux d'air frais destiné aux composants internes.
- ▶ Les décharges électrostatiques (ESD) peuvent endommager l'équipement et gêner les circuits électriques. Des dégâts d'ESD surviennent lorsque des composants électroniques sont mal manipulés et peuvent causer des pannes totales ou intermittentes. Suivez les procédures de prévention d'ESD lors du retrait et du remplacement de composants.
- ▶ Portez un bracelet anti-ESD et veillez à ce qu'il soit bien au contact de la peau. Si aucun bracelet n'est disponible, reliez votre corps à la terre en touchant la partie métallique du châssis.
- ▶ Vérifiez régulièrement la valeur de résistance du bracelet antistatique, qui doit être comprise entre 1 et 10 mégohms (Mohms).

Consignes de sécurité électrique

- ▶ Avant d'allumer l'appareil, reliez le câble de mise à la terre de l'équipement à la terre.
- ▶ Une bonne mise à la terre (connexion à la terre) est très importante pour protéger l'équipement contre les effets néfastes du bruit externe et réduire les risques d'électrocution en cas de foudre.
- ▶ Pour désinstaller l'équipement, débranchez le câble de mise à la terre après avoir éteint l'appareil.
- ▶ Un câble de mise à la terre est requis et la zone reliant les sections du conducteur doit faire plus de 4 mm² ou 10 AWG.

This equipment must be grounded. The power cord for product should be connected to a socket-outlet with earthing connection

Battery Precautions

- ▶ Lithium Battery Caution: There is danger of explosion if battery is incorrectly replaced. Replace only with the same or equivalent type. Dispose of batteries according to the manufacturer's instructions.
- ▶ Disposal of a BATTERY into fire or a hot oven, or mechanically crushing or cutting of a BATTERY can result in an EXPLOSION.
- ▶ Leaving a BATTERY in an extremely high temperature surrounding environment can result in an EXPLOSION or the leakage of flammable liquid or gas.
- ▶ A BATTERY subjected to extremely low air pressure may result in an EXPLOSION or the leakage of flammable liquid or gas.

Revision History

Version	Date	Descriptions
1.0	2018/08/13	1 st Release
1.1	2018/11/19	Revised FCC Statement

Table of Contents

Chapter 1: Product Overview	9
Package Content.....	9
Ordering Information	9
System Specifications	11
Front Panel	12
Rear Panel.....	13
Chapter 2: Motherboard Information	14
Block Diagram.....	14
Motherboard Layout	15
Internal Jumper & Connectors	17
Chapter 3: Hardware Setup.....	24
Preparing the Hardware Installation	24
Installing the System Memory.....	26
Installing the M.2 Interface LTE Module and Storage Module	27
Installing the MPCIE Interface LTE Module	29
Installing the Wireless Module.....	31
Installing the Hard Disk.....	33
Chapter 4: BIOS Setup	34
Enter BIOS Setup	34
Navigate BIOS Setup.....	35
Main Setup	36
Advanced Setup.....	37
Intel RCSetup	46
Security Settings	50
Boot Configuration	51
Save and Exit.....	52
Appendix A: Programming Watchdog Timer.....	53
Appendix B: Setting up Console Redirections	54
Appendix C: Programming Generation 2 LAN Bypass	55

Lanner Generation 2 Bypass.....55

Appendix D: Installing Intel QuickAssist Software for Linux..... 57

Appendix E: Terms and Conditions 58

Warranty Policy 58

RMA Service..... 58

RMA Service Request Form 59

CHAPTER 1: PRODUCT OVERVIEW

The FW-7551SE, an upgraded iteration of Lanner's best-selling vCPE/CPE device the FW-7551, is designed to take full advantage of Intel®'s Atom™ C2000 Series processors and comes with additional connectivity features, delivering virtualization-optimized performance and exceptional energy efficiency for network security, communication, and on-demand network functions.

- ▶ Intel® Atom® C2358/C2558/C2758 (Codenamed Rangeley)
- ▶ 4x GbE RJ45 Marvell 88E1543, 2x GbE SFP Intel® i210
- ▶ 1 or 2x 204pin SODIMM (By SKU), Max. 16GB
- ▶ 1x Consoles (RJ45), 2x USB 2.0
- ▶ Intel® QuickAssist Technology (By SKU)
- ▶ 1x Mini-PCIe (PCIe/USB2.0), 1x M.2 3042 (USB2.0/SATA), 2x SIM Slots
- ▶ 1x 2.5" HDD/SSD Bay (Optional)



Note: For instructions on quick installation and acquiring the Intel® Atom™ Processor C2000 Product Family for Communications Infrastructure Software for Linux* Software package, refer to the attached PDF file.

Package Content

Your package contains the following items:

- ▶ 1x FW-7551SE Network Security Platform
- ▶ 1x Power cable
- ▶ 1x Console cable



Note: If you should find any components missing or damaged, please contact your dealer immediately for assistance.

Ordering Information

SKU No.	Description
FW-7551SE-A	Intel C2358 2 Core with QA, 1x DDR3 ECC SO-DIMM, 4x GbE RJ45 LAN Ports + 2x SFP
FW-7551SE-B	Intel C2558 4 Core with QA, 2x DDR3 ECC SO-DIMM, 4x GbE RJ45 LAN Ports + 2x SFP
FW-7551SE-C	Intel C2758 8 Core with QA, 2x DDR3 ECC SO-DIMM, 4x GbE RJ45 LAN Ports + 2x SFP, 60W Adapter
FW-7551SE-D	Intel C2558 4 Core with QA, 2x DDR3 ECC SO-DIMM, 6x GbE RJ45 LAN Ports

FW-7551SE-A / B / C



FW-7551SE-D



System Specifications

Form Factor		Desktop
Platform	Processor Options	Intel® Atom® C2358/C2558/C2758 (Rangeley)
	CPU Socket	Onboard
	Chipset	SoC
	Security Acceleration	Intel® QuickAssist Technology
BIOS		AMI SPI Flash BIOS
System Memory	Technology	DDR3 1333/1600 MHz ECC DIMM
	Max. Capacity	16GB (SKU A); 32GB (SKU B)
	Socket	1x or 2x 204-pin SODIMM (By SKU)
Networking	Ethernet Ports	4x GbE RJ45 Marvell 88E1543 2x GbE SFP Intel® i210 (Co-lay 2x RJ45)
	Bypass	N/A
	NIC Module Slot	N/A
LOM	IO Interface	N/A
	OPMA slot	N/A
I/O Interface	Reset Button	1
	LED	Power/Status/Storage
	Power Button	1
	Console	1x RJ45
	USB	2x USB 2.0
	LCD Module	N/A
	Display	N/A
Power input	1x DC Jack	
Storage	HDD/SSD Support	1x 2.5" Bay (Optional)
	Onboard Storage	1x CFAST
Expansion	PCIe	N/A
	mini-PCIe	1x Mini-PCIe (PCIe/USB2.0) 1x M.2 2242 B/B+M (USB2.0)
	SIM Card Slot	2x SIM Slots for Nano SIM card
Miscellaneous	Watchdog	Yes
	Internal RTC with Li-Battery	Yes
	TPM	TPM 2.0
Cooling	Processor	Passive CPU Heatsink
	System	1x Cooling Fan w/ Smart Fan
Environmental Parameters	Temperature	0 to 40° C Operating -20 to 70° C Non- Operating
	Humidity (RH)	5 to 90% Operating 5 to 95% Non-Operating
System Dimensions	(WxDxH)	231mm x 200mm x 44mm
	Weight	1.2 kg
Package Dimensions	(WxDxH)	325mm x 120mm x 305mm
	Weight	2.2 kg
Power	Type/Watts	36W or 60W Power Adapter (By SKU)
	Input	AC 100V~240V @50~60Hz
Approvals and Compliance		-

Front Panel

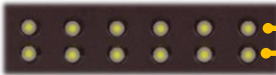

No.	Description	
F1	LED Indicators	<div style="display: flex; justify-content: space-around; align-items: flex-start;"> <div style="text-align: center;">  <ul style="list-style-type: none"> — System Power — System Status — HDD Activity </div> <div style="text-align: center;">  <ul style="list-style-type: none"> — Speed — Link Activity </div> </div> <p><u>Power/Status/HDD LED</u></p> <p>System Power If the LED is on it indicates that the system is powered on. If it is off, it indicates that the system is powered off. Status: This LED is programmable. You could program it to display the operating status with the following</p> <p>System Status If the LED is green, it indicates that the system’s operational state is normal. If it is red, it indicates that the system is malfunctioning.</p> <p>HDD If the LED blinks, it indicates data access activities; otherwise, it remains off.</p> <p><u>Speed/Link Activity</u> These LEDs are indicators for the 4 or 6 (by SKU) Ethernet ports on the back panel.</p> <p>Speed If the LED is amber, it indicates that the connection speed is 1000Mbps. If the LED is green, it indicates that the connection speed is 100Mbps. And if it is off, it indicates that the speed is 10Mbps.</p> <p>Link/Activity If the LED is on, it indicates that the port is active. If it blinks, it indicates that there is traffic.</p>

Rear Panel

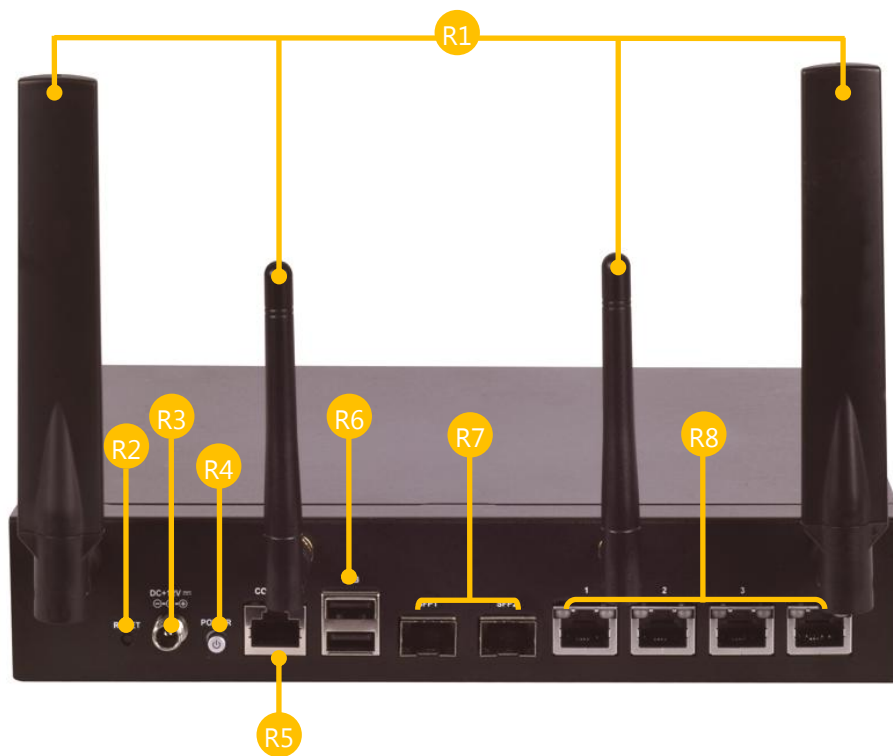

No.	Description	
R1	Antenna	4x Antennas (LTE→WIFI→WIFI→LTE)
R2	Reset Button	Software reset
R3	DC-in	ATX 60W Power Supply
R4	Power Button	Press to power on the system
R5	Console Port	By using suitable rollover cable or RJ-45 to DB-9 console cable, you can connect to a computer terminal for diagnostic or configuration purpose. Terminal Configuration Parameters: 115200 baud, 8 data bits, no parity, 1 stop bit, no flow control.
R6	USB Port	2x USB 2.0 ports
F7	SFP+ Ports	2x SFP+ ports
F8	GbE Ports	4x GbE ports 4 or 6 (by SKU) onboard Ethernet ports equip with 2 pairs of LAN bypass. These 4 GbE ports are provided by Marvell 88E1543 and the other two are provided by Intel i210AT. LAN1 is capable of Preboot eXecution Environment (PXE) (This feature needs to be enabled or disabled in the BIOS; the default is disabled). Two pairs (LAN3-LAN4, LAN5-LAN6) can be configured as LAN Bypass by using Laner Gen2 Bypass technology when failure events occur. This feature can be enabled dynamically with a watch dog timer.

CHAPTER 2: MOTHERBOARD INFORMATION

Block Diagram

The block diagram indicates how data flows among components on the motherboard. Please refer to the following figure for your motherboard's layout design.

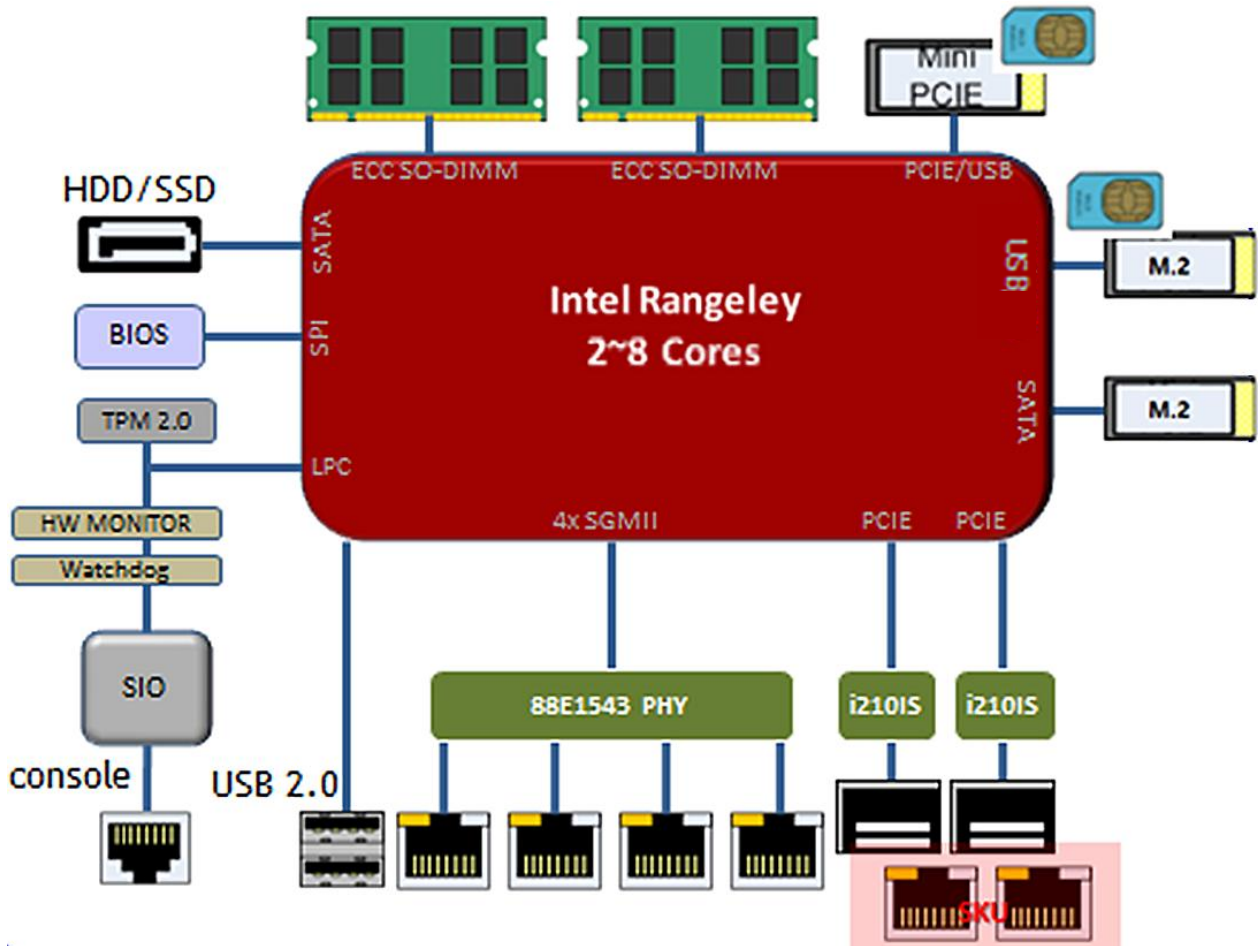

Motherboard Layout

The motherboard layout shows the connectors and jumpers on the board. Refer to the following picture as a reference of the pin assignments and the internal connectors.

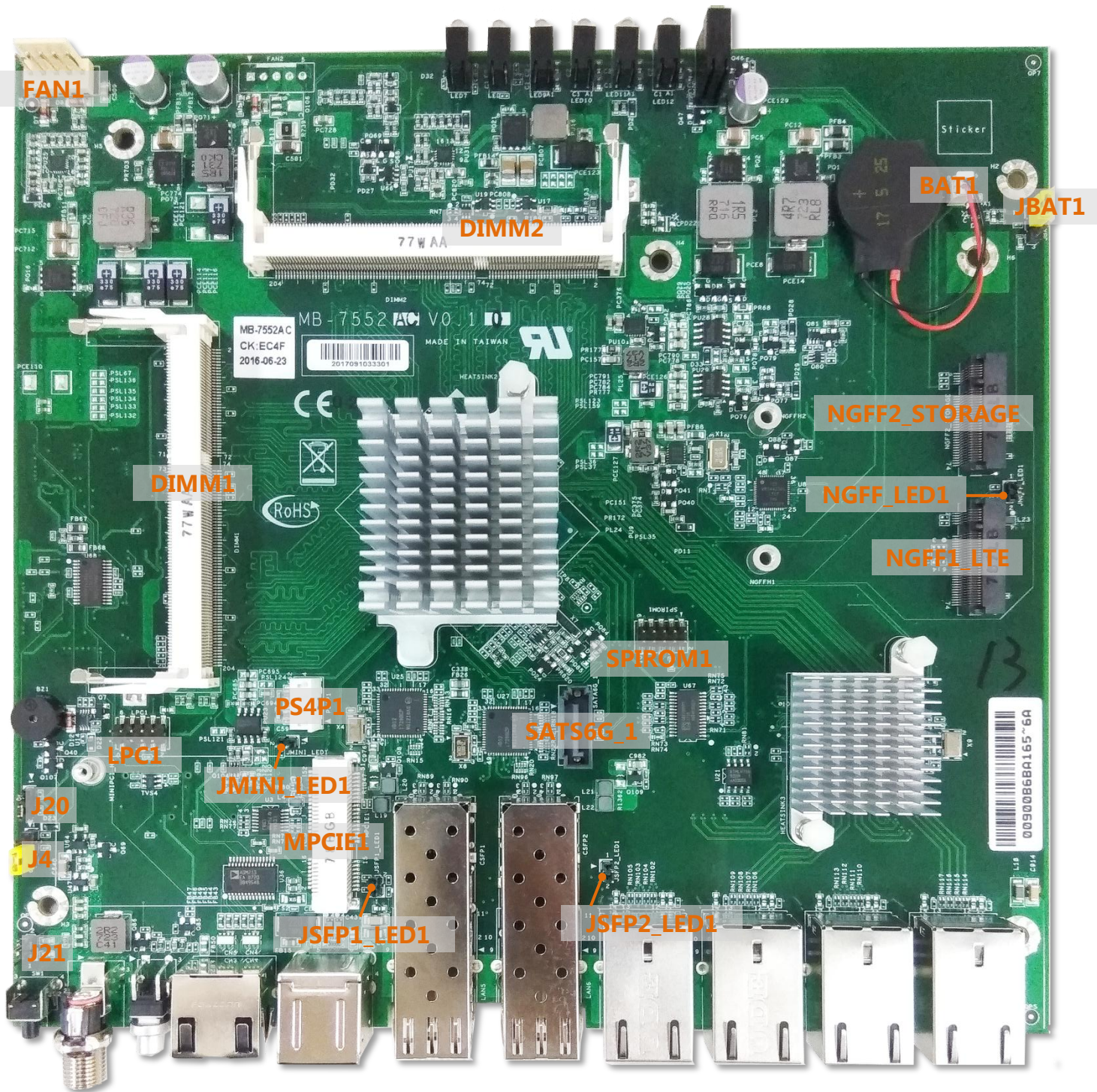

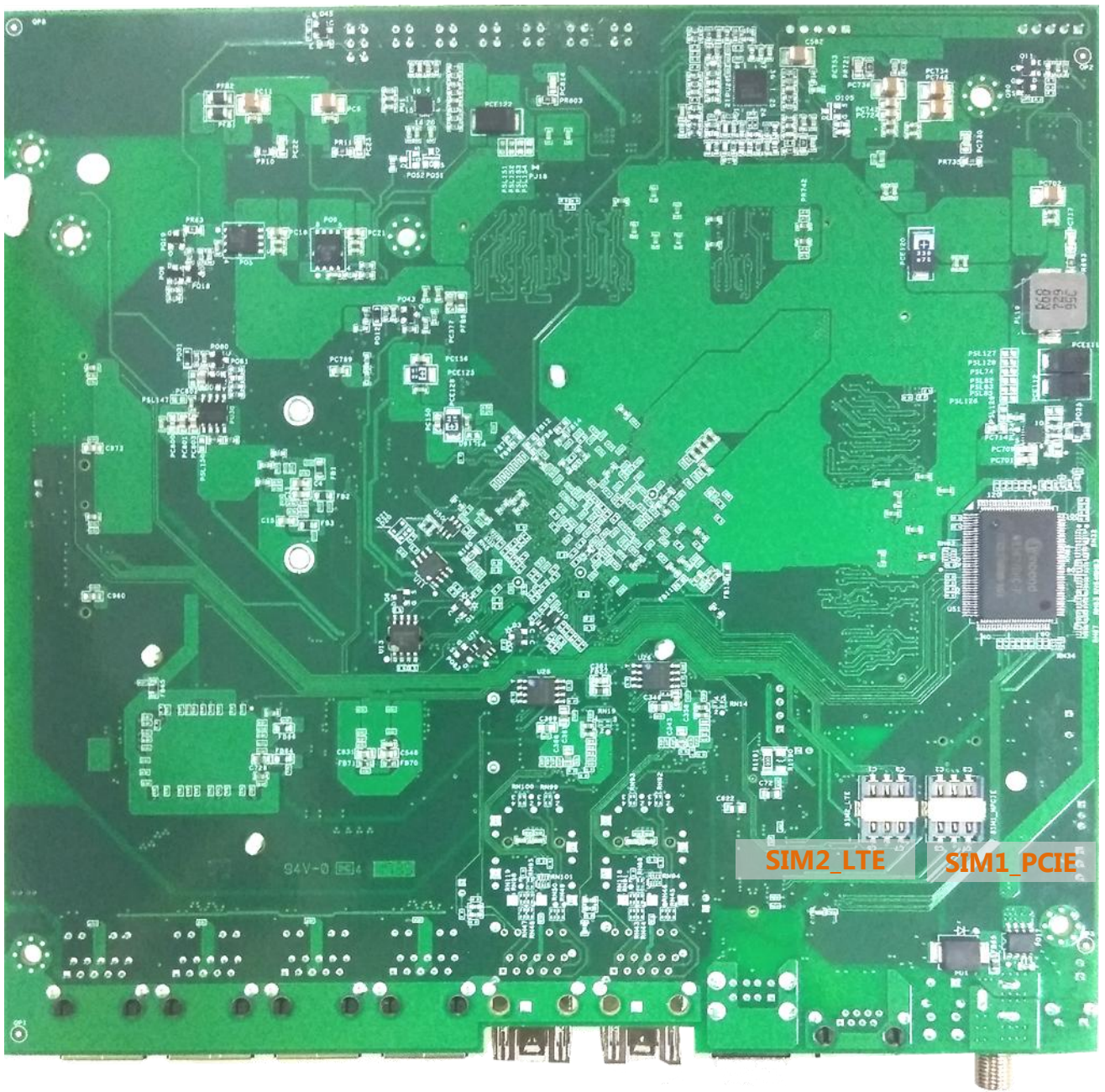



Internal Jumper & Connectors

JBAT1: Clear CMOS

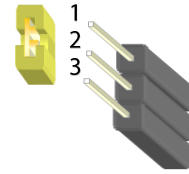
Pin	Description	Pin	Description
1	VBAT	2	PCH_RTCRST_N
3	GND		



Pin	Description	Pin	Description
1.2	Normal (Default)	2.3	Clear CMOS
1 2 3		1 2 3	
			

BAT1: RTC Battery connector

Pin	Description	Pin	Description
1	V_BATTERY	2	GND



PS4P1: SATA Power Connector

Pin	Description	Pin	Description
1	P12V	2	GND
3	GND	4	P5V



SATA6G_1: SATA connector

It is for connecting a SATA hard disk to be served as your system's storage. The system can accommodate one disk (2.5) with SATA 3.0 standard. The controller contains two modes of operation—a legacy mode using I/O space, and an AHCI mode using memory space. Software that uses legacy mode will not have AHCI capabilities. The AHCI (Advanced Host Controller Interface) is a programming interface which defines transactions between the SATA controller and software and enables advanced performance and usability with SATA. Platforms supporting AHCI may take advantage of performance features such as no master/slave designation for SATA devices—each device is treated as a master—and hardware-assisted native command queuing. AHCI also provides usability enhancements such as Hot-Plug.

Pin	Description	Pin	Description
1	GND	5	SATA6G_C_RX_DN0
2	SATA6G_C_TX_DP0	6	SATA6G_C_RX_DP0
3	SATA6G_C_TX_DN0	7	GND
4	GND		



You will need to configure your SATA as HCI mode in the BIOS in order to use the advanced features of SATA. To do this, access the BIOS menu under **IntelRCSetup** → **South Bridge Chipset Configuration** → **SATA Configuration**. Also, the hotplug enable/disable option is under the same SATA Configuration menu. Enable the hotplug function explicitly in this menu if you need it.

SPIROM1: Flash BIOS ROM update connector

It is for updating the SPI Flash soldered on board for service and repair purposes.

Pin	Description	Pin	Description
1	SPI_HOLD0_L	2	NC
3	PMU_AVN_SPI_R_CS0	4	VCC3P3_SB_SPI
5	PMU_AVN_SPI_MISO	6	NC
7	NC	8	PMU_AVN_SPI_R_CLK
9	GND	10	PMU_AVN_SPI_R_MOSI

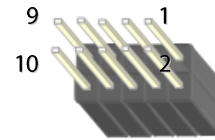

MPCIE1: Mini PCIE 52PIN

Pin	Description	Pin	Description
1	PMU_WAKE#	2	P3V3_MINI
3	NC	4	GND
5	NC	6	P1V5
7	MINI_CLKREQ_N1	8	UIM1_PWR
9	GND	10	UIM1_DAT
11	MINIPCIE_REFCLKN	12	UIM1_CLK
13	MINIPCIE_REFCLKP	14	UIM1_RST
15	GND	16	UIM1_VPP
17	NC	18	GND
19	NC	20	RF_KILL_N2_R
21	GND	22	PLTRST_MINIPCIE_N
23	MINI_PCIE_RXN0	24	P3V3_MINI
25	MINI_PCIE_RXP0	26	GND
27	GND	28	P1V5
29	GND	30	SMB_HOST_3V3_CLK
31	MINI_PCIE1_TX_N0C	32	SMB_HOST_3V3_DAT
33	MINI_PCIE1_TX_P0C	34	GND
35	GND	36	USB3_SB_L_DN
37	GND	38	USB3_SB_L_DP
39	P3V3_MINI	40	GND
41	P3V3_MINI	42	LED_WWAN_N
43	GND	44	LED_WLAN_N
45	NC	46	NC
47	NC	48	P1V5
49	NC	50	GND
51	NC	52	P3V3_MINI

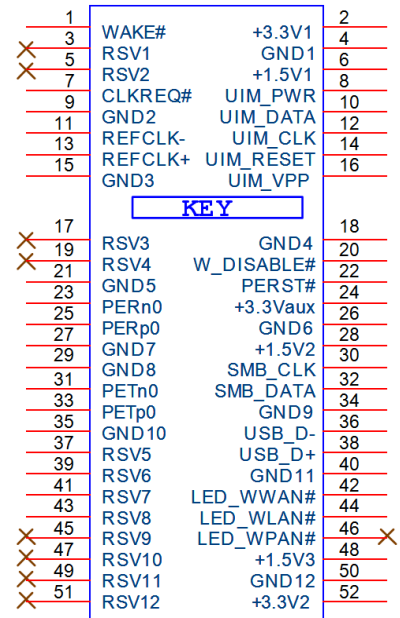
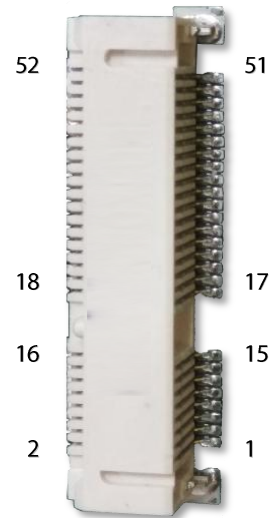

JMINI_LED1: Extra MINI_PCIE LED con (Reserve no use)

Pin	Description	Pin	Description
1	MINI_LED_N	2	P3V3_MINI

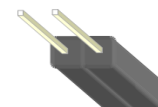

NGFF1_LTE: M.2 con (Only LTE)

Pin	Description	Pin	Description
-----	-------------	-----	-------------

1	NC	2	P3V3_MINI
3	GND	4	P3V3_MINI
5	GND	6	PWROFF#
7	USB0_SB_L_DP	8	W_DIS#
9	USB0_SB_L_DN	10	NGFF_LED_N
11	GND	12	NC
13	NC	14	NC
15	NC	16	NC
17	NC	18	NC
19	NC	20	NC
21	NC	22	NC
23	NC	24	NC
25	NC	26	NC
27	GND	28	UIM2_VPP
29	NC	30	UIM2_RST
31	NC	32	UIM2_CLK
33	GND	34	UIM2_DAT
35	NC	36	UIM2_PWR
37	NC	38	NC
39	GND	40	NC
41	NC	42	NC
43	NC	44	NC
45	GND	46	NC
47	NC	48	NC
49	NC	50	PLTRST_M2SIM_N
51	GND	52	NC
53	NC	54	NC
55	NC	56	NC
57	GND	58	NC
59	NC	60	NC
61	NC	62	NC
63	NC	64	NC
65	NC	66	NC
67	P3V3_MINI	68	NC
69	NC	70	P3V3_MINI
71	GND	72	P3V3_MINI
73	GND	74	P3V3_MINI
75	NC		

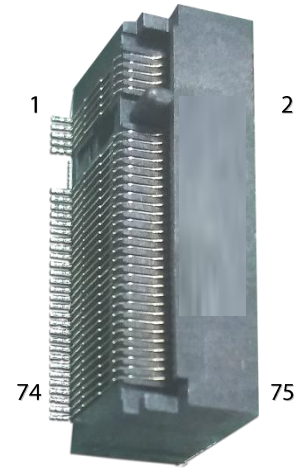

1	GND_PRESENCE_IND	2	
3	GND<3>	3V3_AUX2	4
5	GND<5>	3V3_AUX4	6
7	USB2_D+		8
9	F_CARD_PWROFF#	USB2_D-	10
11	W_DIS#	GND<11>	
13	LED#1DAS/DSS#		12
15			14
17	NOTCH<1>	NOTCH<5>	16
19	NOTCH<2>	NOTCH<6>	18
	NOTCH<3>	NOTCH<7>	
	NOTCH<4>	NOTCH<8>	20
21			22
23		AUDIO_0	24
25	GND-WWAN/OC-SSD	AUDIO_1	26
27	NC<23>	AUDIO_2	28
29	NC<25>	AUDIO_3	30
31	GND<27>		32
33	UIM_RFU	PERn1/USB3RX-	34
35	UIM_RESET	PERp1/USB3RX+	36
37		UIM_CLK	38
39	GND<33>		40
41	UIM_DATA	PETn1/USB3TX-	42
43	UIM_PWR	PETp1/USB3TX+	44
45	DEVSLP	GND<39>	46
47	GNSS0	PERn0/SATA-B+	48
49	GNSS1	PERp0/SATA-B-	50
51	GNSS2	GND<45>	52
53	GNSS3	PETn0/SATA-A-	54
55	GNSS4	PETp0/SATA-A+	56
57	PERST#	GND<51>	58
	CLKREQ#	REFCLKN	
59	WAKE#	REFCLKP	60
61	NC_56	GND<57>	62
63	NC_58		64
65			66
67	ANTCTL0	COEX3	
69	ANTCTL1	COEX2	68
71	ANTCTL2	COEX1	70
73	SIM_DET		72
75	RESET#	SUSCLK	74

NGFF2_STORAGE: M.2 storage con (Only Storage)

Pin	Description	Pin	Description
1	NC	2	P3V3_MINI
3	GND	4	P3V3_MINI
5	GND	6	PWROFF#
7	NC	8	W_DIS#
9	NC	10	HDD_LED#
11	GND	12	NC
13	NC	14	NC
15	NC	16	NC
17	NC	18	NC
19	NC	20	NC
21	NC	22	NC
23	NC	24	NC
25	NC	26	NC
27	GND	28	NC
29	NC	30	NC
31	NC	32	NC
33	GND	34	NC
35	NC	36	NC
37	NC	38	NC
39	GND	40	NC
41	SATA_HRX_C_DTX_P1	42	NC
43	SATA_HRX_C_DTX_N1	44	NC
45	GND	46	NC
47	SATA_HTX_C_DRX_N1	48	NC
49	SATA_HTX_C_DRX_P1	50	PLTRST_M2STORAGE_N
51	GND	52	NC
53	NC	54	NC
55	NC	56	NC
57	GND	58	NC
59	NC	60	NC
61	NC	62	NC
63	NC	64	NC
65	NC	66	NC
67	P3V3_MINI	68	NC
69	NC	70	P3V3_MINI
71	GND	72	P3V3_MINI
73	GND	74	P3V3_MINI
75	NC		

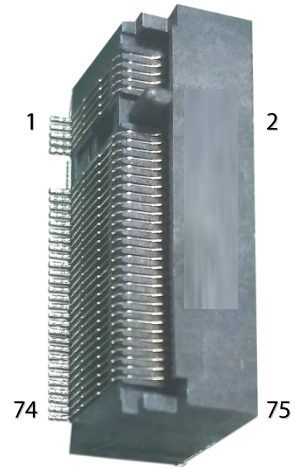

1	GND_PRESENCE_IND	2	
3	GND<3>	3V3_AUX2	4
5	GND<5>	3V3_AUX4	6
7			8
9	USB2_D+		10
11	F_CARD_PWROFF#	USB2_D-	
	W_DIS#	GND<11>	
13	LED#1DAS/DSS#		12
15			14
17	NOTCH<1>	NOTCH<5>	16
19	NOTCH<2>	NOTCH<6>	18
	NOTCH<3>	NOTCH<7>	
	NOTCH<4>	NOTCH<8>	20
21			22
23		AUDIO_0	24
25	GND-WWAN/OC-SSD	AUDIO_1	26
27	NC<23>	AUDIO_2	28
29	NC<25>	AUDIO_3	30
31	GND<27>		32
33	UIM_RFU	PERn1/USB3RX-	34
35	UIM_RESET	PERp1/USB3RX+	36
37		UIM_CLK	38
39	GND<33>		40
41	UIM_DATA	PETn1/USB3TX-	42
43	UIM_PWR	PETp1/USB3TX+	44
45	DEVSLP	GND<39>	46
47	GNSS0	PERn0/SATA-B+	48
49	GNSS1	PERp0/SATA-B-	50
51	GNSS2	GND<45>	52
53	GNSS3	PETn0/SATA-A-	54
55	GNSS4	PETp0/SATA-A+	56
57	PERST#	GND<51>	58
	CLKREQ#	REFCLKN	
59	WAKE#	REFCLKP	60
61	NC_56	GND<57>	62
63	NC_58		64
65			66
67	ANTCTL0	COEX3	
	ANTCTL1	COEX2	68
69	ANTCTL2	COEX1	70
71	ANTCTL3		72
73	SIM_DET		74
75	RESET#	SUSCLK	

JNGFF_LED1: Extra M.2 LED con (Reserve no use)

Pin	Description	Pin	Description
1	NGFF_LED_N	2	P3V3_MINI

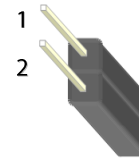

J20: TPM Physical Presence con

Pin	Description
1	P3V3
2	PP
3	GND

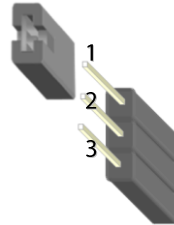

FAN1: PWM FAN con

Pin	Description
1	FAN OUT1
2	NC
3	FAN IN1
4	VFAN1
5	GND



LPC1: PORT80 con

It is a proprietary connector for connecting a checkpoint device to output checkpoints throughout booting and Power-On Self Test (POST) to indicate the task the system is currently executing.

Pin	Description	Pin	Description
1	CLK_33M_P80	2	LPC_AD1
3	PLTRST_PORT80_N	4	LPC_AD0
5	LPC_FRAME_N	6	P3V3
7	LPC_AD3	8	NC
9	LPC_AD2	10	GND

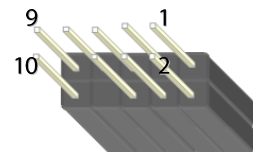

J4: H/W & S/W Reset

The jumper can be adjusted to be in either hardware or software reset mode when the reset switch is pressed. The hardware reset will reboot the system without turning off the power. The software reset can be programmed to reset a software to its default setting.

Pin	Description	Pin	Description
1.2	Hardware reset	2.3	Software reset
2		2	
3		3	

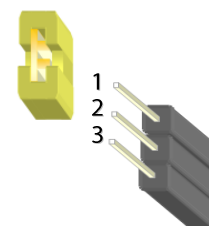

Pin	Description	Pin	Description
1	FP_RST_N_D	2	N41914839
3	FP_SFRST_N		

JSFP1_LED1/JSFP1_LED2: SFP+ con LED x2 (Reserve no use)

JSFP1_LED1

Pin	Description
1	LAN1_LINK_ACT_N
2	LAN1_LINK_100_N

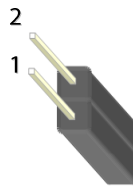

JSFP2_LED1

Pin	Description
1	LAN2_LINK_ACT_N
2	LAN2_LINK_100_N

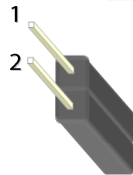

DIMM Socket (DIMM1, DIMM2): The 204-pin DDR3 SO-DIMM is for connecting the DDR3 1333/1600 **ECC** memory. The system can support up to 8 GB in maximum

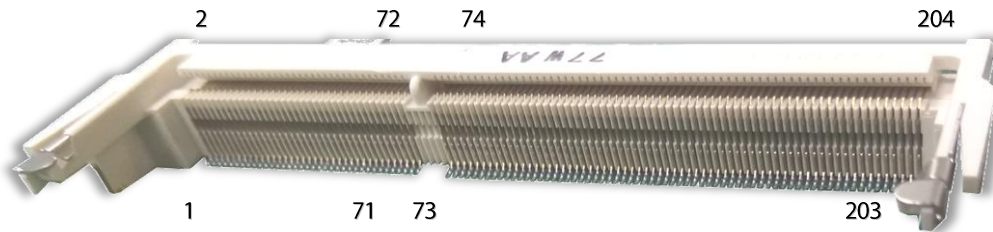

AT-Mode Power Button Connector (J21)

It is for connecting the power switch in AT mode.

Pin	Description
1	P3VSB
2	MR

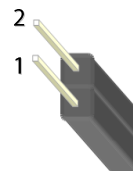

COM1: Console port

Pin	Description	Pin	Description
1	LNRTSA#	2	LNDTRA#
3	LNSOUTA	4	IOGND
5	IOGND	6	LNSINA
7	LNSRA#	8	LNCTSA#

/

SIM1_MPCIE: SIM CONN_6P (For MINI PCIE)

Pin	Description	Pin	Description
C1	UIM1_PWR	C4	UIM1_DATA
C2	UIM1_RST	C5	UIM1_VPP
C3	UIM1_CLK	C6	GND

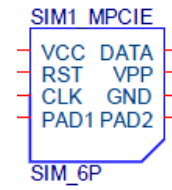

SIM2_LTE: SIM CONN_6P (For M.2)

Pin	Description	Pin	Description
C1	UIM2_PWR	C4	UIM2_DATA
C2	UIM2_RST	C5	UIM2_VPP
C3	UIM2_CLK	C6	GND

CHAPTER 3: HARDWARE SETUP

To reduce the risk of personal injury, electric shock, or damage to the system, please remove all power connections to completely shut down the device. Also, please wear ESD protection gloves when conducting the steps narrated in this chapter.

Preparing the Hardware Installation

To access some components and perform certain service procedures, you must perform the following procedures first.



WARNING: To reduce the risk of personal injury, electric shock, or damage to the equipment, remove the power cord to remove power from the server. The front panel Power On/Standby button does not completely shut off system power. Portions of the power supply and some internal circuitry remain active until AC power is removed.

1. Unpower the system and remove the power cord.
2. Unscrew 2 screws on each side and the bottom of the top cover.



3. Slide the cover backward to open it.

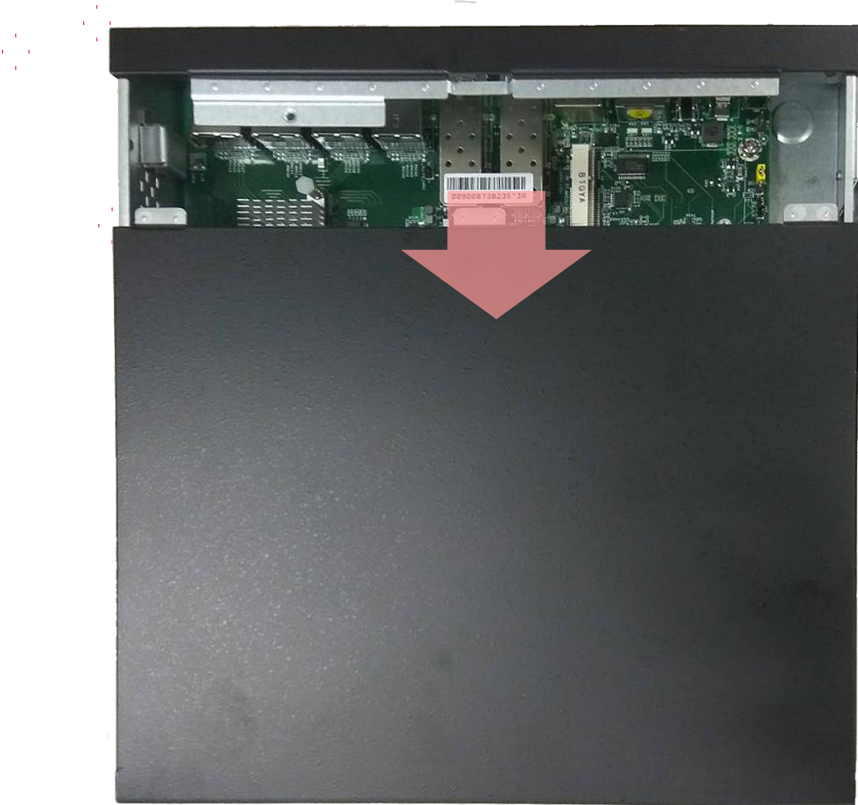

Installing the System Memory

The motherboard supports DDR3 memory that features data transfer rates of 1333, 1600 MHz to meet the higher bandwidth requirements of the latest operating system and Internet applications. To install the memory:

1. Open the DIMM slot latches.
2. Install the DIMM.

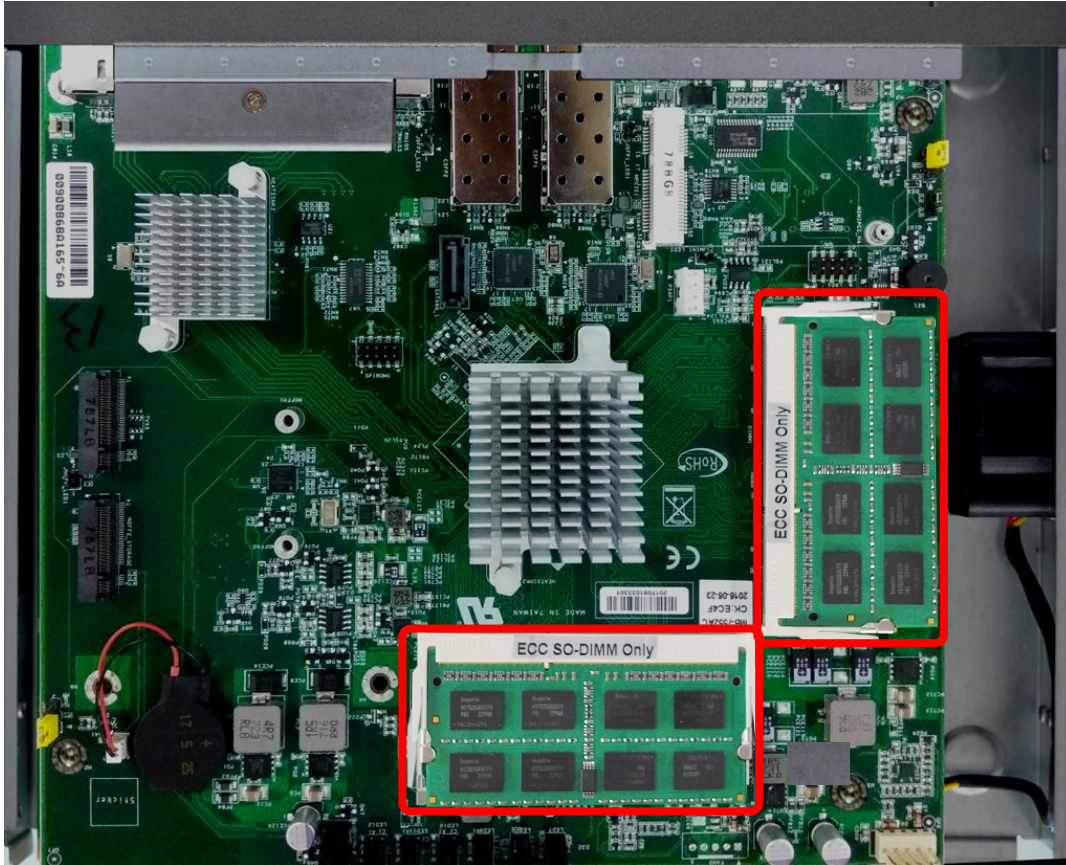

Note: The system requires DDR3 1333/1600 MHz (ECC) memory. Do not install memories with different specifications. The system can support up to 32 GB in maximum.

Installing the M.2 Interface LTE Module and Storage Module

The installation of these two modules should be prior to the hard disk installation.

1. Locate the M.2 slot for LTE module or storage module on the motherboard.

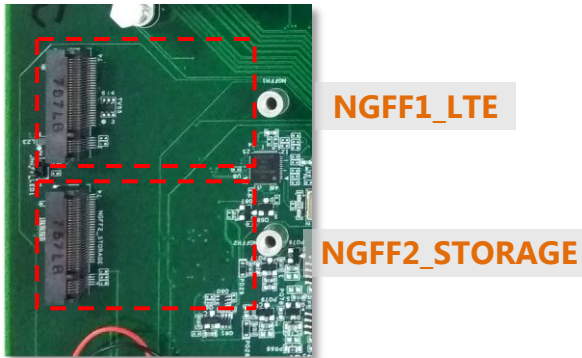

2. Align the notch of the module with the socket key in the slot. Insert the module at 30 degrees into the socket until it is fully seated in the connector.



3. Push down on the module and secure it with the screw that comes with the package.

4. (For LTE module) Snap one LTE antenna cable onto the U.FL connector for **Main**, and the other one onto the U.FL connector for **AUX**.



Note: Please purchase the antenna accessory kit for this system from Lanner.

5. (For LTE module) Replace the top cover and fix it with 6 screws. Flip over the system, loosen the screws that fix the cover of SIM card holder to reveal the SIM slots. Insert the SIM card into **SIM2_LTE** slot and fix the cover with 2 screws.



6. (For LTE module) Attach the LTE antennas onto the front panel. Make sure the antenna cables (Main and Aux) go through the right holes as indicated in the picture.



Installing the MPCIE Interface LTE Module

The motherboard provides one mini-PCIe slot supporting both WIFI and LTE module. The installation of this module should be prior to the hard disk installation.

1. Locate **MPCIE1** slot.

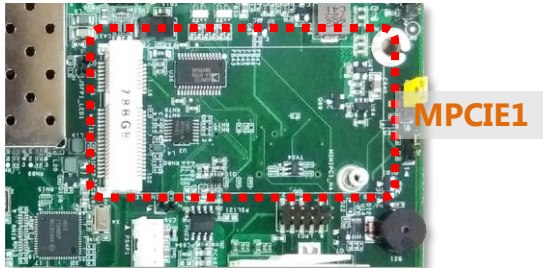

2. Align the notch of the module with the socket key in the slot. Insert the module at 30 degrees into the socket until it is fully seated in the connector.



3. Fix the module to the motherboard with screws.
4. Snap one LTE antenna cable onto the U.FL connector for **MAIN**, and the other one onto the U.FL connector for **AUX**.

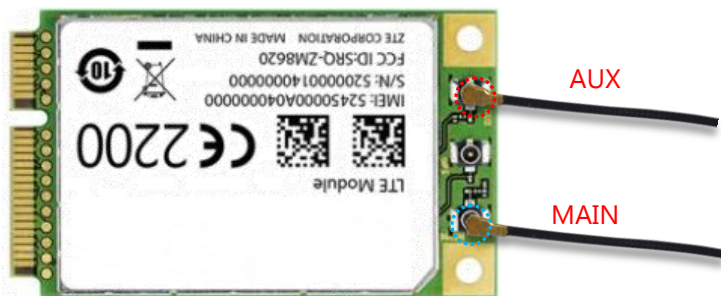

Note: Please purchase the antenna accessory kit for this system from Lanner.

5. Replace the top cover and fix it with 6 screws. Flip over the system, loosen the screws that fix the cover of SIM card holder to reveal the SIM slots. Insert the SIM card into **SIM1_MPCIE** slot and fix the cover with 2 screws.



6. Attach the LTE antennas onto the front panel. Make sure the antenna cables (Main and Aux) go through the right holes as indicated in the picture.



Installing the Wireless Module

The motherboard provides one mini-PCIe slot supporting both WIFI and LTE module. The installation of this module should be prior to the hard disk installation.

1. Locate **MPCIE1** slot.

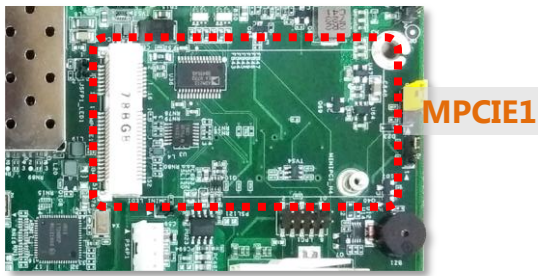

2. Align the notch of the module with the socket key in the slot. Insert the module at 30 degrees into the socket until it is fully seated in the connector.



3. Fix the module to the motherboard with a screw.
4. Snap one WIFI antenna cable onto the U.FL connector for **WIFIO**, and the other one onto the U.FL connector for **WIFI1**.



Note: Please purchase the antenna accessory kit for this system from Lanner.

5. Attach the WIFI antennas onto the front panel. Make sure the antenna cables (WIFI0 and WIFI1) go through the right holes as indicated in the picture.



Installing the Hard Disk

The system can accommodate one 2.5" Serial-ATA disk. Follow these steps to install a hard disk into the FW-7551SE:

1. Unscrew the 4 screws on the hard disk tray to take out the hard disk tray from the system.
2. Insert the four rubber washers into the four notches of the tray.
3. Place the hard disk on the tray and align the holes of the hard disk with the mounting holes on the tray. Secure the hard disk with 4 disk screws on the tray.
4. Connect the Serial-ATA power and data cables to the hard disk's power and drive connector respectively.
5. Plug the Serial-ATA power and data disk cables to the Serial-ATA power and drive connectors on the main board.
6. Put the hard disk tray with the installed hard disk back to the system and secure it with the mounting screws.

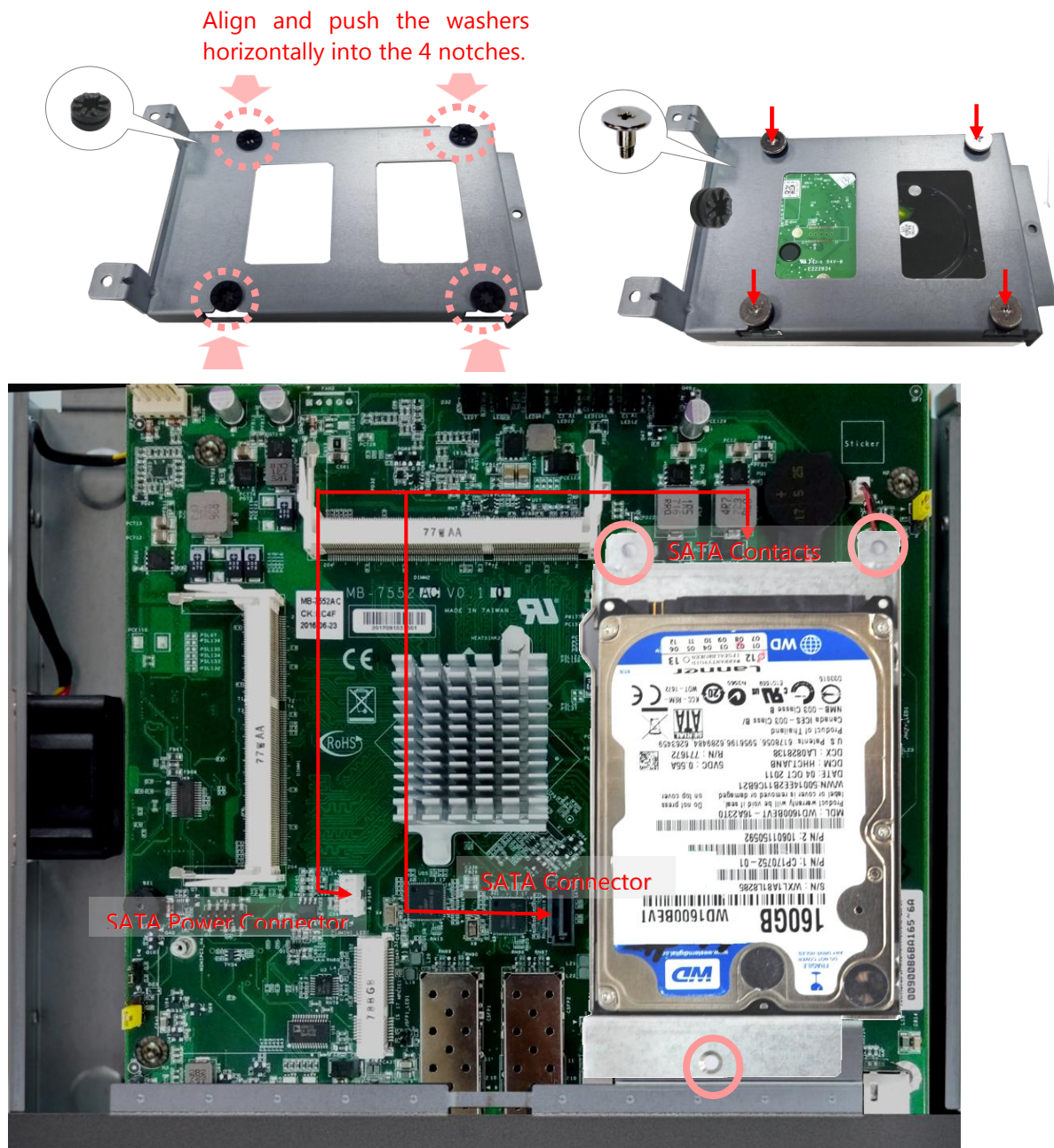

Note: The HDD kit is not included in the package; please order it separately.

CHAPTER 4: BIOS SETUP

Enter BIOS Setup

When you are installing a motherboard or when the system prompts “**Run Setup**” during start-up, you will use the BIOS Setup program to configure the system. This section explains how to configure your system using this program.

Even if you are not prompted to enter the BIOS Setup program when you are installing a motherboard, you can still change the configuration of your computer later on with this program. For example, you may want to enable the security password feature or change the power management settings. This requires you to reconfigure your system by using the BIOS Setup program so that the computer can recognize these changes and record them in the CMOS RAM.

When you start up the computer, the system provides you with the opportunity to run this program. Press **<Delete>** during the Power-On-Self-Test (POST) to enter the Setup utility (There are a few cases that other keys may be used, such as **<F1>**, **<F2>**, and so forth.); otherwise, POST continues with its test routines.

If you wish to enter Setup after POST, restart the system by pressing **<Ctrl+Alt+Delete>**, or by pressing the reset button on the system chassis. You can also restart by turning the system off and then back on. Do this last option only if the first two failed.

The Setup program is designed to make it as easy to use as possible. Being a menu-driven program, it lets you scroll through the various sub-menus and make your selections from the available options using the navigation keys.



Note: This manual describes the standard look of setup screen. There may be some instances where the motherboard features vary from one to another due to customization. This means some of the options described in this manual may not match that of your motherboard’s AMI BIOS.

PXE Function

The Preboot eXecution Environment (PXE) allows you to boot computers using a network interface independently of data storage devices (like hard disks) or installed operating systems. Enable or disable this function with this option here. For LAN port that can be configured to PXE function, refer to Chapter 1 Introduction.

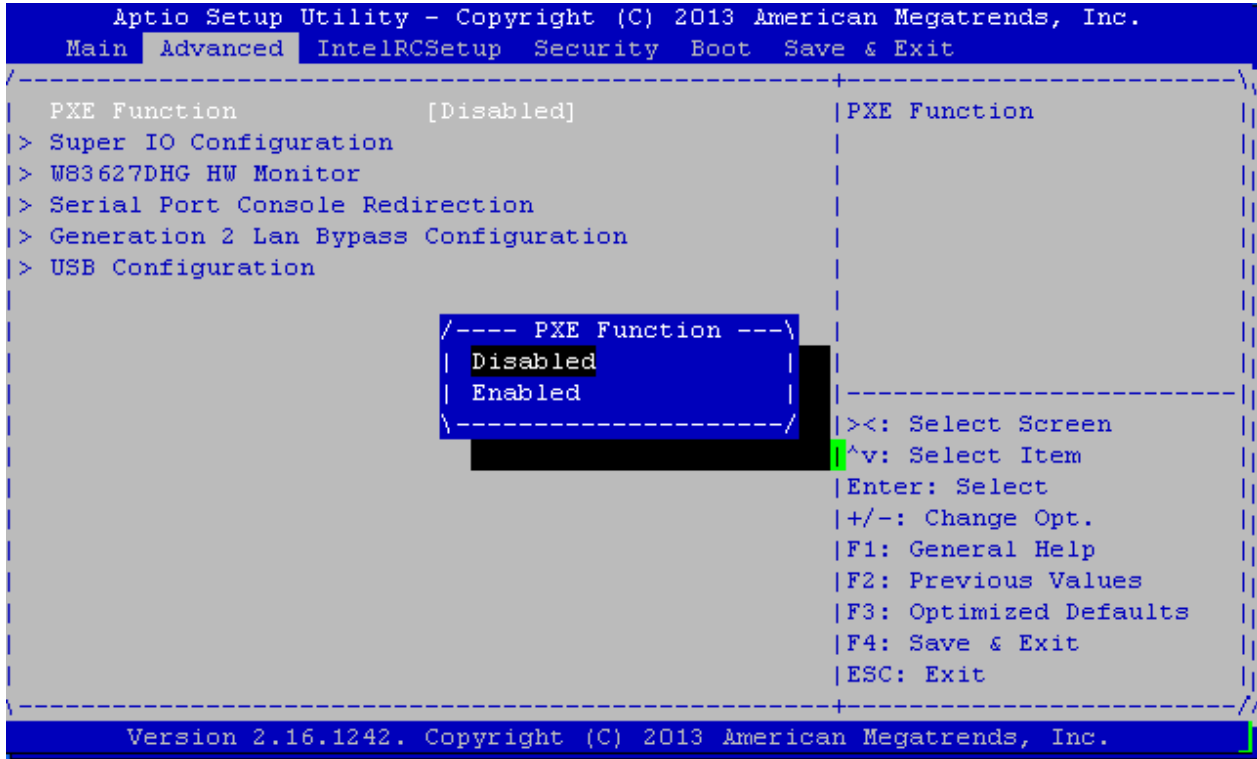

Super IO configuration

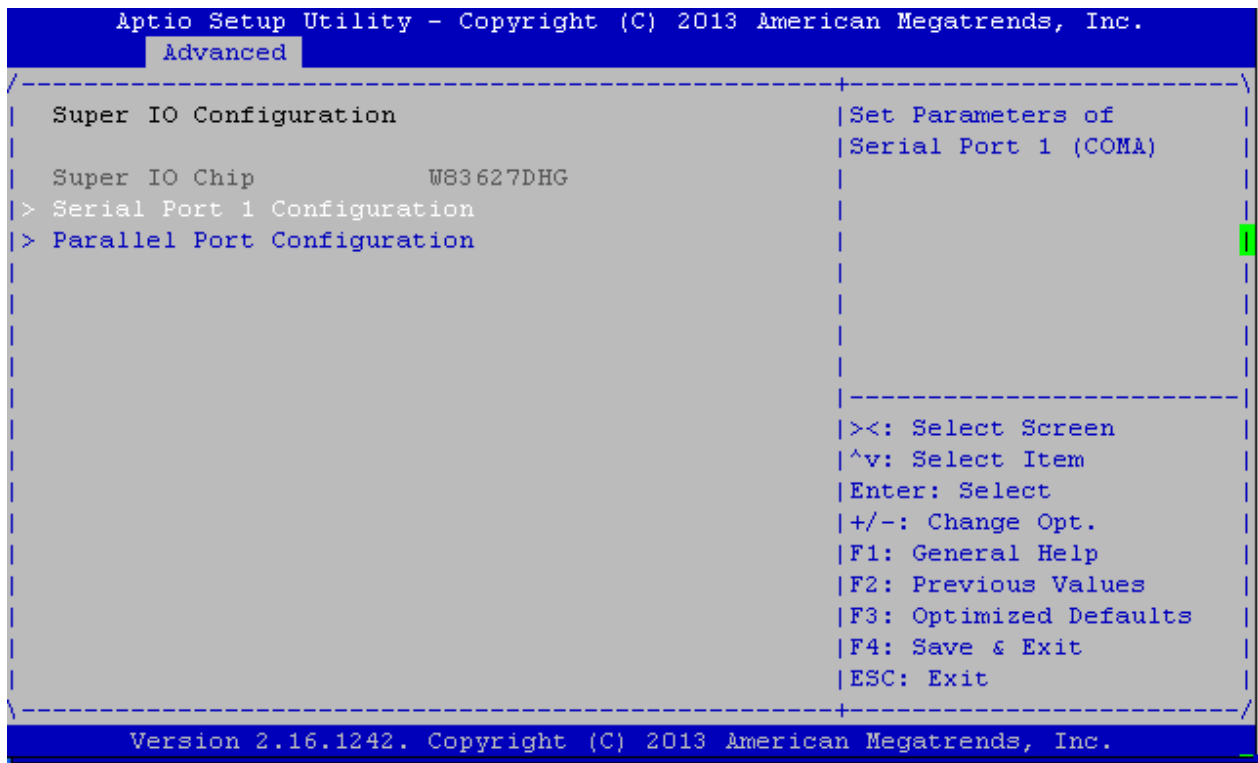

Serial Port 0/1 Configuration

Item	Description
Serial Port	Enable or disable this serial port
Device Settings	Shows the serial port base address and the IRQ port
Change Settings	Selects the port base address and the IRQ port

Parallel port Configuration

Item	Description
Parallel Port	Enable or disable this parallel port
Device Settings	Shows the parallel port base address and the IRQ port
Change Settings	Selects the port base address and the IRQ port

Console Redirection

Use this menu to set the settings for BIOS remote access feature.

```

Aptio Setup Utility - Copyright (C) 2013 American Megatrends, Inc.
  Advanced
-----+-----
| COM0                                     | Emulation: ANSI:           ||
| Console Redirection Settings           | Extended ASCII char       ||
|                                       | set. VT100: ASCII char   ||
| Terminal Type                         | set. VT100+: Extends     ||
| Bits per second                       | VT100 to support color,  ||
| Data Bits                             | function keys, etc.      ||
| Parity                                | VT-UTF8: Uses UTF8      ||
| Stop Bits                             | encoding to map Unicode  ||
| Flow Control                          | chars onto 1 or more    ||
| VT-UTF8 Combo Key Sup                 | -----+-----        ||
| Recorder Mode                         | ><: Select Screen        ||
| Resolution 100x31                    | ^v: Select Item          ||
| Legacy OS Redirection                 | Enter: Select            ||
| Putty KeyPad                          | +/-: Change Opt.        ||
| Redirection After BIO                 | F1: General Help        ||
|                                       | F2: Previous Values     ||
|                                       | F3: Optimized Defaults  ||
|                                       | F4: Save & Exit         ||
|                                       | ESC: Exit               ||
-----+-----
Version 2.16.1242. Copyright (C) 2013 American Megatrends, Inc.
  
```

Item	Description
Console Redirection	Enable or disable BIOS through remote access
Console Redirection Settings	Enter to view more options

COM0 Console Redirection Settings

Item	Description
Terminal Type	Sets the connection terminal type
Bits per second, Data bits, Parity, Stop Bits, Flow Control	Sets the terminal connection parameters such as the baud rate, parity check mechanism, flow control, etc.

Lanner Generation 2 LAN Bypass Configuration

In this screen, you can configure the LAN bypass functionality. The system can accommodate one LAN module.

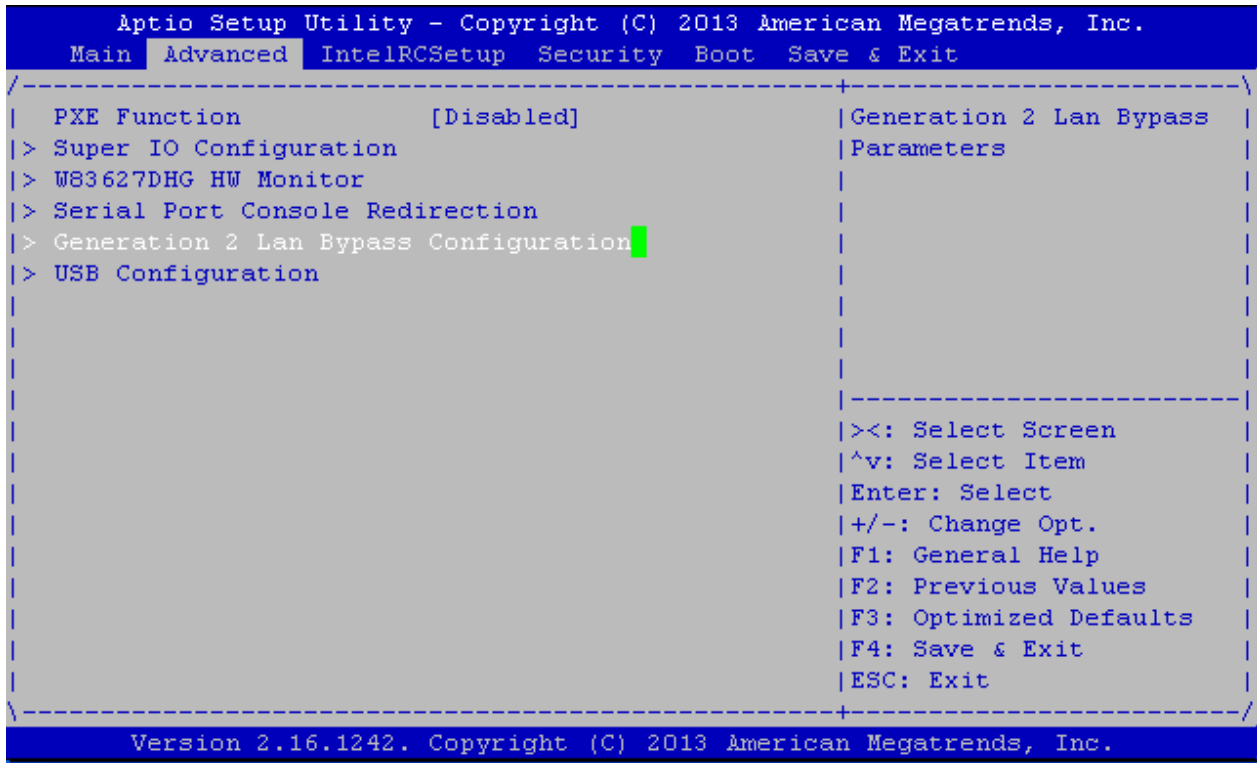

LAN Bypass for Ethernet Expansion Module

You can activate or deactivate the LAN Bypass ports. For the description of the physical ports that are capable of the LAN Bypass function, refer to the *Front Panel Feature* in *Chapter 1 Introduction*.



Note: the Ethernet expansion module may support Lanner Generation 2 or Generation 3 Bypass depending on the module specification. See appendix D Programming Generation 2 and 3 LAN Bypass for more information

Runtime and Power off Bypass Settings

You can enable or disable the automatic activation of hardware LAN Bypass function in the event of a power failure. Hardware Bypass can automatically activate to allow network traffic to continue.

The LAN bypass can be turned on or off in two system states, i.e., power on and power off. The following are the BIOS menu and illustration of the possibilities of LAN bypass configuration in each state. Note that according to the result from table 2, the ports are not bypassed in both Power-on or Power-off state when the setting "Power off LAN Bypass for Module 1" is disabled.

System Status \ Bypass settings in the BIOS	Runtime LAN Bypass for Module 1		Power off LAN Bypass for Module 1
	Enabled	Disabled	
Power on	Bypass	Non-Bypass	Enabled
Power off	Bypass	Bypass	

System Status	Bypass settings in the BIOS		Runtime LAN Bypass for Module 1	Power off LAN Bypass for Module 1
	Enabled	Disabled		
Power on	Non-Bypass	Non-Bypass	Disabled	
Power off	Non-Bypass	Non-Bypass		

USB Configuration

You can use this screen to select options for the USB Configuration. Use the up and down <Arrow> keys to select an item. Use the <Plus> and <Minus> keys to change the value of the selected option. The settings are described on the following pages.

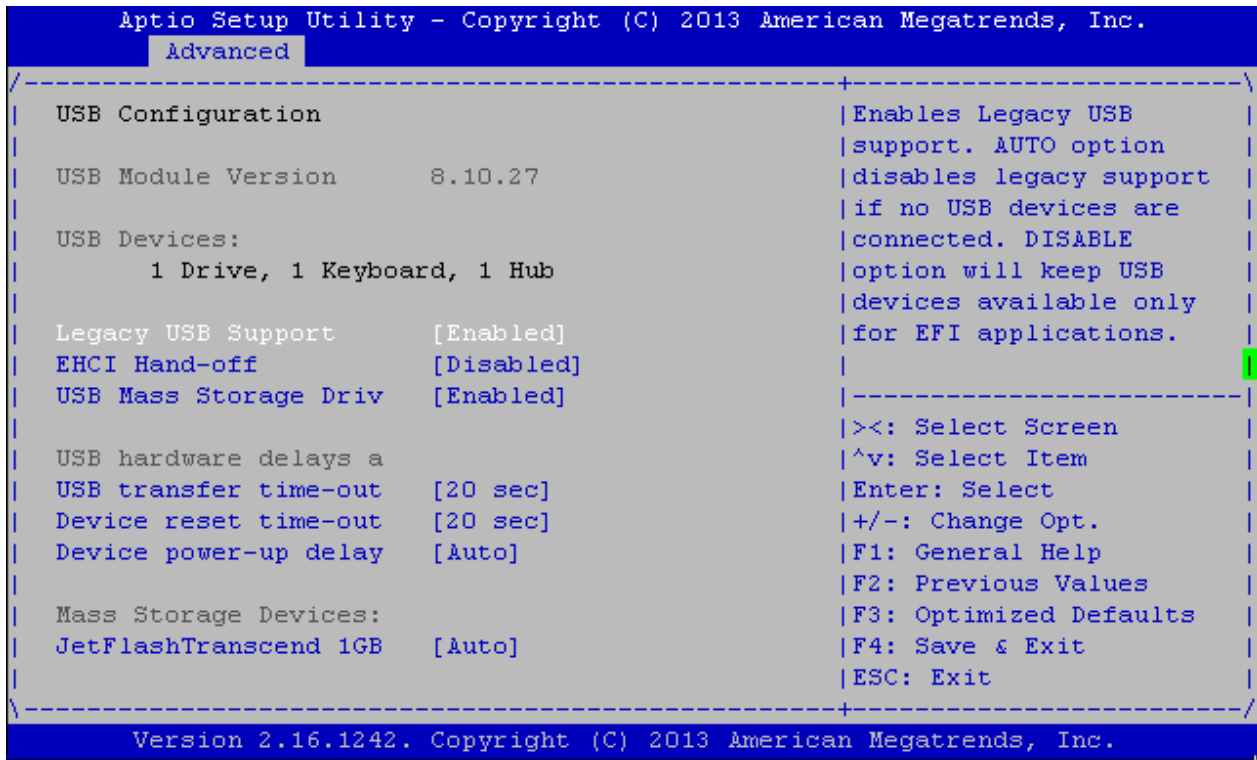

Legacy USB Support

This option enables or disables the support for USB devices on legacy operating systems (OS), e.g., Windows ME/98/ NT, and MS-DOS. Normally if this option is not enabled, any attached USB mouse or USB keyboard will not become available until a USB compatible operating system is fully booted with all USB drivers loaded. When this option is enabled, any attached USB mouse or USB keyboard can be used on the system even when there is no USB drivers loaded on it.

Item	Description
Auto	Allow the system to detect the presence of USB devices at startup. If detected, the USB controller legacy mode is enabled. If it is not detected, the USB controller legacy mode is disabled.
Enabled	Enable the support for USB devices on legacy operating system
Disabled	Disable this function.

EHCI Hand-Off

It allows you to enable support for operating systems which do not have the Enhanced Host Controller Interface hand-off (EHCI hand-off) feature for USB devices.

Item	Description
Enabled	Enable this feature
Disabled	Disable this feature

USB Mass Storage Driv

In this option, you can enable or disable the attached USB drive to be used as the system's hard drive.

The menu sets delay time for USB operations.

Item	Description
USB transfer time-out	Sets transfers to an endpoint to complete within a specific time. <ul style="list-style-type: none"> ● If set to zero, transfers will not time out because the host controller will not cancel the transfer. In this case, the transfer waits indefinitely until it is manually canceled or the transfer completes normally. ● If set to a nonzero value (time-out interval), the host controller starts a timer when it receives the transfer request. When the timer exceeds the set time-out interval, the request is canceled.
Device reset time-out	This option sets the reset timing for the USB Mass Storage to be initialized. When set to 10 Sec, the BIOS will wait for up to 30 seconds for the USB flash drive to initialize.
Device power-up delay	This option sets the power-up timing for the USB Mass Storage to be initialized.

Intel RCSetup

You can use this screen to view the capabilities and of your CPU. You can also use this menu to enable/disable certain functions of your CPU. Use the up and down **<Arrow>** keys to select an item. Use the **<Plus>** and **<Minus>** keys to change the value of the selected option. A description of the selected item appears on the right side of the screen. The settings are described below.

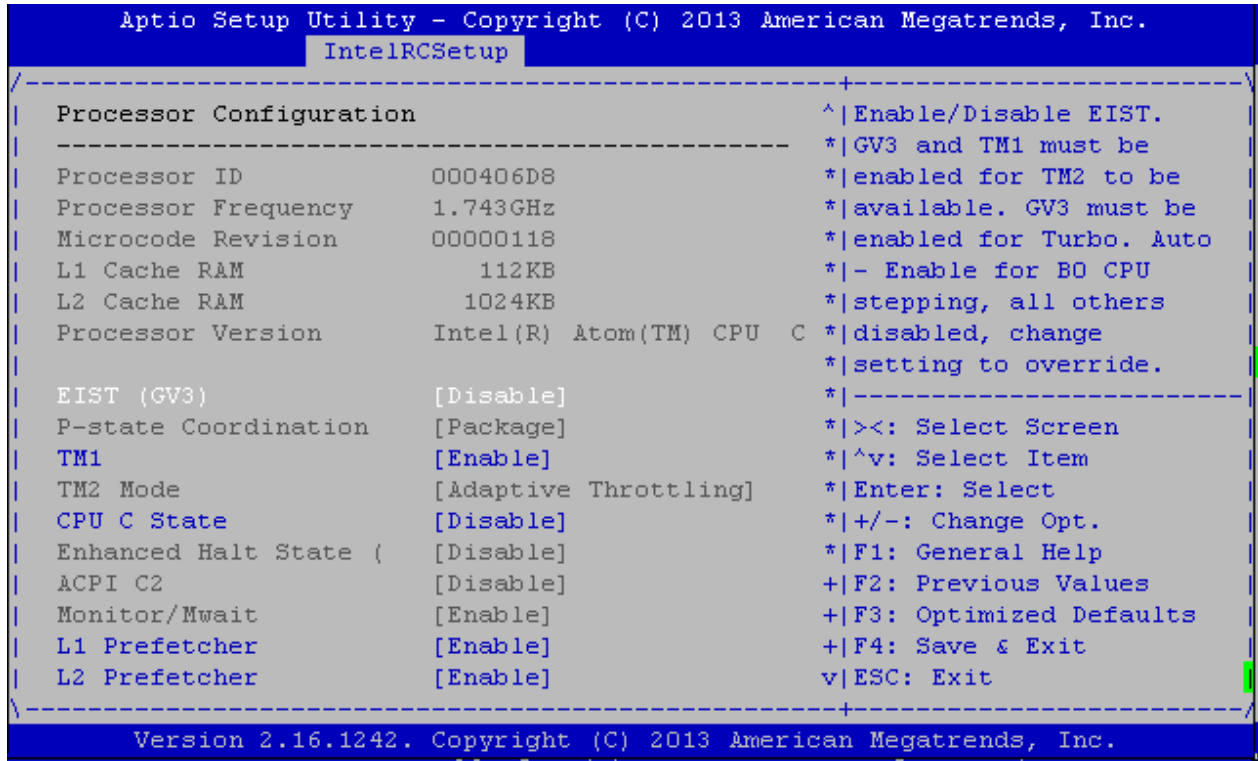

Item	Selection
Intel EIST (GV3)	Enable/disable the Enhanced Intel Speed- Step® technology (EIST)
TM1	The built-in thermal monitor protects the CPU from overheating. Enable or disable this feature.
CPU C State	CPU operating states (C-states) are the capability of an idle processor to turn off unused components to save power. Enable or disable or set it to automatically switch to any C-state number.
L1 Prefetcher	This option controls processor prefetching.
L2 Prefetcher	This option controls processor prefetching.
Max CPUID Value Limit	Allows legacy operating systems to boot even without support CPUs with extended CPUID functions. Select to enable or disable this function.
Execute Disable Bit	Select to enable or disable the No-Execution Page Protection Technology.
AES-NI	Enable or disable the Advanced Encryption Standard New Instructions
Active Processor Core	Select the number of processor cores to be active in each processor package.

North Bridge Chipset Configuration

It shows the memory information such as the total detected memory and memory frequency.

```
Aptio Setup Utility - Copyright (C) 2013 American Megatrends, Inc.
IntelRCSetup

-----
North Bridge Chipset Configuration
-----
---
Memory Information
MRC Version          1.0.0.33
Total Memory         4096 MB
Memory Frequency     DDR3 - 1333 MHz

|><: Select Screen
|^v: Select Item
|Enter: Select
|+/-: Change Opt.
|F1: General Help
|F2: Previous Values
|F3: Optimized Defaults
|F4: Save & Exit
|ESC: Exit

Version 2.16.1242. Copyright (C) 2013 American Megatrends, Inc.
```

South Bridge Chipset Configuration

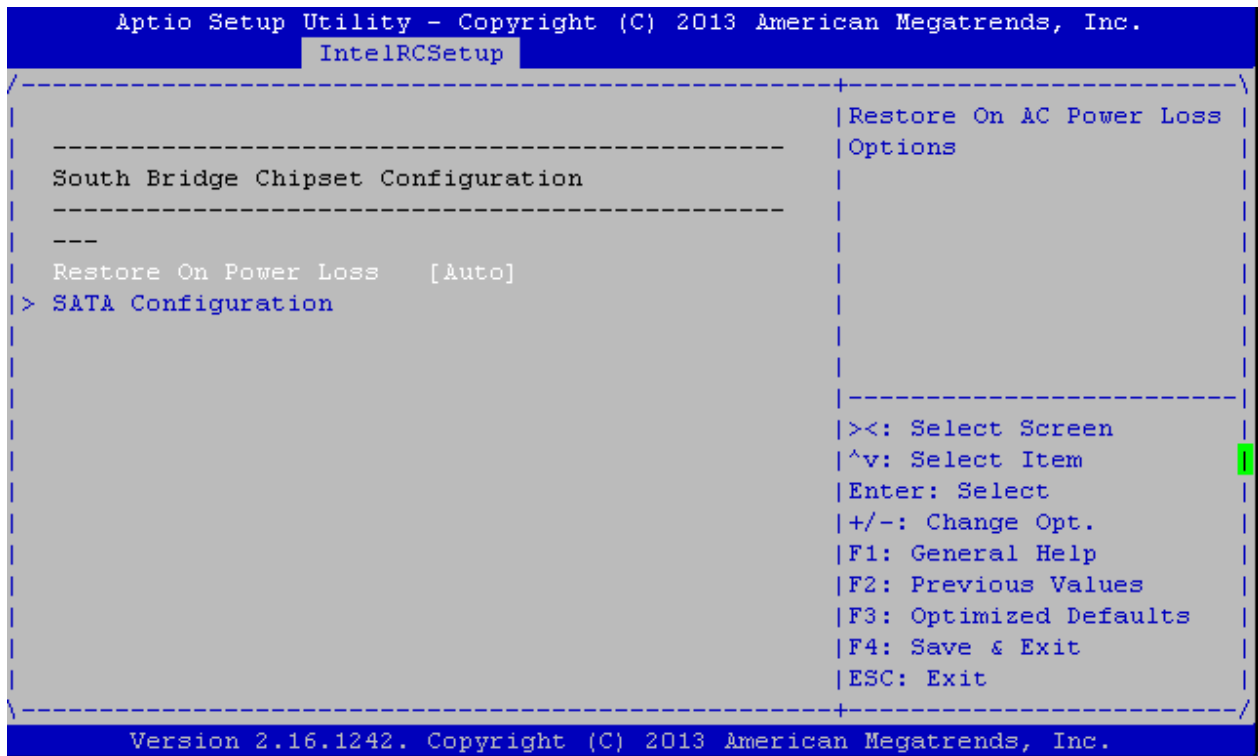

Restore on AC Power Loss

This option lets you set the state of the system when it has just recovered from a power outage.

The menu sets delay time for USB operations:

Item	Selection
Power Off	When setting to Power Off, the system goes into "off state" after an AC power interruption.
Power On	When setting to Power on, the system turns on automatically after a power interruption
Auto	When setting to Last State, the system goes into whatever the state was before the power interruption.

SATA Controllers Configuration

SATA Mode Selection

The system supports various SATA mode.

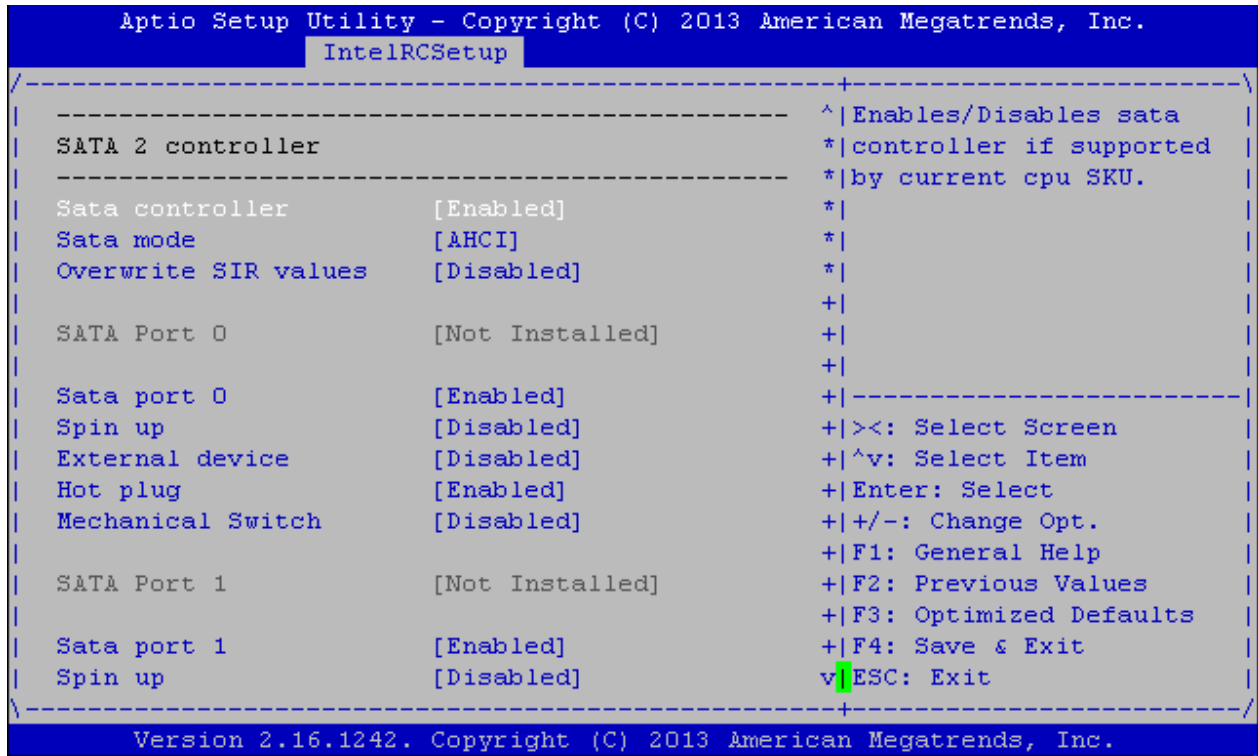

Item	Selection
IDE Mode	Set to IDE mode when you want to use the Serial-ATA hard disk drives as Parallel ATA physical storage devices.
AHCI Mode	Set to AHCI mode when you want the SATA hard disk drives to use the AHCI (Advanced Host Controller Interface). The AHCI allows the onboard storage driver to enable advanced SATA features that increases storage performance or workloads where multiple simultaneous read/write requests are outstanding, most often occurring in server-type applications (native command queuing). It also facilitates hot swapping.
Disable	Disable the SATA controller.

Serial ATA Port 0/1/2/3

Use this menu to configure specific SATA Port for all ports on the system.

Item	Selection
Staggered Spin-Up	Spin-up is a simple mechanism by which the storage subsystem controller can sequence hard disk drive initialization and spin-up. Set to control whether each specific drive will spin up.
External	Enable or disable external SATA connectivity.
Hot Plug	The AHCI of SATA provides hot-plug capability to allow drives to be added or removed with the PC running.
Mechanical Switch	Enable this option to support a mechanical presence switch attached to this port. Disable this option to not support a mechanical presence switch attached to this port.

Security Settings

Select Security Setup from the Setup main BIOS setup menu. All Security Setup options, such as password protection and virus protection, are described in this section. To access the sub menu for the following items, select the item and press **<Enter>**:

```

Aptio Setup Utility - Copyright (C) 2013 American Megatrends, Inc.
Main  Advanced  IntelRCSetup  Security  Boot  Save & Exit

-----
Password Description                                |Set Administrator
                                                    |Password
If ONLY the Administrator's password is set,
then this only limits access to Setup and is
only asked for when entering Setup.
If ONLY the User's password is set, then this
is a power on password and must be entered to
boot or enter Setup. In S/ Create New Password -\
have Administrator rights|
The password length must
in the following range:
Minimum length          3
Maximum length          20
Administrator Password
User Password
                                                    |><: Select Screen
                                                    |^v: Select Item
                                                    |Enter: Select
                                                    |+/-: Change Opt.
                                                    |F1: General Help
                                                    |F2: Previous Values
                                                    |F3: Optimized Defaults
                                                    |F4: Save & Exit
                                                    |ESC: Exit
-----
Version 2.16.1242. Copyright (C) 2013 American Megatrends, Inc.

```

Administrator Password

If you have set an administrator password, you should enter the administrator password for accessing the BIOS setup. Otherwise, you will only be able to see or change selected fields in the BIOS setup program.

User Password

If you have set a user password, you must enter the user password for booting and accessing the system; however, some functions may be disabled.

1. To set an Administrator/User password:
2. Select the option item and press Enter.
3. From the Create New Password box, key in a password, then press enter.
4. Confirm the password when prompted. To change an administrator password:
5. Select the option item and press Enter.
6. From the Enter Current Password box, key in the current password, then press enter.
7. From the Create New Password box, key in a new password, then press Enter.

Confirm the password when prompted.

To clear the administrator password, follow the same steps as in changing an administrator password, then press Enter when prompted to create/confirm the password.

Boot Configuration

In this screen, you will be able to configure the boot procedures and the related elements.

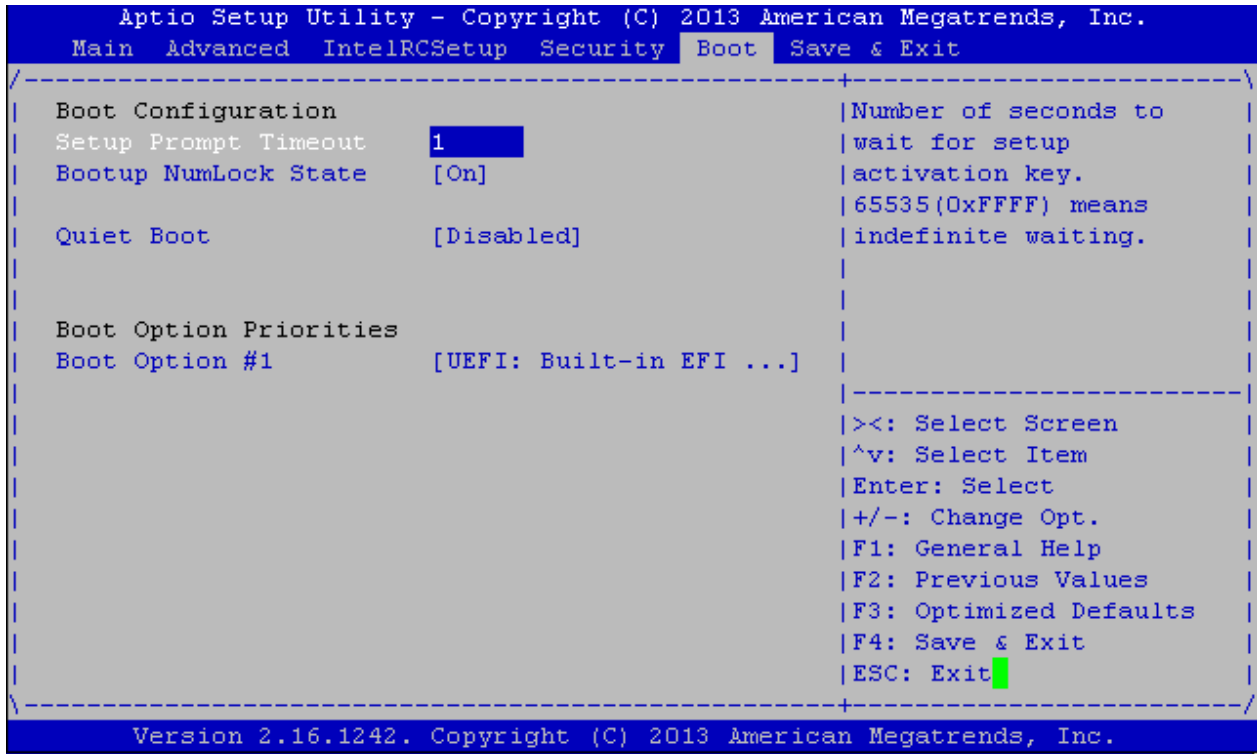

Item	Selection
Setup Prompt Timeout	Specify the number of seconds for the boot setup prompt to wait for user's intervention during the POST.
Bootup Num-Lock State	This option lets you enable or disable the function of the NumLock key.
Quiet Boot	Enabling this item allows the BIOS to suppress the message displayed during the POST.
Set Boot Priority	Use this screen to specify the order in which the system checks for the device to boot from.

Save and Exit

Select the Exit tab from the setup screen to enter the Exit BIOS Setup screen. You can display an Exit BIOS Setup option by highlighting it using the <Arrow> keys. The following table lists the options in this menu.

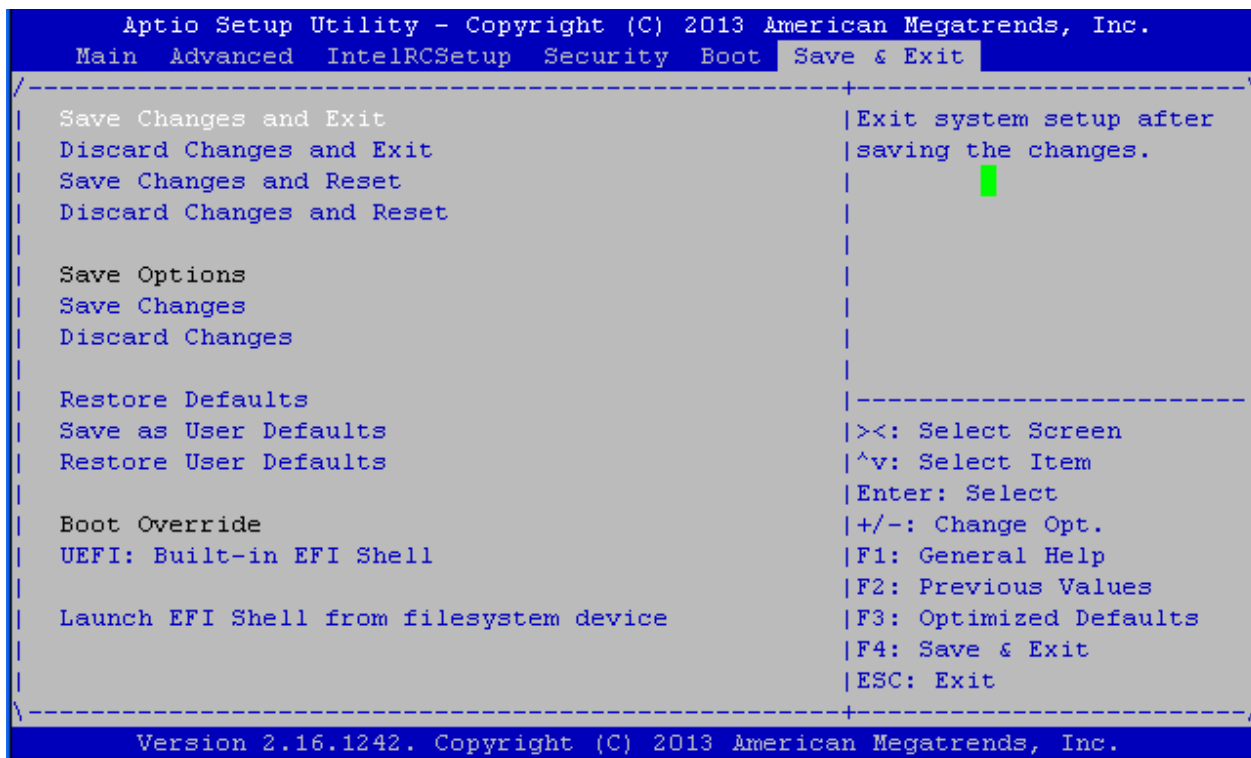

Item	Description
Saving Changes and Exit	Select this option to save changes and exit the BIOS menu. It will automatically reset if the changes made require rebooting the system to take effect.
Discard Changes and Exit	Select this option to discard changes and exit and BIOS menu to continue the booting process.
Save Changes and Reset	When you have completed the system configuration changes, select this option to leave setup and reboot the computer so the new system configuration parameters can take effect.
Discard Changes and Reset	This option allows you to discard the selections you made and restore the previously saved values. After selecting this option, a confirmation appears. Select Yes to discard any changes and load the previously saved values.
Save Changes	Save your changes
Discard Changes	Discard changes
Restore Defaults	Restore to factory defaults
Save as User Defaults	Save all of your changes as a user default setting.
Restore User Defaults	Loads your saved user default setting.
Boot Override	This section of the Boot Menu allows booting from a specific device immediately. Therefore you should see an entry for all bootable devices.
Launch EFI Shell from file system device	This option allows you to attempt to launch the EFI Shell application (shellx64. efi) from one of the available file system devices.

APPENDIX A: PROGRAMMING WATCHDOG TIMER

A watchdog timer is a piece of hardware that can be used to automatically detect system anomalies and reset the processor in case there are any problems. Generally speaking, a watchdog timer is based on a counter that counts down from an initial value to zero. The software selects the counter's initial value and periodically restarts it. Should the counter reach zero before the software restarts it, the software is resumed to be malfunctioning and the processor's reset signal is asserted. Thus, the processor will be restarted as if a human operator had cycled the power.

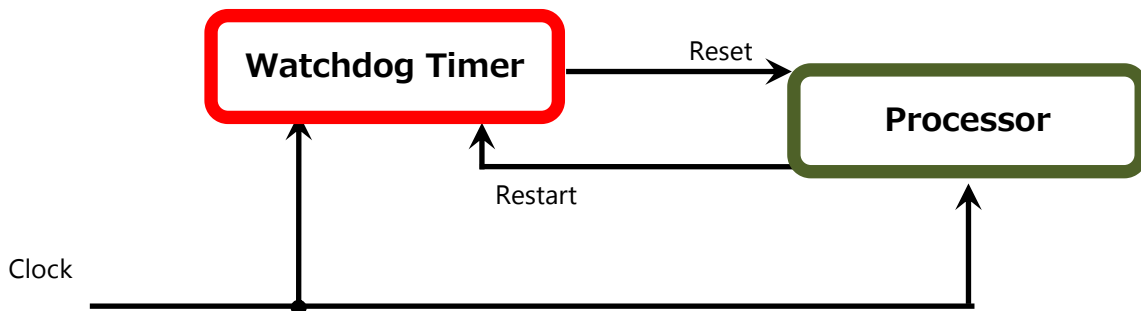

To execute the utility: enter the number of seconds to start countdown before the system can be reset. Press **start** to start the counter and stop to stop the counter.

```
wd_tst --swt xxx (Set Watchdog Timer 1-255 seconds)
```

```
wd_tst[*] --start (Start Watchdog Timer)
```

```
wd_tst --stop (Stop Watchdog Timer)
```

- For a reference utility that contains sample code for watchdog function programming, please visit <http://www.lannerinc.com/support/download-center/drivers>, enter the product category and download the utility package.

APPENDIX B: SETTING UP CONSOLE REDIRECTIONS

Console redirection lets you monitor and configure a system from a remote terminal computer by re-directing keyboard input and text output through the serial port. The following steps illustrate how to use this feature. The BIOS of the system allows the redirection of the console I/O to a serial port. With this configured, you can remotely access the entire boot sequence through a console port.

1. Connect one end of the console cable to console port of the system and the other end to the serial port of the Remote Client System.
2. Configure the following settings in the BIOS Setup menu:
BIOS > Advanced > Serial Port Console Redirection > Console Redirection Settings, select **115200** for the Baud Rate, **None** for Flow control, **8** for the Data Bit, **None** for Parity Check, and **1** for the Stop Bit.
3. Configure console redirection related settings on the client system. You can use a terminal emulation program that features communication with serial COM ports such as *TeraTerm* or *Putty*. Make sure the serial connection properties of the client conform to those for the server.

APPENDIX C: PROGRAMMING GENERATION 2 LAN BYPASS

Lanner Generation 2 Bypass

Lanner Generation 2 bypass is configured through the BIOS menu as shown below:

```

Aptio Setup Utility - Copyright (C) 2013 American Megatrends, Inc.
Main  Advanced  IntelRCSetup  Security  Boot  Save & Exit
-----
| PXE Function          [Disabled]          | Generation 2 Lan Bypass
|> Super IO Configuration | Parameters
|> W83627DHG HW Monitor  |
|> Serial Port Console Redirection |
|> Generation 2 Lan Bypass Configuration |
|> USB Configuration     |
|
|
|-----|
|><: Select Screen
|^v: Select Item
|Enter: Select
|+/-: Change Opt.
|F1: General Help
|F2: Previous Values
|F3: Optimized Defaults
|F4: Save & Exit
|ESC: Exit
|-----|
Version 2.16.1242. Copyright (C) 2013 American Megatrends, Inc.

```

```

Aptio Setup Utility - Copyright (C) 2013 American Megatrends, Inc.
Advanced
-----
| Generation 2 Lan Bypass Configuration | Enable/Disable LAN3-4
|-----| Runtime Bypass
| On Board Lan Bypass Configuration |
| LAN3-4 Runtime Bypass [Disabled] |
| LAN3-4 System Off Byp [Enabled] |
|
| LAN5-6 Runtime Bypass [Disabled] |
| LAN5-6 System Off Byp [Enabled] |
|
|-----|
|><: Select Screen
|^v: Select Item
|Enter: Select
|+/-: Change Opt.
|F1: General Help
|F2: Previous Values
|F3: Optimized Defaults
|F4: Save & Exit
|ESC: Exit
|-----|
Version 2.16.1242. Copyright (C) 2013 American Megatrends, Inc.

```

There are two ways to enable the bypass on the system:

1. The LAN bypass can be turned on or off in two system states, i.e., power on (**Runtime Bypass**) and power off (**System Off Bypass**). The following are the illustration of the possibilities of LAN bypass configuration with respect to both power-on and power-off states.

System Status \ Bypass settings in the BIOS	Runtime LAN Bypass for Module 1		Power off LAN Bypass for Module 1
	Enabled	Disabled	
Power on	Bypass	Non-Bypass	Enabled
Power off	Bypass	Bypass	

System Status \ Bypass settings in the BIOS	Runtime LAN Bypass for Module 1		Power off LAN Bypass for Module 1
	Enabled	Disabled	
Power on	Non-Bypass	Non-Bypass	Disabled
Power off	Non-Bypass	Non-Bypass	

2. A watchdog timer can be used to control the LAN Bypass function dynamically by programming. Lanner also provides sample code for bypass control with WDT via programming. For a reference utility that contains sample code for LAN Bypass function programming, please contact Lanner’s technical support.
 - ▶ For thorough implementation information of Lanner Bypass and Watchdog functionalities, go to Lanner Support website at <http://www.lannerinc.com/category/1202-network-appliances> to download Lanner Bypass Implementation Manual.
 - ▶ For a description of the physical LAN ports equipped with this function, refer to Front Panel in Chapter 1: Product Overview.

APPENDIX D: INSTALLING INTEL QUICKASSIST SOFTWARE FOR LINUX

The FW-7551SE platform incorporates Intel QuickAssist Technology, which includes acceleration modules that are accessed via Intel QuickAssist software. The Intel QuickAssist software also enables the acceleration modules to be easily accessed by open source software such as OpenSSL. The Intel QuickAssist Technology features the acceleration to the following crypto functions:

- Symmetric Cryptographic Functions
 - Cipher Operations
 - Hash/Authenticate Operation
 - Cipher-Hash Combined Operation
 - Key Derivation Operation
- Public Key Functions
 - RSA Operation
 - Diffie-Helman Operation
 - Digital Signature Standard Operation
 - Key Derivation Operation
 - Elliptic Curve Cryptography: ECDSA* and ECDH*

We provide an abstract version of the Intel IntelR Atom™ Processor C2000 Product Family for Communications Infrastructure Software for Linux* Getting Started Guide (No. 518013). In this abstract version of Getting Started guide, it illustrates how to quickly get up and running with Fedora and **Intel®Atom™ Processor C2000 Product Family for Communications Infrastructure Software for Linux Software**. Refer to the attached PDF file for more information.

APPENDIX E: TERMS AND CONDITIONS

Warranty Policy

1. All products are under warranty against defects in materials and workmanship for a period of one year from the date of purchase.
2. The buyer will bear the return freight charges for goods returned for repair within the warranty period; whereas the manufacturer will bear the after service freight charges for goods returned to the user.
3. The buyer will pay for the repair (for replaced components plus service time) and transportation charges (both ways) for items after the expiration of the warranty period.
4. If the RMA Service Request Form does not meet the stated requirement as listed on "RMA Service," RMA goods will be returned at customer's expense.
5. The following conditions are excluded from this warranty:
 - ▶ Improper or inadequate maintenance by the customer
 - ▶ Unauthorized modification, misuse, or reversed engineering of the product
 - ▶ Operation outside of the environmental specifications for the product.

RMA Service

Requesting an RMA#

1. To obtain an RMA number, simply fill out and fax the "RMA Request Form " to your supplier.
2. The customer is required to fill out the problem code as listed. If your problem is not among the codes listed, please write the symptom description in the remarks box.
3. Ship the defective unit(s) on freight prepaid terms. Use the original packing materials when possible.
4. Mark the RMA# clearly on the box.



Note: Customer is responsible for shipping damage(s) resulting from inadequate/loose packing of the defective unit(s). All RMA# are valid for 30 days only; RMA goods received after the effective RMA# period will be rejected.

RMA Service Request Form

When requesting RMA service, please fill out the following form. Without this form enclosed, your RMA cannot be processed.

RMA No:	Reasons to Return: <input type="checkbox"/> Repair(Please include failure details) <input type="checkbox"/> Testing Purpose		
Company:	Contact Person:		
Phone No.	Purchased Date:		
Fax No.:	Applied Date:		
Return Shipping Address: _____			
Shipping by: <input type="checkbox"/> Air Freight <input type="checkbox"/> Sea <input type="checkbox"/> Express _____			
<input type="checkbox"/> Others: _____			
Item	Model Name	Serial Number	Configuration

Item	Problem Code	Failure Status

***Problem Code:**

- | | | | |
|------------------------|------------------------------|--------------------|--------------------------|
| 01:D.O.A. | 07: BIOS Problem | 13: SCSI | 19: DIO |
| 02: Second Time R.M.A. | 08: Keyboard Controller Fail | 14: LPT Port | 20: Buzzer |
| 03: CMOS Data Lost | 09: Cache RMA Problem | 15: PS2 | 21: Shut Down |
| 04: FDC Fail | 10: Memory Socket Bad | 16: LAN | 22: Panel Fail |
| 05: HDC Fail | 11: Hang Up Software | 17: COM Port | 23: CRT Fail |
| 06: Bad Slot | 12: Out Look Damage | 18: Watchdog Timer | 24: Others (Pls specify) |

Request Party

Confirmed By Supplier

Authorized Signature / Date

Authorized Signature / Date