

11 May 2020

# 1570R APPLIANCE

## R80.20.05

Getting Started Guide

DRAFT

# Check Point Copyright Notice

© 2020 Check Point Software Technologies Ltd.

All rights reserved. This product and related documentation are protected by copyright and distributed under licensing restricting their use, copying, distribution, and decompilation. No part of this product or related documentation may be reproduced in any form or by any means without prior written authorization of Check Point. While every precaution has been taken in the preparation of this book, Check Point assumes no responsibility for errors or omissions. This publication and features described herein are subject to change without notice.

## RESTRICTED RIGHTS LEGEND:

Use, duplication, or disclosure by the government is subject to restrictions as set forth in subparagraph (c) (1)(ii) of the Rights in Technical Data and Computer Software clause at DFARS 252.227-7013 and FAR 52.227-19.

## TRADEMARKS:

Refer to the [Copyright page](#) for a list of our trademarks.

Refer to the [Third Party copyright notices](#) for a list of relevant copyrights and third-party licenses.

DRAFT

# Important Information



## Latest Software

We recommend that you install the most recent software release to stay up-to-date with the latest functional improvements, stability fixes, security enhancements and protection against new and evolving attacks.



## Certifications

For third party independent certification of Check Point products, see the [Check Point Certifications page](#).



## Check Point R80.20.05

For more about this release, see the R80.20.05 [home page](#).



## Latest Version of this Document

Open the latest version of this [document in a Web browser](#).

Download the latest version of this [document in PDF format](#).



## Feedback

Check Point is engaged in a continuous effort to improve its documentation.

[Please help us by sending your comments.](#)

## Revision History

Date	Description
11 May 2020	First release of this document

# Table of Contents

---

<b>Introduction</b> .....	<b>6</b>
<b>Shipping Carton Contents</b> .....	<b>7</b>
<b>Connecting the Cables</b> .....	<b>8</b>
<b>Setting up the Appliance</b> .....	<b>9</b>
Mounting Options .....	9
<b>Using DC Power</b> .....	<b>14</b>
Field Wiring for DC Mains .....	15
<b>First Time Deployment Options</b> .....	<b>17</b>
<b>Appliance Diagrams and Specifications</b> .....	<b>18</b>
Front Panel .....	21
Back Panel .....	24
Side Panel .....	26
<b>Using the First Time Configuration Wizard</b> .....	<b>29</b>
Welcome .....	30
Zero Touch .....	30
Authentication Details .....	32
Appliance Date and Time Settings .....	34
Appliance Name .....	35
Security Policy Management .....	36
Internet Connection .....	37
Local Network .....	40
Wireless Network .....	42
Administrator Access .....	44
Appliance Registration .....	46
Security Management Server Authentication .....	49
Security Management Server Connection .....	50
Software Blade Activation .....	52
Summary .....	53
<b>Zero Touch Cloud Service</b> .....	<b>54</b>
<b>USB Drive</b> .....	<b>55</b>

---

<b>Health and Safety Information</b> .....	<b>56</b>
Information sur la Santé et la Sécurité .....	64
<b>Support</b> .....	<b>71</b>

DRAFT

# Introduction

Thank you for choosing Check Point's Internet Security Product Suite. Check Point products provide your business with the most up to date and secure solutions available today.

Check Point also delivers worldwide technical services including educational, professional, and support services through a network of Authorized Training Centers, Certified Support Partners, and Check Point technical support personnel to ensure that you get the most out of your security investment.

For more information about the appliance, see the *Check Point 1500 Appliance series Administration Guide*.

For more technical information, go to [Check Point Support Center](#).

DRAFT

# Shipping Carton Contents

Item	Quantity	Description
Appliance	1	1570R appliance
LAN cable	1	1.8m - RJ45 to RJ45, CAT5e, shielded, STP, black color
Console cable	1	1m, USB type-C to USB-2.0 type-A, black color
Power adapter	1	AC to 12VDC desktop, 40W, black color
Power cord for adapter	1	Plug types: US, UK, EU and AUS/NZ, India, China, Japan
Rubber feet	4	Assembled on the appliance
Wall mount kit	1	Includes drilling hole location sticker. Screws: M4*6, truss screw
Mini USB WiFi dongle	1	2.4GHz, commercial grade (exclude WiFi-LTE)
DIN rail kit	1	Brackets + screws
Antenna	3 2 1	WiFi Antenna RP-SMA type, black color (WiFi models only) LTE Antenna RP-SMA type, black color (for LTE models only) GPS Active-Antenna RP-SMA type, black color
Industrial power supply	1	Power adapter AC to 12VDS desktop, TBD xxW, black color, industrail grade
IP42 kit	1	IP42 kit (front cover, WiFi Antenna - if required water proof)
Guides	1	<i>Check Point 1570R Appliance Quick Start Guide</i>
License Agreement	1	End user license agreement

# Connecting the Cables

1. Connect the power supply unit to the appliance and to a power outlet.

The appliance is turned on when the power supply is connected.

2. When the appliance is turned on, the Power LED on the front panel lights up in red for a short period.

The LED then turns blue and starts to blink. This shows a boot is in progress and firmware is being installed.

When the LED turns a solid blue, the appliance is ready for login.

**Note** - The LED is red if there is an alert or error.

3. Connect the standard network cable to the LAN1 port on the back panel of the appliance and to the network adapter on your PC.
4. **Connect the console cable to the console port on the back of the appliance, and to a USB port on a supported terminal.**

- a. Set the Flow control to **None**.

- b. To get the console driver, click: <https://www.silabs.com/products/development-tools/software/usb-to-uart-bridge-vcp-drivers>

- c. Verify the MD5 and SHA256 are the following:

- MD5 - c0b27c9b0f3a3ed53927a4857853a2cb

- SHA 256 -

- 5d8fa117cd499a50cab895f35d50d108a61e80b6a3f6d2ecbffa8949085b8f2e

5. **If you use an external modem:**

Connect the Ethernet cable to the WAN port on the appliance back panel and plug it into your external modem or router's PC/LAN network port. The WAN Link LED on the appliance front panel lights up when the Ethernet is connected



# Setting up the Appliance

1. Remove the Check Point 1570R appliance from the shipping carton and place it on a tabletop.  
For other mounting options, see below.
2. **Optional** - Remove the transparent protective sticker from the front panel of the appliance.
3. Identify the network interface marked as LAN1. This interface is preconfigured with the IP address 192.168.1.1.

## Mounting Options

- Desktop - No special hardware or mounting instructions necessary.
- DIN rail kit - Attaches to either back panel (for 1570R Wired) or bottom panel (for 1570R Wired and Wired-LTE)
- Wall mount - Attached from bottom panel.

DRAFT

In the 1570R Wired model, the DIN rail mount holes are located on the back panel or bottom:

**Back**

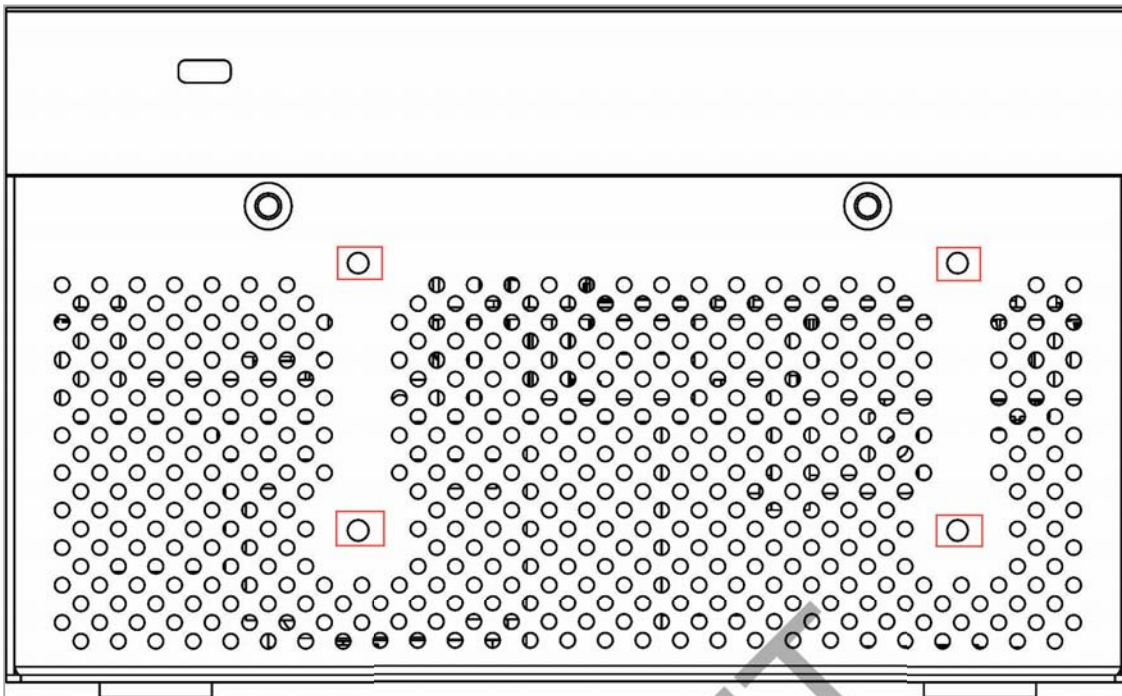

Bottom

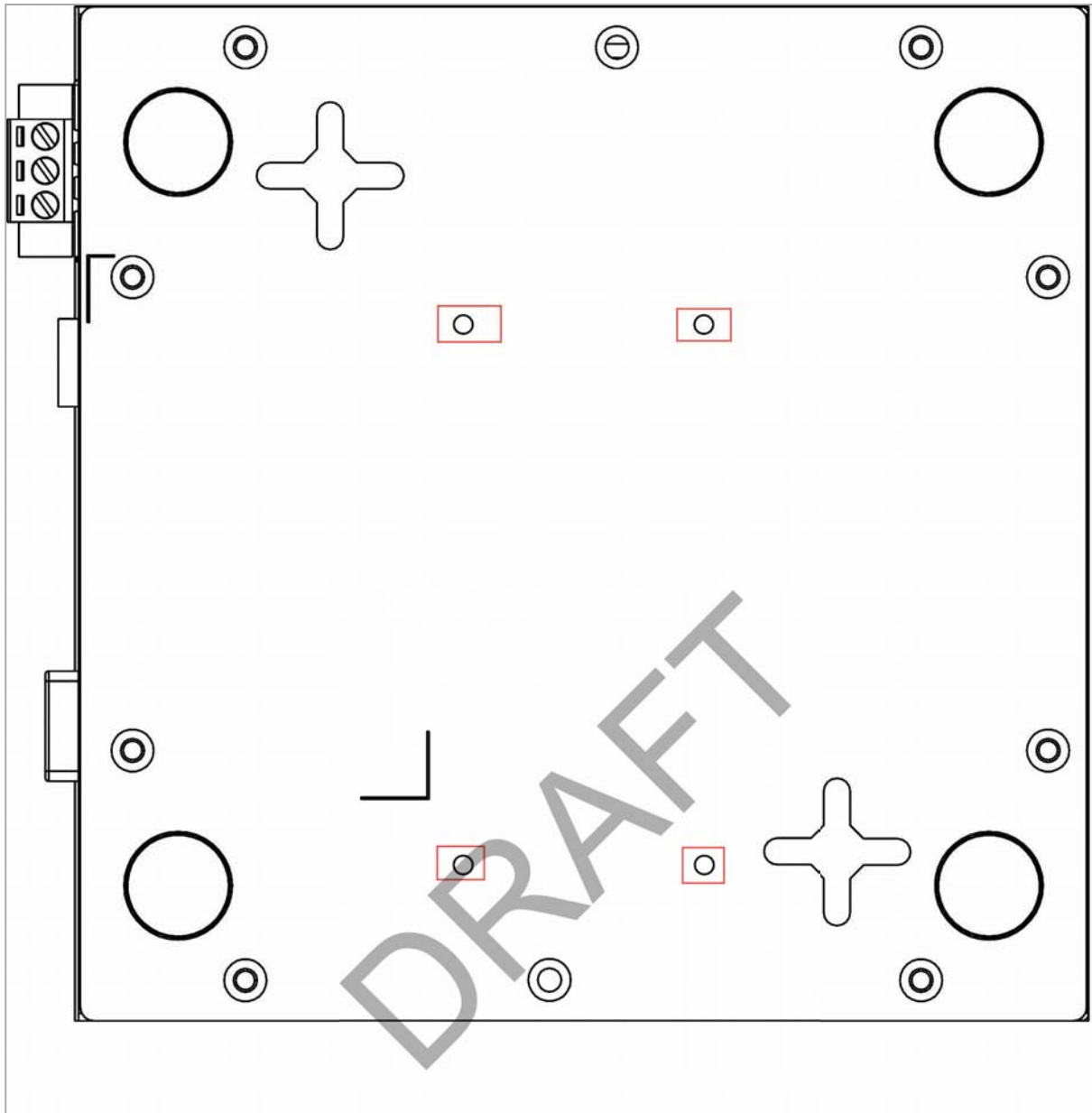

In the 1570R WiFi-LTE model, use the DIN rail mount holes located on the bottom panel :

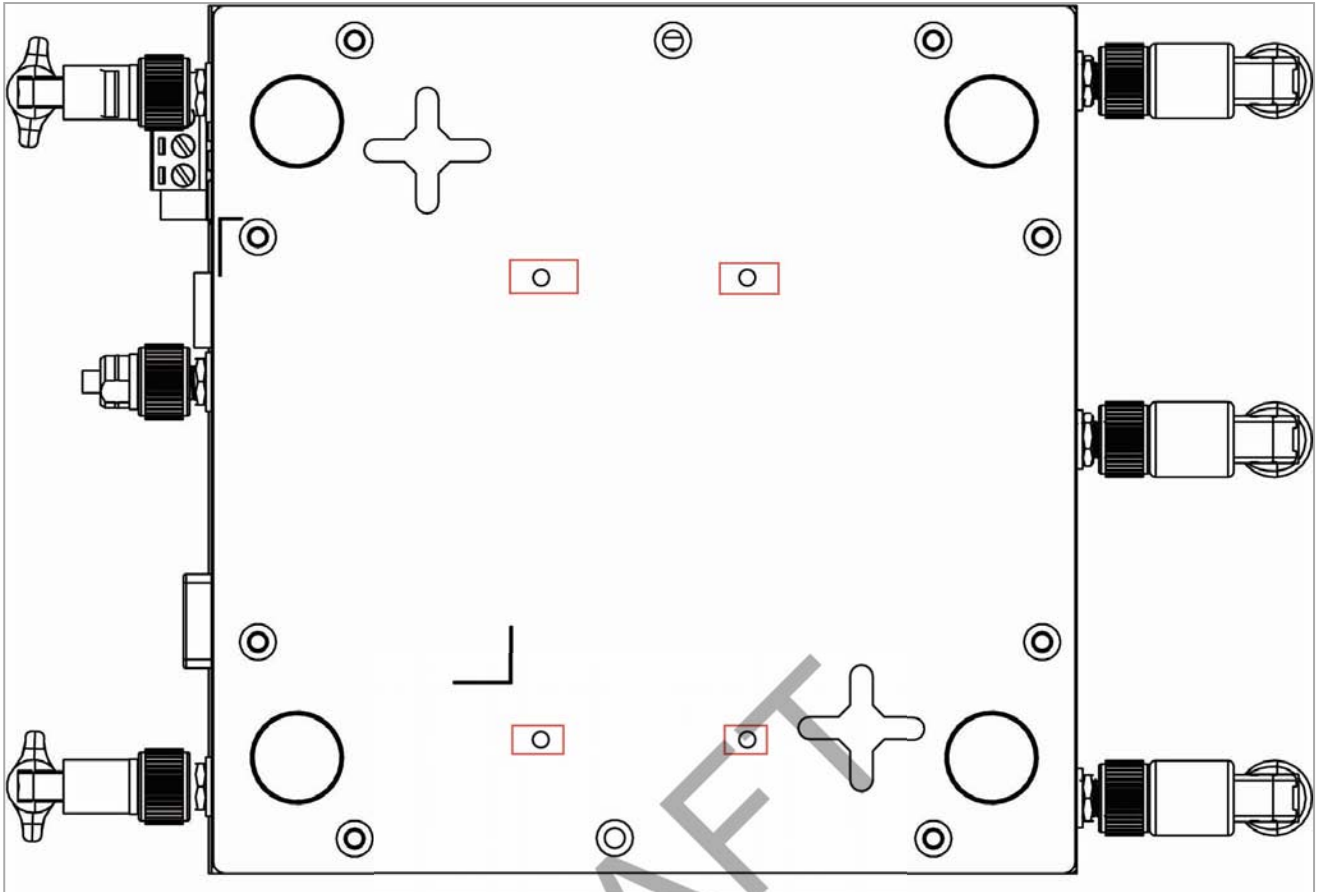

**To mount the appliance using the DIN rail kit:**

1. Attach the DIN rail kit (with screws M3x5x4) to either the back or bottom panel (depends on model and preference).
2. Attach the DIN rail kit to the desired surface.

**To mount the appliance to the wall:**

1. Place the wall-mount sticker on the wall and drill two holes for the screws.
2. Attach the 2 screws in the accessory kit (M4\*6) to the wall.
3. Mount the appliance and verify the 2 screws are fastened well to the appliance.

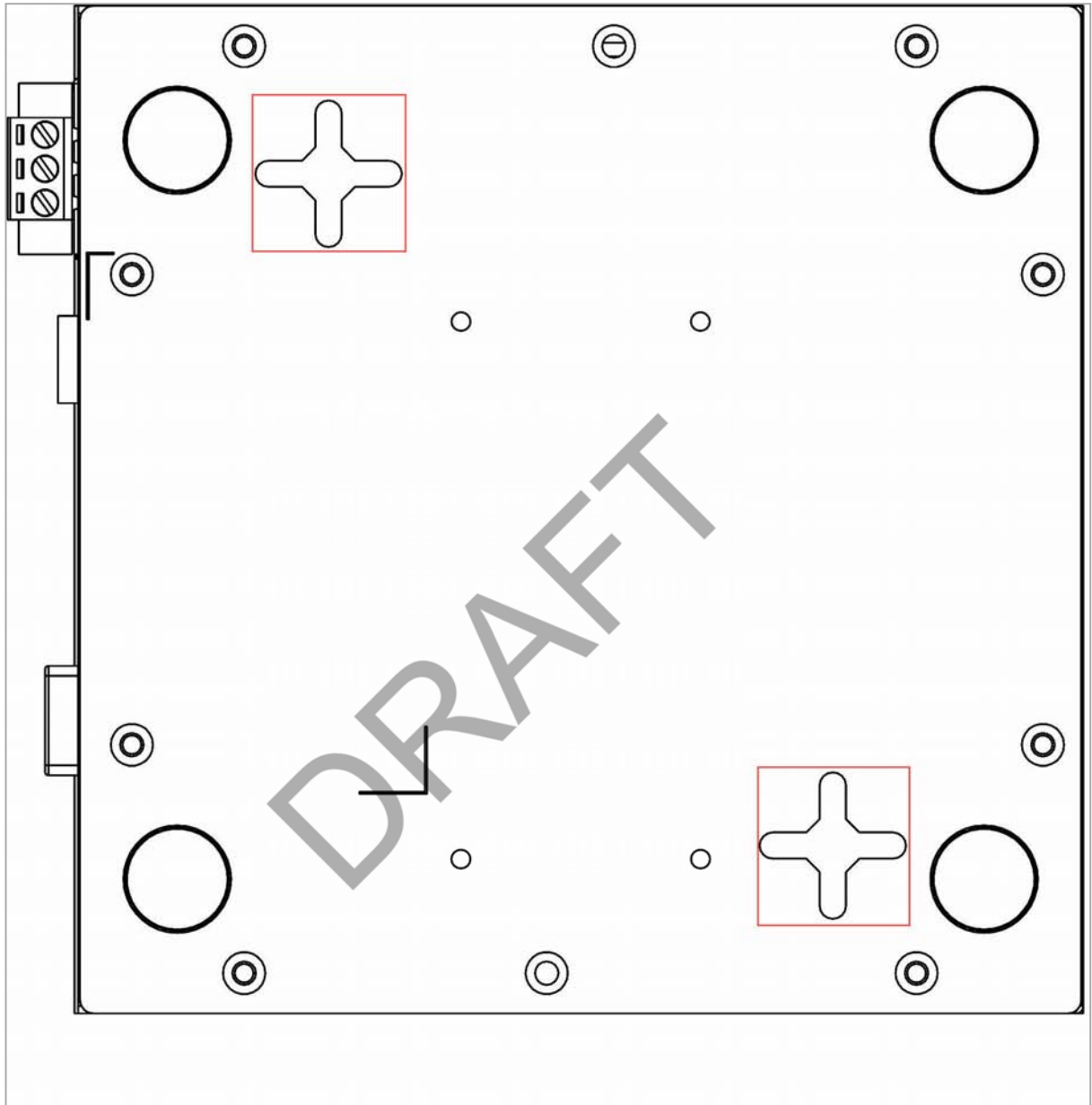

# Using DC Power

## To use the DC terminal block:

1. Insert the positive and negative wires into the V+ and V- contacts on the terminal block connector.
2. Tighten the wire-clamps screws to prevent the DC wires coming loose.

Before wiring the device, make sure that:

- The terminal block is suitable for 18 AWG (6A). Torque value is 5 lb-in.
- The cross sectional area of the earthing conductors should be at least 18AWG.
- The temperature rating of the input connection cable should be higher than 95°C.
- Based upon the product specification provided by the manufacturer, this unit is intended to be supplied by an UL Listed power supply suitable for use at T<sub>ma</sub> 75 degree C, altitude 5000m and rated 12V-72Vdc, -48Vdc, 2.3A ; 12Vdc, 2.6A for V-81WLR series; 12V-72Vdc, -48Vdc, 12Vdc, 2.1A for V-81R series. IPlease contact Check Point for more information or if you require further assistance.

## To connect DC power to the equipment:

1. Turn OFF all power sources and equipment that will be attached to this appliance.
2. Connect protective earthing first, with at least 18 AWG G/Y color PE conductor, diameter 3.5mm min., screw type PE terminal, and a Spring/Star washer to provide satisfactory locking.
3. Attach signal cables to the appliance.
4. Attach the power cords to the appliance.

For DC systems, make sure the polarity is 12-72V, or -48VDC connections.

5. Attach the signal cables to other devices.
6. Connect the power cords to their sources.
7. Turn ON all the power sources.

## To disconnect DC power from the Equipment:

1. Turn OFF all power sources and equipment that are attached to this appliance.

Disconnect DC power sources at the breaker panel or by turning off the power source. Then remove the DC cables.

2. Remove the signal cables from the connectors.
3. Remove the protective earthing conductor from the devices.

## Tolerance

This equipment is intended for power supplied by DC mains. There is no tolerance for supplying voltage under 12-72Vdc and -48Vdc.

# Field Wiring for DC Mains

Only trained service personnel are authorized to install and remove the  $\pm 12 - \pm 72$  volt DC Mains, and make the connections to and disconnections from the  $\pm 12 - \pm 72$  volt DC Mains. The customer is responsible for ensuring that only trained service personnel install or remove the  $\pm 12 - \pm 72$  volt power cable.

See the IPC documentation for detailed instructions for installing DC Power supplies in the IPC.

## Safety Statement

Power supplies to the IPC must be with the same power rating or wattage to ensure that the IPC will operate correctly.



### Caution

#### To reduce the risk of electric shock or energy hazards:

- It is the customer's responsibility to supply the necessary power cable.
- Use a circuit breaker that is rated at 20 amps.
- Use 0.75 mm<sup>2</sup> (18 AWG) single copper wire, or 0.75 mm<sup>2</sup> (18 AWG) Multi-core copper at min. 90° C.
- Strip the wire, and leave the bare lead approximately 10mm for terminals connection.
- Torque the wiring-terminal screws to 0.60 newton-meters (5 inch-pounds).
- Wire strip length is 4-4 mm.
- For supply connections, use wires suitable for at least 90° C.
- If the power source requires ring terminals, you must use a crimping tool to install the ring terminals to the power cord wires. The ring terminals must be UL approved and must accommodate the wire that is described above.

This equipment is designed to permit the connection the earthed conductor of the DC supply circuit to the earthed conductor at the equipment. If this connection is made, all of the following conditions must be met:

- This equipment shall be connected directly to the DC supply system earthed electrode conductor or to a bonding jumper from an earthing terminal bar or bus to which the DC supply system earthed electrode conductor is connected.
- This equipment shall be located in the same immediate area (such as, adjacent cabinets) as any other equipment that has a connection between the earthed conductor of the same DC supply circuit and the earthed conductor, and also the point of earthed of the DC system. The DC system shall not be earthed elsewhere.
- The DC supply source shall be located within the same premises as this equipment.
- Switching or disconnecting devices shall not be in the earthed circuit conductor between the DC source and the point of connection of the earthed electrode conductor.



### Danger

Electrical current from power, telephone, and communication cables is hazardous.

**To avoid a shock hazard:**

- Do not connect or disconnect any cables or perform installation, maintenance, or reconfiguration of this product during an electrical storm.
- Connect all power cords to properly wired sources.
- Connect to properly wired power sources any equipment that will be attached to this product.
- When possible, use one hand only to connect or disconnect signal cables.
- Never turn on any equipment when there is evidence of fire, water, or structural damage.
- Disconnect the attached DC power sources before you open the device covers, unless you are instructed otherwise in the installation and configuration procedures.
- Connect and disconnect cables as described when you install, move, or open covers on this product or attached devices.

DRAFT



# First Time Deployment Options

There are different options for first time deployment of your gateways:

- ["Using the First Time Configuration Wizard" on page 29](#)
- ["Zero Touch Cloud Service" on page 54](#)
- ["USB Drive" on page 55](#)

DRAFT

# Appliance Diagrams and Specifications

This section describes the different features in the front, back, and side panels of these 1570R models:

- Wired
- LTE-WiFi

**Note** - Depending on which model appliance you have, some of the specifications below may vary.

DRAFT

Wired

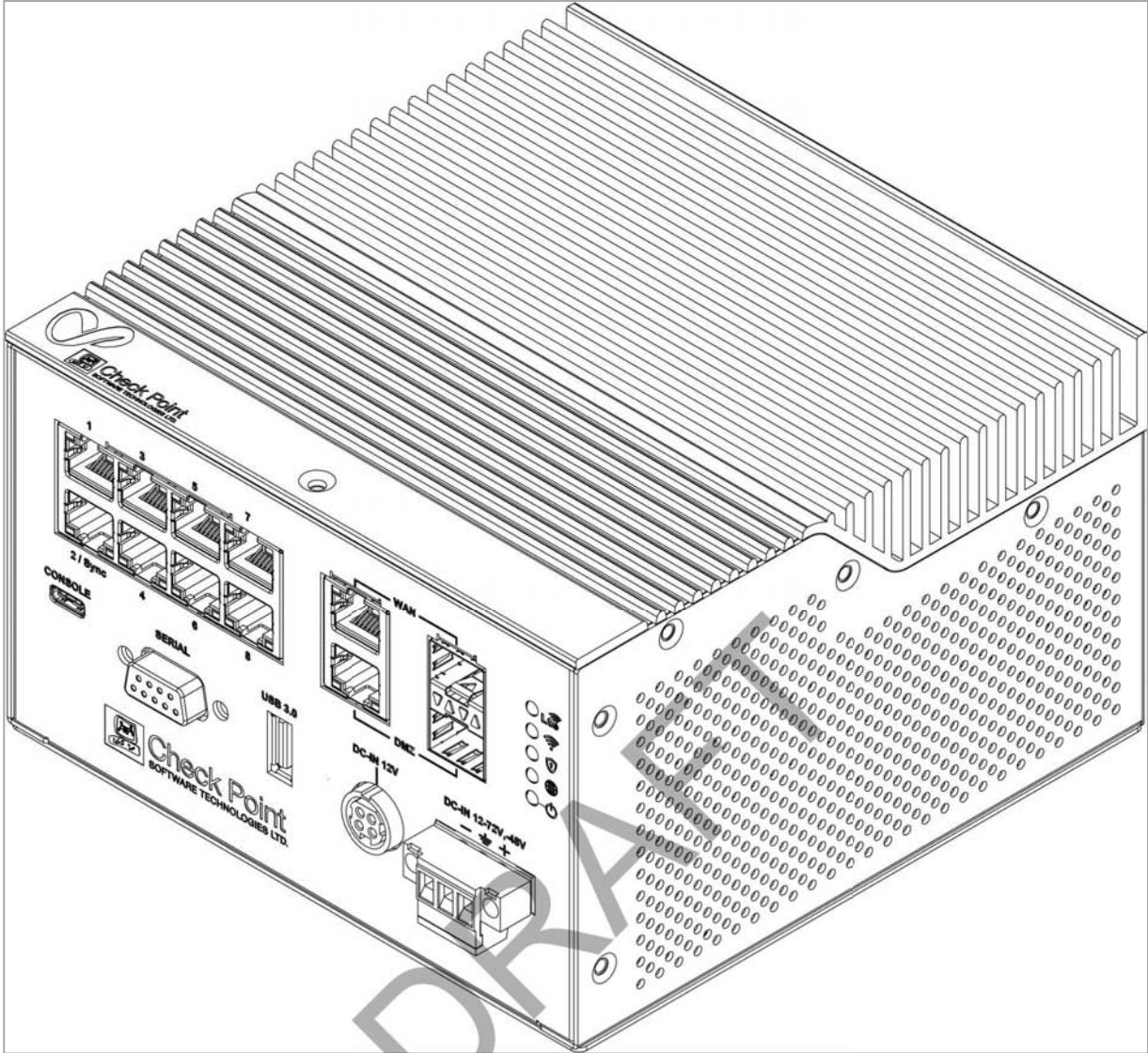

WiFi-LTE

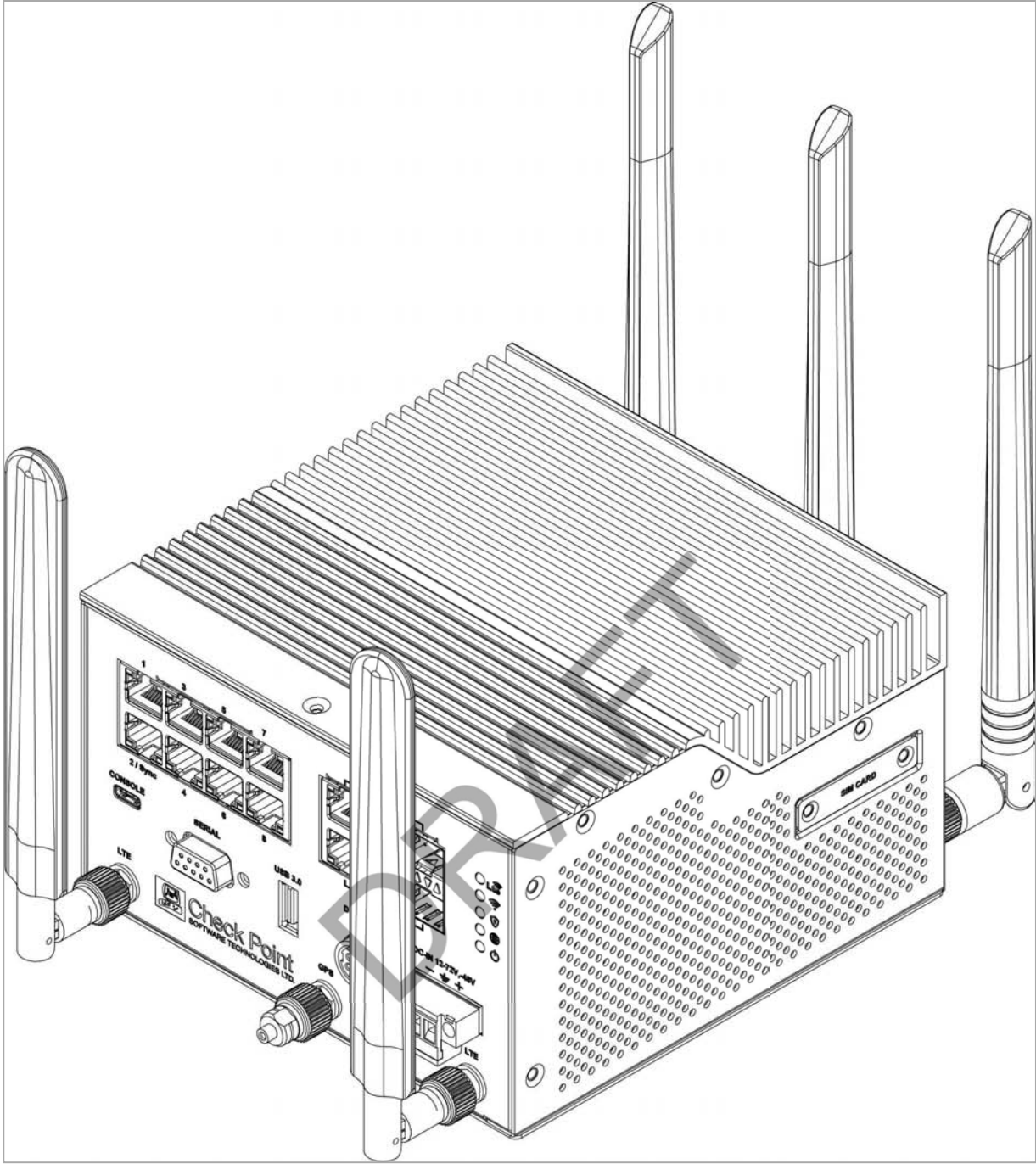

# Front Panel

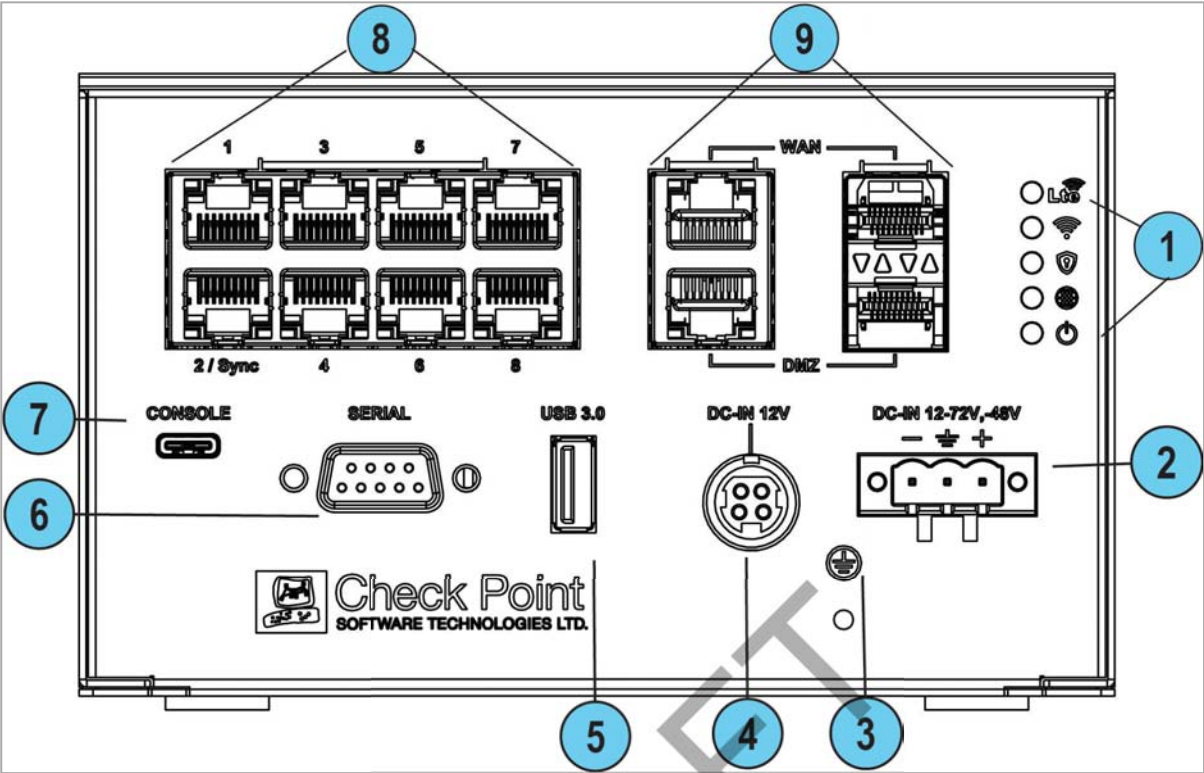

**Note** - There is only one set of LEDs. These LEDs show different colors depending on what activity is occurring.

Key	Item	Description
1	LEDs	From top to bottom: <ul style="list-style-type: none"> <li>■ LTE-WiFi</li> <li>■ WiFi</li> <li>■ Management</li> <li>■ Internet</li> <li>■ Power</li> </ul>
2	DC input	Connects to the power supply unit's cable.
3	Ground screw	Protective earthing terminal.
4	Power cord socket	Plug the power adapter cord in here.
5	USB port 3.0	USB port 3.0 for SW download and external dongle as WiFi.

Key	Item	Description
6	Serial port	Plug in the serial cable here.
7	Console	Plug in the serial console cable here. Baud rate: 115200.
8	LAN ports	LAN ports 1-8. 10/100/1000MbE
9	WAN and DMZ ports	Two WAN/DMZ combo ports The DMZ is a combo port of SFP and RJ45 (on the right). Only one can operate a time once plugged in and connected. 10/100/1000MbE

The Management LED shows the status of the retries mechanism:

Action	Management LED Activity
Zero Touch is running.	Blinks red (slowly)
Successfully connected to Zero Touch Cloud Server and saved the deployment script.	Blinks red (rapidly)
Zero Touch process is completed. SMP activation is not needed.	LED off
Activation sleeping time.	Blinks blue (slowly)
Reactivation.	Blinks blue (rapidly)
SMP is connected.	Solid blue.
SMP mode is off.	LED off
Gateway failed to connect to the SMP and will exit from the retry script.	Constant red.

Wait times before retry:

Failure	Waiting Time
1st	2 minutes
2nd	4 minutes
3rd	8 minutes
4th	16 minutes
Subsequent	Retries every 16 minutes until Cloud Services are successfully activated

The table below describes the network LEDs (RJ45 WAN and LAN ports and the SFP). Each port uses a bi-color LED to reflect the link/activity and speed, from 10M to 1GbE.

RJ45 and 1G SFP	LED1 (Green)	LED2 (Amber)
No link	Off	Off
1G link	ON	Off
1G Act	Blink	ON
100M link	ON	Off
100M Act	Blink	Off
10M link	ON	Off
10M Act	Blink	Off

DRAFT

# Back Panel

Wired

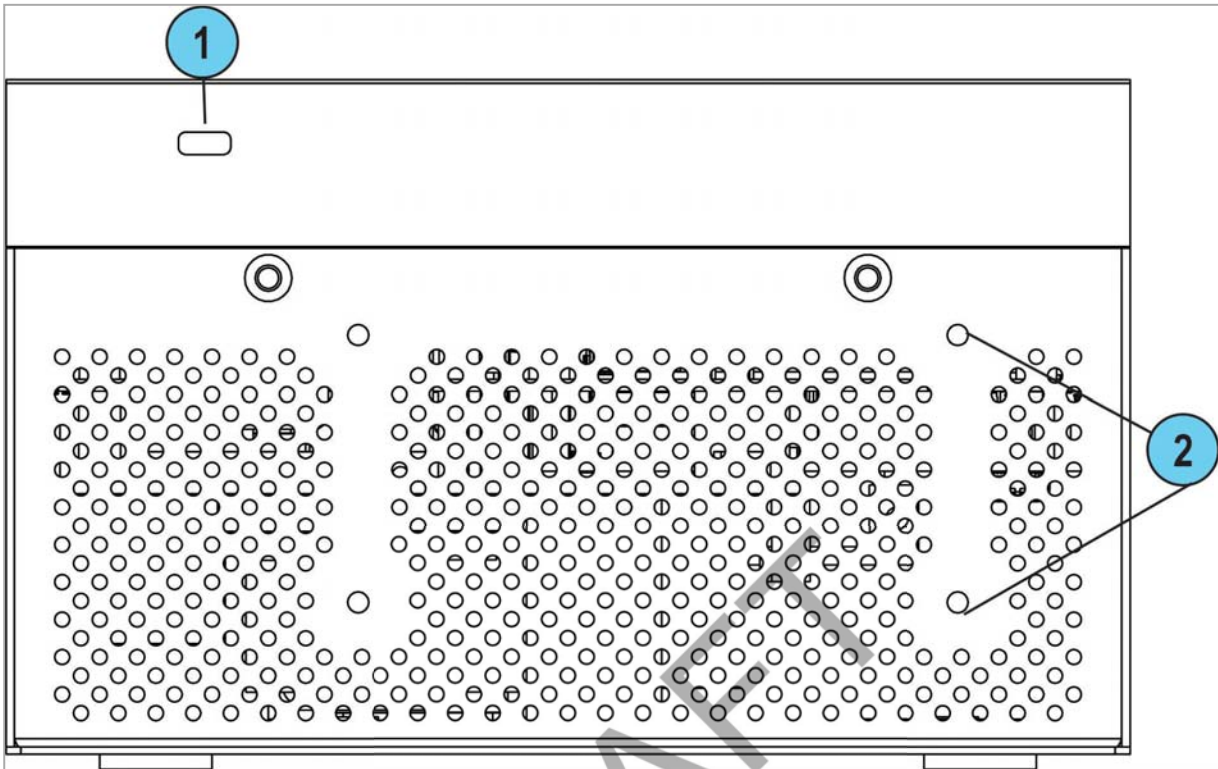



## WiFi-LTE

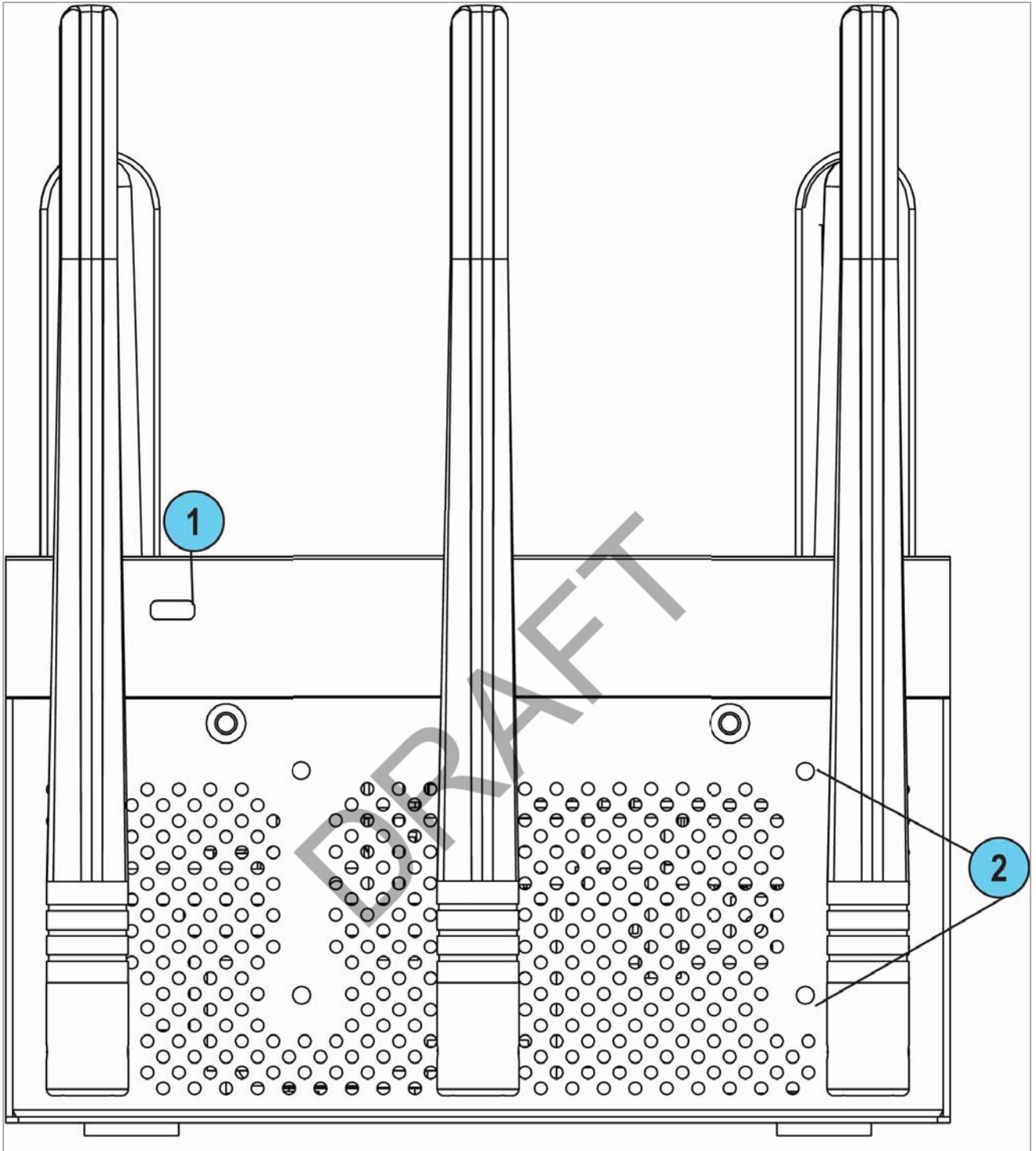

Key	Item	Description
1	Anti-theft slot	Insert anti-theft cable here. Use Kensington and Sunbox TL-623M cable as a reference.
2	M3 DIN rail mount hole	

# Side Panel

Wired

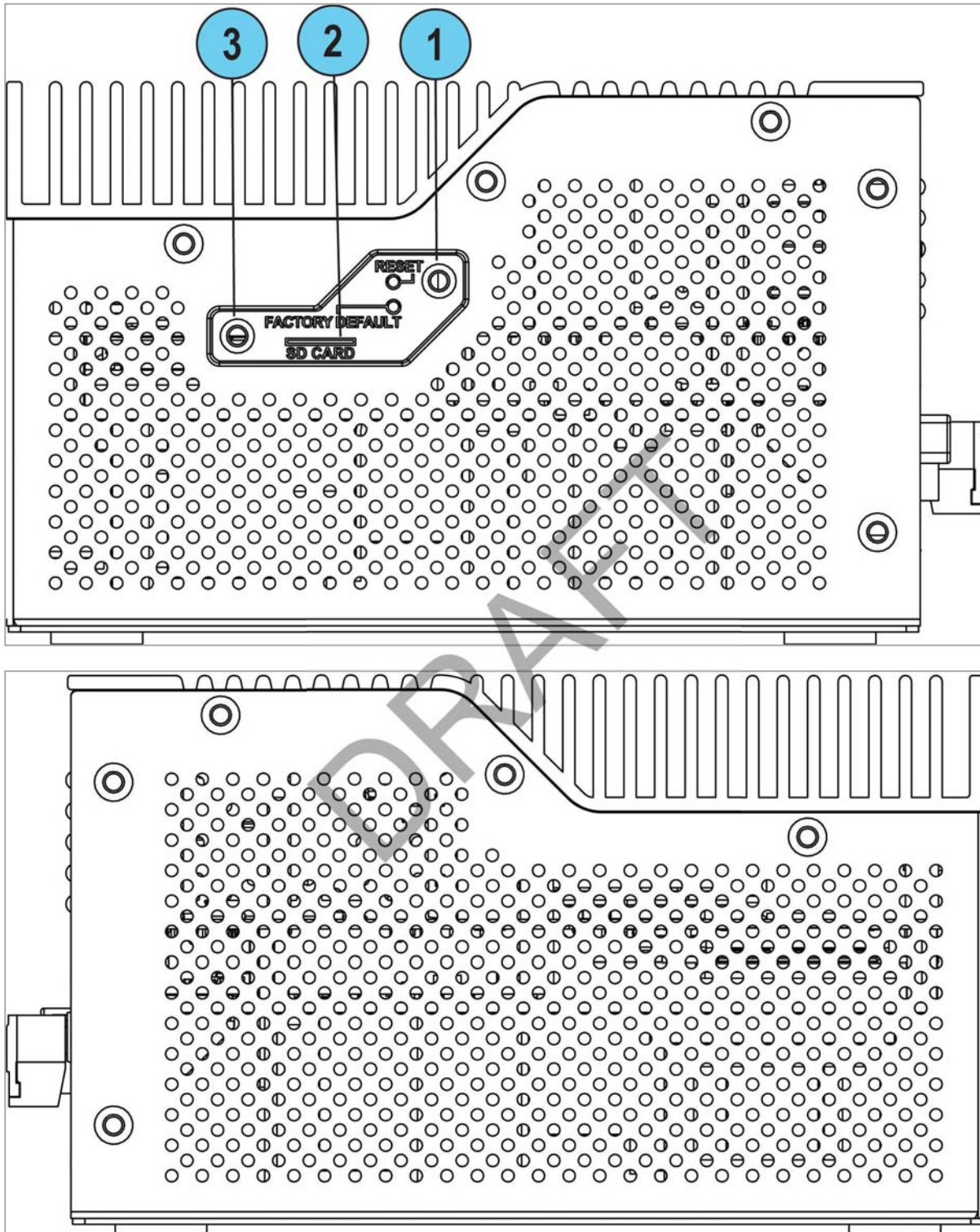

# WiFi-LTE

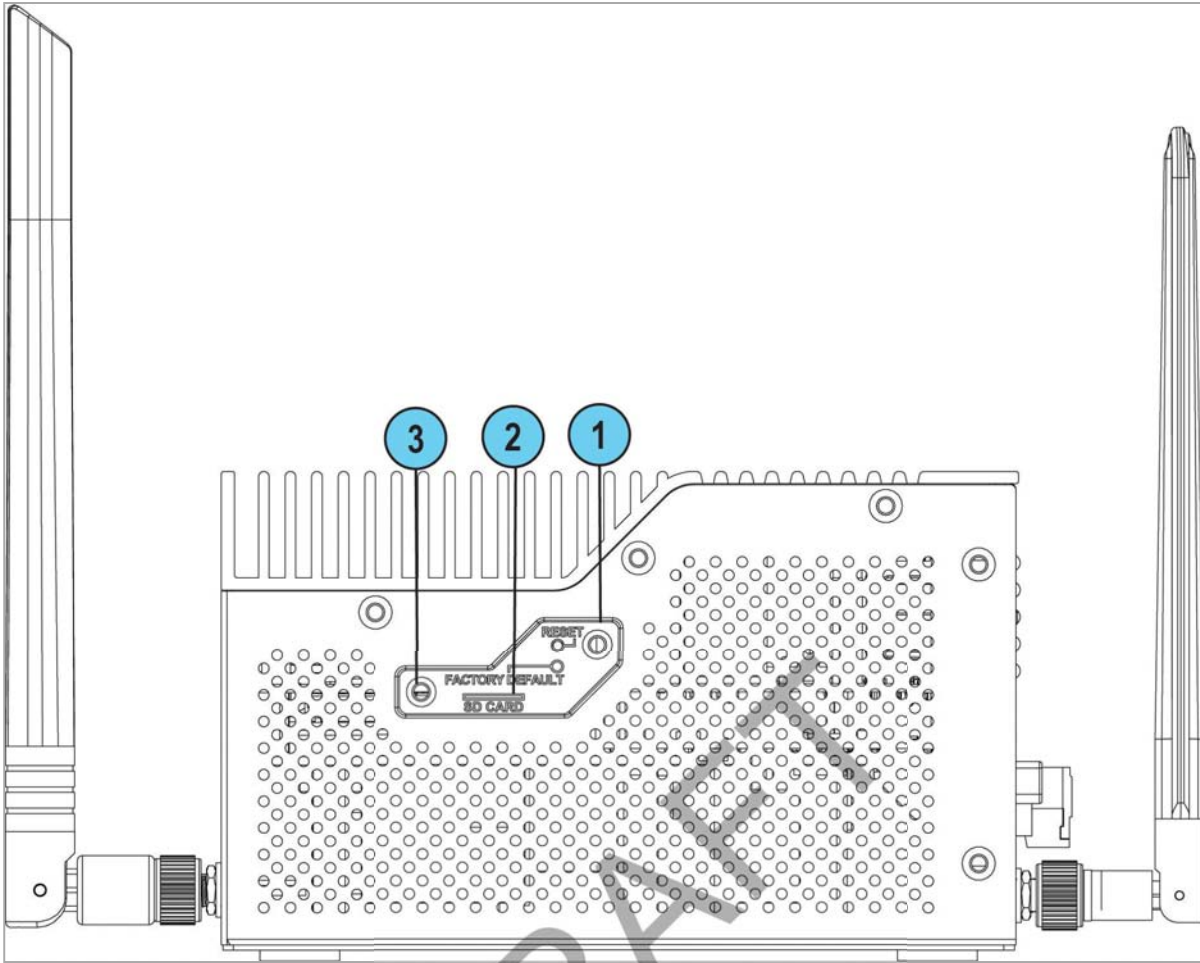

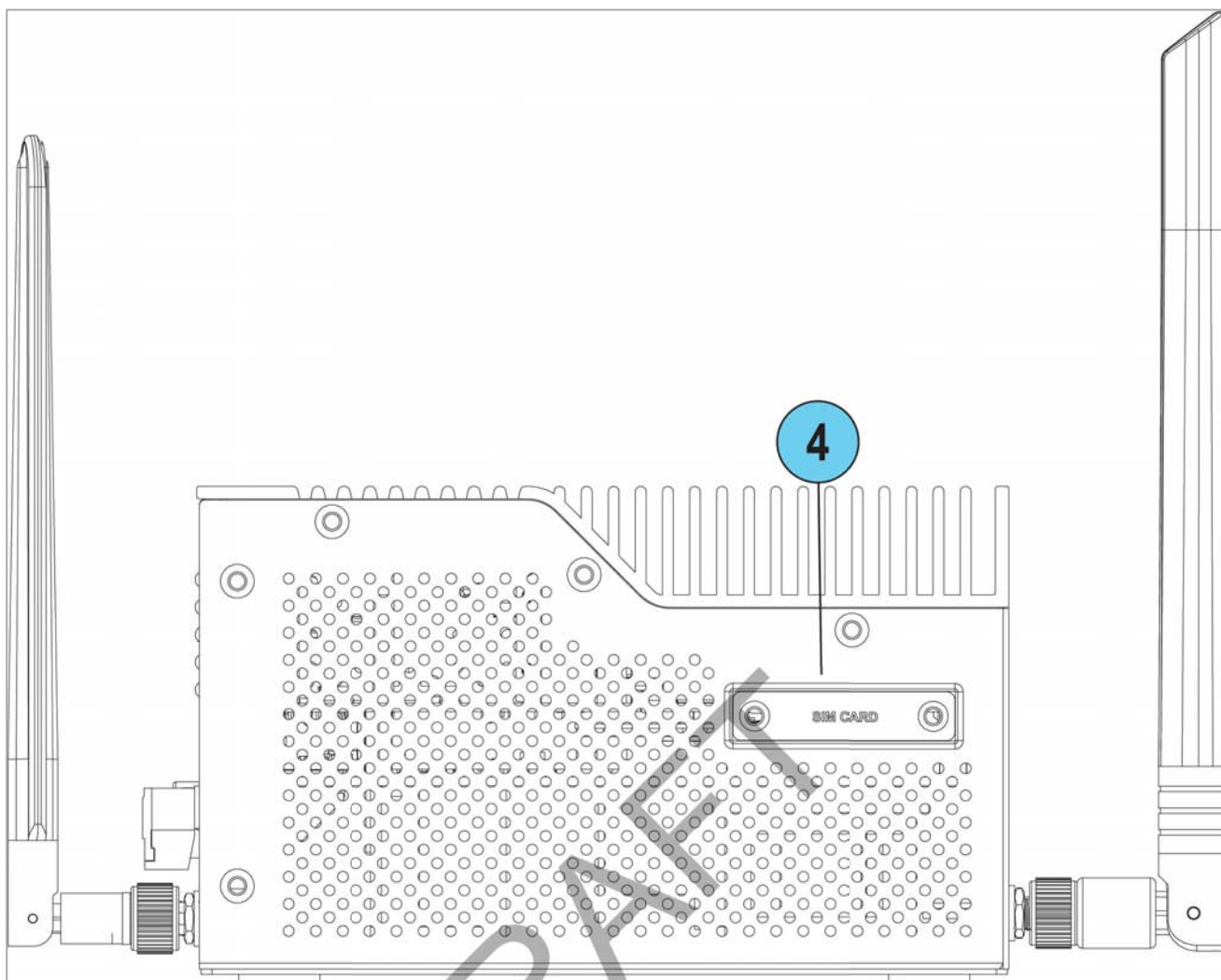

Key	Item	Description
1	Reset	Short press resets the system but does not remove any user parameters.
2	SD card slot	Insert micro-SD card here.
3	Factory Default	Press the button continuously for 12 seconds to restore the appliance to its factory default. All user parameters previously configured are removed.
4	SIM card slot	Insert SIM card here (WiFi-LTE model only).

# Using the First Time Configuration Wizard

Configure the Check Point appliance with the First Time Configuration Wizard.

To close the wizard and save configured settings, click **Quit**.

**Note** - In the First Time Configuration Wizard, you may not see all the pages described in this guide. The pages that show in the wizard depend on your appliance model and the options you select.

DRAFT



# Welcome

The **Welcome** page introduces the product and shows the name of your appliance.

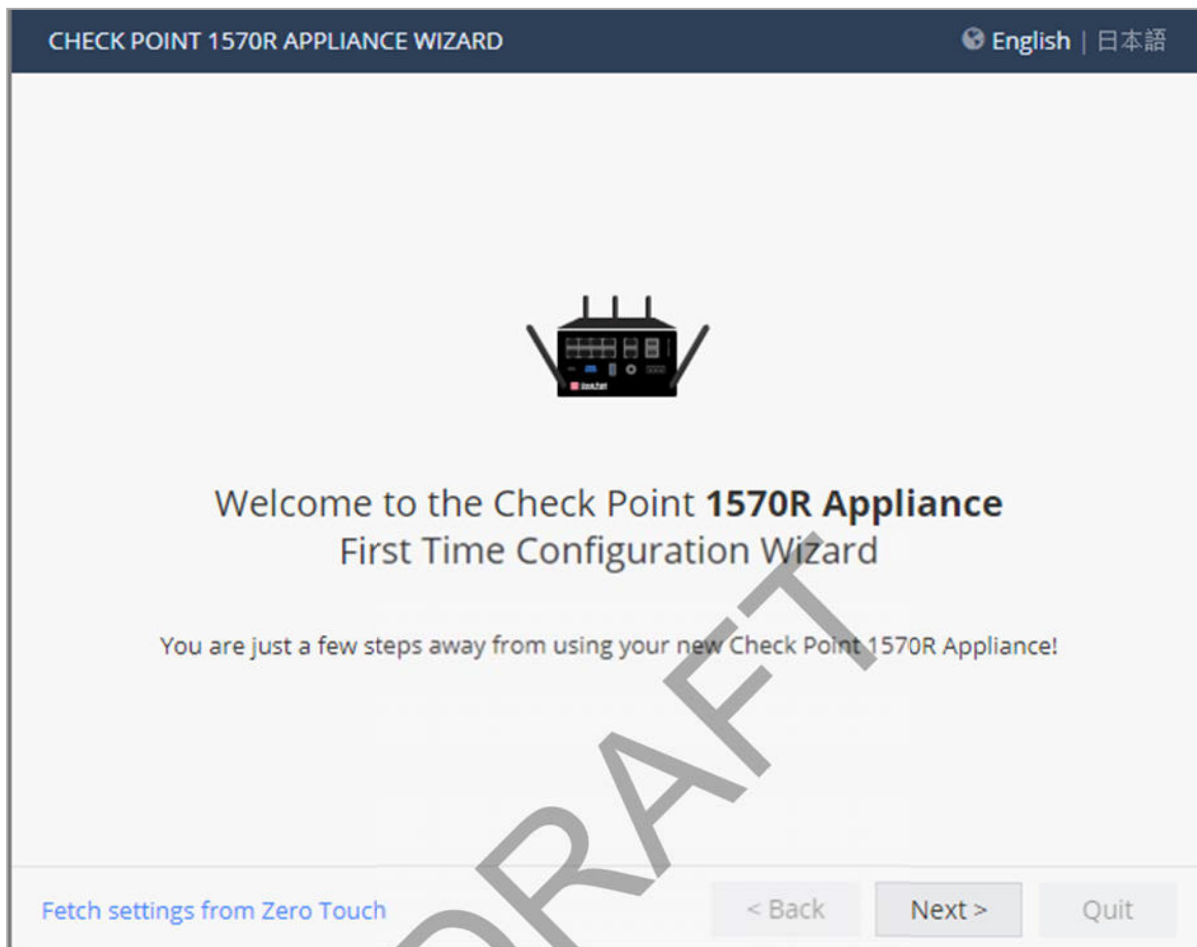

You can connect to the Zero Touch server to fetch settings automatically from the cloud.

**To change the language of the WebUI application:**

Select the language link at the top of the page.

**Note** - Only English is allowed as the input language.

## Zero Touch

Zero Touch enables a gateway to automatically fetch settings from the cloud when it is connected to the internet for the first time.

**Note** - You cannot use Zero Touch if you connect to the internet with a proxy server.

If the gateway connects to the internet through DHCP, the gateway will fetch the Zero Touch settings without any additional action. If no DHCP service is available, you must run the First Time Configuration Wizard, configure the **Internet Connection** settings, and then fetch the settings from the Zero Touch server.

**To connect to the Zero Touch server:**

1. In the **Welcome** page, click **Fetch Settings from the cloud**.
2. In the window that opens, click **OK** to confirm that you want to proceed.
3. The **Internet connection** page opens. Configure your Internet connection and click **Connect**.
4. The **Fetching settings from the cloud** window opens and shows the **Connecting to the service provider** status. This process may take several minutes.
5. If you fail to connect, an error message appears. Possible errors include:
  - Internet connection is not configured correctly.
  - Internet connection is through a proxy server.
  - Zero Touch is already running.
  - Zero Touch service already completed.
  - The First Time Configuration Wizard already completed.
  - Zero Touch service is disabled.Where applicable, click **Retry** now to connect again.
6. After you connect to the server, the settings are automatically downloaded and installed. The status is shown in the **Fetching settings from the cloud** window. It may take several minutes until the installation is complete.
7. Click **Finish**.

**Note** - If a collision is detected between an internal network (LAN) and an IP returned using DHCP (WAN), the conflicting LAN address is changed automatically. If a colliding LAN IP address is changed, a message appears in the system logs.

When you reconnect to the WebUI or click **Refresh**, the browser opens to show the status of the installation process.

After the gateway downloads and successfully applies the settings, it does not connect to the Zero Touch server again.

# Authentication Details

In the **Authentication Details** page, enter the required details to log in to the Check Point 1570R Appliance WebUI application or if the wizard terminates abnormally:

- **Administrator Name** - We recommend that you change the default "admin" login name of the administrator. The name is case sensitive.
- **Password** - A strong password has a minimum of 6 characters with at least one capital letter, one lower case letter, and a special character. Use the **Password strength** meter to measure the strength of your password.

**Note** - The meter is only an indicator and does not enforce creation of a password with a specified number of character or character combination. To enforce password complexity, click the check box.

- **Confirm Password** - Enter the password again.
- **Country** - Select a country from the list (for wireless network models).

**Note** - The country code selection is for non-US models only and is not available for all US models. Per FCC regulation, all WiFi products marketed in the US must be fixed to US operation channels only.

The country where the license is set determines the wireless frequency and parameters, as the regulations vary according to region.

If you are using a trial license, only **basic radio settings**, are allowed in all zones. A warning that selected wireless radio settings are not applied shows on the **Summary** page and also on the **Device > License** page. For more information on basic wireless radio settings, see [sk159693](#).

If you select a country and install a valid license, but the wireless region of the device does not match the selected country, a warning message shows and you must edit the country information. When the country and wireless region match, you see the full settings.



CHECK POINT 1570R APPLIANCE WIZARD ? Help

## Authentication Details Check Point SOFTWARE TECHNOLOGIES LTD.

Change the default administrator name and set the password:

Administrator name:

Password:

Confirm password:

Enforce password complexity on administrators

It is strongly recommended to use both uppercase and lowercase characters as well as one of the following characters in the password: !@#\$%^&\*()-\_+=;

Country:

Help us improve product experience by sending data to Check Point

Step 1 of 9 | Authentication

# Appliance Date and Time Settings

In the **Appliance Date and Time Settings** page, configure the appliance's date, time, and time zone settings manually or use the Network Time Protocol option.

When you set the time manually, the host computer's settings are used for the default date and time values. If necessary, change the time zone setting to show your correct location. Daylight Savings Time is automatically enabled by default. You can change this in the WebUI application on the **Device > Date and Time** page.

- **Date** - The host computer's date appears by default. If required, set a different date.
- **Time** - The host computer's time appears by default. If required, set a different time.
- **Time Zone** - The host computer's time zone appears by default. If required, select a time zone setting to reflect your exact location.
- **Primary NTP server** - The IP or host name of the primary NTP server. The default server is `ntp.checkpoint.com`
- **Secondary NTP server** - The IP or host name of the secondary NTP server. The default server is `ntp2.checkpoint.com`

CHECK POINT 1570R APPLIANCE WIZARD ? Help

## Appliance Date and Time Settings Check Point SOFTWARE TECHNOLOGIES LTD.

Set time manually

Date:

Time:  :

Time zone:

Use Network Time Protocol (NTP)

First NTP server:

Second NTP server:

Time zone:

Step 2 of 9 | Date and Time Settings < Back    Next >    Quit

# Appliance Name

In the **Appliance Name** page, enter a name to identify the appliance, and enter a domain name (optional).

When the gateway performs DNS resolving for a specified object's name, the domain name is appended to the object name. This lets hosts in the network look up hosts by their internal names.

CHECK POINT 1570R APPLIANCE WIZARD Help

## Appliance Name





Appliance Name:

Domain name:   
Example: mycompany.com

Step 3 of 9 | Appliance Name < Back Next > Quit

**DRAFT**