

# User Manual

Model: 6034-805-0000

Thank you for purchasing MID products. This user manual introduces every function of the MID briefly, which let you have an easy control in it and enjoy its value fully. Please read this manual carefully before use. The version number of this manual is Ver1.0.

## Announcements

1. Please noted that the new battery is only able to achieve the best performance after two or three charge and discharge cycles completely.
2. For the first three times charge battery, please make sure the charging time should be 8-10 hours at least. After it, the battery can be full charged about 5 hours. These make lithium battery achieved its best performance in the future.
3. To prevent data loss, it is recommended that users should be back up important data, especially before the firmware upgrade. We are not be responsible for any losses caused by data loss.
4. This machine is a high-precision electronic product, please do not disassemble by yourself.
5. Please avoid any strong beat or collide the player.
6. Avoid using the player in the following environments: high temperature, low temperature, humid, dusty, powerful magnetic field and long-term exposure under sunlight.
7. It's allow to wipe the device's casing gently by wet cloth drying, and any other chemical solution cleaning is strictly prohibited.
8. The device can not be suffered any drip and splash, and it should not be placed near something like cups filled liquid.
9. To avoid hearing damage, please choose the appropriate volume while listening.
10. Do not alter any part of the device.
11. Please only use the batteries, chargers and accessories manufacturers allowed. It will be violate the warranty regulations or may be dangerous if you use any other ones
12. Please follow the relevant local environmental regulations to dispose the discarded device and accessories.
13. If there is any questions during using, please contact the local dealer or our company's customer service center directly.
14. All specifications or others are subject to change without notice.

## Manual Catalogue:

- 一、 Product specifications
- 二、 Appearance and Key Description
- 三、 Operation keys introduction
- 四、 Getting Started
  - (一) Open the player
  - (二) The use of functions
    1. WIFI
    2. Bluetooth

3. Play Music
4. Play video
5. Picture browsing
6. Photograph
7. Recording
8. G-SENSOR
9. HDMI
10. Download and Use Application

#### (四) Charging Step

1. Charge the unit via USB adapter.

#### (五) Abnormal restart

### 五、 Frequently Asked Questions

#### 一、 Product specifications

- Model: MT06
- EMMC Capacity: 64G
- DDR Capacity: 2GB
- USB port: MICRO USB
- Display: 10.1 inch (type); 800\*1280 (Display pixels)
- Battery: Rechargeable polymer lithium ion battery 8100mA/h
- Size: 274.6mm (L) \* 177mm (W) \* 13.3mm (H)
- 二、 Appearance and Key Description:

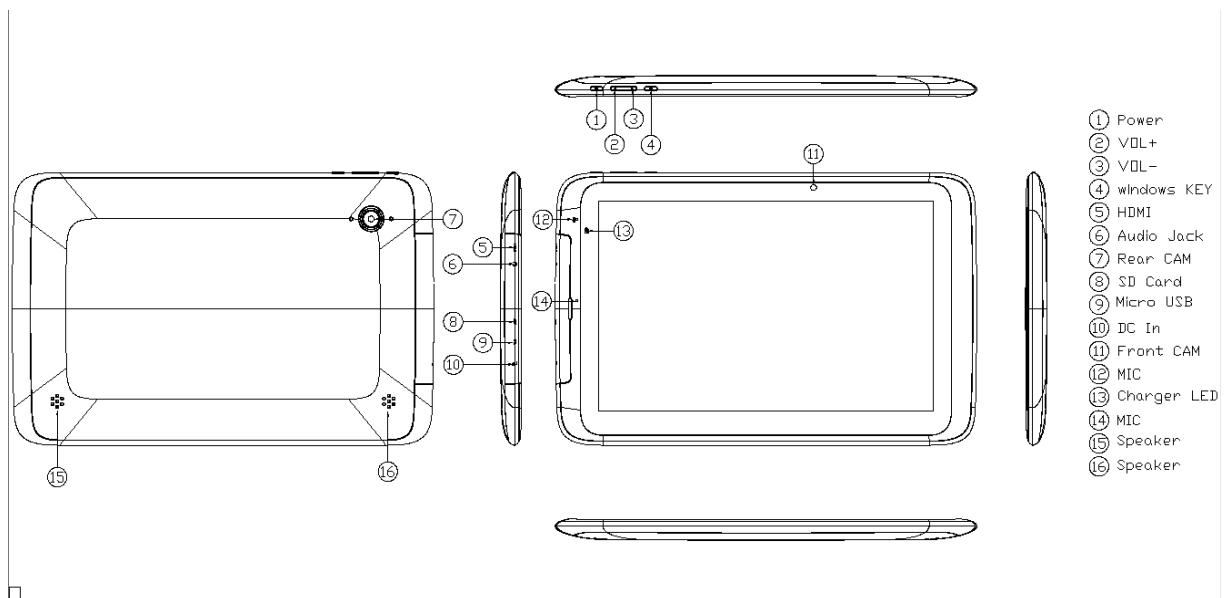

#### 三、 Operation keys introduction:

1. Power: Long press to open the device, short press to wake up the device while standby, long press to off the device.
2. Volume + / - : Short press to adjust the volume.
3. Home key to return to the desktop

## 四、Getting Started

### (一) Boot device

According to "Power" button in the Appearance and Keys description, long press it to turn on the device.

### (二) The use of functions:

#### 1. WIFI

Turn on the WIFI in "Settings" menu, click search, select the available network and connect it via enter the correct password.

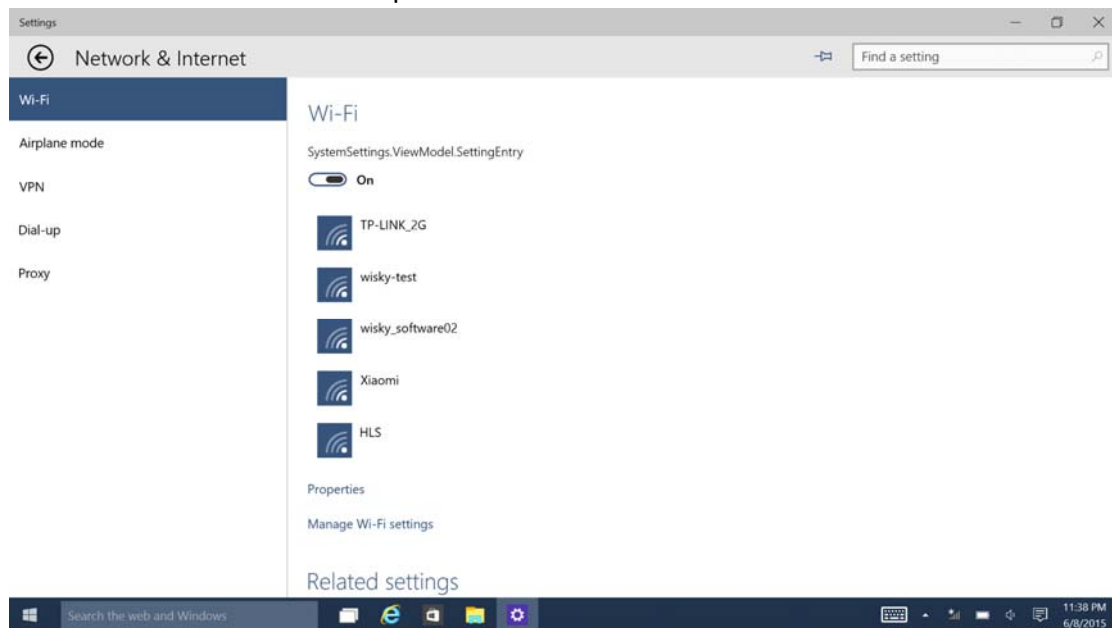

#### 2. Bluetooth

Turn on Bluetooth in "Settings". The unit will search for Bluetooth devices automatically, then you can select a device pairing. Once the pairing is succeed finished, you can transmit / receive files

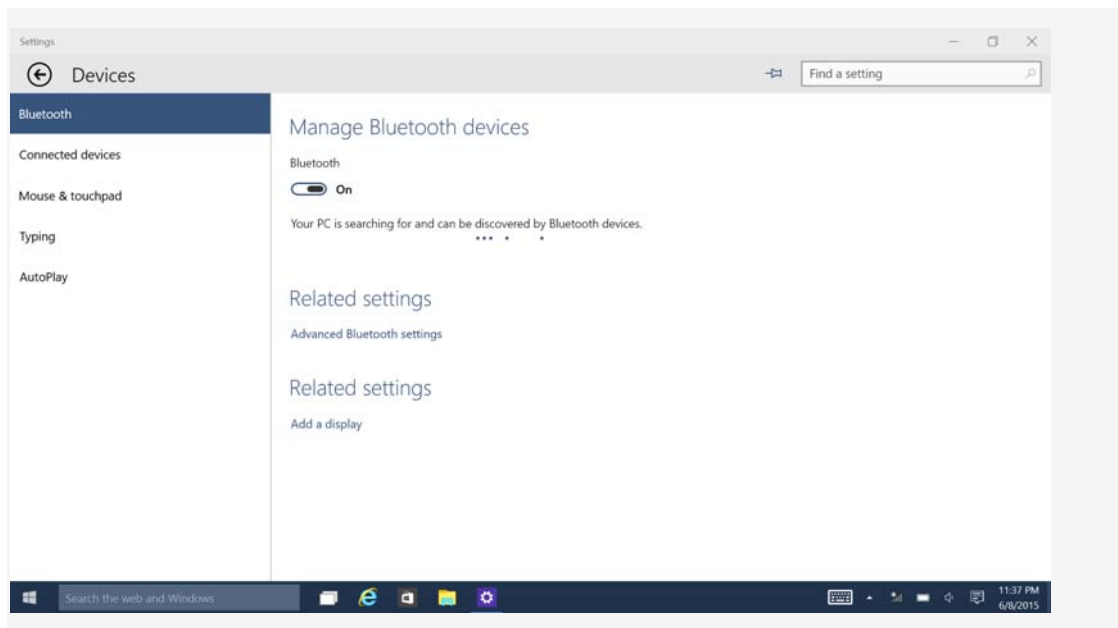

### 3. Music

Simply click the "Music" into the music player interface, you can download different styles of Music players according to your preference. The unit can support music format of MP3, wav, aac or ogg.

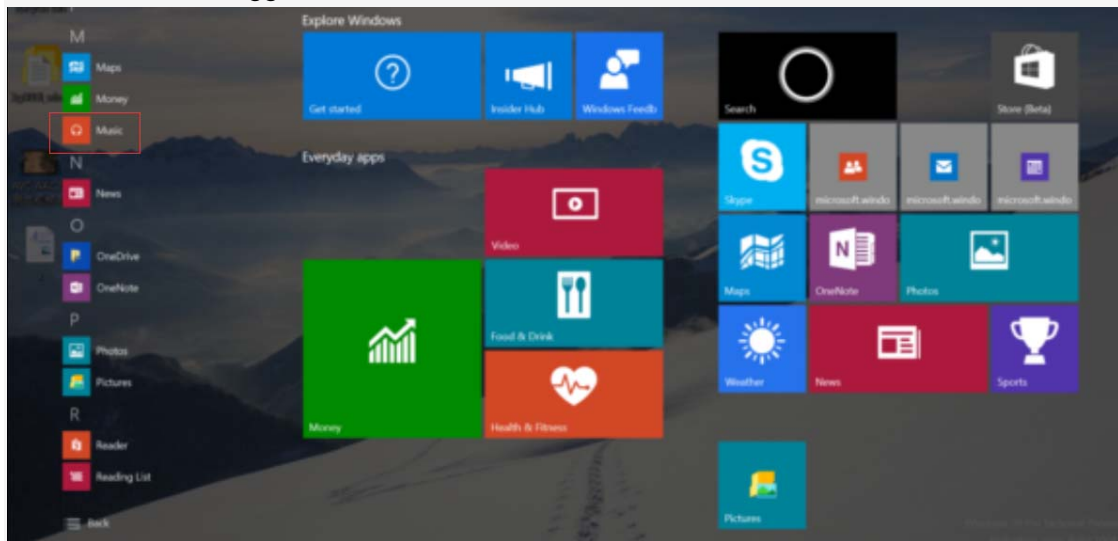

### 4. Video

Simply click the "Video Player" for playing, you can download different styles of Video players according to your preference. The unit can support video format of 3gp, webm, mov or MP4.



### 5. Picture

You can browsing the picture by click into the “Gallery”, and also can set the picture as the desktop background.

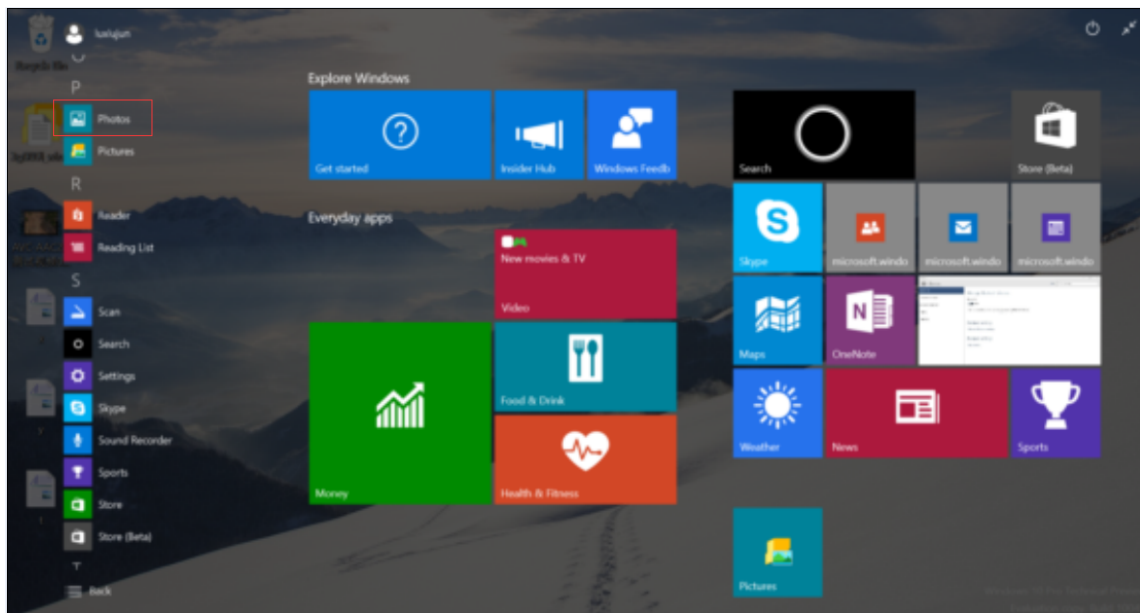

### 6. Front CAM 200MP\Rear CAM500MPCamera

Click the “Camera” in menu, you can select photos or use the camera function. Insert the TF card into unit, the photos can be saved in it.

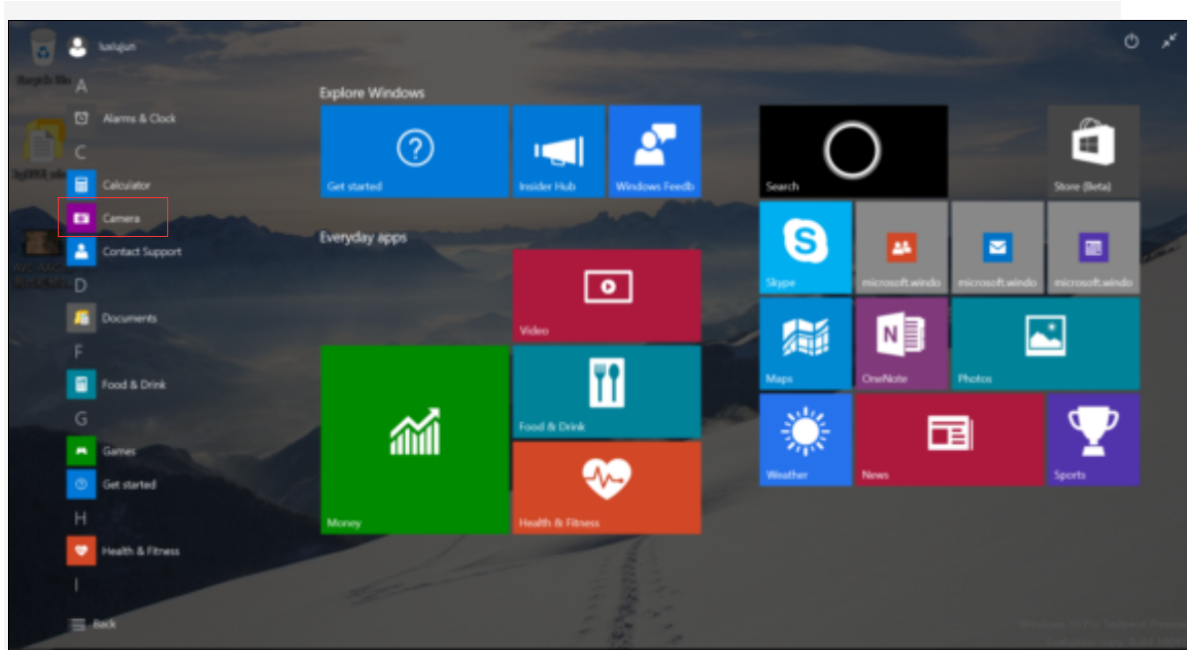

## 7. Recording

Click the "Record" menu directly for enter the recording interface.



## 8. G-SENSOR

Auto-rotate screen in the bottom right corner of the status bar can be turned on or off  
G-SENSOR

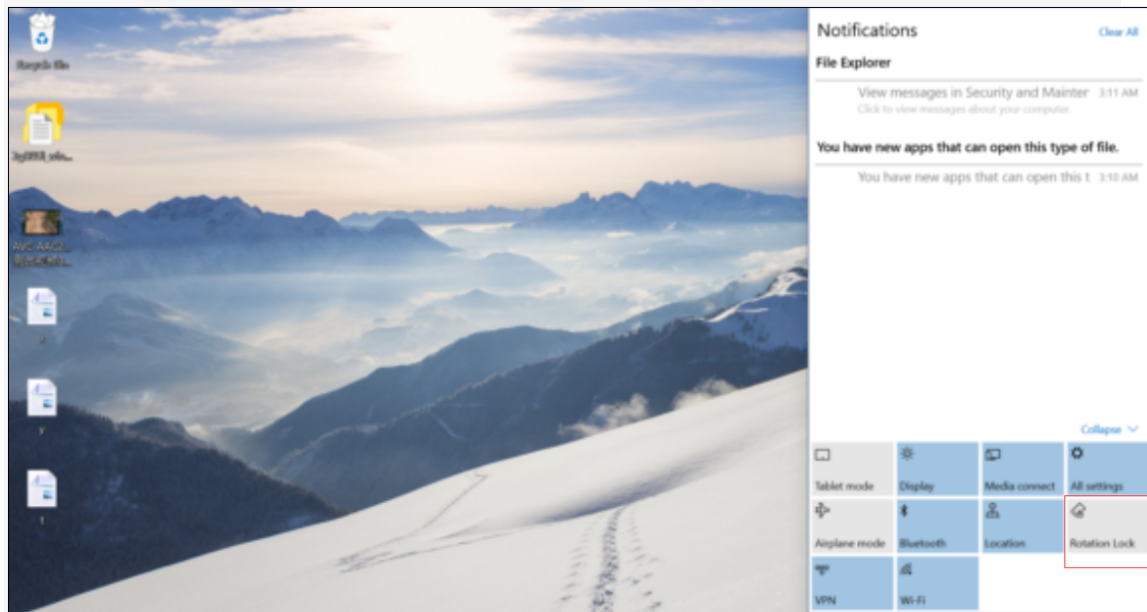

## 9.HDMI

To connect an external display, display and the machine can normally display

### 10. Download and Use Application

1. Click the exe will need to install, then there is one prompt dialog box shows "Install" "Cancel". Click "Install" and waiting for installing exe. After finish, it will shows "Application is already installed". Click "Finish" to continue to install other or click "Open" to open the current installed application directly.

Method 2: The application installation method downloaded from Network

1. Install and download ". exe" market applications through "exe installer". For example, store, etc.

2. Open the page, you can find a large number of sorted applications. Click on any application, there will be shows the option of "Install", then click "Install", it will prompt "Downloading ----> Finished download ----> Download is finished and is being installed ----> Install succeed". At this time, you can open this application or click " Uninstall " to uninstall it.

3. You can also download the application by any web page directly.

Note: The applications which downloaded from Website just can be saved in TF card.

### (四) Charging Step

#### 1. Using adapter for charging

Special note: The adapter's specification must be accord with the following requirement. Any accident or failure based on not accord with the adapter requirement, we regard it as man-made damage.

Name: Adapter

Input: AC100V~240Hz ,50Hz/60Hz

Output: 5.0V 2000MA

Interface Standard: USB MICO standard interface

#### (五) Abnormal restart:

If there is anomalies caused by illegal operation, such as fixed screen, can not operate etc., all can be got right after reset it through the "Power button" which in the side of the device and then turn on device again.

#### 五、 Frequently Asked Questions

##### ① The players can not boot

- Check battery with power or not
- Connect the adapter and check again
- If it still can not boot after charging, please contact our customer service.

##### ② The earphone can not hear sound

- Check the volume is set to 0 or not.
- Check the earphone connection is OK or not

##### ③ Serious noise

- Check the earphone plug is clean or not, dirt can cause noise.
- Check the music file is damaged or not. Try to confirm it by playing other music. If the file has been damaged, it may cause very serious noise or skips.

##### ④ The screen garbled

- Check that you have set the correct language or not. You can find and set it in < Settings> -- <System settings> -- <Language selection>.

##### ⑤ Can not download files

- Make sure the computer and player is properly connected
- Check the storage space of memory is full or not
- Check the USB cable is damaged or not

#### **FCC Warning**

This device complies with Part 15 of the FCC Rules. Operation is subject to the following two conditions:

(1) This device may not cause harmful interference, and (2) this device must accept any interference received, including interference that may cause undesired operation.

NOTE 1: This equipment has been tested and found to comply with the limits for a Class B digital device, pursuant to part 15 of the FCC Rules. These limits are designed to provide reasonable protection against harmful interference in a residential installation. This equipment generates, uses



and can radiate radio frequency energy and, if not installed and used in accordance with the instructions, may cause harmful interference to radio communications. However, there is no guarantee that interference will not occur in a particular installation. If this equipment does cause harmful interference to radio or television reception, which can be determined by turning the equipment off and on, the user is encouraged to try to correct the interference by one or more of the following measures:

- Reorient or relocate the receiving antenna.
- Increase the separation between the equipment and receiver.
- Connect the equipment into an outlet on a circuit different from that to which the receiver is connected.
- Consult the dealer or an experienced radio/TV technician for help.

NOTE 2: Any changes or modifications to this unit not expressly approved by the party responsible for compliance could void the user's authority to operate the equipment.