

## Using UltraSpec Alignment - General Overview

---

This chapter covers the following topics:

- UltraMgr/UltraSpec Analyzer Overview
- Storing, recalling, and modifying jobs
- Defining a job
- Machine Dimensions
- Soft Foot
- View Data
- Checking data
- Viewing machine moves
- Printing an alignment job



# General Overview

This section contains overviews of UltraMgr and the UltraSpec analyzer, the three alignment methods, menu maps of the UltraSpec analyzer, and an explanation of the Main Menu.

## UltraMgr/UltraSpec Analyzer Overview

The figure below shows how jobs can be moved in and out of various areas of UltraMgr's database and the analyzer. Definitions of the job types follow.

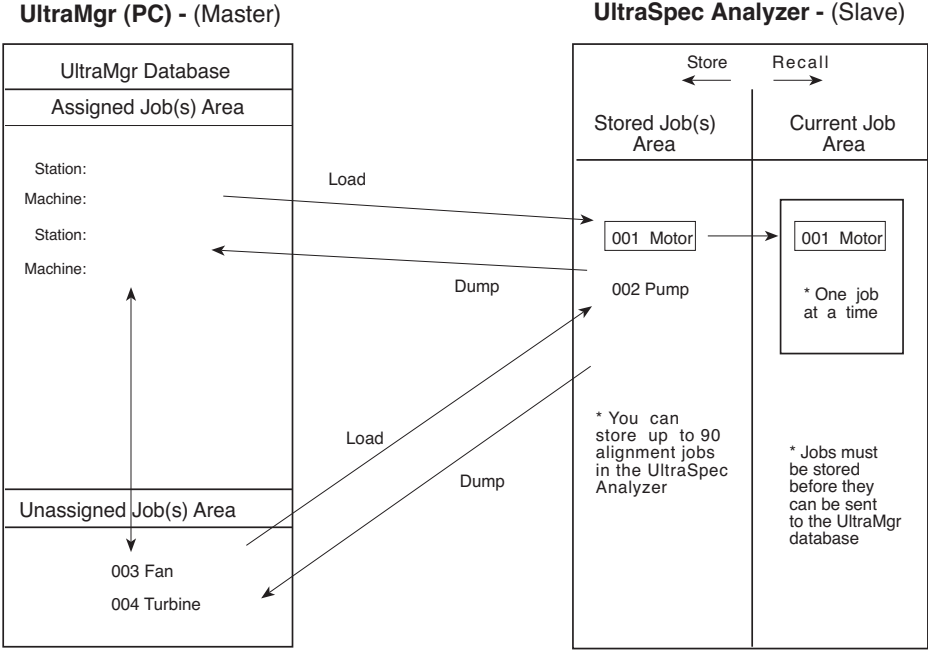

UltraMgr/UltraSpec Analyzer Overview

---

**Note**

This manual and the UltraSpec Analyzer manual use the terms Station and Machine. In RBMware compatible UltraMgr v4.00 and later, a station may be preferred to as Area, and Machine may be referred to as Equipment unless redefined by the user.

---

**Note**

Data from the 8215 and 8225 laser heads are compatible with UltraMgr v4.40 and later.

Definitions of the job types shown in the figure are:

- **Assigned jobs** – jobs that have been assigned to a machine.
- **Unassigned jobs** – jobs that have been moved from the Stored Jobs area of the analyzer into the UltraMgr database but have not been assigned to a machine. Using UltraMgr, you can also change a job from Assigned to Unassigned status.
- **Stored jobs** – located in the Stored Jobs area of the Analyzer. Current jobs that are saved become stored jobs and are placed in the Stored Jobs area; also, all jobs that are loaded from the UltraMgr database are placed in this area and become stored jobs.
- **Current job** – job currently displayed in the working area (only one job can be displayed at a time).

The following cases may help you to understand how jobs are moved around in the analyzer and back and forth to UltraMgr. When beginning a job (in the Current Job location), there are normally two choices. Either start from ground zero and create, configure, and name an entirely new job or, (if available) recall a job from the Stored Job(s) area.

**Case 1** – If you create and configure an entirely new job in the analyzer's Current Job area and you want to keep it, you must copy it into the Stored Job area by using the Store Job command in the Alignment Options menu. From there (using the UltraMgr database program on a PC), you can download it into a section of UltraMgr known as the Unassigned Area.

Continuing with the UltraMgr program, you can then assign the job to a machine and station thereby fully integrating the job information into the UltraMgr database. If for some reason you do not want to assign the job to a machine and station, you can leave it in the Unassigned Area.

In either case, you can then use UltraMgr to Load the job back into the analyzer and from that point, you can recall it into the Current Job area where you have full editing capabilities.

**Case 2** – You begin with a recalled job from the Stored Job area. An important concept to remember is that a job recalled into the Current Job area is essentially a *copy* of the original job which remains in the Stored Job area. This allows you to modify, renumber, and save the *copy* thereby creating an entirely new job (without affecting the original job).

However, if you want to change the original job (instead of creating a new one), make the desired changes and, when prompted about saving the original job, answer No. This allows you to overwrite the data in the original job with your new data.

**Case 3** – This case is referred to as job “cloning” and provides optimum use of the entire system, including UltraMgr. *This procedure will be the one commonly used after an alignment job has been archived in UltraMgr.* An old job performed on the same machine can be loaded into the analyzer and used as a template for the job to be performed. The old job contains information on the job setup, the latest alignment condition (machine moves and tolerances), and concerns or observations (notes). You should review this information before clearing out the readings and notes. If desired, edit the job setup and then begin taking your first set of new readings.

In summary, some of the advantages in using this method are:

- You save time by using a previous job setup.
- Problems and concerns (soft foot, runout, etc.) documented on previous jobs can be viewed.
- Jobs that are loaded from the Assigned area of UltraMgr already have station and machine assignments; this ensures that your new job data will be dumped to the proper location.

Although the UltraMgr user’s manual provides additional information, some other concepts will be briefly discussed.

Referring back to the UltraMgr/UltraSpec analyzer overview figure, the UltraMgr PC is shown as the master and the UltraSpec analyzer is shown as a slave. This means that actual transactions between the UltraMgr PC and the analyzer are controlled by UltraMgr. Although you must make the following analyzer selections to prepare for a job transfer, (1) Utility (2) Communications (3) Host PC Load/Dump, the analyzer plays a passive role from that point on. The actual transfer is set up and controlled from an UltraMgr screen.

Also, when you are using UltraMgr, you need to consider what actions are necessary after jobs have been *created* or *changed* (in the analyzer). As mentioned previously, actual Station and Machine assignments are made from UltraMgr.

The following figure and table (next page) show how changes to the various parameters affect the job type. Although job type is a software term, the job type determines where the job will be dumped to within the alignment database (to a Machine location or to the Unassigned area).

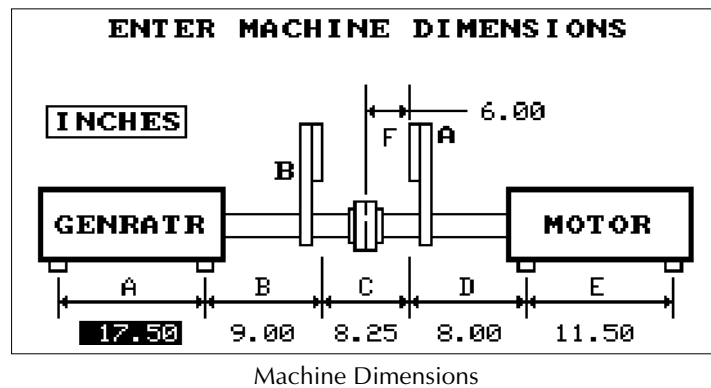

Modifications to these fields	change the Job Type to	
	Unassigned	Modified
Alignment Data		X
Alignment Method		X
Coupling	X	
Mach Desc	X	
Mach ID	X	
Machine Dimension: A & E (between feet)	X	
Machine Dimension: B, C, D, & F		X
Machine View (also called machine configuration)	X	
Notes		X
Rotation		X
RPM	X	
Station	X	
Thermal Growth		X
User Initials		X
Foot Pre-Check		X
Laser Configuration		X

**Modified Jobs** – This job type is assigned to a particular machine within UltraMgr. If a change(s) is made to a job that causes it to become Modified, it will still retain its Station and Machine assignments in UltraMgr.

**Note**

When loading a job from UltraMgr, you will receive a screen prompt that allows you to assign a new Job No./Name to the modified job. To ensure that your jobs are easy to identify, CSI recommends that you assign a new Job No./Name. Otherwise, you can have assigned jobs that have very similar labels (except perhaps for the time the file was stored). Of course, you can always use UltraMgr's editing features to go back and delete any jobs you really do not want to keep.

**Unassigned Jobs** – If you create a new job or make change(s) to an existing job that causes it to be Unassigned, when dumped, it will be placed in the Unassigned Area of the alignment database. From there, you can use UltraMgr to assign it to a machine within the database.

The following pop up box will be displayed if any fields are changed which make the job an Unassigned job. Those fields are listed in the Unassigned column on the previous page.

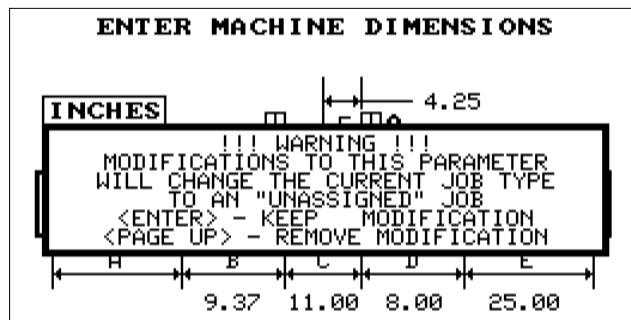

---

**Note**

If, for some reason, you do not want to assign a job to the database, you always have the option of leaving it in the Unassigned Area. UltraMgr allows you to Load and Dump these jobs to the analyzer the same way assigned jobs are handled.



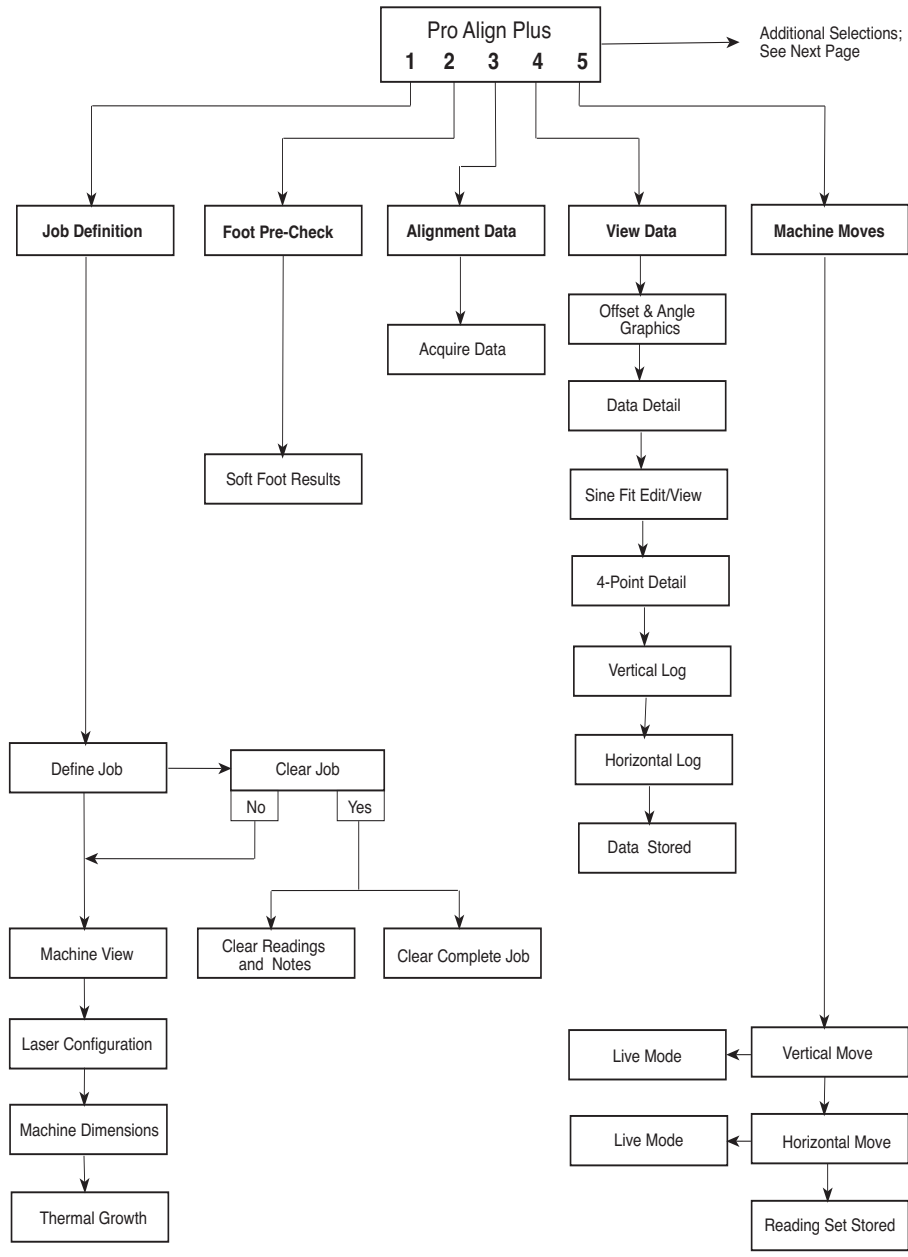

CSI Laser Menu Selections Map (page 1) – Quick Spec Mode Off

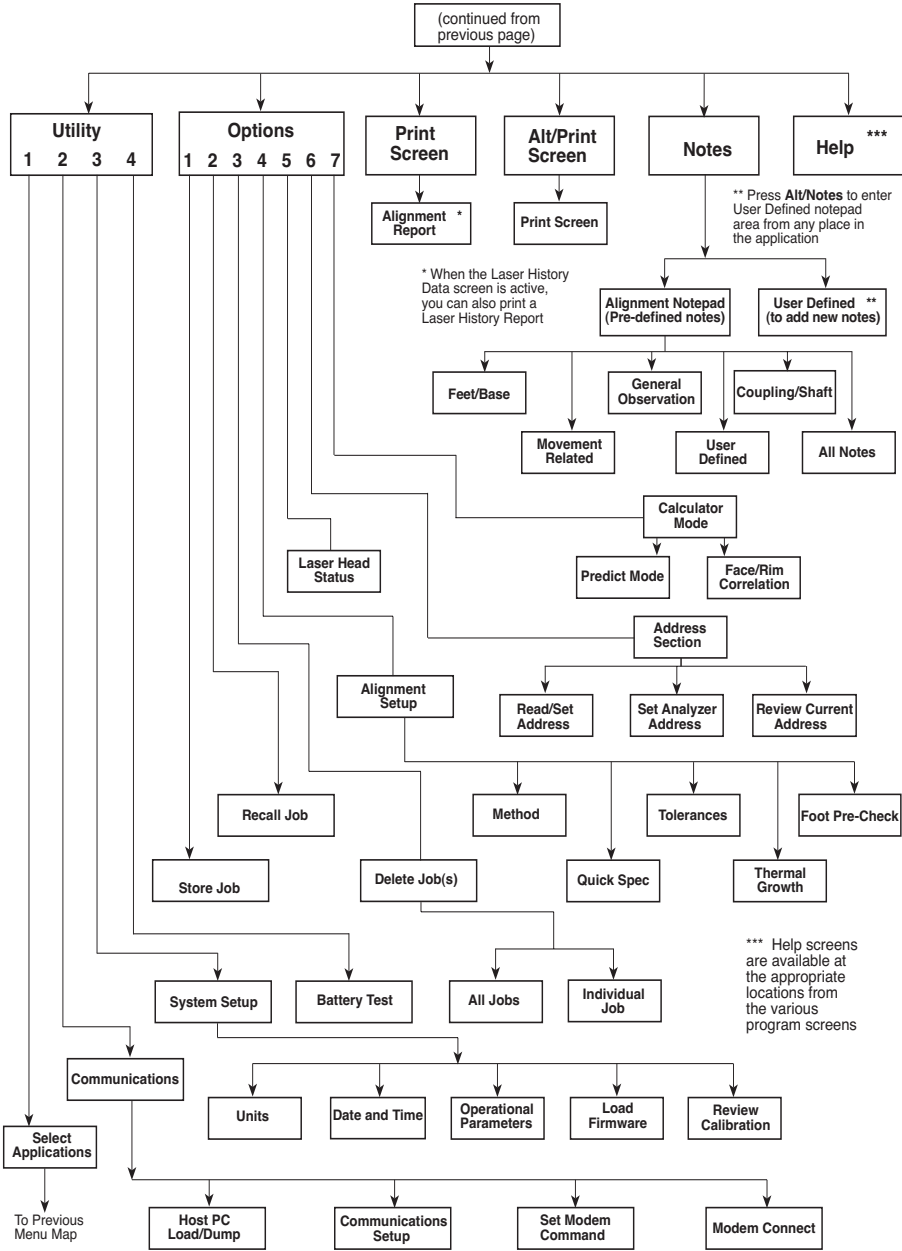

CSI Laser Menu Selections Map (page 2) – Quick Spec Mode Off

---

## Main Menu Display

The Main Menu items are shown and described in the following section.

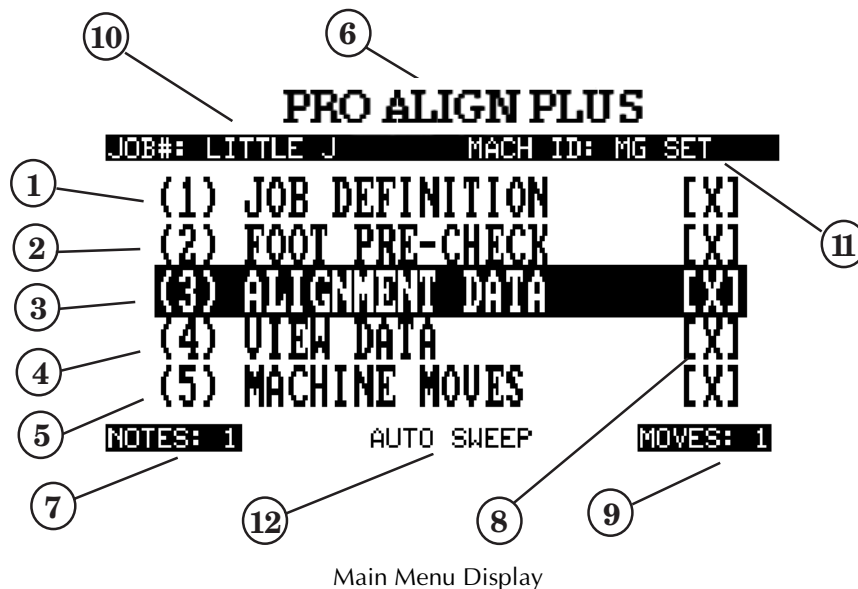

1. ... Use this section to complete all items necessary to document the job properly.
2. ... Allows you to locate feet that are causing machine problems (including relative severity).
3. ... Section where alignment data is acquired.
4. ... Displays graphical representation of the present alignment condition in offset and angle.
5. ... Calculates required machinery moves, both vertical and horizontal. A real time machine move is provided for machine positioning.
6. ... Program header – identifies program as Pro Align Plus.
7. ... Total number of notes that are stored with the Current alignment job (up to 40).
8. ... An X appears after each function that has been properly performed.

9. ... Shows the number of machine moves that have been stored in the Current alignment job (up to 20).
10. · The job number as defined in the Job Definition section.
11. · The Machine being aligned.
12. · Data collection method currently being used.

---

## Job Definition

---

### Define Job

To bring up the Define Job screen, select the Job Definition section on the Main menu.

```
          DEFINE JOB
CLEAR JOB: NO    USER: ABC
JOB #     : JOB CSI
MACH ID   : PBT COOL
MACH DESC: PBT COOLING FA\-->
STATION   : HEAVY EQUIPMEN\-->
COUPLING  : 1      RPM: 2500
```

Define Job Screen

Use the Up Arrow or Down Arrow to highlight the following portions of the Define Job menu.

**Clear Job:** You can erase part or all of the Current job shown on the Define Job menu. Use any numbered key to toggle to “Yes”; press Enter and a screen showing three options will be displayed.

```
          CLEAR CURRENT JOB
          SELECT PART TO BE CLEARED:
(1) ABORT, DO NOT CLEAR
(2) READINGS & NOTES ONLY
(3) CLEAR THE WHOLE JOB
```

Clear Job Options

Press the Up Arrow or Down Arrow to highlight one of the following three selections. Press Enter to accept.

- (1)· Abort, Do Not Clear – returns you to the Define Job menu with no changes to the job.
- (2)· Readings & Notes Only – causes all job alignment reading sets (up to 20) and notes (up to 40) to be erased. The information in the Job Definition section will remain unchanged. You will be returned to the Define Job menu after the Readings have been cleared.

If a job is received from UltraMgr and the only things changed during the alignment job are the alignment readings and notes, the new job will be dumped directly back to the proper Station and Machine.

- (3)· Clear the Whole Job – causes all alignment readings, notes, machine moves, machine distances, and job definition fields to be erased. You will be returned to a blank Define Job menu after the Job has been cleared.

---

**Note**

The menu items Job #, Mach ID, Mach Desc, Station, and Coupling are used for documentation purposes and for identification within UltraMgr.

**User:** An alphanumeric, 3-character field to identify who performed the alignment job (see “Alphanumeric Keys” on page 2-15). Normally, it will be the user’s initials.

**Job #:** You can select up to 10 characters to name the job (job name must be furnished to save the job – a job cannot be saved with a blank Job#). The Job# gives the job a unique identification; it can be tied to a work order number, etc.

If the job is defined within the analyzer, it will be dumped to UltraMgr as an Unassigned job. After the dump is complete, the job should be assigned to its machine. The Mach ID, Mach Desc, and Station will be modified to match their assignment within UltraMgr.

If no machine or station exists (in the UltraMgr database), they can be created after the job has been dumped. You can then complete the job assignment.

---

**Note**

If the job is defined within UltraMgr, the Mach ID, Mach Desc, Station and Coupling cannot be modified within the analyzer.

**Mach ID:** - Up to 10 characters can be used to define a Machine ID code for the machine being aligned.

**Mach Desc:** - By pressing any key on the keypad (except Page Up or Alt), the highlighted block can be expanded. Up to 28 characters can be used to describe the machine being aligned. Press the Up Arrow or Down Arrow to go to the next section of Define Job (characters off the screen will not be lost).

**Station:** - Press any numbered key to expand the highlighted block. Up to 32 characters can be used to describe the station where the machine is located.

**Coupling:** - If machinery being aligned has more than one coupling, use this section of Define Job to number them. Each coupling should have its own unique number. An example would be a machinery train consisting of a motor, a gearbox, and a compressor. The coupling between the motor and gearbox should be 1 and the coupling between the gearbox and compressor should be 2. Positive numbers up to 10 can be entered.

**RPM:** - A unique RPM exists for each coupling that is entered. If you have a variable speed machine, enter the highest RPM at which the coupling will be operated. Also, if a coupling design has shafts operating at different speeds, enter the larger of the two. This parameter is used to establish alignment tolerances.

When finished, press the Enter key to continue.

---

## Machine View

Use the following screen to define how the machines will be viewed during the alignment job. In this view, the two machines are connected by one coupling.

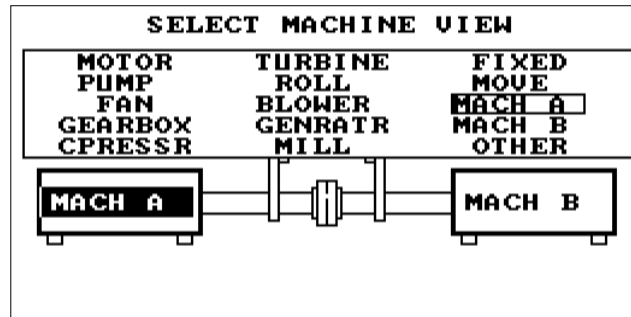

Machine View Screen

The machines should be named according to how they are installed *relative to the location where the user will view the machines*. Choose the appropriate name with the Up/Down arrow keys and Left/Right arrow keys. Press Enter to accept the left machine. Proceed to the right machine and repeat the process. Then, press Enter to move to the next screen.

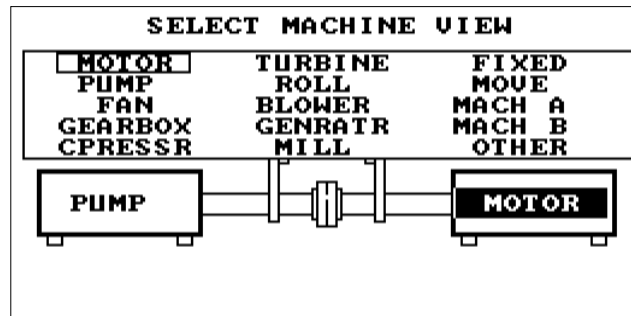



---

## Laser Configuration

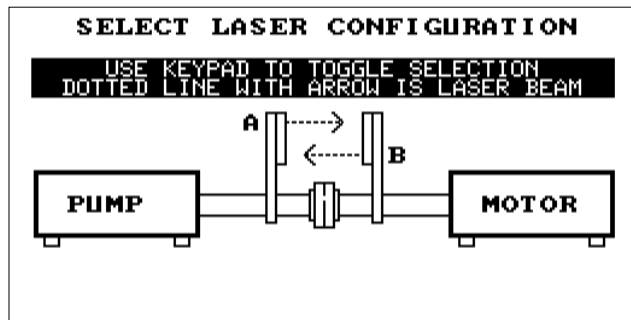

It does not matter which sensor head is put on which machine, however, the analyzer must know each head's location. Use any keypad key to toggle from one configuration to the other. The arrows must be set to match the directions that each laser will transmit, i.e., the arrows must represent the actual laser directions by pointing away from the small circle and toward the red target. Press Enter to accept the configuration.

---

### **Caution!**

*Selecting the proper configuration for the laser heads is extremely important! If the setting is wrong, all of the machine move calculations will be incorrect.*

For the Model 8215/8225, A and B are marked on the face plate of the laser head.

---

### **Note**

The program automatically knows whether Model 8215 or 8225 laser heads are being used.

---

## Machine Dimensions (A through F)

### Note

This section assumes that the fixtures are set up to the point that the sensor heads are mounted.

After accepting the configuration, the following screen will appear.

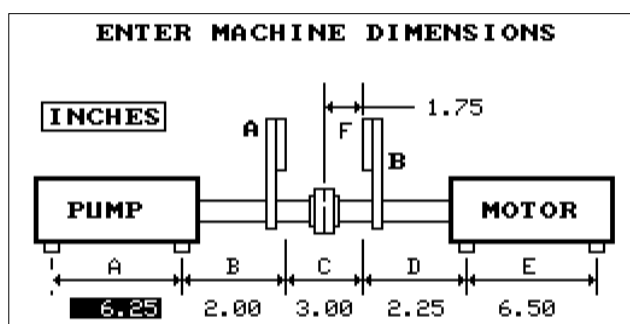

Machine Dimensions (A) Screen

Measure all of the dimensions to the nearest 1/8 inch (3 mm) with the exception of dimension C. Dimension C should be measured to the nearest 1/16 inch (1.5 mm). Refer to “Entering Fractions (Alignment Applications Only)” on page 2-17 for instructions on entering fractions into the system.

Use the Up/Down arrow keys to select the field you want to modify; press Enter to accept the entry. Refer to the following table for a description of each dimension.

### Note

The dimensions are the same for both the Model 8215 and 8225 laser heads.

Dimension	Measurement Description	Measure to Nearest
A	Center of outboard foot to center of inboard foot of the machine on the <b>left</b> .	1/8 inch (3 mm)
B	Center of inboard foot on the <b>left</b> machine to the sensor <b>head face</b> on the <b>left</b> machine. To enter a measurement for a foot that falls inside the laser face, place a negative sign (–) in front of it.	1/8 inch (3 mm)
C	Measure from the <b>inside face</b> of one sensor head to the <b>inside face</b> of the other sensor head.	1/16 inch (1.5 mm)
D	Center of inboard foot on the <b>right</b> machine to the sensor <b>head</b> on the <b>right</b> machine. To enter a measurement for a foot that falls inside the laser face, place a negative sign (–) in front of it.	1/8 inch (3 mm)
E	Center of outboard foot to center of inboard foot of the machine on the <b>right</b> .	1/8 inch (3 mm)
F	From <b>right</b> sensor head to <b>center</b> of coupling or, to the location where offset tolerances are measured (this is not required for jackshaft tolerances).	1/8 inch (3 mm)

---

**Note**

With large equipment, you may need to drop a plumb bob from the sensor head to measure these dimensions accurately.

---

## Thermal Growth, Vertical

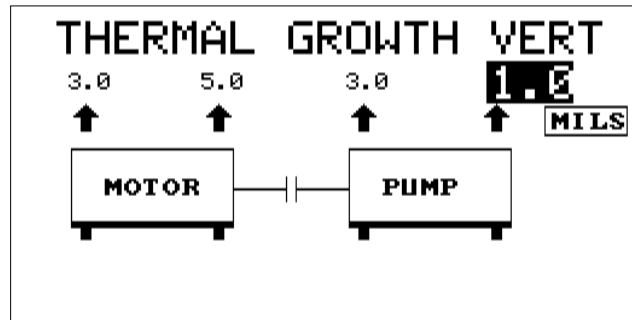

Thermal Growth (Vertical) Screen

This screen shows a side view of the coupled machinery. The amount of vertical thermal growth that both machines will experience during operation can be expressed in either mils or millimeters (mm). Thermal growth values should correspond to the amount each shaft will move in the vertical direction directly above each foot. If thermal growth is negligible, enter zeroes. The range of values that can be entered are -250 to 250 mils and -6.35 to 6.35 mm.

Press the Up Arrow or Down Arrow to toggle between the growth values. If one or both machines actually experience a downward growth during operation, negative numbers should be used. Press the Enter key to accept the vertical readings; then, the Thermal Growth Horizontal screen will appear.

---

### Note

The Thermal Growth screens only appear in the Job Definition section if Thermal Growth is set to Yes in the Options, Alignment Setup menu. Refer to "Alignment Setup" on page 3-6 for more information.

---

## Thermal Growth, Horizontal

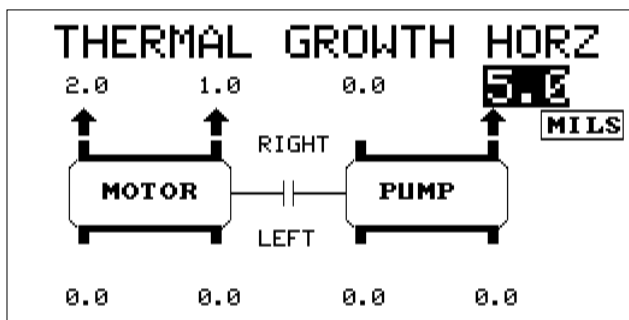

Thermal Growth (Horizontal) Screen

This screen shows a top view of the coupled machinery. Horizontal thermal growth can be entered in this top view of the coupled machines. Thermal growth values (mils or mm) should correspond to the amount each shaft will move at each foot. If thermal growth is negligible, enter zeroes at all locations. One entry field at each set of feet must be zero. The range of values that can be entered are 0 to 250 mils and 0 to 6.35 mm.

---

### Note

If negative horizontal thermal growth numbers are entered, the system will change them to positive numbers.

The Up Arrow will scroll from the right side to the left side at each set of feet, then onto the next set of feet to the right. The Down Arrow will scroll in the opposite direction. Press the Enter key to accept the values; you will then be returned to the Main menu.

---

### Note

Thermal Growth values measured by the UltraSpec Thermal Growth application can be transferred to the UltraSpec ProAlign Plus program. Refer to the UltraSpec Thermal Growth User's Manual for more information.



Loosen the hold-down bolt and wait for the dial to stop. Press any number key to accept that value; the cursor will move to the next foot. Retighten the bolt and proceed to the next foot. To remove results (clear data at a single foot) and acquire new data, press Delete. To remove results at all feet (clear data at all feet), press Alt/Delete.

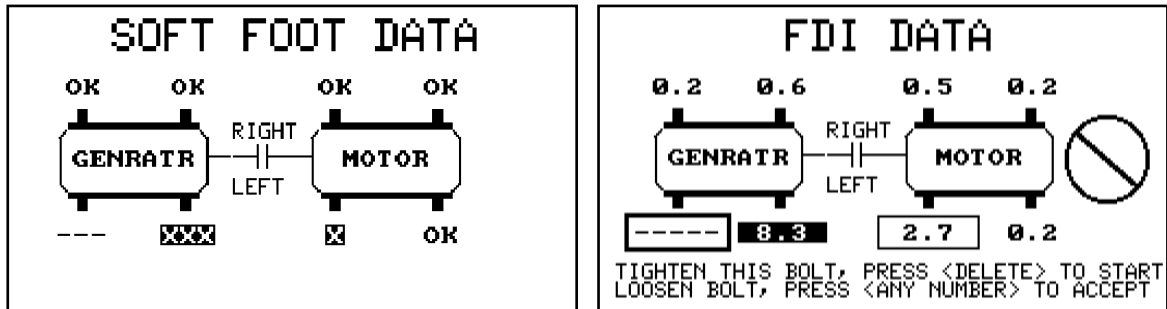

After all feet have been checked (CSI recommends that you always check *all* feet), press Enter and the data will be evaluated. The data is evaluated based on the type of Foot Pre-Check being used. If Soft Foot is selected, the data is evaluated as follows:

- “----” – no measurement was made for this foot
- “OK” – the measurement to determine Soft Foot is within the specified tolerance
- “x” – the measurement is from 1 to 2 times the specified tolerance (1x tolerance < measurement ≤ 2x tolerance)
- “xx” – the measurement is from 2 to 3 times the specified tolerance (2x tolerance < measurement ≤ 3x tolerance)
- “xxx” – greater than 3x tolerance

This method does not display a number as the machine is being checked for soft foot (to prevent you from mistaking this number for a shim correction).

If FDI is selected, the data is evaluated by default as follows:

- “----” – no measurement was made for this foot
- “No Box” – excellent condition (less than 2.0)
- “Clear Box” – acceptable condition (between 2.0 and 3.0)
- “Dark Box” – out of tolerance (greater than 3.0)

*These tolerances can be changed in UltraMgr and transferred to the UltraSpec.*

---

**Warning!**

**The numbers displayed are not the required correction shims for this foot. Soft Foot corrections frequently require wedge shaped arrangements of shims to be installed. However, the actual thickness and shape of the Soft Foot correction must be determined by using a feeler gauge.**

---

**Note**

For more information about Foot Pre-Check, see Appendix heading “Foot Pre-Check Types” on page -1

---

**Note**

Remember that all this data is dumped to UltraMgr. *Help messages are available if needed.*





---

## Alignment Data

This function, available from the main alignment menu, allows you to make the raw measurements needed for the calculation of the relative positions of the shafts. This section gives a brief overview of the available data collection modes. The next chapter gives an in-depth look at each mode.

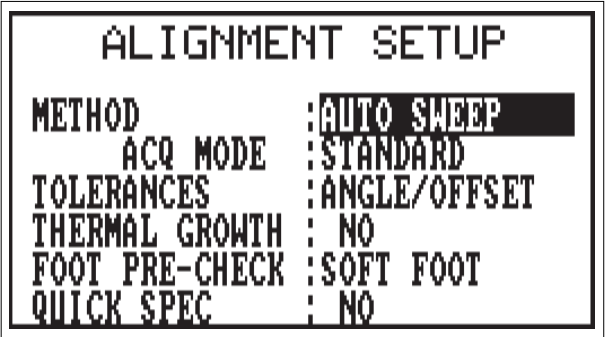

**Method:** to provide data acquisition for varying applications, circumstances, and preferences, a number of different data collection methods are provided. The method to be used is selected by entering the Alignment Options menu accessed by pressing the Options key and selecting Alignment Options. These include:

- **Auto Sweep** – data is automatically acquired while the shaft is rotated. The arc of rotation can vary from as little as 45° to a full 360° (one revolution). This mode is especially useful when the 4 point measurement technique is impractical or when inconsistencies in shaft position exist at points in the rotation. Averaging mode allows many revolutions, see details on page 6-7.
- **Manual Sweep** – data is measured each time the laser heads are in alignment and the number keypad is pressed. Data from up to 36 positions may be recorded. This mode is especially useful for performing uncoupled or non-rotational alignments. Functions similarly to the Auto Sweep mode except that the laser heads, or shafts, are stopped at each position where data is to be taken and a key pressed to store a reading.

- **4 Point Auto** – the four point automatic mode is a more traditional style of acquiring data for alignment. The laser heads are mounted on a shaft, and the shaft is then rotated so that data can be taken when the laser heads are at the 12 o'clock (0 or 360°), 3 o'clock (90°), 6 o'clock (180°), and 9 o'clock (270°) positions. The readings are continuously averaged whenever the laser heads are at one of these positions and automatically recorded when the shaft is rotated to the next position. The averaging process reduces variation from jitter due to background vibration or from slight changes in the angular position of the heads.
- **4 Point Manual** – similar to the 4 Point Auto mode except that the user has complete control over when data is acquired and which of the four measurement positions it will be used in. This mode is useful when the machinery is not mounted in a true horizontal orientation, so that the inclinometer is not effective *or* when the clock positions *relative to vertical and horizontal base movements of the machine* are non-standard.
- **Straightness** – allows the laser heads to be used to collect elevation readings for surface profile analysis.
- **Dual Pass** – functions similar to the Auto Sweep mode except data is automatically acquired as each laser head passes by each other. This mode, like Manual Sweep, is useful for performing uncoupled or non-rotational alignments.

---

## Data Quality

When using Auto Sweep, Manual Sweep, or Dual Pass a sine curve is fit to the data points to determine what the projected data would be at each of the clock positions mentioned above in the 4 Point Auto method. If the fit of the curve to the data points is marginal, then the data can be automatically conditioned to improve the sine fit. The resultant fit may be viewed and can be manually conditioned if desired. This procedure is discussed in the application chapter. If the analyzer is unable to condition the data suitably, then a message “UNFIT DATA” will appear on-screen warning the user to retake data or change data collection methods. There is always some variability introduced into data due to shaft clearances, bearing faults, base deterioration, etc. If this variability becomes significant compared to the amount of misalignment, it may become necessary to use a 4 Point or Manual Sweep Method to acquire data. Changing methods does not require the job to be redefined. Merely select a new method from the Alignment Options menu and retake the last set of data.

When using any 4 point method the data is always checked for validity. In theory, subtracting any third measurement from the sum of two opposing measurements will give the value of the 4th measurement (the one opposite the third measurement). For example, add the left and right measurements together, then subtract the top measurement. The results should approximately equal the value of the bottom measurement. If this comparison varies by more than 20%, a message will be displayed warning of a “Data Validity Error, Reading Error Above 20%”. When this happens you should retake the last readings to check for accuracy, before proceeding. There is always some variability introduced into data due to shaft clearances, bearing faults, base deterioration, etc.

---

## View Data

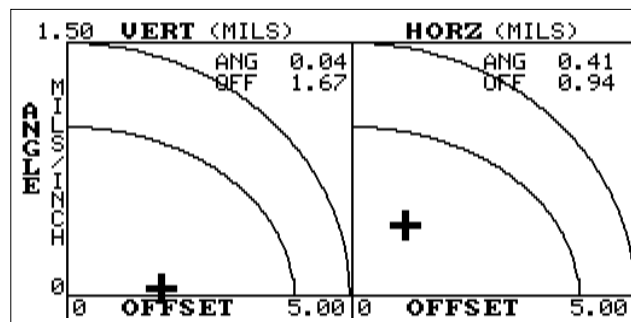

Dual Tolerance Plot

After acquiring data, the view data function allows you to check the acceptability of the current alignment. Both the vertical and the horizontal relationships are plotted as well as the calculated values for angle and offset or left angle and right angle. The bold crosshair shows the current condition, whereas a faint crosshair is drawn to show the previous position. Use the Up/Down arrow keys to change the plot scaling if needed. The area under the lowest arc is the excellent range. The area under the higher arc and above the lower arc represents the acceptable range. Pressing Enter will return the user to the main menu.

---

**Note**

If more than one set of alignment data has been acquired, the last two data sets acquired will have their current conditions displayed on this screen. The last data set will have its current condition represented by the bold crosshair while the previous data set will have its current condition represented by a crosshair that isn't bold. Individual plots displaying all alignment data sets acquired are available. Refer to "Additional Data Detail" on page 5-34 for details.

---

## Tolerances

The amount of offset and angular misalignment displayed is based upon the last full set of alignment readings. All shaft misalignment is a combination of offset and angular misalignment (see “Alignment Application Notes” on page 8-3). This screen breaks down the misalignment into each component. The amount of each type of misalignment is shown for both the horizontal and vertical directions (for horizontal machines). *These values are only used for tolerances therefore, only absolute values are used (no negative signs).*

### Standard

The combination of offset and angle is a direct indication of the alignment condition. Optimum alignment occurs when offset and angle are zero. In most cases, that degree of accuracy is not practical. For that reason, tolerances are used to set an achievable goal. CSI's recommended tolerances (referenced to RPMs) are listed in the table below.

Speed (RPM)	Excellent		Acceptable	
	Offset (mils)	Angle (mils/inch)	Offset (mils)	Angle (mils/inch)
< 500	5.0	1.5	6.0	2.0
500 - 1250	4.0	1.0	5.0	1.5
1250 - 2000	3.0	0.5	4.0	1.0
2000 - 3500	2.0	0.3	3.0	0.5
3500 - 7000	1.0	0.25	2.0	0.3
> 7000	.5	0.2	1.0	0.25

Values in the table are assumed to be pure offset or pure angle. However, in most cases, you will have a combination of the two and tolerances should account for this combination.

For example, for an 1800 RPM machine which has 3.5 mils of pure offset misalignment, the alignment is in the acceptable range. Or, if it has 0.80 mils/inch of pure angular misalignment, the alignment is acceptable. However, if the remaining misalignment is a combination of 3.5 mils offset and 0.80 mils/inch angular, the misalignment is not as good, and should be considered out-of-tolerance.

Plotting the condition as a single point on an X-Y graph provides a true indication of the alignment status.

The offset and angle information is intended to be used as an alignment tolerance only (to determine how close the alignment is based upon the last set of alignment readings); do not use these data to align the machines. For this reason, offset and angle are always displayed as positive numbers.

The curves at the lower left are the tolerances to shoot for. Depending on RPM, they can be modified in UltraMgr and then transferred to the analyzer.

The alignment condition (with respect to the tolerances) can be monitored by observing the tolerance target during the live move. The bullseye means you are within the excellent tolerance range. The middle band means you are within the acceptable range, but outside the excellent range. The outside band means you are within 1x - 2x of the acceptable tolerance.

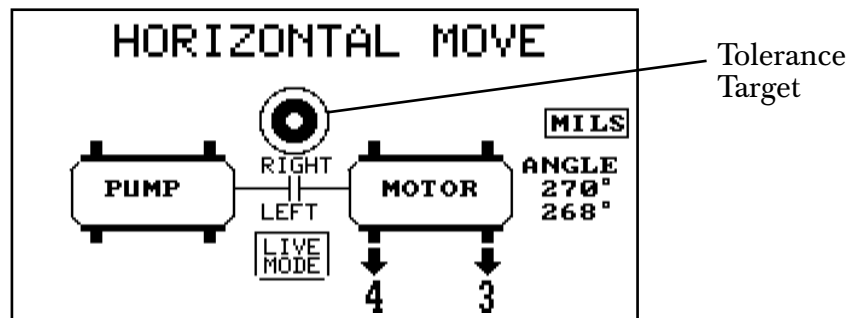

The example above shows that the alignment condition is in the acceptable range.

---

## Tolerance Example

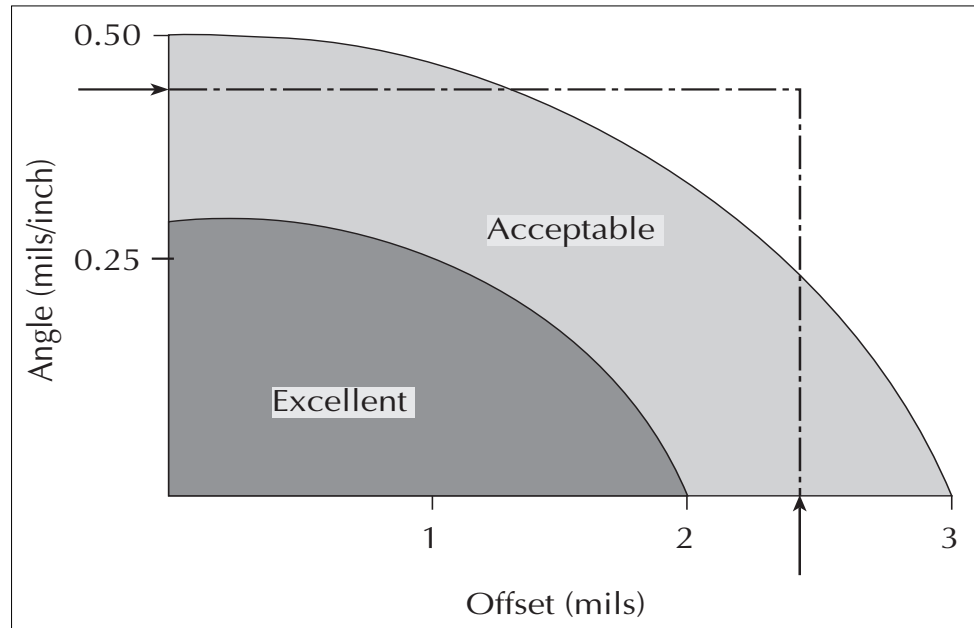

Tolerance Chart (2000 to 3500 RPM)

The chart above shows the Angle and Offset for a machine that operates at 2000 – 3500 RPM plotted together. A pure angle reading of 0.45 Mils/Inch and a pure Offset reading of 2.5 Mils are marked by the arrows. These readings are clearly in the acceptable range when looked at individually. However, look what happens when these two “acceptable” reading are plotted together. The two lines connect outside the acceptable range. This illustrates the importance of looking at the Offset and Angle together when establishing specified tolerances.



## Jackshaft

One of the biggest advantages in using a laser system is the ability to align over long distances ( $> 20''$ ). The further apart the sensor heads are mounted, the less practical it is to use the Offset and Angle Tolerances. In those cases, the Jackshaft Tolerances should be used. This method measures the two angles ( $\alpha$  and  $\beta$ ) as shown in the figure below. The combination of these two angles are laid out on a graph similar to the offset and angle graphic. When the angles are within tolerance, the cursor will be in the Excellent or Acceptable range.

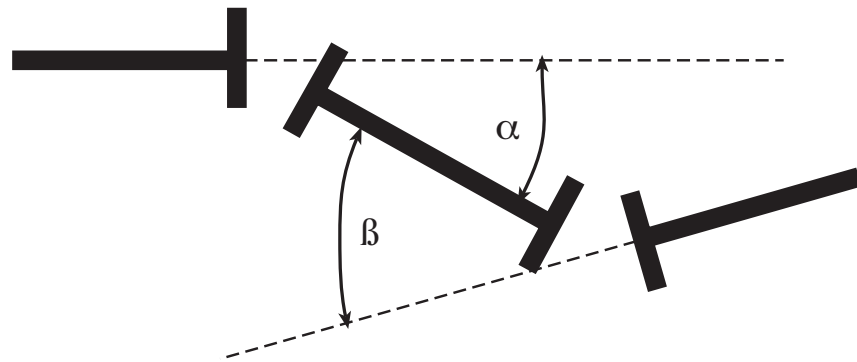

CSI's recommended tolerances are listed in the following table.

Speed (RPM)	Excellent	Acceptable
	Angle (mils/inch)	Angle (mils/inch)
< 500	1.0	2.0
500 - 1250	0.9	1.8
1250 - 2000	0.8	1.6
2000 - 3500	0.6	1.2
3500 - 7000	0.4	0.6
> 7000	0.2	0.3

---

## Additional Data Detail

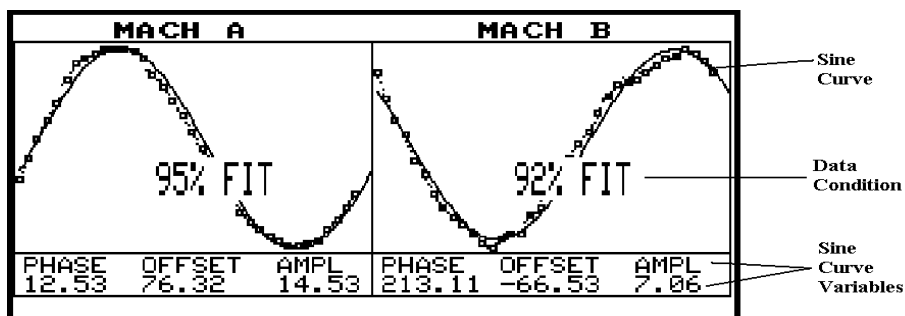

For users who want to view the acquired data in more detail, pressing the Page Down key when the dual plot is displayed (see “Dual Tolerance Plot” on page 5-28) will access additional screens.

**Sine Fit** – When Dual Pass or one of the sweep methods is used, the dual Sine Fit screen is displayed first. Points which are shown as boxes have been included in the fit to the sine curve. How well these points fit the sine curve is given as a percentage. Points which are shown as a single dot have been excluded from the fit.

Press the Alt/Left Arrow key to edit the left sine curve, and press the Alt/Right Arrow key to edit the right sine curve. Press the Left or Right Arrow key to move the cursor to individual points (one point at a time). Use the Up or Down Arrow key to move the cursor to individual points 10 points at a time. The measured values for the point selected by the cursor is shown at the bottom of the plot. An asterick (\*) displayed next to the point number indicates that point has been excluded or deleted from the fit.

A point may be excluded from the fit by placing the cursor over it (using the Arrow keys to position the cursor) and pressing the Delete key. The box will become a point indicating it is not considered in the curve fit. Press the Alt/Delete key to undelete all deleted points and refit the sine curve to its original condition. A previously excluded point may be included by placing the cursor over the point and pressing the Insert key. Each time a point is removed or added the sine fit will be recalculated. Press the Alt/Left Arrow key and the Alt/Right key to move the cursor between the first and last points.

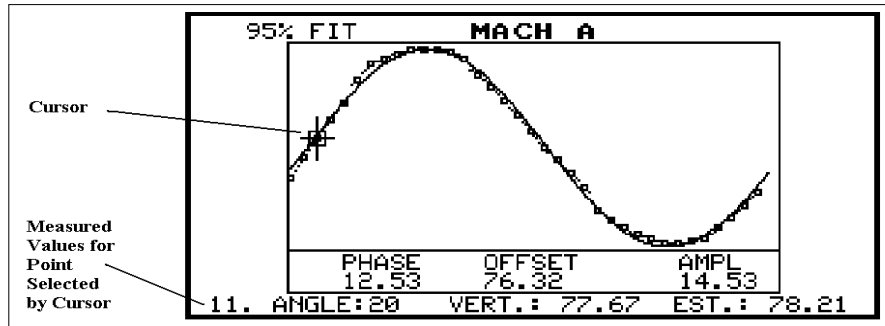

CSI does not recommend making moves based on sine fit percentages of less than 70%. Although sine fits of 70 to 85% can be used, CSI recommends another set of readings be made to try and improve the accuracy. Sine fits above 90% provide the highest repeatability.

**Note**

Although up to 180 data points can be acquired, not all the data points are fit to the sine curve. The data points fit to the sine curve (up to a maximum of 36) are selected so they are evenly spaced over the acquired sweep area. Therefore, when editing a sine curve no more than 36 data points can be inserted.

From the dual Sine Fit screen, press Enter to leave this screen and display the Sine Fit Status screen.

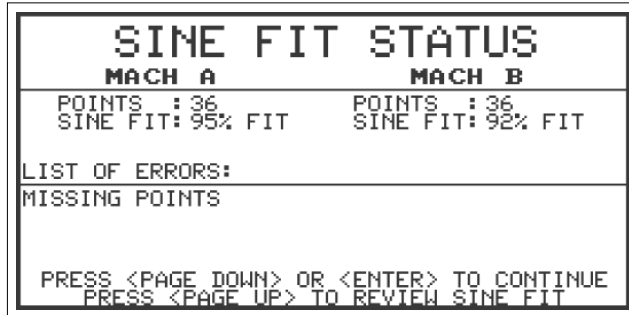

Sine Fit Status Screen

**Sine Fit Status** – this screen summarizes the number of points used, percentage of fit, and lists factors (errors) which could be corrected to improve the data. From the Sine Fit Status screen, press Enter to leave this screen and display the View Data Screen.

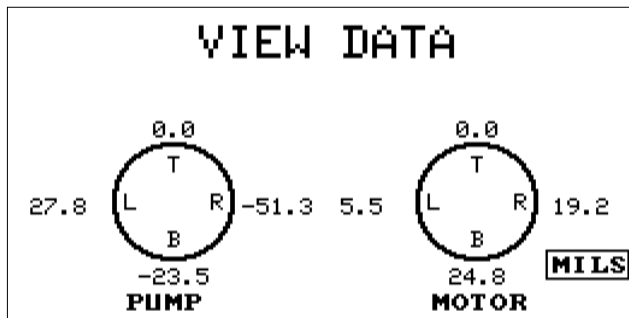

View Data Screen

**4 Point - View Data** – this screen appears first if using the 4 point methods or immediately following the sine fit information if using the sweep methods. Data cannot be edited and is simply provided for the convenience of those who are accustomed to recording the data in this manner or who wish to use this data to perform a graphical solution on paper. To see the “raw data,” (the position of the beam on each target) press the 0 key. To return the top reading to zero, press the 0 key again. Press Enter to leave this screen.

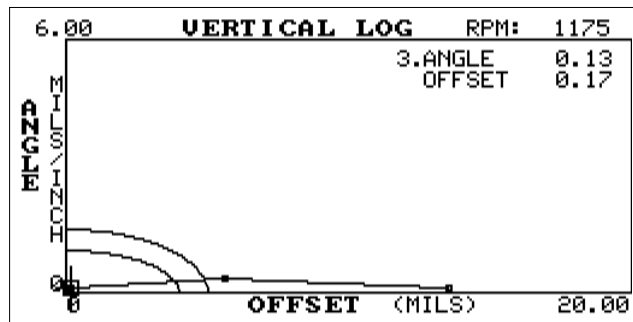

**Vertical Log** – this is an enlarged version of the vertical plot shown on the dual plot. In addition to the misalignment based on the two most recent alignment measurements, all previous measurements are shown. The Left/Right arrow keys may be used to move a cursor to each plotted point. The corresponding angle and offset will be displayed. The Up/Down arrows can be used to change the overall plot scaling.

To view the Acceptable and excellent tolerances press the Alt and Page Up keys. To return to the optimum scale press the Alt and Page Down keys.

**Horizontal Log** – press the Enter key to exit the vertical log and display the horizontal. The arrow keys perform the same cursor and scaling functions as for the vertical plot. Pressing Enter at this screen returns to the program's main menu.

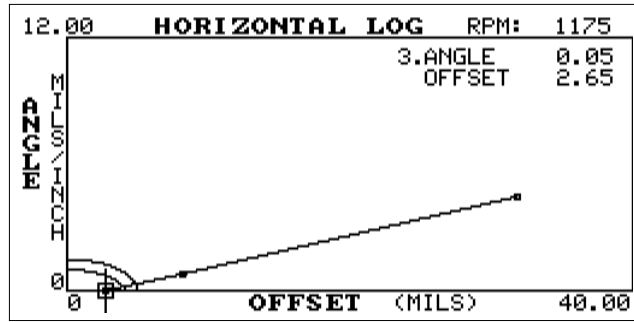

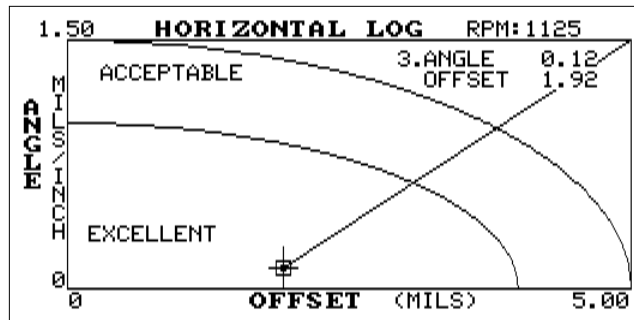

To view the Acceptable and Excellent tolerances, press the Alt and Page Up keys. To view all the reading sets at the optimum scale, press the Alt and Page Down keys. To increase or decrease the scale by a factor of two, press the Up and Down arrow keys.

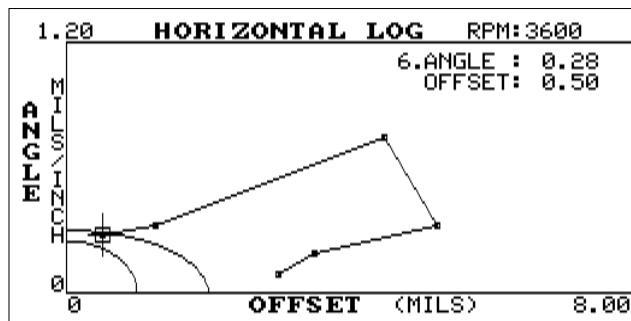

Horizontal Log Display

Once you have reached the tolerance targets, your machinery should operate correctly without any adverse effects from misalignment.

The offset and angle information is intended to be used as an alignment tolerance only (to determine how close the alignment is based upon the last set of alignment readings); do not use this data to align the machines. For this reason, offset and angle are always displayed as positive numbers.

---

## Storing Data Sets

From View Data the alignment readings and machine moves will be automatically recorded and stored when the Enter key is pressed to exit from either the dual tolerance plot or the Horizontal Log screen if viewing additional data details. This step returns you to the program's Main menu. When the readings and moves are recorded, a screen listing the number of readings recorded for the current alignment job will appear for a few seconds.

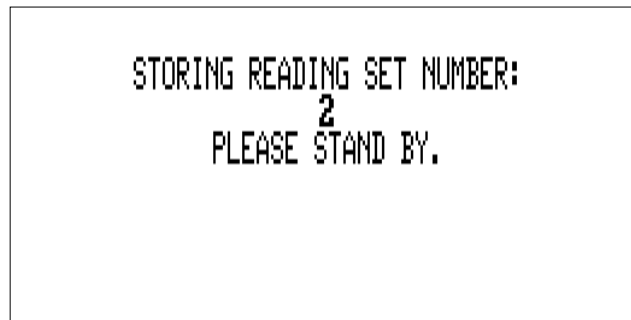

A maximum of 20 readings can be stored per alignment job. The current alignment readings must be different from the previous set for the readings to be recorded. If more than 20 readings are acquired a message is displayed giving you the option of either discard the last reading taken or overwriting the 20th reading with the last reading.

---

### **Note**

If you decide to overwrite the 20th reading with the last reading, it cannot be retrieved.





---

## Machine Moves

After defining the job, checking the foot pre-check, collecting alignment data, and viewing the analysis of the alignment data, you are ready to see what machine moves are required. This section shows the screens and information that are available.

While in the Machine Moves section, in addition to viewing the required corrections, you can watch them being made in live mode (and view six different solutions in each plane – horizontal and vertical). Within the vertical and horizontal logs, you can see how the present alignment condition compares to the tolerances goal you are shooting for.

Use the Enter key to first view the Vertical Move, and then the Horizontal Move. A bullseye on each of the move screens displays the corresponding tolerances. The alignment readings and machine moves will be automatically recorded when the Enter key is pressed to exit from the Horizontal Move screen.

When the readings and moves are recorded, a screen listing the number of readings recorded for the current alignment job (maximum of 20) will appear for a few seconds. The number of readings recorded will also be displayed in the lower right of the Main menu screen.

---

**Note**

The alignment readings must be different from the previous set for the current set of readings to be recorded.

---

Vertical Move

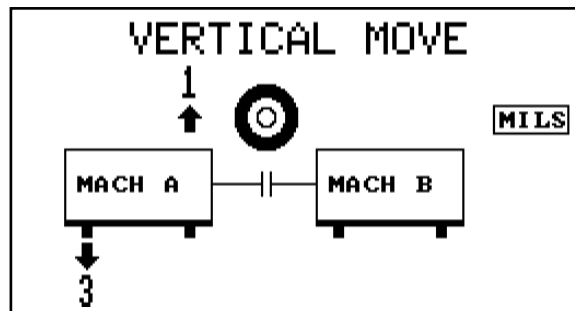
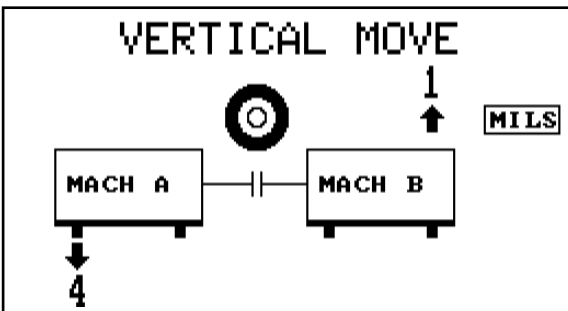
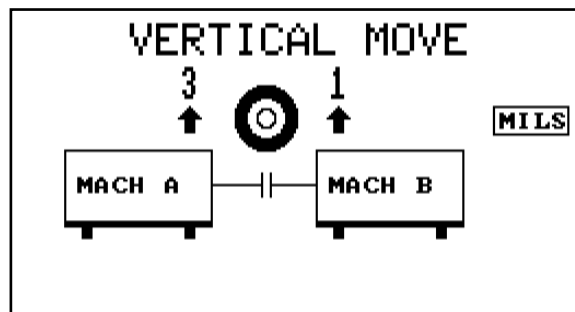
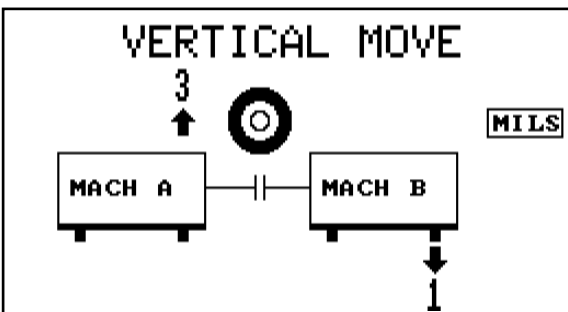
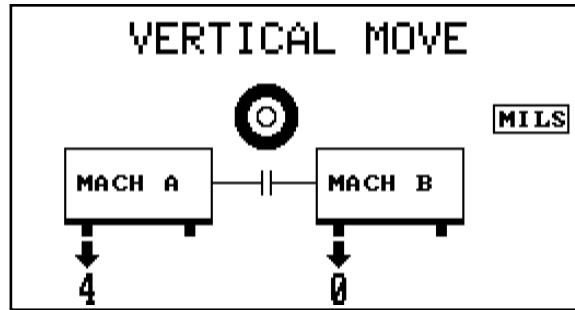
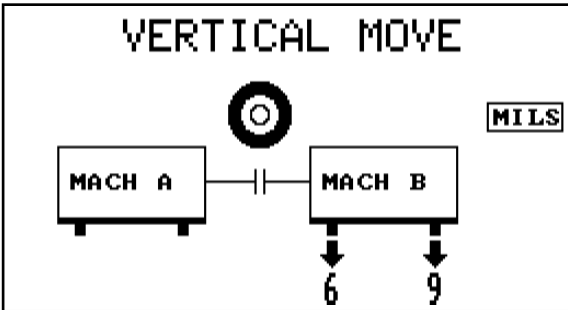

One of the six screens shown on the previous page (side view) will be displayed when entering the Machine Move section. Each screen shows a separate solution to bring the equipment into alignment. Solutions are expressed in mils or millimeters and show the direction the equipment should be moved.

To select the screens, press the Left/Right Arrow to toggle through them. *Except* for first reading sets, all the screens default back to the solution arrangement they were in when last used. *For* first reading sets, the left machine will normally be selected. However, when Motor or Move are on the right side, they will be selected.

The target indicates how close the machine horizontal or vertical positions are to being in tolerance. The center (bullseye) indicates an *excellent* range. The middle ring represents an acceptable range. The outer ring represents  $> 1$  times and  $< 2$  times the acceptable range. No ring highlighted indicates  $> 2$  times acceptable range.

Press the Enter key to proceed to the Horizontal Move screen.

---

**Note**

Even though it isn't indicated on the Vertical Machine Moves screen, it is possible to perform a live move in the vertical direction. Refer to "Using Live Mode" on page 5-45 for details.

---

## Horizontal Move

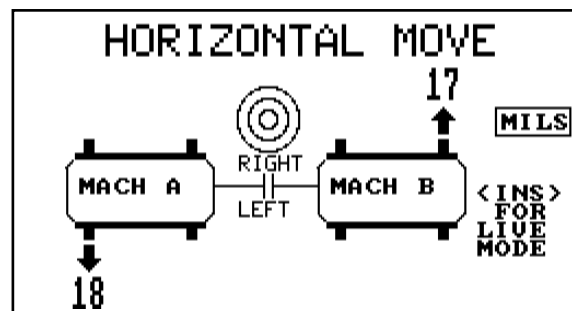
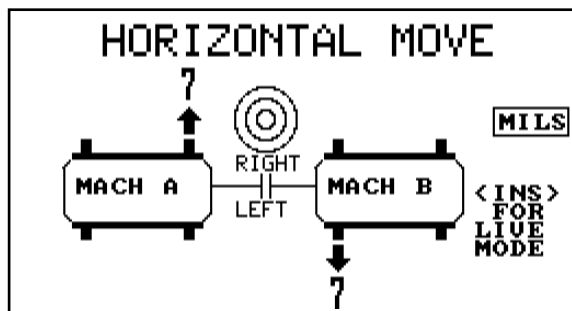
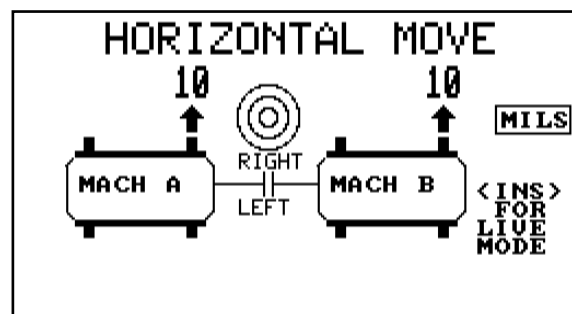
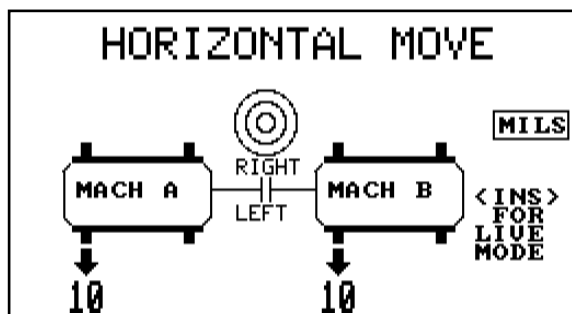
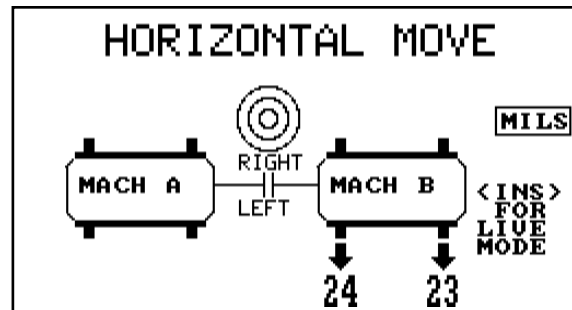
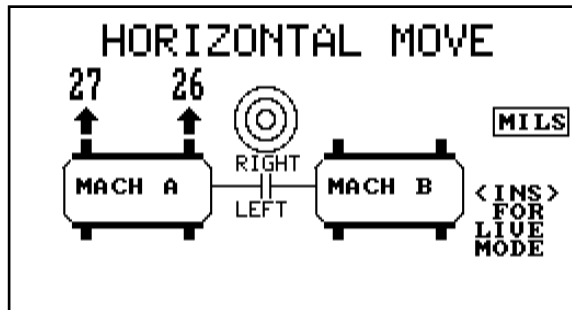

One of the six screens shown on the previous page (top view) will be displayed when entering the Horizontal Move section. Just like the Vertical move section, each screen shows a separate solution to bring the equipment into alignment. Solutions are expressed in mils or millimeters and show the direction the equipment should be moved.

The target indicates how close the machine horizontal or vertical positions are to being in tolerance. The center (bullseye) indicates an *excellent* range. The middle ring represents an acceptable range. The outer ring represents  $> 1$  times and  $< 2$  times the acceptable range. No ring highlighted indicates  $> 2$  times acceptable range.

To select the screens, press the Left/Right Arrow to toggle through them. *Except* for first reading sets, all the screens default back to the solution arrangement they were in when last used. *For* first reading sets, the left machine will normally be selected. However, when Motor or Move are on the right side, they will be selected.

To exit Machines Moves and return to the Main menu, press the Enter key. To enter Live Mode, see “Using Live Mode” below.

---

### Using Live Mode

To activate the live mode in either the Vertical or Horizontal direction, press the Insert key. The analyzer will prompt you to position the fixtures to any rotational position.

Place the fixtures at any rotational position and press <Delete> to start.

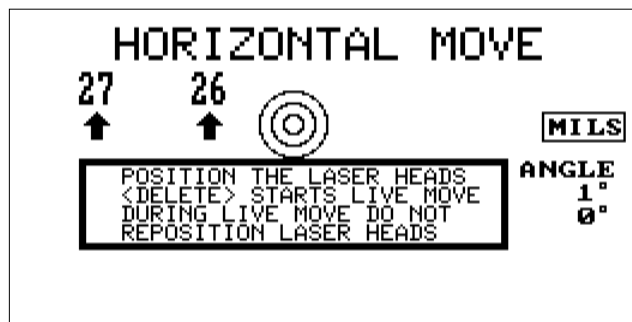

---

***Warning!***

**Do not change the rotational position after <Delete> is pressed. This will cause the move to be incorrect.**

---

***Warning!***

**Do not loosen the machine feet hold down bolts until after you have entered Live mode (after the Delete key has been pressed). Loosening the hold down bolts prior to entering Live mode can cause the move to be incorrect.**

---

***Note***

The angular position information *of the laser heads* is shown to the right of the machines.

After the fixtures are in the chosen rotational position, press the Delete key to start the live mode, and then move the machine(s) until they are within tolerance.

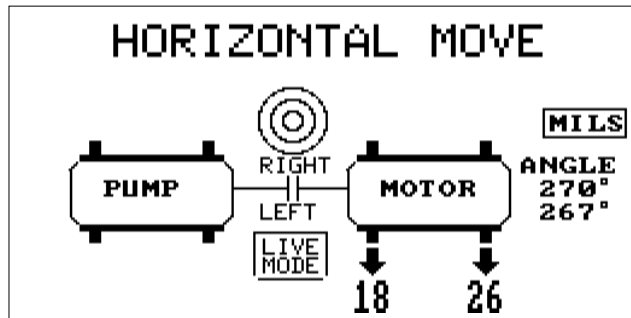

Live Mode active with machine position more than 2 x out of acceptable tolerance

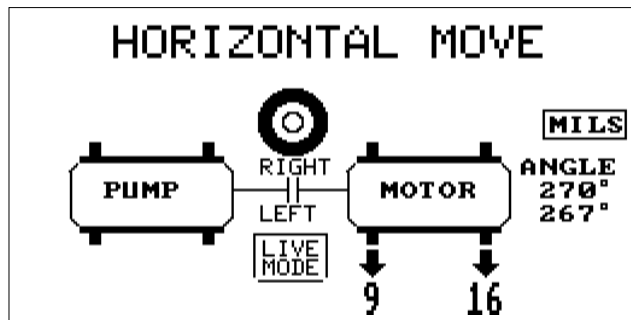

Live Mode active with machine position more than 1 x but less than 2 x out of acceptable tolerance

**Warning!**

When the machine(s) are within tolerance, before exiting the Live mode, tighten the machine hold down bolts. If readjustments to the machine(s) remain within tolerance when the hold down bolts are tightened, then press the Enter key to exit Live mode and return to the Machine Moves screen.

---

**Warning!**

**Do not** use a hammer to move machines. These impacts may move either sensor head, causing improper machine positioning. CSI recommends that you use jack bolts (permanent or portable).

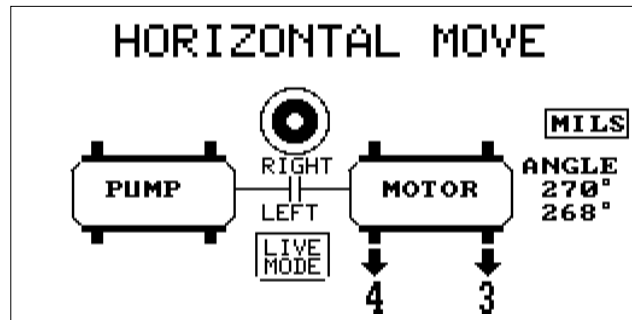

Live Mode in acceptable range

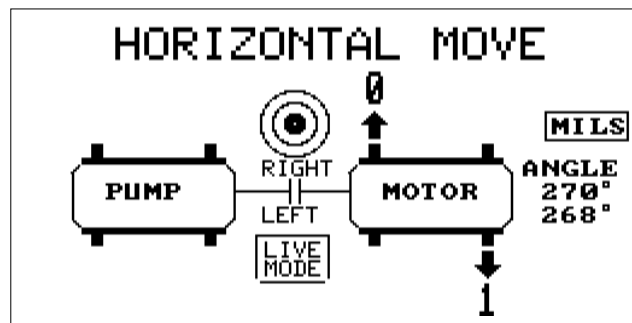

Live Mode in excellent range



If a live move is done in the vertical direction, if you go directly to the Horizontal Move screen (or visa versa) and press the Insert key to start the Live Mode, the following message will be displayed.

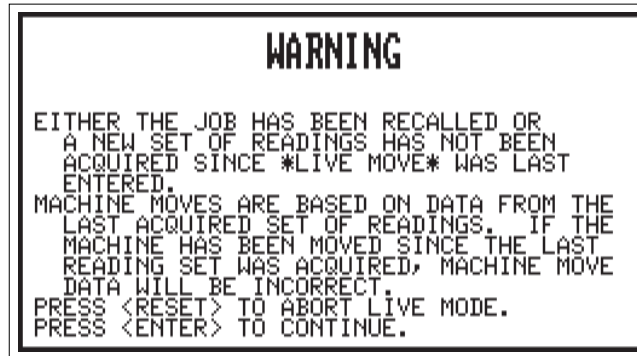

Once a live move is done in either the vertical or horizontal direction, a second live move should not be done in the opposite direction without first acquiring a new set of laser readings.

If this situation occurs, press the Reset/Main key to abort the Live mode and return to the Main menu or press Enter to continue with the Live mode.

---

**Note**

This message is also displayed on a recalled alignment job if a new set of data has not been acquired since the job was recalled.



## Acquiring Alignment Data

---

### ◆ Data Collection Methods - Overview

In this chapter, we will examine each of the modes which can be used for acquiring alignment data for the purpose of shaft alignment. It is assumed that you have previously read the chapter “Using UltraSpec Alignment - General Overview” on page 5-1. Therefore, this chapter does not explain the various functions such as Job Definition and Soft Foot analysis which are common to all modes.

---

**Note**

Use of the Straightness mode is discussed in “Straightness Application” on page 7-1.

---

#### 4 Point Methods - General Information

There are two fundamental methods by which the data is acquired for shaft alignment calculations, the 4 point modes and the sweep modes. The 4 point modes require data to be taken at positions perpendicular and parallel to the axis in which the machine’s position can be adjusted horizontally. This is sometimes called the clock method and most often uses data readings at 12 o’clock (0 or 360°), at 3 o’clock (90°), at 6 o’clock (180°), and at 9 o’clock (270°). This is typical of the data acquired by those trained in using a scaled graph to manually arrive at an alignment solution using the reverse dial indicator method.

When using the 4 point methods, ideally, the sum of the two horizontal measurements will equal the sum of the two vertical measurements. This relationship may be used to check the data for validity. Any variance greater than 10-20% is a cause for concern. When this occurs, repeat the readings to verify that a variation wasn't accidentally introduced by the user. For example, by using the fixtures as levers to turn the shaft or by not controlling the torsional play in the coupling. Damaged regions in rolling element bearings and shaft rubs could also cause problems, but are less common.

Because of this same mathematical relationship, having any 3 of the 4 points would allow the fourth point to be calculated. This can be useful when obstructions only allow you to rotate the laser fixtures to three of the four clock positions. Unfortunately, estimating the fourth point like this removes the ability to check the validity of the data. Abnormal readings at any one of the three known points could cause error. Therefore, use this technique with caution and only when absolutely necessary. CSI recommends using a partial sweep method rather than the three 90° clock points if the arc of rotation is restricted.

---

### **Sweep Methods - General Information**

The sweep modes use data acquired at several different angular positions. By using CSI's patented process, this data is translated into readings for the four clock positions. There are several advantages to the sweep method over the 4 point method of acquiring data. Data does not have to be acquired at 3 or 4 specific angular locations; any angular positions will work. More data points are used to arrive at the true rotational behavior of the shaft, therefore a discrepancy in one area of the rotation does not have as great an effect. If a full rotation of the shaft is not possible, the three point method still requires at least 180° of shaft rotation, which must begin at one of the four designated positions; the sweep method can use rotations less than 90° starting from any position. However, keep in mind that no matter what method is used, reconstructing a complete picture using partial data is never as desirable as starting with a complete picture.

When using the sweep mode calculations are completed in the following manner. If readings were taken from each laser target at 1° intervals (with the position as the Y- axis and the rotational position as the X-axis), a sine wave would be formed. Even when only part of the sine wave is completed, UltraSpec Alignment software can complete the remainder of the curve. Called curve fitting, all values used to determine the machine moves can be obtained from the completed sine waves.

CSI recommends you sweep at least 90°, however accuracy may be reduced even at 90°. At the very least, this could result in more machine moves being required to achieve satisfactory alignment. Each head will store up to 180 readings (the higher the number, the greater the accuracy), however, all 180 readings are not required to determine the sine wave. You must have at least three readings and they should be spaced at large intervals in the shaft rotation.

After the sweep data has been transferred from the heads to the analyzer, the data will be automatically curve fit. The quality of the data is shown by the curve fit percentage. If more points are located off the sine wave (the greater distance from the curve), the lower the percentage will be. A high number of points on the curve means that most of the data were acquired from points that lay on the sine curve.

Bearing faults, rubs, and looseness are all problems which can cause points not to fall on the curve. These mechanical problems can cause all data to have some low levels of variability. This variability may appear as randomness, or “noise”. This noise is not generally of much concern when the level of misalignment is high, however, as the amplitudes measured from misalignment decrease, *the ratio of noise to the signal increases and the percentages of fit may worsen*. Although the program will automatically condition the data for an improved fit in such a circumstance, there may be times when the user chooses to change methods or to manually condition the data using the View Data function (see Sine Fit under “Additional Data Detail” on page 5-34).

---

## Quick Spec

This option is set in the Alignment Setup menu and is accessed by using the Options key. When set to Yes, Quick Spec works with any selected shaft alignment method to give an abbreviated means of checking whether the machine alignment is in tolerance. If the machine alignment is unacceptable, you can provide additional machine dimensions and continue as a normal alignment.

---

### **Note**

Refer to “Quick Spec” on page 6-33 for additional information about using Quick Spec.

---

## Auto Sweep

Since they have built-in inclinometers, CSI's laser fixtures allow data to be automatically acquired while the shaft is rotated. The arc of rotation can vary from as little as 45° to a full 360° (one revolution). This mode is especially useful when the 4 point measurement technique is impractical or when inconsistencies in shaft position exist at points in the rotation. With the Auto Sweep method, data readings or values are automatically acquired and stored in the laser heads every 2 degrees; therefore, in a 360° sweep it is possible to acquire up to 180 data readings per laser head.

---

### Note

Although it is possible to acquire up to 180 data readings, not all of the data readings are used to calculate the machine's alignment condition. Refer to "Additional Data Detail" on page 5-34.

To acquire data using the Auto Sweep method, you must first select Auto Sweep as the method from the Alignment Setup menu (accessed by pressing the Options Key). Once this method is shown, using the Up/down Arrow keys to select and the number keys on the keypad to toggle the selection, set the Acquisition (ACQ) Mode to either Standard or Averaging.

**Standard** - this mode of operation (sometimes referred to as the Unidirectional Mode) is the mode that is most often used during Auto Sweep alignments. In this mode, a direction of rotation is automatically defined for data acquisition based on the first rotation to progress past the starting point by 20 degrees. In the Standard Mode, data acquired in the Data Acquisition Direction of Rotation will always overwrite any previous data stored at the same angular position. This includes data acquired at its defined angle position. In this mode of operation, once the direction of rotation is defined by the laser heads, only the data in that direction of rotation will be acquired; therefore, any backward rotation of the shaft due to backlash will not be acquired and thus will not affect the alignment results. The following scenario illustrates this more clearly.

1. ... When the analyzer initializes the laser heads, all data is cleared and their current position is defined as the Starting Point for determination of the data collection direction.
2. ... If the laser heads are rotated less than 20 degrees in the counter-clockwise position from the defined starting point, data is collected for this rotation but it is not committed and permanently stored.
3. ... If the counter-clockwise rotation is stopped before the 20 degrees and laser heads are now rotated in the clockwise direction, data will be ignored (not acquired) until the Starting Point is reached again. At this point all data collected in the counter-clockwise direction is cleared and the data acquisition is started in the clockwise direction.
4. ... This mode of operation will continue as long as the laser heads are rotated in both the clockwise and counter-clockwise directions until a rotation of more than 20 degrees occurs in one of the directions of rotation. Once the 20 degrees point is passed, all acquired data is committed and stored and the direction of rotation is defined as the Data Acquisition Direction of Rotation.
5. ... Now data will only be acquired when the laser heads are rotated in the same direction as the defined Data Acquisition Direction of Rotation.



**Averaging** - this mode of operation is intended to allow multiple sampling of data in order to reduce the noise in the data by averaging all of the acquired values. In the Average Mode, a Data Acquisition Direction of rotation is defined in the same manner as it is in the Standard Mode. However, instead of always over-writing the last data reading stored at the same angular position, it will be averaged with previous readings if the laser head has been moved at least 20 degrees in the reverse direction or a full 360 degree sweep is performed. In this mode of operation, once the direction of rotation is defined by the laser heads, only the data in that direction of rotation will be acquired; therefore, any backward rotation of the shaft due to backlash will not be acquired and thus will not affect the alignment results. The following scenario will clarify the intended operation.

1. ... Assume that the Data Acquisition Direction of rotation is defined as clockwise (see scenario for Standard Mode).
2. ... If the laser heads are rotated in the clockwise direction to an angle of 50 degrees, data is acquired and stored for each angular position in this rotation.
3. ... If the laser heads are then rotated in the counter-clockwise direction for 10 degrees (back to an angle of 40 degrees), all data acquired is ignored in the counter-clockwise direction since the direction of rotation is not in the Data Acquisition Direction of rotation.
4. ... If the laser heads are again rotated in the clockwise direction for 25 degrees (to an angle of 65 degrees), the data acquired for each angular position will over-write the previous data acquired because the angle of negative rotation was not at least 20 degrees.
5. ... If the laser heads are then rotated in the counter-clockwise direction for 30 degrees (back to an angle of 35 degrees), all data is ignored because of the direction of rotation.
6. ... Now if the laser heads are rotated in the clockwise direction for 360 degrees. The data for the angular positions in the range 36 - 65 degrees will be averaged with the previous values since there has been a rotation of at least 20 degrees away from the stopping point. The data for the angular positions in the range 66 - 359 degrees will receive a data value since the direction of rotation is correct. The data angular positions in the range 0 - 35 degrees will be averaged with the previous values since the rotation in the clockwise direction passed the starting point (i.e. 360 degree sweep).

The current alignment method is always shown at the bottom center of the main menu. Once the job has been defined and any soft foot has been corrected (if necessary), prepare to measure the misalignment by selecting Alignment Data from the Main Menu.



With Alignment Data highlighted, press the Enter key to start the data acquisition procedure. The following screen will be displayed.

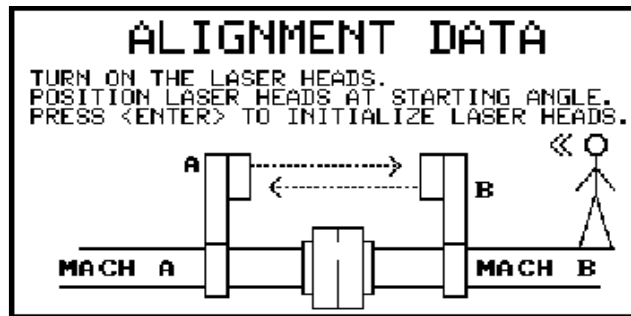

The next screen directs you to turn on the laser heads, position them at any angular position you desire to start from, and then press the enter key to initialize the laser heads. It is not required to define a sweep arc range and direction of rotation due to the increased number of data readings acquired every 2 degrees and the process, which automatically defines the direction of rotation. Once the laser heads are initialized, the next screen appears prompting you to now acquire the data by rotating the laser heads. After the laser heads have been rotated, press the Enter key transmit or transfer the data from the laser heads to the analyzer.

**Note**

For the greatest accuracy and repeatability, all readings should be acquired using the same direction of rotation. In addition, it is best to use the same direction of rotation as the machine normally operates.

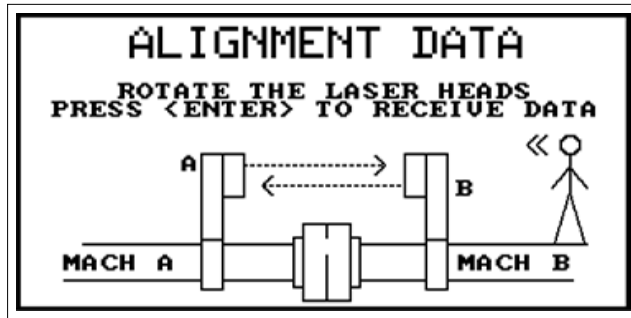

The 8215/8225 laser fixtures are designed to be rotated a full revolution in two seconds. As with any sweep, a smooth, uniform acceleration and deceleration during the rotation of the laser heads is necessary for accurate, reliable, and repeatable data. During the transfer, the "Receiving Data" screen will be displayed showing the progress of the data transfer for each laser head.

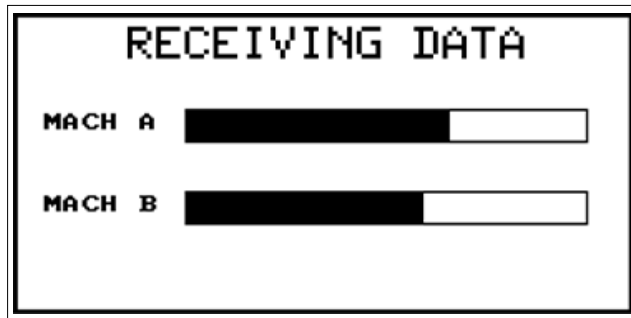

When the data transfer is complete, an Analysis in Progress screen similar to the following is displayed while the data is curved to fit a sine wave. If the fit is satisfactory (85% and above), you are returned to the main menu where the data may now be viewed.

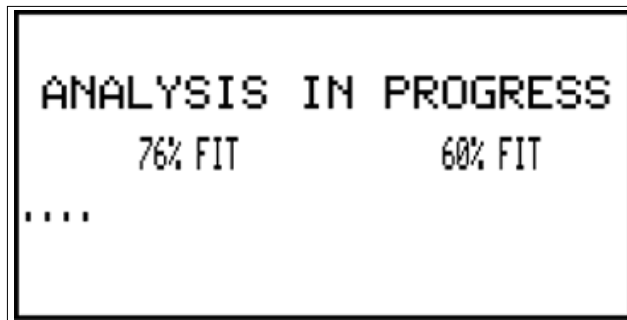

Otherwise, you are warned that the data is “Unfit” (less than 85%). At this point you should either repeat the data acquisition or try to manually condition or edit the data. This built-in check helps alert you to the data losing reliability in the misalignment calculations. Refer to “Additional Data Detail” on page 5-34 for more information.

---

**Note**

Remember, when shaft movement due to other than misalignment is present in the data this will appear as a randomness (noise) in the data. This is not normally a problem when the misalignment is great, but will increasingly interfere as the misalignment decreases. therefore, the better the alignment, the more likely the chance of seeing the Unfit data warning.

If you do encounter a machine where this becomes a problem too great to overcome, consider switching to an alternative method such as Manual Sweep or 4 Point Auto.

---

## Manual Sweep

Manual Sweep functions similarly to the Auto Sweep mode except that the laser heads, or shafts, are stopped at each position where data is to be taken and a key pressed to store a reading. Data from up to 36 positions may be recorded. This mode is especially useful for performing uncoupled or non-rotational alignments. This is the recommended sweep method for sweeps that are  $<75^\circ$ .

The current alignment method is always shown at the bottom center of the screen. The alignment method is selected from the Alignment Setup menu which is accessed using the Options key. Once the Manual Sweep method is shown, using the Up/Down Arrow keys to select and the number keys on the keypad to toggle the selection, set the sample rate.

**Sample Rate** – determines the number of data samples that are to be collected and averaged together to produce a single Laser PSD reading. Use the Left and Right Arrow keys to toggle sample rate from 1 to 25 samples. The default is 2.



Manual Sweep Measurement Method

After the job has been defined and any soft foot condition corrected (if necessary), select Alignment Data to acquire a new set of shaft readings.

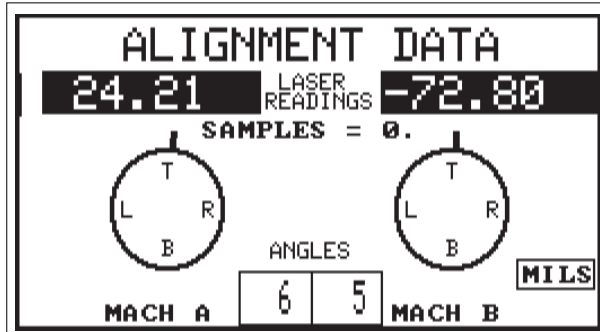

The current laser readings are shown in reverse video just below the screen title line. The current laser head position is shown graphically by a heavy black line on the circles and numerically by the degree readings at the bottom of the screen.

When the head positions and data are as desired press any number key on the keypad to record data at the given point. The number of samples, shown at the center of the screen, will increment by one (36 max).

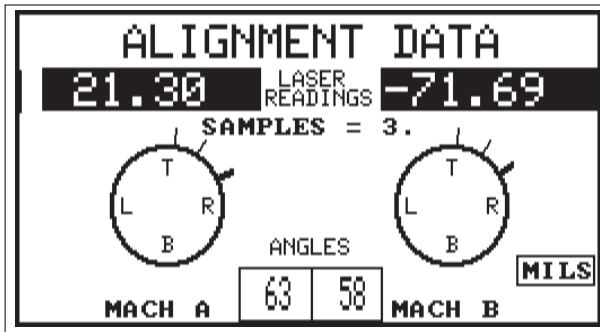

Each time a data point is recorded and the heads are rotated to a new position, a thinner line is left behind to denote where data was acquired.

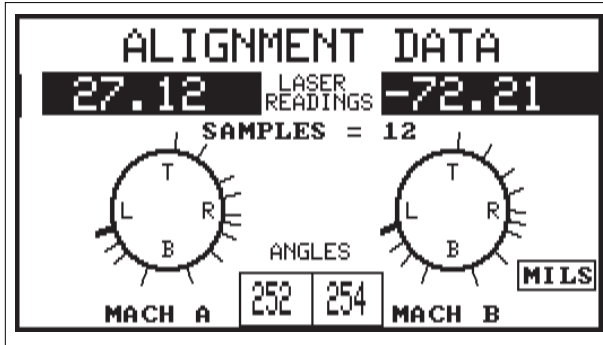

**Note**

A minimum of three data points over a 45° sweep arc is required, but CSI recommends a minimum of 8 data points (samples) acquired over a sweep arc of at least 90°.

When all the desired samples (36 max.) have been acquired, press the Enter key to accept the data. An "Analysis In Progress" screen similar to the following is displayed while the data is curve fit to a sine wave. If the fit is satisfactory (85% and above), you are returned to the main menu where the data may now be viewed.

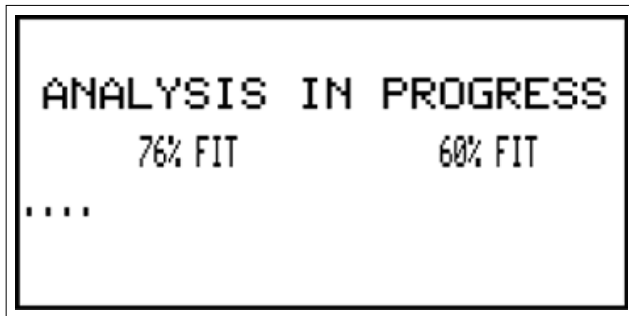



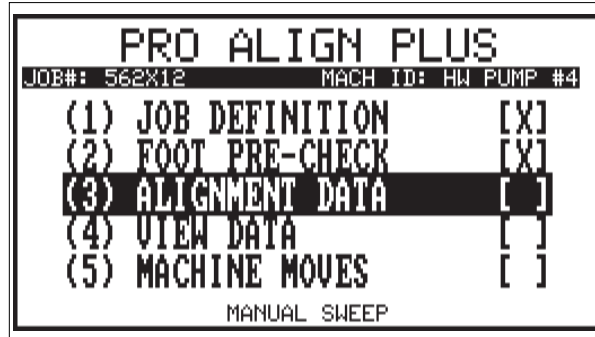

Otherwise, you are warned the data is “Unfit” (less than 85%). At this point you should either repeat the data acquisition or try to manually condition or edit the data. This built-in check helps alert you to the data losing reliability in the misalignment calculations. Refer to “Additional Data Detail” on page 5-34 for more information.

---

**Note**

For the greatest accuracy and repeatability, all readings should be acquired using the same direction of rotation. In addition, it is best to use the same direction of rotation as the machine normally operates.

---

**Note**

Remember, when shaft movement due to causes other than misalignment is present in the data this will appear as a randomness (noise) in the data. This is not normally a problem when the misalignment great, but will increasingly interfere as the misalignment decreases. Therefore, the better the alignment the more likely the chance of seeing the Unfit data warning.

If you do encounter a machine where this becomes a problem too great to overcome, consider switching to an alternative method such as 4 Point Auto.

---

## 4 Point Auto

The 4 Point Auto method is a more traditional style of acquiring data for alignment. The laser heads are mounted on a shaft, and the shaft is then rotated so that data can be taken when the laser heads are at the 12 o'clock (0 or 360°), 3 o'clock (90°), 6 o'clock (180°), and 9 o'clock (270°) positions. The readings are continuously averaged whenever the laser heads are at one of these positions and automatically recorded when the shaft is rotated to the next position. The averaging process reduces variation from jitter due to background vibration or from slight changes in the angular position of the heads.

The current alignment method is always shown at the bottom center of the screen. The alignment method is selected from the Alignment Setup menu which is accessed using the Options key. Once the 4-point method is shown, set the sample rate. Use the Up and Down Arrow Keys to select the sample rate and the Number keys on the keypad to toggle the selection.

**Sample Rate** – determines the number of data samples that are to be collected and averaged together to produce a single Laser PSD reading. Use the Left and Right Arrow keys to toggle sample rate from 1 to 25 samples. The default is 2.



After the job has been defined and any soft foot condition corrected (if necessary), select Alignment Data to acquire a new set of shaft readings.

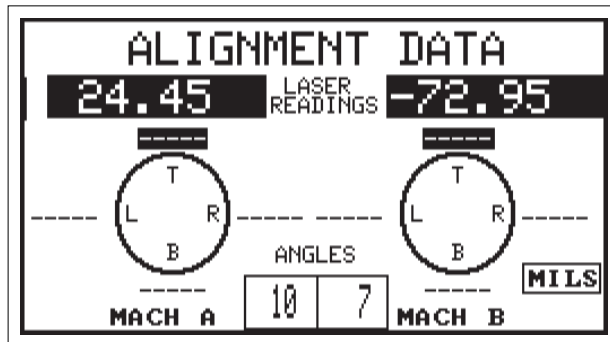

The current laser readings are shown in reverse video just below the title line of the data acquisition screen. When the laser heads are at one of the desired clock positions, the angle readouts at the bottom center of the screen get cross hatches over the numbers, you will hear the analyzer beep (and the red LED on the front panel of the analyzer will illuminate) each time a new reading is measured. The heads must be within one degree of the desired position (average of both angles). In Auto mode the data is automatically placed in the correct clock position and it is averaged continuously until you move out of the desired clock position. You can clear and restart the averager at any time by pressing the Alt/Delete key while readings are being acquired. The data at the four clock positions is the averaged value. The position currently highlighted is the one for which data is being acquired.

If the laser heads can only be rotated to three of the positions, then press Enter after the third set of data has been collected, and the fourth is automatically calculated. Using only three readings increases the likelihood of error and does not allow the instrument to check data validity. CSI does not recommend using only three readings if four are available.

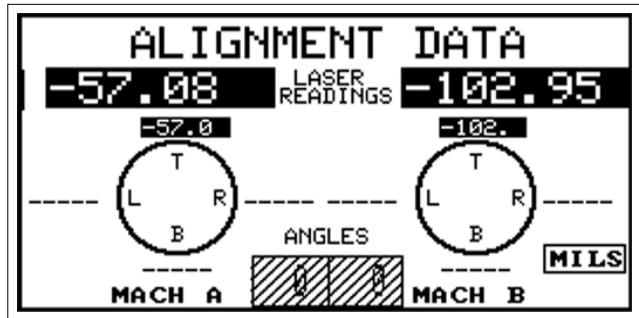

Data Acquired at 12 O'clock (270°)

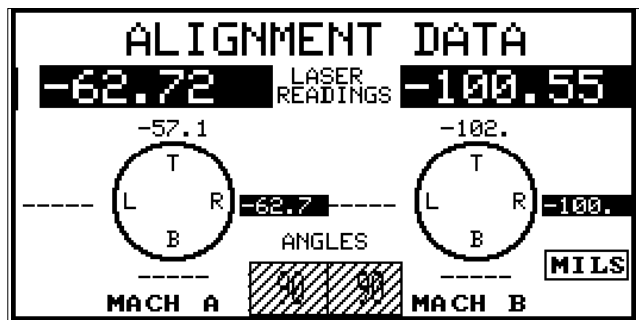

Data Acquired at 3 O'clock (0°)

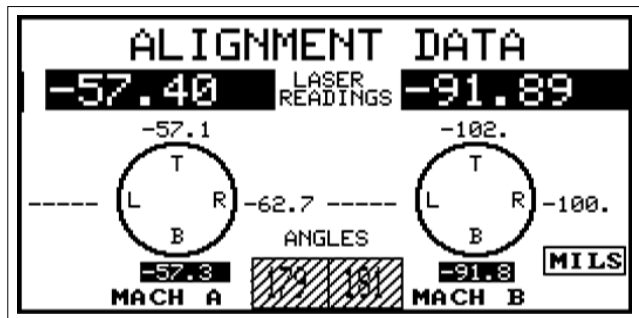

Data Acquired at 6 O'clock (90°)

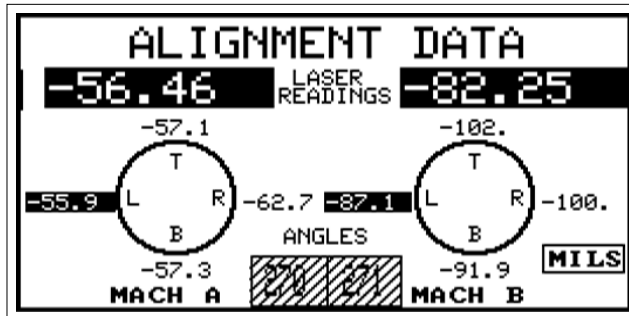

Data Acquired at 9 O'clock (90°)

When all the data has been acquired all the desired points, press the Enter key to accept the data. At this point the data is checked for validity (refer to “Data Quality” on page 5-27 for more information). If the data validity is satisfactory, you are returned to the main menu where the data may now be viewed.



Otherwise, you are warned that a data validity error exists. At this point you should either repeat the data acquisition to check for accuracy. This built-in check helps alert you to the data losing reliability in the misalignment calculations.

**Note**

For the greatest accuracy and repeatability, all readings should be acquired using the same direction of rotation. In addition, it is best to use the same direction of rotation as the machine normally operates.

---

**Note**

Remember, when shaft movement due to causes other than misalignment is present in the data this will appear as a randomness (noise) in the data. This is not normally a problem when the misalignment great, but will increasingly interfere as the misalignment decreases. Therefore, the better the alignment the more likely the chance of seeing the data validity warning.

---

## 4 Point Manual

The 4 Point Manual method is similar to the 4 Point Auto mode except that the user has complete control over when data is acquired and which of the four measurement positions it will be used in. This mode is useful when the machinery is not mounted in a true horizontal orientation, so that the inclinometer is not effective, or when the clock positions relative to vertical and horizontal base movements of the machine are nonstandard.

The current alignment method is always shown at the bottom center of the screen. The alignment method is selected from the Alignment Setup menu which is accessed using the Options key. Once the 4 point method is shown, using the Up/Down Arrow keys to select and the Number keys on the keypad to toggle the selection, set the Sample Rate.

**Sample Rate** – determines the number of data samples that are to be collected and averaged together to produce a single Laser PSD reading. Use the Left and Right Arrow keys to toggle sample rate from 1 to 25 samples. The default is 2.



After the job has been defined and any soft foot condition corrected (if necessary), select Alignment Data to acquire a set of shaft readings.

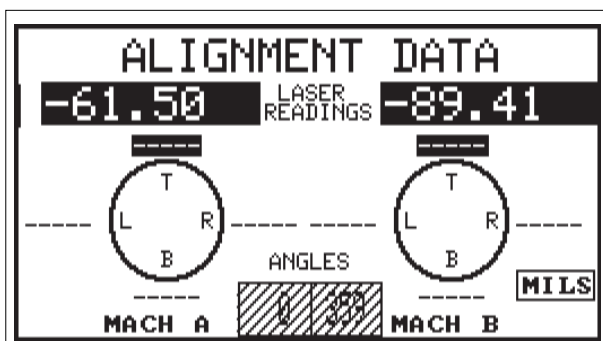

The current laser head readings are shown in reverse video just below the title line of the display. The current head angle is shown at the bottom center of the screen. To acquire data, use the arrow keys to move the reverse video of the data point to be acquired to the desired position. When using this mode the user must be very careful to get the desired readings into the desired positions. That is why this is called the 4 Point Manual method. All readings should be 90° from each other, but this does allow the program to handle special circumstances where the shaft of the machine is not in the horizontal plane. There is no averaging of the displayed data and no safeguards against data being placed in the wrong position.

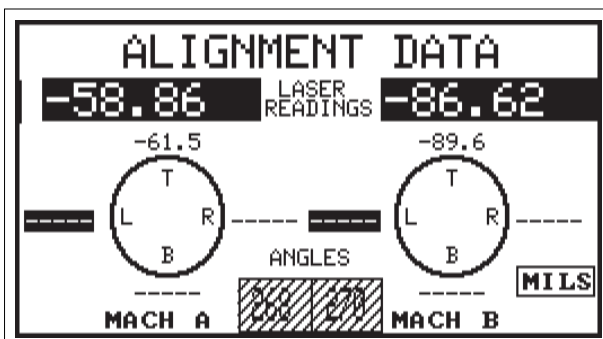

When the desired data position is highlighted and the data is acceptable, press any number key to insert the data into the selected position.

After 3 or 4 positions have had data inserted, pressing the Enter key will complete acquisition and accept the data.



---

**Note**

CSI does not recommend using only three readings if four are available.

At this point the data is checked for validity (refer to “Data Quality” on page 5-27 for more information). If the data validity is satisfactory, you are returned to the main menu where the data may now be viewed.



Otherwise, you are warned that a data validity error exists. At this point you should either repeat the data acquisition to check for accuracy. This built-in check helps alert you to the data losing reliability in the misalignment calculations.

---

**Note**

For the greatest accuracy and repeatability, all readings should be acquired using the same direction of rotation. In addition, it is best to use the same direction of rotation as the machine normally operates.

---

**Note**

Remember, when shaft movement due to causes other than misalignment is present in the data this will appear as a randomness (noise) in the data. This is not normally a problem when the misalignment great, but will increasingly interfere as the misalignment decreases. Therefore, the better the alignment the more likely the chance of seeing the data validity warning.

---

## Dual Pass

Dual Pass functions similar to the Auto Sweep mode except data is automatically acquired as each laser head passes by each other. This mode, like Manual Sweep, is useful for performing uncoupled or non-rotational alignments. In this mode of operation, PSD and angle data are only taken when the laser beam of each laser head enters the “valid data” window centered on the vertical centerline of the other head’s PSD.

### Note

With the Dual Pass method, a special cable is required to synchronize the two Laser Heads since they will be moved independently of each other and will not always be in alignment with each other. When using direct connect communication, the Model 821510 direct connect cable is connected between the laser heads and analyzer to synchronize the laser heads while using the Dual Pass method. When using RF communication, the Model 8215C2-PM “Dual Pass” cable is connected between the two laser heads to synchronize the laser heads while using the Dual Pass method. For longer spans the Model 800002 and Model 800003 extension cables can be added between the Model 821510 direct connect cable/Model 8215C2-PM “Dual Pass” cable and the laser heads.

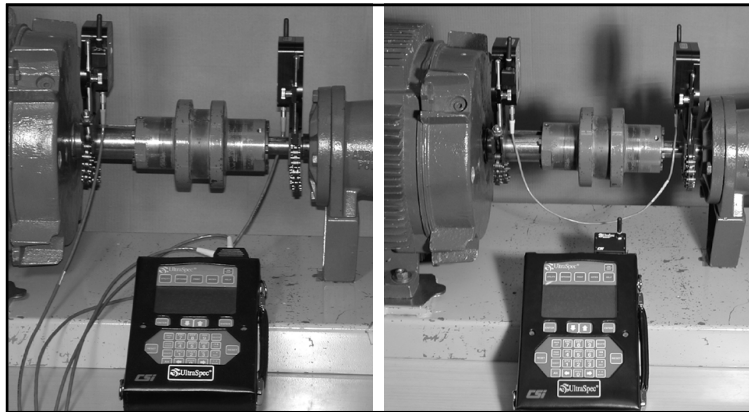

Two ways of hooking up the laser heads for Dual Pass. Direct Connect (left) and RF Communication (right).

To acquire data using the Dual Pass method, you must first select Dual Pass as the method from the Alignment Setup menu (accessed by pressing the Options key). Once this method is shown, using the Up/Down Arrow keys to select and the number keys on the keypad to toggle the selection, set the Target Window percentage.

- Target Window - determines the size of the valid data window around the vertical centerline of the other laser head's PSD. Use any number keys on the keypad to toggle the Target Window between 10%, 25%, 50%, 75%, and 100%. The default is 100%.

---

**Note**

If a lower percentage (smaller valid window) is selected, a slower rotational sweep speed may be required especially with a smaller PSD (e.g. with the 10mm x10mm PSD on the 8215).

The following scenario will more clearly illustrate how the Dual Pass method operates.

1. ... When the analyzer initializes the laser heads, all data is cleared and they enter the “Dual Pass” mode of operation.
2. .. The laser heads then begin detecting the presence of the other laser head’s laser beam on its PSD. If a laser beam is not on a PSD, the laser head's LED will be flashed solid yellow.
3. .. When the other laser head’s laser beam is detected on its PSD, the laser beam is tracked as it crosses the PSD. As soon as the laser beam is detected on the PSD, the laser head's LED will be or continue to be (depending on the state it originally started from) flashed solid yellow.
4. .. When a laser beam enters the “valid data” window around its PSD’s vertical centerline, data is acquired. As valid data is acquired, the laser head will flash its LED green once.
5. .. Data continues to be acquired while a laser beam is within the “valid data” window. The position data that is closest to the vertical centerline (i.e. horizontal position closes to zero) is the value that is retained along with its angular position. As each data sample is taken the LED on the Laser Head will flash green to indicate that a valid data point has been acquired.
6. .. If a laser beam passes across the PSD so quickly that a data point is not acquired within the “valid data” window, no data will be acquired.
7. ... When a laser beam leaves the PSD completely, the acquired data point is committed and stored.
8. .. The laser heads again begin detecting the presence of the other laser head’s laser beam on its PSD and their LED's resumes to be flashed solid yellow.

The typical method of operation will be for the user to initialize the laser heads with the analyzer. One of the heads will then be moved to a new position. Then the second head will be moved past the first head to a new position. As the laser heads pass each other, the data will be acquired. The first head will then be moved past the second head to a new position. Again, as the laser heads pass each other, both laser heads will acquire the data. This method continues until the user has acquired the necessary number of passes and downloads the data to the analyzer. This may include several full rotations of the laser heads.

---

**Note**

A minimum of three data points over a 45° sweep arc is required, but CSI recommends a minimum of 8 data points acquired over a sweep arc of at least 90°.

The current alignment method is always shown at the bottom center of the main menu. Once the job has been defined and any soft foot has been corrected (if necessary), prepare to measure the misalignment by selecting Alignment Data from the Main Menu.



With Alignment Data highlighted, press the Enter key to start the data acquisition procedure. The following screen will be displayed.

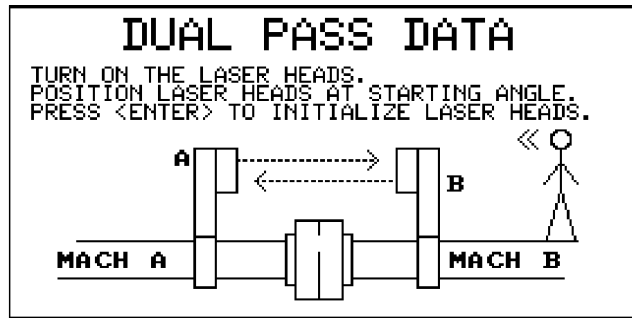

The next screen directs you to turn on the laser heads, position them at any angular position you desire to start from, and then press the Enter key to initialize the laser heads. It is not required to define a sweep arc range and direction of rotation with the Dual Pass mode since this is a type of Manual Sweep mode of operation. Once the laser heads are initialized the next screen appears prompting you to now acquire the data by rotating the laser heads. After the laser heads have been rotated as described in the above scenario, press the Enter key transmit or transfer the data from the laser heads to the analyzer.

---

**Note**

For the Auto Sweep and Dual Pass methods, if the laser heads have not been turned off since they last acquired and stored a set of data readings and prior to initializing them, pressing the Alt/0 (Alt/Space) key will “Resend” the last set of data they acquired and stored to the analyzer without having to resweep the laser heads. This is useful if for some reason the data transfer from the heads to the analyzer was aborted before it was complete.

---

**Caution!**

*To prevent damage to the laser heads, when the laser heads are mounted in close proximity to each other, make sure the antennas do not come into contact with each other as one laser head is rotated past the other.*

---

**Note**

For the greatest accuracy and repeatability, all readings should be acquired using the same direction of rotation. In addition, it is best to use the same direction of rotation as the machine normally operates.

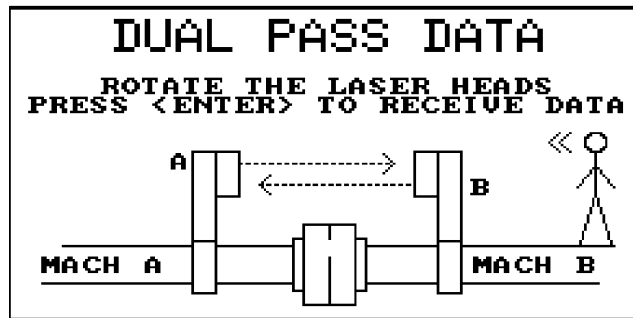

The 8215/8225 laser fixtures are designed to be rotated a full revolution in two seconds. As with any sweep a good smooth uniform acceleration and deceleration during the rotation of the laser heads is necessary for accurate, reliable, and repeatable data. During the transfer, the “Receiving Data” screen will be displayed showing the progress of the data transfer for each laser head.

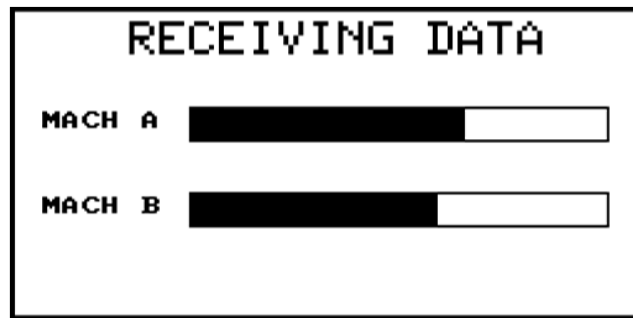



When the data transfer is completed, an “Analysis In Progress” screen similar to the following is displayed while the data is curve fit to a sine wave. If the fit is satisfactory (85% and above), you are returned to the main menu where the data may now be viewed.

```
ANALYSIS IN PROGRESS
      76% FIT           60% FIT
.....
```

```
PRO ALIGN PLUS
JOB#: 562X12      MACH ID: HW PUMP #4
(1) JOB DEFINITION [X]
(2) FOOT PRE-CHECK [X]
(3) ALIGNMENT DATA [X]
(4) VIEW DATA [ ]
(5) MACHINE MOVES [ ]
      DUAL PASS
```

Otherwise, you are warned the data is “Unfit” (less than 85%). At this point you should either repeat the data acquisition or try to manually condition or edit the data. This built-in check helps alert you to the data losing reliability in the misalignment calculations. Refer to “Additional Data Detail” on page 5-34 for more information.

---

**Note**

Remember, when shaft movement due to causes other than misalignment is present in the data this will appear as a randomness (noise) in the data. This is not normally a problem when the misalignment great, but will increasingly interfere as the misalignment decreases. Therefore, the better the alignment the more likely the chance of seeing the Unfit data warning.

If you do encounter a machine where this becomes a problem too great to overcome, consider switching to an alternative method such as Manual Sweep.



---

## Quick Spec

Quick Spec allows you to make a quick check of the alignment condition of a machine with minimal setup and effort. If a machine is found to have unacceptable alignment, the procedure can be readily converted to a full alignment procedure and machine moves calculated. *Quick Spec is only available in Pro Align and Pro Align Plus.*

To use Quick Spec, select the desired alignment method from the Alignment Setup menu which is accessed using the Options key. Then, set Quick Spec to Yes. When in Quick Spec mode, the normal alignment main menu is not shown; each new job begins ready to configure and acquire data.

---

**Caution!**

*Entering Quick Spec mode will clear any existing job in the Current Job area. A warning screen will give you a chance to cancel this action.*

---

**Note**

Quick Spec is not available for the Dual Pass method or straightness.

## Quick Spec Mode Flow Diagram

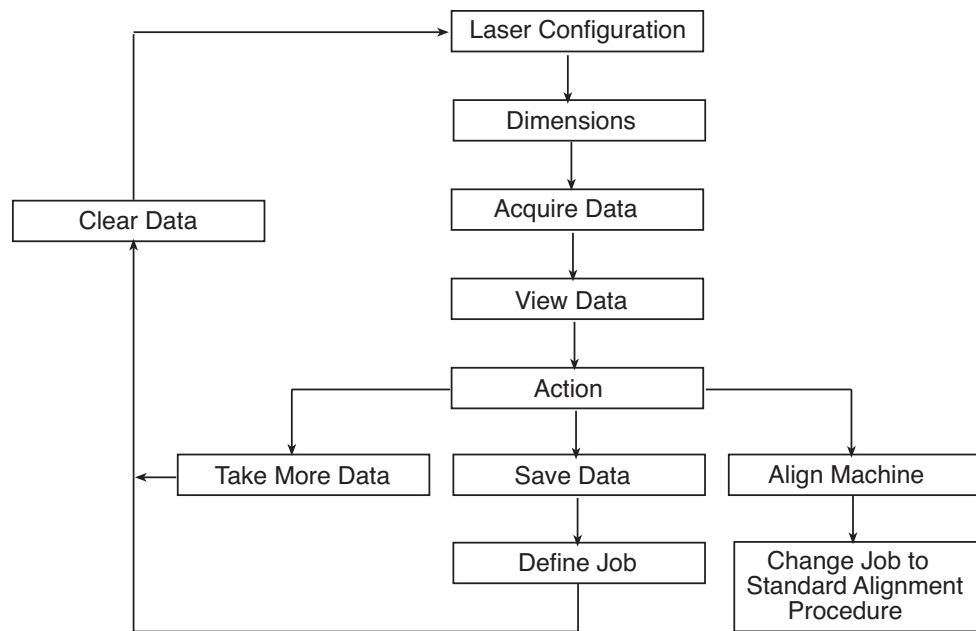

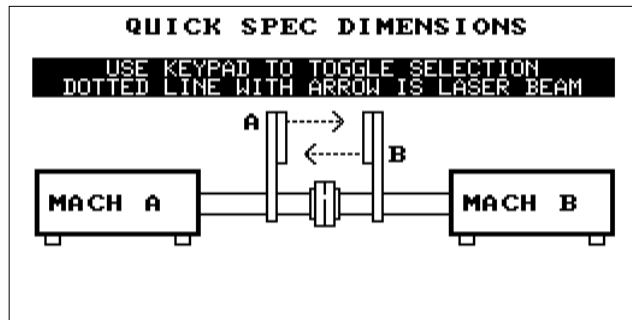

To check the current alignment condition of a machine, mount the laser heads on the shafts, then change the display to match the head positions using any number key to toggle the relative positions. The laser heads are designated as A and B (this is marked on the face plates).

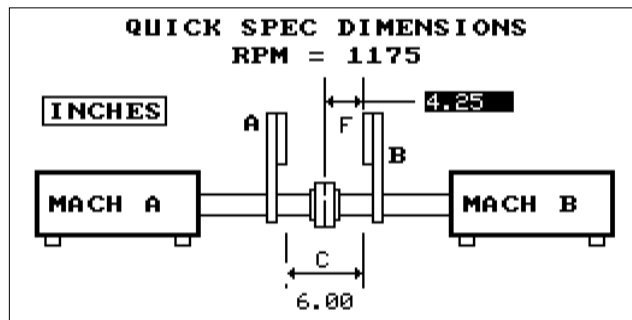

Once the head positions have been designated, press Enter to accept. You must now enter the machine speed and two dimensions. The distance between the heads and from the center of the coupling to the head on the right is all that is required to check the current alignment. When this data has been entered, press Enter to continue.

---

**Note**

In this example, Quick Spec uses the Auto Sweep method to acquire data.

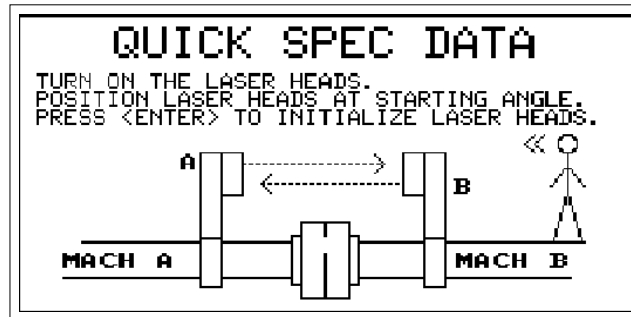

The next screen directs you to turn on the laser heads, position them at any angular position you desire to start from, and then press the Enter key to initialize the laser heads. It is not required to define a sweep arc range and direction of rotation due to the increased number of data readings acquired every 2 degrees and the process, which automatically defines the direction of rotation. Once the laser heads are initialized the next screen appears prompting you to now acquire the data by rotating the laser heads. After the laser heads have been rotated, press the Enter key transmit or transfer the data from the laser heads to the analyzer.

---

**Note**

For the Auto Sweep method, if the laser heads have not been turned off since they last acquired and stored a set of data readings and prior to initializing them, pressing the Alt/0 (Alt/Space) key will "Resend" the last set of data they acquired and stored to the analyzer without having to resweep the laser heads. This is useful if for some reason the data transfer from the heads to the analyzer was aborted before it was complete.

**Note**

For the greatest accuracy and repeatability, all readings should be acquired using the same direction of rotation. In addition, it is best to use the same direction of rotation as the machine normally operates.

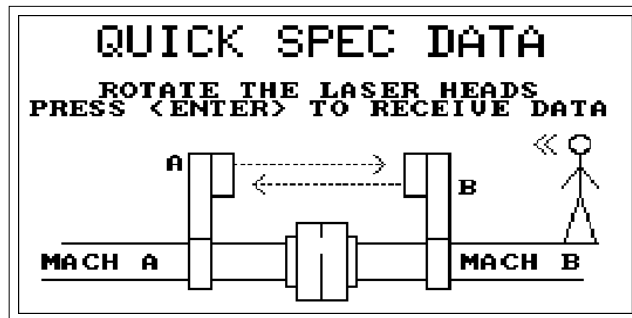

The 8215/8225 laser fixtures are designed to be rotated a full revolution in two seconds. As with any sweep a good smooth uniform acceleration and deceleration during the rotation of the laser heads is necessary for accurate, reliable, and repeatable data. During the transfer, the "Receiving Data" screen will be displayed showing the progress of the data transfer for each laser head.

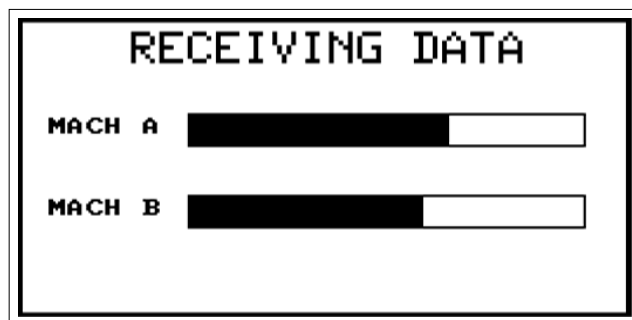

When the data transfer is completed, an “Analysis In Progress” screen similar to the following is displayed while the data is curve fit to a sine wave. If the fit is satisfactory (85% and above), you are shown the results by means of a dual tolerance plot screen.

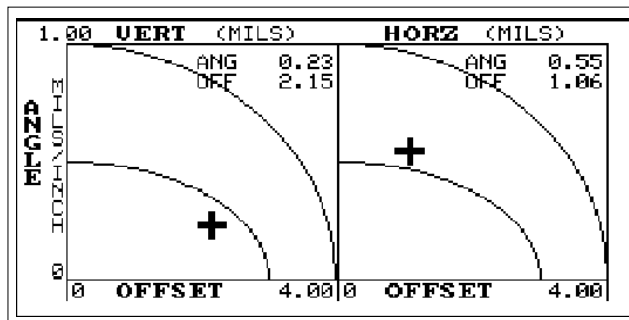
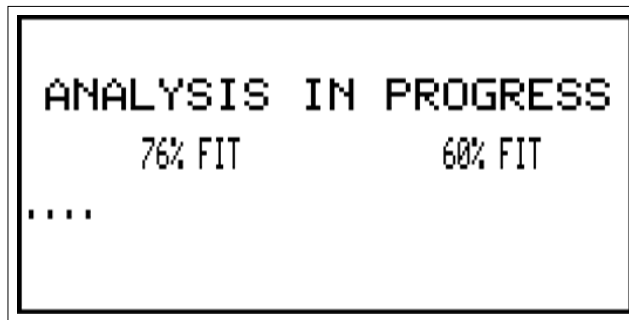

**Note**

For users who want to view the acquired data in more detail, pressing the Page Down key when the dual tolerance plot is displayed will access additional screens. Refer to “Additional Data Detail” on page 5-34 for more information.

Otherwise, you are warned the data is “Unfit” (less than 85%). At this point you should either repeat the data acquisition or try to manually condition or edit the data. This built-in check helps alert you to the data losing reliability in the misalignment calculations. Refer to “Additional Data Detail” on page 5-34 for more information.



---

**Note**

Remember, when shaft movement due to causes other than misalignment is present in the data this will appear as a randomness (noise) in the data. This is not normally a problem when the misalignment great, but will increasingly interfere as the misalignment decreases. Therefore, the better the alignment the more likely the chance of seeing the Unfit data warning.

If you do encounter a machine where this becomes a problem too great to overcome, consider switching to an alternative method such as Manual Sweep or 4 Point Auto.

After viewing the dual tolerance plot, press Enter to store the reading and continue. You now have a choice to either take more data using Quick Spec, save this data, or align the machine. Either use any Number key on the keypad to toggle between these choices, and then press Enter to accept the choice; or press the Page Up key to review the results (dual tolerance plot).

```
QUICK SPEC
PRESS ANY NUMBER KEY TO
SELECT DESIRED ACTION:
  TAKE NEW DATA
PRESS <ENTER> TO CONTINUE
PRESS <PAGE UP> TO REVIEW RESULT
```

Selecting “Take More Data” will clear the previous readings and return you to the start of the Quick Spec routine.

**Saving Quick Spec Data** – if you want to save this data and the job, select “Store Data.”

```
QUICK SPEC
PRESS ANY NUMBER KEY TO
SELECT DESIRED ACTION:
STORE DATA
PRESS <ENTER> TO CONTINUE
PRESS <PAGE UP> TO REVIEW RESULT
```

The Define Job screen will then be displayed.

```
DEFINE JOB
CLEAR JOB: NO USER:
JOB #
MACH ID
MACH DESC: \-->
STATION \-->
COUPLING : 1 RPM: 1175
```

A Job # must be supplied before storing the job. You can also add other descriptive information (identifying the machine) at this time, if desired.

If this Quick Spec job was recalled from the stored job area, the previously entered data will be present. After all changes to this screen are complete, press Enter to save the job. If the job is stored successfully, a screen appears stating that it was a success. Also displayed on this screen is the amount of “Free Memory” (in bytes) available in the analyzer.

```
STORE JOB

JOB #: W.O. S1501
STORED SUCCESSFULLY...

FREE MEMORY = 509440
PRESS <ENTER> TO CONTINUE
```

Press Enter to continue and return to the initial Quick Spec Screen.

```
QUICK SPEC

PRESS ANY NUMBER KEY TO
SELECT DESIRED ACTION:
ALIGN MACHINE
PRESS <ENTER> TO CONTINUE
PRESS <PAGE UP> TO REVIEW RESULT
```

**Using Quick Spec data to align a machine** – selecting Align Machine takes you directly into the normal alignment mode. To return to Quick Spec, simply clear the current job. If you wish to calculate the moves, then complete the job definition and go directly to the Machine Moves selection.

---

**Note**

If soft foot has not been corrected previously on this machine, you will want to check for soft foot before making any moves. If a soft foot is corrected after the Quick Spec data was taken, you will want to take a new set of alignment data from which to calculate the moves.



## Straightness Application

---

### Overview

The straightness feature found in the UltraSpec analyzer alignment application is used to determine surface profiles. This profile can be of a motor baseplate or checking the crown on a rolling application. You must use a set of laser sensor heads and mounting fixtures (CSI model 8AA50) to acquire surface profile readings.



---

## Select the Application

To select the straightness method of data collection, the UltraSpec analyzer must be in the alignment application. Press the Utility function key and press the Enter key when the selected application is highlighted.

---

**Note**

If already in the alignment application, this step and the next are not required.

The following screen is displayed.

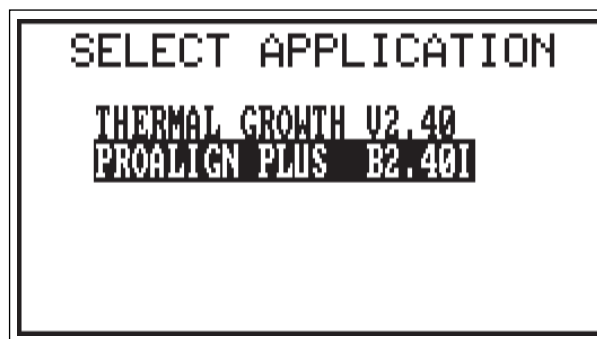

Select PRO ALIGN PLUS and press the Enter key.

---

## Alignment Setup

```
ALIGNMENT OPTIONS

(1) STORE JOB
(2) RECALL JOB
(3) DELETE JOB(S)
(4) ALIGNMENT SETUP
(5) LASER HEAD STATUS
(6) ADDRESS SELECTION
(7) CALCULATOR MODE
```

From the alignment application's main menu, press the Options function key. Arrow the selection bar to Alignment Setup and press the Enter key. The following screen is displayed.

```
ALIGNMENT SETUP

METHOD          : STRAIGHTNESS
SAMPLE RATE     : 2
TOLERANCES      : N/A
THERMAL GROWTH  : N/A
FOOT PRE-CHECK  : N/A
COLLECTION MODE : STANDARD
```

Use any Number key to toggle through the selections for method until straightness is displayed. Once this method is shown, use the Up and Down Arrow keys to make a selection, and any Number key to toggle through the options for that selection. If necessary, use these keys to set the Sample rate and Collection mode.

- **Sample Rate** – determines the number of data samples that are to be collected and averaged together to produce a single Laser PSD reading. Use the Left and Right Arrow keys to toggle sample rate from 1 to 25 samples. The default is 2.

- **Collection Mode** – select Standard for a continuous reading of the Laser Readings (the current or last reading is used), or select Average for a continuous accumulative average of the laser readings.

The straightness method main menu will now be displayed.

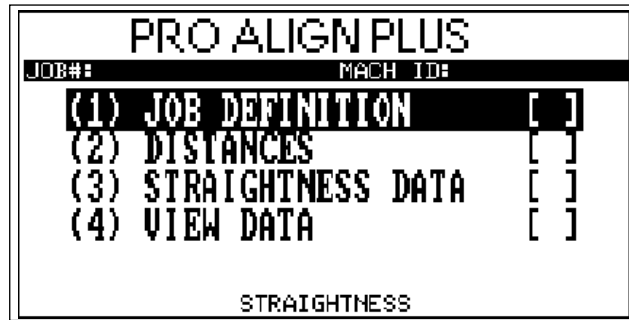

Highlight Job Definition, and press the Enter key.

---

**Note**

Notice that the method (straightness) is shown at the bottom, center.



---

## Defining the Job

```
DEFINE JOB
CLEAR JOB: NO    USER: CSI
JOB #      : W.O. S1501
MACH ID   : MILL #5
MACH DESC: PEBBLE MILL  \-->
STATION   : PROCESS FLOOR \-->
```

On this screen, enter the requested information using the alphanumeric keypad.

---

**Note**

*All* the information is required for proper job documentation.

Press the Enter key when the information has been filled in.

### Four Ways of Configuring the Laser Fixtures

There are four ways to configure the laser fixtures. The first consideration is which fixture is to be fixed and which one will be moved. The configuration shown below is for the left fixture to be fixed. Notice the laser head to be used at each location can also be selected.

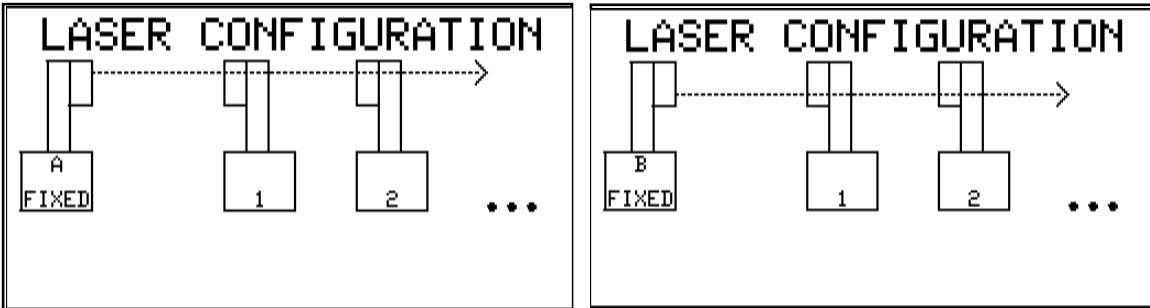

The other two configuration options are shown below. This arrangement has the right fixture fixed.

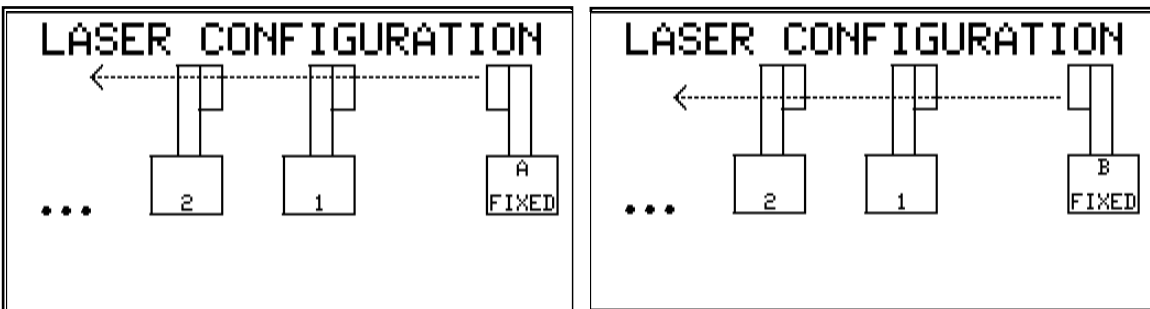

This selection process is accomplished by toggling through the available options with any number key.

---

## Entering Distances

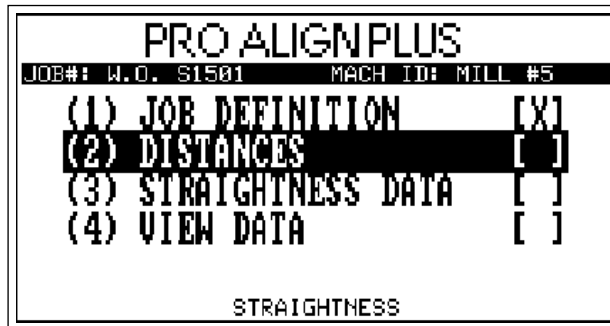

After the job definition step has been completed, an “X” is placed beside that step indicating it has been completed. With Distances highlighted, press the Enter key.

The following screen is displayed.

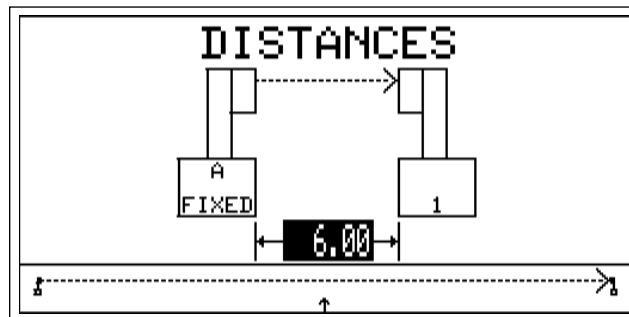

Enter the distance (in inches) between the fixed head and the first measurement location. To add additional measurement segments, press the Up arrow key. The distance between the segments can be different lengths and up to 50 segment measurements can be taken. Segments of the same length can be entered by pressing the Up arrow key.

The distance screen will show up to four measurement locations at one time. Notice that a total of eight measurement segments have been defined in this example and the first segment field is active. This information is displayed on the overall graph below the segment fields. The arrow shows the present location.

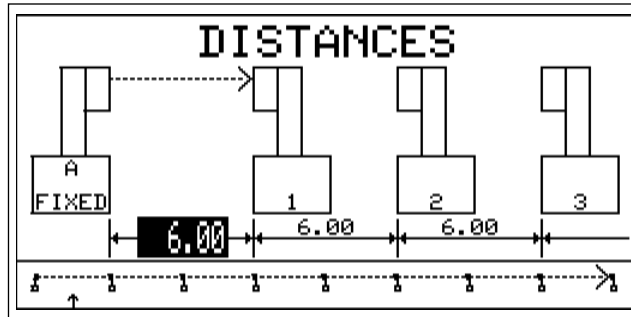

### Help Messages

Help messages are available in any of the UltraSpec applications by pressing the Help function key. The help message for the distance screen is displayed to show the active keys for entering information.

```

HELP - DISTANCES
USE THE FOLLOWING KEYS TO ENTER SEGMENT
LENGTHS:
<UP><DN>    - SELECT SEGMENT. NEW SEGMENTS
              ARE ADDED AT FAR END.
<ALT><PAGE UP> - MOVE TO FIXED HEAD.
<ALT><PAGE DOWN>-MOVE AWAY FROM FIXED HEAD
<DELE>     - REMOVE A SEGMENT.
<INS>      - INSERT A NEW SEGMENT.
<NUMBERS>  - ENTER SEGMENT LENGTH.
<ENTER>    - ACCEPT ALL SEGMENT LENGTHS.
<RESET/MAIN>- EXIT TO MAIN MENU.
PRESS <ENTER> TO RETURN
  
```

---

## Taking Straightness Data

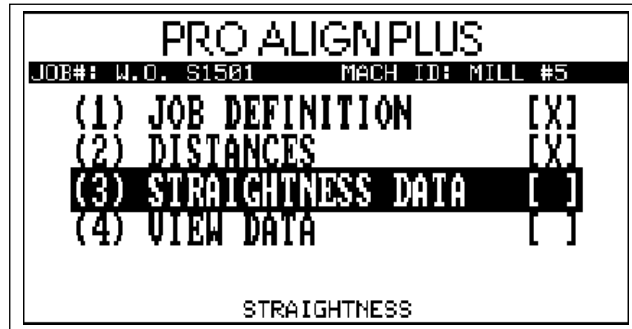

Again, an "X" has been placed in Step 2 showing completion. Highlight Step 3, Straightness Data, and press the Enter key.

The following screen is displayed.

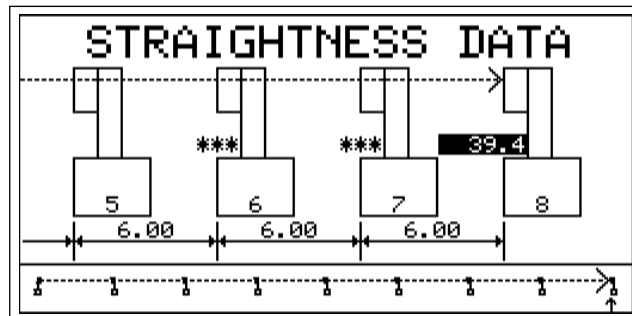

Turn the lasers on. To disable the sleep mode on each laser head, hold the power button down for 3 seconds, until the activity LEDs are both off. Laser communications with the moveable head must be established to collect data at the defined segments. Communication can be with radio frequency (RF) or cable. Start at the farthest point and center both lasers. To accept the value displayed, press any number key. Use the Up arrow key to move to the next segment to the right. Use the Down arrow to move to the left.

The moveable sensor head is then relocated to the next measurement point. It should be positioned so that the beam from the *stationary* head is horizontally centered in the *moveable* heads target. If it is not within a band  $\pm 10$  mils of the center vertical axis, the error message “Beam horizontally off enter” will be displayed. To remove the message, readjust the moveable sensor head. A reading can be deleted and retaken by selecting that segment and pressing the Delete key.

---

## View Data

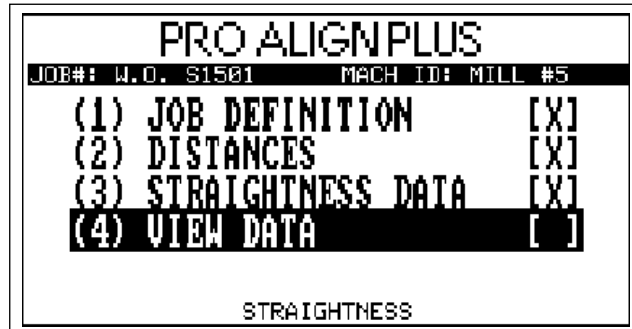

Once all the readings are taken, press the Enter key to accept all the data. Step 3 has an “X” showing completion and step 4 is highlighted. Press the Enter key to view the results of the profile.

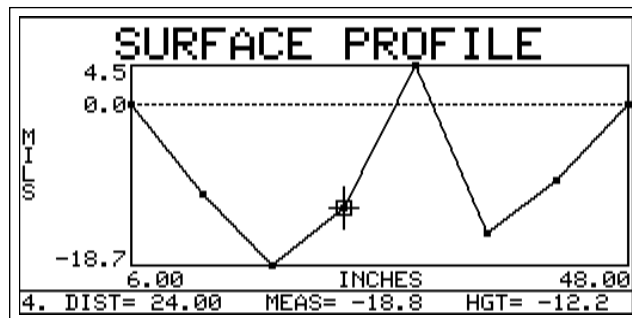

The surface profile for the eight segments measured is displayed. A cursor can be moved using Left or Right arrow keys to display information on an individual segment. The segment number, length, measured value and height from the laser (dotted line) is shown on the bottom. Press the Enter key to return to the main menu.

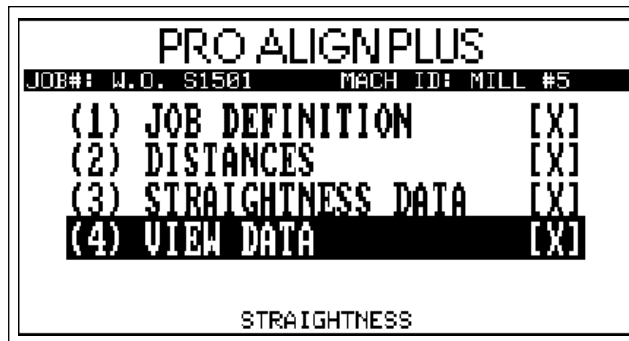

An "X" now appears next to step 4 indicating completion of the current straightness job. To save the current job information press the Options function key.

The following screen is displayed.

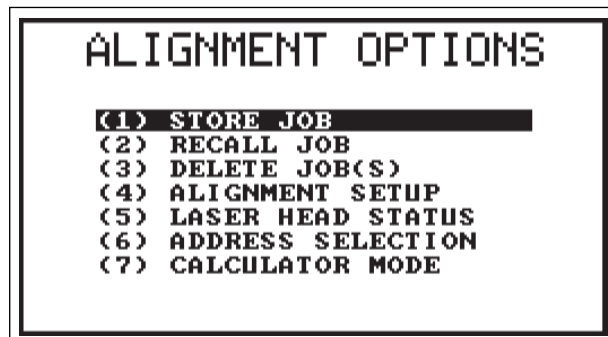

Choose Store Job and press the Enter key.



If no duplicate job numbers were previously stored, the screen below will be displayed.

```
STORE JOB

JOB #:  W.O. S1501
STORED SUCCESSFULLY...

FREE MEMORY = 509440
PRESS <ENTER> TO CONTINUE
```

You can now transfer the job data to UltraMgr for long-term storage.

---

**Note**

For additional information on storing a job, recalling a job, and deleting a job refer to “Options Key” on page 3-2 for details. For information on printing, refer to “Screen/Print Key” on page 3-25 for details.



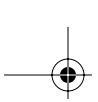

## Application Information

---

### ◆ Machinery Shaft Alignment – General Overview

Poor shaft alignment can cause the following problems:

- Bearing failure
- Shaft deflection fatigue
- Seal leakage and failure
- Coupling failure
- Internal heating
- High energy consumption
- Excessive vibrations (studies have shown that almost 50% of excessive vibration in direct-coupled rotating equipment is due to misalignment)

Proper machine alignment will result in:

- Less downtime (increased production)
- Increased bearing life
- Lower energy costs
- Increased coupling life
- Lower vibration (lower maintenance costs, even on surrounding machinery)

A successful alignment job involves completing at least five major steps:

- Pre-job preparation and setup (considering items such as soft foot, base integrity, pipe strain, documentation, and tolerances)
- Measurement of the amount and direction of misalignment
- Calculating corrective moves
- Actually moving the equipment within preset tolerances

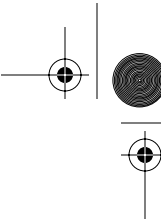

- Documentation of work done for use in future alignment jobs

Early alignment methods involved using a straightedge along the coupling rims. This is still a good procedure to use as a preliminary step. In fact, for low speed machines, operated infrequently for short periods of time, it may be all that is needed.

However, more complex machines require more than this. Feeler gages, inside micrometers, and dial indicators are now used extensively for taking precise alignment measurements and monitoring corrective moves. These tools can give good results when used properly.

Mistakes, however, can cause errors in the alignment procedure. Errors that commonly occur are:

- Failing to document the job setup, problems, findings, and data
- Failing to use good indicator brackets
- Failing to determine the correct amount of bracket sag
- Misreading the indicators
- Failing to detect sticking indicators
- Mistakes in recording and interpreting the data
- Errors in calculating the moves
- Errors in making moves

These types of errors are even more likely to occur when you have pressure to complete the job quickly.

CSI's alignment equipment can help you avoid these kinds of mistakes. Our adjustable brackets are designed to fit most machines. Since there are no axial projecting arms, bracket sag is zero. Misalignment readings are calculated automatically and required moves are then displayed. If a serious mistake is made, the system will prompt you for corrected entries before moving on to the next step.

Completed jobs are easily documented. Documented jobs can then be stored in UltraMgr, a PC-based, corrective technologies information management system. This documented history can be used to enhance troubleshooting, identify personnel candidates for additional training, reduce alignment time, etc. See "UltraMgr" on page 8-8 for more information.

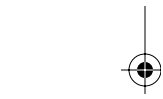
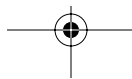

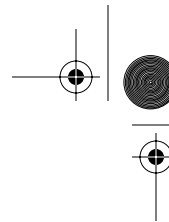

## Alignment Application Notes

To achieve ideal machine alignment, the shaft centerline of one machine element (such as a motor) must coincide with the centerline extension of another machine shaft (such as a pump) during operation. In more complex applications, three or more elements may be aligned in a train.

Misalignment can occur both horizontally and vertically. Most misaligned machines have a combination of offset and angular misalignment (see following figure).

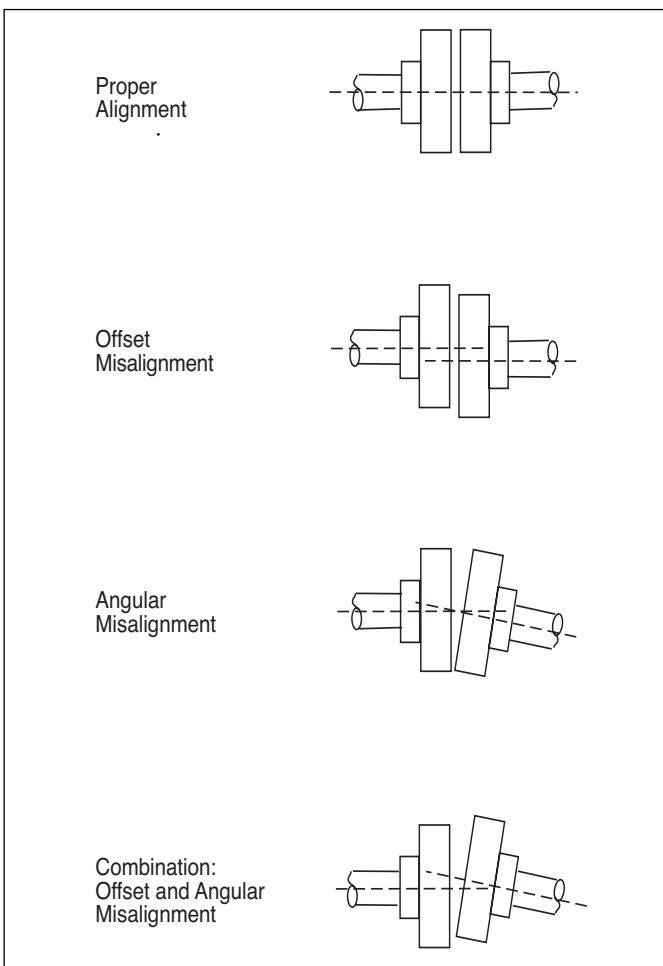

Alignment Examples

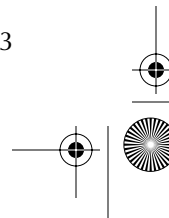
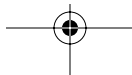
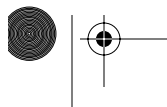

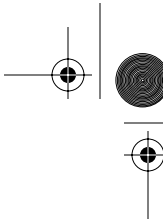

---

## Pre-job Preparation and Setup

Before starting any alignment job, the history of alignments performed on this machine(s) should be reviewed. Were any special problems found during the previous alignment; if so, what were they (soft foot, piping strain, coupling problems, etc.)? How well was the machine aligned and who performed the alignment? Answering these questions along with having a pre-defined job setup reduces the pre-job preparation time and decreases the total time to do the job.

Now that the past is known, before proceeding with alignment measurements, ensure that your machine(s) are mounted perfectly parallel with the base or foundation. If they are not parallel, additional stress may be placed on the machine when the anchor bolts are tightened. Uneven height of the base surface, dirt or corrosion under the feet, or other irregularities can all cause the machine to be supported unevenly – a condition known as “soft foot”. In addition to preventing proper machine alignment, extreme soft foot conditions can actually cause damage to the machine (warped or cracked feet, etc.).

Two major reasons for correcting soft foot are (1) to avoid “chasing your tail” during the alignment and (2) to remove the stress and enable the machine(s) to operate at their best. Therefore, all machines should be checked for soft foot, not just the machine being moved.

Additional pre-alignment considerations include:

- Proper foundation
- Grouting (suitable material with no voids or cracks)
- Baseplate (must be clean, rigid, and properly designed)
- Coupling (properly selected and installed)
- Machinery element supports (no cracks and tight)
- Minimize pipe strain

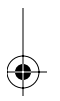

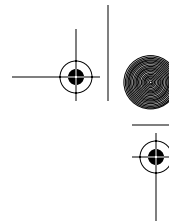

### Proper Foundation

On new installations, allow foundation concrete to cure sufficiently before installing your machines. Normally, you should not mount machines directly on the foundation. Base plates usually provide more stability. Also, to make future alignments easier, a set of high quality (stainless steel, etc.) pre-cut shims should be placed beneath each foot. These should be at least 1/8 inch (3 mm) thick.

### Coupling Considerations

CSI's alignment system is not affected by axial float and the effects from torsional play (backlash) in the coupling are minimal. However, you should ensure that the coupling is properly installed and not in such poor condition that it adversely affects the alignment process. Also, CSI recommends (while alignment is being performed) that you eliminate torsional play by rotating the driving machine in the same direction that it normally operates. If necessary, put a drag on the driven end to prevent gravity overswing.

### Minimize Pipe Strain

Excessive pipe strain can create serious problems and should be corrected before attempting machine alignment. Ensure that pipes are fitted correctly and, if necessary, have some flexibility. In some cases, stationary pipes fitted directly to the machine can cause machine movement as they heat up (thermal growth).

---

## Changes That Occur During Operation

Machine alignment can change significantly as machines are started from a "cold" position and run up to operating speed ("hot" position). Some factors that can influence alignment include:

- Thermal growth
- Torque transmission forces
- Aerodynamic forces
- Hydraulic forces

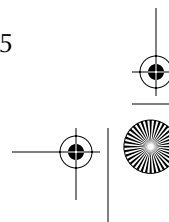
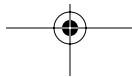
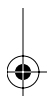

### Thermal Growth

Unfortunately, machines that must be aligned may not expand thermally at the same rate. Because of this, you may have to intentionally misalign them in their “cold” positions in order to achieve alignment when they are “hot”. The following drawing shows an example of this.

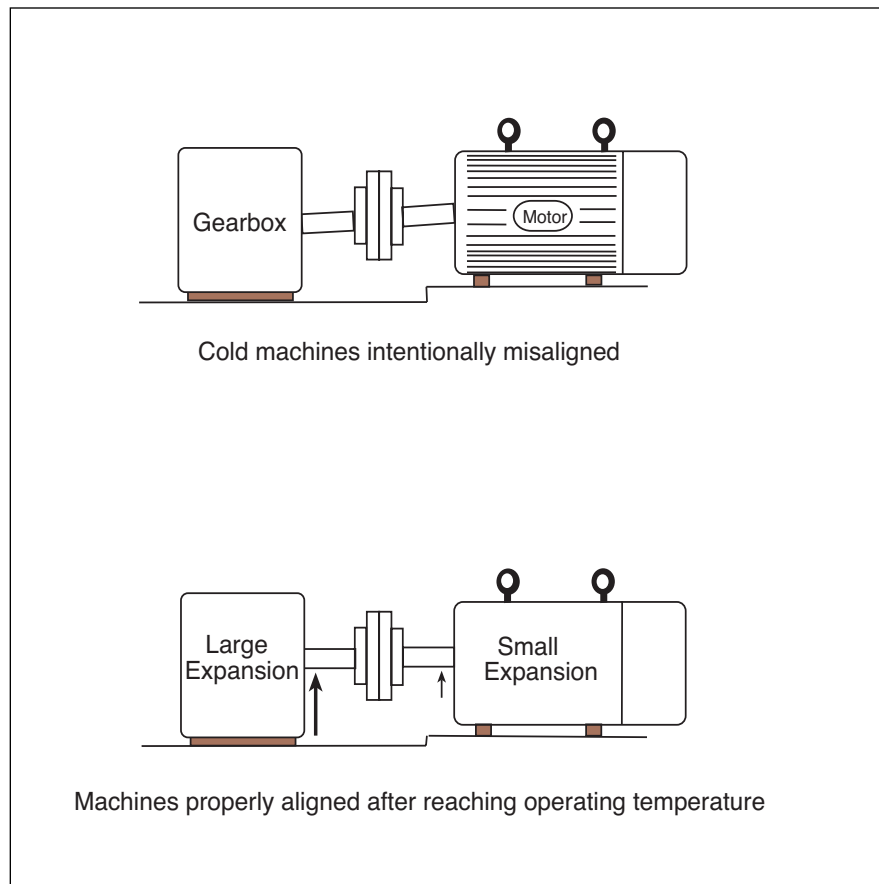

Different Thermal Expansion Rate Examples

The UltraSpec alignment system allows you to input the amount of vertical and horizontal thermal growth at each machine foot. There are several methods that can be used to calculate this growth.



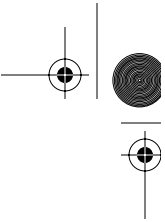

---

## Alignment Pitfalls

Some pitfalls to good alignment are:

- Improperly or not correcting for soft foot
- Thermal growth
- Excessive shaft play or radial clearances
- Bent shafts
- Damaged bearings
- Torsional play

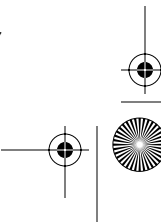
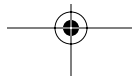

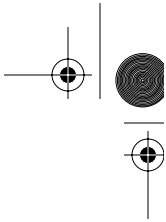

---

## UltraMgr

UltraMgr is a versatile, PC-based, database software package that is used to manage corrective technologies data. UltraMgr is designed to communicate with the UltraSpec analyzer and other CSI analyzers.

The storage of alignment information in a database provides many advantages which include:

- The ability to quickly retrieve and review the alignment status of all equipment in an entire plant to help plan the maintenance priorities and scheduling.
- The ability to quickly retrieve and review the alignment history of a particular technician to determine if more training is needed.
- The ability to quickly retrieve and review the alignment history of a particular piece of equipment to determine if the machine is going out of alignment too frequently.
- The ability to use previously entered and stored machine-specific data and setup information in the present alignment (on the same machine) thereby greatly reducing setup time.
- The ability to use previously entered and stored machine-specific data and setup information in the present alignment (on a similar machine), thus requiring only minor changes in the field.
- The ability to recall the complete alignment job previously performed on the present machine (including notes) to see peculiarities that might affect alignment. Knowing about previous problems will reduce time spent tackling the same concerns. Also, the name of the technician that performed the alignment previously is available in case there are any questions.

UltraMgr can be used as a standalone program or in conjunction with CSI's RBMware. The maximum benefits of UltraMgr are obtained when used with RBMware because you can quickly switch from alignment history to examine vibration data for machines under investigation.



## System Maintenance and Troubleshooting

---



### Overview

In this chapter, for your convenience, we have grouped many of the various activities related to maintaining and troubleshooting the UltraSpec Laser Alignment system. In some cases, the actions are also discussed in other parts of the manual. CSI hopes this will help you quickly find maintenance-related information when you need it.

---

#### Firmware and Application Version

This manual covers UltraSpec 8215/8225 compatible analyzer firmware and application versions 2.40 (and later). Version 2.40 (and later) firmware and applications require version 6.0 or later ROM to load into the UltraSpec analyzer.

---

**Note**

The 8215/8225 Laser Fixtures are only compatible with the ProAlign Plus application and not compatible with the ProAlign, Easy Align, Quick Align, Vertical Align, and Train Align applications.

---

#### UltraSpec Analyzer Serialization

The loaded firmware has been serialized and is matched to the analyzer serial number. If the firmware and analyzer serial numbers do not match, contact CSI Customer Support.

---

## UltraMgr Software and Prerequisites

In order to use the UltraSpec 8215/8225 compatible 2.40 applications with UltraMgr compatible software, the software must be RBMware version 4.40 or later for Windows.

DOS UltraMgr software and earlier versions of Windows UltraMgr software will not work with the UltraSpec 8215/8225 compatible analyzer 2.40 or later applications.

---

### **Note**

The UltraSpec Thermal Growth application will not communicate with the UltraMgr software.

---

### **Note**

UltraMgr requires some planning and set up before jobs can be downloaded into the UltraSpec analyzer. See the UltraMgr User's manual for more information.



---

## Precautions

Please follow these precautions carefully. Any product damage due to these conditions may void the warranty.

- *Do not* change the battery pack with the battery charger connected as damage may occur to the analyzer.
- Use only CSI-supplied battery chargers that have been approved for use with the UltraSpec analyzer and 8215/8225. The use of any other charger will most likely damage the equipment.
- Do not use CSI battery chargers with anything other than what they are designed for! The 8211 *must* be used to charge the UltraSpec analyzer and 8215/8225; do not use the 8211 to charge anything else!
- Do not repeatedly overcharge the analyzer batteries. If the batteries are continually allowed to remain in the “Fast” charge cycle for periods longer than the recommended 14 to 16 hours, battery degradation will occur.
- Do not use any batteries other than those included and/or specified for the UltraSpec analyzer and 8215/8225.
- Do not connect a signal larger than  $\pm 21$  volts into the input of the analyzer.
- Do not connect any signal other than a TTL-level signal to the tachometer input. Other signals may damage the analyzer.
- Do not connect a printer directly to the RS232 port located on the top panel of the analyzer.
- Do not connect any adapters or accessories to the RS232 port located on the top panel of the analyzer while the analyzer is turned on.
- Do not start the machines being aligned with the laser alignment system equipment attached. Be sure to remove the laser system before starting the machinery.

---

## UltraSpec Analyzer Battery Maintenance

---

### UltraSpec Analyzer Battery

A rechargeable battery pack is used to power the UltraSpec analyzer. Before using the analyzer, verify that the battery has enough charge to operate properly.

The battery needs to be recharged if:

- The analyzer will not power up; or
- The analyzer displays a low battery warning and turns itself off.

---

### Continuous Battery Operation Length

With a fully charged battery, the UltraSpec 8000 analyzer will operate continuously for at least ten hours and the UltraSpec 8117 will operate continuously for at least eight hours. The actual time between recharge cycles can be increased by turning the analyzer off when not in use.

---

## Battery Test

The Battery Test function will give an approximate indication (in percent) of the battery's condition and the battery pack voltage. To access this function, select Battery Test from the Utility key menu.

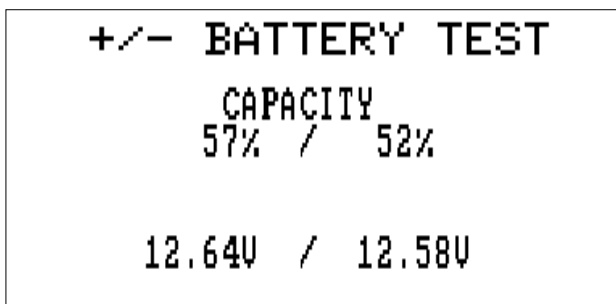

UltraSpec 8000

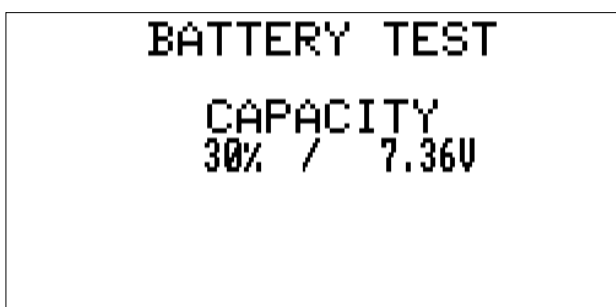

UltraSpec 8117

This display presents *approximate* values and should only be used as a guideline in determining the amount of battery charge remaining. When the percent value first reaches zero, a built-in safety margin allows approximately ten minutes of additional use before the analyzer turns itself off in order to protect the memory.

---

**Note**

If the analyzer should display the low battery warning screen and turn itself off, the analyzer's memory will remain intact for approximately two weeks. Therefore, the collected data are retained in memory and can be accessed after the analyzer's battery has been recharged.

---

**UltraSpec 8000 Analyzer Battery Recharge**

To recharge the battery, set the "Trickle/Fast" switch on the underside of the Model A2115-C battery charger to "Fast." Plug the charger into a standard 115 VAC outlet, and then plug the charger jack into the battery charger input located on the top panel of the UltraSpec 8000 analyzer.

The supplied battery charger will completely recharge the battery pack in 14 to 16 hours using the Fast setting. If the batteries are continually allowed to remain in the Fast charge cycle for periods longer than 14 to 16 hours, battery degradation *will* occur. An occasional overcharge will not significantly reduce battery life; however, leaving the batteries in the Fast charge cycle over a weekend, for example, is not recommended. Typically, the batteries should be placed in the charge cycle (after the analyzer has been used for a full shift, for example), allowed to charge overnight, and then removed from charge the next morning.

After the battery has been fully charged, the Trickle charge cycle can be used to maintain the batteries in a fully charged condition. The Trickle mode can also be used to charge the batteries over an extended period of time. The batteries may remain in the Trickle mode for extended periods without damage.

---

**Note**

Optional accessories that provide alternative charging methods are available for the UltraSpec 8000 analyzer, see "Accessories and Product Options."



---

## Changing the UltraSpec 8000 Analyzer Battery

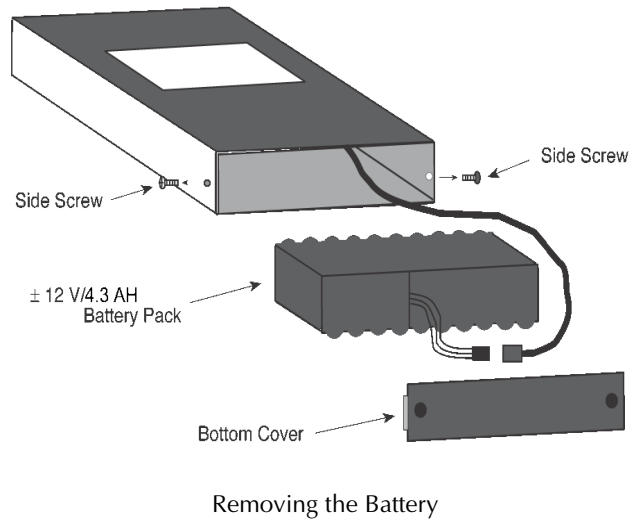

To change the battery pack:

1. Insure that the analyzer is Off, and that the battery charger is *not* connected to the analyzer.
2. Remove the two screws on the *sides* of the analyzer located just above the bottom edge (*not* the screws on the bottom cover), and remove the bottom cover.
3. Carefully remove the battery pack from the analyzer case, and disconnect the 3-pin connector.
4. Connect the 3-pin connector from the new battery pack to the analyzer, and insert the battery pack into the analyzer case. Insure that the connector is placed on top of or beside the battery pack – not on the bottom side.
5. Replace the bottom cover and screws (the top of the analyzer cover fits into the slotted side of the cover).

---

**Note**

If the battery is hard to pull out, you may have to remove the front cover of the analyzer. To do so, carefully slide the cover downward until the cable connector is exposed. Disconnect the cable and slide the cover on down until the battery is free. After replacing the battery, reverse the process by sliding the cover back up until the cable can be re-attached. Continue by returning the cover to its original position.

---

**Caution!**

*Do not change the battery pack with the battery charger connected as damage may occur to the analyzer. Exercise caution when re-connecting the 3-pin, polarized connector. Damage will occur to the connector if forced in the incorrect orientation.*

---

## UltraSpec 8117 Analyzer Battery Recharge

To recharge the battery, plug the Model 93140 charger into a standard 115 VAC outlet, and then plug the charger jack into the battery charger input located on the top panel of the UltraSpec 8117 analyzer.

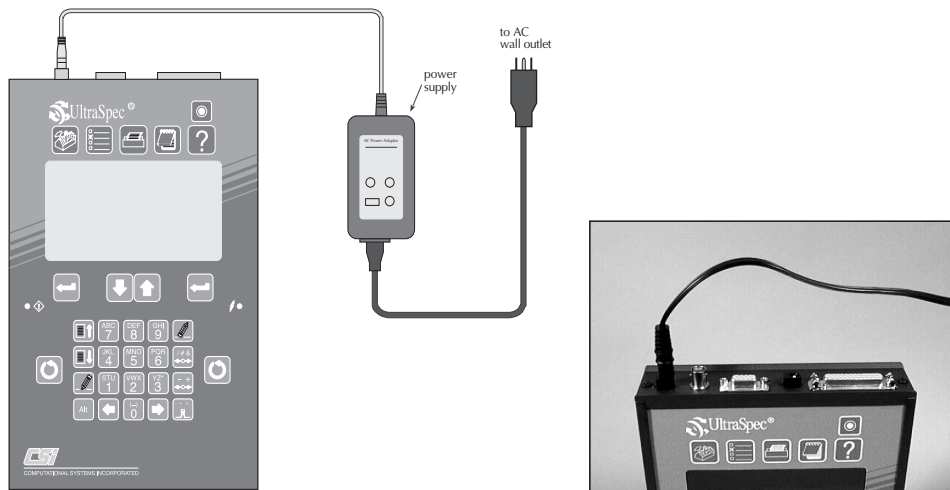

The supplied battery charger will completely recharge the battery pack in 14 to 16 hours. If the batteries are continually allowed to remain in the charge cycle for periods longer than 14 to 16 hours, battery degradation *will* occur. An occasional overcharge will not significantly reduce battery life; however, leaving the batteries in the charge cycle over a weekend, for example, is not recommended. Typically, the batteries should be placed in the charge cycle (after the analyzer has been used for a full shift, for example), allowed to charge overnight, and then removed from charge the next morning.

The UltraSpec 8117 analyzer, with a fully charged battery, will operate continuously for at least eight hours. The actual time between recharge cycles can be increased by turning the analyzer off when not in use.

---

## Changing the UltraSpec 8117 Analyzer Battery

To change the UltraSpec 8117 analyzer's battery pack:

- 1.....Make sure that the analyzer is Off, and that the battery charger power supply is *not* connected to the analyzer.
- 2.....On the bottom of the analyzer, remove the two screws on the bottom panel as shown below. Then remove the panel.

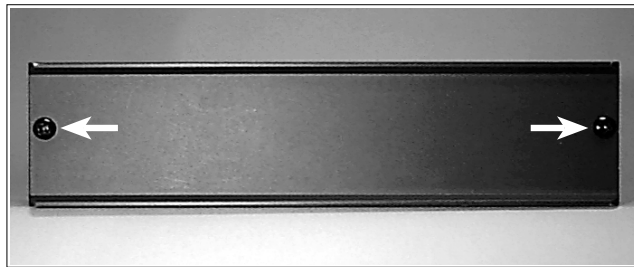

- 3.....Using the tabs on the sides of the battery pack, carefully remove the battery pack from the battery compartment.
- 4.....Insert the new battery pack into the analyzer case, ensuring that the strip contacts on the battery pack line up with the connection pins inside the battery compartment.

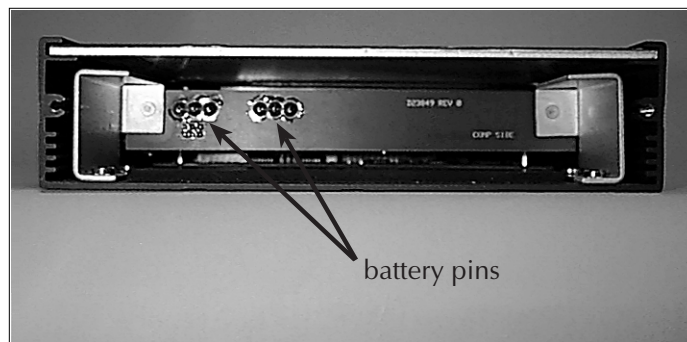

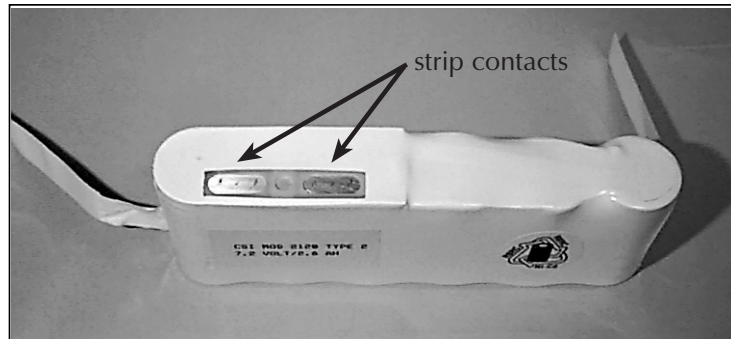

- 5.... Tuck the battery pack tabs into the case on the sides of the battery pack. Make sure that the tabs do not interfere with the installation of the bottom panel.
- 6.... Replace the bottom panel and screws.

---

**Caution!**

*Do not change the battery pack with the battery charger connected as damage may occur to the analyzer.*

See “Using the Model 8211 and Model 8212 Battery Chargers” on page 9-14 for information about recharging batteries using the 8211 battery charger.

---

**Note**

Optional accessories that provide alternative charging methods are available for the UltraSpec analyzer, see “Accessories and Optional Products” in the Appendices.

---

## 8215/8225 Fixtures General Maintenance

---

### Care and Handling

To ensure satisfactory service from this system, follow these procedures:

- Keep the mounting base and chain mounting posts lightly oiled to prevent them from corroding.
- To maintain repeatability and accuracy, avoid dropping fixture items. Refer to the Customer Assistance section for repair, update, and calibration.
- Do not subject system items to large temperature swings.
- Do not engrave on the sensor heads.
- Keep all lens free of grease, dirt, oil, and other smudges.
- Clean the laser and target lens with a soft, lint-free cloth and standard lens cleaning solution (a field size cleaner container is available from CSI). Never use an organic solvent such as a thinner or benzine.
- Store laser heads in the carrying case when not in use.

---

### Calibration

The Model 8215/8225 calibration should be checked every two years. Return the sensor heads to CSI for a calibration check. All calibrations are NIST traceable.

---

◆ **Conditions That can Cause Problems With the 8215/8225**

Water vapor or dust can interfere with a target “seeing” its laser. The air between the sensor heads should be visually clear. Take care to ensure that the air between the laser heads is not being heated from steam leaks, uninsulated piping, etc. Heated air rising within the span between the sensor heads can refract the laser beams and cause errors in the alignment readings.

Operate the 8215/8225 fixtures at ambient temperatures. If the fixtures have been stored at a different temperature than the ambient temperature, allow the 8215/8225 fixtures to reach ambient temperature. Ensure that any heat source that may be present is not creating a large temperature difference between the 8215/8225 fixtures and the ambient temperature. Sunlight itself will not cause a laser reading problem.

Conditions such as building construction materials and contents, other radio systems operation in the vicinity at or near the same operation frequency, and noise generated by nearby equipment may make RF communication unsatisfactory. If this problem occurs, use direct cable communications.

---

## Using the Model 8211 and Model 8212 Battery Chargers

---

### Battery Charging

Batteries may be charged with the Model 8211 or the Model 8212. The Model 8211 is a “smart, drop-in” charger that can provide a fast- or trickle-charge for the laser heads and analyzer. In fact, it can discharge the laser heads, if necessary. The Model 8212 is an “overnight” trickle-charger that can only trickle-charge laser heads and the analyzer.



### Model 8211 Smart Charger

The Model 8211 provides all battery charging needs and comes with the system. It is a “smart, drop in” charger for the laser heads; it will also charge the analyzer when plugged into a cable. The following picture shows both of the laser heads *and* the UltraSpec analyzer being charged.

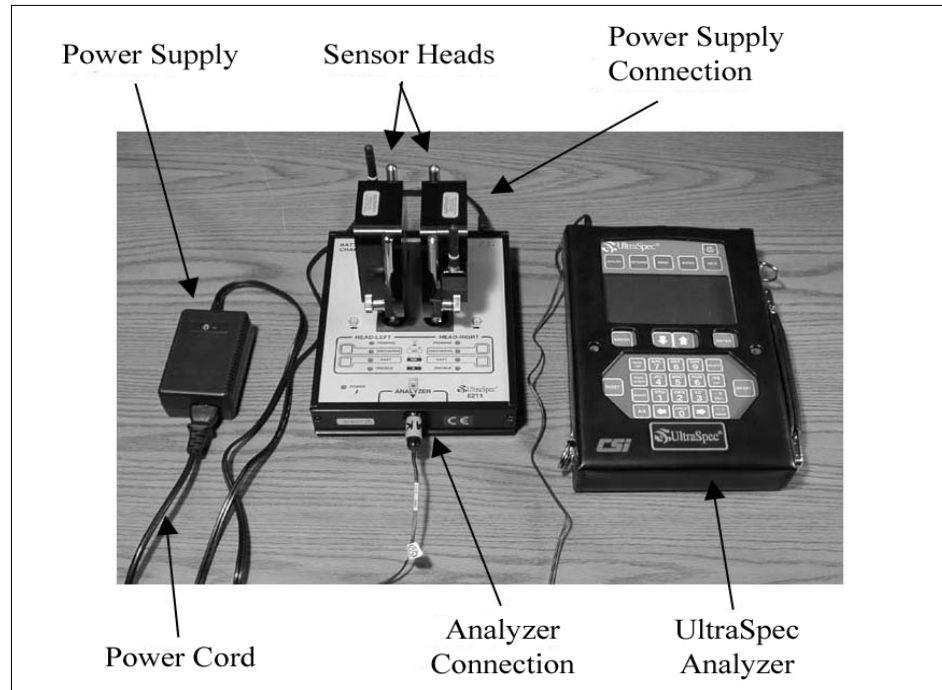

Charging the Sensor Heads and Analyzer with Model 8211 Charger

To set up the 8211, complete these steps:

1. ... Plug the power cord into the power supply.
2. ... Plug the power cord into an AC receptacle.
3. ... Plug the power supply into the 8211 in the top end cap.

At that time, the beeper will sound indicating that power has been applied to the battery charger. As a test, all LEDs will illuminate for 1.5 seconds.

4. ... Plug the analyzer charging cable into the bottom end cap.

The sensor heads and analyzer can now be charged either individually or, all at the same time.

### Charging the Sensor Heads with the Model 8211

Place the sensor heads over the posts so that the heads face outward as shown in “Charging the Sensor Heads and Analyzer with Model 8211 Charger” on page 9-15. Heads can be charged individually or together.

<b>Indicator Light</b>	<b>Charging Status</b>
Pending	Waiting for safe voltage and temperature
Discharge (steady)	Batteries discharging
Discharge (flashing)	Discharge requested, waiting for safe voltage or temperature
Fast (steady)	Batteries in fast charge
Fast (flashing)	Fast charge requested, waiting for safe voltage or temperature
Trickle	Batteries in trickle charge, topping-off, or charge complete

For maximum safety, the battery charger has a “Pending” status LED, which lights momentarily when the head is first placed on the charger. If a battery is very low, or is out of a specific temperature range, it cannot be safely charged. When this condition occurs the “Pending” indicator remains light. While “Pending,” the charger is actually charging the batteries at a very low rate. This brings the low battery into acceptable voltage range. Once the battery temperature and voltage are suitable for charging, the charger automatically begins trickle charging and the “Trickle” indicator light turns on.

To fast charge or discharge the battery the “Fast” button or “Discharge” button must be pressed. If the “Fast” button or “Discharge” button is pressed while the battery voltage is too low or temperature is not suitable for “Fast” or “Discharge” operation, the indicator light will flash on and off. This response acknowledges the request but indicates that the charger cannot follow the request at that time. Once voltage and temperature conditions are suitable, the requested “Fast” or “Discharge” operation will begin and the indicator light will change to a steady light.

---

**Warning!**

**Note that if the battery is fully charged, a user is able to initiate fast charge by pressing the “Fast” button. After about 2 minutes, the charger will stop fast charge in this case. However, to avoid overcharging batteries, you should not press the “Fast” button with an already fully charged battery.**

After the “Fast” charging cycle has completed the charger beeper will sound and automatically begin trickle charging. When this condition begins the “Trickle” indicator light turns on indicating that the battery is almost completely charged or is completely charged. For the laser head batteries, the two conditions occur within a few minutes of each other. Charge time from a fully discharged set of batteries to approximately a 90% voltage charge is 15 minutes.

After the “Discharge” cycle has completed the charger automatically begins fast charging and the “Fast” indicator light turns on. To avoid the battery memory concern, use the “Discharge” mode when you have more than 20 minutes to charge the sensor head batteries. The typical charge cycle is as follows:

<b>Action</b>	<b>Time</b>
Press DISCHARGE button	Start
DISCHARGE complete, FAST starts	7 minutes
FAST complete, TRICKLE starts – charging complete	22 minutes
<b>NOTE:</b> The heads can be left on TRICKLE indefinitely (until the next time they are needed).	

---

**Note**

After power has been applied to the charger and the sensor head have been placed in it, if none of the LED's for that sensor head are lit then the contact between the sensor head and charger may not be sufficient enough to charge the batteries. No LED's lit indicates a “no battery present” state. If this occurs, remove the sensor head from the charger and try reseating it back into the charger.

---

**Note**

After a charging cycle has begun, if that charging cycle is interrupted (e.g. disconnecting the power to the charger or removing the sensor head from the charger) the charging process described above begins again from the beginning. Therefore, if the charger cycle is interrupted while the “Fast” charge mode is in progress then the charger will then automatically begin trickle charging after “Pending.”

“Pending LED” will light momentarily and switch into FAST charge. Charge time for a fully discharged set of batteries is 15 minutes. The beeper will sound when both heads are charged (90%) and have switched to TRICKLE charge. To avoid the NiCad battery memory concern, use the DISCHARGE mode when you have more than 20 minutes to charge the sensor head batteries.

### **Charging the UltraSpec 8000 Analyzer with the Model 8211**

Plug the charging cable (A821101) from the bottom end cap on the 8211 (earlier than Rev. 4) into the top of the analyzer. TRICKLE mode will start the charge cycle. To change to FAST mode, press the FAST button in the Analyzer section. The analyzer battery is not monitored but utilizes a timer to avoid overcharging. The 8211 will charge the analyzer in FAST mode for 15 hours or until the FAST button is pressed again (whichever comes first). If the 8211 charger is Rev. 4 or later, it cannot be used to charge an UltraSpec 8000 analyzer.

### **Charging the Model 8117 Analyzer with the Model 8211 Charger**

Plug the charging cable (A821102) from the bottom end cap on the 8211 into the charger port on the top end cap of the 8117 analyzer. The battery pack will recharge in 14 to 16 hours. If the batteries are continually allowed to remain on charge for longer than 16 hours, battery degradation will occur. Overnight charging is allowable, however, charging over a weekend is not recommended.

### **Charging the Model 2120 Analyzer with the Model 8211 Charger**

Plug the charging cable (A821102) from the bottom end cap on the 8211 into the charger port on the top end cap of the 2120 analyzer. The battery pack will recharge in two and one half hours. After the battery pack has been fully charged, the battery charger will automatically switch to a trickle charge.

### **Model 8212 Trickle Charger**

The Model 8212 battery charger is a trickle charger for the laser heads and the Model 8117 UltraSpec analyzer. It will charge the laser heads and analyzer in ten hours. This is intended to be an overnight charge. The laser heads should not be left on charge over 24 hours. Continual overcharging the batteries will result in a shortened life.

To set up the Model 8212 charger, complete the following steps:

1. ... Plug the power cord into the power supply that came with the 8117 or 2120 analyzer.
2. ... Plug the power cord into an AC receptacle.
3. ... Plug the power supply into the Power connection on the 8212. Ensure the associated LED illuminates.
4. ... Plug the laser heads into the A and B pigtails from the 8212. Ensure the associated LEDs illuminate.
5. ... To charge the analyzer, plug the 821102 charge cable into the analyzer connector on the 8212. Ensure the associated LED on the 8212 illuminates.

See the photo below that illustrates the 8212 setup with a pair of laser heads and a Model 8117 UltraSpec analyzer.

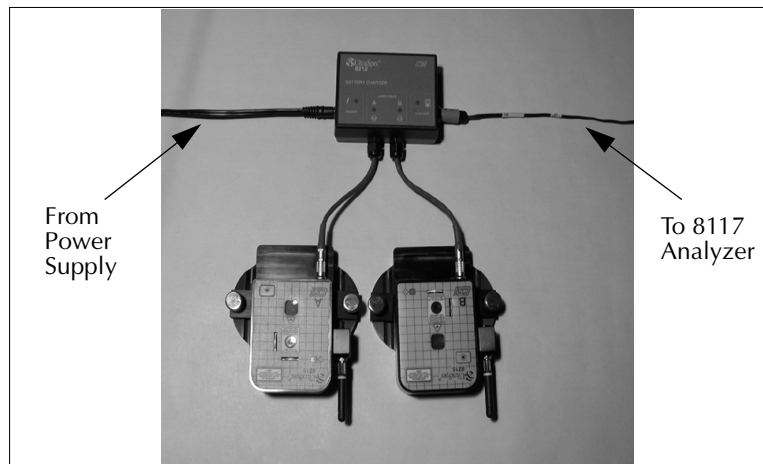

Charging the Model 8215 Laser Heads with the Model 8212 Charger

### **Charging the Model 8117 and 2120 Analyzers with the Model 8212 Charger**

After plugging the charging cable (A821102) into the 8212, plug the other end of the cable into the charger connection on the top end cap of the Model 8117 or the Model 2120 analyzer. Ensure the LED on the analyzer illuminates, if applicable. The Model 8117 battery pack will recharge in 14 to 16 hours. If the batteries are allowed to continually remain on charge for longer than 16 hours, battery degradation will occur. Overnight charging is allowable, however, charging over a weekend is not recommended. The Model 2120 battery pack will recharge in two hours then switch to a trickle charge that will not damage the battery.

### **Charging the Model 8000 Analyzer with the Model 8212 Charger**

The Model 8212 trickle charger CAN NOT charge an UltraSpec 8000 analyzer. To charge the 8000 use either a Model 8211 (previously discussed in this section) or the Model 2115-C-120 wall charger.

---

**Note**

See “UltraSpec 8000 Analyzer Battery Recharge” on page 9-6 and “UltraSpec 8117 Analyzer Battery Recharge” on page 9-9 for information on optional methods of charging the UltraSpec analyzer.

---

### **Battery Usage - Laser Heads**

A rechargeable battery pack is used to power each sensor head. A fully charged battery pack will give 3 to 4 hours of continuous service while transmitting data. Longer operation is possible since typical alignments do not require continuous communication with the analyzer. The battery is designed to have a long life and is not intended to be replaced by the user. Replacement should be performed only at CSI. CSI recommends that the batteries be replaced after 1,000 charges/discharges.

To conserve battery life, the 8215/8225 has a sleep mode and a shutdown mode. The sleep mode is activated after 5 minutes of no communication with the analyzer. In the sleep mode, the laser beam and RF communication are shutdown until communication is reestablished. All data in memory is saved. In the auto-shutdown mode, the sensor heads are completely shutdown. The Power button will start the sensor heads again. All data in memory is lost, therefore another sweep should be taken.

The sleep and auto-shutdown modes can be disabled. When turning the sensor heads on, press and hold down the Power button (the LEDs will turn on when the Power buttons are first pressed). The LEDs will turn off when the sleep mode is disabled (approximately 3 seconds). When both LEDs light again, the shutdown mode will be disabled (approximately 5 seconds). Refer to “Laser Head Status Screen” on page 3-8 for more information.

---

**Note**

Please note that this disables the battery conservation (for the sensor heads) therefore, if the heads are left on, the batteries will run down.