

PowerGrid-9172AC

G.hn+11ac Wi-Fi Powerline Adapter

User Manual



Preface

This manual provides information related to the installation and operation of this device. The individual reading this manual is presumed to have a basic understanding of telecommunications terminology and concepts.

If you find the product to be inoperable or malfunctioning, please contact technical support for immediate service by email at homesupport@comtrend.com

For product update, new product release, manual revision, or software upgrades, please visit our website at <http://www.comtrend.com>

Important Safety Instructions

In order to keep the safety of users and your properties, please follow these safety instructions:

1. This power line access point is designed for indoor use only; DO NOT place this power line access point outdoor.
2. DO NOT put this power line access point at or near hot or humid places, like a kitchen or bathroom. Also, do not leave this power line access point in the car under direct sunlight.
3. DO NOT pull any connected cable with force; disconnect it from the power line access point first.
4. If you want to place this power line access point at high places, please make sure the power line access point is firmly secured. Falling from high places would damage the power line access point and its accessories, and warranty will be void.
5. There's no user-serviceable part inside the access point. If you found that the power line access point is not working properly, please contact your dealer of purchase and ask for help. DO NOT disassemble the access point, warranty will be void.
6. If the power line access point falls into water when it's powered, DO NOT use your hand to pick it up. Switch the electrical power off before you do anything, or contact an experienced electrical technician for help.

Copyright

Copyright©2017 Comtrend Corporation. All rights reserved. The information contained herein is proprietary to Comtrend Corporation. No part of this document may be translated, transcribed, reproduced, in any form, or by any means without prior written consent of Comtrend Corporation.

This program is free software: you can redistribute it and/or modify it under the terms of the GNU General Public License as published by the Free Software Foundation, either version 3 of the License, or (at your option) any later version.

This program is distributed in the hope that it will be useful, but WITHOUT ANY WARRANTY; without even the implied warranty of MERCHANTABILITY or FITNESS FOR A PARTICULAR PURPOSE. See the GNU General Public License for more details.

You should have received a copy of the GNU General Public License along with this program. If not, see <http://www.gnu.org/licenses/>

NOTE: This document is subject to change without notice.

Protect Our Environment



This symbol indicates that when the equipment has reached the end of its useful life, it must be taken to a recycling centre and processed separate from domestic waste.

The cardboard box, the plastic contained in the packaging, and the parts that make up this device can be recycled in accordance with regionally established regulations. Never dispose of this electronic equipment along with your household waste; you may be subject to penalties or sanctions under the law. Instead, please be responsible and ask for disposal instructions from your local government.

CATALOG

CHAPTER 1 INTRODUCTION	5
1.1 SYSTEM REQUIREMENTS.....	5
CHAPTER 2 HOW TO INSTALL PG-9172AC	6
CHAPTER 3 LED INDICATIONS	12
CHAPTER 4 BUTTON FUNCTIONS	13
CHAPTER 5 WIRELESS SYSTEM AND NETWORK SETUP	14
5.1 CONNECT TO POWER LINE ACCESS POINT BY WEB BROWSER	14
5.2 CONNECTING TO WEB MANAGEMENT INTERFACE	15
5.3 VIEW SYSTEM INFORMATION	16
5.4 NETWORK SETTINGS.....	18
5.5 STATIONS LIST	18
5.6 NETWORK TIMING	19
5.7 ACCESS POLICY	20
5.8 ADMINISTRATION.....	21
5.9 MONITOR.....	22
5.10 LOGOUT.....	22
CHAPTER 6 WIRELESS CONFIGURATIONS	23
6.1 2.4G WIRELESS SETTINGS	23
6.1.1 Multiple BSS	24
6.2 2.4G SECURITY SETTINGS.....	25
6.3 2.4G WPS SETTINGS	26
6.4 2.4G AIR TIME MANAGEMENT.....	27
6.4.1 2.4Ghz Air Time Management.....	27
6.4.2 Configuration.....	28
6.4.3 Per BSS Weights.....	28
6.4.4 Per Station Weights.....	28
6.5 5G WIRELESS SETTINGS	29
6.5.1 Multiple BSS	30
6.6 5G SECURITY SETTINGS.....	31
6.7 5G WPS SETTINGS.....	32
6.8 5G AIR TIME MANAGEMENT.....	33
6.8.1 5Ghz Air Time Management.....	33
6.8.2 Configuration.....	34
6.8.3 Per BSS Weights.....	34
6.8.4 Per Station Weights.....	34
CHAPTER 7 G.HN/POWERLINE SETUP	35
7.1 CONFIGURE STATIC IP MODE	35
7.2 LOGGING IN.....	36
7.3 G.HN INTERFACE	37
7.3.1 Basic Configuration.....	38
7.3.2 NDIM Configuration.....	38
7.3.3 Encryption Configuration via WEB UI.....	38
7.4 IP INTERFACE.....	39
7.4.1 IP config.....	40
7.5 ETHERNET INTERFACE	41
7.6 DEVICE INTERFACE.....	42
7.6.1 Hardware information	42
7.6.2 Software information.....	42
7.6.3 Security	43
7.6.4 SW update	43
7.6.5 HTTP SW update.....	43
7.7 MULTICAST INTERFACE.....	44
7.7.1 MCAST Configuration	44
7.8 QoS MENU.....	45
7.8.1 QoS Configuration.....	45

7.9 VLAN INTERFACE	48
7.9.1 VLAN Configuration	48
7.10 G.HN SPECTRUM INTERFACE.....	49
7.10.1 Notches	49
7.11 LOG FILE INTERFACE.....	50
7.11.1 Log File.....	50
7.12 ADVANCED INTERFACE	51
CHAPTER 8 CLI COMMANDS FOR TR069 SETTINGS VIA TELNET	52

Chapter 1 Introduction

Comtrend's PG-9172AC is designed to meet the growing demand for perfect connectivity and coverage across multiple devices connected concurrently throughout the home. The G.hn Powerline Wi-Fi extender allows users to take Wi-Fi with them anywhere throughout the home or backyard and enjoy a seamless wireless experience.

1.1 System Requirements

- Computer or network devices with wired or wireless network interface card
- Any connected devices must feature a network port
- Web browser (Microsoft Internet Explorer 4.0 or above, Google Chrome web browser, Opera web browser, or Safari web browser)
- An available AC power socket (100 – 240 V, 50/60Hz)

Chapter 2 How to Install PG-9172AC

(A) Understanding the AC1200 G.hn Powerline Adapter

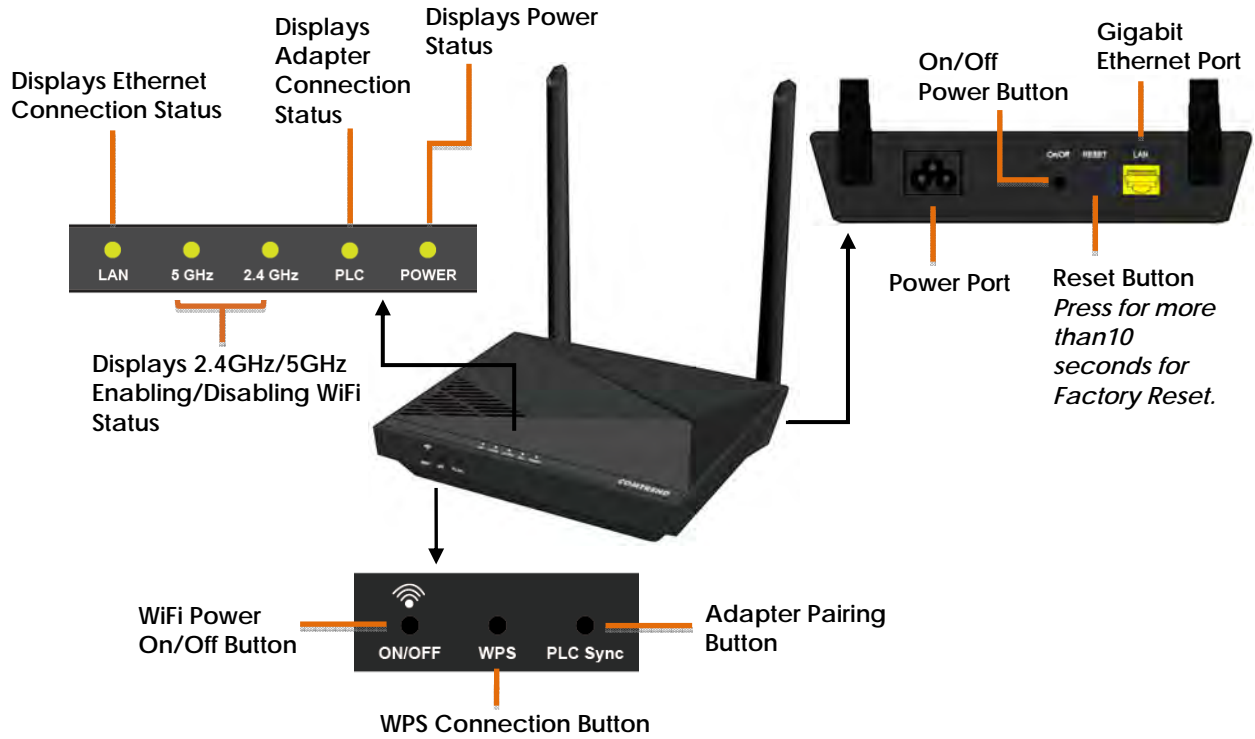

How to Create a Basic (2 unit) G.hn Powerline Network

Purpose	Recommended Primary Adapter	Second Adapter
• Connecting a single dedicated Internet Device	PG-9172**	PG-9172**
• Bringing wireless to a remote location	PG-9172**	PG-9172AC
• Connecting a PoE Enabled Device	PG-9172**	PG-9172PoE

A G.hn Powerline Network can consist of a minimum of 2 and up to 16 devices total.

**The PG-9172 can be replaced by another G.hn Powerline Adapter.

NOTE: The following steps show how to create or add onto a G.hn Powerline Network using a PG-9172AC.

(A minimum of two G.hn Powerline Adapters are required to create a proper connection.)

→ If this is the first time you are setting up a G.hn Powerline Network please continue to Section B.

→ If you already have an established G.hn Powerline Network and are adding an additional adapter, please skip to Section C.

(B) Creating a New G.hn Network

1. Plug a PG-9172* unit into the power outlet closest to the Network Device (Modem, Router). Do not plug the adapter into a power strip or surge protector, as network performance could degrade significantly.

***NOTE:** It is suggested that you use the PG-9172 as the primary connection to the Network Device, however, the PG-9172 can be replaced by another G.hn Powerline Adapter.

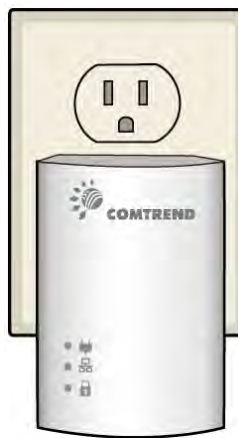

PG-9172

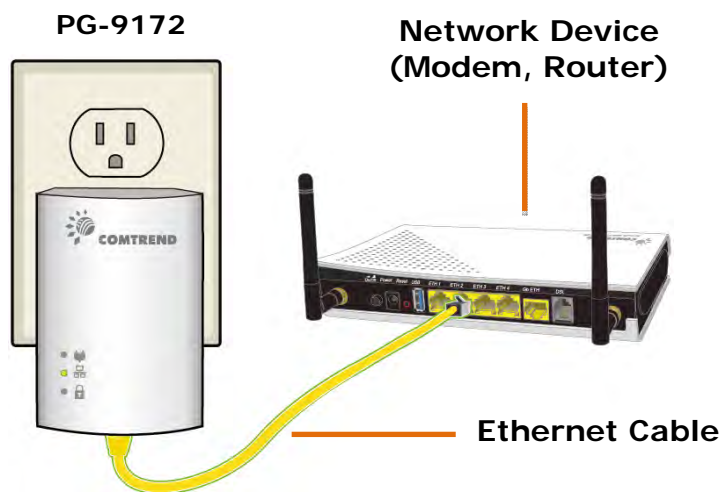

2. Connect the PG-9172 to a Network Device with an Ethernet (RJ-45) cable. (Wait 10 seconds for the **Network Indicator**  to light up **GREEN**, which indicates a good connection. A flashing **GREEN** light indicates that the device has a good connection and is also sending data).







(C) Adding to an Existing G.hn Network

3. Plug the PG-9172AC into the power outlet closest to the location you want to add wireless and/or near an Internet-Enabled Device you would like to directly connect to the adapter. The **Power Indicator**  should light up.
4. Optionally, to add an Internet- Enabled Device, directly connect the PG-9172AC to the Internet-Enabled Device with an Ethernet cable. (The **Network Indicator**  on the PG-9172 and the **LAN Indicator**  of the PG-9172AC should both be **GREEN** representing a strong connection).



(D) Security Setup

NOTE: G.hn Adapters will automatically “pair” in “non-secure” mode. It is highly recommended to follow Step 5 to create a secure connection.

5. Press the “Config” Button of a PG-9172 in the existing network for 2 seconds. You will see the **Security Indicator**  start flashing **GREEN**. Within two minutes, press the “PLC Sync” Button on the PG-9172AC for 2 seconds until you see the **PLC Indicator**  start flashing **GREEN**. (When the adapters are successfully paired with a strong connection the PG-9172’s **Security Indicator**  and **Connection Indicator**  will be solid **GREEN** and the PG-9172AC’s **PLC Indicator**  will be solid **GREEN**.)
6. Repeat Steps 3 to 5 to add additional adapters/devices.

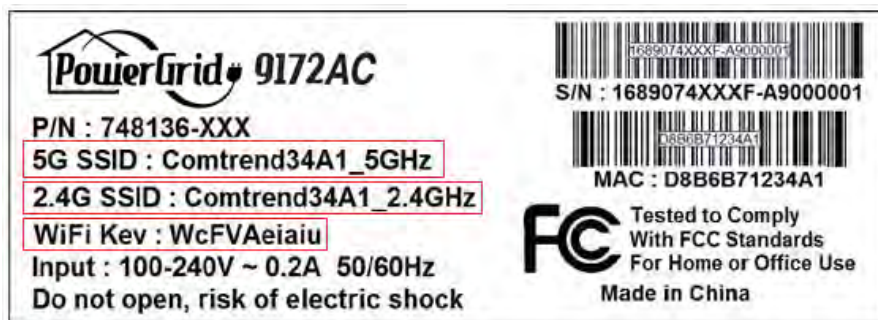

(E) Connecting Your WiFi Devices to the New PG-9172AC Access Point

- For some devices (E.g. laptops, cameras, set-top-boxes, etc.) wireless connectivity can be done via WPS (Wireless Protected Setup). WPS allows you to simply connect devices to the new Access Point without entering a username/password manually. To do this, please follow the instructions in Section F below.
- You have created a new Internet Access Point and it is now active and ready to use! To connect your WiFi devices to your new PG-9172AC WiFi Access Point, select the PG-9172AC Access Point using your WiFi device's standard network list. The Network Name (SSID) and Password (WiFi Key) can be found on the bottom of the PG-9172AC.



- Go to Section G.

(F) Setup of Wireless Devices via WPS (WiFi Protected Setup)

- Press and hold the "WPS" Button for more than 2 seconds on the PG-9172AC to activate its WPS. The PG-9172AC's **WiFi Indicators**   should flash to indicate a WPS connection is in progress.



- Within two minutes, press the "WPS" Button (often the WPS/Reset Button) on your remote Internet-Enabled Devices to activate WPS.

12. The devices will establish a secure connection.

(G) You Have Successfully Installed Your G.hn Powerline Adapter with WiFi!

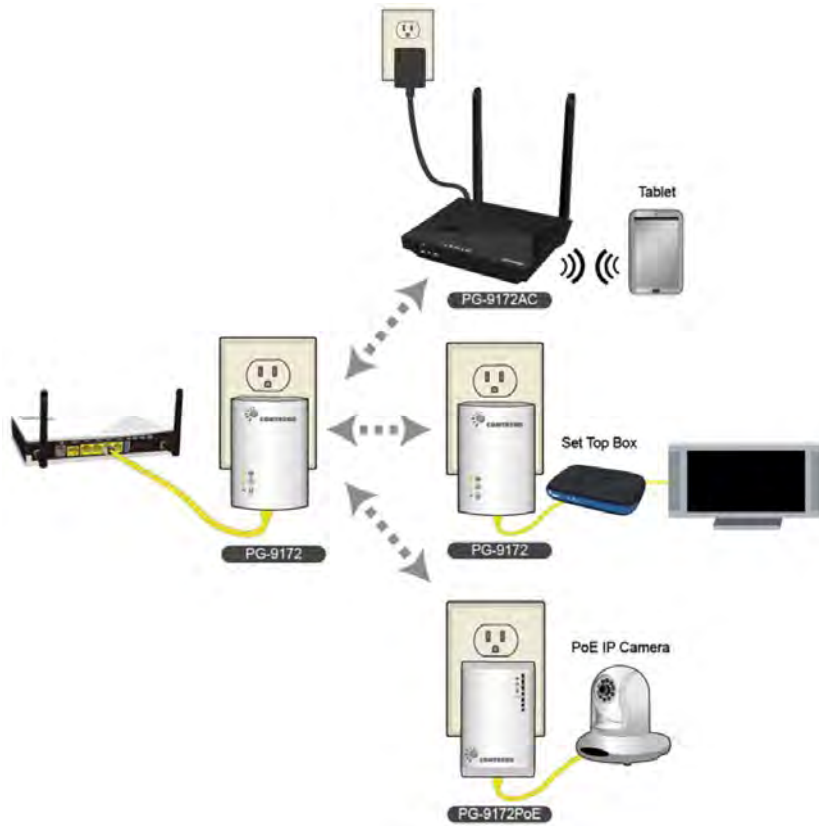

(H) Troubleshooting

The following information should help you diagnose basic setup or installation problems.

● POWER	POWER
● LAN	LAN
● ● 5 GHz 2.4 GHz	WiFi
● PLC	PLC

1) POWER Indicator is OFF: First try pressing the “Power” Button on the rear panel of the device. If the **Power Indicator** is still off, please make sure that your power socket is working properly (perhaps by testing with another device). Then plug in your PG-9172AC again and push the “Power” Button on the rear panel of the device.

2) LAN Indicator is OFF: The LAN Indicator is off when there is no directly connected device into the G.hn Adapters’ Ethernet Port. If there is a device connected and if the **LAN Indicator** is off, check that the Ethernet port of the Powerline Adapter is connected firmly to the Ethernet port of the other device. Also, you can check the condition of the Ethernet cable by using another Ethernet cable to test if the indicator turns on.

3) WiFi Indicators are OFF: To turn on both indicators (enable WiFi) you can press the “WiFi” Button  on the front of the device. You can also login to the G-9172AC Web and enable WiFi (5G only). See section 5.5 of the

User Manual for details.

4) PLC Indicator is OFF: This indicator shows that the adapter is paired to the G.hn Network. If this indicator is off, plug both Powerline Adapters that you're attempting to pair into power outlets that are located within the same room. All of the indicators of the device should blink (approx. 10 seconds), and the **PLC Indicator** should light up. If the **PLC Indicator** does not light up, it may indicate the existing G.hn network is secure and you have to pair the PG-9172AC to it in "secure mode." To do so, press the "PLC Sync" Button on the PG-9172AC for 2 seconds. Within 2 minutes, press the "Config" Button on the PG-9172 for 2 seconds (Holding for more than 4 seconds will clear the security key and require a re-pairing). The **PLC Indicator** will then light up **GREEN**. Afterwards, you can plug the units back into their original location.

5) PLC Indicator is Blinking RED: This indicator shows that the adapter is paired to the G.hn Network. If the **PLC Indicator** is blinking **RED**, then the adapter is paired in "non-secure" mode to the G.hn Network. It is optional to pair the device in "secure mode." To pair the device in "secure mode," press the "PLC Sync" Button on the PG-9172AC and the "Config" Button on the PG-9172 for 2 seconds. The **PLC Indicator** will then light up **GREEN**.

* If you have tried all of the above and are still experiencing problems, you can reset all devices to factory default by pushing the "Reset" Button on the PG-9172AC for more than 10 seconds AND the "Config" Button on the PG-9172 for 10 seconds.



FOR MORE HELP: For instructions on advanced features, FAQ, etc., please visit the PG-9172AC online Product Webpage on our website.

Chapter 3 LED Indications

LED	COLOR	MODE	DESCRIPTION
● PLC	Green	On	The current connection (line rate) is more than 40 Mbps
		Blink	(1). PLC pairing (2). System rebooting
	Orange	On	The current connection (line rate) is more than 20 Mbps and less than 40 Mbps
	Red	On	(1). The current connection (line rate) is between 1 and 20 Mbps per second (2). The PLC is in unsecure mode* and connected to other PLCs
		Off	No PLC connection exists
● 2.4 GHz	Green	Off	2.4GHz WLAN is disabled
		On	2.4GHz WLAN is on or activity occurring (tx/rx data and message)
		Blink	(1). Fast Blinking: 1.WPS SSID/Key sync copy failed (2). Slow Blinking: 1. Normal WPS sync activity 2. WPS SSID/Key sync activity 3. System in Factory Reset process
● 5 GHz	Blue	Off	5GHz WLAN is disabled
		On	5GHz WLAN is on or activity occurring (tx/rx data and message)
		Blink	(1). Fast Blinking: 1.WPS SSID/Key sync copy failed (2). Slow Blinking: 1. Normal WPS sync activity 2. WPS SSID/Key sync activity 3. System in Factory Reset process
● LAN	Green	Off	LAN Interface down
		On	LAN Interface up 10/100/1000
	Orange	Blink	(1). Fast Blinking: 1. WPS SSID/Key sync copy failed (2). Slow Blinking: 1. WPS SSID/Key sync activity 2. System in Factory Reset process
● POWER	Green	Off	System is powered off
		On	System is powered on
		Blink	(1). Fast Blinking: 1. WPS SSID/Key sync copy failed (2). Slow Blinking: 1. WPS SSID/Key sync activity 2. System in Factory Reset process

* **Note:** PG-9172AC does not support secured LED indication. If the PLC LED is RED in deployment, it may indicate that the G.hn network is in unsecured mode. The user needs to manually pair the PLC units to create a secure connection.

Chapter 4 Button Functions

BUTTON	WORDING ON ENCLOSURE	BUTTON FUNCTION	SECONDS TO PUSH BUTTON	DESCRIPTION
1	PLC Sync	PLC pairing	+2sec	Press more than 2 seconds (PLC LED starts slow blinking), and configuration period is open
2	WPS	WPS	2-5 sec	1. Press for 2-5 seconds, and both 2.4 GHz & 5 GHz LED blink slowly. 2. Then release the button, the AP WPS is in process.
		WiFi SSID/PW copy	+5 sec	Press for +5 seconds, 2.4 GHz & 5 GHz, LAN, and POWER LED blink slowly, the WLAN is in sync with main gateway for SSID and Key on 2.4GHz
3	RESET	Factory reset	+10 sec	Press more than 10 seconds: a factory reset of the system (both G.hn & WiFi) is performed
4	WiFi ON/OFF	Switch off/on 2.4GHz/5GHz WiFi interfaces	+2 sec	Disable/enable both 2.4G/5GHz WLAN interfaces by pushing the button for +2s
1&2	N/A	Switch off/on all LED's	+2 sec	Turn on/off all LED's by pushing both PLC Sync and WPS buttons simultaneously for +2s

Chapter 5 wireless System and Network Setup

5.1 Connect to power line access point by web browser

PG-9172AC supports two kinds of management IP.

- (1) DHCP client, which gets a dynamic IP address from the Modem/Broadband Router/Home Gateway that it is connected to by default.
- (2) Static IP, 192.168.0.5 by default, which can be configurable in the web UI.

Before you can connect to the power line access point and start configuration procedures, your computer must be able to get an IP address automatically (dynamic IP address). PG-9172AC gets a dynamic IP address from Modem/Broadband Router/Home Gateway that it is connected to by default. However, the current IP info of PG-9172AC would be displayed at the Modem/Broadcom Router/Home Gateway.

Also, the static IP of PG-9172AC can be accessed by the default static IP address of 192.168.0.5, subnet mask 255.255.255.0. Change your PC's static IP address to 291.68.0.100, subnet mask 255.255.255.0 for accessing web UI management.

5.2 Connecting to Web Management Interface

All functions and settings for the Wi-Fi AP of PG-9172AC must be configured via the web management interface. Please start your web browser, and input '192.168.0.5' in the address bar, then press the 'Enter' key. The following will be displayed:



The screenshot shows the login page for the COMTREND AC1200 G.hn Powerline Adapter. The page has a blue header with the COMTREND logo and the product name. Below the header, there is a light blue background with a login form. The form includes fields for IP (192.168.0.5), Username (root), and Password (masked with dots). There are 'Login' and 'Clear' buttons. At the bottom of the page, there is a 'goahead' logo and the text 'WEBSERVER™'.

Please input user name and password in their respective fields, default user name is '**root**', and default password is '**12345**', then press the **Login** button, to view the web management interface of this access point.

NOTE: If you can't see the web management interface, and you're being prompted to input user name and password again, it means you didn't input username and password correctly.

5.3 View System Information

The system information is on the left-side of the web page as shown below.

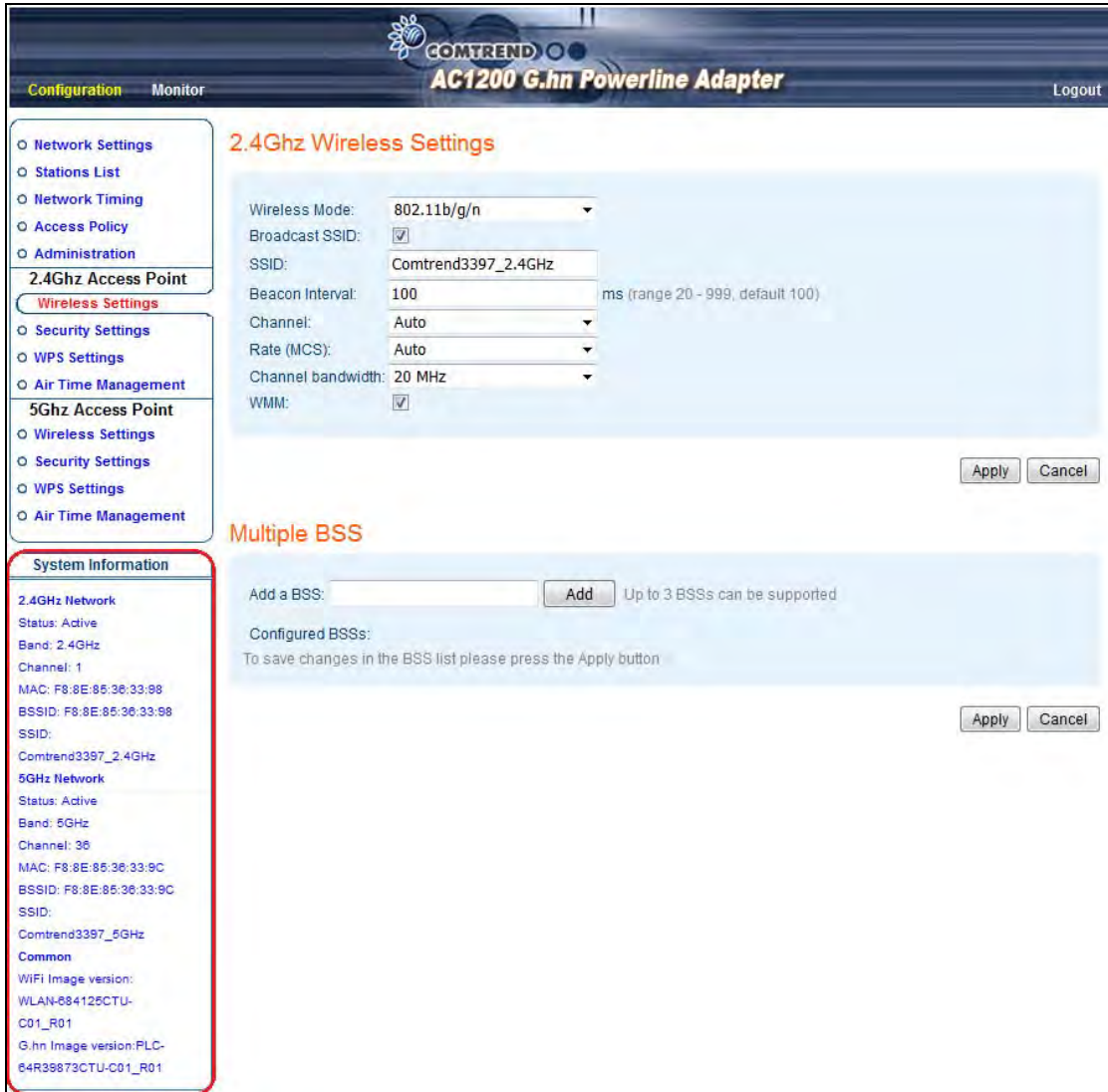

The screenshot displays the web interface for a Comtrend AC1200 G.hn Powerline Adapter. The interface is divided into a left sidebar and a main content area. The sidebar contains a navigation menu with the following items: Network Settings, Stations List, Network Timing, Access Policy, Administration, 2.4GHz Access Point, Wireless Settings (highlighted in red), Security Settings, WPS Settings, Air Time Management, 5GHz Access Point, Wireless Settings, Security Settings, WPS Settings, and Air Time Management. The 'System Information' section in the sidebar is also highlighted in red and contains the following details:

- 2.4GHz Network**
 - Status: Active
 - Band: 2.4GHz
 - Channel: 1
 - MAC: F8:8E:85:36:33:98
 - BSSID: F8:8E:85:36:33:98
 - SSID: Comtrend3397_2.4GHz
- 5GHz Network**
 - Status: Active
 - Band: 5GHz
 - Channel: 36
 - MAC: F8:8E:85:36:33:9C
 - BSSID: F8:8E:85:36:33:9C
 - SSID: Comtrend3397_5GHz
- Common**
 - WiFi Image version: WLAN-884125CTU-C01_R01
 - G.hn Image version: PLC-64R39873CTU-C01_R01

The main content area shows the '2.4GHz Wireless Settings' section with the following configuration:

- Wireless Mode: 802.11b/g/n
- Broadcast SSID:
- SSID: Comtrend3397_2.4GHz
- Beacon Interval: 100 ms (range 20 - 999, default 100)
- Channel: Auto
- Rate (MCS): Auto
- Channel bandwidth: 20 MHz
- WMM:

Below the settings are 'Apply' and 'Cancel' buttons. The 'Multiple BSS' section includes an 'Add a BSS' input field with an 'Add' button and a note that up to 3 BSSs can be supported. Below this is a 'Configured BSSs' section with a note to press the 'Apply' button to save changes, and 'Apply' and 'Cancel' buttons.

System Information

2.4GHz Network

Status: Active

Band: 2.4GHz

Channel: 1

MAC: F8:8E:85:36:33:98

BSSID: F8:8E:85:36:33:98

SSID:

Comtrend3397_2.4GHz

5GHz Network

Status: Active

Band: 5GHz

Channel: 36

MAC: F8:8E:85:36:33:9C

BSSID: F8:8E:85:36:33:9C

SSID:

Comtrend3397_5GHz

Common

WiFi Image version:

WLAN-684125CTU-C01_R01

G.hn Image version:PLC-64R39873CTU-C01_R01

Here are descriptions of every item:

Heading	Description
2.4GHz Network	Displays 2.4GHz AP status, Channel, MAC, BSSID and SSID string.
5GHz Network	Displays 5GHz AP status, Channel, MAC, BSSID and SSID string.
Common	WiFi and G.hn Image version information. WiFi Image version: PG-9172AC-WLAN-684125CTU-C01_R01 G.hn Image version: PG-9172AC-PLC-64R39873CTU-C01_R01

5.4 Network Settings

This page allows you to set the IP address for the web UI. Click the **Apply** button to reboot the system and implement your changes.



Network Settings

Obtain an IP address automatically
 Use the following IP address:

IP Address: 192 . 168 . 0 . 5
 Subnet Mask: 255 . 255 . 255 . 0
 Default Gateway: 192 . 168 . 1 . 254
 DNS Server: 8 . 8 . 8 . 8

Apply Cancel

5.5 Stations List

This page shows the information of wireless Stations that are connected to PG-9172AC.



Stations List

2.4Ghz Wireless Network

Wireless Interface 1 - "Comtrend3397_2.4GHz" - "F8:8E:85:36:33:98"	MAC Address	Rate (MCS)	Bandwidth

5Ghz Wireless Network

Wireless Interface 1 - "Comtrend3397_5GHz" - "F8:8E:85:36:33:9C"	MAC Address	Rate (MCS)	Bandwidth

Here are descriptions of every item:

Heading	Description
MAC address	This option will list the Wireless stations connected to the PG-9172AC at the 2.4G or 5GHz Interface.
Rate (MCS)	MCS# on the wireless interface with the station.
Bandwidth	Bandwidth, 20/40MHz for 2.4GHz, 20/40/80MHz for 5GHz

5.6 Network Timing

This page allows you to set the local time zone for TR069 management.

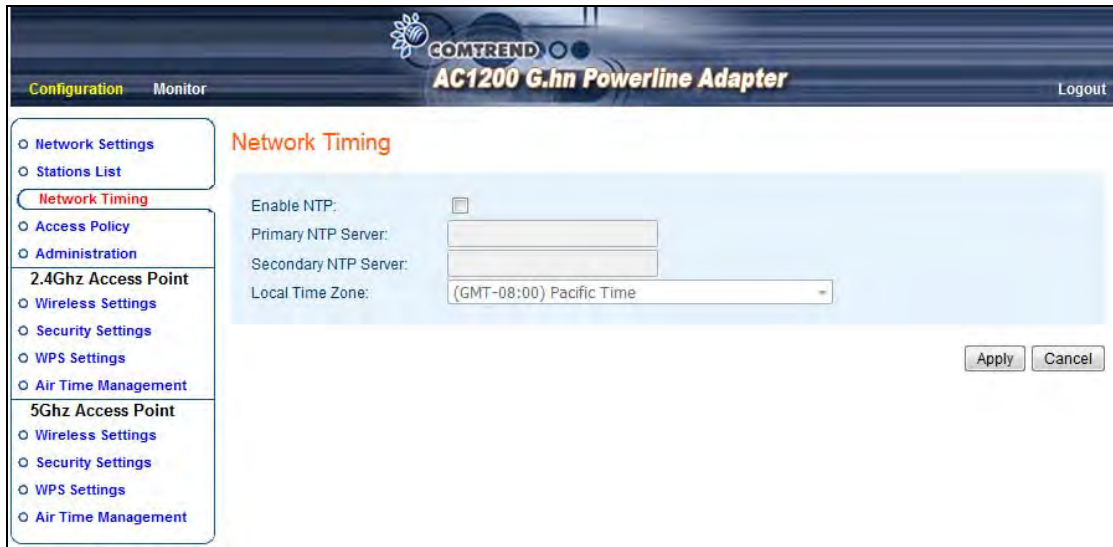

The screenshot shows the 'Network Timing' configuration page for a COMTREND AC1200 G.hn Powerline Adapter. The page has a navigation menu on the left with options like 'Network Settings', 'Stations List', 'Network Timing', 'Access Policy', 'Administration', '2.4Ghz Access Point', '5Ghz Access Point', etc. The main content area is titled 'Network Timing' and contains the following settings:

- Enable NTP:
- Primary NTP Server:
- Secondary NTP Server:
- Local Time Zone:

Buttons for 'Apply' and 'Cancel' are located at the bottom right of the settings area.

Heading	Description
Enable NTP	You can decide to set up NTP client by clicking checkbox.
Primary NTP Server	Input the Primary NTP Server, for example: us.pool.ntp.org, etc.
Secondary NTP Server	Input the Secondary NTP Server, for example: www.nist.gov
Local Time Zone	You can select your Time Zone from the drop-down menu.

5.7 Access Policy

This page allows you to set the Access Policy for a specific MAC address.



Here are descriptions of every item:

Heading	Description
Policy:	This option will allow/reject the list of wireless stations.
Add a station MAC	MAC format is XX:XX:XX:XX:XX:XX

A maximum of 32 entries can be configured.

To save changes in the MAC addresses list press the **Apply** button.

5.8 Administration

This page allows you to upgrade the software, view the components versions, change the password, download log files, restore defaults or reboot the system.

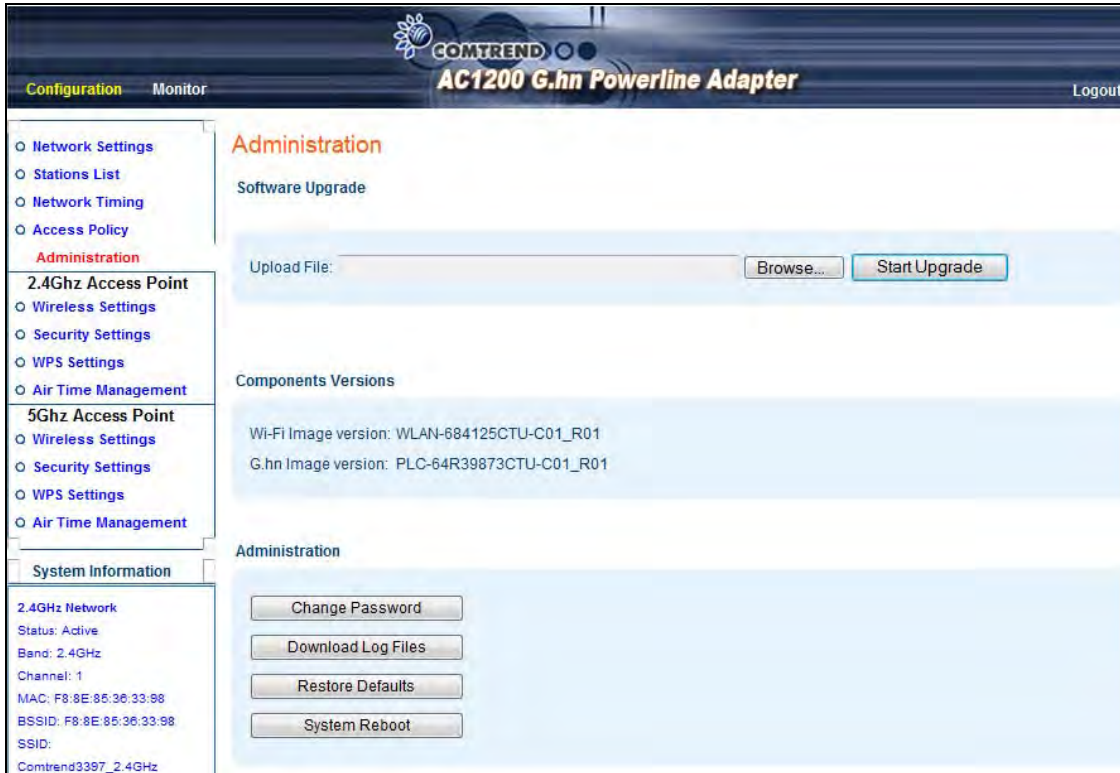

Here are descriptions of every setup item:

Heading	Description
Software Upgrade	Select the firmware file for the PG-9172AC from the local driver of your laptop. *PLC firmware can be updated via Marvell's SCT tool locally or via TR069 protocol remotely.
Components Versions	Wi-Fi Image version: PG-9172AC-WLAN-684125CTU-C01_R01 G.hn Image version: PG-9172AC-PLC-64R39873CTU-C01_R01
Change Password	Click this button to change the password (Only for "admin" account)
Download Log Files	Reserved for debugging purpose
Restore Defaults	Click this button to reset all the settings of PG-9172AC to their factory defaults (Wi-Fi & G.hn PLC)
System Reboot	Click this button to restart the PG-9172AC

5.9 Monitor

This page shows the statistics on LAN, 2.4G & 5G interfaces.



Configuration **Monitor** Logout

2.4Ghz Counters

System Counters

LAN Interface	
Rx Packets:	7515
Rx Bytes:	2879639
Tx Packets:	3806
Tx Bytes:	1990045
Wireless Interface	
Rx Packets:	0
Rx Bytes:	0
Tx Packets:	0
Tx Bytes:	0



Configuration **Monitor** Logout

5Ghz Counters

System Counters

LAN Interface	
Rx Packets:	6325
Rx Bytes:	2575376
Tx Packets:	4529
Tx Bytes:	2528521
Wireless Interface	
Rx Packets:	0
Rx Bytes:	0
Tx Packets:	0
Tx Bytes:	0

5.10 Logout

Log out from the web management.



Configuration **Monitor** **Logout**

Chapter 6 Wireless Configurations

6.1 2.4G Wireless Settings

This page allows you to configure the basic settings for the 2.4GHz interface of the access point.



The screenshot shows the configuration interface for the 2.4GHz wireless settings. The page title is "2.4Ghz Wireless Settings". On the left, there is a navigation menu with options like "Network Settings", "Stations List", "Network Timing", "Access Policy", "Administration", "2.4Ghz Access Point", "5Ghz Access Point", and "System Information". The "2.4Ghz Access Point" section is expanded to show "Wireless Settings".

The main configuration area includes the following fields:

- Wireless Mode: 802.11b/g/n
- Broadcast SSID:
- SSID: Comtrend3397_2.4Ghz
- Beacon Interval: 100 ms (range 20 - 999, default 100)
- Channel: Auto
- Rate (MCS): Auto
- Channel bandwidth: 20 MHz
- WMM:

Buttons for "Apply" and "Cancel" are located at the bottom right of the settings area.

Below the main settings is a section titled "Multiple BSS". It contains an "Add a BSS:" input field with an "Add" button and the text "Up to 3 BSSs can be supported". Below this is a "Configured BSSs:" section with a note: "To save changes in the BSS list please press the Apply button". "Apply" and "Cancel" buttons are also present at the bottom right of this section.

The "System Information" section on the left shows the following details for the 2.4GHz Network:

- Status: Active
- Band: 2.4Ghz
- Channel: 1
- MAC: F8:8E:85:36:33:98
- BSSID: F8:8E:85:36:33:98
- SSID:

Here are descriptions of every setup item:

Heading	Description
Wireless Mode	802.11b/g legacy: auto selection of 802.11b/g. 802.11b/g/n: auto selection of 802.11b/g/n
Broadcast SSID	Decide if the wireless power line access point will broadcast its own SSID or not. You can hide the SSID of your wireless power line access point (set the option to 'Disable'), so only those who know the SSID of your wireless power line access point can get connected.
SSID	Please input the SSID (the name used to identify this wireless access point) here. You can input up to 32 alphanumerical characters. PLEASE NOTE THAT THE SSID IS CASE SENSITIVE.
Beacon Interval	The default is 100 ms and the acceptable range is 20 – 999(ms). It's safe to keep the default and it's not necessary to change unless you know the effect.
Channel	Select Auto, Or manually select a channel.
Rate(MCS)	Modulation and Coding Scheme. It's safe to select Auto and it's not necessary to change unless you know the effect.
Channel Bandwidth	Select the wireless channel width by drop-down menus(bandwidth taken by wireless signals of this access

	<p>point).</p> <p>20MHz : lower performance but less interference. 40MHz : Auto 40/20MHz(automatically select based on interference level)</p>
WMM	<p>WMM (Wi-Fi Multimedia) technology, can improve the performance of certain network applications, like audio/video streaming, network telephony (VoIP), and others. When you enable the WMM function, the power line access point will define the priority of different kinds of data, to give higher priority to applications which require an instant response. Therefore you can improve the performance of such network applications.</p>

6.1.1 Multiple BSS

A BSS, Basic Service Set consists of all the devices associated with an IEEE 802.11 wireless local area network (WLAN).

This section allows you to add up to 3 additional BSSIDs (Basic Service Set Identifiers) for the 2.4GHz interface of the access point.



The screenshot shows the configuration interface for a Comtrend AC1200 G.hn Powerline Adapter. The page is titled "2.4Ghz Wireless Settings" and includes a sidebar with navigation options like "Network Settings", "Stations List", and "2.4Ghz Access Point". The main content area shows settings for "Wireless Mode" (802.11b/g/n), "Broadcast SSID" (checked), "SSID" (Comtrend3397_2.4GHz), "Beacon Interval" (100 ms), "Channel" (Auto), "Rate (MCS)" (Auto), "Channel bandwidth" (20 MHz), and "WMM" (checked). Below this, the "Multiple BSS" section is highlighted with a red box. It features an "Add a BSS:" field with an "Add" button and a note "Up to 3 BSSs can be supported". Underneath, there is a table of "Configured BSSs" with three entries: BSS1, BSS2, and BSS3, each with its corresponding BSSID and a "Delete" button. The BSSIDs are F8:8E:85:36:33:A9, F8:8E:85:36:33:AA, and F8:8E:85:36:33:AB respectively. A note at the bottom of the section says "To save changes in the BSS list please press the Apply button".

To save changes in the BSS list click the **Apply** button.

6.2 2.4G Security Settings

This page allows you to configure the Security Settings for 2.4Ghz interface of the access point.



Click the **Apply** button to save your settings.

Here are descriptions of every setup item:

Heading	Description
Wireless Interface	Select the interface that you want to configure from the SSID or the BSSs you have added.
Security Mode	Select the encryption supported over wireless access. The encryption method can be Disabled/None, WPA-PSK, WPA2-PSK or WPA-PSK+WPA2-PSK.
Encryption Type	There are three types of Cipher: TKIP, AES, TKIP+AES
Pass Phrase	8 to 63 alphanumeric characters

6.3 2.4G WPS Settings

This page allows you to configure the WPS Settings for 2.4Ghz interface of the access point. Wi-Fi Protected Setup allows that each time you want to set up a connection, there is no need to select the encryption mode and enter the encryption password.



The screenshot shows the '2.4 Ghz Wi-Fi Protected Setup' configuration page. The 'WPS' dropdown is set to 'Enable'. Under 'Configure Enrollee', the 'via PBC' radio button is selected. The 'WPS Summary' table is as follows:

WPS Summary	
WPS Current Status:	Idle
WPS Configured:	Yes
WPS SSID:	Comtrend3397_2.4GHz
WPS Auth Mode:	WPA2-PSK
WPS Encryp Type:	AES
WPS Key (ASCII):	12345678

Heading	Description
WPS	Select to Enable/Disable WPS from the drop-down menu. Then click the Apply button to implement your selection.
Configure Enrollee	Select between via PBC (Push Button Control) and via PIN (Personal Identification Number)
WPS Status	Shows the current WPS status

Click the **Activating WPS** button to confirm your choice.

6.4 2.4G Air Time Management

This page allows you to configure the setting for Air Time Management of the 2.4GHz Access Point.



The screenshot displays the web interface for the COMTREND AC1200 G.hn Powerline Adapter. The page is titled "2.4Ghz Air Time Management" and is divided into several sections:

- Navigation Menu:** Includes options for Network Settings, Stations List, Network Timing, Access Policy, Administration, 2.4Ghz Access Point, 5Ghz Access Point, System Information, and Air Time Management (which is currently selected).
- 2.4Ghz Air Time Management Configuration:**
 - Air Time Management:** Set to "Disable".
 - Scheduler Algorithm:** Set to "Weighted Fairness".
 - Show throughput statistics:** Set to "Yes".
 - A note: "Please Apply changes before weights configuration".
 - Buttons: "Apply" and "Cancel".
- Per BSS Weights:**
 - SSID: Comtrend3397_2.4GHz, Weight: 0 (slider).
 - SSID: BSS1, Weight: 0 (slider).
 - SSID: BSS2, Weight: 0 (slider).
 - SSID: BSS3, Weight: 0 (slider).
 - Note: "To save changes in the list please press the Apply button".
 - Buttons: "Apply" and "Cancel".
- Per Station Weights:**
 - Form: "Add new station." with fields for MAC, Name, and Weight (slider).
 - Button: "Add".
 - Note: "Up to 15 stations can be supported".
 - Note: "To save changes in the list please press the Apply button".
 - Buttons: "Apply" and "Cancel".
- System Information (Left Panel):**
 - 2.4GHz Network:** Status: Active, Band: 2.4GHz, Channel: 6, MAC: F8:8E:85:36:33:A8, BSSID: F8:8E:85:36:33:A8, SSID: Comtrend3397_2.4GHz.
 - 5GHz Network:** Status: Active, Band: 5GHz, Channel: 44, MAC: F8:8E:85:36:33:AC, BSSID: F8:8E:85:36:33:AC, SSID: Comtrend33A7_5GHz.
 - Common:** WiFi Image version: WLAN-684125CTU-C01_R01, G.hn Image version: PG-9074-FLC-

6.4.1 2.4Ghz Air Time Management

This part shows the Statistics of BSS, Station or throughput.

Heading	Description
Per BSS Statistics	Displays each BSS's statistics
Per Station Statistics	Displays each Station's statistics
Throughput Statistics	Displays all statistics

6.4.2 Configuration

This part allows you to set up the Air Time Management, select the Scheduler Algorithm and whether show throughput statistics or not.

Heading	Description
Air Time Management	Select to Enable/Disable Air Time Management from the drop-down menu.
Scheduler Algorithm	Select to No Fairness(Round Robin)/Fairness/Weighted Fairness Scheduler Algorithm from the drop-down menu, No Fairness(Round Robin) : The order will decide the transmission, so the longer the device is connected, the longer the wait time. Fairness: Each device occupies the same transmission time. Weighted Fairness : According to the Weight you give will decide the priority of transmission.
Show Throughput Statistics	Select to YES/NO to Show Throughput Statistics.

Click the **Apply** button to implement your changes.

6.4.3 Per BSS Weights

This part allows you to configure each BSS's Weight from 0 to 100, the higher the Weight you give, the more priority it has.

To save changes in the list click the **Apply** button.

6.4.4 Per Station Weights

This part allows you to configure each WiFi station's Weight from 0 to 100, the higher the Weight you give, the more priority it has.

Heading	Description
MAC	Input the MAC address from the device which you want to add on.
Name	Input an ID for the station (Reserved)
Weight	Set the Weights for the Station from 0 to 100 by scrolling the scroll or Input number.

Click the **Add** button to create the new entry. Click the **Delete** button to remove an entry. To save changes in the list, click the **Apply** button.

6.5 5G Wireless Settings

This page is to configure basic settings for the 5GHz interface of the access point.



The screenshot shows the configuration interface for the COMTREND AC1200 G.hn Powerline Adapter. The page is titled "5Ghz Wireless Settings" and includes a sidebar with navigation options like "Network Settings", "Stations List", and "2.4Ghz Access Point". The main content area has two sections:

- 5Ghz Wireless Settings:** Contains checkboxes for "Enable 5Ghz Radio" and "Broadcast SSID" (both checked). The "SSID" field is set to "Comtrend3397_5GHz". The "Beacon Interval" is set to "100" ms. The "Channel" is set to "Auto", "Rate (MCS)" is "Auto", and "Channel bandwidth" is "80 MHz". The "WMM" checkbox is also checked. "Apply" and "Cancel" buttons are at the bottom right.
- Multiple BSS:** Includes an "Add a BSS:" field with an "Add" button and a note "Up to 3 BSSs can be supported". Below it, it says "Configured BSSs:" and "To save changes in the BSS list please press the Apply button". "Apply" and "Cancel" buttons are at the bottom right.

Here are descriptions of every setup item:

Heading	Description
Enable 5Ghz Radio	Tick to enable 5GHz radio.
Broadcast SSID	Decide if the wireless power line access point will broadcast its own SSID or not. You can hide the SSID of your wireless power line access point (set the option to 'Disable'), so only those who know the SSID of your wireless power line access point can get connected.
SSID	Please input the SSID (the name used to identify this wireless access point) here. You can input up to 32 alphanumerical characters. PLEASE NOTE THAT THE SSID IS CASE SENSITIVE.
Beacon Interval	The default is 100 ms and the acceptable range is 20 – 999(ms). It's safe to keep in default and it's not necessary to change unless you know the effect.
Channel	Select Auto, Or manually select a channel.
Rate(MCS)	Modulation and Coding Scheme. It's safe to select Auto and it's not necessary to change unless you know the effect.
Channel Bandwidth	Select wireless channel width from the drop-down menu(bandwidth taken by wireless signals of this access point). 20MHz : lower performance but less interference. 40MHz : Auto 40/20MHz

	80MHz : Auto 80/40/20MHz (automatically select based on interference level)
WMM	WMM (Wi-Fi Multimedia) technology, can improve the performance of certain network applications, like audio/video streaming, network telephony (VoIP), and others. When you enable the WMM function, the power line access point will define the priority of different kinds of data, to give higher priority to applications which require an instant response. Therefore you can improve the performance of such network applications.

6.5.1 Multiple BSS

A BSS, Basic Service Set consists of all the devices associated with an IEEE 802.11 wireless local area network (WLAN).

This section allows you to add up to 3 additional BSSIDs (Basic Service Set Identifiers) for the 5GHz interface of the access point.



To save changes in the BSS list click the **Apply** button.

6.6 5G Security Settings

This page allows you to configure the Security Settings for the 5Ghz interface of the access point.



The screenshot shows the web interface for the COMTREND AC1200 G.hn Powerline Adapter. The page title is "5Ghz Security Settings". On the left, there is a navigation menu with the following items: Network Settings, Stations List, Network Timing, Access Policy, Administration, 2.4Ghz Access Point (Wireless Settings, Security Settings, WPS Settings, Air Time Management), 5Ghz Access Point (Wireless Settings, Security Settings, WPS Settings, Air Time Management). The main content area contains the following settings:

- Wireless Interface: 1 - "Comtrend3397_5GHz" - F8:8E:85:36:33:9C
- Security Mode: WPA2-PSK
- Encryption Type: TKIP AES TKIP+AES
- Pass Phrase: 12345678

Buttons for "Apply" and "Cancel" are located at the bottom right of the settings area.

Here are descriptions of every setup item:

Heading	Description
Wireless Interface	Select the interface that you want to configure from the SSID or the BSSs you have added.
Security Mode	Select the encryption supported over wireless access. The encryption method can be Disabled/None, WPA-PSK, WPA2-PSK or WPA-PSK+WPA2-PSK.
Encryption Type	There are three types of Cipher: TKIP, AES, TKIP+AES
Pass Phrase	8 to 63 alphanumeric characters.

6.7 5G WPS Settings

This page allows you to configure the WPS Settings for the 5Ghz interface of the access point. Wi-Fi Protected Setup means that each time you want to set up a connection, there is no need to select the encryption mode and enter the encryption password.



The screenshot shows the '5Ghz Wi-Fi Protected Setup' configuration page. The WPS status is set to 'Enable'. The 'Configure Enrollee' section has 'via PBC' selected. The 'WPS Summary' table is as follows:

WPS Summary	
WPS Current Status:	Idle
WPS Configured:	Yes
WPS SSID:	Comtrend3397_5GHz
WPS Auth Mode:	OpenWPA2
WPS Encryp Type:	
WPS Key (ASCII):	12345678

Heading	Description
WPS	Select to Enable/Disable WPS from the drop-down menu.
Configure Enrollee	Select between via PBC (Push Button Control) and via PIN (Personal Identification Number)
WPS Status	Shows the current WPS status

Click the **Activating WPS** button to confirm your choice.

6.8 5G Air Time Management

This page allows you to configure the setting for Air Time Management of 5GHz Access Point.



The screenshot displays the web interface for the COMTREND AC1200 G.hn Powerline Adapter. The main content area is titled "5Ghz Air Time Management" and contains three expandable sections: "Per BSS Statistics", "Per Station Statistics", and "Throughput statistics". Below these is the "Configuration" section, which includes settings for "Air Time Management" (set to "Disable"), "Scheduler Algorithm" (set to "No Fairness (Round Robin)"), and "Show throughput statistics" (set to "Yes"). There are "Apply" and "Cancel" buttons. The "Per BSS Weights" section shows a table with columns for SSID and Weight, with three entries: "Comtrend3397_5GHz", "BSS1", "BSS2", and "BSS3", each with a weight of 0 and a corresponding slider. The "Per Station Weights" section includes a form to "Add new station" with fields for MAC, Name, and Weight, and an "Add" button. The left sidebar contains a navigation menu with categories like "Network Settings", "2.4Ghz Access Point", "5Ghz Access Point", and "System information". The "System information" section shows details for both 2.4GHz and 5GHz networks, including status, band, channel, MAC, and BSSID.

6.8.1 5Ghz Air Time Management

This part shows the Statistics of BSS, Station or throughput.

Heading	Description
Per BSS Statistics	Displays each BSS's statistics
Per Station Statistics	Displays each Station's statistics
Throughput Statistics	Display all statistics

6.8.2 Configuration

This part allows you to set up the Air Time Management, select the Scheduler Algorithm and whether to show throughput statistics or not.

Heading	Description
Air Time Management	Select to Enable/Disable Air Time Management from the drop-down menu.
Scheduler Algorithm	Select to No Fairness(Round Robin)/Fairness/Weighted Fairness Scheduler Algorithm from the drop-down menu, No Fairness(Round Robin) : The order will decide the transmission, so the longer the device is connected, the longer the wait time. Fairness: Each device occupies the same transmission time. Weighted Fairness : According to the Weight you give will decide the priority of transmission.
Show Throughput Statistics	Select to YES/NO to Show Throughput Statistics.

Click the **Apply** button to implement your changes.

6.8.3 Per BSS Weights

To save changes in the list click the **Apply** button.

6.8.4 Per Station Weights

This part allows you to configure each WiFi Station's Weight from 0 to 100, the higher the Weight you give, the more priority it has.

Heading	Description
MAC	Input the MAC address from the device which you want to add on.
Name	Input an ID for the station (Reserved)
Weight	Set the Weights for Station from 0 to 100 by scrolling the scroll or Input number.

Click the **Add** button to create the new entry. Click the **Delete** button to remove an entry.

Chapter 7 G.hn/Powerline Setup

7.1 Configure STATIC IP MODE

In static IP mode, you assign IP settings to your PC manually.

Follow these steps to configure your PC IP address to use subnet 10.10.1.x.

NOTE: The following procedure assumes you are running Windows XP. However, the general steps involved are similar for most operating systems (OS). Check your OS support documentation for further details.

- STEP 1:** From the Network Connections window, open Local Area Connection (*You may also access this screen by double-clicking the Local Area Connection icon on your taskbar*). Click the **Properties** button.
- STEP 2:** Select Internet Protocol (TCP/IP) and click the Properties button.
- STEP 3:** Change the IP address to the domain of 10.10.1x (70<x<255) with subnet mask of 255.255.255.0. The screen should now display as below.

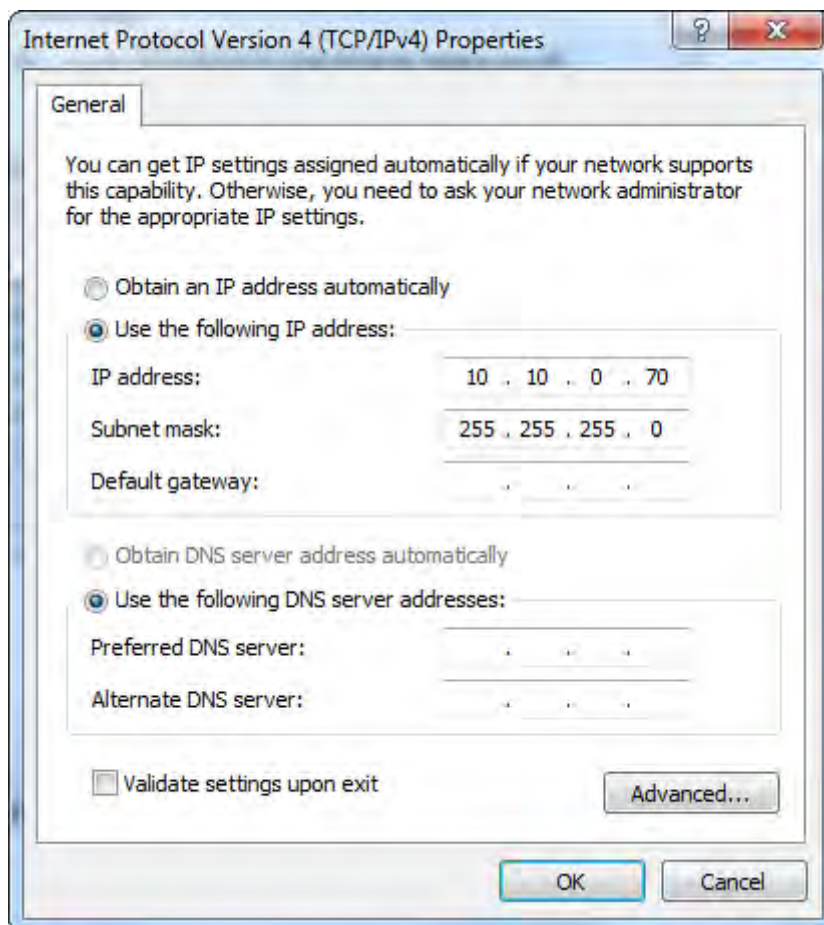

- STEP 4:** Click **OK** to submit these settings.

7.2 Logging In

Perform the following steps to login to the web user interface.

STEP 1: Start the Internet browser and enter the default IP address for the device in the Web address field. For example, if the default IP address is 10.10.0.69, type <http://10.10.0.69>

STEP 2: A dialog box will appear, such as the one below. Input the default Authentication Password.

Authentication Password: **admin**



Click **OK** to continue.

Note:

The Factory Reset password is: **betera**

7.3 G.hn Interface



PG-9172AC Web Configuration

[G.hn](#)

[IP](#)

[Ethernet](#)

[Device](#)

[Multicast](#)

[QoS](#)

[VLAN](#)

[G.hn spectrum](#)

[Log file](#)

[Advanced](#)

Basic settings

•MAC address f8:8e:85:36:33:96

•Device ID 1

•Domain Name

•Force node Type AUTOMATIC ▾

•Node type* DOMAIN_MASTER

* Node type change can take some time, please refresh page to update state

•G.hn profile PLC 50MHz MIMO_BOOST ▾

Neighboring Domain Interference Mitigation (NDIM)

•NDIM mode AUTOMATIC ▾

•Domain ID (DOD)

Encryption Configuration

•Encryption is DISABLED

•Pairing password

•Automatic configuration*:

* Pairing can take some time, please refresh page to update state

Available Connections

Device ID	MAC Address	Phy Tx (Mbps)	Phy Rx (Mbps)
<i>Empty list</i>			

37

Leading the **Communication Trend**

7.3.1 Basic Configuration

- **MAC Address** Displays the MAC address of the device.
- **Device ID** Device ID of this node.
- **Domain Name** string of all nodes in the network.
- **Force node Type** force the modem to have a particular role (END POINT or DOMAIN MASTER)
- **G.hn profile** of all nodes in the network: selecting which G.hn profile must be applied to the network (PLC 50MHz, PLC 50MHz with MIMO, PLC 100MHz, COAX 100MHz and PHONE 100MHz).

7.3.2 NDIM Configuration

- **NDIM mode** set to Automatic for enabling automatic DOD selection functionality and set to Manual for manual configuration of DOD.
- **Domain ID (DOD)** manually set the DOD number from 1 to 15 to use a different preamble seed than the default 13.

7.3.3 Encryption Configuration via WEB UI

- **Pairing Password** used for authentication. Write a custom password to manually create a secure domain.

Available Connections

- In this tab table, all the available **G.hn connections** are presented. Remote node DID and MAC address, transmission and reception physical speeds.

7.4 IP Interface



PG-9172AC Web Configuration

[G.hn](#)
[IP](#)
[Ethernet](#)
[Device](#)
[Multicast](#)
[QoS](#)
[VLAN](#)
[G.hn spectrum](#)
[Log file](#)
[Advanced](#)

IPv4 configuration*

DHCP enabled NO ▾

IPv4 address / netmask /

Default Gateway

DNS

Additional address #1 /

Additional address #2 /

*All changes except the DNS server will have effect after system boot

IPv6 configuration*

DHCP enabled NO ▾

IPv6 address / prefix /

Default Gateway

DNS

Additional address #1 /

Additional address #2 /

Additional address #3 /

Additional address #4 /

IPv6 link-local address /

IPv6 SLAAC address /

*All changes except the DNS server will have effect after system boot

NTPv4/v6 client configuration

NTPv4/v6 client enabled NO ▾

Resynchronization time

NTP IPv4/v6 address

7.4.1 IP config

In the **IP configuration** tab of one G.hn node, the IPv4 and IPv6 settings can be read and changed.

IPv4 subsection:

- **DHCPv4 enabled:** in the case of choosing "NO" IP configuration in the following parameters, the IPv4 Address, Subnet Mask, Default Gateway and DNS should be configured; fill these fields in. In the case of choosing "YES" they will be filled automatically when configuration is received from the DHCPv4 server.
- **IPv4 address/netmask:** IPv4 address / netmask of this device.
- **Default Gateway:** IPv4 gateway to connect the device to other LAN segments.
- **DNS:** Domain Name Server IP (IPv4).
- **Additional address #1/2:** additional fixed IPv4 addresses that will always be configured at boot time.

IPv6 subsection:

- **DCHPv6 enabled:** in the case of choosing "NO" IP configuration in the following parameters, the IPv6 Address, prefix, Default Gateway and DNS should be configured; fill these fields in. In the case of choosing "YES" they will be filled automatically when configuration is received from the DHCPv6 server.
- **IPv6 Address / prefix:** IPv6 address / prefix of the device to read the node's DHCPv6 address in case the DHCPv6 is enabled.
- **Default Gateway:** IPv6 gateway to connect the node to other LAN segments.
- **DNS:** Domain Name Server IP (IPv6).
- **Additional address #1/2/3/4:** additional fixed IPv6 addresses that will always be configured at boot time.
- **IPv6 Link-Local Address:** to read the node's Link Local address.
- **IPv6 SLAAC address:** IPv6 address, automatically obtained by means of the SLAAC mechanism.

NTPv4/v6 subsection:

- **NTPv4/v6 client enabled:** Enable/disable NTP client.
- **Resynchronization time:** Configure re-synchronization interval time in minutes.
- **NTP IPv4/v6 address:** Hostname or IP (IPv4 or IPv6) of NTP server.

7.5 Ethernet Interface

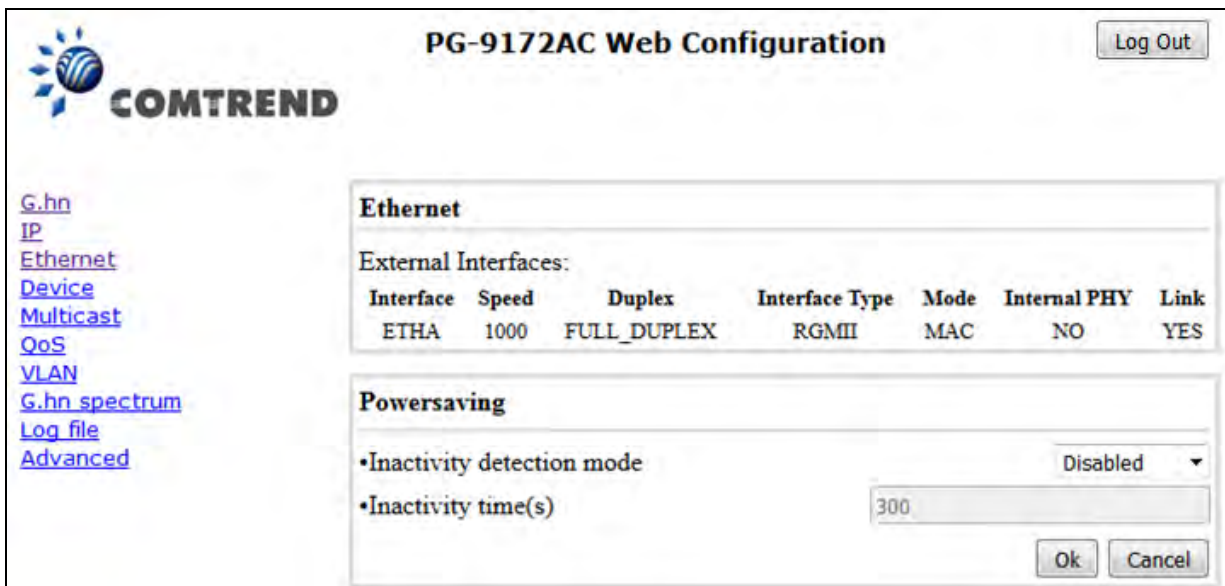

The screenshot shows the 'PG-9172AC Web Configuration' interface. On the left is a navigation menu with links: [G.hn](#), [IP](#), [Ethernet](#), [Device](#), [Multicast](#), [QoS](#), [VLAN](#), [G.hn spectrum](#), [Log file](#), and [Advanced](#). The main content area is titled 'Ethernet' and contains two sections:

Ethernet

External Interfaces:

Interface	Speed	Duplex	Interface Type	Mode	Internal PHY	Link
ETHA	1000	FULL_DUPLEX	RGMI	MAC	NO	YES

Powersaving

- Inactivity detection mode: Disabled (dropdown menu)
- Inactivity time(s): 300 (input field)

Buttons: Ok, Cancel

The Ethernet table shows the coverage & Info of the Ethernet interface; including Interface, Speed, Duplex, Interface Type, Mode, Internal PHY & Link.

Powersaving

Ethernet powersaving can be disabled, enabled by Ethernet link or enabled by Ethernet activity; idle timer can be configured as well.

7.6 Device Interface



PG-9172AC Web Configuration

[G.hn](#)
[IP](#)
[Ethernet](#)
[Device](#)
[Multicast](#)
[QoS](#)
[VLAN](#)
[G.hn spectrum](#)
[Log file](#)
[Advanced](#)

Hardware information

•Device name	PG-9172AC
•Device description	AC1200 G.hn Powerline Adapter
•Device manufacturer	Comtrend
•Serial number	00
•MAC address	f8:8e:85:36:33:96
•HW version	1_0

Software information

•FW version	PLC-64R39873CTU-C01_R01
•System uptime	0 days, 1h 14m 37s

Security

•New Configuration password

SW update

•Status Ready: initial status

•Protocol FTP ▾

•Server IPv4/v6

•FTP User

•FTP Password

•OSUP Filename

HTTP SW update

•Upgrade file:

7.6.1 Hardware information

In this tab, basic information such as MAC Address and Serial Number of the selected node is shown.

7.6.2 Software information

Shows the FW version and system uptime.

42

Leading the **Communication Trend**

7.6.3 Security

The nodes in the network: to change the configuration password string from the default ("admin") to another; decided by the user.

7.6.4 SW update

Current loaded firmware version is shown. Any flash section can be upgraded; the first flash section should be selected and after clicking on the "OK" button the corresponding file should be chosen. Usually, a reboot should be performed afterwards to make sure the changes are effective.

The protocol is by FTP client or TFTP client. L2 is proprietary and is reserved for future use.

7.6.5 HTTP SW update

STEP 1: Enter the path and filename of the firmware image file in the **Software File Name** field or click the Browse button to locate the image file.

STEP 2: Click the **OK** button once to upload and install the file.

NOTE: The update process will take about 2 minutes to complete. The device will reboot and the browser window will refresh to the default screen upon successful installation. It is recommended that you compare the **Software Version** on the [Device Interface](#) screen with the firmware version installed, to confirm the installation was successful.

7.7 Multicast Interface

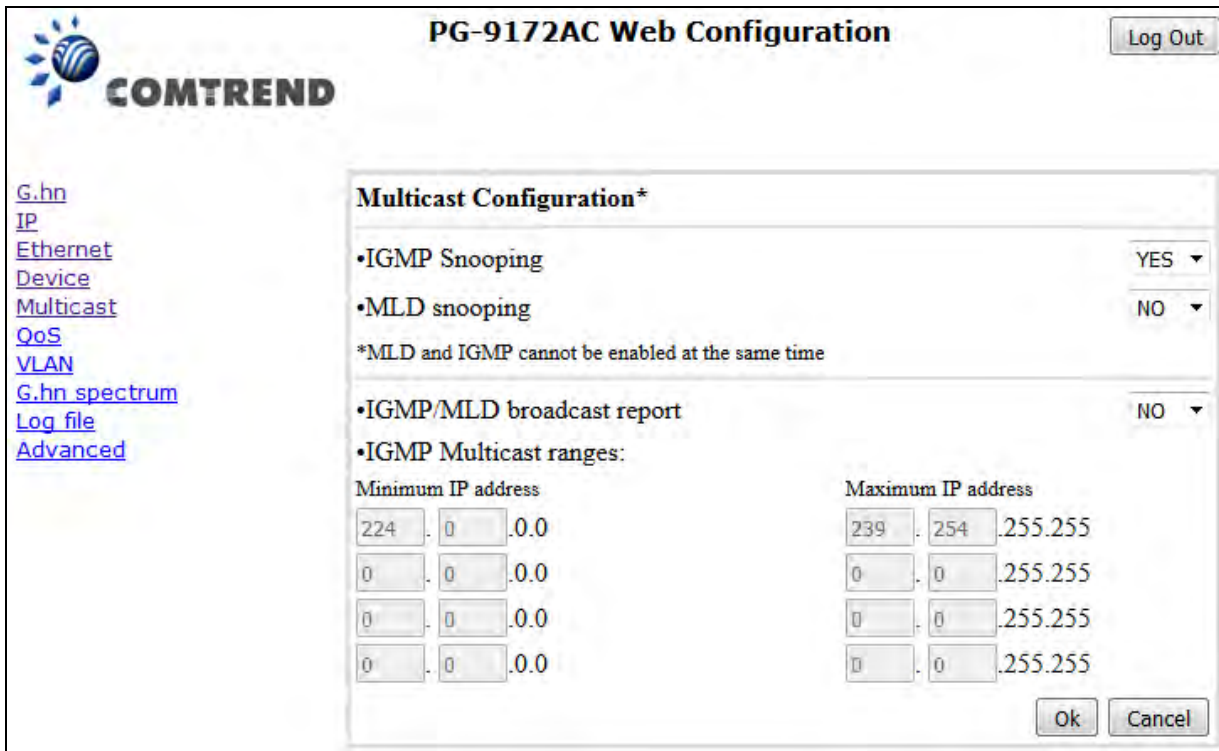

The screenshot shows the 'Multicast Configuration*' page in the PG-9172AC Web Configuration interface. The page includes a navigation menu on the left with links for G.hn, IP, Ethernet, Device, Multicast, QoS, VLAN, G.hn spectrum, Log file, and Advanced. The main configuration area contains the following settings:

- IGMP Snooping:** YES
- MLD snooping:** NO
- *MLD and IGMP cannot be enabled at the same time**
- IGMP/MLD broadcast report:** NO
- IGMP Multicast ranges:**

Minimum IP address				Maximum IP address			
224	.	0	.0.0	239	.	254	.255.255
0	.	0	.0.0	0	.	0	.255.255
0	.	0	.0.0	0	.	0	.255.255
0	.	0	.0.0	0	.	0	.255.255

Buttons for 'Ok' and 'Cancel' are located at the bottom right of the configuration area.

7.7.1 MCAST Configuration

In the **MCAST Configuration** tab of "My Network", **IGMP snooping** and **MLD** features can be enabled or disabled. Also, IGMP multicast IP addresses ranges which the G.hn PLC network will sniff; can be configured.

- **IGMP Snooping:** Enable or Disable.
- **MLD Snooping:** Enable or Disable.
- **IGMP/MLD broadcast report (allowed):** set to NO for enabling reports dropping until the video source is detected, this is a recommended setting when IGMP/MLD is enabled. Set to YES for broadcasting reports until the video source is detected; this implies the multicast video stream is sent as broadcast and it is the recommended state when IGMP/MLD is disabled.

IGMP Multicast ranges configuration: 4 multicast IP address ranges can be configured defining the minimum and maximum IP addresses of each range. Only multicast traffic within these ranges will be processed.

7.8 QoS menu



PG-9172AC Web Configuration

[G.hn](#)
[IP](#)
[Ethernet](#)
[Device](#)
[Multicast](#)
[QoS](#)
[VLAN](#)
[G.hn spectrum](#)
[Log file](#)
[Advanced](#)

QoS Configuration

QoS criterion Custom ▾

Type of frame Ethernet frame ▾

Packet detection 1 IPv4 ▾

Offset

Bitmask

Pattern

Packet detection 2 None ▾

Offset

Bitmask

Pattern

Packet classification

•Default prio 0 ▾

PC	Offset	Bitmask	Pattern	Priority
Rule 1	<input type="text" value="7"/>	<input type="text" value="0x00E0"/>	<input type="text" value="0x0000"/>	<input type="text" value="0 ▾"/>
Rule 2	<input type="text" value="7"/>	<input type="text" value="0x00E0"/>	<input type="text" value="0x0020"/>	<input type="text" value="1 ▾"/>
Rule 3	<input type="text" value="7"/>	<input type="text" value="0x00E0"/>	<input type="text" value="0x0040"/>	<input type="text" value="2 ▾"/>
Rule 4	<input type="text" value="7"/>	<input type="text" value="0x00E0"/>	<input type="text" value="0x0060"/>	<input type="text" value="3 ▾"/>
Rule 5	<input type="text" value="7"/>	<input type="text" value="0x00E0"/>	<input type="text" value="0x0080"/>	<input type="text" value="4 ▾"/>
Rule 6	<input type="text" value="7"/>	<input type="text" value="0x00E0"/>	<input type="text" value="0x00A0"/>	<input type="text" value="5 ▾"/>
Rule 7	<input type="text" value="7"/>	<input type="text" value="0x00E0"/>	<input type="text" value="0x00C0"/>	<input type="text" value="6 ▾"/>
Rule 8	<input type="text" value="7"/>	<input type="text" value="0x00E0"/>	<input type="text" value="0x00E0"/>	<input type="text" value="7 ▾"/>

7.8.1 QoS Configuration

In the **QoS** configuration tab, the packet classifier can be managed to define a QoS rule for incoming Ethernet traffic, and assign a priority to be used in the G.hn network. Press the "OK" button for loading the newly configured settings:

- **QoS CRITERION:** a general criterion can be chosen among "None" (no QoS), "Custom" and "802.1p".
- **Type of Frame:** with this parameter the type of Ethernet traffic being transmitted by the G.hn network should be selected. Based on this parameter, the internal offsets in the system are adjusted. In the QoS tab, Ethernet frame offsets should be set **counting number** as they appear in the sniffer SW (for instance, the same field will be in a different position if normal Ethernet frames or 802.1Q tagged frames exist).

- **Packet detection 1:** first packet detection rule can be configured (offset, bitmask and pattern). Packets which accomplish it will be sent to the classification module.
- **Packet detection 2:** if second packet detection is also enabled, both, first and second detection criteria must be accomplished to pass packets to the classification module.
- **Packet classification:** up to 8 classification rules can be defined in this section for packets which have previously been correctly detected. For 802.1p only priorities can be managed, offset, bitmask and pattern are predefined to sniff the PCP field.
- **Default priority:** select default priority; which will be applied to non classified incoming packets. Priority 7 is the highest. Priority 0 is the lowest.

Example



PG-9172AC Web Configuration

Log Out

[G.hn](#)
[IP](#)
[Ethernet](#)
[Device](#)
[Multicast](#)
[QoS](#)
[VLAN](#)
[G.hn spectrum](#)
[Log file](#)
[Advanced](#)

QoS Configuration

QoS criterion 802.1p ▾

Type of frame Ethernet frame ▾

Packet detection 1 None ▾

Offset

Bitmask

Pattern

Packet detection 2 None ▾

Offset

Bitmask

Pattern

Packet classification

•Default prio 0 ▾

PC	Offset	Bitmask	Pattern	Priority
Rule 1	<input type="text" value="0"/>	<input type="text" value="0x0000"/>	<input type="text" value="0x0000"/>	0 ▾
Rule 2	<input type="text" value="0"/>	<input type="text" value="0x0000"/>	<input type="text" value="0x0000"/>	1 ▾
Rule 3	<input type="text" value="0"/>	<input type="text" value="0x0000"/>	<input type="text" value="0x0000"/>	2 ▾
Rule 4	<input type="text" value="0"/>	<input type="text" value="0x0000"/>	<input type="text" value="0x0000"/>	3 ▾
Rule 5	<input type="text" value="0"/>	<input type="text" value="0x0000"/>	<input type="text" value="0x0000"/>	4 ▾
Rule 6	<input type="text" value="0"/>	<input type="text" value="0x0000"/>	<input type="text" value="0x0000"/>	5 ▾
Rule 7	<input type="text" value="0"/>	<input type="text" value="0x0000"/>	<input type="text" value="0x0000"/>	6 ▾
Rule 8	<input type="text" value="0"/>	<input type="text" value="0x0000"/>	<input type="text" value="0x0000"/>	7 ▾

Ok
Cancel

If QoS criterion: 802.1p, all other options are grayed out, and follow the QoS rules below. According to G.9960 specs, the priority mapping recommended by [IEEE 802.1D] subclause 7.7.3 is presented in Table III.1. for four priority queues.

PCP	Priority	Acronym	Traffic Types
1	0 (Third)	BK	Background
0	1 (lowest)	BE	Best Effort
2	2 (lowest)	EE	Excellent Effort
3	3 (Third)	CA	Critical Applications
4	4 (second)	VI	Video, < 100 ms latency and jitter
5	5 (second)	VO	Voice, < 10 ms latency and jitter
6	6 (highest)	IC	Internetwork Control
7	7 (highest)	NC	Network Control

In summary, the sequence of priority queue, (7,6) > (5,4) > (3,0) > (2,1)

7.9 VLAN Interface

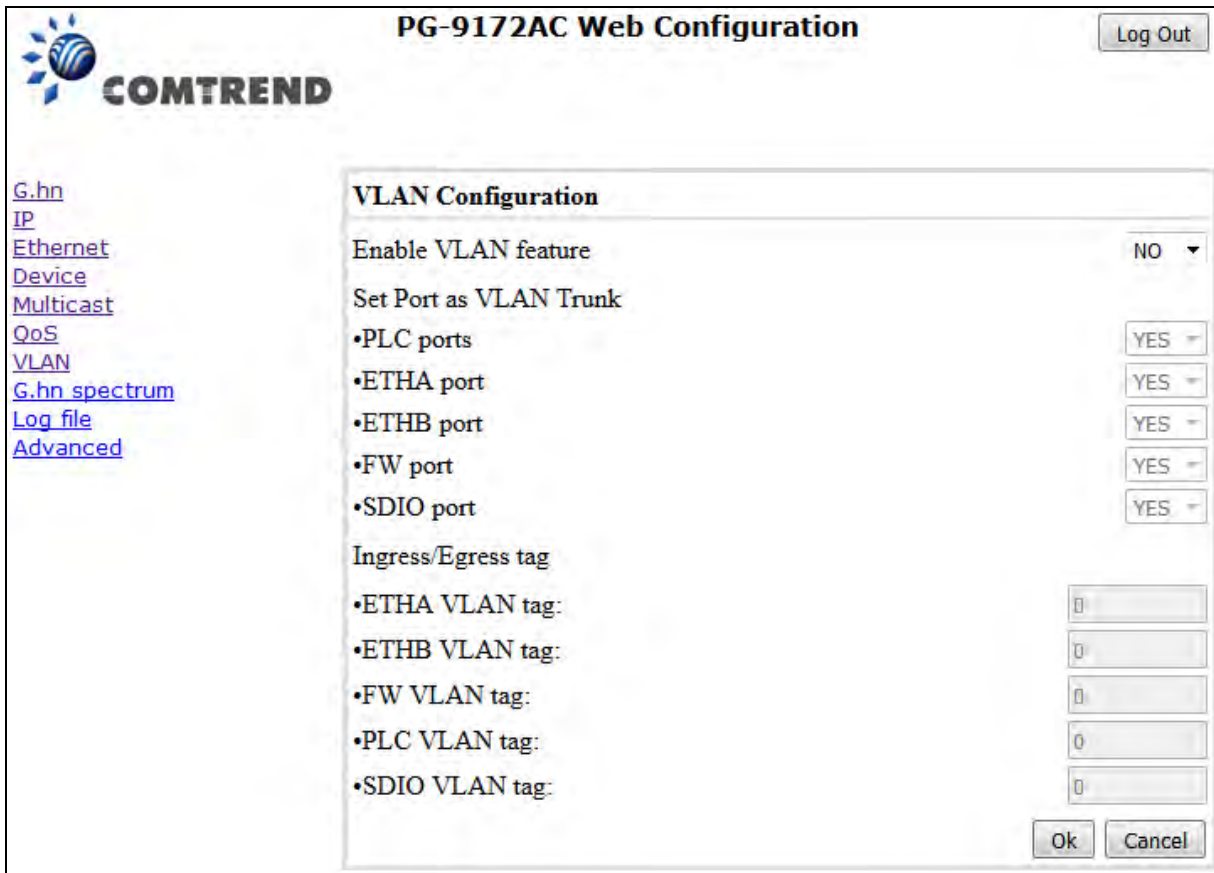

PG-9172AC Web Configuration Log Out

COMTREND

[G.hn](#)
[IP](#)
[Ethernet](#)
[Device](#)
[Multicast](#)
[QoS](#)
[VLAN](#)
[G.hn spectrum](#)
[Log file](#)
[Advanced](#)

VLAN Configuration

Enable VLAN feature NO ▾

Set Port as VLAN Trunk

- PLC ports YES ▾
- ETHA port YES ▾
- ETHB port YES ▾
- FW port YES ▾
- SDIO port YES ▾

Ingress/Egress tag

- ETHA VLAN tag:
- ETHB VLAN tag:
- FW VLAN tag:
- PLC VLAN tag:
- SDIO VLAN tag:

Ok Cancel

7.9.1 VLAN Configuration

In the **VLAN Configuration** tab of one G.hn node, a VLAN tag can be added or removed per interface. Also, removing a tag at egress per interface can be also enabled or disabled:

- **Enable VLAN Configuration:** Select **No** from the drop down menu to disable completely the VLAN functionality, removing all tags.
- **Set Port as VLAN Trunk:** Select **Yes** from the drop down menu for the ports that you want to set as VLAN Trunk ports.
- **Ingress/Egress tag:** A tag value (from 1 to 4095) per interface can be added in this section. Set value to 0 for no tagging.

7.10 G.hn spectrum Interface



PG-9172AC Web Configuration

[G.hn](#)
[IP](#)
[Ethernet](#)
[Device](#)
[Multicast](#)
[QoS](#)
[VLAN](#)
[G.hn spectrum](#)
[Log file](#)
[Advanced](#)

Notches Configuration

Notch index	Start freq (KHz)	Stop freq (KHz)	Depth (dB)	Type
0	1800	2000	100	Regulation
1	3500	4000	100	Regulation
2	7000	7300	100	Regulation
3	10100	10150	100	Regulation
4	14000	14350	100	Regulation
5	18068	18168	100	Regulation
6	21000	21450	100	Regulation
7	24890	24990	100	Regulation
8	28000	29700	100	Regulation
9	50000	54000	100	Regulation
10	0	1807	100	Regulation
11	80000	100000	100	Regulation
12	28000	30000	26	Regulation

Add new user notch

- Index (0..9)
- Start frequency (KHz)
- Stop frequency (KHz)
- Depth (0..40dB, 100 removes notch)

Remove user notch

- Index (0..9)

7.10.1 Notches

In this tab a table with all configured **Notches** of selected node will be shown. The table is composed of next columns for every notch: Notch Number, Type of notch, Start Frequency (KHz), Stop Frequency (KHz), Depth (in dB).

The first 13 notches (Regulation) are Read Only, **RO**, in the system and they can be neither removed nor modified. The next 40 notches (Vendor) are defined by the vendor using SDK and they are also RO. The last 10 notches (User) are R/W and they can be added/removed by user using this tool.

To add new notches the user should fill the "**Add a new User Notch**" fields, setting Start and Stop frequencies in KHz and depth in dB of notch and then press the "**Ok**" button. They will be added in first User free position from number 0 to 9. (If successful, you can see a record in the Type column)

To remove a User Notch, the "**Remove a User Notch**" section should be used, setting notch number to be removed from 0 to 9 and pressing the "**Ok**" button.

7.11 Log file Interface

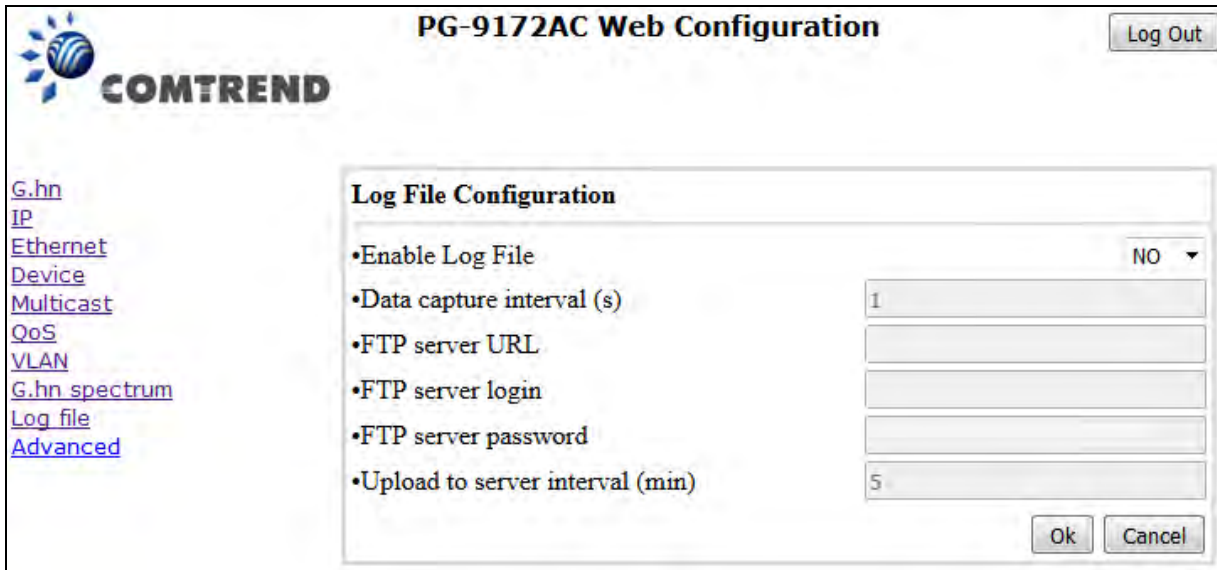

The screenshot shows the 'PG-9172AC Web Configuration' interface. On the left, there is a navigation menu with links: [G.hn](#), [IP](#), [Ethernet](#), [Device](#), [Multicast](#), [QoS](#), [VLAN](#), [G.hn spectrum](#), [Log file](#), and [Advanced](#). The main content area is titled 'Log File Configuration' and contains the following settings:

- Enable Log File: NO (dropdown menu)
- Data capture interval (s): 1 (text input)
- FTP server URL: (text input)
- FTP server login: (text input)
- FTP server password: (text input)
- Upload to server interval (min): 5 (text input)

At the bottom right of the configuration area, there are 'Ok' and 'Cancel' buttons. A 'Log Out' button is located in the top right corner of the main configuration window.

7.11.1 Log File

In the **Log File** configuration the following settings can be read, and changed by clicking on the corresponding "OK" button for the selected node:

- **Enable Log File** set to YES for enabling Log File functionality in the node and set to NO for disabling it.
- **Data Capture Interval** sets the interval of time in seconds to capture data.
- **FTP Server URL** configures the url for the remote FTP server where the files will be uploaded.
- **FTP Server Login** configures the user for the FTP server.
- **FTP Server Password** configures the password for the FTP server.
- **Upload to Server Interval** sets the interval of time in minutes to send the captured file to the remote server.

7.12 Advanced Interface

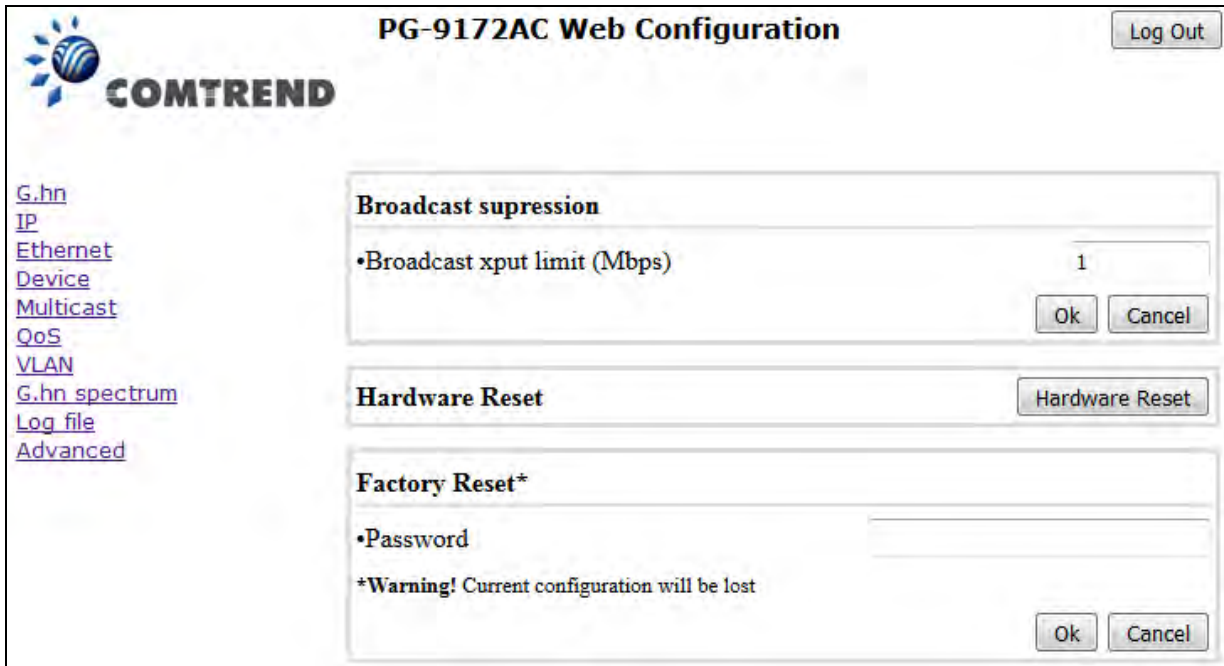

The screenshot displays the 'PG-9172AC Web Configuration' interface. At the top left is the COMTREND logo. A 'Log Out' button is in the top right. A left-hand navigation menu includes links for G.hn, IP, Ethernet, Device, Multicast, QoS, VLAN, G.hn spectrum, Log file, and Advanced. The main content area is divided into three sections: 1. 'Broadcast suppression' with a 'Broadcast xput limit (Mbps)' field set to '1' and 'Ok'/'Cancel' buttons. 2. 'Hardware Reset' with a 'Hardware Reset' button. 3. 'Factory Reset*' with a 'Password' field, a warning message '*Warning! Current configuration will be lost', and 'Ok'/'Cancel' buttons.

Broadcast suppression :In this tab the broadcast suppression feature can be managed. Broadcast traffic higher than the selected value will be dropped.

Hardware Reset: Click on this button to perform a reboot in the node.

Factory Reset: Input the password: **betera** and click the **OK** button to perform a factory reset. The current configuration will be lost.

Chapter 8 CLI commands for TR069 settings via Telnet

A system reboot is required for new settings.

- **ACS URL settings,**

```
nvrnram_set 2860 TR069URL [http://domain or IP/string]
```

For example:

```
nvrnram_set 2860 TR069URL http://220.128.128.235/cpe/?pd128
```

Display the current settings,

```
nvrnram_get 2860 TR069URL
```

- **ACS username,**

```
nvrnram_set 2860 TR069Username [username]
```

For Example:

```
nvrnram_set 2860 TR069Username comtrend
```

Display the current settings,

```
nvrnram_get 2860 TR069Username
```

- **ACS password,**

```
nvrnram_set 2860 TR069Password [password]
```

For example:

```
nvrnram_set 2860 TR069Password comtrend
```

Display the current settings,

```
nvrnram_get 2860 TR069Password
```

- **Periodic interval in seconds.**

```
nvrnram_set 2860 TR069InformInterval [seconds]
```

For example:

```
nvrnram_set 2860 TR069InformInterval 3600
```

Display the current settings,

```
nvrnram_get 2860 TR069InformInterval
```

FCC Statement:

Federal Communication Commission Interference Statement

This equipment has been tested and found to comply with the limits for a Class B digital device, pursuant to Part 15 of the FCC Rules. These limits are designed to provide reasonable protection against harmful interference in a residential installation. This equipment generates, uses and can radiate radio frequency energy and, if not installed and used in accordance with the instructions, may cause harmful interference to radio communications. However, there is no guarantee that interference will not occur in a particular installation. If this equipment does cause harmful interference to radio or television reception, which can be determined by turning the equipment off and on, the user is encouraged to try to correct the interference by one of the following measures:

- Reorient or relocate the receiving antenna.
- Increase the separation between the equipment and receiver.
- Connect the equipment into an outlet on a circuit different from that to which the receiver is connected.
- Consult the dealer or an experienced radio/TV technician for help.

FCC Caution: Any changes or modifications not expressly approved by the party responsible for compliance could void the user's authority to operate this equipment.

This device complies with Part 15 of the FCC Rules. Operation is subject to the following two conditions: (1) This device may not cause harmful interference, and (2) this device must accept any interference received, including interference that may cause undesired operation.

This device is restricted for indoor use.

For product available in the USA/Canada market, only channel 1~11 can be operated. Selection of other channels is not possible.

IMPORTANT NOTE:

FCC Radiation Exposure Statement:

This equipment complies with FCC radiation exposure limits set forth for an uncontrolled environment. This equipment should be installed and operated with minimum distance 20cm between the radiator & your body.

IC Statement:

This device complies with Industry Canada license-exempt RSS standard(s). Operation is subject to the following two conditions: (1) this device may not cause interference, and (2) this device must accept any interference, including interference that may cause undesired operation of the device.

Le présent appareil conforme aux CNR d'Industrie Canada applicables aux appareils radio exempts de licence. L'exploitation est autorisée aux deux conditions suivantes : (1) l'appareil ne doit pas produire de brouillage, et (2) l'utilisateur de l'appareil doit accepter tout brouillage radioélectrique subi, même si le brouillage est susceptible d'en compromettre le fonctionnement.

For product available in the USA/Canada market, only channel 1~11 can be operated. Selection of other channels is not possible.

Pour les produits disponibles aux États-Unis / Canada du marché, seul le canal 1 à 11 peuvent être exploités. Sélection d'autres canaux n'est pas possible.

This radio transmitter (4013A-PG9172AC) has been approved by Industry Canada to operate with the antenna types listed below with the maximum permissible gain indicated. Antenna types not included in this list, having a gain greater than the maximum gain indicated for that type, are strictly prohibited for use with this device.

Le présent émetteur radio (4013A-PG9172AC) a été approuvé par Industrie Canada pour fonctionner avec les types d'antenne énumérés ci-dessous et ayant un gain admissible maximal d'antenne. Les types d'antenne non inclus dans cette liste, ou dont le gain est supérieur au gain maximal indiqué, sont strictement interdits pour l'exploitation de l'émetteur.

Ant.	Brand Holder	Model Name	Antenna Type	Connector	Gain (dBi)	
					2.4GHz	5GHz
1	Master Wave Technology Co., Ltd.	502219-293	Dipole Antenna	I-PEX	2.41	3.80
2	Master Wave Technology Co., Ltd.	502219-292	Dipole Antenna	I-PEX	2.31	3.62

The device for operation in the band 5150–5250 MHz is only for indoor use to reduce the potential for harmful interference to co-channel mobile satellite systems.

les dispositifs fonctionnant dans la bande 5150-5250 MHz sont réservés uniquement pour une utilisation à l'intérieur afin de réduire les risques de brouillage préjudiciable aux systèmes de satellites mobiles utilisant les mêmes canaux.

The maximum antenna gain permitted for devices in the band 5725-5850 MHz shall be such that the equipment still complies with the e.i.r.p. limits specified for point-to-point and non-point-to-point operation as appropriate.

le gain maximal d'antenne permis (pour les dispositifs utilisant la bande 5725-5850 MHz) doit se conformer à la limite de p.i.r.e. spécifiée pour l'exploitation point à point et non point à point, selon le cas.

IMPORTANT NOTE:

IC Radiation Exposure Statement:

This equipment complies with IC RSS-102 radiation exposure limits set forth for an uncontrolled environment. This equipment should be installed and operated with minimum distance 20cm between the radiator & your body.

Cet équipement est conforme aux limites d'exposition aux rayonnements IC établies pour un environnement non contrôlé. Cet équipement doit être installé et utilisé avec un minimum de 20 cm de distance entre la source de rayonnement et votre corps.