

Functional description User Manual

5WY7703



FORD PATS Clip-On

Homologation Support Documents

SV C BC P2 RF_LF
RF Engineer



1. Functional Description

The transceiver module is a component of the Ford Passive Anti -Theft System (PATS). The transceivers interface directly with the vehicle's Powertrain Control Module (PCM) or can be used with other devices, such as an instrument cluster or other control function. In this specification, the term " **PATS Module**" is used to describe any of these devices.

The Ford PATS Clip_On transceiver is similar to the Ford PATS P207 manufactured by Siemens. The Ford PATS Clip_On transceiver is the interface between the transponder inside the key and the PATS control module (PCM or other unit).

When the vehicle's ignition is started the PATS module signals the transceiver to energize the transponder inside the key head. The transponder conforms to the Texas Instruments (TIRIS) protocol. The transceiver amplifies a 134.2KHz signal that is coupled from the transceiver's antenna to the transponder's coil which charges the transponder. After charging, the transceiver sends a 40 bit random number to the transponder. The data written into the transponder is encoded in a pulse width modulated (PWM) format and modulated in an ASK format at the desired frequency. The transceiver modulates the PWM data sent by the Powertrain Control Module on the TX input. The transceiver modulates the data on the TX input only while the TX input is active. The transceiver does not send any signal while the TX input is inactive. The transponder discriminates between the off times of the transceiver's PWM encoded, ASK modulated signal to distinguish low bits and high bits. During the on -times the transceiver is restoring energy to the transponder.

The transceiver also receives the signal transmitted by a transponder. The transceiver will demodulate the transponder's FSK signal and transmit it to the PATS module over an asynchronous serial communication interface (SCI). The SCI protocol is one start bit, one stop bit and no parity at 15.625 Kbaud with the Most Significant Byte first and the Least Significant Bit of each Byte first. The SCI (and transponder) message includes a start byte, eight data bytes, two block check character bytes, a stop byte and two end bytes. The value of the Start Byte is either 7E or FE hexadecimal. The value of the Stop Byte is either 7E or FE hexadecimal. The value of both the End Bytes is 00 hexadecimal.

The transceiver also has limited diagnostic capability. After the transceiver has begun charging the transponder, the transceiver will send a diagnostic byte to the PATS module over the SCI.

SV C BC_P2_RF_LF
RF Engineer



2. Module Housing

The module assembly contains a bobbin assembly, a printed circuit board assembly, and a top cover. The bobbin assembly and top cover are a glass filled nylon material, PBT -GF20. A four-pin connector and antenna ring are injection molded into the bobbin assembly. The PCB is 1 Oz. Copper, double sided, all SMD components will be affixed to the PCB by a double -sided IR reflow process. The PCB will mount to the housing via six press fit pins. The wire antenna is connected to the PCB by two of the six press fit pins. The top cover attaches to the bobbin assembly with four snaps and helps protect the wire antenna and PCB.

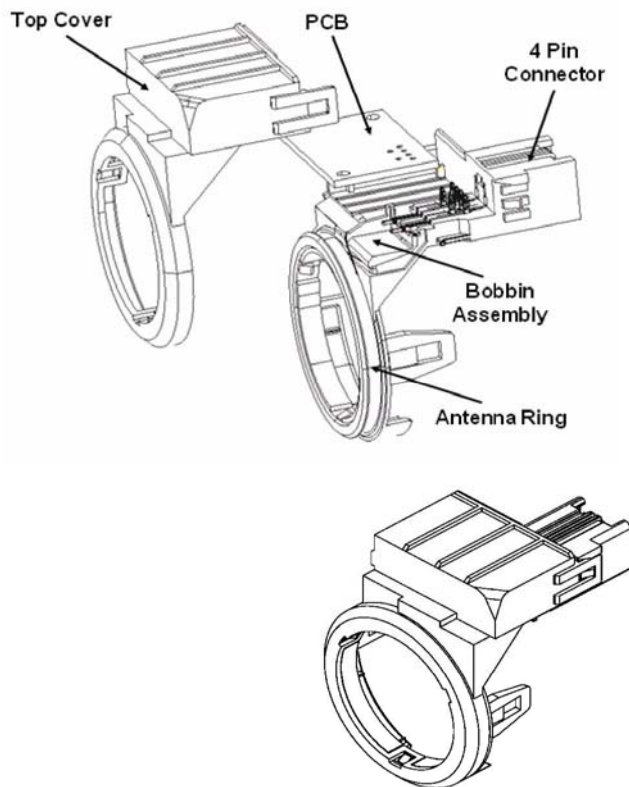

SV C BC_P2_RF_LF
RF Engineer



4. Interface Requirements

4.1 PATS Clip_On Connector

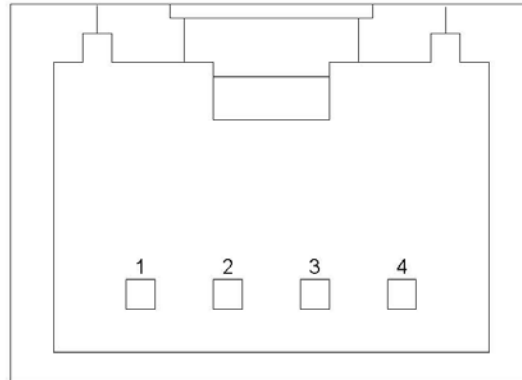

Mechanical Connector

Front View Looking Into Connector

Pin #	Pin Description	Steady State Current (Key Off)	Steady State Current (Key Run/Start)	Operating Voltage	Frequency or /MIN BIT Width	% Duty
1	Ignition	0 mA	50 mA	VBatt	DC	DC
2	Ground	0.015 mA	50 mA	0v	DC	DC
3	TX	0 mA	12 mA for 50 ms	0 – VBatt	64 μ s	VAR.
4	RX (SCI-out)	0 mA	12 mA < 1 sec.	0 – VBatt	15.625kbaud	VAR.

Table 1 Pin Description

SV C BC_P2_RF_LF
RF Engineer



4.2 Terminal Definitions and Characteristics

All inputs and outputs shall be capable to withstand any single point failure of a short to battery or ground, through any resistive path, without physical damage to the component while the fault is occurring, and any physical damage and/or functional degradation once the fault is removed.

4.2.1 PATS Clip_On Permanent Battery and Ground Connections

Signal Name	Signal Function	Electrical Characteristics
Ignition	Power to the module	Min Operating Voltage: 7 V Max Operating Voltage: 24 V I_{nom} @12.0 V: 32mA
Ground	Ground to the module	I_{nom} @ 12.0 V: 32mA

Table 2 Battery and Ground Connection Ratings

4.2.2 PATS Clip_On Input

All digital inputs shall meet the applicable Generic Body Module SDS requirements unless otherwise agreed to by Ford Motor Company

Signal ID	Functional Name	Active (On) State	Inactive (Off) State	Min Logical High Threshold	Max. Logical Low Threshold
Tx Input	Transmit Data	Low	High (1KOhm pull up resistor)	3.97 V	3.04V

Table 3 Tx Input

¹ The given limits include a maximum GND voltage shift between SJB Logic GND and switch GND of ± 1 V.



4.2.3 PATS Clip_On Output

Signal ID	Type of Output/ Driver	Minimum functional voltage	Maximum functional voltage	Minimum performance voltage	Maximum performance voltage	Output short circuit protection
Rx Output	Low Side Driver	7V	24V	7V	24V	Provided

Table 4 Rx Output

Characteristics:

- Short circuit to ground and overload protections are provided
- Maximum Low output voltage: 0.58V
- Operating Current at Nominal Voltage (12.0V)= 12mA
- Nominal Frequency= 15.625KHz
- Minimum/Maximum Frequency= 14.843KHz/16.407KHz

4.2.4 Serial Communication

The transceiver is to communicate transponder data to the Control function using a 15.625 kHz +/- 5% serial communications interface signal. The signal is to be in standard UART format with one start bit and one stop bit, and no parity. The signal exiting the transceiver module shall be asserted low (ground).

The serial communication will exactly mirror the transponder receive signal, except for the addition of diagnostic bytes and start and stop bits. This means that a transponder "1" signal, as specified by the appropriate transponder ES, will correspond to a UART "1" signal.

5. Label

Siemens VDO
5WY7703
FCC ID:KR55WY7703

Note Owner Manual:

This device complies with Part 15 of the FCC Rules. Operation is subject to the following two conditions:

- (1) This device may not cause harmful interference, and
- (2) this device must accept any interference received, including interference that may cause undesired operation.

Caution:

Any changes or modifications not expressly approved by the party responsible for compliance could void the user's authority to operate this equipment.

SV C BC_P2_RF_LF
RF Engineer

Using the FORD CRYPTOGRAPHIC TRANSCEIVER TEST BOX and NUTI Software

Before starting the program please connect the following items shown below.

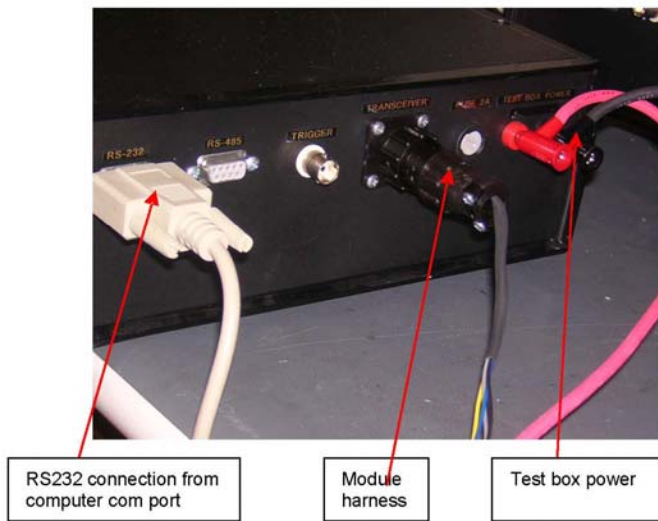

Transmit control line: NORMAL is for normal communication and ON turns the antenna output continuously.

Test box power switch



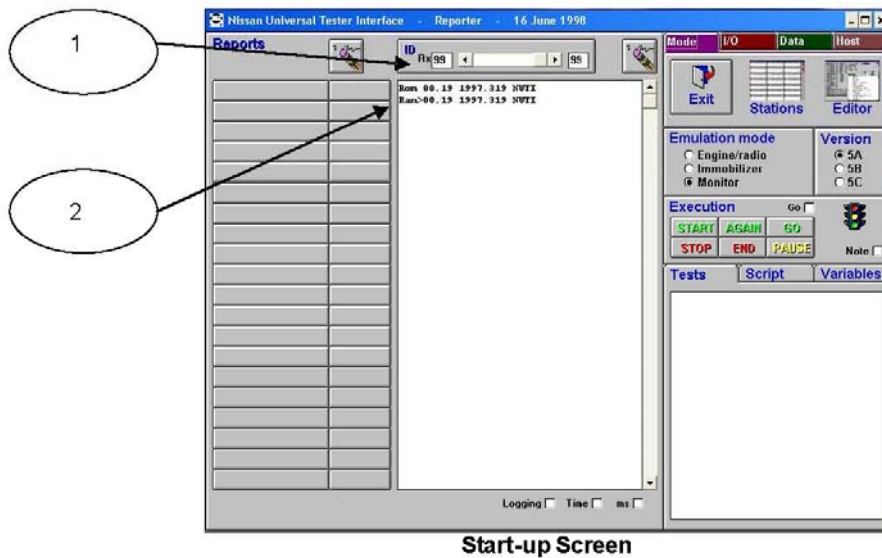

Start-up Screen

1. Click the "Nissan" icon on the computer desktop.
2. The above Start-up screen should appear and a "99" (1) should be in the ID RX box.
3. In the main screen a ROM and RAM message (2) should appear.

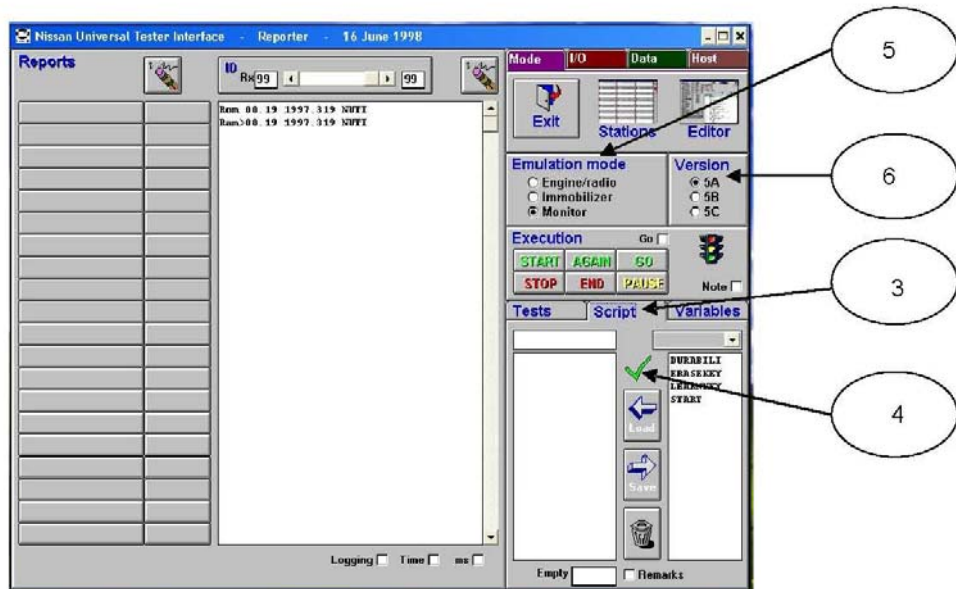

Loading the Scripts 1

4. Press the Script Tab (3) to display the Script to be used. They should be located in Emulation mode (5) "Monitor" Version (6) "5A". To check if the scripts are already loaded click Check Mark (4).

- If the scripts are in E² they will appear in the box (7). If the scripts do not appear in the window they will have to be loaded. To do that select all the scripts by selecting the first one and drag the cursor down to select them all (8). Press load button(9) and the scripts will appear in the box (7).

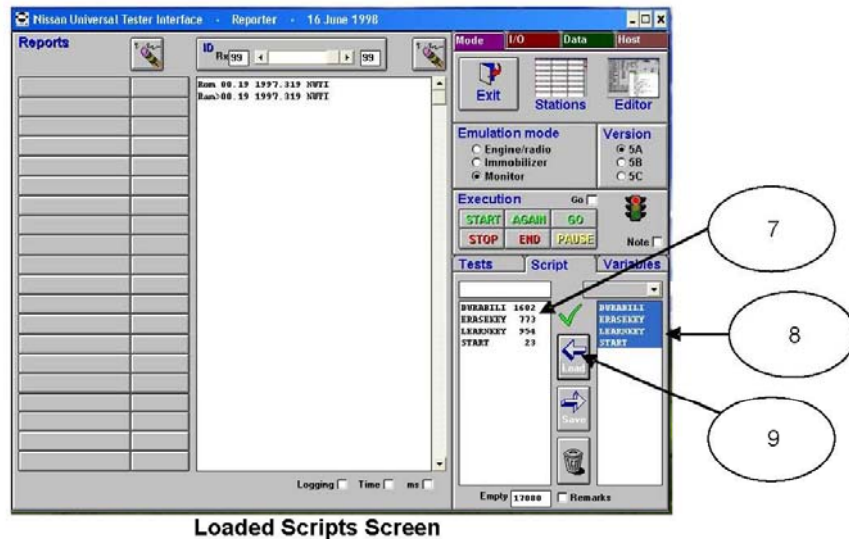

Loaded Scripts Screen

- To Run the Script select "Start script" (10) and it should load in the box (11). To run the script press the **START** Button (12).

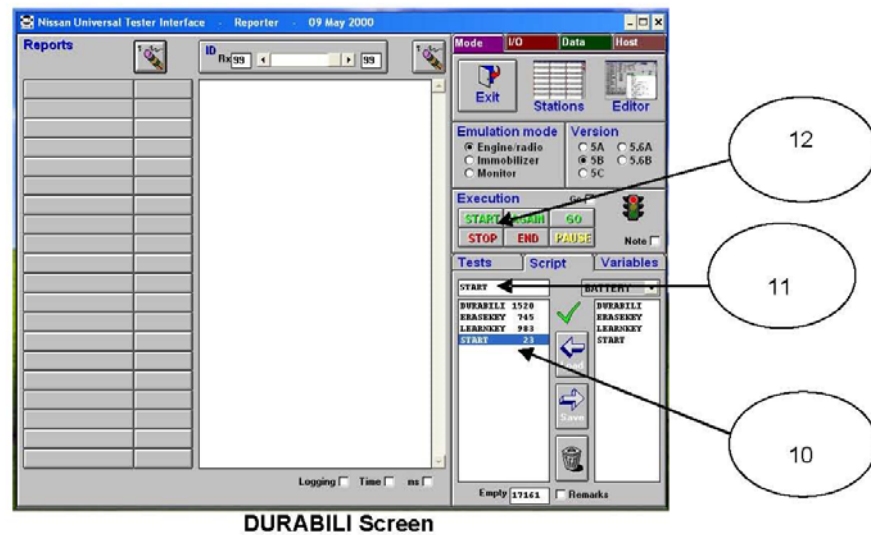

DURABILI Screen

7. On the left of the screen a list of possible error codes will be displayed. The IGN CYC is the count of how many ignition cycles have occurred (13) and TPOK is how many successful communications have occurred between the module and the transponder. If there are any problems one of the error messages will turn red and record a failure. The module will keep cycling until the stop button (14) is pressed.

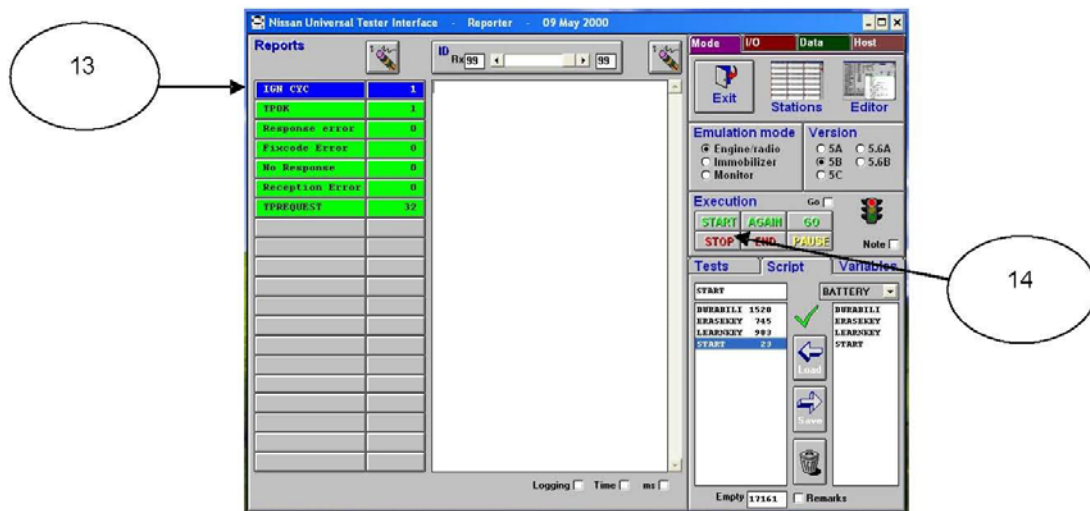

8. To set the module into constant transmit mode click the 5AB tab (15) and make sure that BAT and IGN are both lighted(16). If they are not lighted click on the boxes (17) to turn them on. **Note: Make sure that the module is not cycling when trying to setup this test.** Now turn the Transmit control line from NORMAL to ON to turn the antenna output continuously.

