

SUMMARY

INTRODUCTION	275	TRACK FAST FORWARD/REWIND	292
TIPS, CONTROLS AND GENERAL INFORMATION	276	TRACK SELECTION (Browse).....	292
TIPS	276	AUDIO SOURCE SELECTION.....	293
MULTIMEDIA DEVICES: SUPPORTED AUDIO FILES AND FORMATS.....	278	TRACK INFORMATION DISPLAY	293
NOTES ON TRADEMARKS.....	279	RANDOM TRACK REPRODUCTION	293
EXTERNAL AUDIO SOURCES.....	279	TRACK REPETITION.....	293
TECHNICAL SPECIFICATIONS.....	280	CD PLAYER	294
QUICK GUIDE.....	281	LOADING/EJECTING A CD	294
CONTROLS ON FRONT PANEL	281	Bluetooth ® SOURCE	295
FRONT PANEL CONTROL SUMMARY TABLE.....	282	PAIRING A Bluetooth ® AUDIO DEVICE	295
STEERING WHEEL CONTROLS	283	USB/iPod SUPPORT	296
DESCRIPTION	283	AUX SUPPORT.....	296
STEERING WHEEL CONTROL SUMMARY TABLE	284	PHONE MODE	297
SWITCHING THE SYSTEM ON/OFF	285	PHONE MODE ACTIVATION	297
RADIO (TUNER) MODE.....	285	MAIN FUNCTIONS	297
RADIO MODE SELECTION	285	DISPLAYED INFORMATION	298
FREQUENCY BAND SELECTION.....	285	PAIRING A MOBILE PHONE.....	298
DISPLAYED INFORMATION	286	STORING NAMES/NUMBERS IN THE MOBILE PHONE PHONEBOOK	300
RADIO STATION SELECTION.....	286	CONNECTION/DISCONNECTION OF A MOBILE PHONE OR A Bluetooth ® AUDIO DEVICE	300
PREVIOUS/NEXT RADIO STATION SEARCH	287	DELETION OF A MOBILE PHONE OR A Bluetooth ® AUDIO DEVICE	301
PREVIOUS/NEXT RADIO STATION FAST SEARCH	287	SETTING A MOBILE PHONE OR A Bluetooth ® AUDIO DEVICE AS FAVOURITE	302
AM/FM RADIO STATION TUNING	287	DELETION OF PHONE DATA (PHONEBOOK AND RECENT CALLS)	302
DAB RADIO	288		
SETTING THE PRESELECTIONS	289		
AUDIO	289		
MEDIA MODE	292		
TRACK CHANGE (previous/next).....	292		

TRANSMISSION OF PHONE DATA (PHONEBOOK AND RECENT CALLS)	302	CLOCK	309
MAKING A PHONE CALL.....	303	eco:Drive	309
MANAGING AN INCOMING CALL	304	SETTINGS	311
MAKING A SECOND PHONE CALL.....	306	VOICE COMMANDS	315
MANAGING TWO PHONE CALLS.....	306	USE OF THE VOICE COMMANDS.....	315
ENDING A CALL.....	307	USE OF STEERING WHEEL CONTROLS TO ACTIVATE VOICE COMMANDS.....	315
REDIALLING	307	VOICE SESSION STATUS.....	316
CONTINUING A PHONE CALL.....	307	MULTIPLE CHOICE.....	316
ACTIVATION/DEACTIVATION OF THE MICROPHONE.....	307	GLOBAL VOICE COMMANDS.....	317
TRANSFERRING A CALL.....	308	PHONE VOICE COMMANDS.....	318
SMS MESSAGE READER.....	308	RADIO AM/FM/DAB VOICE COMMANDS	322
"MORE" MODE.....	308	MEDIA VOICE COMMANDS.....	324
TRIP COMPUTER.....	309	CUSTOMER SERVICE NUMBER LIST	327

INTRODUCTION

The car is equipped with an infotematic system designed according to the specific characteristics of the passenger compartment, with a customised design that matches the style of dashboard.

The system is installed in an ergonomic position for the driver and passenger, and controls can be quickly located from the graphical display on the front, making the device easy to use.

To increase protection against theft, the system has a protection system that only allows it to be used on the vehicle in which it was originally fitted.

The instructions for use are given below and we recommend you read them carefully and always keep them to hand (for example, in the glove compartment).

Enjoy reading. Happy motoring!

The information in this publication is provided by way of example. Fiat Group Automobiles S.p.A. can modify the specifications of the vehicle model described in this publication at any time, for technical or marketing purposes. For further information, contact a Fiat Dealership.



TIPS, CONTROLS AND GENERAL INFORMATION

TIPS

Road safety

Learn how to use the various system functions before setting off.

Read the instructions for the system carefully before setting off.



WARNING

If the volume is too loud this can be dangerous. Adjust the volume so that you can still hear background noises (e.g. horns, ambulances, police vehicles, etc.).

Reception conditions

Reception conditions change constantly while driving. Reception may be interfered with by the presence of mountains, buildings or bridges, or when you are far away from the broadcaster.

IMPORTANT The volume may be increased when receiving traffic alerts and news.

Care and maintenance

Observe the following precautions to ensure the system is fully operational:

- the display is sensitive to scratching, liquids and detergents. The display should not come into contact with pointed or rigid objects which could damage its surface. Do not press on the display when cleaning it.
- prevent any liquid from entering the system: this could be damaged beyond repair.



Only clean the front panel and the display with a soft, clean, dry, anti-static cloth. Cleaning and polishing products may damage the surface. Do not use alcohol or similar products to clean the panel or the display.

Important

In the event of a failure, the system should only be checked and repaired at a Fiat Dealership.

If the temperature is particularly low, the display may take a while to reach optimum brightness.

If the car is stopped for a while and the outside temperature is very high, the system may go into “thermal protection” mode, suspending operation until the temperature in the passenger compartment returns to acceptable levels.

CD

Dirt, scratches or any distortions on CDs may cause skipping during playback and poor sound quality. Follow these tips for optimum playback conditions:

- only use CDs with the following mark:



- clean every CD thoroughly removing any fingerprints or dust using a soft cloth. Hold CDs by the circumference and clean them from the centre towards the edge;

- never use chemical products (e.g. antistatic, thinner or spray cans) for cleaning as they could damage the surface of the CDs;
- after listening to them place CDs back in their cases to avoid them being damaged;
- do not expose CDs to direct sunlight, high temperatures or moisture for long periods;
- do not stick labels on the surface of the CD and do not write on the recorded surface using pens or pencils;
- never use CDs that are very scratched, cracked, deformed, etc. Their use could cause damage the player or make it malfunction.

To achieve the best quality audio reproduction we recommend the use of original CD supports. Correct operation is not guaranteed when CD-R/RW media are used that were not correctly burnt and/or with a maximum capacity above 650 Mb.

IMPORTANT Do not use commercially available protective sheets for CDs or discs with stabilisers as they could get stuck in the internal mechanism and damage the disc.

IMPORTANT If a copy-protected CD is used, it may take a few seconds before the system starts to play it. The CD player cannot be guaranteed to play all protected discs. The presence of copy protection is often in small letters or may be difficult to read on the cover of the actual CD and it may say something like, for example, "COPY CONTROL", "COPY PROTECTED", "THIS CD CANNOT BE PLAYED ON A PC/MAC" or identified through the use of symbols, such as, for example:



IMPORTANT If a multisession disc is loaded, only the first session will be played.

MULTIMEDIA DEVICES: SUPPORTED AUDIO FILES AND FORMATS

For CD, USB and iPod sources the system can play files with the following extensions and formats:

- .MP3 (32 – 320Kbps);
- .WAV;
- .WMA (5 – 320Kbps) mono and stereo;
- .AAC (8 – 96KHz) mono and stereo;
- .M4A (8 – 96KHz) mono and stereo;
- .M4B (8 – 96KHz) mono and stereo;
- .MP4 (8 – 96KHz) mono and stereo.

For all sources (CD, AUX, iPod and **Bluetooth**®), the system can also play the following Playlist formats:

- .M3U
- .PLS
- .WPL

NOTE It makes no difference whether the suffixes are written in capital or small letters.

NOTES ON TRADEMARKS

iPod, iTunes and iPhone are registered trademarks of Apple Inc.

All other trademarks are the property of their respective owners.



Apple is not responsible for the operation of this device and of its conformity with the safety rules and standards.



The DAB/DAB+/DMB Digital Radio function has been certified according to the specifications of "ARD" white sticker, for Class A - Audio services. ARD is a trademark of the Associazione per la Radiofonia Digitale in Italia.

EXTERNAL AUDIO SOURCES

Other electronic devices (e.g. iPod, PDA, etc...) can be used on the car.

Some of them can however cause electromagnetic interference. Disconnect these devices if the system performance worsens.

NOTE The system supports only FAT32-formatted USB devices. The system does not support devices with a capacity higher than 64 Gb.

TECHNICAL SPECIFICATIONS

Speakers for basic specification

Front speakers

- 2 Ø 38 mm tweeters on the door handle;
- 2 Ø 165 mm mid-woofer speakers in the door panel.

Rear speakers

- 2 Ø 165 mm full-range speakers in the door panel.

Hi-Fi specification speakers (for versions/markets, where provided)

Front speakers

- 2 Ø 38 mm tweeters on the door handle;
- 2 Ø 165 mm mid-woofer speakers in the door panel.

Rear speakers

- 2 Ø 165 mm full-range speakers in the door panel;
- 1 8-channel amplifier in the luggage compartment;
- 1 subwoofer box in the luggage compartment (position varies according to the versions).

QUICK GUIDE

CONTROLS ON FRONT PANEL







fig. 1

F0Y0001



FRONT PANEL CONTROL SUMMARY TABLE

Button	Functions	Mode
1 - 	Ignition	Brief button press
	Off	Brief button press
	Volume adjustment	Left/right rotation of knob
2 - 	Volume activation/deactivation (Mute/Pause)	Brief button press
3 - 	CD ejection	Brief button press
4	CD housing	–
5 - 	Display on/off	Brief button press
6 - 	Exit the selection/return to previous screen	Brief button press
7 - BROWSE ENTER	Scrolling the list or tuning to a radio station	Left/right rotation of knob
	Confirmation of the option displayed	Brief button press
8 - MORE	Accessing the addition functions (displaying of Time, Trip Computer, eco:Drive function data)	Brief button press
9 - PHONE	Phone data displaying	Brief button press
10 - SETTINGS	Accessing the Vehicle Settings menu	Brief button press
11 - MEDIA	Source selection: CD, USB/iPod, AUX or Bluetooth ®	Brief button press
12 - RADIO	Accessing the Radio mode	Brief button press

STEERING WHEEL CONTROLS (for versions/markets, where provided)

DESCRIPTION

The controls for the main system functions are present on the steering wheel to make things easier.

The activation of the function selected is controlled, in some cases, by how long the button is pressed (short or long press) as described in the table below.

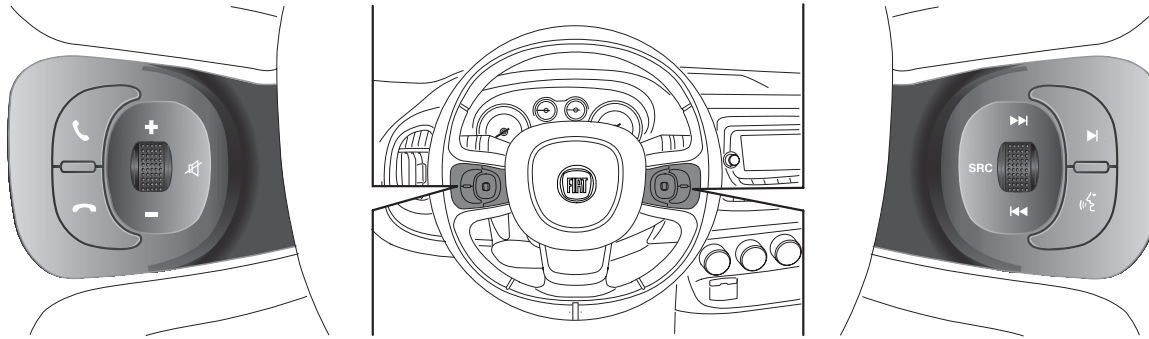







fig. 2

F0Y0002

Uconnect

STEERING WHEEL CONTROL SUMMARY TABLE

Button	Interaction (pressure/rotation)
	<ul style="list-style-type: none"> - Acceptance of incoming call - Acceptance of the second incoming phone call and putting the active phone call on hold - Activation of voice recognition for Phone function - Interruption of the voice message in order to give a new voice command - Interruption of voice recognition
	<ul style="list-style-type: none"> - Rejection of incoming call - Ending of call in progress
	Pressing the centre of the left wheel: <ul style="list-style-type: none"> - deactivation/reactivation of the microphone during a phone conversation - activation/deactivation of the CD, USB/iPod, Bluetooth® source Pause - activation/deactivation of radio Mute function
+/-	Turning left wheel upwards or downwards: <ul style="list-style-type: none"> - adjustment of the audio volume: hands-free, SMS message reader, voice announcements and music sources
	<ul style="list-style-type: none"> - Scrolling the stored radio stations (preset)
	<ul style="list-style-type: none"> - Activation of voice recognition - Interruption of the voice message in order to give a new voice command - Interruption of voice recognition
	Turning right wheel upwards or downwards: <ul style="list-style-type: none"> - Radio Mode: selection of previous/next radio station - CD, USB/iPod, Bluetooth® mode: selection of previous/next track
SRC	Pressing the centre of the right wheel: <ul style="list-style-type: none"> - selection of audio sources available: radio, CD, USB/iPod, AUX and Bluetooth®

SWITCHING THE SYSTEM ON/OFF

RADIO (TUNER) MODE

The system switches on/off when the button/knob  (ON/OFF) is pressed (1-fig. 1).

The electronic volume adjustment control rotates continuously (360°) in both directions without stop positions.

Turn the button/knob clockwise to increase the radio volume or counterclockwise to decrease it.

The system has the following tuners: AM, FM and DAB (for versions/markets, where provided).

RADIO MODE SELECTION

Press the RADIO button (12-fig. 1) on the front panel to activate the radio mode.

The different tuning modes can be selected with the corresponding button on the display (see fig. 4).

Each tuning mode can have a specific preselection set.

FREQUENCY BAND SELECTION

Briefly press the "AM/FM" button to switch from AM to FM and vice versa.

If the DAB tuner is available, briefly press the "AM/FM", "AM/DAB", "FM/DAB" buttons to select the desired band.



fig. 3

F0Y1030

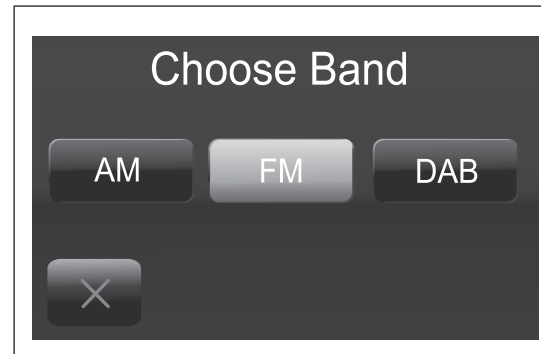

fig. 4

F0Y1001

DISPLAYED INFORMATION

After the desired radio station is selected on the display (see fig. 5), the following information is shown:

At the top: the list of radio stations stored (preset) is displayed; the station being listened to is highlighted.

In the middle: the name of the radio station being listened to and the buttons to select the previous or the next radio station are displayed.

At the bottom: the following buttons are displayed:

- "Browse": list of the radio stations available;
- "AM/FM", "AM/DAB", "FM/DAB": selection of the desired frequency band (button reconfigurable according to the band selected: AM,FM or DAB);
- "Tune" : manual radio station tuning (not available for DAB radios);
- "Info": additional information on the source being listened to;
- "Audio": access to the "Audio setting" screen.

RADIO STATION SELECTION

To search for the desired radio station press buttons **◀◀** or **▶▶** on the display or use the steering wheel controls.



fig. 5

F0Y1000

PREVIOUS/NEXT RADIO STATION SEARCH

Briefly press buttons **◀◀** or **▶▶** on the display: when the button is released the previous or the next radio station is displayed.

When searching forwards, if the system reaches the end of the band, it will automatically stop on the station where the search has started from.

PREVIOUS/NEXT RADIO STATION FAST SEARCH

Hold down buttons **◀◀** or **▶▶** on the display to start the fast search: when the button is released, the first tunable radio station can be heard.

AM/FM RADIO STATION TUNING

Use the "Tune" button to select a radio station.

Press the "Tune" button on the display then select the first number of the desired radio station (see fig. 6).

The graphic keyboard on the display is used to enter the number of the station.

In this mode, use buttons **+** and **-** to fine-tune the frequency.

Press button **⌫** (Delete) to delete a wrong number (and enter the correct station number).

After entering the last digit of the station, the "Tune" screen is deactivated and the system tunes automatically to the station selected (the number of the radio station is displayed in the "Tune" text box).

The screen disappears automatically after 5 seconds or manually by pressing the "OK" or **⌫** (Delete) buttons.

Incomplete radio station selection ("OK")

Press the "OK" button on the display to tune to the radio station selected and close the "Direct Tune" screen (manual tuning).

Exit the "Direct Tune" screen

Press the "Exit" or the "Radio" button on the display to return to the system main screen.



fig. 6

FOY1007

DAB RADIO

(for versions/markets, where provided)

Once the DAB radio mode on the display is selected, the information on the station being listened to is displayed (see fig. 7) and the following modes will be available:



fig. 7

F0Y1020

Selection of the previous/next radio station by:

- rotating the BROWSE ENTER button/knob (7-fig. 1);
- briefly pressing the |◀◀ or ▶▶| buttons on the display;
- pressing the |◀◀ or ▶▶| controls on the steering wheel.

Hold down the |◀◀ or ▶▶| buttons to fast scroll the station list.

The "Browse" button is used to display:

- the list of all DAB stations;
- the list of stations filtered by "Genres";
- the list of stations filtered by "Ensembles" (broadcast group).

Use the "ABC" button inside each list to skip to the desired letter.

The "Refresh" button requires the DAB radio station list to be updated: the update can take a few seconds up to about two minutes.

SETTING THE PRESELECTIONS

Preselections are available in all system modes and are activated by touching one of the preselection buttons located at the top of the display.

To store the radio station being listened to, press and hold down the button corresponding to the desired preset until a confirmation acoustic signal is heard.

The system can store up to 12 radio station in each mode: 4 radio stations are displayed at the top.

Press the "All" button on the display to show all the radio stations stored in the frequency band selected.

AUDIO

To enter the "Audio" menu, press the SETTINGS button (10-fig. 1) on the front panel, scroll the menu then select and press the "Audio" item on the display.

The following adjustments can be carried out using the "Audio" menu:

- "Equalizer" (for versions/markets, where provided);
- "Balance/Fade" (left/right and front/rear balance adjustment);
- "Volume/Speed" (excluding versions with Hi-Fi system) speed-dependent automatic volume adjustment;
- "Loudness" (for versions/markets, where provided);
- "Auto-On Radio";
- "Radio Off Delay".

To exit the "Audio" menu, press the ◀/Done button.

NOTE When a setting is changed, the ◀ button is replaced with the word "Done".

Equalizer

(for versions/markets, where provided)

Select "Equalizer" on the display to adjust the bass, medium and treble tones.

Use the "+" or "-" buttons to carry out the settings desired (see fig. 8).

Then press ◀/Done button to return to the "Audio" menu.

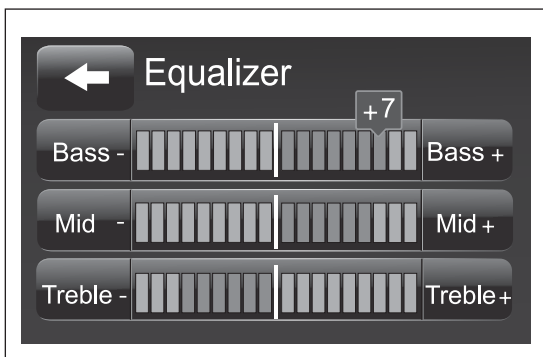

fig. 8

F0Y1002

Balance/Fade

Press the "Balance/Fade" button to balance the sound from the front and rear seat speakers.

Press the ▲ or ▼ buttons to balance the front and rear speakers (see fig. 9).

Press the ◀ or ▶ buttons to balance the speakers on the left and the right side.

The adjustment is also possible by moving the 🔊 symbol on the right side of the display upwards/downwards/to the left/to the right.

Press the central "C" button to balance the adjustments.

Then press ◀/Done button to return to the "Audio" menu.

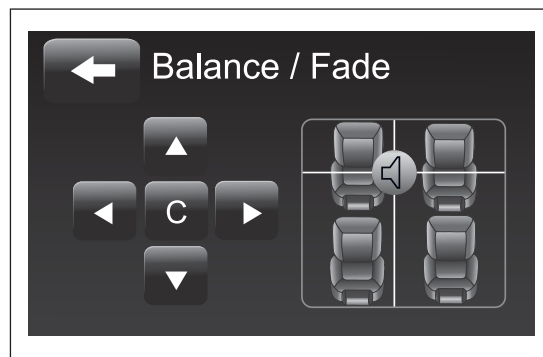

fig. 9

F0Y1003

Volume/Speed

Press the "Volume/Speed" button to choose between "Off" and "1, 2 or 3".

The option selected is displayed (see fig. 10).

Choose "1, 2 or 3" to increase the volume proportionally to the selection made.

Then press ◀/Done button to return to the "Audio" menu.

Loudness

(for versions/markets, where provided)

To activate/deactivate the "Loudness" function to improve the sound quality at low volumes.

Auto-On Radio

To set the radio behaviour when the ignition key is turned to MAR.

The options are radio on, radio off or reset of the condition active when the ignition key was last turned to STOP.

Radio Off Delay

To keep the radio on for a preset time after the ignition key is turned to STOP.

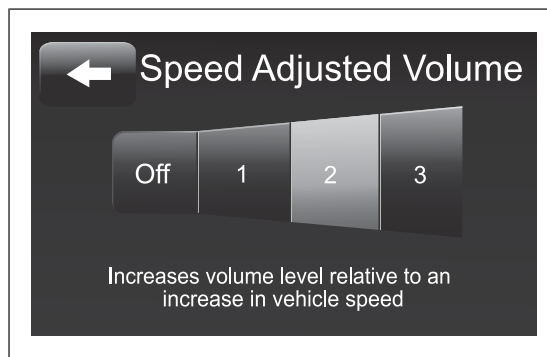

fig. 10

F0Y1004

MEDIA MODE

This chapter describes the interaction modes concerning the operation of CD, **Bluetooth**®, AUX, USB/iPod.

TRACK CHANGE (previous/next)

Briefly press the ►►| button or turn the BROWSE ENTER button/knob (7-fig. 1) clockwise to play the next track or briefly press the |◄◄ button or turn the BROWSE ENTER button/knob counterclockwise to return to the beginning of the selected track or at the beginning of the previous track if this has been played for less than 8 seconds.

TRACK FAST FORWARD/REWIND

Press and hold down the ►►| button to fast forward the selected track or keep the |◄◄ button pressed to fast rewind the track.

The fast forward/rewind will stop once the button is released or when the previous/next track is reached.

TRACK SELECTION (Browse)

Use this function to scroll through or select the tracks on the active device.

The selection options depend on the device connected or the CD type inserted.

For example, on an audio CD you can select the track to be played, whilst on a CD-ROM, a USB/iPod or **Bluetooth**® device you can scroll through the list of artists, genres and albums available depending on the information present on the tracks.

Use the "ABC" button inside each list to skip to the desired letter within the list.

NOTE This button may be disabled for some **Apple**® devices.

NOTE The "Browse" button does not allow any operation on an AUX device.

NOTE To consult the list of **Bluetooth**® audio devices and supported functions, visit the website www.fiat.com or call Customer Services on 00800.3428.0000 (the number may vary depending on the country: please refer to the reference table in the "Customer Service number list" section herein).

Press the "Browse" button to activate this function on the source being played.

Turn the BROWSE ENTER (7-fig. 1) button/knob to select the desired category and then press the button/knob to confirm the selection.

Press the "X" button to cancel the function.

NOTE The indexing time of a USB device can vary according to the media inserted (in some cases it can take a few minutes).

AUDIO SOURCE SELECTION

Press the "Source" button to select the desired audio source among those available: CD, AUX, USB/iPod or **Bluetooth®**.

If no source is selected, the screen disappears after a few seconds and the display shows the main screen again.

TRACK INFORMATION DISPLAY

Press the "Info" button to show on the display the information on the track being listened to for devices that support the function.

Press the "X" button to exit the screen.

RANDOM TRACK REPRODUCTION

Press the ">" button then the "Shuffle" button to play the tracks on CD, USB/iPod or **Bluetooth®** in random mode.

Press the "Shuffle" button again to deactivate the function.

TRACK REPETITION

Press the ">" button then the "Repeat" button to activate the function.

Press the "Repeat" button again to deactivate the function.

CD PLAYER

To activate the CD mode, enter an audio CD or an MP3 in the relevant slot 4 (fig. 1) or press the MEDIA button (11 - fig. 1) on the front panel.

If there is a CD inside, press the graphic button "Source" then select "CD".

If the CD loaded cannot be read (e.g. a CD-ROM has been inserted or the CD is inserted the wrong way round or there is a reading error) the display will show an error message.

LOADING/EJECTING A CD

To load the CD, insert it gently into the slot to activate the motorised loading system, which will position it correctly (the "CD" symbol on the display comes on).

Enter a CD when the system is on, the CD mode is automatically selected and the system starts playing the tracks.

The display shows the number of the track and the time (minutes and seconds).

Press the ▲ button (EJECT) (3 - fig. 1) on the front panel, with the system on, to activate the motorised ejection of the CD.

After the ejection, the audio source will be automatically selected.

If the CD is not removed from the slot, the system will re-enter it automatically after about 10 seconds without playing it.

Bluetooth® SOURCE

This mode is activated by pairing a **Bluetooth®** device containing music tracks with the system.

PAIRING A Bluetooth® AUDIO DEVICE

To pair a **Bluetooth®** audio device, proceed as follows:

- activate the **Bluetooth®** function on the device;
- press the MEDIA button (11-fig. 1) on the front panel;
- if the "Media" source is active, press the "Source" button;
- select the **Bluetooth®** media source;
- press the "Add Device" button;
- search for **uconnect®** on the **Bluetooth®** audio device (during the pairing stage a screen is displayed showing the progress of the operation);

- when requested by the audio device, enter the PIN code shown on the system display or confirm on the device the PIN displayed;
- if the pairing procedure is completed successfully, a screen is displayed. Answer "Yes" to the question to pair the **Bluetooth®** audio device as favourite (the device will have priority on all other devices that will be paired later on). If "No" is selected, the priority is determined according to the order of connection. The last device connected will have the highest priority;
- an audio device can also be paired by pressing the SETTINGS button (10-fig. 1) on the front panel and by selecting "Phone / **Bluetooth®**".

IMPORTANT If the **Bluetooth®** connection between mobile phone and system is lost, consult the mobile phone owner's handbook.

USB/iPod SUPPORT

To activate the USB/iPod mode insert the corresponding device (USB or iPod) in the USB port fig. 11 present on the car.

If a USB/iPod device is inserted with the system on, this starts playing the tracks present on the device.

AUX SUPPORT

To activate the AUX mode engage a suitable device in the AUX port fig. 12 on the car.

Entering a device when the system is on, it starts playing the tracks on the device (playing starts from the first track).

Adjust the volume by the button/knob  (1 - fig. 1) on the front or by the volume adjustment control on the connected device.

As for the "Audio source selection" function, see the chapter "Media Mode".

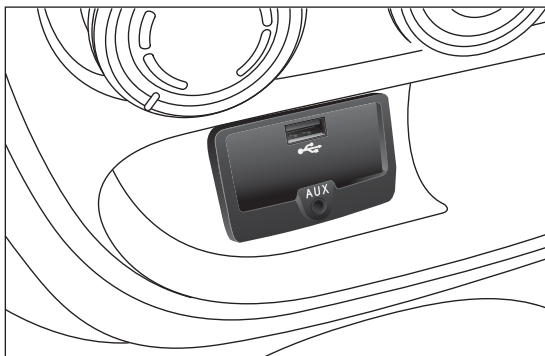

fig. 11

F0Y0097

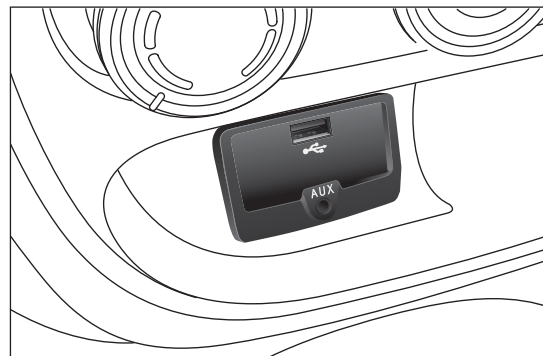

fig. 12

F0Y0097

IMPORTANT

The functions of the device connected with the AUX port are directly managed by the device itself: it is not possible to change track/folder/playlist with the controls on the front or on the steering wheel.

Do not leave the cable of your portable player connected with the AUX socket after disconnection, to avoid possible hiss from the speakers.

PHONE MODE

PHONE MODE ACTIVATION

Press the PHONE button (9-fig. 1) on the front panel to activate the Phone mode.

The following screen appears on the display (see fig. 13).

MAIN FUNCTIONS

Use the buttons on the display to:

- dial the phone number (using the graphic keypad on the display);
- display and call the contacts on the mobile phone phonebook;
- display and call contacts from the registers of previous calls;

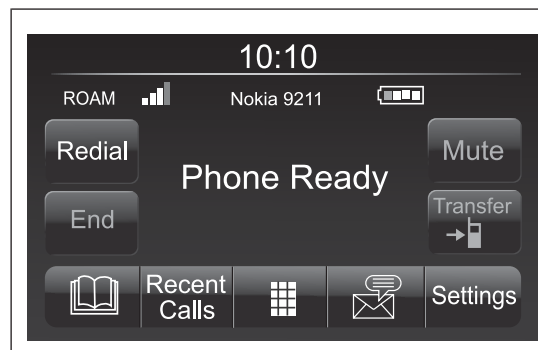

fig. 13

FOY1012

- pair up to 10 phones/audio device to make access and connection easier and quicker;
- transfer calls from the system to the mobile phone and vice versa and deactivate the microphone audio for private conversations.

Your mobile phone's audio is transmitted through your vehicle audio system; the system will automatically mute your radio when using the Phone function.

DISPLAYED INFORMATION

When a phone is connected to the system, the display shows various information (if available):

- status of roaming;
- network signal intensity;
- mobile phone battery charge;
- mobile phone name.

NOTE To consult the list of mobile phones and supported functions, visit the website www.fiat.com or call Customer Services on 00800.3428.0000 (the number may vary depending on the country: please refer to the reference table in the "Customer Service number list" section herein).

PAIRING A MOBILE PHONE

IMPORTANT Carry out this operation only with car stationary and in safety conditions; this function is deactivated when the car is moving.

Even though the mobile phone pairing procedure is described below we always recommend to consult the mobile phone owner's handbook.

To pair the mobile phone, proceed as follows:

- activate the **Bluetooth**® function on the mobile phone;
- press the PHONE button (9-fig. 1) on the front panel;
- if no phone is paired with the system yet, the display shows a dedicated screen;
- select "Yes" to start the pairing procedure then search for the **uconnect**® device on the mobile phone (if "No" is selected, the Phone main screen is displayed);
- when prompted by the mobile phone, use its keyboard to enter the PIN code shown on the system display or confirm on the mobile phone the PIN displayed;

- from the "Phone" screen you can always pair a mobile phone pressing the "Settings" button: press the "Add Device" button and proceed as described above;
- during the pairing stage a screen is displayed showing the progress of the operation;
- if the pairing procedure is completed successfully, a screen is displayed: answer "Yes" to the question to pair the mobile phone as favourite (the mobile phone will have priority on all other mobile phones that will be paired later on). If no other devices are paired, the system will consider the first associated device as favourite.

Note

The priority is determined according to the order of connection for mobile phones which are not set as favourite. The last phone connected will have the highest priority.



STORING NAMES/NUMBERS IN THE MOBILE PHONE PHONEBOOK

Before pairing your mobile phone, you must make sure you have stored the names you want to contact in the phonebook on your mobile phone so that you can call them using the car's hands-free system.

If your phonebook does not contain any names, enter new names for the most frequently used numbers.

For further details, consult your mobile phone owner's handbook.

IMPORTANT The names in the phonebook not containing phone numbers or name and surname will not be displayed.

CONNECTION/DISCONNECTION OF A MOBILE PHONE OR A Bluetooth® AUDIO DEVICE

Connection

The system connects automatically to the mobile phone paired with the highest priority.

To choose a specific mobile phone or **Bluetooth®** audio device, proceed as follows:

- press the SETTINGS button (10-fig. 1) on the front panel;
- select "Phone / Bluetooth" on the display;
- select the "Paired Phones" or "Paired Audio" list using the corresponding button on the display;
- select the specific device (mobile phone or **Bluetooth®** device);
- press the "Connect" button;
- during the connection stage a screen is displayed showing the progress of the operation;
- the device connected is highlighted in the list.

Disconnection

To disconnect a specific mobile phone or **Bluetooth®** audio device, proceed as follows:

- press the SETTINGS button (10-fig. 1) on the front panel;
- select "Phone / Bluetooth" on the display;
- select the "Paired Phones" or "Paired Audio" list using the corresponding button on the display;
- select the specific device (mobile phone or **Bluetooth®** device);
- press the "Disconnect" button.

DELETION OF A MOBILE PHONE OR A Bluetooth® AUDIO DEVICE

To delete a mobile phone or **Bluetooth®** audio device from a list, proceed as follows:

- press the SETTINGS button (10-fig. 1) on the front panel;
- select "Phone / Bluetooth" on the display;
- select the "Paired Phones" or "Paired Audio" list using the corresponding button on the display;
- select the device (mobile phone or **Bluetooth®** device);
- press the "Delete Device" button;
- a confirmation screen will appear on the display: press "Yes" to delete the device or "No" to cancel the operation.

SETTING A MOBILE PHONE OR A Bluetooth® AUDIO DEVICE AS FAVOURITE

To set a mobile phone or **Bluetooth®** audio device as favourite, proceed as follows:

- press the SETTINGS button (10-fig. 1) on the front panel;
- select "Phone / Bluetooth" on the display;
- select the "Paired Phones" or "Paired Audio" list using the corresponding button on the display;
- select the specific device (mobile phone or **Bluetooth®** device);
- press the "Make Favourite" button;
- the device selected is moved to the top of the list.

DELETION OF PHONE DATA (PHONEBOOK AND RECENT CALLS)

Select "Phone Data Delete" on the display to delete the list of recent calls and the phonebook copy.

TRANSMISSION OF PHONE DATA (PHONEBOOK AND RECENT CALLS)

If your mobile phone has a function for sending the phonebook via **Bluetooth®** technology.

During the pairing procedure a screen will appear with the request "Do you want to download you phone data and recent calls?".

Answer "Yes" to copy the whole phonebook and the list of recent calls to the system.

Answer "No" to carry out the operation later on.

After the first phone data transmission, the procedure for transmitting and updating the phonebook (if supported) starts as soon as a **Bluetooth®** connection is established between mobile phone and system.

Whenever a mobile phone is connected to the system, a maximum of 1000 contacts can be downloaded and updated for each phone.

Depending on the amount of items downloaded from the phonebook, a slight delay can occur before the last names downloaded can be used. Up to then the phonebook downloaded previously (if present) will be available.

Only the phonebook of the mobile phone currently connected to the system can be accessed.



The phonebook downloaded from the mobile phone can neither be modified nor be deleted through the **uconnect®** system: changes will be transmitted and updated in the system when the mobile phone is next connected.

MAKING A PHONE CALL

The operations described below can only be accessed if supported by the mobile phone in use.

For all functions available, refer to the mobile phone owner's handbook.

A call can be made by:

- selecting the  icon (mobile phone phonebook);
- selecting "Recent Calls";
- selecting the  icon;
- Pressing the "Redial" button.

Dialling the phone number using the "keyboard" icon on the display

Enter the phone number using the graphic keyboard displayed.

Proceed as follows:

- press the PHONE button (9-fig. 1) on the front panel;
- press the  button on the display and use the numbered buttons to enter the number;
- press the "Call" button to make a call.

Dialling the phone number using the mobile phone

It is possible to dial a phone number with the mobile phone and continue using the system (never allow yourself to be distracted while driving).

When a phone number is dialled with the keyboard of the mobile phone, the audio of the call is played over your car's sound system.

Recent calls

The list of the last calls made for each of the following call types can be displayed:

- Calls received;
- Calls made;
- Calls without a reply;
- All calls.

To access these types of calls, press the "Recent Calls" button on the Phone menu main screen.

MANAGING AN INCOMING CALL

Call controls

The buttons on the display allow the following phone call functions to be managed:

- Answer;
- End;
- Ignore;
- Put on hold/resume;
- Deactivate/activate the microphone;
- Transfer the call;
- Switch from one call to the other;
- Conference/merge two active calls.

Answering a phone call

When a phone call is received on the mobile phone, the system deactivates the audio system (if active) and displays a screen.

Press the "Answer" button or the  button on the steering wheel controls to answer.

Rejecting a phone call

Press the "Ignore" button or the  button on the steering wheel controls to reject.

Answering an incoming call during an active conversation

To answer an incoming call whilst another phone conversation is in progress, press the "Answer" button to put the ongoing call on hold and answer the new incoming call.

IMPORTANT Not all mobile phones may support the management of an incoming call when another phone conversation is active.

MAKING A SECOND PHONE CALL

When a phone conversation is active, a second phone call can be made as follows:

- select the number/contact of the list of recent calls;
- select the contact from the phonebook;
- press the "Hold" button and dial the number using the graphic keyboard of the display.

MANAGING TWO PHONE CALLS

If two calls are in progress (one active and one on hold), it is possible to switch between them pressing the "Call On Hold" button or to merge the two calls in a conference pressing the "Merge calls" buttons.

Note

Check whether the telephone in use supports the management of a second call and the "Conference" mode.

ENDING A CALL

Press the "End" button or the  button on the steering wheel controls to end a call in progress.

Only the ongoing call is ended and any call on hold becomes the new active call.

Depending on the type of mobile phone, if the ongoing call is ended by the caller, the call on hold may not be activated automatically.

REDIALLING

To call the number/contact of last call made, press the "Redial" button.

CONTINUING A PHONE CALL

After the engine is switched off, it is still possible to continue a phone call.

The call continues until it is ended manually or for a maximum period of about 20 minutes.

When the system is switched off the call is transferred to the mobile phone.

ACTIVATION/DEACTIVATION OF THE MICROPHONE

During a call the microphone can be deactivated pressing the  button on the front panel (or on the steering wheel controls) or the "Mute" button on the display.

When the microphone is deactivated it is still possible to listen to the call in progress.

To reactivate the microphone, press the corresponding button again.



TRANSFERRING A CALL

The ongoing calls can be transferred from the mobile phone to the system and vice versa without ending the calls.

To transfer the call, press the "Transfer" button.

SMS MESSAGE READER

The system can read the messages received by the mobile phone.

To use this function the mobile phone must support the SMS exchange function via **Bluetooth**®.

If this function is not supported by the phone, the corresponding  button is deactivated (greyed out).

When a text message is received, the display will show a screen where the options "Listen", "Call" or "Ignore" can be selected.

Press the  button to access the list of SMS messages received by the mobile phone (the list displays a maximum of 60 messages received).

"MORE" MODE

Press the MORE button (8-fig. 1) on the front panel to display (see fig. 14) the following operation settings:

- Trip Computer;
- Clock;
- eco:Drive.

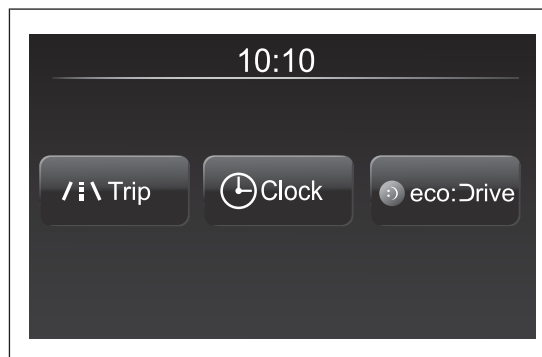

fig. 14

FOY1013

TRIP COMPUTER

Press the "Trip" button (see fig. 14) to display the trip information of the car.

This function allows you to display the consumption levels and define two separate trips called "Trip A" and "Trip B" for monitoring the car's "complete journey" in a reciprocally independent manner.

Both functions can be reset (reset - start of a new journey): to reset the desired "Trip" hold down the "Trip A" or "Trip B" buttons.

CLOCK

Press the "Clock" button (see fig. 14) to display the clock.

eco:Drive

eco:Drive (see fig. 15) monitors your driving style on-board and in real time using the "Acceleration", "Deceleration", "Gearbox" (excluding versions with automatic transmission used in "Auto" mode) and "Speed" indexes which are calculated and stored directly in the system;

Connect to the eco:Drive site (www.fiat.com/ecodrive) to configure the USB stick to be used to estimate the trip and the driving style data.

Do not remove the USB stick until the system has downloaded the data since they might be lost completely or partially.



fig. 15

FOY1014

Activation

Press the "eco:Drive" button (see fig. 14) to interact with the function.

To activate the function press the "eco:Drive ON" button.

A screen will be displayed (see fig. 16) showing 4 indexes:

- "Acceleration";
- "Deceleration";
- "Gearbox" (only 3 indexes for versions with automatic transmission without the "Gearbox" index);
- "Speed".

These indexes are grey until the system has sufficient data to evaluate the driving style or in the event of long stops.

Once sufficient data are available, the indexes will have 4 colours depending on the evaluation: green (very good), yellow, orange and red (very bad).

The average of these indexes will be displayed above them, in real time, indicating the eco-sustainability of the driving style, from 0 (low) to 100 (high).

To check the data average of previous trip (the "trip" starts when the ignition key is turned to MAR and stops when it is turned to STOP), select the "Previous Trip" button (see fig. 17).

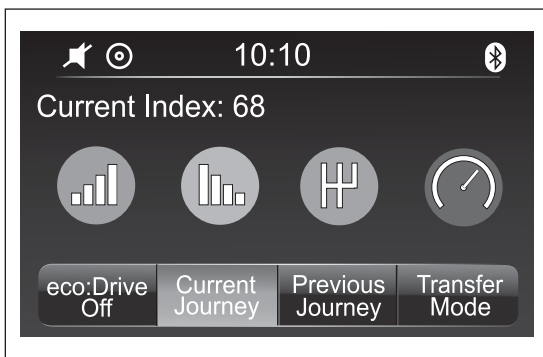

fig. 16

F0Y1015

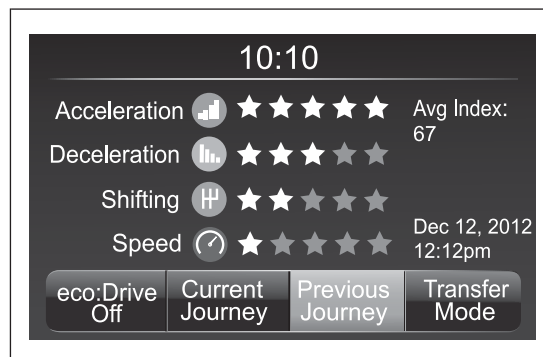

fig. 17

F0Y1016

The data are automatically transferred to the USB stick when the engine is switched off. The data transferred are deleted from the system memory.

When the data are transferred to the USB stick, the display could show instructions on the correct operation steps: follow these instruction.

These messages are only displayed with ignition key in STOP position and radio off delay longer than 0 minutes.

Note

Warning messages will be displayed, when the USB memory is full.

Deactivation

Press the "eco:Drive Off" button to deactivate the function.

SETTINGS

Press the SETTINGS button (10-fig. 1) on the front panel to display the "Settings" main menu (see fig. 18).

NOTE The menu items displayed vary according to the versions.

The menu comprises the following options:

- Display;
- Time & Date;
- Safety/Assistance (for versions/markets, where provided);
- Lights (for versions/markets where provided);
- Doors & Locks;
- Audio;
- Phone / Bluetooth;
- Radio;
- Restore Default Settings.



fig. 18

FOY1005

Display

The "Display" menu contains the following options:

- "Brightness"** (this setting is not available when the display mode is set to "Automatic"): select "Brightness" and press the "+" or "-" buttons to adjust the display brightness with the headlights on or off (the setting not corresponding to the active headlight condition is greyed out).
- "Display Mode"**: press the "Display Mode" button to set the display brightness according to "Day", "Night" or "Auto" condition. In "Auto" mode the display brightness is aligned to that of the instrument panel.
- "Language"**: press the "Language" button to select one of the languages available.
- "Units"**: press the "Units" button to select the correct unit for "Temperature" ("°C" or "°F"), "Distance" ("km" or "mi") and "Fuel Consumption". If the distance is in "km", "km/l" or "l/100km" can be selected. If the distance is in "mi" (miles), "miles per gallon" ("mpg") are set automatically.

- "Voice Resp. Length"**: press the relevant button to set the detail level of the voice messages supplied by the system and the suggestions displayed.
- "Touchscreen Beep"**: press the relevant button to activate/deactivate the acoustic signal when the buttons on the displayed are pressed.
- "Display Trip B"**: press the relevant button to activate/deactivate the displaying of the Trip B on the instrument panel display.

Clock & Date

Use this function to set the clock.

Time setting

Press the SETTINGS button (10-fig. 1) on the front panel then select "Clock & date" (see fig. 18).

Select "Set Time" and press the ▲ or ▼ buttons (see fig. 19) to adjust hours and minutes.

Press the "12h" or "24h" buttons to select the time format.

The "am" and "pm" are available in "12h" mode.

In the Clock menu, "Show Time Status" can be selected to activate/deactivate the displaying of the clock at the top of the display (for versions/markets where provided).

Date setting

To set the date proceed as for the time setting: select "Set Date" to adjust day, month and year.



fig. 19

F0Y1006

Safety/Assistance

(for versions/markets, where provided)

Select this function to adjust the rain sensor sensitivity (for versions/markets, where provided).

Lights

(for versions/markets, where provided)

Use this function to carry out the following adjustments:

- "Twilight sensor" (for versions/markets, where provided): adjustment of headlight switching on sensitivity;
- "Daytime Lights" (DRL) (for versions/markets where provided): activation/deactivation of daytime lights;
- "Cornering Lights" (for versions/markets where provided): activation/deactivation of cornering lights.

Doors & Locks

Use this function to activate/deactivate the automatic door locking when the car is moving ("Autoclose" function).

Audio

See paragraph "Audio" in chapter "Switching the system on/off".

Phone / Bluetooth

See the description in the "Connecting/disconnecting a mobile phone or a **Bluetooth**® audio device" paragraph in the "Phone Mode" chapter.

Radio

Use this function to configure the following options:

- "Traffic Announc.": activation/deactivation of the automatic tuning of the traffic announcements ("TA" function);
- "Altern. Frequency": activation/deactivation of the automatic tuning of the strongest signal for the station selected ("AF" function);
- "Regional": activation/deactivation of the automatic tuning to a station which broadcasts regional news ("REG" function);
- "Playing DAB Announcements": activation/deactivation of the automatic tuning to DAB announcements and selection of announcement categories of interest among those available.

Restore Default Settings

Use this function to restore the settings for display, time, date, audio and radio to the default values set by the manufacturer.

VOICE COMMANDS

USE OF THE VOICE COMMANDS

Please follow the suggestions below to be sure that the voice commands are always recognised by the system:

- speak at a normal volume;
- always wait for the "beep" before speaking;
- the system is capable of recognising the voice commands given, irrespective of gender, by the tone of voice and intonation of the person giving the instructions;
- if possible, try and keep the noise in the passenger compartment to a minimum;
- before giving voice commands, ask other passengers not to talk. This is to prevent misunderstanding since the system may recognise other words (in addition to or different from your voice command) if several people are speaking;
- for optimum operation it is advisable to close the windows and the sun roof (for versions/markets, where provided) to avoid external interference.

IMPORTANT Voice commands must always be given in safe driving conditions, in compliance with the laws in force in the country where you are driving and using the mobile phone correctly.

USE OF STEERING WHEEL CONTROLS TO ACTIVATE VOICE COMMANDS

"Phone" button

The button  on the steering wheel controls activates the "Phone" voice recognition system to make calls, display recent incoming and outgoing calls and phonebook, etc.

Every time the button  is pressed, there is a "beep" and the display shows a suggestion screen inviting the user to say a command.



"Voice" button



The button  on the steering wheel controls activates the "Radio/Media" voice recognition system to:



- tune to a specific radio station;
- tune to a specific AF/FM radio frequency;
- play a track on a USB memory stick/iPod/CD MP3;
- play an album track on a USB memory stick/iPod/CD MP3.

Every time the button  is pressed, there is a "beep" and the display shows a suggestion screen inviting the user to say a command.

Fast use of the voice interaction



The buttons  or , when pressed during a system voice message, enable to say a voice command directly.



For example, if the system is saying a help voice message and you know the command to give to the system, pressing the buttons  or , the voice message is interrupted and you can say the wished voice command directly (without having to listen to the whole help voice message).

The buttons  or , if pressed when the system is waiting for a voice command by the user, close the voice session.

VOICE SESSION STATUS

The system displays the voice session status with specific icons:

-  (green icon): displayed when the system is listening. In this case you can say a voice command;
-  (green icon): displayed when the system has interpreted the said voice command and its function is performed. In this case you cannot say a voice command;
-  (green icon): displayed when the system is processing the given voice command. In this case you cannot say a voice command;

-  (yellow icon): displayed when the system is saying a help, information or multiple choice voice message. In this case you cannot say a voice command;
-  (red icon): displayed when the voice interaction is ended by the user. In this case you cannot say a voice command.

MULTIPLE CHOICE

In a few specific cases the system cannot define univocally the said voice command and asks for choosing among max. four alternatives.

For example, if you ask to call a name in the phonebook and there are similar names, the system will suggest a numerical list of the available alternatives (see fig. 20), asking to say the associated number.

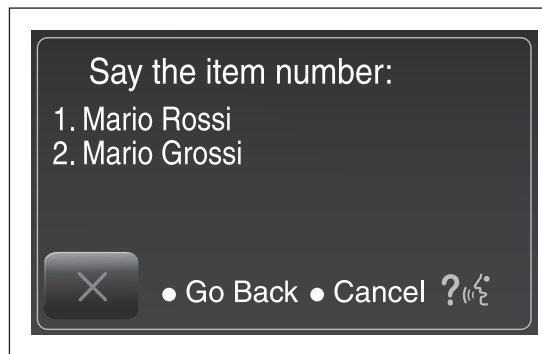

fig. 20

FOY1046

GLOBAL VOICE COMMANDS

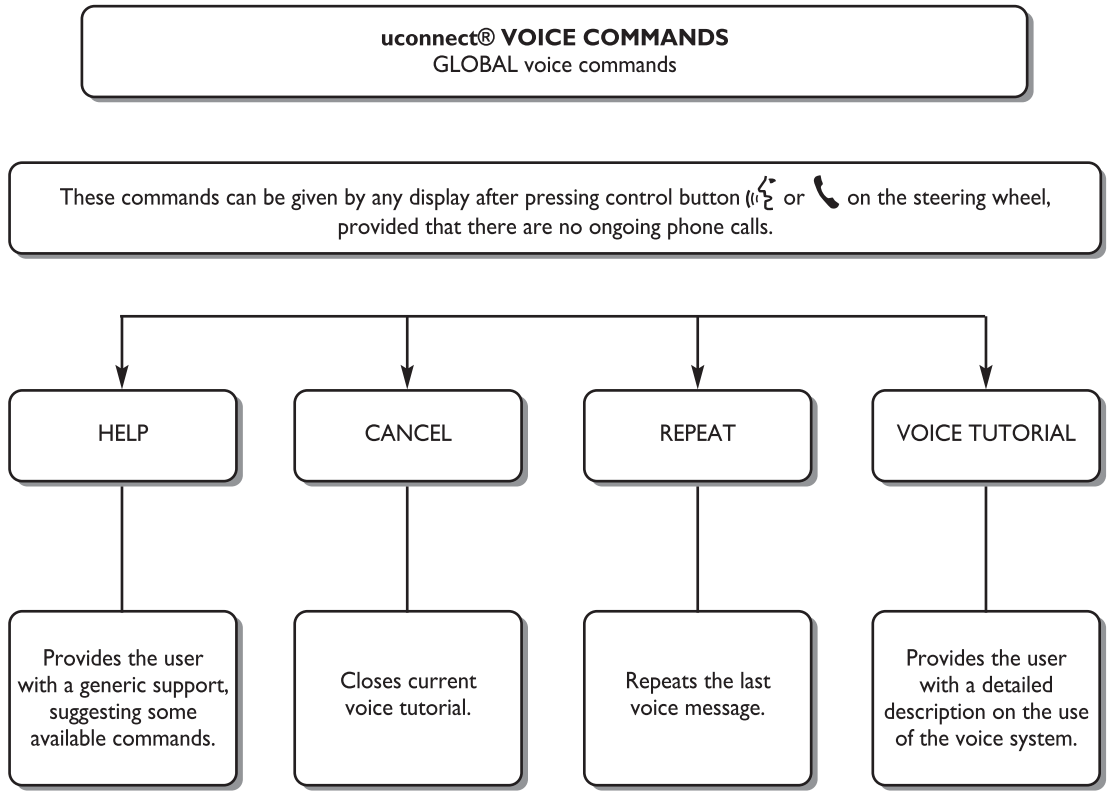



fig. 21

FOY1040

PHONE VOICE COMMANDS

uconnect® VOICE COMMANDS PHONE voice commands

If a phone is connected via **Bluetooth®** to the **uconnect®** system, these commands can be given by any of the main displays after pressing button  provided that there are no ongoing phone calls. If no phone is connected via **Bluetooth®**, the **uconnect®** system will provide voice message: "There are no paired phones. Pair a phone and try again" and session will be ended.

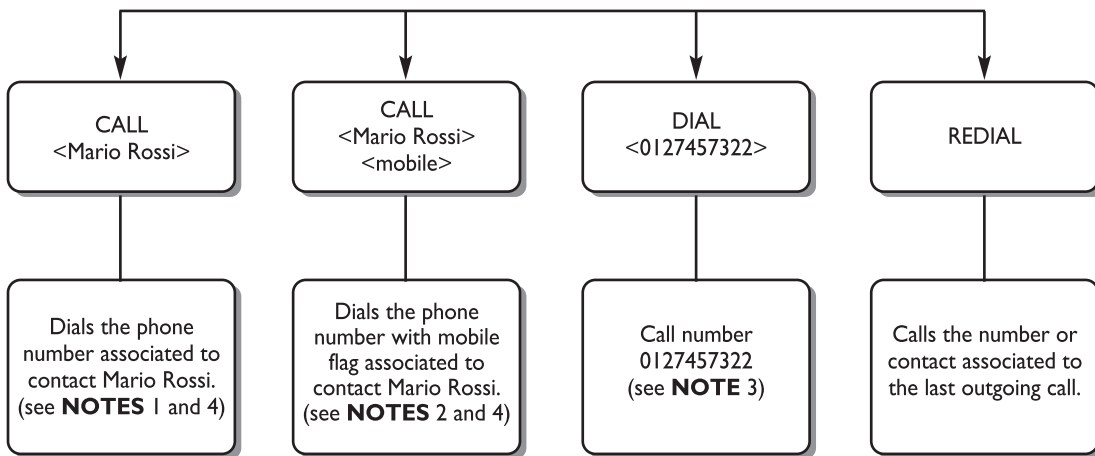

continued ⇨

fig. 22

follows ⇒

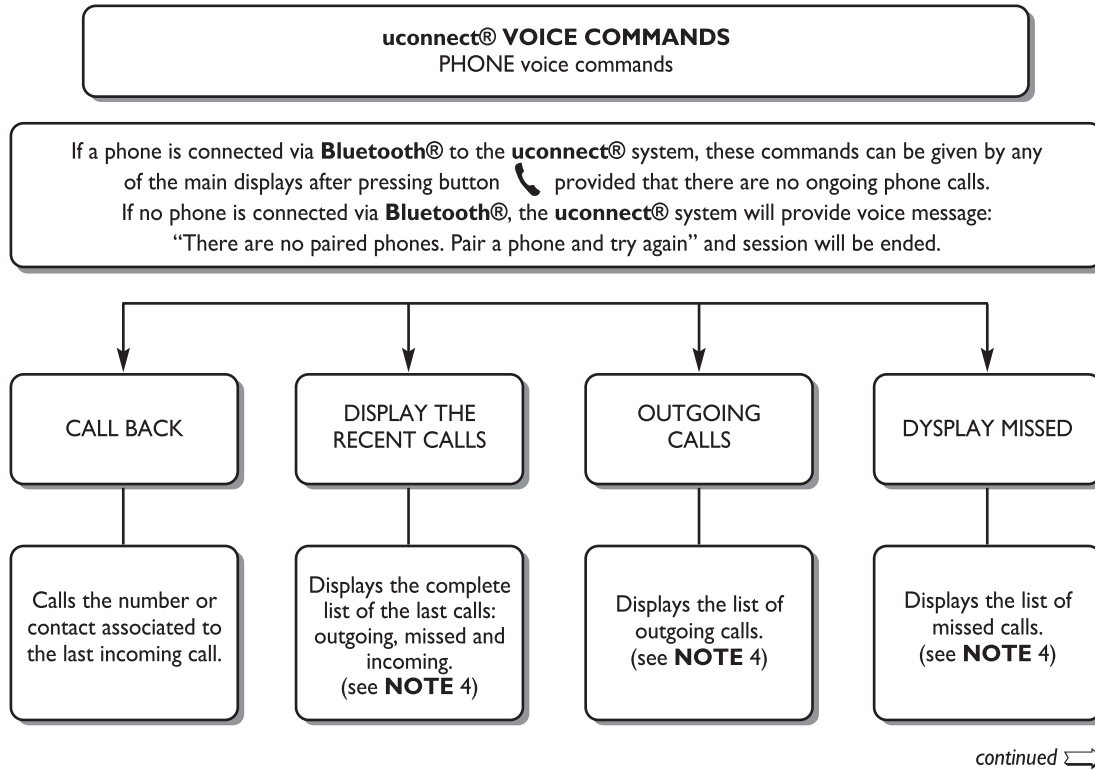



fig. 23

F0Y1042

follows →

uconnect® VOICE COMMANDS
PHONE voice commands

If a phone is connected via **Bluetooth®** to the **uconnect®** system, these commands can be given by any of the main displays after pressing button  provided that there are no ongoing phone calls. If no phone is connected via **Bluetooth®**, the **uconnect®** system will provide voice message: "There are no paired phones. Pair a phone and try again" and session will be ended.

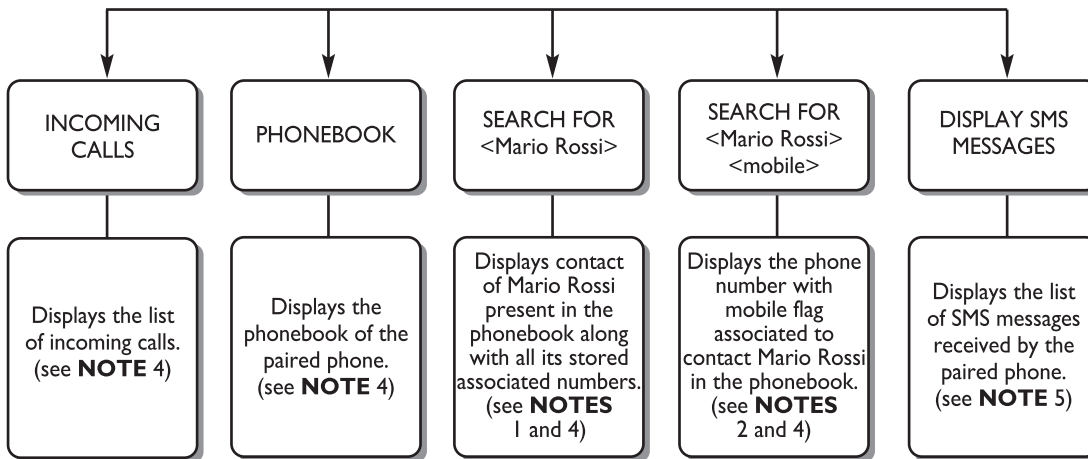

fig. 24

NOTES

1. <Mario Rossi> can be replaced with any name in the phonebook of your mobile phone.

If the phone allows storing of <name> (Mario) and <surname> (Rossi) in two different fields, the following voice commands can be given:

CALL <Mario> <Rossi>

CALL <Rossi> <Mario>

SEARCH FOR <Mario> <Rossi>

SEARCH FOR <Rossi> <Mario>

2. <mobile> can be replaced with one of the 3 available flags: <home>, <office>, <other>.

If the phone allows storing of <name> (Mario) and <surname> (Rossi) in two different fields, the following voice commands can be given:

CALL <Mario> <Rossi> <mobile>

CALL <Rossi> <Mario> <mobile>

SEARCH FOR <Mario> <Rossi> <mobile>

SEARCH FOR <Rossi> <Mario> <mobile>

3. Phone number <0127457322> can be replaced with any other phone number.

4. This function is only available if the phone, connected via Bluetooth, supports download of the phonebook and of the last calls on the **uconnect®** system and if the download has been carried out.

5. This function is only available if the phone, connected via Bluetooth® to the **uconnect®** system, supports SMS message voice reading function.

fig. 25

F0Y1044



RADIO AM/FM/DAB VOICE COMMANDS

uconnect® VOICE COMMANDS
RADIO AM/FM/DAB voice commands

These commands can be given by any main display after pressing control button  on the steering wheel, provided that there are no ongoing phone calls.

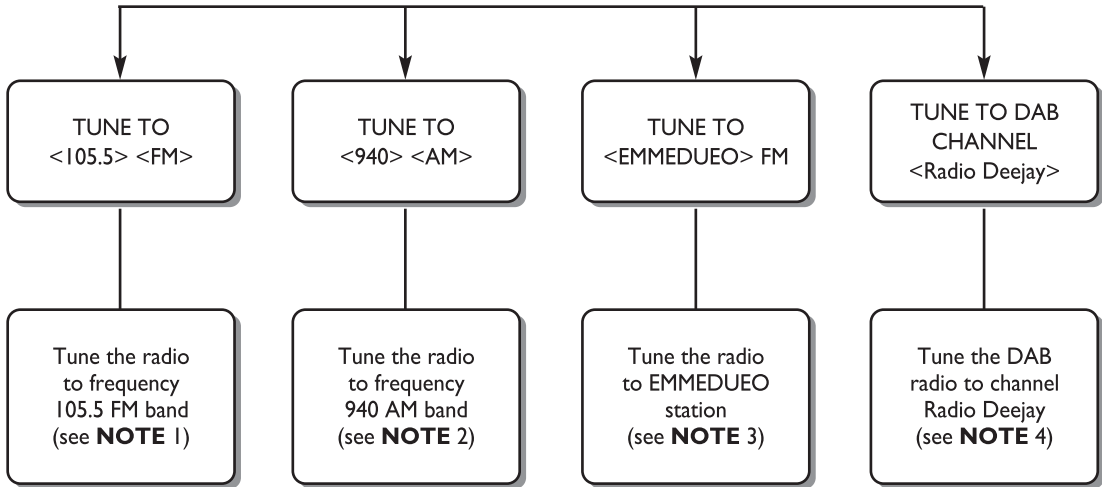

fig. 26

NOTES

1. <105.5> can be replaced with any other available frequency of the FM band.
2. <940> can be replaced with any other available frequency of the AM band.
3. <EMMEDUEO> can be replaced with any other name of FM station received by the radio.
Not all the radio stations provide this service.
4. <Radio DeeJay> can be replaced with any other DAB channel name received by the DAB radio.
Not all the DAB channels provide this service.

fig. 27

FOY1050

MEDIA VOICE COMMANDS

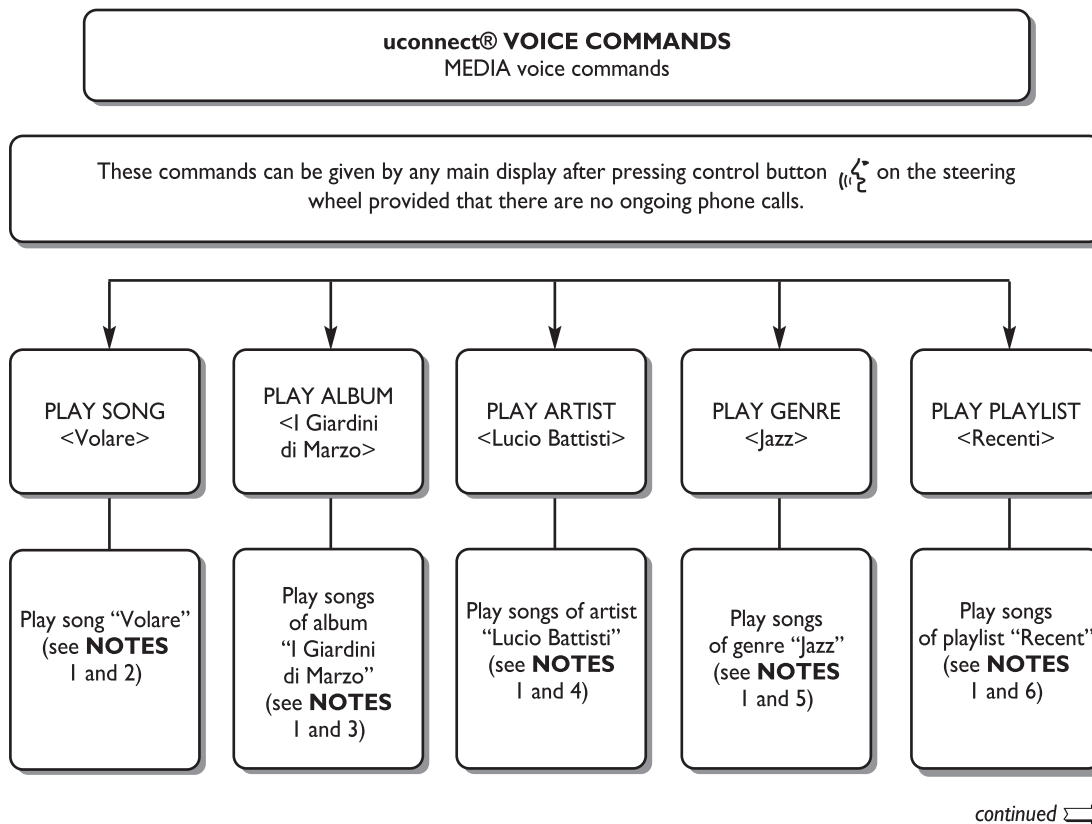

fig. 28

follows ⇨

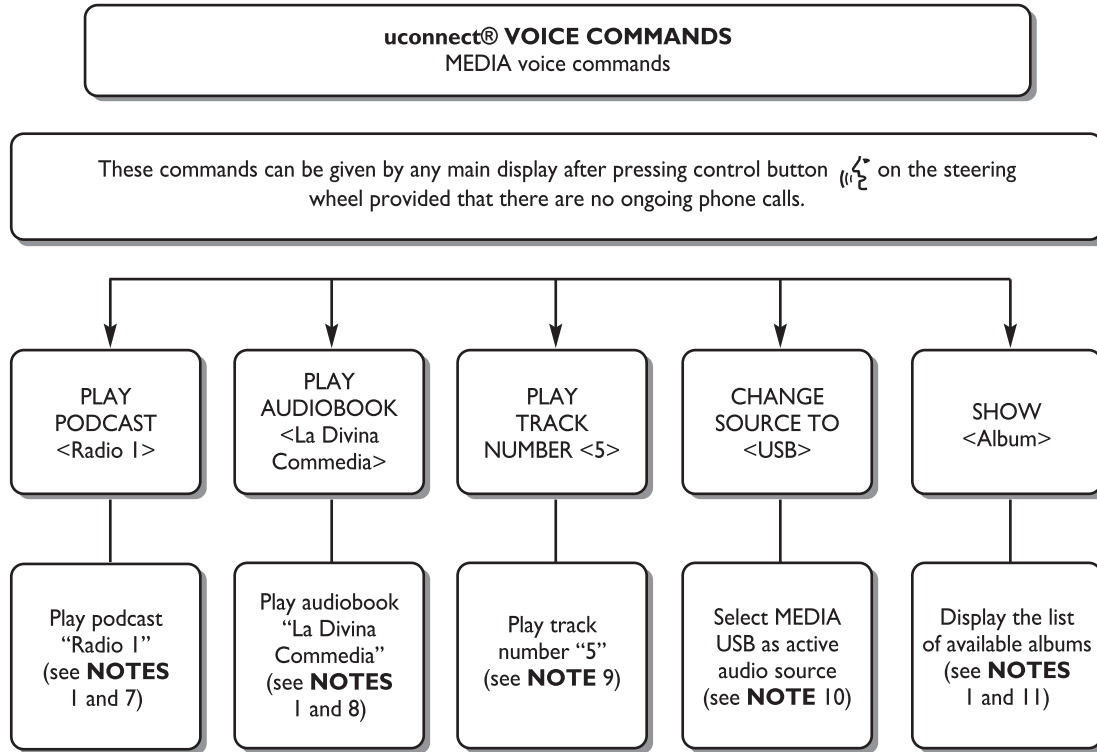

fig. 29

FOY1048

NOTES

1. Multimedia files stored in MEDIA sources (USB memory stick, iPod via USB, MP3 CD) should have information about songs correctly set (song title, artist, album, genre, podcast, audiobook) otherwise they will not be available via voice commands.
2. <Volare> can be replaced with any other title of a song available in the MEDIA source (available on USB memory stick, iPod via USB, MP3 CD) inserted and active.
3. <I Giardini di Marzo> can be replaced with any other title of an album available in the MEDIA source (available on USB memory stick, iPod via USB, MP3 CD) inserted and active.
4. <Lucio Battisti> can be replaced with any other name of an artist available in the MEDIA source (available on USB memory stick, iPod via USB, MP3 CD) inserted and active.
5. <Jazz> can be replaced with any other genre available in the MEDIA source (available on USB memory stick, iPod via USB, MP3 CD) inserted and active.
6. <Recent> can be replaced with any other name of a playlist available in the MEDIA source (available on USB memory stick, iPod via USB, MP3 CD) inserted and active.
7. <Radio I > can be replaced with any other name of a podcast available in the MEDIA source (available on iPod via USB) inserted and active.
8. <La Divina Commedia> can be replaced with any other title of an audiobook available in the MEDIA source (available on iPod via USB) inserted and active.
9. <5> can be replaced with any track number available in the MEDIA source (available on audio CD) inserted and active.
10. <USB> can be replaced with any other MEDIA source: "USB", "iPod", "CD", "AUX" and "Bluetooth".
11. <Album> can be replaced with any other category:
 - “Songs”, “Artists”, “Albums”, “Genres”, “Playlists” (available on USB memory stick, iPod via USB, MP3 CD)
 - “Folders” (available on USB memory stick, MP3 CD)
 - “podcasts”, “audiobooks” (available on iPod via USB).

fig. 30

CUSTOMER SERVICE NUMBER LIST

The following table shows the specific Customer Service numbers for each country.

Country	International freephone number	Company freephone number	International number
Austria	00800.3428.0000	–	+39.02.44412.041
Belgium	00800.3428.0000	0800.55111	+39.02.44412.041
Denmark	–	–	–
France	00800.3428.0000	0800.3428.00	+39.02.44412.041
Germany	00800.3428.0000	+49.69.669.888.70 (upon payment)	+39.02.44412.041
Greece	–	800.11500.800	+39.02.44412.041
Ireland	–	1800.3428.00	+39.02.44412.041
Italy	00800.3428.0000	800.3428.00	+39.02.44412.041
Luxembourg	00800.3428.0000	800.28111	+39.02.44412.041
Holland	00800.3428.0000	–	+39.02.44412.041
Poland	00800.3428.0000	–	+39.02.44412.041
Portugal	00800.3428.0000	–	+39.02.44412.041
United Kingdom	00800.3428.0000	–	+39.02.44412.041



Country	International freephone number	Company freephone number	International number
Czech Republic	–	–	–
Slovakia	–	–	–
Spain	00800.3428.0000	900.3428.00	+39.02.44412.041
Sweden	–	–	–
Switzerland	00800.3428.0000	–	+39.02.44412.041
Hungary	–	06.40.245.245 (upon payment)	+36.1.465.3688