

User Guide

A Step-by-Step Guide for
Planning, Installing, and
Operating a Complete Central
Home Device Control System

Congratulations on your Purchase of an ASPIRE RF Wireless Control System!

Part of the next generation of convenient, dependable, and user-friendly wireless controls, your new system allows you to create a wireless, two-way network within your family home, condo, or apartment. The network puts you in command of a large number of compatible devices from a single, remote control. Some of the benefits that you will enjoy with your new wireless control system include:

- Convenience and versatility – use the centralized control system for home lighting controls, appliances, and your thermostat
- Safety – enjoy a safe arrival at night by coming home to a well-lit house by simply triggering your garage door opener
- Enhanced Home Experience – set the mood for entertainment, romance, or relaxation by setting all light levels for any group of fixtures with the touch of a button
- Ease of Installation – benefit from the simple and practical set-up process with a quick and painless install every time
- Time and Energy Savings – turn off groups of lights from any location in the home and reduce energy bills with one-touch control

How the System Works

Each ASPIRE RF device functions as a repeater, using 900 MHz signals to ensure that every command is carried out. Rather than depending solely on line-of-sight communications like other technologies, the system employs Z-Wave™, a technology that is able to get around obstacles by routing commands through other devices in the network when required.

The controller is a portable device capable of both managing your Z-Wave network and controlling all of the devices on your network.

In addition to your ASPIRE RF Wireless Control System, ASPIRE offers a fully integrated array of devices and accessories, including smart dimmers, switches, duplex receptacles, and a wealth of accessories to link your entire network.

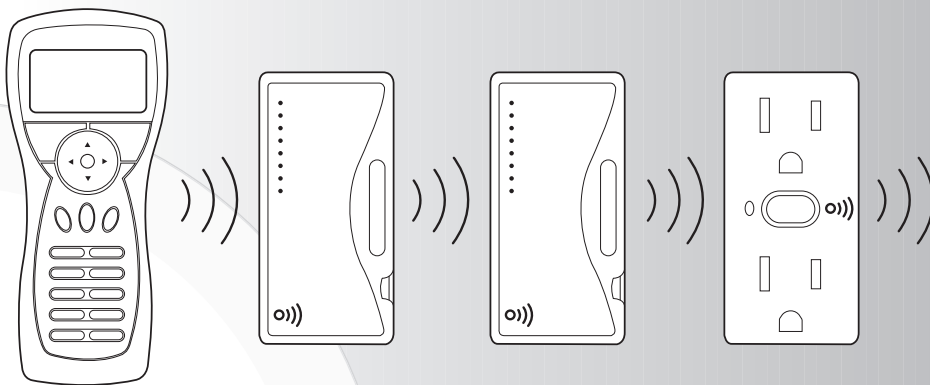

Using This Guide

We recommend that you carefully review the contents of this guide to get the most from your wireless system. If you have additional questions related to the installation or the operation of your Aspire RF Wireless Control System, please call 1-866-853-4293 or go to cooperwiringdevices.com/aspirerf.

I. Safety Information and FCC Information	4
II. Quick Reference Guide	5
III. Installing and Activating Devices	9
Installing a Device	9
Checking Device Status	10
Renaming a Device	11
Configuring a Device	12
Activating Individual Devices	13
Activating ALL ON and ALL OFF	15
Controlling Devices	16
Controlling the Thermostat	17
Customizing the All Switch	18
Activating Panic Mode	19
Customizing Panic Group	19
IV. Creating and Controlling Scenes	21
Creating a Scene	21
Activating a Scene	23
Creating Favorite Scenes	24
Renaming a Scene	25
Renumbering a Scene	26
Deleting a Scene	27
Editing a Scene	28
Transferring a Scene	29
V. Creating and Controlling Events	29
Creating an Event	29
Activating or Deactivating an Event	32
Activating or Deactivating All Events	32
Renaming an Event	33
Deleting an Event	34
Editing an Event	35
VI. Editing and Controlling the Away Feature	36
Editing the Away Feature	36
Activating or Deactivating the Away Feature	38
VII. Making Advanced Changes to Your System	39
Creating an Association Between Devices	39
Replicating Handheld Information to a Second Receiver	41
Selecting a New Primary Controller	42
Uninstalling a Device	43
Resetting the System	44
VIII. Personalizing System Settings	45
Setting Current Day and Time	45
Selecting a Language	46
Activating Child Protection	47
IX. Troubleshooting Guide and Maintenance	48
Retrieving Version Information about Your System	48
Retrieving Version Information about an Individual Device	49
Removing a Failed Device	50
Replacing a Failed Device	51
Operating Network Discovery	52
X. Warranty	53
XI. Ordering Information for Cooper Wiring Devices	54

Safety First (Cautions and Warnings)

Lorem ipsum dolor sit amet, consectetur adipiscing elit. Nullam ac dui. Aliquam commodo adipiscing lacus. Nunc eget erat. Sed consequat justo non leo. Integer id nisl vel nisi gravida iaculis. Proin vel sapien. Suspendisse ut nunc. Aenean scelerisque consequat eros. Fusce suscipit. Praesent purus. Sed dictum mi quis tellus laoreet suscipit. Nunc in turpis. Duis ac lacus. Fusce mattis scelerisque turpis. Mauris quis nisl id metus consectetur mattis. Morbi semper condimentum odio. Pellentesque vestibulum. Pellentesque molestie lobortis pede.

Vaenean tempor mi ut eros. Praesent odio urna, posuere eu, sagittis non, congue ac, urna. Maecenas vestibulum ipsum et dui. Nullam massa lorem, ornare id, elementum eu, condimentum vitae, felis.

Suspendisse quis nisi. Nulla eu lectus sit amet ligula bibendum molestie. Sed nisi neque, congue eget, imperdiet a, gravida nec, eros. Curabitur nec mi. Maecenas purus. Phasellus nec velit et justo sollicitudin iaculis. Duis quis magna. Pellentesque enim ligula, semper ut, lacinia eu, suscipit non, quam.

FCC INTERFERENCE STATEMENT

NOTE: This equipment has been tested and found to comply with the limits for a Class B digital device, pursuant to Part 15 of the FCC Rules. These limits are designed to provide reasonable protection against harmful interference in a residential installation. This equipment generates, uses and can radiate radio frequency energy and, if not installed and used in accordance with the instructions, may cause harmful interference to radio communications. However, there is no guarantee that interference will not occur in a particular installation. If this equipment does cause harmful interference to radio or television reception, which can be determined by turning the equipment off and on, the user is encouraged to try to correct the interference by one or more of the following measures:

- Reorient or relocate the receiving antenna.
- Increase the separation between the equipment and receiver.
- Connect the equipment into an outlet on a circuit different from that to which the receiver is connected.
- Consult the dealer or an experienced radio/TV technician for help.

FCC CAUTION:

Any changes or modifications not expressly approved by Cooper Wiring Devices could void the user's authority to operate the equipment.

Cooper Wiring Devices, 302 Cooper Circle, Peachtree City, GA 30269 • 866-853-4293

Follow these instructions to get started using your Aspire RF Wireless Control System right away.

Getting Started

To use the wireless control system, first put information about your home devices into the handheld and tabletop controllers. In order to power on, each controller requires AA batteries:

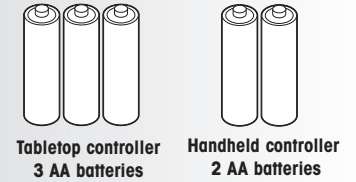

Powering On and Off the Controllers

Pressing any button will activate the controllers. After thirty seconds of inactivity, the controller will automatically power off.

Using the Controllers

The controllers use a menu system to guide you. This section will introduce you to the following basic concepts:

- Controller Buttons
- Navigating Menu Screens
- Using the Controller
- Creating Custom Names

Favorite Scene buttons

OK button

Menu button

Arrow pad

ALL ON button

Panic button

Back button

ALL OFF button

Tabletop Controller

Handheld Controller

Menu button

Back button

Arrow pad

OK button

ALL OFF button

Panic button

ALL ON button





Number pad

Using the Controller

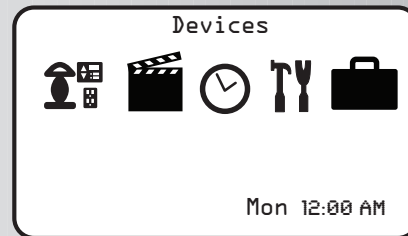
Menu Options

The controllers use an easy-to-navigate menu system to provide all functionality for the wireless system. When activating the controller, these icons represent the five main menus.



	Devices Menu	Use this menu to control the basic functions of the devices, such as installation, de-installation, naming, child protection, and on/off operation.
	Scenes Menu	Use this menu to direct any combination of lighting or devices to a desired level. You can create a list of favorite scenes (such as Bedtime, Movie Time, or Dinner) that will make it easy to make changes with one-touch control.
	Events Menu	Use this menu to schedule one-time or recurring changes to devices in your home. You can create, name, edit, change, delete, or schedule individual or groups of events.
	Settings Menu	Use this menu to customize your controller with your preferences for day/time, language, panic mode settings, system information, and much more.
	Away Menu	Use this menu to edit and control functions that give the impression that your house is occupied when you're away for an extended period of time.

Navigating Menu Screens

You can easily navigate through the menu screens on your controllers. Here are some tips to help you become familiar with the system:

- **To select a menu icon,** use the left and right arrows to highlight your choice.

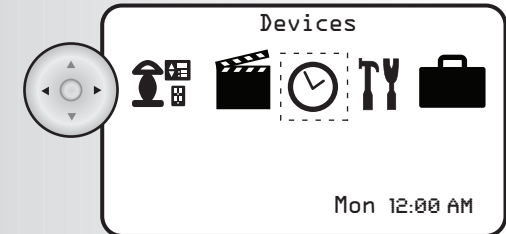

- **To select a menu item from a list,** use the up and down arrows to highlight your choice.

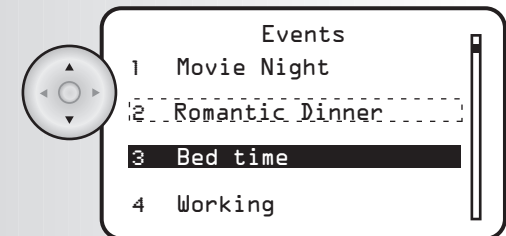

- **To go to the menu item you selected,** press the OK button located at the center of the arrow pad.

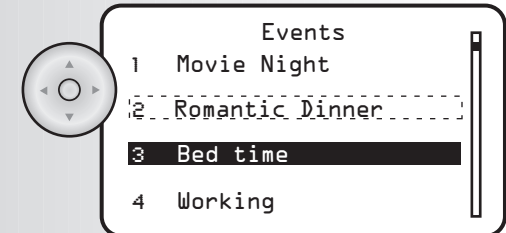

- **To exit to a menu screen and return to the previous menu,** press the Back button.

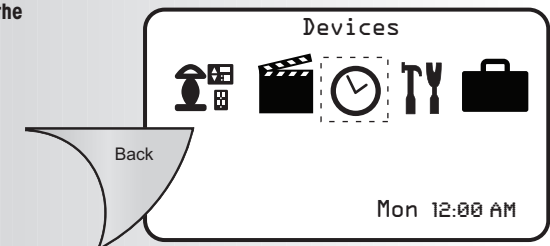

Creating Custom Names

Several features of the wireless system give the option to create custom names. More detailed instructions for each of these features is included in this manual. Here are some tips to introduce you to the process:

- **To find a letter when entering a name,** use the up and down arrows to scroll through a list containing the alphabet and a space key.

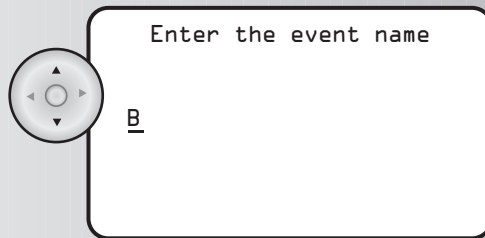

- **To save an entry,** press the right arrow once. The cursor will move one space to the right.

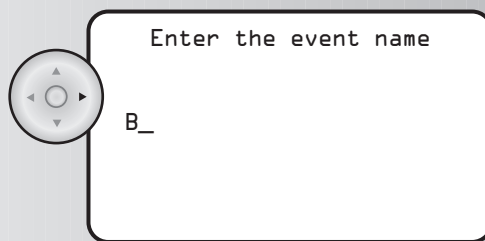

- **To enter a number instead of a letter (handheld controller only),** press the number on the number pad.

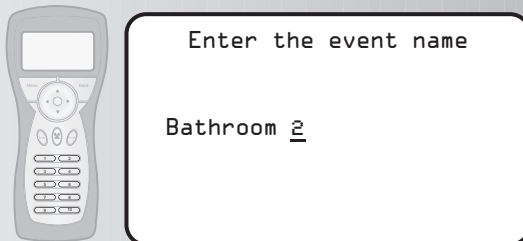

- **To enter a number instead of a letter (tabletop controller only),** press one of the Favorite Scene buttons. Use the up and down arrows to scroll through numbers.



- **To erase the previous letter or number,** press the left arrow once.

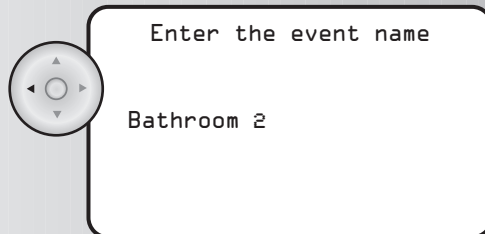

Installing a Device

The wireless control system can be programmed to direct up to 232 individual devices (Handheld/Tabletop is one of the 232 devices). After reviewing this section, you will be able to perform the following basic functions:

- Installing a Device
- Checking Device Status
- Renaming a Device
- Configuring a Device
- Activating Individual Devices
- Activating ALL ON and ALL OFF
- Controlling Devices
- Controlling the Thermostat
- Customizing All Switch
- Activating Panic Mode
- Customizing Panic Group

1. Select the "Install" option from the Devices menu. Press the OK button (Located at the center of the arrow pad).

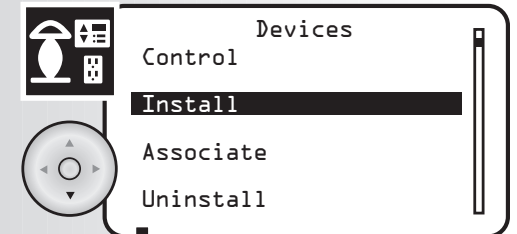

2. Press the Install button on the device. The installation process will last thirty seconds. If you want to end the installation process, press the Back button on your controller during the waiting period.

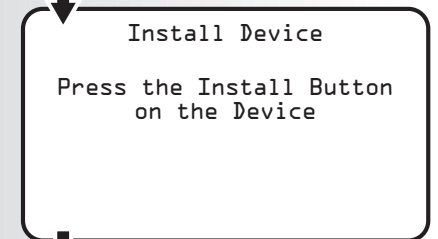

3. When the installation process has completed, the controller will assign a name to the device.

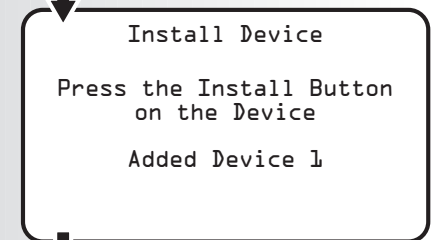

- **If the device is a Cooper Wiring product,** the name is read from the device. The device will automatically be added to the All Switch and Away groups of the wireless system. (See pages XX to learn more about these features.)

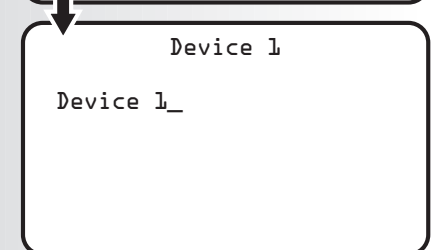

- **If the device is not a Cooper Wiring product,** the controller will assign a default name based on the generic class of the device. The device cannot be assigned to the All Switch and Away groups of the system.

Configuring a Device (for compatible products only)

All Cooper Wiring devices share common configuration options. You can select your preferred configuration for each device on your system. The configuration options available are as follows:

- Off Delay
- Panic On Time
- Panic Off Time
- Power On State

1. Select the "Configure" option from the Devices menu. Press the OK button.

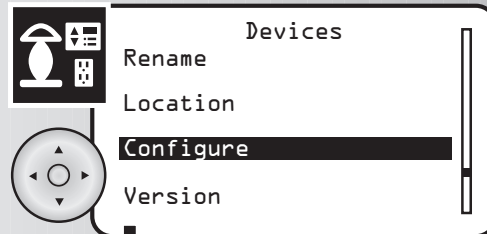

2. Highlight the location of the device that you would like to configure. Press the OK button.



3. Highlight the specific device that you would like to configure. Press the OK button.

! If you attempt to configure a device not manufactured by Cooper Wiring, an error message will appear. After two seconds, you can press the Back button to return to the configuration menu.

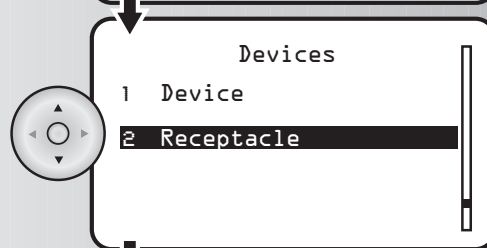

4. Highlight Off Delay and press the OK button to select it. This feature allows gives the user time to leave a room before the light turns off. To activate Off Delay, press and hold the dimmer switch. The LEDs on the device will flash until the desired amount of Off Delay time passes.

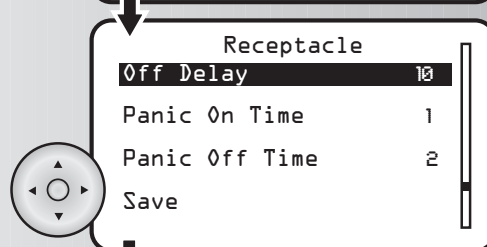

5. Checkmarks indicate the Off Delay time. Using the arrow pad, highlight your preferred Off delay time (in seconds). Press the OK button to select the time.

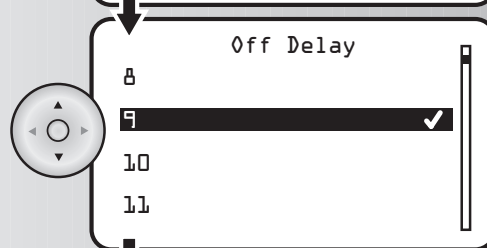

Configuring a Device (for compatible products only) (continued)

6. Highlight Panic Off Time and press the OK button to select it.

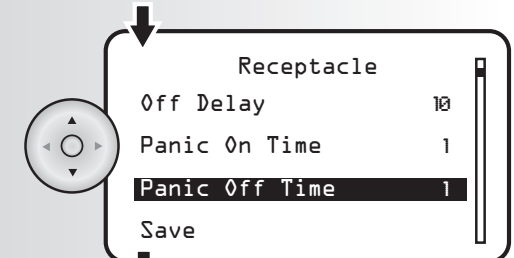

7. Checkmarks indicate the Panic Off Time. Using the arrow pad, highlight your preferred Panic Off Time (in seconds). Press the OK button to select the time. Repeat this for the Panic On Time.

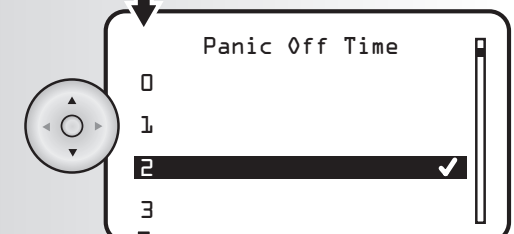

8. Highlight Power On State and press the OK button to select it. The Power On state defines what state the device powers up into when power is applied.

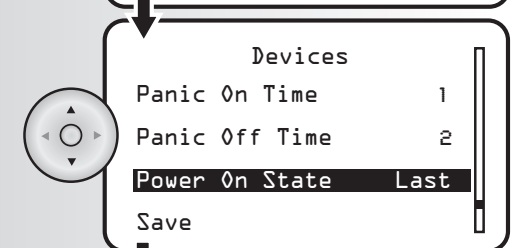

9. Checkmarks indicate the Power On State. Using the arrow pad, highlight your preferred Power On State. Press the OK button to select the desired Power On State.

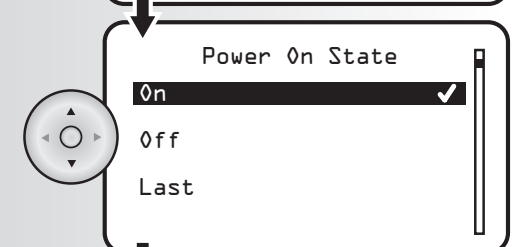

10. Press the Menu button to Save the Device Configuration. A window will display a message saying the Device was updated.

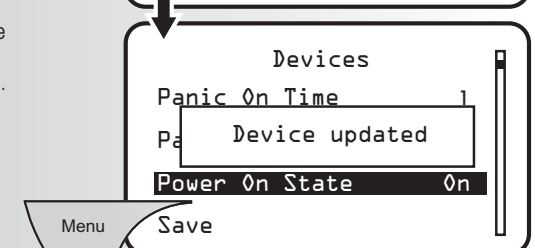

Activating Individual Devices

1. Select the "Control" option from the devices menu. Press the OK button.

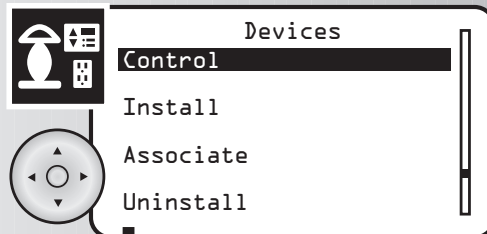

2. Highlight the location of the device you want to activate. Press the OK button.



3. To turn a device on or off, highlight the device. Press the OK button. This can also be done by pressing the ALL ON button to turn the device on and by pressing the ALL OFF button to turn the device off.

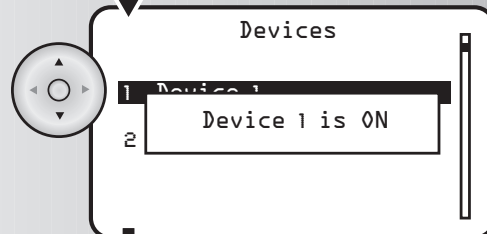

4. For dimmer control, highlight the device then use the ALL ON and ALL OFF buttons. A window will display the dim level from 0% to 100% .

To increase the brightness level, press and hold the ALL ON button on the controller. Release the ALL ON button when desired dim level is reached.

To decrease the brightness level, press and hold the ALL OFF button on the controller. Release the ALL ON button when desired dim level is reached.

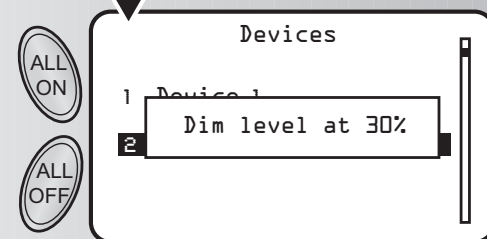

Checking Device Status

1. Select the "Device Status" option from the devices menu. Press the OK button.

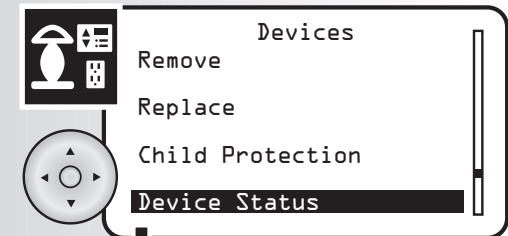

2. Select the location of the device(s) that you are checking. Press the OK button.

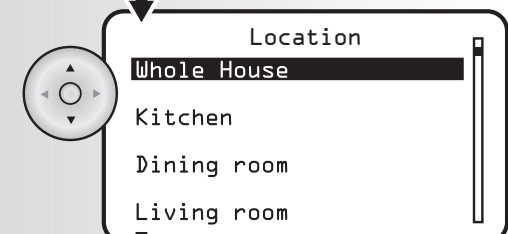

3. Scroll through the menu, allowing a few seconds for the system to fetch the device state for each device.



Renaming a Device

1. Select the "Rename" option from the devices menu. Press the OK button.

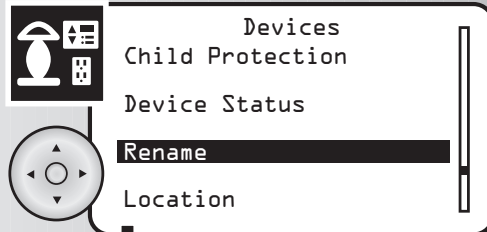

2. Highlight the location of the device that you would like to rename. Press the OK button.



3. Highlight the specific device that you would like to rename. Press the OK button.

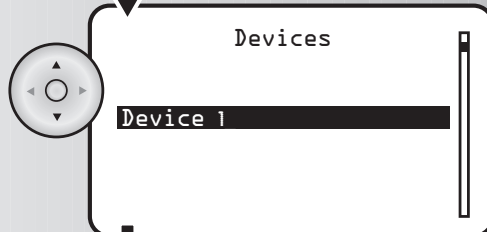

4. Using the arrow pad, enter the new name for the device. Press the OK button to save the new name.

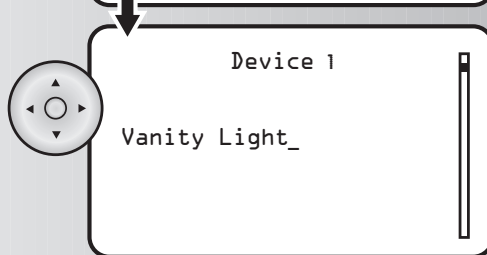

Activating Individual Devices (Using the Handheld Controller)

Each device is automatically renumbered after it is installed. You can use your handheld controller's number pad to quickly access and activate any device installed in the wireless control system.

1. Using the number pad on the handheld controller, select the number of the device you want to activate.

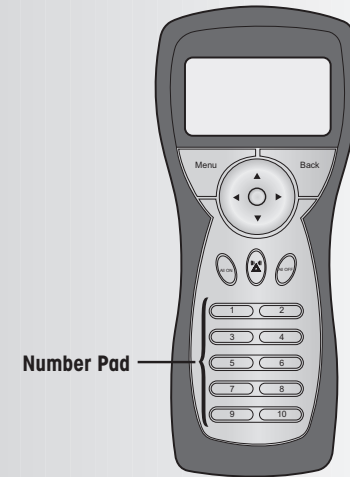

2. **To increase the brightness level**, press and hold the ALL ON button on the controller. Release the ALL ON button when desired dim level is reached.



- To decrease the brightness level**, press and hold the ALL OFF button on the controller. Release the ALL OFF button when desired dim level is reached.



Activating ALL ON

1. Press the ALL ON button on the controller. All of the devices that are part of the ALL ON group will turn on. Each device can be programmed to be included with the ALL ON command.

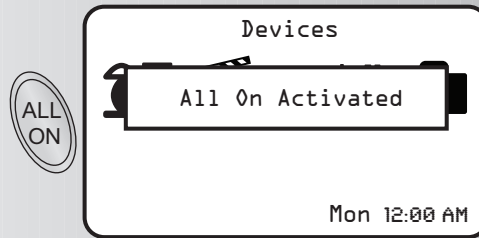

Activating ALL OFF

1. Press the ALL OFF button on the controller. All of the devices that are part of the ALL OFF group will turn off. Each device can be programmed to be included with the ALL OFF command.

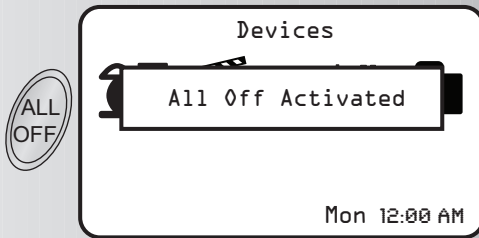

Controlling Devices

The control menu allows devices to be operated in a specific manner. When a device is entered into the network, information is retrieved from the device and stored in the wireless control system. The amount and type of information retrieved determines the extent to which the device can be controlled by the controller.

The system may not recognize all controls for some devices. If you try to select a device that is not controllable in a specific way, a pop-up window will appear with an error message. The pop-up window can be cancelled using the Back key, or simply wait two seconds for the message to automatically disappear.

Below are some examples of devices, their generic/specific type, and the resulting functionality with your system.

Device	Generic/Specific Type	Functionality
Binary Switch	None/Binary Switch, Binary Switch/Binary Switch, Binary Power Switch/Binary Switch	On button turns switch ON and off button turns switch OFF.
Multilevel Switch	None/Multilevel Switch, Multilevel Power Switch/Multilevel Power Switch	On button turns switch ON and off button turns switch OFF. ON button held down brightens switch. OFF button held down dims switch.
Toggle Switch Remote Switch	None/Basic, Binary Toggle Switch/Binary Toggle Binary Toggle Remote Switch/Binary Toggle	Both on and off buttons toggle switch.
Toggle Switch Remote Switch	Multilevel Toggle Switch/Multilevel Toggle Switch Multilevel Toggle Remote Switch/Multilevel Toggle	Both on and off buttons toggle switch. Both buttons held down toggle switch.
Remote Switch	None/Basic, Binary Remote Switch/Binary Switch	On button turns switch ON and off button turns switch OFF.
Remote Switch	Multilevel Remote Switch/Multilevel Switch	On button turns switch ON and off button turns switch OFF. ON button held down brightens switch. OFF button held down dims switch.
Entry Control	None/Lock, Door Lock/Lock	On button activates lock and off button deactivates.
Semi Interoperable	Ignore/Basic	On button activates and off button deactivates.
Window Covering	None/Basic, Simple Window Covering Control/Basic Window Covering	On button opens window covering and off button closes window covering.
Remote Controller, Static Controller, Repeater Slave, Binary Sensor, Multilevel Sensor, and Pulse Meter		No functionality available.

Do we need this?

Note from Loudwater—I'm not sure you'd want to have this table shown to a user. It's very ZWave specific. I think you need to ask Cooper and Zensys on this.

Controlling A Thermostat

A thermostat is not directly controllable with the on and off buttons because the device requires control of multiple points. You may have to follow additional steps to install and control this device within the network of the wireless control system.

In the Control Menu

If your thermostat is supported by the wireless network, the screen will display the available options once the device is selected.

Since each manufacturer offers different options, you may have to query the thermostat device to get the specific features supported by your wireless control system. *(DO YOU WANT TO LIST THESE INSTRUCTIONS?)*

When the wireless control system receives correct features from the thermostat device, you can change the settings that appear within the display window.

Use the arrow keys to scroll through the list of features. When the feature you would like to adjust is highlighted, use the numeric keypad on your controller to enter new values for the thermostat.

In some cases, the fan mode is also supported by the thermostat device. The display will offer the option to select fan mode and enter another window to make adjustments.

Do we need this?

Note from Loudwater—The Handheld/Tabletop does not at the moment support thermostats.

Customizing All Switch (for compatible devices only)

The All Switch feature allows you to select a group of devices that will or will not be triggered when the user presses the ALL ON and ALL OFF buttons.



1. Select the "All Switch" option from the Devices menu. Press the OK button.
2. Highlight the location of the device that you would like to customize. Press the OK button.
3. Highlight the specific device you would like to customize. Press the OK button.
4. Checkmarks indicate the current all switch settings. Using the arrow pad, highlight your preferred level of functionality. Press the OK button to select or deselect the function.

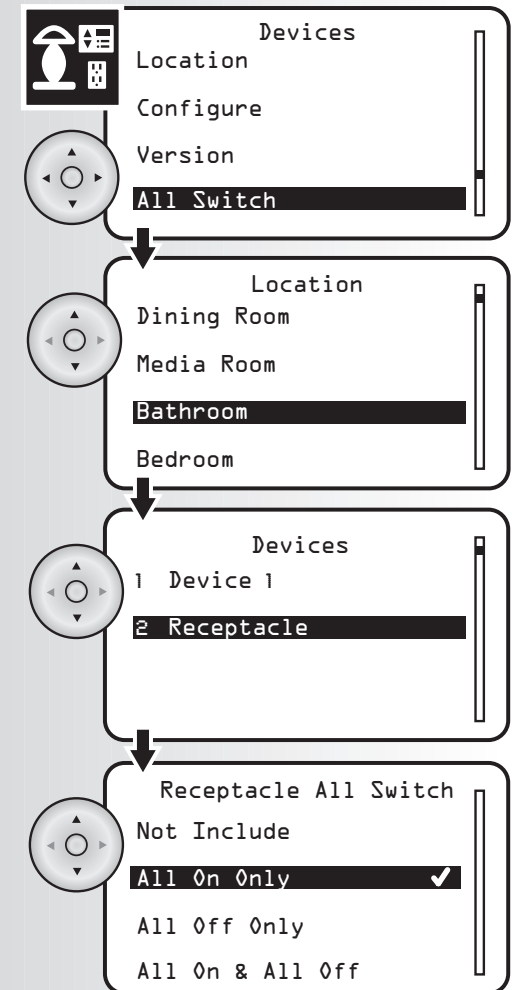

5. To save the changes, press the Menu button.
6. Repeat Steps 2-4 to customize other devices.

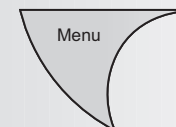

Activating Panic Mode

Panic mode allows the user to trigger a group of devices to turn off and on in a pattern that attracts attention.

1. Press the Panic button on the handheld or tabletop controller.
2. When ready to exit panic mode, press the Panic button again.



Customizing Panic Group (for compatible devices only)

Use this feature to select the group of devices you want included or excluded when you press the Panic button.

1. Select the "Panic" option from the Settings menu. Press the OK button.

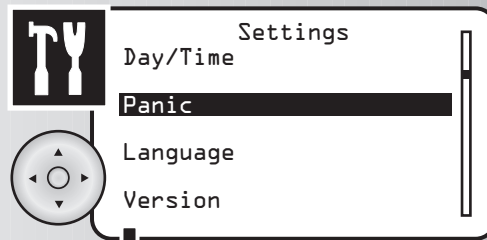

2. Checkmarks indicate the current panic group settings. Using the arrow pad, highlight your preferred level of functionality.

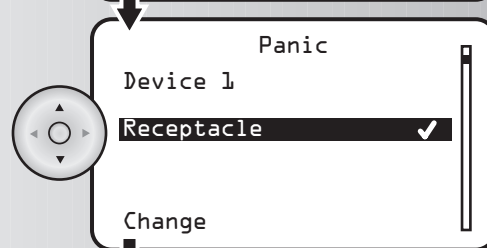

3. To remove a device from the panic group, highlight the device and press the Menu button. The checkmark will be removed.

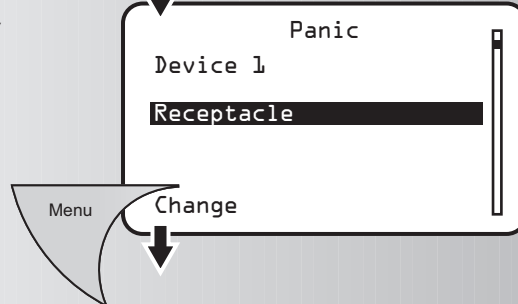

Customizing Panic Group (continued)

To add a device to the panic group, highlight the device and press the Menu button. A checkmark will appear next to the device.

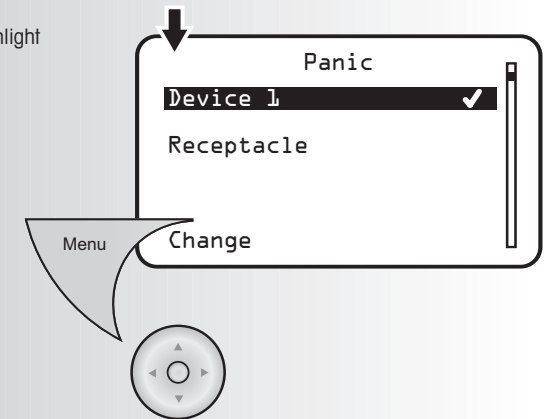

3. To save changes, press the OK button.

Creating a Scene

A scene is a combination of lighting or appliance devices selected by the user that can be controlled as a group by the wireless system. Now that you've installed devices into the system, you can program your controllers to create and control scenes in your home. After reviewing this section, you will be able to perform the following basic functions:

- Creating a Scene
- Activating a Scene
- Creating Favorite Scenes
- Renaming a Scene
- Renumbering a Scene
- Deleting a Scene
- Editing a Scene

1. Select the "Create" option from the Scenes menu. Press the OK button.

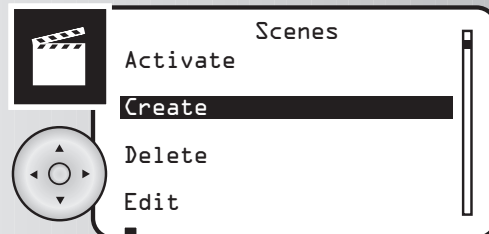

2. Using the arrow pad, enter a name for the scene.

To use one of the system's pre-programmed scene names, press the up arrow and scroll through the options until you find the desired name. Press the OK button to save.

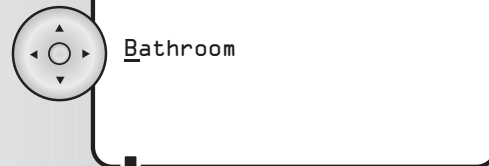

If you want another name, press the down arrow once. Scroll through the alphabet until you find the first letter of the name. When the letter appears, press the right arrow and continue the process until the name is spelled out. Press the OK button to save.

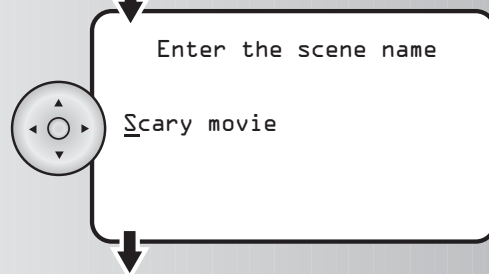

Creating a Scene (continued)

3. Highlight the specific device that you would like in the scene and press the OK button.

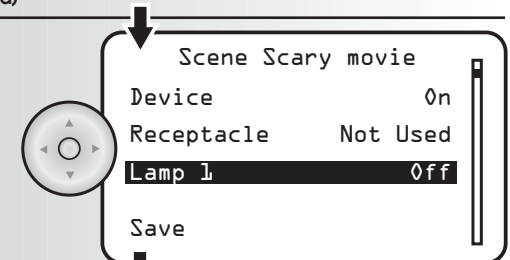

4. Highlight one of four setting options for the device: Not used, On, Off, or a specific light level. Press the OK button.

To select a specific light level, you can select a percentage from 0% to 100%. Use the up and down arrows to enter the number. Press the OK button when finished. (If a device does not allow a specific light level, you will receive a window showing an Error message.)

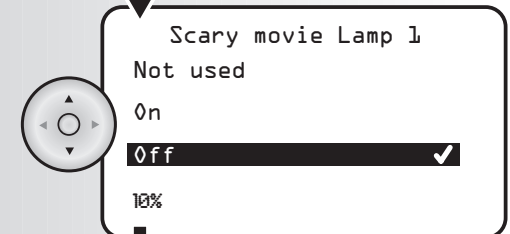

5. Repeat Steps 3-5 for all devices within the scene.

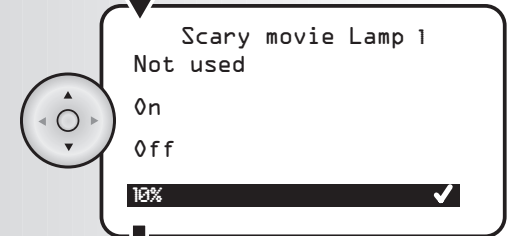

6. To save the scene, press the Menu button.

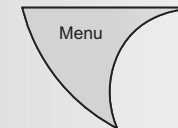
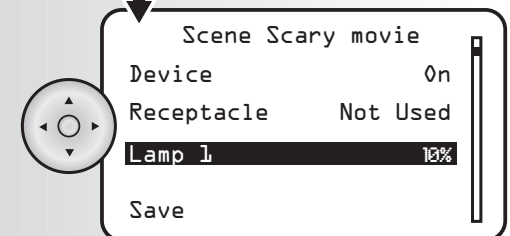

Activating a Scene

1. Select the "Activate" option from the Scenes menu. Press the OK button.

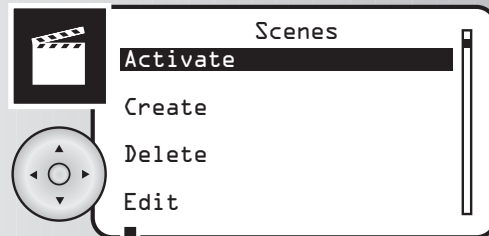

2. Highlight the scene you want to activate. Press the OK button.



3. When activation is complete, a window will display a message saying whether or not the operation was successful and you will return to the Scenes menu.

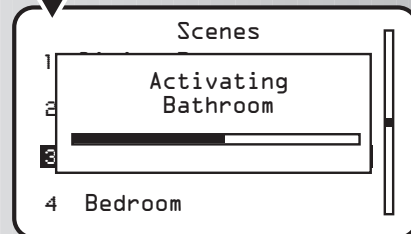

Creating Favorite Scenes

The tabletop controller's main menu is a scene screen where eight of your favorite scenes can be accessed directly. You will have easy one-touch control.



1. Select the "Favorites" option from the Scenes menu. Press the OK button.

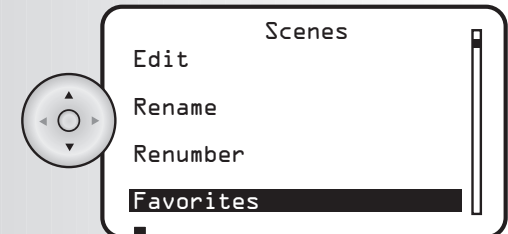

2. Highlight the number that you would like to assign to your favorite scene. Press the OK button.

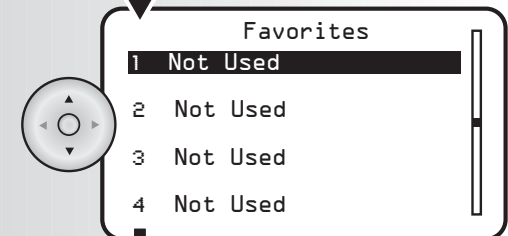

3. Highlight your favorite scene. Press the OK button.

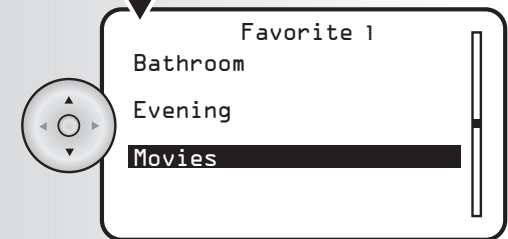

Renaming a Scene

1. Select the "Rename" option from the Scenes menu. Press the OK button.

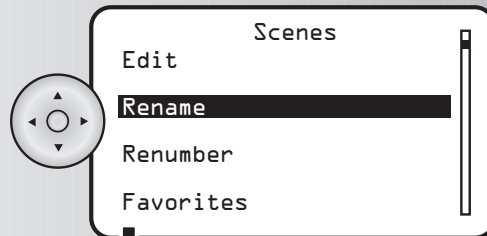

2. Highlight the scene to be renamed. Press the OK button.

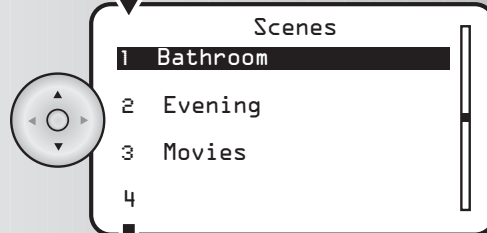

3. Using the arrow pad, input the new scene name. Press the OK button.

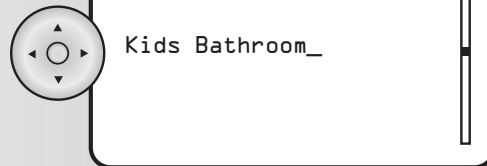

Renumbering a Scene

This feature allows the user to reorder the scenes displayed on the selection menu.

1. Select the "Renumber" option from the Scenes menu. Press the OK button.

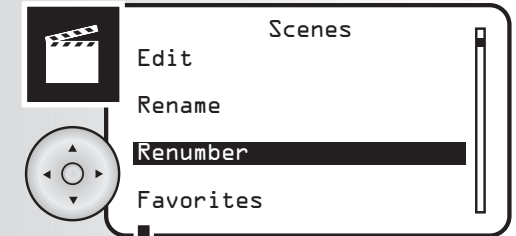

2. Highlight the scene to be renumbered. Press the OK button.

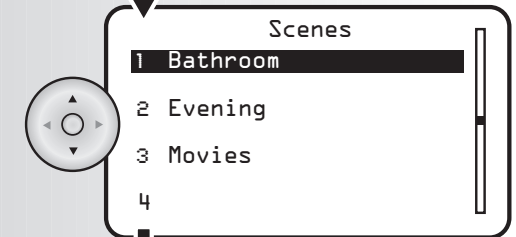

3. A checkmark will appear next to the current number of the scene. Using the arrow pad, move the checkmark next to the new number for the scene. Press the OK button.

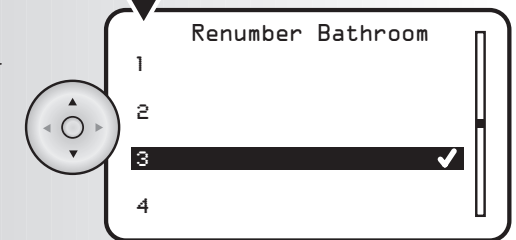

Deleting a Scene

1. Select the "Delete" option from the Scenes menu. Press the OK button.

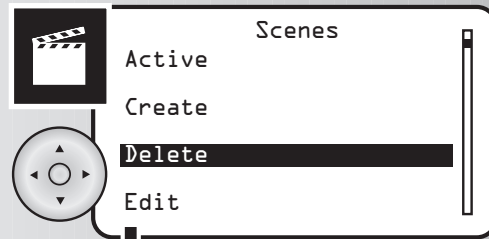

2. Highlight the scene to be deleted. Press the OK button.

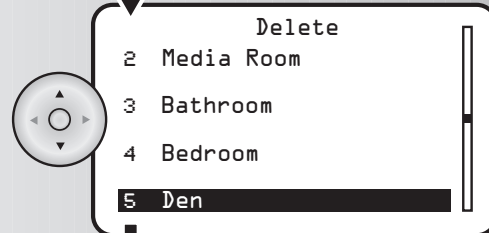

3. When the scene is deleted, a window will display a message saying the operation was successful.

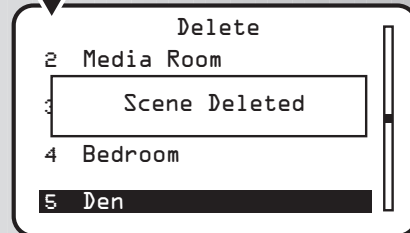

Editing a Scene

1. Select the "Edit" option from the Scenes menu. Press the OK button.

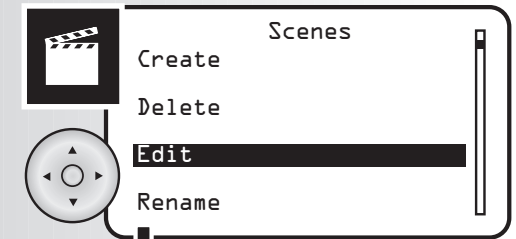

2. Highlight the scene to be edited. Press the OK button.

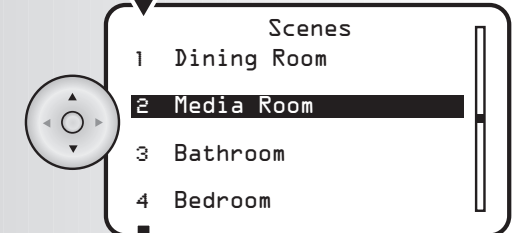

3. You will go to a screen detailing the device status for the selected scene. Press the OK button.

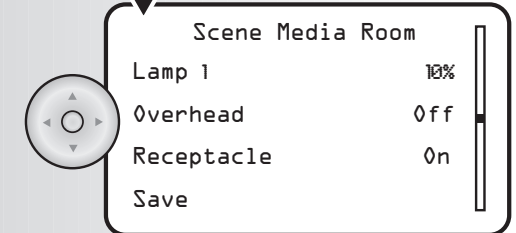

4. You will go to a screen detailing the existing settings for the selected scene. Follow steps 5-7 described on Page XX's Creating a Scene to make and save your changes.

Transferring Scene

1. Select the "Transfer" option from the Scenes menu. Press the OK button.

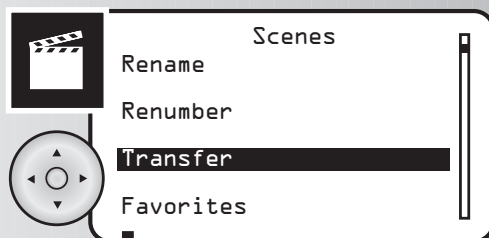

2. Highlight the scene to be transferred. Press the OK button.

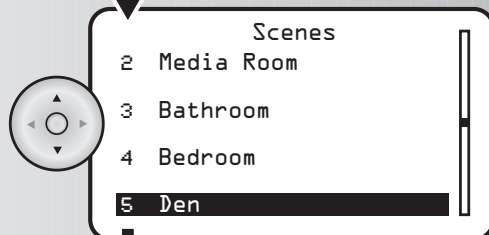

3. Press and hold the desired scene button on the Cooper scene controller. A LED on the Scene Controller will flash when it is receiving information

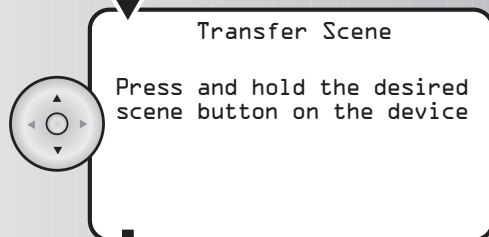

4. When the transfer is complete, a window on will display a message saying whether or not the operation was successful.

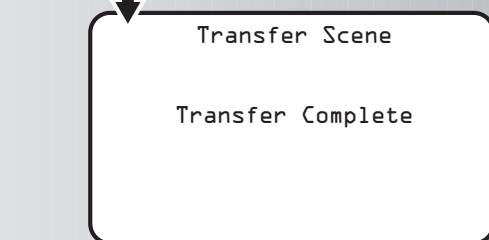

Creating an Event

An event is a scheduled one-time or recurring program that automatically controls a combination of lighting or appliance devices for a desired period of time. You can program your controllers to create and control events in your home. After reviewing this section, you will be able to perform the following basic functions:

- Creating an Event
- Activating and Deactivating an Event
- Activating or Deactivating All Events
- Renaming an Event
- Deleting an Event
- Editing an Event

1. Select the "Create" option from the Events menu. Press the OK button.

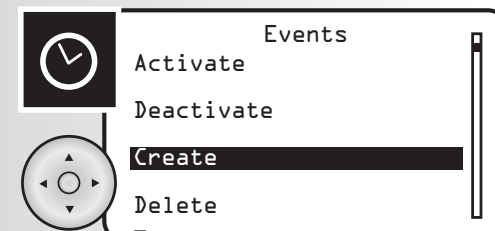

2. Using the arrow pad, enter a name for the event. Scroll through the alphabet until you find the first letter of the event name. When the letter appears, press the right arrow and continue the process until the name is spelled out. Press the OK button to save.

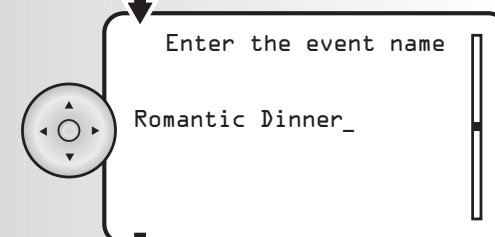

3. Scroll through the menu to view the setting options for the event: Time, Day, Type, Scene, and Active.



To create the time, highlight "Time" and press the OK button.

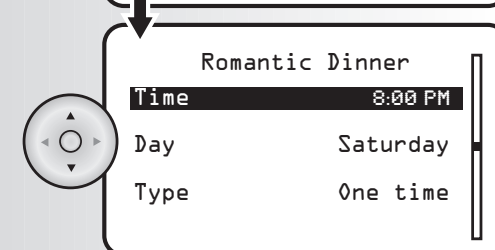

Creating an Event (continued)

Using the arrow pad, enter the correct time.
Press the OK button to save.

Romantic Dinner
Time 8:30 PM
Day Saturday
Type One time

To create the day, highlight "Day" and
press the OK button.

Romantic Dinner
Time 8:30 PM
Day Saturday
Type One time

Using the arrow pad, highlight the day of the
week for the event. Press the OK button to
save.

Romantic Dinner Day
Thursday
Friday ✓
Saturday
Sunday

To create the type, highlight "Type" and
press the OK button. You can make your
event a one-time or recurring event with this
setting.

Romantic Dinner
Day Friday
Type One time
Scene Dining Room
Save

Using the arrow pad, highlight "One Time" or
"Recurring". Press the OK button to save.

Romantic Dinner Type
One Time
Recurring ✓

Creating an Event (continued)

To select the scene, highlight "Scene" and
press the OK button.

Romantic Dinner
Type One time
Scene Dining Room
Active No
Save

You will see a list of existing scenes in your
system. Using the arrow pad, highlight the
desired scene for the event. Press the OK
button to save.

Romantic Dinner Scene
Bedroom
Kitchen ✓
Basement
Porch

4. To save the scene, press the Menu button.

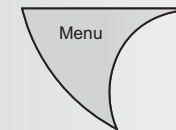

Activating or Deactivating an Event

1. Select the "Activate" or "Deactivate" option from the Events menu. Press the OK button.

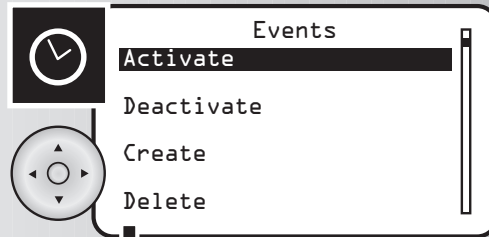

2. Highlight the event to activate or deactivate. Press the OK button.

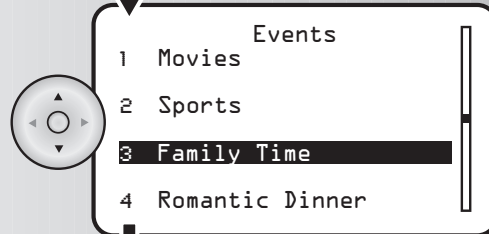

3. When the activation or deactivation is complete, a window will display a message saying the operation was successful.

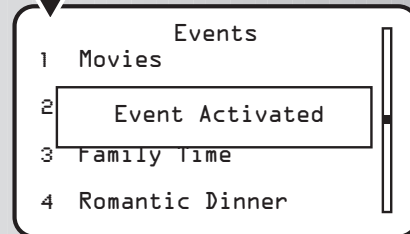

Activating or Deactivating All Events

1. Select the "Activate All" or "Deactivate All" option from the Events menu. Press the OK button.

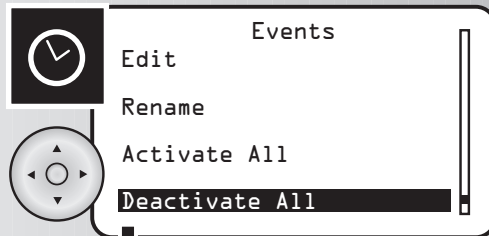

2. When the activation or deactivation is complete, a window will display a message saying the operation was successful.

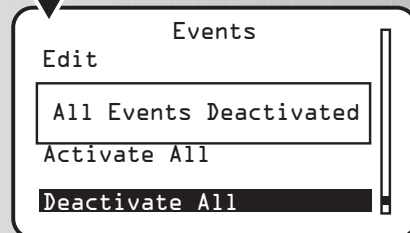

Renaming an Event

1. Select the "Rename" option from the Events menu. Press the OK button.

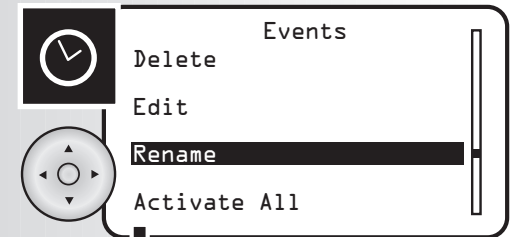

2. Highlight the event to be renamed. Press the OK button.

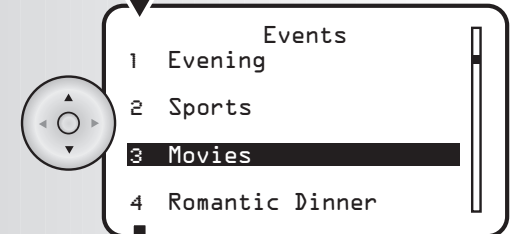

3. Using the arrow pad, input the new event name. Press the OK button to save.

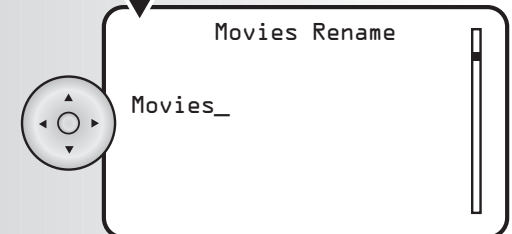

Deleting an Event

1. Select the "Delete" option from the Events menu. Press the OK button.

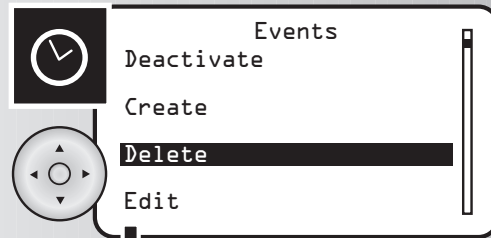

2. Highlight the event to be deleted. Press the OK button.



3. When the event is deleted, a window will display a message saying the operation was successful.

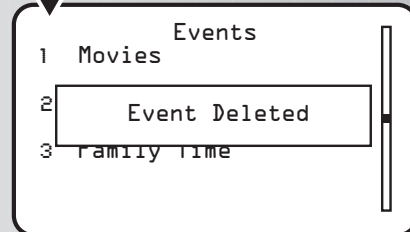

Editing an Event

1. Select the "Edit" option from the Events menu. Press the OK button.

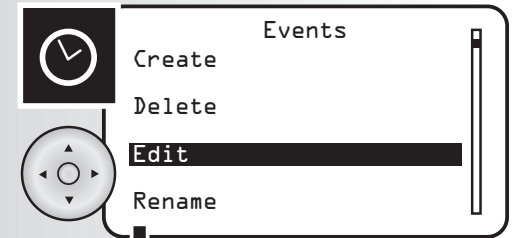

2. Highlight the event to be edited. Press the OK button.

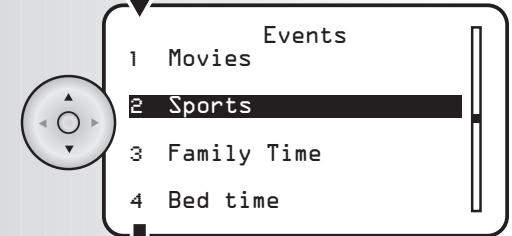

3. A screen detailing the existing options for the selected event will be displayed. Follow steps 3-4 described on Pages 29-31 to make and save your changes.

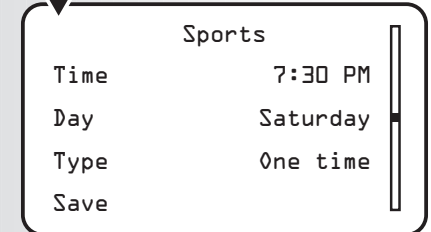

Editing the Away Feature

The away menu allows the user to edit and control a group of devices that will be randomly controlled to give the impression that the house is still occupied during the absence of its residents. After reviewing this section, you will be able to perform the following functions:

- Editing the Away Feature
- Activating or Deactivating the Away Feature

1. Select the "Edit" option from the Away menu. Press the OK button.

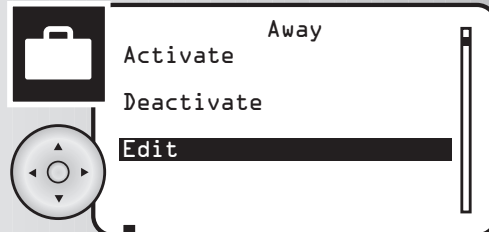

2. Highlight the "Start" option to program the time when the Away mode will begin. Press the OK button.

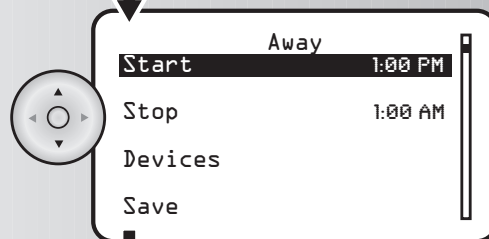

3. Using the arrow pad, enter the start time. Press the OK button to save.

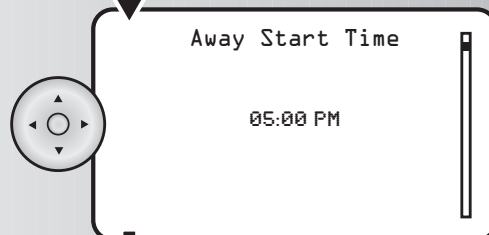

4. Highlight "Stop" to program the time when the Away feature will be deactivated. Press the OK button.

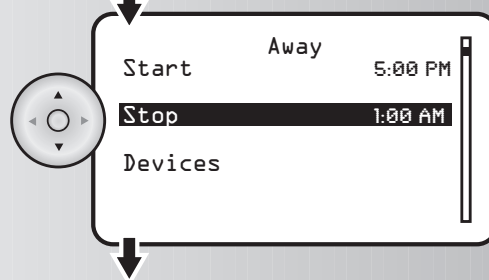

Editing the Away Feature (continued)

5. Using the arrow pad, enter the stop time. Press the OK button to save.

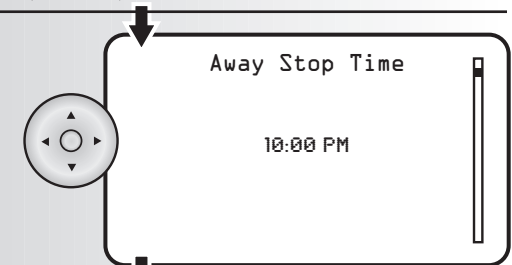

6. Highlight the "Devices" option to select the devices to be included in the away mode.

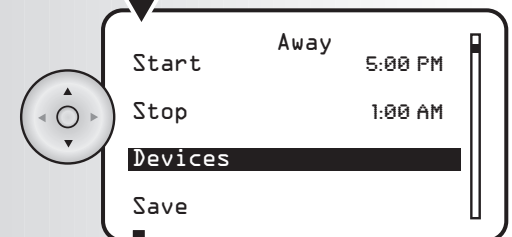

7. Scroll through the list of devices. Highlight and press the OK button to select a device.

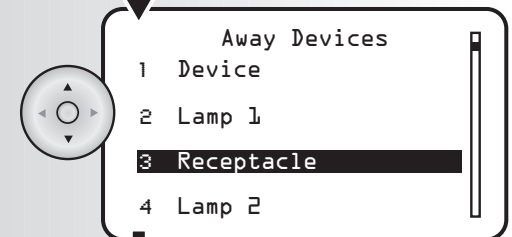

8. Highlight "Included" and press the OK button.

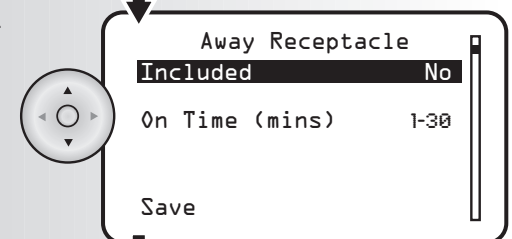

9. Using the arrow pad, highlight "Yes" or "No". Press the OK button to save.

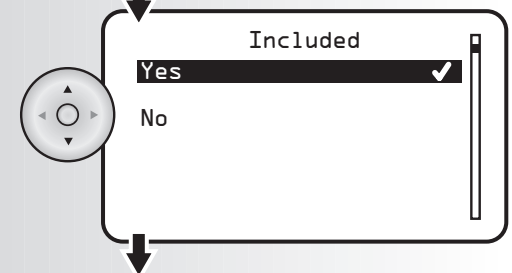

Editing the Away Feature *(continued)*

10. Highlight "On Time (mins)" and press the OK button.

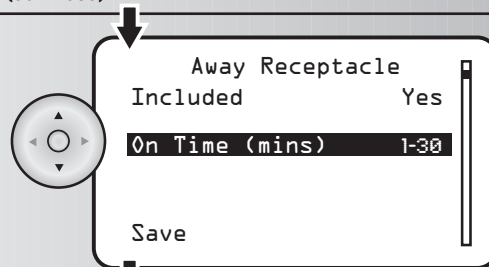

11. Using the arrow pad, highlight the desired on time. Press the OK button to save.

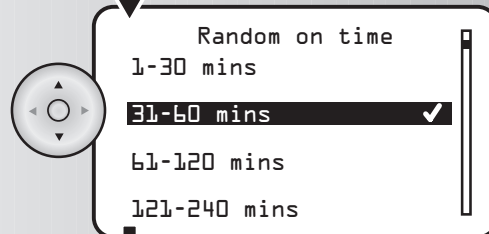

12. To save the scene, press the Menu button. A window will display a message saying the device was updated.

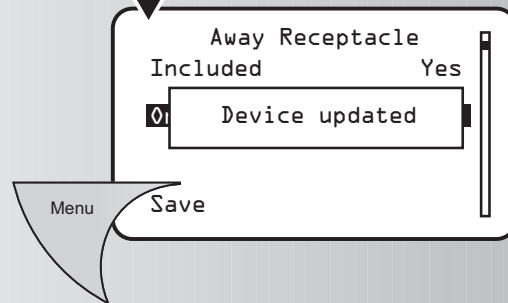

Activating or Deactivating the Away Feature

1. Select the "Activate" or "Deactivate" option from the Away menu. Press the OK button.

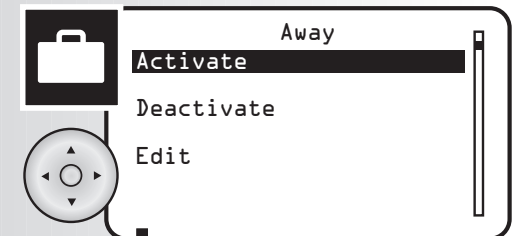

2. When activation or deactivation is complete, a window will display a message saying whether or not the operation was successful.

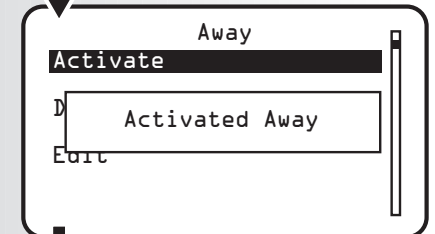

3. When the away feature is activated, the away icon on the main menu will show a checkmark.

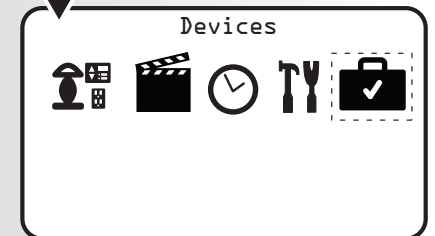

After learning about the basics of your wireless control system, you may want to make further changes to the system. In this section, you will learn to perform these additional functions:

- Creating an Association Between Devices
- Replicating Handheld Information to a Second Receiver
- **Selecting a New Primary Controller [Is this Supported?]**
- Uninstalling a Device
- Resetting the System

Creating an Association Between Devices

An association is a feature that you can program to allow a device in your system (source device) to control another device (destination device). Your Aspire RF wireless system supports up to five associations for each source device.

1. Select the "Associate" option from the Devices menu. Press the OK button.

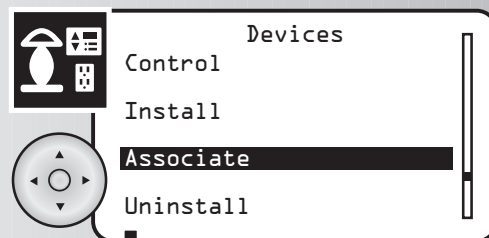

2. Highlight the location of the device that you would like to associate and press the OK button.

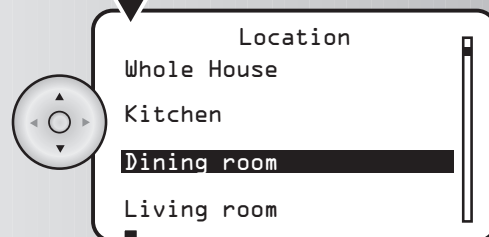

3. Highlight the specific device that you would like to associate and press the OK button.

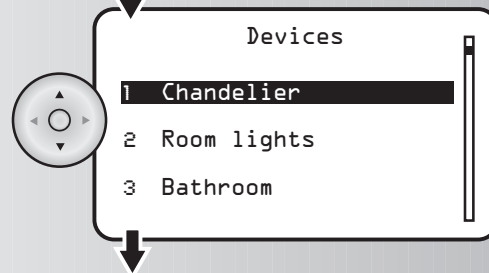

Creating an Association Between Devices (continued)

4. When selected, the handheld will fetch the association information from the device and then display a list of devices.

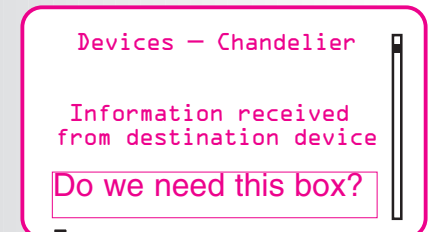

5. Using the arrow pad, highlight the desired device. A checkmark indicates associated devices. Press the Menu button Associate or Disassociate a device.

Note: The device does not have to have its button pressed in order to be associated. [Is this note needed?]

Is this correct?

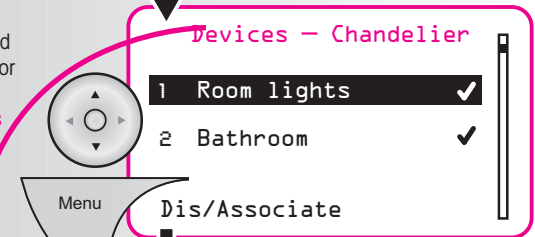

6. To save the association, press the OK button.

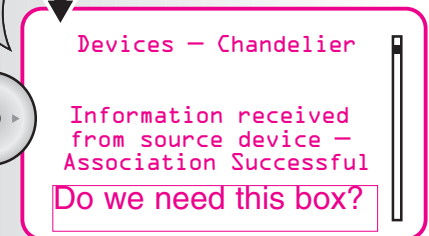

Replicating Handheld Information to a Second Receiver

Replication allows you to duplicate the information from one controller (primary) to another controller (secondary). The primary controller is the only controller capable of adding devices to the network.

Replication can include device information or complete network information (everything including events and scenes).

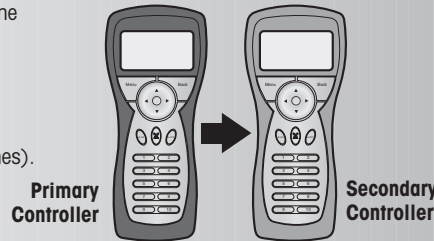

1. On both controllers, select the Replicate option from the Settings menu. Press the OK button.

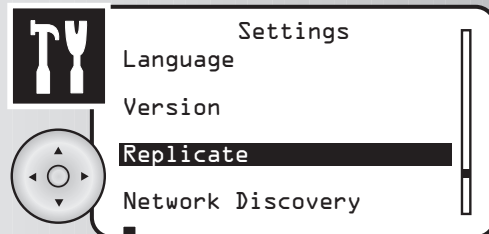

2. On both controllers, highlight one of two replicate options: "Network Only" (devices only) or "Complete Replicate" (also includes events and scenes). Press the OK button.

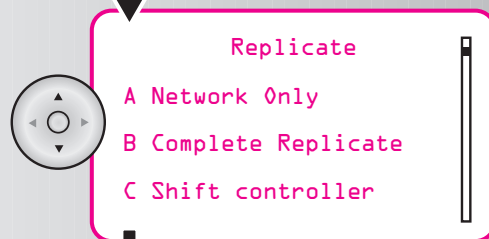

3. Prepare both controllers for the replicate process.

On the primary controller, use the arrow pad to highlight "Send". Press the OK button.

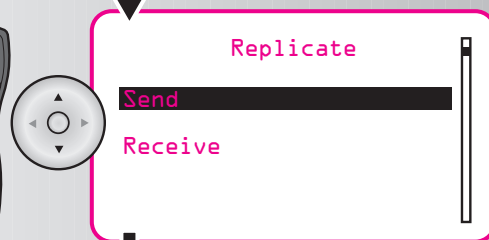
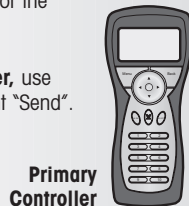

Loudwater says
Replication is up in the air at the moment. Controller shift and Network Only aren't there but they may be in the coming weeks

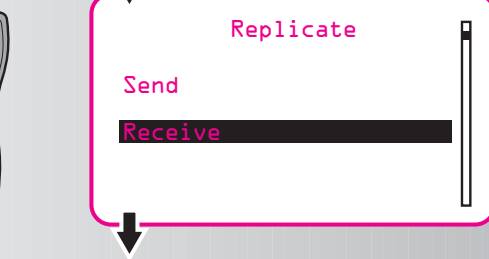

Replicating Handheld Information to a Second Receiver

4. When the replication is complete, windows on both controllers will display a message saying whether or not the operation was successful.



Selecting a New Primary Controller

The replicate function also allows a shifting of the primary controller to become the secondary controller.

1. On the primary controller, select the "Replicate" option from the Settings menu. Press the OK button.

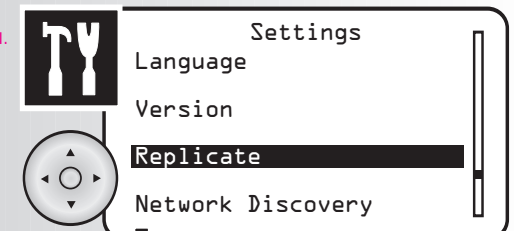

2. On the primary controller, highlight "Shift controller" on the Replicate menu. Press the OK button.

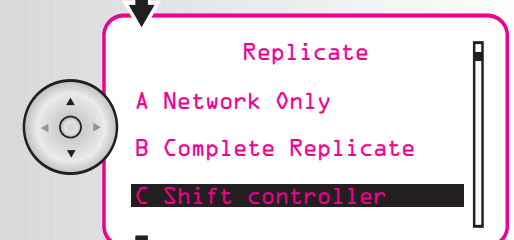

3. Need direction on what happens next.



Do we need this? Does this work for the Tabletop?

Note from Loudwater—The handheld does not support selecting a new primary controller yet

Uninstalling a Device

Before uninstalling a device, the device must be installed in the wireless system. If you receive an "Unknown device" error message during this operation, the device is not installed in your system.

1. Select the "Uninstall" option from the Devices menu. Press the OK button.

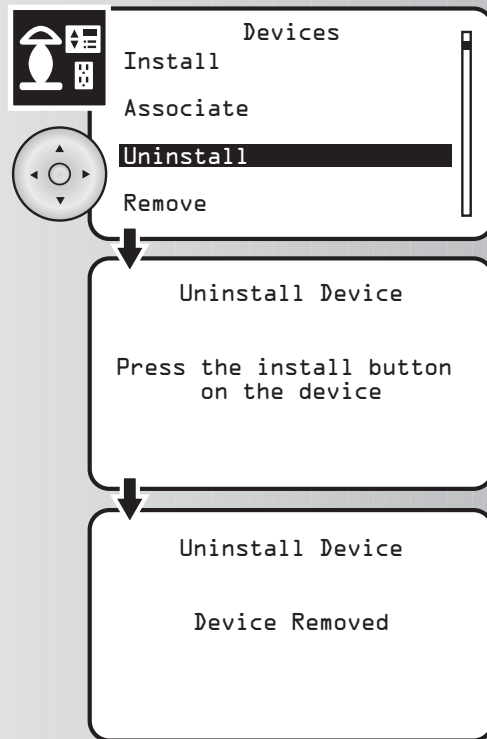

2. Press the Install button on the device that you want to uninstall.

The process to uninstall the device will last several seconds.

If you don't want to install the device, press the Back button on the controller during the waiting period.

3. When the uninstall is complete, a window will display a message saying whether or not the operation was successful.

Resetting the System

This function allows you to clear your handheld controller of all devices, scenes, and events.

1. Select the "Reset" option from the Settings menu. Press the OK button.

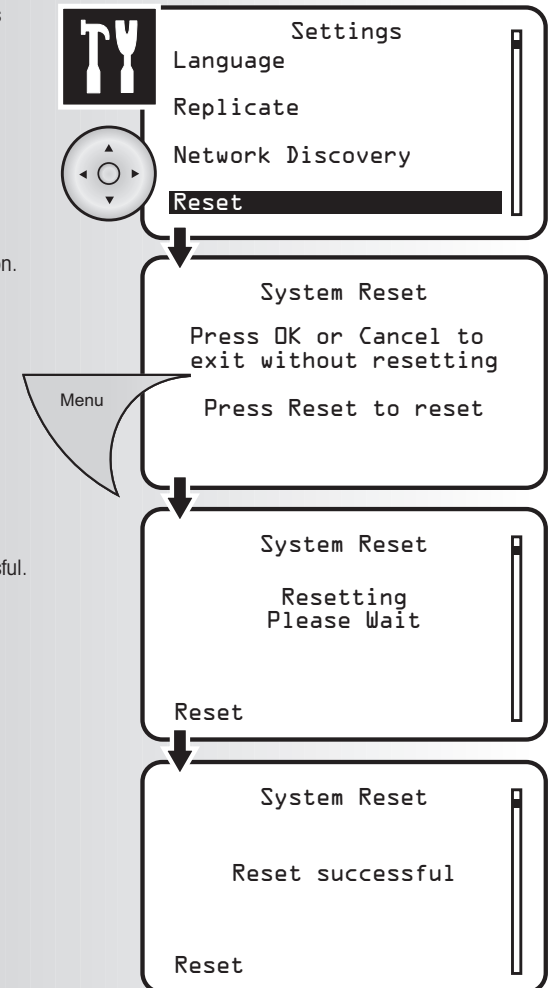

2. To reset the system, press the Menu button. The process to reset the system will last several seconds.

If you don't want to reset the system, press the Back button on the controller.

3. When the system reset is complete, a window will display a message saying whether or not the operation was successful.

The wireless control system has several functions that can be customized to meet individual needs. After reviewing this section you will be able to perform the following functions:

- Setting Current Day and Time
- Activating Child Protection
- Selecting a Language

Setting Current Day and Time

1. Select the "Day/Time" option from the Settings menu. Press the OK button.

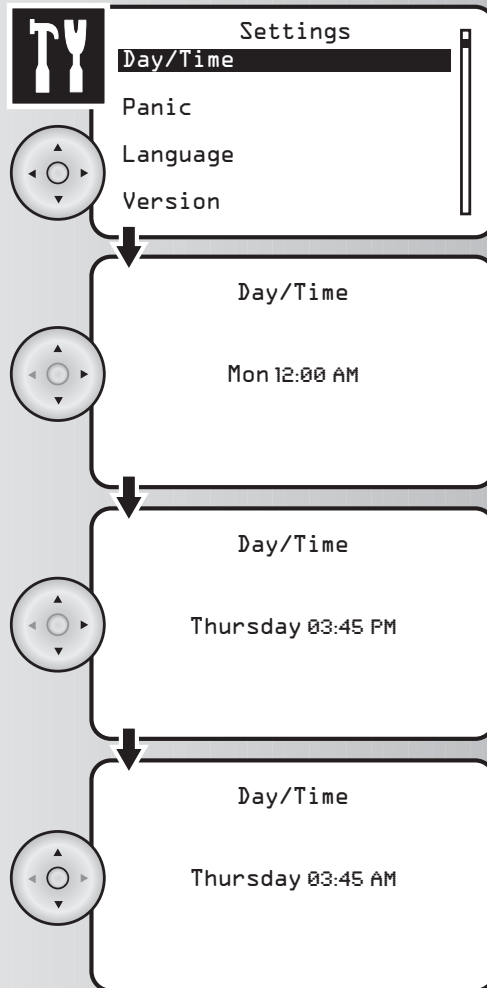

2. Use the up and down arrows to highlight the current day. When finished, press the right arrow to highlight the time.

3. Use the up and down arrows to highlight the current time. When finished, press the right arrow to highlight AM/PM.

4. Use the up and down arrows to highlight AM or PM. Press the OK button to save the current day and time.

Selecting a Language

1. Select the "Language" option from the Settings menu. Press the OK button.

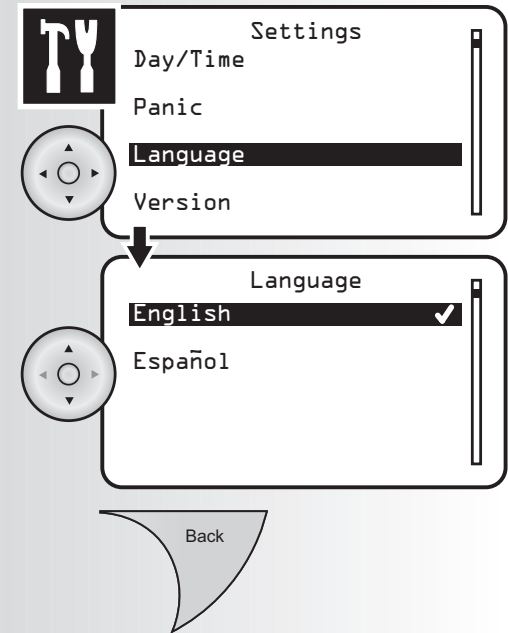

2. Using the arrow pad, highlight the preferred language and press the OK button. A checkmark will be displayed next to the selected language.

3. All text within the menu system will be displayed in the selected language. To return to the main menu, press the Back button.

Activating Child Protection

1. Select the "Child Protection" option from the Devices menu. Press the OK button.

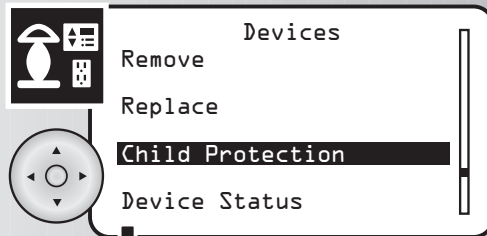

2. Highlight the location of the device for child protection. Press the OK button.



3. Highlight the specific device for child protection. Press the OK button.

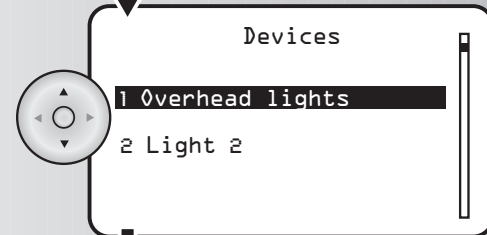

4. The current level of protection will be marked with a checkmark. If you want a different level, use the arrow pad to highlight one of the three available protection levels. Press the OK button.

If you want Unprotected, the device will not be protected.

If you want Sequence control, two or more devices can be controlled in consecutive order.

If you want Remote control, the device will only be controlled by the local controller.

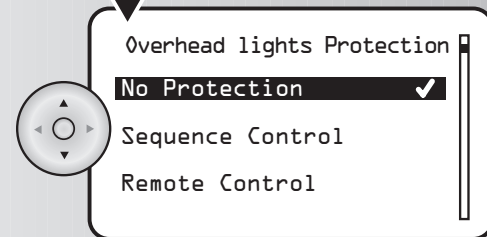

5. To confirm changes, wait for a pop-up window to display "Device updated."

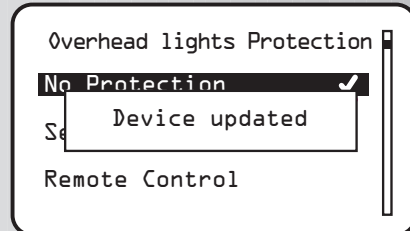

You may encounter some problems while using your wireless control system. Use this section to learn about the following functions:

- Retrieving Version Information about your System
- Retrieving Version Information about Individual Devices
- Removing a Failed Device
- Replacing a Failed Device
- Operating Network Discovery

Retrieving Version Information about your System

1. Select the "Version" option from the Settings menu. Press the OK button.

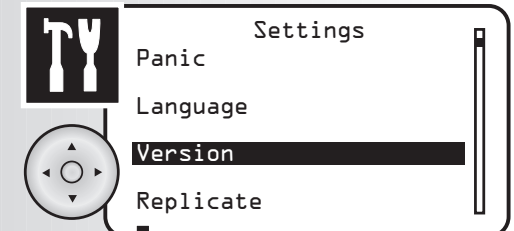

2. View version information about the wireless control system.

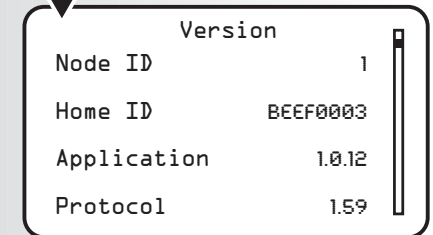

3. When finished, press the OK or Back button to return to the main settings menu.

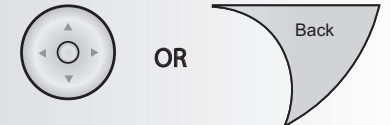

Retrieving Version Information about an Individual Device

1. Select the "Version" option from the Devices menu. Press the OK button.

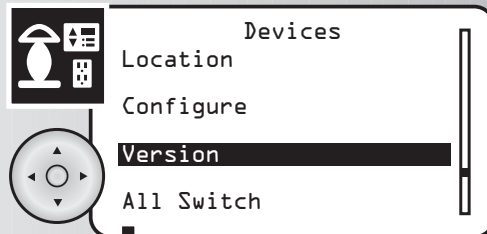

2. Highlight the location of the device. Press the OK button.

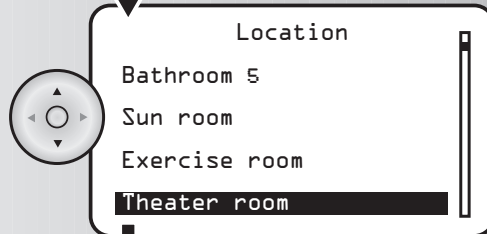

3. Highlight the specific device. Press the OK button.

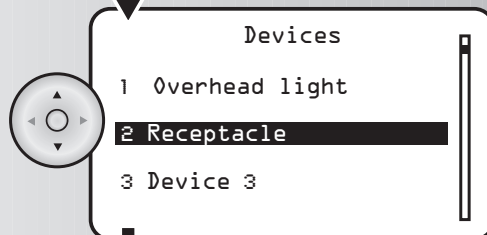

4. View version information about the device.

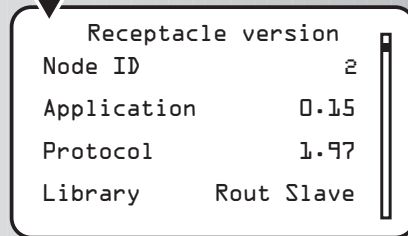

5. When finished, press the OK or Back button to return to the main settings menu.

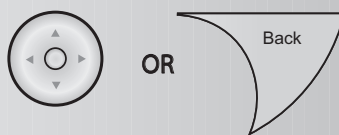

Removing a Failed Device

1. Select the "Remove" option from the Devices menu. Press the OK button.

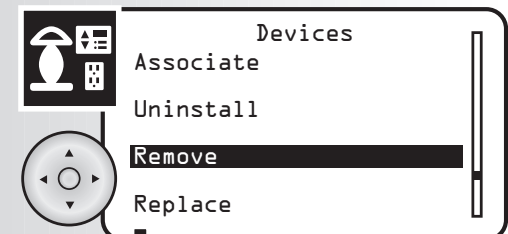

2. Highlight the location of the device to be removed. Press the OK button.

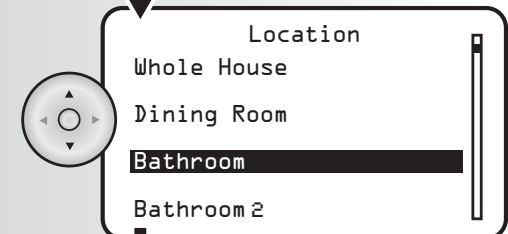

3. Highlight the specific device to be removed. Press the OK button.



4. The controller will check the system to confirm that the device contains a failed noted ID. A message will confirm whether or not the device has been removed.

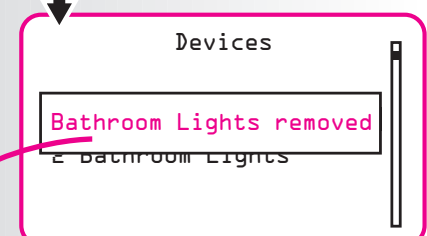

Is this popup window correct?

Replacing a Failed Device

1. Select the "Replace" option from the Devices menu. Press the OK button.

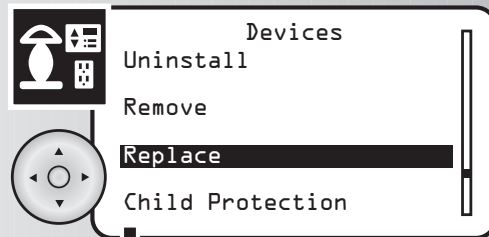

2. Highlight the location of the device to be replaced. Press the OK button.

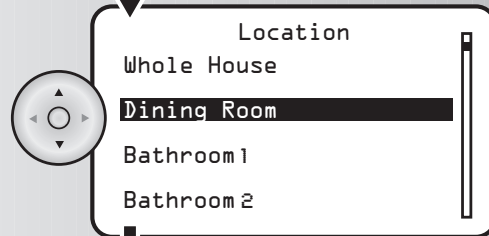

3. Highlight the specific device to be replaced. Press the OK button.

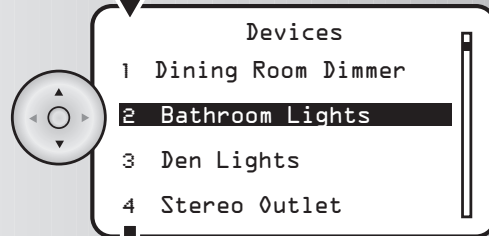

4. Press the Install button on the new device.

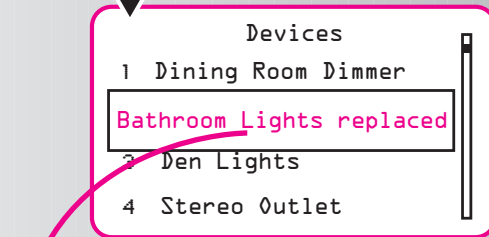

5. The controller will generate new mode information for the system and complete the replacement process. A message will confirm whether or not the device has been replaced.

Is this popup window correct?

Operating Network Discovery

Network discovery is a network management function that forces the controller to search for devices and update the network routing tables contained in the devices and in the handheld. It is rarely used in the day-to-day operation of the wireless system. [Do users need this information or is it only used by service technicians?]

1. Select the "Network Discovery" option from the Settings menu. Press the OK button.

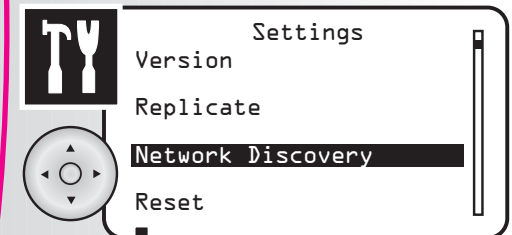

2. The discovery process will last several seconds. A pop-up window will display a message when the operation is complete.

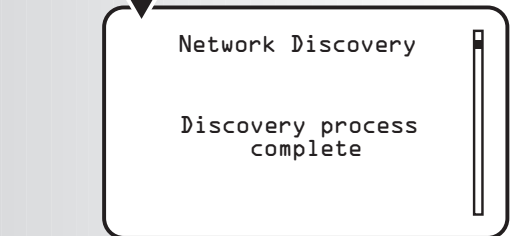

Note from Loudwater—The network discovery is something the users may never use. Not sure if there will be such a thing as a service technician. It may be that they will be instructed to use this over the phone with support.

Page Title

Lorem ipsum dolor sit amet, consectetur adipiscing elit. Nullam ac dui. Aliquam commodo adipiscing lacus. Nunc eget erat. Sed consequat justo non leo. Integer id nisl vel nisi gravida iaculis. Proin vel sapien. Suspendisse ut nunc. Aenean scelerisque consequat eros. Fusce suscipit. Praesent purus. Sed dictum mi quis tellus laoreet suscipit. Nunc in turpis. Duis ac lacus. Fusce mattis scelerisque turpis. Mauris quis nisl id metus consectetur mattis. Morbi semper condimentum odio. Pellentesque vestibulum. Pellentesque molestie lobortis pede.

Morbi nonummy. Donec ultrices enim eu orci. In id neque. Vivamus sodales diam consequat neque. Proin venenatis lobortis ante. Cum sociis natoque penatibus et magnis dis parturient montes, nascetur ridiculus mus. Praesent mollis risus vel lacus. Aliquam interdum nunc vitae enim. Donec semper. Maecenas sed felis. Pellentesque purus libero, consequat eu, dapibus non, accumsan sed, libero. Aenean nec justo nec urna egestas iaculis. Vivamus tincidunt facilisis ante.

Mauris ut enim. Suspendisse convallis nonummy lacus. Aenean eget purus at ipsum adipiscing iaculis. Quisque convallis. Nam viverra. Nam scelerisque tincidunt tellus. Cras erat metus, convallis non, dignissim eget, dignissim at, diam. Aliquam erat volutpat. Mauris rutrum arcu sit amet nulla. Vivamus lectus justo, tempor a, feugiat eu, tincidunt eu, ipsum. Sed nulla est, pharetra ac, euismod a, semper vel, mauris. Duis massa purus, sodales nec, vulputate dignissim, vulputate quis, libero. Mauris magna leo, euismod id, ultrices ac, fermentum sit amet, eros. Praesent rutrum. Aenean tempor mi ut eros. Praesent odio urna, posuere eu, sagittis non, congue ac, urna. Maecenas vestibulum ipsum et dui. Nullam massa lorem, ornare id, elementum eu, condimentum vitae, felis.

Suspendisse quis nisi. Nulla eu lectus sit amet ligula bibendum molestie. Sed nisi neque, congue eget, imperdiet a, gravida nec, eros. Curabitur nec mi. Maecenas purus. Phasellus nec velit et justo sollicitudin iaculis. Duis quis magna. Pellentesque enim ligula, semper ut, lacinia eu, suscipit non, quam. Ut eros quam, lobortis eu, sodales non, placerat ut, sapien. Nunc cursus ipsum in lacus. In hac habitasse platea dictumst. Mauris eleifend nisl vitae mauris. Phasellus non lacus non sapien dictum auctor. Donec eget sem ac eros mattis sodales.

Pellentesque et turpis at lacus aliquam cursus. Nulla tempus elementum ligula. Aenean lacinia nunc eu mi. Fusce tempus nibh. Donec vel nibh. Quisque tortor. Fusce in nisi vel risus commodo posuere. Morbi pulvinar. Donec dapibus varius diam. Cras sodales. Vivamus sit amet elit id orci lacinia ultrices. Etiam vitae nisl. Vestibulum ante ipsum primis in faucibus orci luctus et ultrices posuere cubilia Curae;



Page Title

Lorem ipsum dolor sit amet, consectetur adipiscing elit. Nullam ac dui. Aliquam commodo adipiscing lacus. Nunc eget erat. Sed consequat justo non leo. Integer id nisl vel nisi gravida iaculis. Proin vel sapien. Suspendisse ut nunc. Aenean scelerisque consequat eros. Fusce suscipit. Praesent purus. Sed dictum mi quis tellus laoreet suscipit. Nunc in turpis. Duis ac lacus. Fusce mattis scelerisque turpis. Mauris quis nisl id metus consectetur mattis. Morbi semper condimentum odio. Pellentesque vestibulum. Pellentesque molestie lobortis pede.

Morbi nonummy. Donec ultrices enim eu orci. In id neque. Vivamus sodales diam consequat neque. Proin venenatis lobortis ante. Cum sociis natoque penatibus et magnis dis parturient montes, nascetur ridiculus mus. Praesent mollis risus vel lacus. Aliquam interdum nunc vitae enim. Donec semper. Maecenas sed felis. Pellentesque purus libero, consequat eu, dapibus non, accumsan sed, libero. Aenean nec justo nec urna egestas iaculis. Vivamus tincidunt facilisis ante.

Mauris ut enim. Suspendisse convallis nonummy lacus. Aenean eget purus at ipsum adipiscing iaculis. Quisque convallis. Nam viverra. Nam scelerisque tincidunt tellus. Cras erat metus, convallis non, dignissim eget, dignissim at, diam. Aliquam erat volutpat. Mauris rutrum arcu sit amet nulla. Vivamus lectus justo, tempor a, feugiat eu, tincidunt eu, ipsum. Sed nulla est, pharetra ac, euismod a, semper vel, mauris. Duis massa purus, sodales nec, vulputate dignissim, vulputate quis, libero. Mauris magna leo, euismod id, ultrices ac, fermentum sit amet, eros. Praesent rutrum. Aenean tempor mi ut eros. Praesent odio urna, posuere eu, sagittis non, congue ac, urna. Maecenas vestibulum ipsum et dui. Nullam massa lorem, ornare id, elementum eu, condimentum vitae, felis.

Suspendisse quis nisi. Nulla eu lectus sit amet ligula bibendum molestie. Sed nisi neque, congue eget, imperdiet a, gravida nec, eros. Curabitur nec mi. Maecenas purus. Phasellus nec velit et justo sollicitudin iaculis. Duis quis magna. Pellentesque enim ligula, semper ut, lacinia eu, suscipit non, quam. Ut eros quam, lobortis eu, sodales non, placerat ut, sapien. Nunc cursus ipsum in lacus. In hac habitasse platea dictumst. Mauris eleifend nisl vitae mauris. Phasellus non lacus non sapien dictum auctor. Donec eget sem ac eros mattis sodales.

Pellentesque et turpis at lacus aliquam cursus. Nulla tempus elementum ligula. Aenean lacinia nunc eu mi. Fusce tempus nibh. Donec vel nibh. Quisque tortor. Fusce in nisi vel risus commodo posuere. Morbi pulvinar. Donec dapibus varius diam. Cras sodales. Vivamus sit amet elit id orci lacinia ultrices. Etiam vitae nisl. Vestibulum ante ipsum primis in faucibus orci luctus et ultrices posuere cubilia Curae;

Page Title

Lorem ipsum dolor sit amet, consectetur adipiscing elit. Nullam ac dui. Aliquam commodo adipiscing lacus. Nunc eget erat. Sed consequat justo non leo. Integer id nisl vel nisi gravida iaculis. Proin vel sapien. Suspendisse ut nunc. Aenean scelerisque consequat eros. Fusce suscipit. Praesent purus. Sed dictum mi quis tellus laoreet suscipit. Nunc in turpis. Duis ac lacus. Fusce mattis scelerisque turpis. Mauris quis nisl id metus consectetur mattis. Morbi semper condimentum odio. Pellentesque vestibulum. Pellentesque molestie lobortis pede.

Morbi nonummy. Donec ultrices enim eu orci. In id neque. Vivamus sodales diam consequat neque. Proin venenatis lobortis ante. Cum sociis natoque penatibus et magnis dis parturient montes, nascetur ridiculus mus. Praesent mollis risus vel lacus. Aliquam interdum nunc vitae enim. Donec semper. Maecenas sed felis. Pellentesque purus libero, consequat eu, dapibus non, accumsan sed, libero. Aenean nec justo nec urna egestas iaculis. Vivamus tincidunt facilisis ante.

Mauris ut enim. Suspendisse convallis nonummy lacus. Aenean eget purus at ipsum adipiscing iaculis. Quisque convallis. Nam viverra. Nam scelerisque tincidunt tellus. Cras erat metus, convallis non, dignissim eget, dignissim at, diam. Aliquam erat volutpat. Mauris rutrum arcu sit amet nulla. Vivamus lectus justo, tempor a, feugiat eu, tincidunt eu, ipsum. Sed nulla est, pharetra ac, euismod a, semper vel, mauris. Duis massa purus, sodales nec, vulputate dignissim, vulputate quis, libero. Mauris magna leo, euismod id, ultrices ac, fermentum sit amet, eros. Praesent rutrum. Aenean tempor mi ut eros. Praesent odio urna, posuere eu, sagittis non, congue ac, urna. Maecenas vestibulum ipsum et dui. Nullam massa lorem, ornare id, elementum eu, condimentum vitae, felis.

Suspendisse quis nisi. Nulla eu lectus sit amet ligula bibendum molestie. Sed nisi neque, congue eget, imperdiet a, gravida nec, eros. Curabitur nec mi. Maecenas purus. Phasellus nec velit et justo sollicitudin iaculis. Duis quis magna. Pellentesque enim ligula, semper ut, lacinia eu, suscipit non, quam. Ut eros quam, lobortis eu, sodales non, placerat ut, sapien. Nunc cursus ipsum in lacus. In hac habitasse platea dictumst. Mauris eleifend nisl vitae mauris. Phasellus non lacus non sapien dictum auctor. Donec eget sem ac eros mattis sodales.

Pellentesque et turpis at lacus aliquam cursus. Nulla tempus elementum ligula. Aenean lacinia nunc eu mi. Fusce tempus nibh. Donec vel nibh. Quisque tortor. Fusce in nisi vel risus commodo posuere. Morbi pulvinar. Donec dapibus varius diam. Cras sodales. Vivamus sit amet elit id orci lacinia ultrices. Etiam vitae nisl. Vestibulum ante ipsum primis in faucibus orci luctus et ultrices posuere cubilia Curae;