

October 31, 2018

To: Our Valued Customers

Re: Door Control Products Pricing Adjustments

We remain committed to providing you with innovative, high-quality products. The same level of vigor is employed to improve efficiencies and reduce costs throughout our operations. We have made a concerted effort to absorb increased costs thus far. However, we will be unable to continue to offset the extraordinary increases in raw material, tariff and transportation costs that are expected to continue into 2019.

Effective January 1, 2019, **Corbin Russwin, Norton/RIXSON, SARGENT, and Yale Commercial** will be implementing price adjustments on all door control products, including closers, operators and accessories. The January 1, 2019 price books will supercede all other price books.

The amount of the increase varies by brand. Approximate average increases are:

<b><u>DOOR CONTROLS &amp; PARTS</u></b>	<b><u>AVERAGE INCREASE</u></b>
Corbin Russwin	5.5%
Norton/RIXSON	4.5%
SARGENT	5.0%
Yale Commercial	4.5%

By November 30, 2018, updated price books will be available in digital format on the digital library for easy searchability, download and printing. The brand name above is also a link that will direct you to each brand's digital library.

To reduce waste in support of our sustainability goals, printed price books will be available only to those customers who register to receive a printed copy between November 12<sup>th</sup> and December 15<sup>th</sup> through this link:

**<http://www.nacorporation.com/registration/pricebooks>**

User IDs and passwords will be issued to registrants every Monday. You will receive a user ID, password and instructions on how to login and reserve your printed copies of the price book. Price books will begin shipping the week of December 15<sup>th</sup> on a first-come, first-served basis determined by using the date/time of registration online.

For assistance, please call 1-800-508-5426. A representative of NVISION, our print and order fulfillment company, will be happy to help you through the registration/order process.

Important dates relevant to the implementation of the January 1, 2019 price books are outlined on the following page.

Thank you for your continued support and partnership.



**Corbin  
Russwin** 

**ASSA ABLOY**



# 2019 Price List

Number 32  
Effective January 1, 2019



ASSA ABLOY, the global leader  
in door opening solutions

SECTION	PAGES
Service Center Business Hours, Holiday Schedule	1
Partner Services in Canada, Business Hours, Holiday Schedule	1
Order Forms	2
Key System Information Request Form	6
Keyed Order Lead Sheet	7
Tools and Rules	10
Terms and Conditions	14
Warranty	18
Finishes, Samples, Templates	20

MUSEO®	
TL3700 Series: Museo Levers & Inspire Trim	21
TL3700 Series: Museo Levers & Roses	22
TL3700 Series: Options	26
ML2000 Series: Museo Levers & Inspire Trim	27
ML2000 Series: Museo Levers, Roses & Thumbturns	28
ML2000 Series: Museo Levers & Escutcheons	33
ML20900 Series & ML20600 NAC Series: Museo Levers, Escutcheons, Roses and Thumbturns	38
ML20800 AC2 Series: Museo Levers	50
ED5000 AC2 Series: Museo Levers	53
ED4000 Series: Museo Levers with 800 Series Escutcheon	56
ED5000 Series: Museo Levers with 900 Series Escutcheon	58

KEY SYSTEMS	
General Information	61
Policy	64
Construction Core	65
Keying, Stamping, Cut Keys	66
Bitting List	67
Key Wizard	68
Key Blanks	69
Access 3 AP Security Cylinders	71
Pyramid Cylinders	77
Conventional Cylinders	83
Interchangeable Core Cylinders	91
Security Cylinders	95
Master Ring Cylinders	101
Service Equipment	104

ACCESS CONTROL	
Access 800® AC2	105
ML20800 Series	106
CL33800 Series	110
ED5000 x 9800 AC2 Series	114
WM800 Reader/Controller	120
Wiring Diagram Services and Accessories	121

MORTISE LOCKSETS AND TRIM	
ML2000 Series	123
Vineyard™ Collection	130
Vandal Resistant Trim	132
ML20900 Series & ML20600 NAC Series	133
Cylinder and Keying Options	142
Miscellaneous Options	145

SPECIALTY HARDWARE	
MicroShield® How to Order	147
BHSS Trim	148
BLSS Trim	149
HSS Trim	150
HPSK Trim	151
HP3000 Series Tubular Lock with Push/Pull Trim	152

CYLINDRICAL LOCKS	PAGES
MicroShield® How to Order	154
CL3100 Series Grade 1 Vandal Resistant Cylindrical Lever Locksets	155
CL3300 Series Grade 1 Extra Heavy-Duty Cylindrical Lever Locksets	161
CL3500 Series Grade 1 Heavy-Duty Cylindrical Lever Locksets	167
CL3800 Series Grade 2 Standard-Duty Lever Locksets	173
CK4300 Series Grade 1 Heavy-Duty Cylindrical Knob Locksets	177
CK4400 Series Grade 2 Standard-Duty Cylindrical Knob Locksets	180
PRE-ASSEMBLED UNIT LOCKSETS	
UT5200 Series	183
AUXILIARY HARDWARE	
PL5000 Series Padlocks	189
DL2200 Series Cylindrical Deadlocks	191
DL3000 Series Cylindrical Deadlocks	194
DL3200 Series Cylindrical Deadlocks	197
DL4100 Series Mortise Deadlocks	200
MULTI-POINT LOCKS	
FE5400S	203
FE6600	219
FE6700	231
MP9800	235
EXIT DEVICES	
MicroShield® Technology	247
ED3000 Crossbar Series	249
ED4000 Narrow Stile Pushpad Series	261
ED5000 Pushpad Series	273
ED7000 Narrow Stile Crossbar Series	296
ED8000 Pushpad Series	307
DOOR CLOSERS	
DC3000 Series	317
DC5000 Series (Cam Action Door Closer)	319
DC6000 Series	321
DC8000 Series	325
DC46900 Series (Safeguard™)	330
DC62900 Series	331
PARTS	
<b>Key Systems</b>	
Plugs and Shells	334
Cylinder Parts	335 - 336
Standard Diameter Cylinder Collars	337
Master Ring Cylinder Collars	338
Tools	338
<b>Mortise Locksets and Trim</b>	
ML2000 Series – Mortise Locks	339 - 341
ML2000 Series – Mortise Trim	342 - 350
<b>Vandal Resistant Cylindrical Lever Locksets</b>	
CL3100 Series	351 - 353
<b>Extra Heavy-Duty Cylindrical Lever Locksets</b>	
CL3300 Series	354 - 356
<b>Heavy-Duty Cylindrical Lever Locksets</b>	
CL3500 Series	357 - 358
<b>Grade 2 Key-In-Lever</b>	
CL3700 Series	358
CL3800 Series	359 - 360

Continued on next page.

PARTS	PAGE
<b>Heavy-Duty Cylindrical Knob Locksets</b>	
CK4300 Series	361
<b>Standard-Duty Cylindrical Knob Locksets</b>	
CK4400 Series	362
<b>Pre-Assembled Unit Locksets</b>	
UT5200 Series	363 - 364
<b>Padlocks, Deadlocks and Push-Pull Latches</b>	
Padlocks	364
DL3000 Series Deadlocks	364
<b>ED4000 and ED5000 Series</b>	
Device Parts	365 - 367
Trim Parts	367 - 369
<b>Crossbar Exit Devices and Trims</b>	
ED7000 Series	370 - 374
<b>Pushpad Exit Devices and Trims</b>	
ED8000 Series	375 - 376
<b>Door Closers</b>	
DC3000 Series	377
DC5000 Series	377
DC6000 Series	378
DC8000 Series	379
<b>Electronic Hardware Parts</b>	
DC46900 Series	380
DC62900 Series	380
Access 800® AC2 Series	380

**GENERAL INFORMATION**
**PAGES**
**Order Forms:**

Service Center, Business Hours, Holiday Schedule	1
Partner Services in Canada, Business Hours, Holiday Schedule	1
Order Form	2
Stock Condensed Order Form	3
Keyed Condensed Order Form (Cylinders Ordered Separately)	4
Keyed Condensed Order Form (Cylinders Ordered with Lockset/Device)	5
Key Systems Information Request Form	6
Keyed Order Lead Sheet (A)	7
Keyed Order Lead Sheet (B)	8
Keyed Order Lead Sheet (C)	9

**Tool & Rules:**

Ordering Tips	10
Ordering Tips, Checklist	11
Website eBusiness	12
Online Orders Fax Program	13

**Terms & Conditions:**

Terms & Conditions (Acceptance Quick Ship Orders)	14
Terms & Conditions (Quick Ship Orders Claims)	15
Terms & Conditions (Invoice Deduction Product Modifications)	16
Terms & Conditions (Fire Rated Openings Technical Information)	17

**Limited Warranty:**

Limited Warranty, Finishes, Requirements, Keying Systems	18
Limited Warranty, Terms and Conditions	19
Finishes, Samples, Templates	20

**Service Center Business Hours**

**ASSA ABLOY Door Security Solutions®**

**Customer Service – Monroe** ..... 8:00 a.m. – 4:30 p.m. (Eastern)

1902 Airport Road

Monroe, NC 28110

Telephone Number: .....(800) 438-1951

Fax Number: .....(800) 338-0965

**Technical Product Support** ..... 8:00 a.m. - 4:30 p.m. (Eastern)

225 Episcopal Road

Berlin, CT 06037

Telephone Number: .....(888) 607-5703

**Electrified Technical Product Support** ..... 8:00 a.m. - 4:30 p.m. (Eastern)

Telephone Number: .....(800) 810-WIRE (9473)

Fax Number: .....(203) 603-5981

**Holiday Schedule\* These following entities will be CLOSED on these dates:**

**ASSA ABLOY Door Security Solutions® Customer Service – Monroe**

January 1, 2019

February 18, 2019

April 19, 2019

May 27, 2019

July 4, 2019

July 5, 2019

September 2, 2019

November 28, 2019

November 29, 2019

December 24, 2019

December 25, 2019

**Technical Product Support**

January 1, 2019

February 18, 2019

April 19, 2019

May 27, 2019

July 4, 2019

July 5, 2019

September 2, 2019

November 28, 2019

November 29, 2019

December 24, 2019

December 25, 2019

**Electrified Technical Product Support- New Haven CT**

January 1, 2019

January 21, 2019

February 18, 2019

April 19, 2019

May 27, 2019

July 4, 2019

July 5, 2019

September 2, 2019

November 28, 2019

November 29, 2019

December 24, 2019

December 25, 2019

\* Dates subject to change.

**Partner Services In Canada**

**Business Hours: Customer Service Hours:** 8:00 AM to 4:30 PM Eastern Standard Time.

**Toll Free Telephone Number:** 1-800-461-3007

**Order Fax Number:** 1-800.461.8989.

**Order email:** orders.dss.ca@assaabloy.ca

**RGA email:** rga.dss.ca@assaabloy.com

**Technical Support email:** techsupport.dss.ca@assaabloy.com

**Customer Support:** Ontario email: customerservice.dss.caontario@assaabloy.com

**Customer Support:** East email: customerservice.dss.caeast@assaabloy.com

**Customer Support:** West email: customerservicedss.cawest@assaabloy.com

**2019 Canadian Calendar:**

January 1: New Year's Day

January 24 : Inventory

February 18: Family Day

April 19: Good Friday

May 20: Victoria Day

July 1: Canada Day

August 5: Civic Holiday

September 3: Labor Day

October 14: Thanksgiving

December 25: Christmas Day

December 26: Boxing Day

**For Terms & Conditions and Warranty information pertaining to product sales in Canada, please visit [www.assaabloy.ca/terms](http://www.assaabloy.ca/terms).**

**Note that some products may not be available in Canada as well as some of the programs offered in this price book may differ between the USA and Canada. Please contact your sales representative for more information.**



ASSA ABLOY

List Price Book No. 32

January 1, 2019



<b>CUSTOMER ACCOUNT #</b>	<b>PLEASE CHECK</b>		<b>DATE REQUESTED</b>	<b>SOLD TO ADDRESS</b>
	<input type="checkbox"/> PART SHIP	<input type="checkbox"/> SHIP COMPLETE		
<b>CUSTOMER P.O. #</b>	<b>P.O. DATE</b>	<b>CONTACT PERSON</b>	<b>SHIP TO ADDRESS</b>	
		<b>PHONE #</b>		
		<b>FAX #</b>		

**SHIP VIA**

**MARKS**  
If markings are required, purchase order will be entered to the factory. See *Stock Condensed Order Form* to include appropriate information.

**BUYING PROGRAM**  **OR** **CPQ NUMBER**

<i>Required</i> QTY	<i>Required</i> PART #	<i>(2000X033)</i> CYLINDER	<i>(6 pin-10)</i> KEY BLANKS	<i>Required</i> SERIES & FUNCTION	TRIM, DR WIDTH & HEIGHT	HAND R, L, RR, LR	<i>Required</i> FINISH	KEYWAY/ SECTION	QUICK CODE M52, M54, M55, M94, KR <i>(Requires Voltage)</i>



Sheet _____ of _____
<input type="checkbox"/> This Sheet Only

<b>Customer Name</b>				<b>Purchase Order No.</b>	
Qty.	Series and Function	Trim	Keyway	Finish	Quick Code Options

**Special Notes:**

Item	Qty.	Key Symbol	Hand				Door Number (Up to 10 characters)	Heading (Up to 10 characters)
			RH	LH	RHR	LHR		

Sheet \_\_\_\_\_ of \_\_\_\_\_  
 This Sheet Only

<b>Customer Name</b>				<b>Purchase Order No.</b>		
Qty.	Cylinder	Length	Pins	Keyway	Cam/Tailpiece	Finish

**Special Notes:**

Item	Qty.	Key Symbol	Door Number (Up to 10 characters)	Heading (Up to 10 characters)	Keyed Function Used

Sheet \_\_\_\_\_ of \_\_\_\_\_  
 This Sheet Only

<b>Customer Name</b>				<b>Purchase Order No.</b>	
<b>Qty.</b>	<b>Series and Function</b>	<b>Trim</b>	<b>Keyway</b>	<b>Finish</b>	<b>Quick Code Options</b>

**Special Notes:**

Item	Qty.	Key Symbol	Hand				Door Number (Up to 10 characters)	Heading (Up to 10 characters)
			RH	LH	RHR	LHR		



**ASSA ABLOY**

Date: \_\_\_\_\_

**KEY SYSTEMS INFORMATION**

\*Registry Number: \_\_\_\_\_

\*Job Name and Location: \_\_\_\_\_

\*Keyway: \_\_\_\_\_ Top Master Key Bitting: \_\_\_\_\_

Any Other Known System Information:

Information Requested:

Requested By: \_\_\_\_\_

Phone: \_\_\_\_\_ Fax: \_\_\_\_\_ Email: \_\_\_\_\_

Agency/Distributor Name: \_\_\_\_\_

Key System Administration Response:

**Please attach a Letter of Authorization from the end user if requesting bitting information.**

**\*Required Information**

Sheet 1 of _____
Date: _____
Purchase Order No.: _____
Date Required: _____

**SOLD TO:**

---



---



---

**SHIP TO:**

---



---



---

**1. JOB NAME AND ADDRESS**

---



---



---

**2. SYSTEM STATUS**

New  Existing ..... Registry No. \_\_\_\_\_

Customer Bittings (Please attach and indicate How to Read)  Bow to Tip  Tip to Bow

Corbin Russwin Factory Order No. \_\_\_\_\_ Authorized Security Code\* \_\_\_\_\_

\* Not required if opt-out has been recorded on SID

**3. HIGHEST LEVEL OF SYSTEM**

1 - SKD  2 - MK  3 - GM  4 - GGM  5 - GGGM

**4. SYSTEM TYPE**

Security  IC  Master Ring  Conventional  Pyramid\*\*  Access 3 - AP\*\*  Access 3 - AS\*\*  Access 3 - AHS\*\*

Other \_\_\_\_\_

\*\*Required documentation must accompany each initial Pyramid or Access 3 order to avoid delay.

**5. KEYS**

**Keyway Selection:**  Stock-L4  Standard  Restricted\*  Patented\* Protected

Specific Keyway \_\_\_\_\_

**Number of Pins:**  5  6 (Default)  7

\* Requires PRIOR Key Systems Approval

**Depth System:**  System 70 (Default)  Pre-System 70  Access 3-AP  Access 3-AS/AHS

**Key Bow Style:** \_\_\_\_\_

**Pyramid & Access 3 have dedicated Bows:** \_\_\_\_\_

**Key Stamping:**

<input type="checkbox"/> VKC0 - No Bitting or Key Set Stamping on Keys	<input type="checkbox"/> Bittings (Standard for Conventional Change Keys)
<input type="checkbox"/> VKC1 - Visual Key Control Keys Only	<input type="checkbox"/> DO NOT DUPLICATE
<input type="checkbox"/> VKC2 - Visual Key Control Keys and Cylinders	<input type="checkbox"/> US PROPERTY DO NOT DUPLICATE
<input type="checkbox"/> VKC3 - Visual Key Control Cylinders Only	<input type="checkbox"/> Special Stamping: _____
<input type="checkbox"/> CKC2 - Concealed Key Control Cylinders and VKC Keys	_____
<input type="checkbox"/> CKC3 - Concealed Key Control Cylinders Only	_____

**6. KEY QUANTITY**

<b>Master Level</b>	<b>Qty.</b>	<b>Special Function</b>	<b>Qty.</b>
<input type="checkbox"/> GGGM _____	_____	<input type="checkbox"/> Control .....	_____
<input type="checkbox"/> GGM _____	_____	<input type="checkbox"/> CMK .....	_____
<input type="checkbox"/> GM _____	_____	<input type="checkbox"/> CMK Control .....	_____
<input type="checkbox"/> _____	_____	<input type="checkbox"/> Emergency .....	_____
<input type="checkbox"/> _____	_____	<input type="checkbox"/> SKD Control .....	_____
<input type="checkbox"/> MK / Group _____	_____	<input type="checkbox"/> SKD CMK .....	_____
<input type="checkbox"/> _____	_____	<input type="checkbox"/> SKD CMK Control .....	_____
<input type="checkbox"/> _____	_____	<input type="checkbox"/> Blockout .....	_____
<input type="checkbox"/> Other _____	_____	<input type="checkbox"/> Maintenance .....	_____
<input type="checkbox"/> _____	_____	<input type="checkbox"/> Housekeeping .....	_____
<input type="checkbox"/> _____	_____	<input type="checkbox"/> Mechanical .....	_____
<b>Change Keys*</b>	<b>Qty.</b>	<input type="checkbox"/> Engineering .....	_____
Per cylinder _____	_____	<input type="checkbox"/> Janitorial .....	_____
Per keyed alike group _____	_____	<input type="checkbox"/> Other .....	_____
Per keyed different cylinder _____	_____		

\*Two cut change keys are standard per lockset/cylinder, keyblanks cannot be substituted for cut keys.

**7. CROSS KEYING**

<b>Key Symbol:</b>	<b>To Be Operated By (OBY):</b>

**SOLD TO:**

\_\_\_\_\_  
\_\_\_\_\_  
\_\_\_\_\_

Sheet 2 of _____
Date: _____
Purchase Order No.: _____
Date Required: _____

**8. CONSTRUCTION MASTER KEYING\***

\*This section Does NOT Refer To Temporary Construction Cores  
This Order:    Yes             No     Establish for future use only

Ship Construction Keys To: \_\_\_\_\_  
\_\_\_\_\_

Attention: \_\_\_\_\_  
\_\_\_\_\_

**9. PRICING**

Order subject to follow pricing:

- |  |                         |                                      |
|--|-------------------------|--------------------------------------|
| <input type="checkbox"/> Price List Dated _____  | <b>Discounts Quoted</b> | Exit Devices _____                   |
| <input type="checkbox"/> Special Job Quote _____ | Cylindrical Locks _____ | Door Closers _____                   |
| Date Quoted _____                                | Mortise Locks _____     | Electrical Options _____             |
| Quote No. _____                                  | Deadlocks _____         | <input type="checkbox"/> Other _____ |
|  | Cylinders Only _____    | Other _____                          |

**10. PACKAGING AND MARKING**

- |  |  |
|--|--|
| <input type="checkbox"/> Pack change keys with locks (Standard)                              | Label Boxes:   |
| <input type="checkbox"/> Pack change keys separately (Security, Pyramid and CMK jobs always) | <input type="checkbox"/> Key symbol <input type="checkbox"/> Door No. <input type="checkbox"/> Heading |

Ship Change Keys To: \_\_\_\_\_                      Attention: \_\_\_\_\_  
\_\_\_\_\_  
\_\_\_\_\_

**11. SHIPPING INSTRUCTIONS FOR MASTER KEYS**

Ship Master Keys To: \_\_\_\_\_                      Attention: \_\_\_\_\_  
\_\_\_\_\_  
\_\_\_\_\_

**12. BITTING LIST**

Provide Bitting List for This Order:     Yes     No  
Letter of Authorization:  Attached

Mail Bitting List To: \_\_\_\_\_  
\_\_\_\_\_  
\_\_\_\_\_  
\_\_\_\_\_

Attention: \_\_\_\_\_

**13. CONTACT**

Name of individual in your organization who is knowledgeable about this project, should any clarification be necessary. (Please print or type.)

\_\_\_\_\_  
Name

\_\_\_\_\_  
Phone    Fax

This form has been completed by: (please print)

\_\_\_\_\_  
Name:

**ADDITIONAL INFORMATION (attach)**

System Expansion Requirements, Special Remarks, etc.

## Ordering Tips

- Please submit **Quick Ship Program Orders** and **Plant Product Orders** on separate order forms.
- Please use **Quick Ship Program Forms** for all **Quick Ship Product Orders** and include **Quick Ship Part Numbers**.
- **Order Forms** are included in the Price Book and at [www.corbinrusswin.com](http://www.corbinrusswin.com).
- We recommend using the **Order Form** included with this Price Book when placing purchase orders for Corbin Russwin products. The **Order Form** is available for copying prior to placing your order.
- Please include **Job Name and Registry Number** for all contract orders.
- Be sure to include **Voltage** on all Electrified Hardware orders.
- A **Letter of Authorization** is required for all Protected and Pyramid Keyways.
- **Keyed Lead Sheets A and B** are *recommended* for contract orders that are keyed to existing Master Key systems.
- Remember to include **Keysets** on all contract orders.
- Be sure to include **Handing** for all unit locks, mortise locks and exit devices.
- If you have a **Quote**, please include it with the purchase order. Orders without this information may be delayed.



## Ordering Tip — Administrative Documentation

When submitting purchase orders to ASSA ABLOY Door Security Solutions® Consultants for processing, please remember that certain cylinder types and/or keyways require additional administrative documentation before the order can be entered.

Purchase orders will be held and questioned if the following keyway/cylinder types do not have the proper administrative documentation submitted with each purchase order:

- Protected and Pyramid keyway products
- Security cylinders and keys
- High security cylinders and keys

All of the above product types must be accompanied by additional administrative documents unless they are shipping direct to the end user facility. These administrative documents include, but may not be limited to, the following:

- Letter of Authorization – must be submitted on the end user facility letterhead, dated and signed by an authorized individual from the facility. Letter must be quantity specific for certain product types. ASSA ABLOY Door Security Solutions Consultants does not keep letters of authorization on file.
- Registration Certificate – only required for Pyramid systems.

## Ordering Checklist

Before placing your order, check for the following:

- ✓ Purchase Order on company letterhead
- ✓ Purchase Order is legible
- ✓ Purchase Order Number
- ✓ Account Number
- ✓ Ship To Address
- ✓ Contact Person for additional information requirements
- ✓ Pricing Requirements – Buying Program or CPQ (please attach)
- ✓ Quick Ship Order (Quick Ship Order Form or Quick Ship part numbers included)
- ✓ Contract Order (Keyed Lead Sheets attached)
- ✓ Handing (if applicable)
- ✓ Design (if applicable)
- ✓ Backset & Strike (if applicable)
- ✓ Finish (if applicable)

**Website**

Corbin Russwin's website at [www.corbinrusswin.com](http://www.corbinrusswin.com) is the place to go for all your Corbin Russwin product information needs. Easy-to-navigate menus and intuitive icons allow simple and fast access to the latest on new products, as well as the most up-to-date catalogs, templates and installation instructions.

Another great benefit of the Corbin Russwin website is the ability to become an eBusiness member. Access gives additional information for Corbin Russwin account customers only.

**eBusiness**

Visit [www.corbinrusswin.com](http://www.corbinrusswin.com) to sign up for ASSA ABLOY Door Security Solutions eBusiness access.

ASSA ABLOY Door Security Solutions Consultants provides sales, marketing and support for Corbin Russwin.

To sign up for eBusiness, follow the simple instructions listed below. Register today and start enjoying the many benefits!

eBusiness offers anytime access to:

- Order Status
- Stock Status Check
- Key Systems
- Newsletters
- Contact Webmaster
- Fax Order Acknowledgement
- Extended Literature (Price Books, Order Forms, Keyed Lead Sheets)
- Order Check by P.O.
- Cross Reference Guide
- Key Wizard® Order Forms
- ASSA ABLOY Door Security Solutions Online Store
- Fax Program Sign Up
- Fax Invoice

**How to sign up for eBusiness access:**

- Step 1: Visit our website at [www.corbinrusswin.com](http://www.corbinrusswin.com)
- Step 2: Double-click eBusiness icon (top right corner)
- Step 3: Complete ASSA ABLOY Door Security Solutions eBusiness sign up form



**ONLINE ORDER ENTRY**

Would you like to reduce the time to get your orders entered to the factory and eliminate errors associated with manual order entry?

Then try our on-line order entry system. Our convenient web-based order forms can help you submit your orders directly to the factory in minutes.

Contact your customer service representative who will be able to issue your user name and password as well as set up appropriate training sessions for you and your staff.

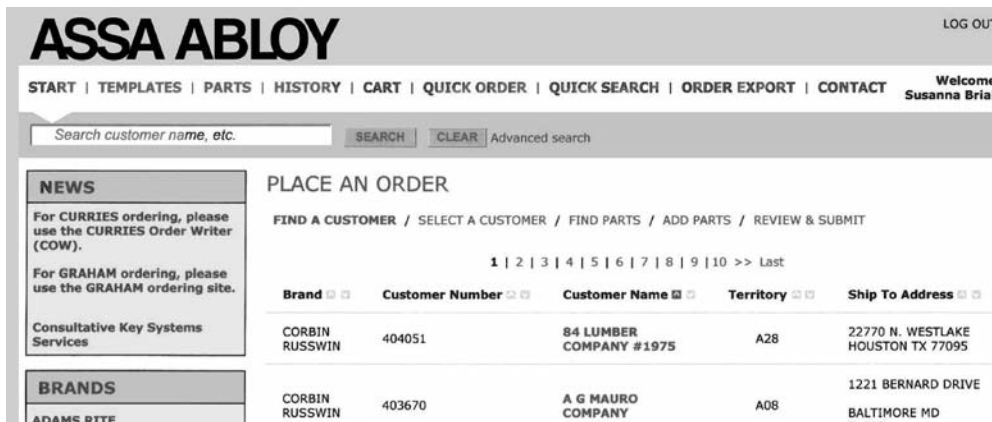

**FAX PROGRAM**

Would you like to receive your acknowledgements and invoices, invoices and Return good Authorizations quickly and efficiently?

If so, ASSA ABLOY Door Security Solutions offers the Order Acknowledgement and Invoice, invoices and Return good Authorizations Fax Program. Please see the simple steps below to get signed up today!

Requirement: Valid eBusiness User ID and Password. (If you do not have an eBusiness User ID and Password, please refer to eBusiness Sign Up Section included in this Price Book.)

Step 1: Log into eBusiness.

Step 2: Double-click on "Sign Up for ASSA ABLOY Door Security Solutions's Fax Program Now!"

Step 3: Fill in appropriate information and send.

**Fax Program Signup**

If your distributor would like to receive their CORBIN RUSSWIN, NORTON, RIXSON and YALE order acknowledgements, invoices, and return goods authorizations by fax, please complete the form below to sign them up today!

Yes - Fax Invoices to Fax #:

Yes - Fax Order Acknowledgements to Fax #:

Yes - Fax Return Goods Authorizations to Fax #:

Enter the distributor's Account Number in the input box below and click [Add] to add it to your Account Number list. Repeat for each distributor Account Number that you have.

Enter Account Number:

Account Number List:

**Terms and Conditions****ACCEPTANCE**

Corbin Russwin reserves the right to decline an order, in whole or in part, when the type or quantity of goods or credit worthiness of the Purchaser is not satisfactory to us in our sole and absolute discretion.

Purchase Orders, Quote Requests, Acknowledgements or the like issued by the Purchaser that have contrary standard terms and conditions are not binding on Corbin Russwin, unless such terms and conditions are approved in a separate written agreement by Corbin Russwin's authorized representatives. In the event of an acceptance of Purchaser's Purchase Order by Corbin Russwin, the Purchaser agrees that such acceptance is solely conditioned on Purchaser's acceptance of the terms and conditions set forth in this instrument, regardless of the terms and conditions specified in Purchaser's Purchase Order. The terms and conditions in Purchaser's Purchase Order which conflict with the terms and conditions of this instrument shall be disregarded and are hereby rejected, and this instrument shall constitute the entire agreement between Corbin Russwin and the Purchaser.

In the event that Corbin Russwin does not enforce or require strict performance of any term or condition hereof, or of any other document, instrument or other agreement relating to goods sold, such lack of enforcement or requirement of strict performance will not waive, affect or diminish any right of Corbin Russwin to enforce or require strict performance of such term or condition in the future.

**PRICES**

All prices are subject to change without notice and are not guaranteed. All shipments will be made at prices in effect at the time of shipment.

Possession of this price list does not constitute an agreement to sell.

We reserve the right to correct clerical, stenographic and other obvious errors at any time.

**TERMS**

Invoices dated the 1st through the 15th will be due for 2% discount on the \*10th of the following month. Invoices dated the 16th through the 31st will be due for 2% discount on the \*25th of the following month. \*Net immediately thereafter. (Corbin Russwin retains the right to sell or to decline to sell to any Customer for any reason whatsoever when in its judgment is deemed sufficient.)

It is understood that Corbin Russwin may impose and charge a finance charge which is the lesser of one and one-half percent (1-1/2%) per month or the highest rate allowed by law on any amount which becomes past due and delinquent. Additionally the Customer shall be responsible for all collection costs, court costs and reasonable attorney's fees (where allowed by law) in connection with the recovery of any delinquent amount.

**FREIGHT**

All orders are shipped FOB factory/warehouse, except as expressly provided below. When delivered to the Transportation Company, the Purchaser assumes the risk of loss or damage in transit.

Customer orders with net product value in excess of \$12,000.00 will be shipped prepaid by Corbin Russwin's carrier of choice to a single destination point in the United States.

Customer orders with net product value less than \$12,000.00 will be shipped prepaid by Corbin Russwin's carrier of choice and freight and handling charges will be added to the customer's invoice.

A minimum freight and handling charge of \$15.00 will be charged on orders with net product value of \$400.00 or less. The minimum freight and handling charge will not apply to orders for only Cut (bitted) keys of any type, Master Keys, Master keyed cylinders or padlocks and factory generated biting lists that do not have any other product types included on the order. Freight on these orders will be charged as the percentage of invoice value.

For orders with net product value greater than \$400.00 and less than \$12,000.00, freight charges will be calculated as a percentage of the net invoice value and will be added to Customer's invoice. The percentage is based on the National U.S. Average On Highway Diesel Fuel Prices as reported by the US Department of Energy in effect at the beginning of each quarter. On the first Monday of each quarter, the new rate will be published on the Corbin Russwin and Door Security Solutions extranet and will go into effect on the 2nd Monday of the quarter. Please refer to the extranet for the rate chart and information on the current freight charge percentage. The percentage in effect at the time of shipment of the order will be charged.

Great Grand Master keys, Grand Master keys, Master keys, Construction Master keys, Control Keys, Lot Day Keys which are shipped separate from customer order for security reasons, on orders with total net product value in excess of \$12,000.00 will be shipped prepaid by Corbin Russwin's carrier of choice. If the total order value is less than \$12,000.00, the shipping charges will be added to Customer's invoice.

If a customer provides their own freight account # for the freight charges, Corbin Russwin will apply a handling fee of \$25.00 to the invoice.

Quick Ship Orders – All 1-Week Quick Ship orders are guaranteed to ship from Corbin Russwin 5 working days after receipt of all information necessary to process order or Corbin Russwin will pay freight costs. If Quick Ship is held for credit reasons Corbin Russwin will not be responsible for freight costs.

Expedited shipping options – If the customer requests an expedited method of shipment such as "Next Day Air" the charges will be prepaid by Corbin Russwin and the full rate for the service, as published by the carrier, will be added to the customer's invoice.

**Terms and Conditions continued**

Packing – Corbin Russwin will pack, mark and ship the products according to its standard procedures for shipment, unless the parties agree, in writing, that Corbin Russwin will comply with any special instructions provided by the customer. Special instructions must be submitted, in writing, at time of order placement. Compliance with special instructions may result in an increased price.

**MINIMUM ORDER**

Minimum order value for complete product is \$250.00 net product value. The minimum order value for parts orders is \$100.00 net product value. In the event that the net product value does not meet the required net minimum, Corbin Russwin may, at its sole discretion (a) apply a minimum order charge, (b) reject the order or (c) waive the minimum requirement provided that the waiver of the requirement for one order shall not constitute a waiver of the requirement for any future orders.

The following products are exempt from this policy: Cut (bitted) Keys of any type, Master Keyed Cylinders, Master Keyed Padlocks and Factory Generated Bitting Lists.

**QUOTATIONS**

If Corbin Russwin elects to offer a quote, such quote will be valid until the expiration date on that quote. Complete shipment of the order must be accepted by Purchaser within standard manufacturing lead times. The quote number must be referenced on the order. Any invoiced order that has the incorrect discount applied to it and did not have the quote number written on the order will have a service fee of \$100.00 net DEDUCTED from any sales credit issued for the difference in discount. The quote is null and void if the Purchase Order does not include ALL product lines listed on the quote or if the quantities for any item covered by the quote deviate by 10% or more. With the issuance and acceptance of a quote for the purchase of products, the Purchaser agrees that products so purchased will not be resold or transferred to any Distributor not authorized by Corbin Russwin to sell its products. This would be inclusive of branches of the quoted Distributor. Failure to abide by this restriction may result in the Distributor's ineligibility for Quotations, or other actions in Corbin Russwin's discretion. Corbin Russwin and its sales representatives reserve the right, in their sole discretion and for any reason, to refuse a Distributor's request to quote a price other than Corbin Russwin's standard list price and regardless of whether Corbin Russwin or its sales representatives have previously quoted discounted prices to the Distributor on some or all of its orders.

**NON-CATALOGED PRODUCTS**

Products not cataloged or listed in this price book will be considered as special products, and will not be manufactured without prior written approval from Corbin Russwin. A minimum special handling charge of \$50.00 will be added for non-cataloged product. Any additional labor or material required will be charged accordingly. Special products require special handling, and therefore standard lead times may not apply. Please consult with your Sales Representative for further details.

**CHANGES/CANCELLATION OF ORDERS**

Changes or cancellations to an order will result in a charge of costs for material and labor expenses that have been incurred prior to notification from Customer. If products have already been made and/or are located in the shipping room, the 45% restocking fee will apply. Handling charges are billed on Customer's original order. All Non-Cataloged Goods and Corbin Russwin Quick Ship Orders may not be changed or cancelled.

**ADD-ON ORDERS TO QUOTE**

Any new order requesting special pricing to match an existing quote number, which has already been ordered, will be accepted up to sixty (60) days after the acknowledgement of the original order. All add-on orders must reference the original factory order number, and the corresponding quote number to receive the quoted pricing discount. Add-on orders for stock will not be accepted.

**PACKAGING**

Many items are defined as to Case Lot Packaging or Minimum Order. The Case Lot policy does not apply to hardware to be used on a specific hardware project.

**DELIVERY**

Orders will be acknowledged and given a scheduled delivery date based on estimated manufacturing lead times. Complete information is required to process all orders. Orders with insufficient information for processing (i.e. keying information, door sizes, handing, etc.) may be subject to extended lead times which are relative to the time required in obtaining the necessary information for order processing. Manufacturing lead time will begin once all information is received to process an order. Corbin Russwin will use reasonable efforts to deliver products as estimated, but makes no guarantees as to delivery dates. Corbin Russwin will not be liable for back charges incurred based on availability of product or as a result of delays in delivery caused by insufficient information required to process an order. Corbin Russwin will not be held responsible for delays in delivery caused by strikes, fires, floods or any other causes beyond our control, including the delivery of material to us. Under no circumstances shall Corbin Russwin be liable or accountable for consequential damages due to failure of delivery.

**CLAIMS**

In the event of Company or Customer error, claims for shortages, pricing errors and/or incorrectly filled orders must be submitted in writing to Customer Service within thirty (30) days from receipt of material. Any claims for shortages or damage by the Carrier must be made by the Customer directly to the Carrier.

**Terms and Conditions continued****INVOICE DEDUCTION**

A Corbin Russwin Sales Representative or Customer Service Representative must be notified of any disputed invoices within sixty (60) days from the date of invoice. Deductions should only be taken for the disputed amount and the balance of the invoice is due and payable within standard payment terms.

**RETURNED GOODS**

It is the policy of Corbin Russwin to not accept returns of any materials that are correctly furnished as per the Distributor's Purchase Order. Return of product due to customer order error or accommodation must be pre-arranged with Corbin Russwin and approved in writing by Sales Management.

All products returned as "Goodwill" must meet the following criteria to be considered a return:

- Be in original, unmarked and undamaged cartons.
- Be valued in excess of \$250.00 net.
- Shipped and invoiced within the previous one hundred twenty (120) days.
- Custom, non-cataloged goods, master-keyed or Corbin Russwin Quick Ship product is not returnable.

A MINIMUM restocking fee of 45% will be charged. Upon receipt and verification by Corbin Russwin that the returned merchandise meets the foregoing conditions, a credit will be issued for the original invoice amount less the MINIMUM 45% restocking fee.

Defective goods and "Goodwill" products that meet the foregoing criteria may be returned by fulfilling the following conditions:

- Send an RGA request in writing to the Corbin Russwin Sales Representative serving the Purchaser's area.
- Ensure the RGA labels that are sent to Purchaser by Corbin Russwin are visible on return goods shipment.
- Ensure that the RGA number appears on the return shipment label and is legible.
- Return the authorized merchandise within sixty (60) days from the date of RGA issuance date.
- Return shipments must be freight prepaid to the location specified on the RGA.
- Corbin Russwin is not liable for damages to product during shipping.

No credit may be taken or issued prior to RGA approval and receipt of product.

All defective goods within the terms of our limited warranty may be returned for credit or replacement.

**RETURNED GOODS – ELECTROMECHANICAL**

All defective replacement requests for electromechanical products/components must be authorized by contacting the Electromechanical Applications Team at 1-800-810-WIRE to obtain a case number. In order to receive credit for the replacement of an electromechanical product the following criteria needs to be met:

- Defective product return must be under warranty
- Defective product/component return must arrive at factory within 60 days of the Returned Goods Authorization issuance
- Returned product must be found defective or nonfunctional upon test at factory
- Returned product must not have been damaged during installation process

**TAXES**

Prices do not include any present or future Federal, State, or Local property, license, privilege, sales, use, excise, gross receipts or other like taxes or assessments, which may result from transactions or any services performed in connection herewith.

**GOVERNING LAW**

The rights and obligations of the parties shall be governed by the laws of the State of North Carolina, excluding any conflicts of law provisions. The United Nations Convention on Contracts for the International Sale of Goods shall not apply to this Agreement.

**LIMITED WARRANTY**

The Terms and Conditions outlined above are subject to Corbin Russwin's Limited Warranty, which is included in this Price List and incorporated herein by reference.

**PRODUCT MODIFICATIONS**

Corbin Russwin products are not designed or intended for aftermarket modification. The warranty on Corbin Russwin products becomes void if the product is modified in any way, regardless of whether the modification causes or contributes to any alleged defect. Warranty voiding modifications include, but are not limited to, third-party electrification of non-electric products and/or the installation of non-approved or non-Corbin Russwin components.

If a Corbin Russwin product is modified it no longer meets industry certification and quality control standards applicable to the original product and is no longer a genuine Corbin Russwin product. A modified product may not be sold as a Corbin Russwin product and the Corbin Russwin and Design® trademark or certification marks based on the original Corbin Russwin product, such as U.L. or ANSI/BHMA marks, may not appear anywhere on the modified product or on any packaging, literature, or instructions sold with the modified product.

All original Corbin Russwin packaging and literature carries the Corbin Russwin and Design® trademark and must be destroyed if the original Corbin Russwin product is modified. Portions of the product that carry the Corbin Russwin and Design® trademark or certification mark must be discarded and/or replaced by the party making the modification. U.L. and other certification testing and marking are also the responsibility of the party making modification. The use of the Corbin Russwin and Design® trademark on modified products constitutes trademark infringement.

**Terms and Conditions continued****FIRE RATED OPENINGS**

Any retrofit or other field modification to a fire rated opening can potentially impact the fire rating of the opening, and Corbin Russwin, Inc. makes no representations or warranties concerning what such impact may be in any specific situation. When retrofitting any portion of an existing fire-rated opening, or specifying and installing a new fire-rated opening, please consult with a code specialist or local code official (Authority Having Jurisdiction) to ensure compliance with all applicable codes and ratings.

The following policy ("Policy") of ASSA ABLOY Americas ("ASSA ABLOY"), and all of its affiliated group companies (collectively, the "Group Companies"), applies to the use of certain intellectual property of all such Group Companies, including all trademarks, names, logos, product images, and related information (the "ASSA ABLOY Marks"). ASSA ABLOY Marks are proprietary and critical to the success of ASSA ABLOY and the Group Companies, and may only be used in strict compliance with this Policy.

This Policy covers any person or entity reselling any product of any Group Company with the consent of such Group Company (each, an "Approved Reseller"). Each Approved Reseller has a non-exclusive right to use certain of the ASSA ABLOY Marks relating to any of the Group Companies for which it is an Approved Reseller, subject to the following conditions:

- (1) Approved Reseller's use of ASSA ABLOY Marks must be truthful, fair, and not misleading;
- (2) Approved Reseller's advertising must clearly indicate that it is advertising of the Approved Reseller, and is not advertising of ASSA ABLOY;
- (3) Approved Reseller may not use any ASSA ABLOY Marks as part of or in connection with a domain name;
- (4) Approved Reseller's advertising must not imply or suggest an association between the Approved Reseller and ASSA ABLOY other than that of buyer and seller;
- (5) Approved Reseller's use of ASSA ABLOY Marks must be a positive representation of ASSA ABLOY, the Group Companies, and their products;
- (6) Approved Reseller's trade name must be more predominant on Approved Reseller's advertising than the ASSA ABLOY Marks;
- (7) Approved Reseller's use of ASSA ABLOY Marks must include the trademark symbol ® or ™, as appropriate, along with the following trademark legend printed in legible text on the Web page or document containing ASSA ABLOY Marks: "[describe ASSA ABLOY Marks] are trademarks or registered trademarks of ASSA ABLOY, Inc. or one of its affiliates in the United States and other countries.";
- (8) Approved Reseller must not make modifications of any ASSA ABLOY Marks; and
- (9) Approved Reseller may use only ASSA ABLOY Marks associated with the Group Companies for which it is an Approved Reseller (e.g., an Approved Reseller that sells Group Company X products but not Group Company Y products may use Group Company X trademarks in connection with its sale of Group Company X products, but may not use Group Company Y trademarks).

ASSA ABLOY reserves the right to review Approved Reseller's usage of ASSA ABLOY Marks at any time and may:

- (a) require changes to the use of ASSA ABLOY Marks at any time in its sole discretion, which changes must be implemented within 30 days of written notice to Approved Reseller;
- (b) condition the use of ASSA ABLOY Marks on ASSA ABLOY's prior approval of such use, which approval may be withheld in its sole discretion;
- (c) revoke permission to use ASSA ABLOY Marks at any time for any or no reason upon 30 days prior written notice to Approved Reseller; and
- (d) revoke permission to use ASSA ABLOY Marks immediately upon notice to Approved Reseller in the event Approved Reseller is in violation of this Policy, or of any other agreement with ASSA ABLOY or any Group Company.

Approved Reseller's right to use ASSA ABLOY Marks in no way conveys to Approved Reseller any proprietary or economic interest in any ASSA ABLOY Marks.

Use of ASSA ABLOY Marks in violation of this Policy may result in severe civil and criminal liabilities. ASSA ABLOY will vigorously enforce this Policy by seeking all appropriate legal remedies, including, but not limited to, pecuniary damages and injunctive relief.

If there are any questions on this policy, please contact Linda Dean at [ldean@assaabloyusa.com](mailto:ldean@assaabloyusa.com) or 203-498-5596.

**TECHNICAL INFORMATION AND ADVICE**

(a) All designs, data, and specifications provided by Company are proprietary and will not be disclosed or reused by Customer without the prior written consent of Company; (b) Company assumes no obligation or liability for any advice given by Company, the results obtained, or damages incurred, and all such advice is given and accepted at Customer's risk.

**Limited Warranty**

Corbin Russwin, Inc. (Company) warrants that its products sold under the Corbin Russwin and Design® trade name in the United States of America are free from defects in workmanship and materials under normal use and service. This warranty does not cover defects or damage arising from improper installation, lack of or improper maintenance, improper storage, shipping and handling, corrosion, erosion, ordinary wear and tear, misuse, abuse, accident, unauthorized service, or use with unauthorized non-Corbin Russwin products or parts. This warranty is void if any modification is made to the warranty product, regardless of whether the modification causes or contributes to the alleged defect. All modifications are made at the risk of the party making the modification.

The only liability of the Company in tort or contract whether under this warranty or otherwise shall be limited to the repair or replacement of any product or component part which shall prove defective as covered by this warranty, within the stated time frame listed below, after delivery to the original purchaser.

Access 3 Cylinders	. . . . .	1 year
Pyramid Cylinders	. . . . .	5 years
CL3100 Series Cylindrical Locksets	. . . . .	10 years
CL3300 Series Cylindrical Locksets	. . . . .	7 years
CL3500 Series Cylindrical Locksets	. . . . .	7 years
CL3800 Series Cylindrical Locksets	. . . . .	5 years
CK4300 Series Cylindrical Locksets	. . . . .	3 years
ML2000 Series Mortise Locksets	. . . . .	10 years
Electrified Locksets	. . . . .	2 years
ED3000, ED7000, ED8000 Series Exit Devices & Trim	. . . . .	1 year
ED4000, ED5000 Series Exit Devices & 900 Series Trim	. . . . .	5 years
All Other Exit Device Trim	. . . . .	1 year
Motorized Electric Latch Retraction (MELR)	. . . . .	5 years
Electrified Exit Devices	. . . . .	2 years
FE5400S	. . . . .	7 years
FE6600	. . . . .	7 years
FE6700	. . . . .	7 years
Access 800® CL33800 x TCAC2 Cylindrical	. . . . .	7 years (mechanical), 2 years (electrical)
Access 800® ML20800 x TCAC2 Mortise Locks	. . . . .	10 years (mechanical), 2 years (electrical)
Access 800® ED5000 x 9800 x TCAC2 Exit Devices	. . . . .	5 years (mechanical), 2 years (electrical)
DC3000 Series Closers	. . . . .	15 years
DC5000 Series Closers	. . . . .	10 years
DC6000 Series Closers	. . . . .	25 years
DC8000 Series Closers	. . . . .	25 years
All Other Corbin Russwin Products	. . . . .	1 year
MicroShield® Finish	. . . . .	1 year

**Finishes:**

Corbin Russwin finishes are covered by a limited warranty period of one year after invoice date.

**Warranty Requirements for Cylinders Factory or Field Combined:**

Cylinders are lubricated at the factory with a petroleum based lubricant (Medeco KeyLube). Cylinders should be lubricated periodically depending upon environmental conditions. Petroleum based lubricant is recommended. Never mix petroleum based lubricants with dry lubricants. Corbin Russwin cylinder and/or core warranty will be voided if used in non-Corbin Russwin locking devices.

**Warranty Requirements for Cylinders Field Combined:**

1. Keys shall be cut to the Corbin Russwin key biting specifications required for the particular keyway and depth system.
2. All pin lengths shall be selected according to prevailing factory standards.
3. Original Corbin Russwin cylinders and cylinder components, including pin tumblers and key blanks, shall be used. We reserve the right to void the warranty if we deem that a malfunction is a result of non-original components which do not conform to Corbin Russwin standards.

**Keying Systems:**

All bittings shall be originated or authorized by the Corbin Russwin Key Systems Department to be compatible with one another in a specific type of cylinder (Pyramid, conventional, security, master ring, interchangeable core) and within a particular keying system.

All components of electromagnetic products are covered by a limited warranty period of one year after invoice date thereof of the original purchaser from us. Product repair or replacement, or associated charges, will not be accepted under this warranty unless prior authorization from Corbin Russwin has been given. Upon receipt of products returned for repair or replacement, we will determine whether products qualify for repair or replacement under this warranty. If they do not, we will obtain authorization prior to proceeding.

We have no liability to pay any costs of repair performed by anyone other than qualified personnel authorized by Corbin Russwin prior to the work being done.



**Terms and Conditions continued**

The Company will not pay for the cost of repair performed other than in accordance with this warranty. Written notice of a product or component part believed to be defective as covered by this warranty should be sent to Corbin Russwin, Inc. 225 Episcopal Road, Berlin, CT 06037, and should include your name and address, an identification of the product or component part and a brief description of the defect. Upon receipt of such notice, the Company will inform you where to ship such product or component part, shipping charges prepaid, for examination and, in the event such examination reveals defect covered by this warranty, the product will be repaired or replaced. The Company reserves the right to replace discontinued product with an equivalent product as deemed by the Company.

THIS WARRANTY IS IN LIEU OF ALL OTHER EXPRESS WARRANTIES. TO THE EXTENT PERMITTED BY LAW, ALL IMPLIED WARRANTIES ARE LIMITED TO THE DURATION OF THIS WARRANTY. CORBIN RUSSWIN, INC. SHALL NOT BE LIABLE FOR ANY INCIDENTAL OR CONSEQUENTIAL DAMAGES. NO AGENT, SALES REPRESENTATIVE OR DEALER HAS THE AUTHORITY TO INCREASE OR ALTER THE OBLIGATIONS OF THIS WARRANTY. SOME STATES DO NOT ALLOW LIMITATIONS ON HOW LONG AN IMPLIED WARRANTY LASTS OR THE EXCLUSION OR LIMITATION OF INCIDENTAL OR CONSEQUENTIAL DAMAGES, SO THE ABOVE LIMITATION OR EXCLUSIONS MAY NOT APPLY TO YOU. THIS WARRANTY GIVES YOU SPECIFIC LEGAL RIGHTS, AND YOU MAY ALSO HAVE OTHER RIGHTS WHICH VARY FROM STATE TO STATE.

## Finishes

ANSI/BHMA Designation	Finish/Description
600	Primed for Painting (USP)
605	Bright Brass (US3)
606	Satin Brass (US4)
611	Bright Bronze (US9)
612	Satin Bronze (US10)
613	Dark Oxidized Satin Bronze, Oil Rubbed (US10B)
613E	Dark Oxidized Satin Bronze - Equivalent
613L	Dark Oxidized Satin Bronze, Clear Coated
618	Bright Nickel Plated (US14)
619	Satin Nickel Plated (US15)
622	Flat Black Coated (US19)
625	Bright Chromium Plated (US26)
626	Satin Chromium Plated (US26D)
628	Satin Aluminum, Clear Anodized (808 Mullion)
629*	Bright Stainless Steel (US32)
630*	Satin Stainless Steel (US32D)
689	Silver Aluminum Painted (SBL)
690	Dark Bronze Painted (LBL)
691	Light Bronze Painted (DBL)
693	Black Painted (FBL)
695	Dark Bronze Painted or Anodized (808 Mullion)
696	Satin Brass Painted (GBL)
722	Black oxidized bronze, oil rubbed
BSP	Black Suede Powder Coat

\*629 and 630 finish options are Not available for the following Muséo levers: 101, 104, 105,111, 112, 113, 114, 115, 116, 117, 119, 121, 122, 126, 127,130, 131, 132

## Samples

Display Mounts (Base Hardware not included). Price covers mount only.

For Product Series	Specify	Price
CL3100, CK4400	SM-CL-NTB	\$178.00
CL3300, CL3500, CL3800	SM-CL-TB	\$178.00
ML2000 x Sectional Trim (Lever, Knob, BLSS, HSS, HPSK)	SM-ML-L	\$166.00
ML2000 x BHSS trim	SM-ML-WAVE-CYL x TP	\$260.00
ML2000 x Roseless	SM-ML-RL	\$178.00
UT5200	SM-UT	\$178.00
HP3000	SM-CL-HP3000	\$217.00
Access 800® CL33800	SM-CL-A800	\$205.00
Access 800® ML20800	SM-ML-A800	\$286.00
Access 800® ED5000 x 9800	SM-ED-A800	\$310.00

Pyramid Sample Display Case

Specify	Price
PS-20-DC	\$310.00

Finish folder with cylinder scalps.

Specify	Price
FP	\$160.00

## Corbin Russwin Templates

Templates of Corbin Russwin products that are most commonly used are available through our website <http://www.corbinrusswin.com/en/site/corbin-russwin/Library/Product-Templates/>

**MUSEO® SERIES**
**PAGES**
**TL3700 Series:**

TL3700 Series: Museo Georgia, Pablo, Jackson, Salvador, Marc Levers & Inspire Trim:	21
TL3700 Series: Museo Georgia, Pablo, Jackson, Salvador, Marc Levers & Roses	22
TL3700 Series: Museo Josef Levers & Roses	23
TL3700 Series: Museo Josef, Georges Levers & Roses	24
TL3700 Series: Museo Piet Levers & Roses	25
TL3700 Series: Options	26

**ML2000 Series:**

ML2000 Series: Museo Georgia, Pablo, Jackson, Salvador, Marc Levers, Inspire Trim	27
ML2000 Series: Museo Georgia, Pablo, Jackson, Salvador, Marc Levers, Roses & Thumbturns	28
ML2000 Series: Museo Josef Levers, Roses & Thumbturns	29
ML2000 Series: Museo Josef, Georges Levers, Roses & Thumbturns	30
ML2000 Series: Museo Piet Levers, Roses & Thumbturns	31
ML2000 Series: Museo Piet Levers, Roses & Thumbturns	32
ML2000 Series: Museo Georgia, Pablo, Jackson, Salvador, Marc Levers & Escutcheons	33
ML2000 Series: Museo Josef Levers & Escutcheons	34
ML2000 Series: Museo Josef, Georges Levers & Escutcheons	35
ML2000 Series: Museo Piet Levers & Escutcheons	36
ML2000 Series: Museo Piet Levers & Escutcheons	37

**ML20900 Series & ML20600 Series NAC:**

ML20900 Series: Museo Georgia, Pablo, Jackson, Salvador, Marc Levers & Roses	38
ML20600 Series NAC: Museo Georgia, Pablo, Jackson, Salvador, Marc Levers & Roses	39
ML20900 Series: Museo Georgia, Pablo, Jackson, Salvador, Marc Levers, Escutcheons, Roses and Thumbturns	40
ML20600 Series NAC: Museo Georgia, Pablo, Jackson, Salvador, Marc Levers, Escutcheons, Roses and Thumbturns	41
ML20900 Series: Museo Josef Levers, Escutcheons, Roses and Thumbturns	42
ML20600 Series NAC: Museo Josef Levers, Escutcheons, Roses and Thumbturns	43
ML20900 Series: Museo Josef, Georges Levers, Escutcheons, Roses and Thumbturns	44
ML20600 Series NAC: Museo Josef, Georges Levers, Escutcheons, Roses and Thumbturns	45
ML20900 Series: Museo Piet Levers, Escutcheons, Roses and Thumbturns	46
ML20600 Series NAC: Museo Piet Levers, Escutcheons, Roses and Thumbturns	47
ML20900 Series: Museo Piet Levers, Escutcheons, Roses and Thumbturns	48
ML20600 Series NAC: Museo Piet Levers, Escutcheons, Roses and Thumbturns	49

**ML20800 AC2 Series:**

ML20800 AC2 Series: Museo Georgia, Pablo, Jackson, Salvador, Marc Levers	50
ML20800 AC2 Series: Museo Josef, Georges Levers	51
ML20800 AC2 Series: Museo Piet Levers	52

**ED5000 AC2 Series:**

ED5000 AC2 Series: Museo ML20800 AC2 Series: Museo Georgia, Pablo, Jackson, Salvador, Marc Levers	53
ED5000 AC2 Series: Museo ML20800 AC2 Series: Museo Josef, Georges Levers	54
ED5000 AC2 Series: Museo Piet Levers	55

**ED4000 Series Pushpad Exit Devices:**

ED4000 Series: Museo Levers with 800 Series Escutcheon: Georgia, Pablo, Jackson, Salvador, Marc Levers	56
ED4000 Series: Museo Levers with 800 Series Escutcheon: Piet Levers	57

**EDS000 Series:**

ED5000 Series: Museo Georgia, Pablo, Jackson, Salvador, Marc Levers with 900 Series Escutcheon	58
ED5000 Series: Museo Josef, Georges Levers with 900 Series Escutcheon	59
ED5000 Series: Museo Piet Levers with 900 Series Escutcheon	60

# Tubular Locksets

TL3700 Series: Muséo Levers and Inspire™ Roseless Trim

January 1, 2019

contemporary trim to complement the interior design of your next project

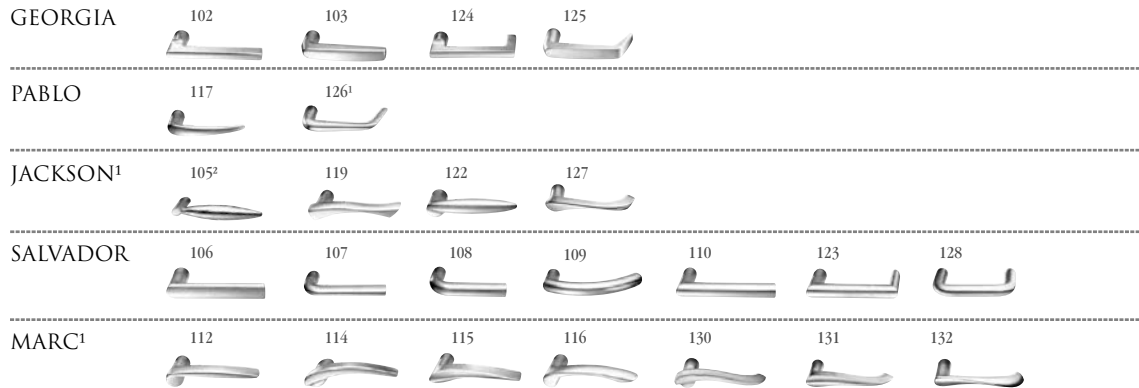

J Collar

<sup>1</sup>Handed: specify hand when ordering  
<sup>2</sup>Contact factory for current lead time

613E	Dark Oxidized Satin Bronze - Equivalent	605	Bright Brass, Clear Coated
626	Satin Chromium Plated	606	Satin Brass, Clear Coated
BSP	Black Suede Powder Coat	611	Bright Bronze, Clear Coated
		612	Satin Bronze, Clear Coated
		613	Dark Oxidized Satin Bronze, Oil Rubbed
		613L	Dark Oxidized Satin Bronze, Clear Coated
		618	Bright Nickel Plated
		619	Satin Nickel Plated
		625	Bright Chromium Plated
		629*	Bright Stainless Steel
		630*	Satin Stainless Steel
		722	Black Oxidized Bronze, Oil Rubbed

### Function

TL3710	Passage Set	\$236.00	\$246.00
TL3710A	Passage Set-3 Hour	\$242.00	\$252.00
TL3720	Privacy Set	\$248.00	\$258.00
TL3720A	Privacy Set-3 Hour	\$254.00	\$264.00
TL3750	Single Lever Pull-Through Bolted	\$104.00	\$109.00
TL3770	Double Lever Pull	\$195.00	\$205.00
TL3780	Communicating Set	\$236.00	\$246.00
TL3780A	Communicating Set-3 Hour	\$242.00	\$252.00

Ordering Example Details →

TL3710 Passage: Non-Keyed tubular lock  
 102J Georgia Family Lever, J Collar  
 626 Satin Chrome Finish  
 LH Left Handed

Trim Only				
Quantity	Series/Function	Trim	Finish	Hand
24	TL3710	102J	626	LH

\*629 and \*630 finish options are Not available for all Muséo levers. Please refer to page 20 for availability.



**ASSA ABLOY**

ASSA ABLOY, the global leader in door opening solutions

Corbin Russwin is a brand associated with ASSA ABLOY Access and Egress Hardware Group, Inc., an ASSA ABLOY Group company. Copyright © 2019, ASSA ABLOY Access and Egress Hardware Group, Inc. All rights reserved. Reproduction in whole or in part without the express written permission of ASSA ABLOY Access and Egress Hardware Group, Inc. is prohibited.

Contact us at: 800-543-3658 or visit [www.corbinrusswin.com](http://www.corbinrusswin.com). In Canada contact us at: 800-461-3007 or visit [www.assaabloydss.ca](http://www.assaabloydss.ca)

# Tubular Locksets

TL3700 Series: Muséo Levers and Roses

January 1, 2019

contemporary trim to complement the interior design of your next project

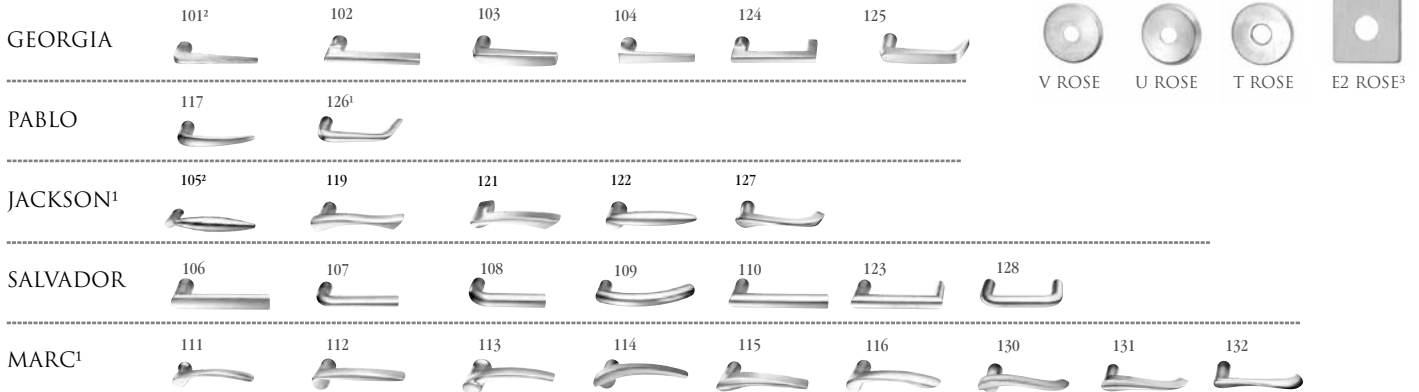

<sup>1</sup>Handed: specify hand when ordering

<sup>2</sup>Contact factory for current lead time

<sup>3</sup>**CAUTION:** Cannot retrofit on existing cylindrical lock door preps with through-bolt holes outside the 2-1/8" bored hole (Ex. CL3300 & CL3500).

613E	Dark Oxidized Satin Bronze - Equivalent	605	Bright Brass, Clear Coated
626	Satin Chromium Plated	606	Satin Brass, Clear Coated
BSP	Black Suede Powder Coat	611	Bright Bronze, Clear Coated
		612	Satin Bronze, Clear Coated
		613	Dark Oxidized Satin Bronze, Oil Rubbed
		613L	Dark Oxidized Satin Bronze, Clear Coated
		618	Bright Nickel Plated
		619	Satin Nickel Plated
		625	Bright Chromium Plated
		629*	Bright Stainless Steel
		630*	Satin Stainless Steel
		722	Black Oxidized Bronze, Oil Rubbed

## Function

TL3710	Passage Set	\$220.00	\$230.00
TL3710A	Passage Set-3 Hour	\$226.00	\$236.00
TL3720	Privacy Set	\$232.00	\$242.00
TL3720A	Privacy Set-3 Hour	\$238.00	\$248.00
TL3750	Single Lever Pull-Through Bolted	\$127.00	\$132.00
TL3750S	Single Lever Pull-Surface Mounted	\$97.00	\$107.00
TL3770	Double Lever Pull	\$184.00	\$194.00
TL3780	Communicating Set	\$220.00	\$230.00
TL3780A	Communicating Set-3 Hour	\$226.00	\$236.00

Ordering Example Details →

TL3710 Passage: Non-Keyed tubular lock  
 111T Marc Lever, T-Rose  
 626 Satin Chrome Finish  
 LH Left Handed

Trim Only				
Quantity	Series/Function	Trim	Finish	Hand
24	TL3710	111T	626	LH

\*629 and \*630 finish options are Not available for all Muséo levers. Please refer to page 20 for availability.



ASSA ABLOY

# Tubular Locksets

TL3700 Series: Muséo Levers and Roses

January 1, 2019

contemporary levers to complement the interior design of your next project



JOSEF

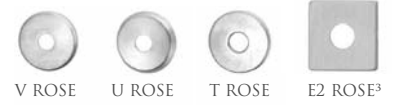

<sup>1</sup>Handed: specify hand when ordering

<sup>2</sup>Contact factory for current lead time

<sup>3</sup>**CAUTION:** Cannot retrofit on existing cylindrical lock door preps with through-bolt holes outside the 2-1/8" bored hole (Ex. CL3300 & CL3500).

613E Dark Oxidized Satin Bronze - Equivalent  
626 Satin Chromium Plated  
BSP Black Suede Powder Coat

605 Bright Brass, Clear Coated  
606 Satin Brass, Clear Coated  
611 Bright Bronze, Clear Coated  
612 Satin Bronze, Clear Coated  
613 Dark Oxidized Satin Bronze, Oil Rubbed  
613L Dark Oxidized Satin Bronze, Clear Coated  
618 Bright Nickel Plated  
619 Satin Nickel Plated  
625 Bright Chromium Plated  
629 Bright Stainless Steel  
630 Satin Stainless Steel  
722 Black Oxidized Bronze, Oil Rubbed

## Function

TL3710	Passage Set	\$230.00	\$240.00
TL3710A	Passage Set-3 Hour	\$236.00	\$246.00
TL3720	Privacy Set	\$244.00	\$254.00
TL3720A	Privacy Set-3 Hour	\$250.00	\$260.00
TL3750	Single Lever Pull-Through Bolted	\$130.00	\$140.00
TL3750S	Single Lever Pull-Surface Mounted	\$100.00	\$110.00
TL3770	Double Lever Pull	\$194.00	\$204.00
TL3780	Communicating Set	\$230.00	\$240.00
TL3780A	Communicating Set-3 Hour	\$236.00	\$246.00

Ordering Example Details →

TL3710 Passage: Non-Keyed tubular lock  
133E2 Josef Lever, E2 Rose  
626 Satin Chrome Finish  
LH Left Handed

Trim Only				
Quantity	Series/Function	Trim	Finish	Hand
24	TL3710	133E2	626	LH



**ASSA ABLOY**

ASSA ABLOY, the global leader in door opening solutions

Corbin Russwin is a brand associated with ASSA ABLOY Access and Egress Hardware Group, Inc., an ASSA ABLOY Group company. Copyright © 2019, ASSA ABLOY Access and Egress Hardware Group, Inc. All rights reserved. Reproduction in whole or in part without the express written permission of ASSA ABLOY Access and Egress Hardware Group, Inc. is prohibited.

Contact us at: 800-543-3658 or visit [www.corbinrusswin.com](http://www.corbinrusswin.com). In Canada contact us at: 800-461-3007 or visit [www.assaabloydss.ca](http://www.assaabloydss.ca)

# Tubular Locksets

TL3700 Series: Muséo Levers and Roses

January 1, 2019

contemporary levers to complement the interior design of your next project

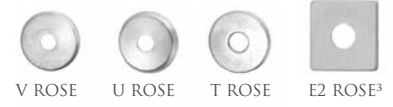
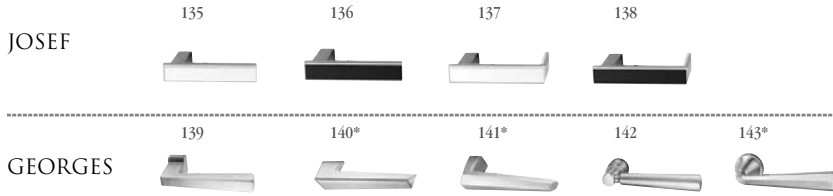

\*Georges Levers 140, 141 and 143 are not available for the following functions: TL3720 and TL3720A

<sup>1</sup>Handed: specify hand when ordering  
<sup>2</sup>Contact factory for current lead time  
<sup>3</sup>CAUTION: Cannot retrofit on existing cylindrical lock door preps with through-bolt holes outside the 2-1/8" bored hole (Ex. CL3300 & CL3500).

613E	Dark Oxidized Satin Bronze - Equivalent	605	Bright Brass, Clear Coated
626	Satin Chromium Plated	606	Satin Brass, Clear Coated
BSP	Black Suede Powder Coat	611	Bright Bronze, Clear Coated
		612	Satin Bronze, Clear Coated
		613	Dark Oxidized Satin Bronze, Oil Rubbed
		613L	Dark Oxidized Satin Bronze, Clear Coated
		618	Bright Nickel Plated
		619	Satin Nickel Plated
		625	Bright Chromium Plated
		629	Bright Stainless Steel
		630	Satin Stainless Steel
		722	Black Oxidized Bronze, Oil Rubbed

### Function

TL3710	Passage Set	\$305.00	\$315.00
TL3710A	Passage Set-3 Hour	\$311.00	\$321.00
TL3720*	Privacy Set	\$317.00	\$327.00
TL3720A*	Privacy Set-3 Hour	\$323.00	\$333.00
TL3750	Single Lever Pull-Through Bolted	\$205.00	\$215.00
TL3750S	Single Lever Pull-Surface Mounted	\$175.00	\$185.00
TL3770	Double Lever Pull	\$268.00	\$278.00
TL3780	Communicating Set	\$305.00	\$315.00
TL3780A	Communicating Set-3 Hour	\$311.00	\$321.00

Ordering Example Details →

TL3710 Passage: Non-Keyed tubular lock  
 135E2 Josef Lever, E2 Rose  
 626 Satin Chrome Finish  
 LH Left Handed

Trim Only				
Quantity	Series/Function	Trim	Finish	Hand
24	TL3710	135E2	626	LH



ASSA ABLOY

# Tubular Locksets

TL3700 Series: Muséo Levers and Roses

January 1, 2019

contemporary trim to complement the interior design of your next project



PIET



629	Bright Stainless Steel
630	Satin Stainless Steel

### Function

TL3710	Passage Set	240.00
TL3710A	Passage Set - 3 Hour	246.00
TL3720	Privacy Set	254.00
TL3720A	Privacy Set - 3 Hour	260.00
TL3750	Single Lever Pull - Through Bolted	140.00
TL3750S	Single Lever Pull - Surface Mounted	110.00
TL3770	Double Lever Pull	204.00
TL3780	Communicating Set	240.00
TL3780A	Communicating Set - 3 Hour	246.00

PIET



629	Bright Stainless Steel
630	Satin Stainless Steel

### Function

TL3710	Passage Set	297.00
TL3710A	Passage Set - 3 Hour	303.00
TL3720	Privacy Set	308.00
TL3720A	Privacy Set - 3 Hour	314.00
TL3750	Single Lever Pull - Through Bolted	191.00
TL3750S	Single Lever Pull - Surface Mounted	161.00
TL3770	Double Lever Pull	253.00
TL3780	Communicating Set	297.00
TL3780A	Communicating Set - 3 Hour	303.00

PIET



629	Bright Stainless Steel
630	Satin Stainless Steel

### Function

TL3710	Passage Set	315.00
TL3710A	Passage Set - 3 Hour	321.00
TL3720	Privacy Set	327.00
TL3720A	Privacy Set - 3 Hour	333.00
TL3750	Single Lever Pull - Through Bolted	215.00
TL3750S	Single Lever Pull - Surface Mounted	185.00
TL3770	Double Lever Pull	278.00
TL3780	Communicating Set	315.00
TL3780A	Communicating Set - 3 Hour	321.00

### Ordering Example Details

TL3710 Passage: Non-Keyed tubular lock  
 21WU Piet Family Lever - Wood Insert, U-Rose  
 29BH29 Lever Finish  
 Wood insert with polished stainless steel (629) shank and polished stainless steel (629) grip  
 629 Lock Finish  
 LH Left Handed

### Stock Order

Quantity	Series/Function	Trim	Lever Finish	Lock Finish	Hand
2	TL3710	21WU	29BH29	629	LH

**CAUTION:** Cannot retrofit on existing cylindrical lock door preps with through-bolt holes outside the 2-1/8" bored hole (Ex. CL3300 & CL3500).



**ASSA ABLOY**

ASSA ABLOY, the global leader in door opening solutions

Corbin Russwin is a brand associated with ASSA ABLOY Access and Egress Hardware Group, Inc., an ASSA ABLOY Group company. Copyright © 2019, ASSA ABLOY Access and Egress Hardware Group, Inc. All rights reserved. Reproduction in whole or in part without the express written permission of ASSA ABLOY Access and Egress Hardware Group, Inc. is prohibited. Contact us at: 800-543-3658 or visit [www.corbinrusswin.com](http://www.corbinrusswin.com). In Canada contact us at: 800-461-3007 or visit [www.assaabloydss.ca](http://www.assaabloydss.ca)



**Door Thickness Options**

Description	Specify Quick Code	Add or Deduct
1-3/8" (35mm) up to 1-3/4" (44mm)	D138	No Charge
1-3/4" (44mm) up to 2-1/4" (57mm)	(standard)	
2-1/4" (57mm) up to 2-1/2" (64mm)	D214	
(Consult factory if over 2-1/2" (64mm))		

**Backset Options**

Description	Specify Quick Code	Add or Deduct
2-3/4"	(standard)	No Charge
2-3/8" <sup>1</sup>	B238	

**Strike Options**

Lip Length	ANSI Curved Lip - Specify Quick Code	Curved Lip Box - Specify Quick Code	Full Lip Specify Quick Code	Full Lip Radius Corner Specify Quick Code	Add or Deduct
1"	SA100	SC100			No Charge
1-1/8"	SA118	SC118			
1-1/4"	SA114	(standard)	SF114	SFR114	
1-3/8"	SA138	SC138			
1-1/2"	SA112	SC112 <sup>2</sup>			Add \$16.00 per lockset
1-3/4"	SA134	SC134			
2"	SA200	SC200			
2-1/4"	SA214	SC214			
2-1/2"	SA212	SC212			
2-3/4"	SA234	SC234			
3"	SA300	SC300			

**Miscellaneous Options**

Description	Specify Quick Code	Add or Deduct
Latch front, rounded corners	M13	Add \$2.50 per latch
1" (25mm) latch front, square corners <sup>3</sup>	M14	Add \$6.00 per lockset
1" (25mm) latch front, rounded corners	M15	Add \$2.50 per latch
ANSI wrought strike box	M17	Add \$6.00 per lockset

Notes:

1. 1" front supplied standard
2. Standard for D214
3. Standard for 2-3/8" backset



**ASSA ABLOY**

# Mortise Locksets

ML2000 Series: Muséo Levers and Inspire™ Roseless Trim

January 1, 2019

contemporary trim to complement the interior design of your next project

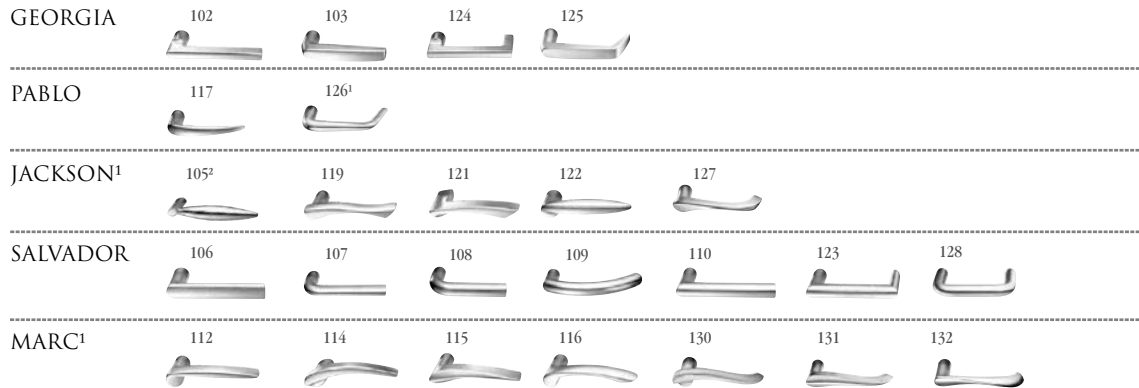

J Collar

<sup>1</sup>Handed: specify hand when ordering.

<sup>2</sup>Contact factory for current lead time.

\*629 and \*630 finish options are Not available for all Muséo levers. Please refer to page 20 for availability.

613E	Dark Oxidized Satin Bronze - Equivalent	605	Bright Brass, Clear Coated	618	Bright Nickel Plated
626	Satin Chromium Plated	606	Satin Brass, Clear Coated	619	Satin Nickel Plated
BSP	Black Suede Powder Coat	611	Bright Bronze, Clear Coated	625	Bright Chromium Plated
		612	Satin Bronze, Clear Coated	629*	Bright Stainless Steel
		613	Dark Oxidized Satin Bronze, Oil Rubbed	630*	Satin Stainless Steel
		613L	Dark Oxidized Satin Bronze, Clear Coated	722	Black Oxidized Bronze, Oil Rubbed

### Function

Function	Model	Description	Price	Price		
Non-Keyed	ML2010	Passage	\$864.00	\$888.00		
	ML2020	Privacy	\$970.00	\$994.00		
	ML2030	Privacy	\$934.00	\$958.00		
	ML2060	Half Dummy	\$336.00	\$348.00		
	ML2070	Full Dummy	\$672.00	\$696.00		
	ML2080	Half Active Dummy Trim	\$561.00	\$573.00		
	ML2090	Full Active Dummy Trim	\$897.00	\$921.00		
Single Cylinder	ML2003	Classroom	\$1,020.00	\$1,044.00		
	ML2051	Office				
	ML2055	Classroom				
	ML2056	Classroom Holdback				
	ML2057	Storeroom	\$1,033.00	\$1,057.00		
	ML2069	Institution Privacy				
	ML2053	Entrance				
Single Cylinder with Deadbolt	ML2054	Entrance	\$1,056.00	\$1,080.00		
	ML2058	Entrance Holdback				
	ML2068	Privacy or Classroom				
	ML2024	Entrance			\$1,111.00	\$1,135.00
	ML2048	Entrance				
	ML2049	Storeroom Deadbolt				
	ML2059	Security Storeroom				
ML2065	Dormitory					
ML2067	Apartment					
ML2073	Classroom Security					
Double Cylinder	ML2075	Entrance/Office	\$1,106.00	\$1,130.00		
	ML2029	Hotel				
	ML2002	Classroom Intruder			\$1,142.00	\$1,166.00
	ML2032	Institution				
	ML2042	Entrance				
ML2052	Classroom Intruder					
Double Cylinder with Deadbolt	ML2087	Security Vestibule	\$707.00	\$731.00		
	ML2022	Store Door				
	ML2062	Intruder Deadbolt				
	ML2072	Classroom Security Intruder				
	ML2082	Dormitory				
ML2092	Security Institution					
Full Working Trim (Quick Code M31) No cylinder; includes thumbturn lever			\$707.00	\$731.00		



### Ordering Example Details

<b>ML2000</b>	ML2051	Office Function
Sectional Trim	102	Georgia Family Lever
(rose)	J	Collar
	625	Finish
	RHR	Handing

### Stock Order

Quantity	Series/Function	Trim	Finish	Hand
24	ML2051	102J	625	RHR



**ASSA ABLOY**

ASSA ABLOY, the global leader in door opening solutions

Corbin Russwin is a brand associated with ASSA ABLOY Access and Egress Hardware Group, Inc., an ASSA ABLOY Group company. Copyright © 2019, ASSA ABLOY Access and Egress Hardware Group, Inc. All rights reserved. Reproduction in whole or in part without the express written permission of ASSA ABLOY Access and Egress Hardware Group, Inc. is prohibited.

Contact us at: 800-543-3658 or visit [www.corbinrusswin.com](http://www.corbinrusswin.com). In Canada contact us at: 800-461-3007 or visit [www.assaabloydss.ca](http://www.assaabloydss.ca)

# Mortise Locksets

ML2000 Series: Muséo Levers, Roses and Thumbturns

January 1, 2019

contemporary levers to complement the interior design of your next project

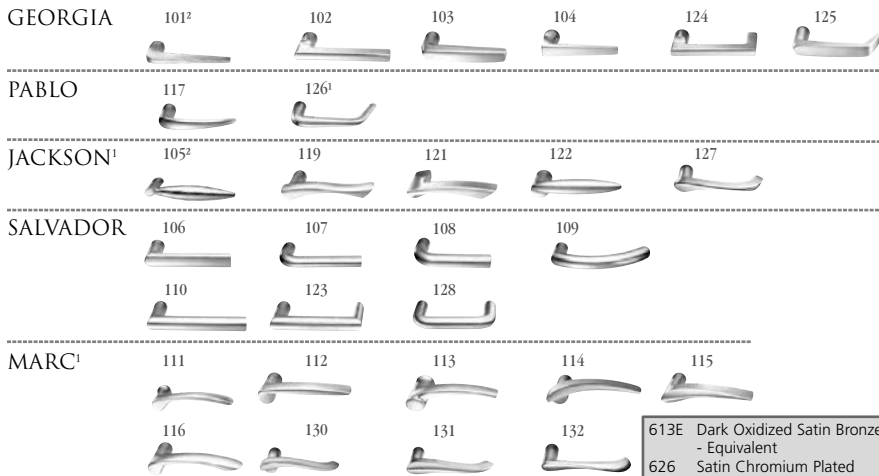

## ROSES

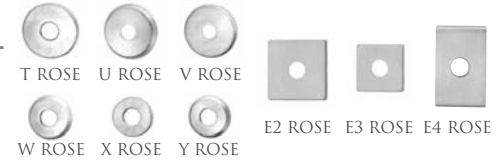

## THUMBTURNS<sup>3</sup>



1. Handed: specify hand when ordering
2. Contact factory for current lead time
3. Specify thumbturn as quick code. Thumbturn backplate will match shape of rose chosen (i.e. round or square)

\*629 and \*630 finish options are Not available for all Muséo levers. Please refer to page 20 for availability.

613E	Dark Oxidized Satin Bronze - Equivalent
626	Satin Chromium Plated
BSP	Black Suede Powder Coat

605	Bright Brass, Clear Coated	618	Bright Nickel Plated
606	Satin Brass, Clear Coated	619	Satin Nickel Plated
611	Bright Bronze, Clear Coated	625	Bright Chromium Plated
612	Satin Bronze, Clear Coated	629*	Bright Stainless Steel
613	Dark Oxidized Satin Bronze, Oil Rubbed	630*	Satin Stainless Steel
613L	Dark Oxidized Satin Bronze, Clear Coated	722	Black Oxidized Bronze, Oil Rubbed

## Function

Function	Model	Description	Price	Price
Non-Keyed	ML2010	Passage	\$811.00	\$835.00
	ML2020	Privacy		
	ML2030	Privacy	\$917.00	\$941.00
	ML2060	Privacy	\$886.00	\$910.00
	ML2050	Half Dummy	\$462.00	\$486.00
	ML2070	Full Dummy	\$924.00	\$948.00
	ML2080	Half Active Dummy Trim	\$388.00	\$412.00
	ML2090	Full Active Dummy Trim	\$850.00	\$874.00
Single Cylinder	ML2003	Classroom		
	ML2051	Office		
	ML2055	Classroom	\$967.00	\$991.00
	ML2056	Classroom Holdback		
	ML2057	Storeroom		
	ML2069	Institution Privacy		
	ML2053	Entrance		
ML2054	Entrance	\$980.00	\$1,004.00	
ML2058	Entrance Holdback			
ML2068	Privacy or Classroom			
Single Cylinder with Deadbolt	ML2024	Entrance		
	ML2048	Entrance		
	ML2049	Storeroom Deadbolt		
	ML2059	Security Storeroom	\$1,003.00	\$1,027.00
	ML2065	Dormitory		
	ML2067	Apartment		
	ML2073	Classroom Security		
ML2075	Entrance/Office			
ML2029	Hotel	\$1,058.00	\$1,082.00	
Double Cylinder	ML2002	Classroom Intruder		
	ML2032	Institution		
	ML2042	Entrance	\$1,053.00	\$1,077.00
	ML2052	Classroom Intruder		
ML2087	Security Vestibule			
Double Cylinder with Deadbolt	ML2022	Store Door		
	ML2062	Intruder Deadbolt		
	ML2072	Classroom Security Intruder	\$1,089.00	\$1,113.00
	ML2082	Dormitory		
ML2092	Security Institution			
Full Working Trim (Quick Code M31) No cylinder; includes thumbturn lever			\$827.00	\$851.00



### Ordering Example Details

<b>ML2000</b>	Sectional Trim (rose)	ML2051	Office Function
111		111	Marc Family Lever
W		W	Rose
625		625	Finish
RHR		RHR	Handing

### Stock Order

Quantity	Series/Function	Trim	Finish	Hand
24	ML2051	111W	625	RHR



**ASSA ABLOY**

Corbin Russwin is a brand associated with ASSA ABLOY Access and Egress Hardware Group, Inc., an ASSA ABLOY Group company. Copyright © 2019, ASSA ABLOY Access and Egress Hardware Group, Inc. All rights reserved. Reproduction in whole or in part without the express written permission of ASSA ABLOY Access and Egress Hardware Group, Inc. is prohibited.

# Mortise Locksets

ML2000 Series: Muséo Levers, Roses and Thumbturns

January 1, 2019

contemporary levers to complement the interior design of your next project



## ROSES

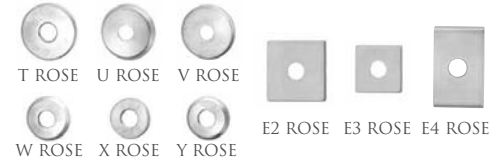

## THUMBTURN<sup>3</sup>



1. Handed: specify hand when ordering
2. Contact factory for current lead time
3. Specify thumbturn as quick code. Thumbturn backplate will match shape of rose chosen (i.e. round or square)

613E	Dark Oxidized Satin Bronze - Equivalent	605	Bright Brass, Clear Coated	618	Bright Nickel Plated
626	Satin Chromium Plated	606	Satin Brass, Clear Coated	619	Satin Nickel Plated
BSP	Black Suede Powder Coat	611	Bright Bronze, Clear Coated	625	Bright Chromium Plated
		612	Satin Bronze, Clear Coated	629	Bright Stainless Steel
		613	Dark Oxidized Satin Bronze, Oil Rubbed	630	Satin Stainless Steel
		613L	Dark Oxidized Satin Bronze, Clear Coated	722	Black Oxidized Bronze, Oil Rubbed

## Function

Function	Model	Description	Price	Price
Non-Keyed	ML2010	Passage	\$920.00	\$944.00
	ML2020	Privacy		
	ML2030	Privacy	\$982.00	\$1,006.00
	ML2060	Privacy	\$951.00	\$975.00
	ML2050	Half Dummy	\$353.00	\$377.00
	ML2070	Full Dummy	\$730.00	\$754.00
	ML2080	Half Active Dummy Trim	\$543.00	\$567.00
	ML2090	Full Active Dummy Trim	\$920.00	\$944.00
Single Cylinder	ML2003	Classroom		
	ML2051	Office		
	ML2055	Classroom		
	ML2056	Classroom Holdback	\$1,032.00	\$1,056.00
	ML2057	Storeroom		
	ML2069	Institution Privacy		
	ML2053	Entrance		
ML2054	Entrance			
	ML2058	Entrance Holdback	\$1,045.00	\$1,069.00
	ML2068	Privacy or Classroom		
Single Cylinder with Deadbolt	ML2024	Entrance		
	ML2048	Entrance		
	ML2049	Storeroom Deadbolt		
	ML2059	Security Storeroom	\$1,068.00	\$1,092.00
	ML2065	Dormitory		
	ML2067	Apartment		
	ML2073	Classroom Security		
ML2075	Entrance/Office			
	ML2029	Hotel	\$1,123.00	\$1,147.00
Double Cylinder	ML2002	Classroom Intruder		
	ML2032	Institution		
	ML2042	Entrance	\$1,118.00	\$1,142.00
	ML2052	Classroom Intruder		
	ML2087	Security Vestibule		
Double Cylinder with Deadbolt	ML2022	Store Door		
	ML2062	Intruder Deadbolt		
	ML2072	Classroom Security Intruder	\$1,154.00	\$1,178.00
	ML2082	Dormitory		
	ML2092	Security Institution		
Full Working Trim (Quick Code M31) No cylinder; includes thumbturn lever			\$720.00	\$744.00



### Ordering Example Details

<b>ML2000</b>	Office Function
Sectional Trim (rose)	Josef Family Lever
133	Rose
E4	Finish
625	Handing
RHR	

### Stock Order

Quantity	Series/Function	Trim	Finish	Hand
24	ML2051	133E4	625	RHR



ASSA ABLOY, the global leader in door opening solutions

Corbin Russwin is a brand associated with ASSA ABLOY Access and Egress Hardware Group, Inc., an ASSA ABLOY Group company. Copyright © 2019, ASSA ABLOY Access and Egress Hardware Group, Inc. All rights reserved. Reproduction in whole or in part without the express written permission of ASSA ABLOY Access and Egress Hardware Group, Inc. is prohibited.

Contact us at: 800-543-3658 or visit [www.corbinrusswin.com](http://www.corbinrusswin.com). In Canada contact us at: 800-461-3007 or visit [www.assaabloydss.ca](http://www.assaabloydss.ca)

# Mortise Locksets

ML2000 Series: Muséo Levers, Roses and Thumbturns

January 1, 2019

contemporary levers to complement the interior design of your next project

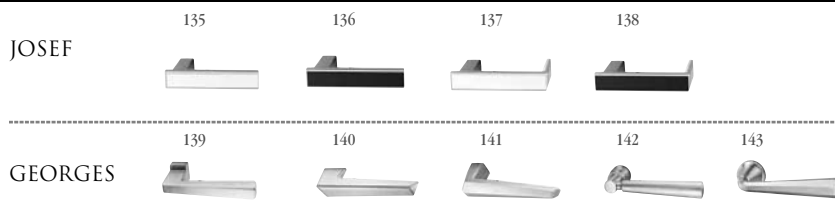

## ROSES

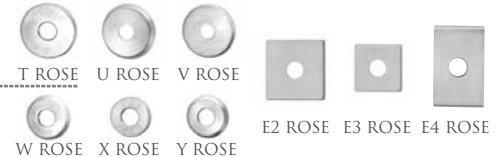

## THUMBTURNS<sup>3</sup>

1. Handed: specify hand when ordering
2. Contact factory for current lead time
3. Specify thumbturn as quick code. Thumbturn backplate will match shape of rose chosen (i.e. round or square)

613E	Dark Oxidized Satin Bronze - Equivalent	605	Bright Brass, Clear Coated	618	Bright Nickel Plated
626	Satin Chromium Plated	606	Satin Brass, Clear Coated	619	Satin Nickel Plated
BSP	Black Suede Powder Coat	611	Bright Bronze, Clear Coated	625	Bright Chromium Plated
		612	Satin Bronze, Clear Coated	629	Bright Stainless Steel
		613	Dark Oxidized Satin Bronze, Oil Rubbed	630	Satin Stainless Steel
		613L	Dark Oxidized Satin Bronze, Clear Coated	722	Black Oxidized Bronze, Oil Rubbed

## Function

Function	Model	Description	Price	Price
Non-Keyed	ML2010	Passage	\$996.00	\$1,020.00
	ML2020	Privacy	\$1,058.00	\$1,082.00
	ML2030	Privacy	\$1,022.00	\$1,046.00
	ML2050	Half Dummy	\$384.00	\$408.00
	ML2070	Full Dummy	\$792.00	\$816.00
	ML2080	Half Active Dummy Trim	\$583.00	\$607.00
	ML2090	Full Active Dummy Trim	\$991.00	\$1,015.00
Single Cylinder	ML2003	Classroom	\$1,108.00	\$1,132.00
	ML2051	Office		
	ML2055	Classroom		
	ML2056	Classroom Holdback		
	ML2057	Storeroom	\$1,121.00	\$1,145.00
	ML2069	Institution Privacy		
	ML2053	Entrance		
Single Cylinder with Deadbolt	ML2054	Entrance	\$1,144.00	\$1,168.00
	ML2058	Entrance Holdback		
	ML2068	Privacy or Classroom		
	ML2024	Entrance		
	ML2048	Entrance	\$1,199.00	\$1,223.00
	ML2049	Storeroom Deadbolt		
	ML2059	Security Storeroom		
	ML2065	Dormitory		
Double Cylinder	ML2067	Apartment	\$1,194.00	\$1,218.00
	ML2073	Classroom Security		
	ML2075	Entrance/Office		
	ML2029	Hotel		
	Double Cylinder with Deadbolt	ML2002	Classroom Intruder	\$1,230.00
ML2032		Institution		
ML2042		Entrance		
ML2052		Classroom Intruder		
ML2087		Security Vestibule		
Double Cylinder with Deadbolt	ML2022	Store Door	\$1,230.00	\$1,254.00
	ML2062	Intruder Deadbolt		
	ML2072	Classroom Security Intruder		
	ML2082	Dormitory		
	ML2092	Security Institution		
Full Working Trim (Quick Code M31) No cylinder; includes thumbturn lever			\$794.00	\$818.00



### Ordering Example Details

<b>ML2000</b>	ML2051	Office Function
Sectional Trim (rose)	135	Josef Family Lever
	E4	Rose
	625	Finish
	RHR	Handing

### Stock Order

Quantity	Series/Function	Trim	Finish	Hand
24	ML2051	135E4	625	RHR



ASSA ABLOY

# Mortise Locksets

ML2000 Series: Muséo Levers, Roses and Thumbturns

January 1, 2019

contemporary trim to complement the interior design of your next project



## PIET



## ROSES

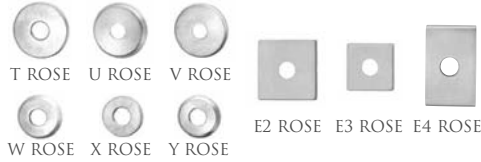

## THUMBTURNS



629	Bright Stainless Steel
630	Satin Stainless Steel

Specify thumbturn as quick code. Thumbturn backplate will match shape of rose chosen (i.e. round or square)

### Function

Function	Model	Description	Price
Non-Keyed	ML2010	Passage	\$944.00
	ML2020	Privacy	\$1,006.00
	ML2030	Privacy	\$975.00
	ML2060	Privacy	\$377.00
	ML2050	Half Dummy	\$754.00
	ML2070	Full Dummy	\$567.00
	ML2080	Half Active Dummy Trim	\$944.00
Single Cylinder	ML2003	Classroom	\$1,056.00
	ML2051	Office	
	ML2055	Classroom	
	ML2056	Classroom Holdback	
	ML2057	Storeroom	
	ML2069	Institution Privacy	\$1,069.00
	ML2053	Entrance	
	ML2054	Entrance	
	ML2058	Entrance Holdback	
	ML2068	Privacy or Classroom	
Single Cylinder with Deadbolt	ML2024	Entrance	\$1,092.00
	ML2048	Entrance	
	ML2049	Storeroom Deadbolt	
	ML2059	Security Storeroom	
	ML2065	Dormitory	
	ML2067	Apartment	
	ML2073	Classroom Security	
	ML2075	Entrance/Office	
ML2029	Hotel	\$1,147.00	
Double Cylinder	ML2002	Classroom Intruder	\$1,142.00
	ML2032	Institution	
	ML2042	Entrance	
	ML2052	Classroom Intruder	
Double Cylinder with Deadbolt	ML2087	Security Vestibule	\$1,178.00
	ML2022	Store Door	
	ML2062	Intruder Deadbolt	
	ML2072	Classroom Security Intruder	
	ML2082	Dormitory	
ML2092	Security Institution		
Full Working Trim (Quick Code M31) No cylinder; includes thumbturn lever			\$744.00



### Ordering Example Details

<b>ML2000</b>	ML2051	Office Function
Sectional Trim	21M	Piet Family Lever - Polished with Satin Insert
(rose)	V	Rose
	293029	Lever Finish
		Polished with satin stainless steel insert (630),
		polished stainless steel (629) shank and
		polished stainless steel (629) grip
	629	Lock Finish
	RHR	Handing

### Stock Order

Quantity	Series/Function	Trim	Lever Finish	Lock Finish	Hand
2	ML2051	21MV	293029	629	RHR



## ASSA ABLOY

ASSA ABLOY, the global leader in door opening solutions

Corbin Russwin is a brand associated with ASSA ABLOY Access and Egress Hardware Group, Inc., an ASSA ABLOY Group company. Copyright © 2019, ASSA ABLOY Access and Egress Hardware Group, Inc. All rights reserved. Reproduction in whole or in part without the express written permission of ASSA ABLOY Access and Egress Hardware Group, Inc. is prohibited.

Contact us at: 800-543-3658 or visit [www.corbinrusswin.com](http://www.corbinrusswin.com). In Canada contact us at: 800-461-3007 or visit [www.assaabloydss.ca](http://www.assaabloydss.ca)

# Mortise Locksets

ML2000 Series: Muséo Levers, Roses and Thumbturns

January 1, 2019

contemporary levers to complement the interior design of your next project

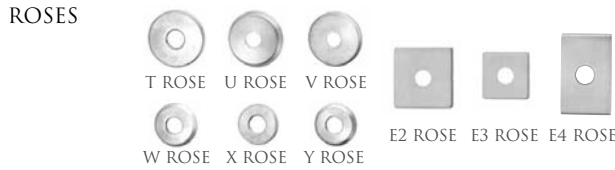

629	Bright Stainless Steel
630	Satin Stainless Steel

### Function

Function	Model	Description	Price
Non-Keyed	ML2010	Passage	\$1,020.00
	ML2020	Privacy	
	ML2030	Privacy	\$1,082.00
	ML2060	Privacy	\$1,046.00
	ML2050	Half Dummy	\$408.00
	ML2070	Full Dummy	\$816.00
	ML2080	Half Active Dummy Trim	\$607.00
	ML2090	Full Active Dummy Trim	\$1,015.00
Single Cylinder	ML2003	Classroom	
	ML2051	Office	
	ML2055	Classroom	
	ML2056	Classroom Holdback	\$1,132.00
	ML2057	Storeroom	
	ML2069	Institution Privacy	
	ML2053	Entrance	
	ML2054	Entrance	
	ML2058	Entrance Holdback	\$1,145.00
	ML2068	Privacy or Classroom	
Single Cylinder with Deadbolt	ML2024	Entrance	
	ML2048	Entrance	
	ML2049	Storeroom Deadbolt	
	ML2059	Security Storeroom	
	ML2065	Dormitory	\$1,168.00
	ML2067	Apartment	
	ML2073	Classroom Security	
	ML2075	Entrance/Office	
	ML2029	Hotel	\$1,223.00
Double Cylinder	ML2002	Classroom Intruder	
	ML2032	Institution	
	ML2042	Entrance	\$1,218.00
	ML2052	Classroom Intruder	
	ML2087	Security Vestibule	
Double Cylinder with Deadbolt	ML2022	Store Door	
	ML2062	Intruder Deadbolt	
	ML2072	Classroom Security Intruder	\$1,254.00
	ML2082	Dormitory	
	ML2092	Security Institution	
Full Working Trim (Quick Code M31) No cylinder; includes thumbturn lever			\$818.00



### Ordering Example Details

ML2000 Sectional Trim (rose)	ML2051	Office Function
	21W	Piet Family Lever - Wood Insert
	U	Rose
	29BH29	Lever Finish
		Wood insert with polished stainless steel (629) shank and polished stainless steel (629) grip
	629	Lock Finish
	RHR	Handing

### Stock Order

Quantity	Series/Function	Trim	Lever Finish	Lock Finish	Hand
2	ML2051	21WU	29BH29	629	RHR



ASSA ABLOY

# Mortise Locksets

ML2000 Series: Muséo Levers and Escutcheons

January 1, 2019

contemporary levers to complement the interior design of your next project

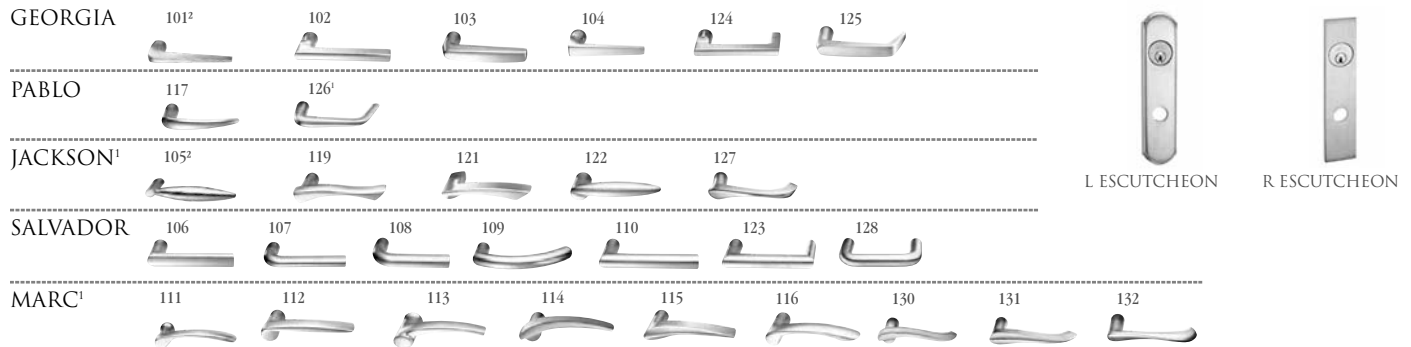

1. Handed: specify hand when ordering.
2. Contact factory for current lead time.

\*629 and \*630 finish options are Not available for all Muséo levers. Please refer to page 20 for availability.

613E	Dark Oxidized Satin Bronze - Equivalent	605	Bright Brass, Clear Coated	618	Bright Nickel Plated
626	Satin Chromium Plated	606	Satin Brass, Clear Coated	619	Satin Nickel Plated
BSP	Black Suede Powder Coat	611	Bright Bronze, Clear Coated	625	Bright Chromium Plated
		612	Satin Bronze, Clear Coated	629*	Bright Stainless Steel
		613	Dark Oxidized Satin Bronze, Oil Rubbed	630*	Satin Stainless Steel
		613L	Dark Oxidized Satin Bronze, Clear Coated	722	Black Oxidized Bronze, Oil Rubbed

### Function

Category	Model	Description	Price	Price
Non-Keyed	ML2010	Passage	\$865.00	\$889.00
	ML2020	Privacy	\$971.00	\$995.00
	ML2030	Privacy		
	ML2060	Privacy	\$940.00	\$964.00
	ML2050	Half Dummy	\$489.00	\$513.00
	ML2070	Full Dummy	\$978.00	\$1,002.00
	ML2080	Half Active Dummy Trim	\$415.00	\$439.00
Single Cylinder	ML2090	Full Active Dummy Trim	\$904.00	\$928.00
	ML2003	Classroom		
	ML2051	Office		
	ML2055	Classroom	\$1,021.00	\$1,045.00
	ML2056	Classroom Holdback		
	ML2057	Storeroom		
	ML2069	Institution Privacy		
	ML2053	Entrance		
Single Cylinder with Deadbolt	ML2054	Entrance	\$1,034.00	\$1,058.00
	ML2058	Entrance Holdback		
	ML2068	Privacy or Classroom		
	ML2024	Entrance		
	ML2048	Entrance		
	ML2049	Storeroom Deadbolt	\$1,057.00	\$1,081.00
	ML2059	Security Storeroom		
Double	ML2065	Dormitory		
	ML2067	Apartment		
	ML2073	Classroom Security		
	ML2075	Entrance/Office	\$1,112.00	\$1,136.00
	ML2029	Hotel		
Double Cylinder with Deadbolt	ML2002	Classroom Intruder	\$1,107.00	\$1,131.00
	ML2032	Institution		
	ML2042	Entrance		
	ML2052	Classroom Intruder		
	ML2022	Store Door	\$1,143.00	\$1,167.00
	ML2062	Intruder Deadbolt		
Full Working Trim (Quick Code M31) No cylinder; includes thumbturn lever	ML2072	Classroom Security Intruder		
	ML2082	Dormitory		
	ML2092	Security Institution		
			\$881.00	\$905.00



### Ordering Example Details

ML2000  
Escutcheon Trim

ML2051 Office Function  
111 Marc Family Lever  
L Escutcheon  
619 Finish  
RHR Handing

### Stock Order

Quantity	Series/Function	Trim	Finish	Hand
24	ML2051	111L	619	RHR



ASSA ABLOY

ASSA ABLOY, the global leader in door opening solutions

Corbin Russwin is a brand associated with ASSA ABLOY Access and Egress Hardware Group, Inc., an ASSA ABLOY Group company. Copyright © 2019, ASSA ABLOY Access and Egress Hardware Group, Inc. All rights reserved. Reproduction in whole or in part without the express written permission of ASSA ABLOY Access and Egress Hardware Group, Inc. is prohibited.

Contact us at: 800-543-3658 or visit [www.corbinrusswin.com](http://www.corbinrusswin.com). In Canada contact us at: 800-461-3007 or visit [www.assaabloydss.ca](http://www.assaabloydss.ca)



# Mortise Locksets

ML2000 Series: Muséo Levers and Escutcheons

January 1, 2019

contemporary levers to complement the interior design of your next project



JOSEF

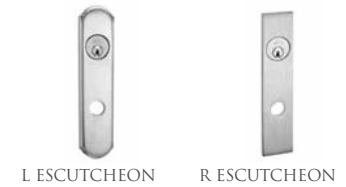

1. Handed: specify hand when ordering
2. Contact factory for current lead time

613E	Dark Oxidized Satin Bronze - Equivalent	605	Bright Brass, Clear Coated	618	Bright Nickel Plated
626	Satin Chromium Plated	606	Satin Brass, Clear Coated	619	Satin Nickel Plated
BSP	Black Suede Powder Coat	611	Bright Bronze, Clear Coated	625	Bright Chromium Plated
		612	Satin Bronze, Clear Coated	629	Bright Stainless Steel
		613	Dark Oxidized Satin Bronze, Oil Rubbed	630	Satin Stainless Steel
		613L	Dark Oxidized Satin Bronze, Clear Coated	722	Black Oxidized Bronze, Oil Rubbed

### Function

Function	Model	Description	Price	Price
Non-Keyed	ML2010	Passage	\$993.00	\$1,017.00
	ML2020	Privacy	\$1,055.00	\$1,079.00
	ML2030	Privacy		
	ML2060	Privacy	\$1,024.00	\$1,048.00
	ML2050	Half Dummy	\$389.50	\$413.50
	ML2070	Full Dummy	\$803.00	\$827.00
	ML2080	Half Active Dummy Trim	\$579.50	\$603.50
	ML2090	Full Active Dummy Trim	\$993.00	\$1,017.00
Single Cylinder	ML2003	Classroom		
	ML2051	Office		
	ML2055	Classroom	\$1,105.00	\$1,129.00
	ML2056	Classroom Holdback		
	ML2057	Storeroom		
	ML2069	Institution Privacy		
	ML2053	Entrance		
	ML2054	Entrance	\$1,118.00	\$1,142.00
	ML2058	Entrance Holdback		
	ML2068	Privacy or Classroom		
Single Cylinder with Deadbolt	ML2024	Entrance		
	ML2048	Entrance		
	ML2049	Storeroom Deadbolt		
	ML2059	Security Storeroom	\$1,141.00	\$1,165.00
	ML2065	Dormitory		
	ML2067	Apartment		
	ML2073	Classroom Security		
	ML2075	Entrance/Office		
	ML2029	Hotel	\$1,196.00	\$1,220.00
Double Cylinder	ML2002	Classroom Intruder		
	ML2032	Institution		
	ML2042	Entrance	\$1,191.00	\$1,215.00
	ML2052	Classroom Intruder		
Double Cylinder with Deadbolt	ML2022	Store Door		
	ML2062	Intruder Deadbolt		
	ML2072	Classroom Security Intruder	\$1,227.00	\$1,251.00
	ML2082	Dormitory		
	ML2092	Security Institution		
Full Working Trim (Quick Code M31) No cylinder; includes thumbturn lever			\$793.00	\$817.00



Ordering Example Details

**ML2000**  
Escutcheon Trim

ML2051 Office Function  
133 Josef Family Lever  
L Escutcheon  
619 Finish  
RHR Handing

### Stock Order

Quantity	Series/Function	Trim	Finish	Hand
24	ML2051	133L	619	RHR



**ASSA ABLOY**

# Mortise Locksets

ML2000 Series: Muséo Levers and Escutcheons

January 1, 2019

contemporary levers to complement the interior design of your next project

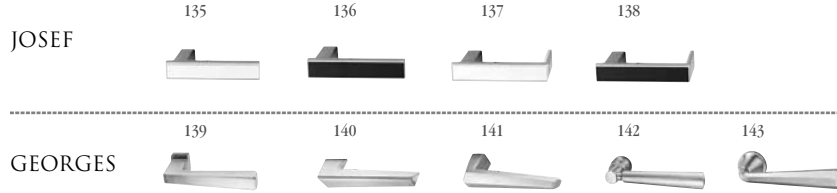

1. Handed: specify hand when ordering
2. Contact factory for current lead time

613E	Dark Oxidized Satin Bronze - Equivalent	605	Bright Brass, Clear Coated	618	Bright Nickel Plated
626	Satin Chromium Plated	606	Satin Brass, Clear Coated	619	Satin Nickel Plated
BSP	Black Suede Powder Coat	611	Bright Bronze, Clear Coated	625	Bright Chromium Plated
		612	Satin Bronze, Clear Coated	629	Bright Stainless Steel
		613	Dark Oxidized Satin Bronze, Oil Rubbed	630	Satin Stainless Steel
		613L	Dark Oxidized Satin Bronze, Clear Coated	722	Black Oxidized Bronze, Oil Rubbed

### Function

Function	Model	Description	Price	Price
Non-Keyed	ML2010	Passage	\$1,069.00	\$1,093.00
	ML2020	Privacy		
	ML2030	Privacy	\$1,131.00	\$1,155.00
	ML2060	Privacy	\$1,095.00	\$1,119.00
	ML2050	Half Dummy	\$420.50	\$444.50
	ML2070	Full Dummy	\$865.00	\$889.00
	ML2080	Half Active Dummy Trim	\$619.50	\$643.50
	ML2090	Full Active Dummy Trim	\$1,064.00	\$1,088.00
Single Cylinder	ML2003	Classroom		
	ML2051	Office		
	ML2055	Classroom	\$1,181.00	\$1,205.00
	ML2056	Classroom Holdback		
	ML2057	Storeroom		
	ML2069	Institution Privacy		
		ML2053	Entrance	
	ML2054	Entrance	\$1,194.00	\$1,218.00
	ML2058	Entrance Holdback		
	ML2068	Privacy or Classroom		
Single Cylinder with Deadbolt	ML2024	Entrance		
	ML2048	Entrance		
	ML2049	Storeroom Deadbolt		
	ML2059	Security Storeroom	\$1,217.00	\$1,241.00
	ML2065	Dormitory		
	ML2067	Apartment		
	ML2073	Classroom Security		
	ML2075	Entrance/Office		
	ML2029	Hotel	\$1,272.00	\$1,296.00
Double Cylinder	ML2002	Classroom Intruder		
	ML2032	Institution	\$1,267.00	\$1,291.00
	ML2042	Entrance		
	ML2052	Classroom Intruder		
Double Cylinder with Deadbolt	ML2022	Store Door		
	ML2062	Intruder Deadbolt		
	ML2072	Classroom Security Intruder	\$1,303.00	\$1,327.00
	ML2082	Dormitory		
	ML2092	Security Institution		
Full Working Trim (Quick Code M31) No cylinder; includes thumbturn lever			\$867.00	\$891.00



Ordering Example Details

**ML2000**  
Escutcheon Trim

ML2051 Office Function  
135 Josef Family Lever  
L Escutcheon  
619 Finish  
RHR Handing

### Stock Order

Quantity	Series/Function	Trim	Finish	Hand
24	ML2051	135L	619	RHR



**ASSA ABLOY**

ASSA ABLOY, the global leader in door opening solutions

Corbin Russwin is a brand associated with ASSA ABLOY Access and Egress Hardware Group, Inc., an ASSA ABLOY Group company. Copyright © 2019, ASSA ABLOY Access and Egress Hardware Group, Inc. All rights reserved. Reproduction in whole or in part without the express written permission of ASSA ABLOY Access and Egress Hardware Group, Inc. is prohibited.

Contact us at: 800-543-3658 or visit [www.corbinrusswin.com](http://www.corbinrusswin.com). In Canada contact us at: 800-461-3007 or visit [www.assaabloydss.ca](http://www.assaabloydss.ca)

# Mortise Locksets

ML2000 Series: Muséo Levers and Escutcheons

January 1, 2019

contemporary levers to complement the interior design of your next project

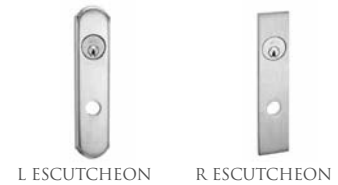

629	Bright Stainless Steel
630	Satin Stainless Steel

## Function

Function	Model	Description	Price
Non-Keypad	ML2010	Passage	\$1,017.00
	ML2020	Privacy	
	ML2030	Privacy	\$1,079.00
	ML2060	Privacy	\$1,048.00
	ML2050	Half Dummy	\$413.50
	ML2070	Full Dummy	\$827.00
	ML2080	Half Active Dummy Trim	\$603.50
	ML2090	Full Active Dummy Trim	\$1,017.00
Single Cylinder	ML2003	Classroom	
	ML2051	Office	
	ML2055	Classroom	\$1,129.00
	ML2056	Classroom Holdback	
	ML2057	Storeroom	
	ML2069	Institution Privacy	
	ML2053	Entrance	
	ML2054	Entrance	\$1,142.00
Single Cylinder with Deadbolt	ML2058	Entrance Holdback	
	ML2068	Privacy or Classroom	
	ML2024	Entrance	
	ML2048	Entrance	
	ML2049	Storeroom Deadbolt	
	ML2059	Security Storeroom	\$1,165.00
	ML2065	Dormitory	
	ML2067	Apartment	
Double Cylinder	ML2073	Classroom Security	
	ML2075	Entrance/Office	
	ML2029	Hotel	\$1,220.00
	ML2002	Classroom Intruder	
	ML2032	Institution	
	ML2042	Entrance	\$1,215.00
	ML2052	Classroom Intruder	
	Double Cylinder with Deadbolt	ML2022	Store Door
ML2062		Intruder Deadbolt	
ML2072		Classroom Security Intruder	\$1,251.00
ML2082		Dormitory	
ML2092		Security Institution	
Full Working Trim (Quick Code M31) No cylinder; includes thumbturn lever			\$817.00



### Ordering Example Details

**ML2000** Escutcheon Trim  
 ML2051 Office Function  
 21M Piet Family Lever - Polished with Satin Insert  
 L Escutcheon  
 293029 Lever Finish  
 Polished with satin stainless steel insert (630), polished stainless steel (629) shank and polished stainless steel (629) grip  
 629 Lock Finish  
 RHR Handing

### Stock Order

Quantity	Series/Function	Trim	Lever Finish	Lock Finish	Hand
2	ML2051	21ML	293029	629	RHR



**ASSA ABLOY**

Corbin Russwin is a brand associated with ASSA ABLOY Access and Egress Hardware Group, Inc., an ASSA ABLOY Group company. Copyright © 2019, ASSA ABLOY Access and Egress Hardware Group, Inc. All rights reserved. Reproduction in whole or in part without the express written permission of ASSA ABLOY Access and Egress Hardware Group, Inc. is prohibited. Contact us at: 800-543-3658 or visit [www.corbinrusswin.com](http://www.corbinrusswin.com). In Canada contact us at: 800-461-3007 or visit [www.assaabloydss.ca](http://www.assaabloydss.ca)

# Mortise Locksets

ML2000 Series: Muséo Levers and Escutcheons

January 1, 2019

contemporary levers to complement the interior design of your next project



PIET



L ESCUTCHEON R ESCUTCHEON

629	Bright Stainless Steel
630	Satin Stainless Steel

## Function

Function	Model	Description	Price
Non-Keyed	ML2010	Passage	\$1,093.00
	ML2020	Privacy	
	ML2030	Privacy	\$1,155.00
	ML2060	Privacy	\$1,119.00
	ML2050	Half Dummy	\$444.50
	ML2070	Full Dummy	\$889.00
	ML2080	Half Active Dummy Trim	\$643.50
	ML2090	Full Active Dummy Trim	\$1,088.00
Single Cylinder	ML2003	Classroom	
	ML2051	Office	
	ML2055	Classroom	\$1,205.00
	ML2056	Classroom Holdback	
	ML2057	Storeroom	
	ML2069	Institution Privacy	
	ML2053	Entrance	
	ML2054	Entrance	\$1,218.00
	ML2058	Entrance Holdback	
	ML2068	Privacy or Classroom	
Single Cylinder with Deadbolt	ML2024	Entrance	
	ML2048	Entrance	
	ML2049	Storeroom Deadbolt	
	ML2059	Security Storeroom	\$1,241.00
	ML2065	Dormitory	
	ML2067	Apartment	
	ML2073	Classroom Security	
	ML2075	Entrance/Office	
	ML2029	Hotel	\$1,296.00
Double Cylinder	ML2002	Classroom Intruder	
	ML2032	Institution	
	ML2042	Entrance	\$1,291.00
	ML2052	Classroom Intruder	
Double Cylinder with Deadbolt	ML2022	Store Door	
	ML2062	Intruder Deadbolt	
	ML2072	Classroom Security Intruder	\$1,327.00
	ML2082	Dormitory	
	ML2092	Security Institution	
Full Working Trim (Quick Code M31) No cylinder; includes thumbturn lever			\$891.00



### Ordering Example Details

<b>ML2000</b>	ML2051	Office Function
Escutcheon	21W	Piet Family Lever - Wood Insert
Trim	L	Escutcheon
	29BH29	Lever Finish
		Wood insert with polished stainless steel (629) shank and polished stainless steel (629) grip
	629	Lock Finish
	RHR	Handing

### Stock Order

Quantity	Series/Function	Trim	Lever Finish	Lock Finish	Hand
2	ML2051	21WL	29BH29	629	RHR



**ASSA ABLOY**

ASSA ABLOY, the global leader in door opening solutions

Corbin Russwin is a brand associated with ASSA ABLOY Access and Egress Hardware Group, Inc., an ASSA ABLOY Group company. Copyright © 2019, ASSA ABLOY Access and Egress Hardware Group, Inc. All rights reserved. Reproduction in whole or in part without the express written permission of ASSA ABLOY Access and Egress Hardware Group, Inc. is prohibited.

Contact us at: 800-543-3658 or visit [www.corbinrusswin.com](http://www.corbinrusswin.com). In Canada contact us at: 800-461-3007 or visit [www.assaabloydss.ca](http://www.assaabloydss.ca)

# Mortise Locksets

ML20900 Series Muséo Levers and Inspire Roseless Trim

January 1, 2019

contemporary levers to complement the interior design of your next project

# MUSÉO®

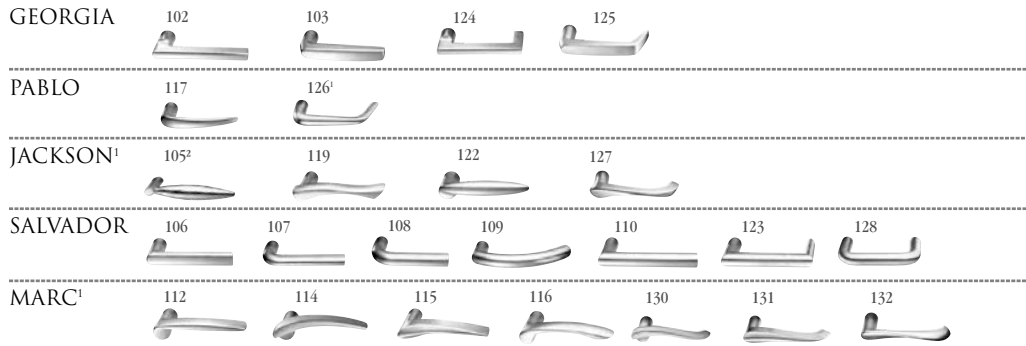

1. Handed: specify hand when ordering
2. Contact factory for current lead time

613E	Dark Oxidized Satin Bronze - Equivalent	605	Bright Brass, Clear Coated	618	Bright Nickel Plated
626	Satin Chromium Plated	606	Satin Brass, Clear Coated	619	Satin Nickel Plated
BSP	Black Suede Powder Coat	611	Bright Bronze, Clear Coated	625	Bright Chromium Plated
		612	Satin Bronze, Clear Coated	629*	Bright Stainless Steel
		613	Dark Oxidized Satin Bronze, Oil Rubbed	630*	Satin Stainless Steel
		613L	Dark Oxidized Satin Bronze, Clear Coated	722	Black Oxidized Bronze, Oil Rubbed

## Function

Lever with Roses					
Single Cylinder	ML20914	Fail Safe	\$1,238.00		\$1,262.00
	ML20906	Fail Secure			
No Cylinder Override	ML20907	Fail Safe	\$1,152.00		\$1,176.00
	ML20915	Fail Secure			
Double Cylinder	ML20932	Fail Safe	\$1,324.00		\$1,348.00
	ML20987	Fail Secure			



### Ordering Example Details

**ML2000**  
Sectional Trim (rose)

ML2051 Office Function  
102 Georgia Family Lever  
J Collar  
625 Finish  
RHR Handing

### Stock Order

Quantity	Series/Function	Trim	Finish	Hand
24	ML2051	102J	625	RHR

\*629 and \*630 finish options are Not available for all Muséo levers. Please refer to page 20 for availability.



**ASSA ABLOY**

# Electrically Controlled Mortise Locksets

## ML20600 NAC Series Electrified Mortise Lock with High Security Monitoring

January 1, 2019

contemporary levers to complement the interior design of your next project

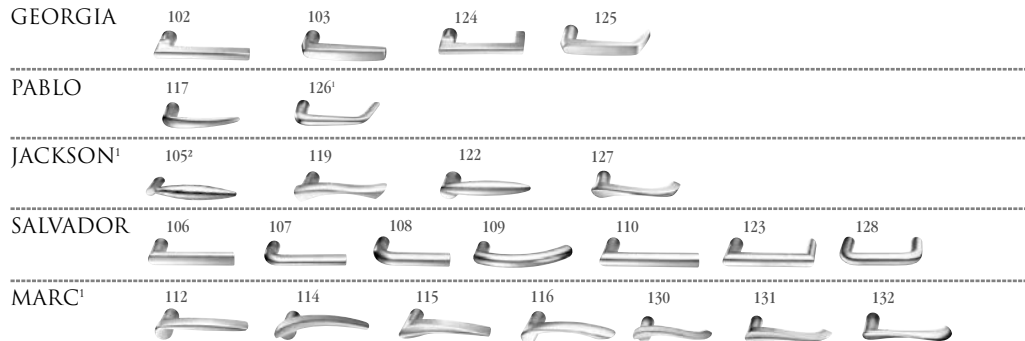

1. Handed: specify hand when ordering
2. Contact factory for current lead time

613E	Dark Oxidized Satin Bronze - Equivalent	605	Bright Brass, Clear Coated	618	Bright Nickel Plated
626	Satin Chromium Plated	606	Satin Brass, Clear Coated	619	Satin Nickel Plated
BSP	Black Suede Powder Coat	611	Bright Bronze, Clear Coated	625	Bright Chromium Plated
		612	Satin Bronze, Clear Coated	629*	Bright Stainless Steel
		613	Dark Oxidized Satin Bronze, Oil Rubbed	630*	Satin Stainless Steel
		613L	Dark Oxidized Satin Bronze, Clear Coated	722	Black Oxidized Bronze, Oil Rubbed

### Function

Lever with Roses					
Single Cylinder	ML20606 x NAC	Fail Safe/Fail Secure	\$1,413.00		\$1,437.00
	ML20608 x NAC	Fail Safe/Fail Secure	\$1,488.00		\$1,512.00
No Cylinder Override	ML20607 x NAC	Fail Safe/Fail Secure	\$1,327.00		\$1,351.00
	ML20609 x NAC	Fail Safe/Fail Secure	\$1,402.00		\$1,426.00

### ML20600 High Security Monitoring Options

Description	Specify	Add or Deduct
Mercury and Lenel compatible 1KΩ/2KΩ resistance supervision	R01	Add \$100.00 per lockset
Software House compatible 1KΩ/2KΩ resistance supervision	R03	Add \$100.00 per lockset
AMAG compatible 4-state supervision	R04	Add \$100.00 per lockset
Deadbolt Privacy Function	PHR	Add \$100.00 per lockset
Deadbolt Privacy and Mercury / Lenel 1KΩ/2KΩ	PHRR01	Add \$200.00 per lockset
Deadbolt Privacy and Software House 1KΩ/2KΩ	PHRR03	Add \$200.00 per lockset
Deadbolt Privacy and AMAG 4-State	PHRR04	Add \$200.00 per lockset



Ordering Example Details →

ML2000 Mortise Lock x NAC x No Cylinder x Deadbolt x Fail-Secure

- Muséo® lever 102 with J Collar
- Polished chrome finish
- Right hand reverse
- Deadbolt privacy function, Mercury and Lenel compatible 1KΩ/2KΩ resistance supervision

Stock Order							
Quantity	Series/Function	Technology Code	Trim	Finish	Hand	Fail Safe/Fail Secure	High Security Monitoring Options
24	ML20608	NAC	102J	625	RHR	SEC	PHRR01

\*629 and \*630 finish options are Not available for all Muséo levers. Please refer to page 20 for availability.



ASSA ABLOY

ASSA ABLOY, the global leader in door opening solutions

Corbin Russwin is a brand associated with ASSA ABLOY Access and Egress Hardware Group, Inc., an ASSA ABLOY Group company. Copyright © 2019, ASSA ABLOY Access and Egress Hardware Group, Inc. All rights reserved. Reproduction in whole or in part without the express written permission of ASSA ABLOY Access and Egress Hardware Group, Inc. is prohibited.

Contact us at: 800-543-3658 or visit [www.corbinrusswin.com](http://www.corbinrusswin.com). In Canada contact us at: 800-461-3007 or visit [www.assaabloydss.ca](http://www.assaabloydss.ca)

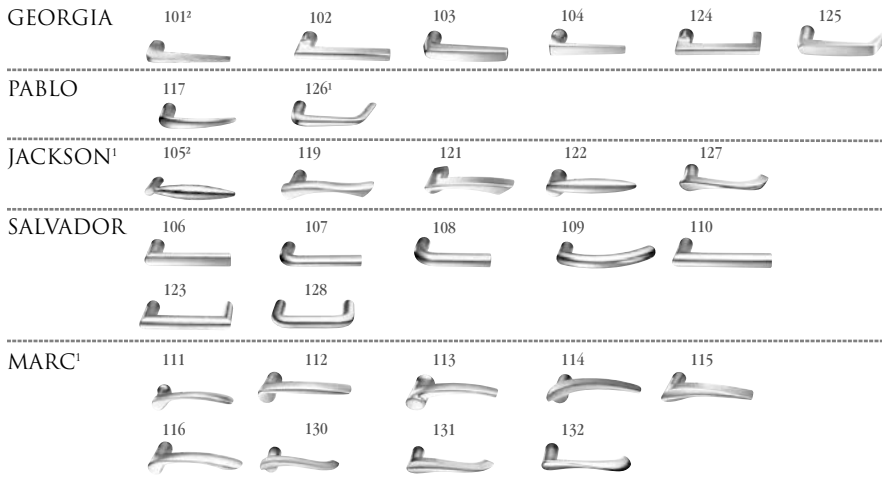

**ROSES**

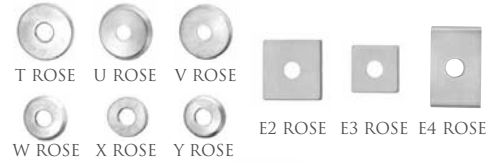

**ESCUTCHEONS**



**THUMBTURNS<sup>3</sup>**



1. Handed: specify hand when ordering
2. Contact factory for current lead time
3. Specify thumbturn as quick code. Thumbturn backplate will match shape of rose chosen (i.e. round or square). Not available with escutcheons.
4. ML20987 not available for L or R escutcheons.

\*629 and \*630 finish options are Not available for all Muséo levers. Please refer to page 20 for availability.

613E	Dark Oxidized Satin Bronze - Equivalent	605	Bright Brass, Clear Coated	618	Bright Nickel Plated
626	Satin Chromium Plated	606	Satin Brass, Clear Coated	619	Satin Nickel Plated
BSP	Black Suede Powder Coat	611	Bright Bronze, Clear Coated	625	Bright Chromium Plated
		612	Satin Bronze, Clear Coated	629*	Bright Stainless Steel
		613	Dark Oxidized Satin Bronze, Oil Rubbed	630*	Satin Stainless Steel
		613L	Dark Oxidized Satin Bronze, Clear Coated	722	Black Oxidized Bronze, Oil Rubbed

**Function**

Lever with Escutcheons: L,R					
Single Cylinder	ML20914	Fail Safe/Fail Secure*	\$1,239.00		\$1,263.00
	ML20906				
No Cylinder Override	ML20907	Fail Safe/Fail Secure*	\$1,153.00		\$1,177.00
	ML20915				
Double Cylinder	ML20932	Fail Safe/Fail Secure*	\$1,325.00		\$1,349.00
	ML20987				
Lever with Roses: V,U,T,Y,X,W,E2,E3,E4					
Single Cylinder	ML20914	Fail Safe/Fail Secure*	\$1,185.00		\$1,209.00
	ML20906				
No Cylinder Override	ML20907	Fail Safe/Fail Secure*	\$1,099.00		\$1,123.00
	ML20915				
Double Cylinder	ML20932	Fail Safe/Fail Secure*	\$1,271.00		\$1,295.00
	ML20987				

\*Must specify: SAF for Fail Safe or SEC for Fail Secure.



Ordering Example Details

<b>ML20900 ECL</b>	ML20914	Single Cylinder
Escutcheon Trim	SEC	Fail Secure
	104	Salvador Family Lever
	L	Escutcheon
	613	Finish
	RHR	Handing
	24 AD	24 Volt AC/DC

**Stock Order**

Quantity	Series/Function	Fail Safe/Fail Secure	Trim	Finish	Hand	Voltage
24	ML20914	SEC	104L	613	RHR	24 AD



**ASSA ABLOY**

# Electrically Controlled Mortise Locksets

## ML20600 NAC Series Electrified Mortise Lock with High Security Monitoring

January 1, 2019

contemporary levers to complement the interior design of your next project

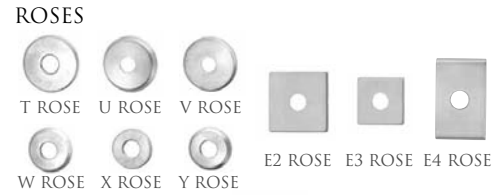
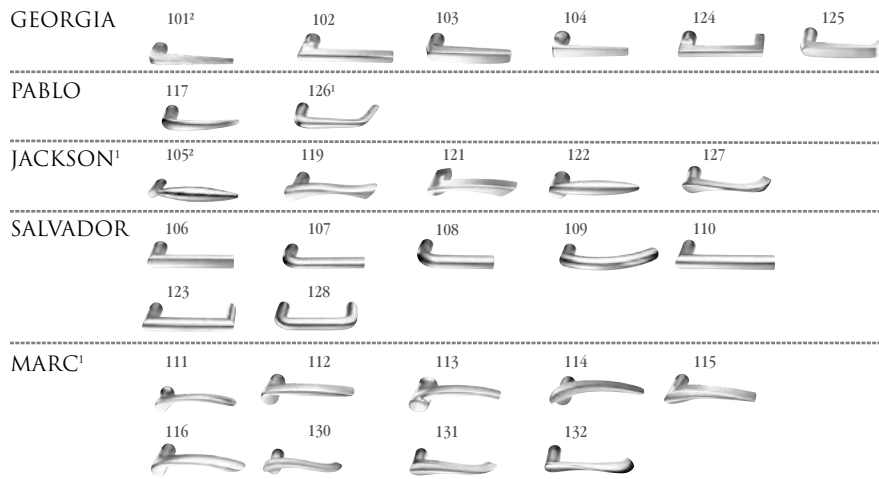

1. Handed: specify hand when ordering
2. Contact factory for current lead time
3. Specify thumbturn as quick code. Thumbturn backplate will match shape of rose chosen (i.e. round or square). Not available with escutcheons.

\*629 and \*630 finish options are Not available for all Muséo levers. Please refer to page 20 for availability.

613E	Dark Oxidized Satin Bronze - Equivalent	605	Bright Brass, Clear Coated	618	Bright Nickel Plated
626	Satin Chromium Plated	606	Satin Brass, Clear Coated	619	Satin Nickel Plated
BSP	Black Suede Powder Coat	611	Bright Bronze, Clear Coated	625	Bright Chromium Plated
		612	Satin Bronze, Clear Coated	629*	Bright Stainless Steel
		613	Dark Oxidized Satin Bronze, Oil Rubbed	630*	Satin Stainless Steel
		613L	Dark Oxidized Satin Bronze, Clear Coated	722	Black Oxidized Bronze, Oil Rubbed

### Function

Lever with Escutcheons: L,R					
Single Cylinder	ML20606 x NAC	Fail Safe/Fail Secure	\$1,414.00		\$1,438.00
	ML20608 x NAC	Fail Safe/Fail Secure	\$1,489.00		\$1,513.00
No Cylinder Override	ML20607 x NAC	Fail Safe/Fail Secure	\$1,328.00		\$1,352.00
	ML20609 x NAC	Fail Safe/Fail Secure	\$1,403.00		\$1,427.00

Lever with Roses: V,U,T,Y,X,W,E2,E3,E4					
Single Cylinder	ML20606 x NAC	Fail Safe/Fail Secure	\$1,360.00		\$1,384.00
	ML20608 x NAC	Fail Safe/Fail Secure	\$1,435.00		\$1,459.00
No Cylinder Override	ML20607 x NAC	Fail Safe/Fail Secure	\$1,274.00		\$1,298.00
	ML20609 x NAC	Fail Safe/Fail Secure	\$1,349.00		\$1,373.00

\*Must specify: SAF for Fail Safe or SEC for Fail Secure.

### ML20600 High Security Monitoring Options

Description	Specify	Add or Deduct
Mercury and Lenel compatible 1KΩ/2KΩ resistance supervision	R01	Add \$100.00 per lockset
Software House compatible 1KΩ/2KΩ resistance supervision	R03	Add \$100.00 per lockset
AMAG compatible 4-state supervision	R04	Add \$100.00 per lockset
Deadbolt Privacy Function	PHR	Add \$100.00 per lockset
Deadbolt Privacy and Mercury / Lenel 1KΩ/2KΩ	PHRR01	Add \$200.00 per lockset
Deadbolt Privacy and Software House 1KΩ/2KΩ	PHRR03	Add \$200.00 per lockset
Deadbolt Privacy and AMAG 4-State	PHRR04	Add \$200.00 per lockset



Ordering Example Details

<b>ML20600 NAC</b> Escutcheon Trim	ML20608	Single Cylinder
	SEC	Fail Secure
	104	Salvador Family Lever
	L	Escutcheon
	613	Finish
	RHR	Handing
	24 AD	24 Volt AC/DC

### Stock Order

Quantity	Series/Function	Technology Code	Trim	Finish	Hand	Fail Safe/Fail Secure	High Security Monitoring Options
24	ML20608	NAC	104L	613	RHR	SEC	PHRR01



ASSA ABLOY

ASSA ABLOY, the global leader in door opening solutions

Corbin Russwin is a brand associated with ASSA ABLOY Access and Egress Hardware Group, Inc., an ASSA ABLOY Group company. Copyright © 2019, ASSA ABLOY Access and Egress Hardware Group, Inc. All rights reserved. Reproduction in whole or in part without the express written permission of ASSA ABLOY Access and Egress Hardware Group, Inc. is prohibited.

Contact us at: 800-543-3658 or visit [www.corbinrusswin.com](http://www.corbinrusswin.com). In Canada contact us at: 800-461-3007 or visit [www.assaabloydss.ca](http://www.assaabloydss.ca)



JOSEF



ROSES

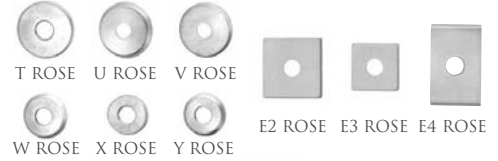

ESCUTCHEONS



THUMBTURNS<sup>3</sup>



1. Handed: specify hand when ordering
2. Contact factory for current lead time
3. Specify thumbturn as quick code. Thumbturn backplate will match shape of rose chosen (i.e. round or square). Not available with escutcheons.
4. ML20987 not available with L or R escutcheons.

613E	Dark Oxidized Satin Bronze - Equivalent	605	Bright Brass, Clear Coated	618	Bright Nickel Plated
626	Satin Chromium Plated	606	Satin Brass, Clear Coated	609	Satin Nickel Plated
BSP	Black Suede Powder Coat	611	Bright Bronze, Clear Coated	625	Bright Chromium Plated
		612	Satin Bronze, Clear Coated	629	Bright Stainless Steel
		613	Dark Oxidized Satin Bronze, Oil Rubbed	630	Satin Stainless Steel
		613L	Dark Oxidized Satin Bronze, Clear Coated	722	Black Oxidized Bronze, Oil Rubbed

Function

Lever with Escutcheons: L,R					
Single Cylinder	ML20914	Fail Safe/Fail Secure*	\$1,323.00		\$1,347.00
	ML20906				
No Cylinder Override	ML20907	Fail Safe/Fail Secure*	\$1,237.00		\$1,261.00
	ML20915				
Double Cylinder	ML20932	Fail Safe/Fail Secure*	\$1,409.00		\$1,433.00
	ML20987				
Lever with Roses: V,U,T,Y,X,W,E2,E3,E4					
Single Cylinder	ML20914	Fail Safe/Fail Secure*	\$1,250.00		\$1,274.00
	ML20906				
No Cylinder Override	ML20907	Fail Safe/Fail Secure*	\$1,164.00		\$1,188.00
	ML20915				
Double Cylinder	ML20932	Fail Safe/Fail Secure*	\$1,336.00		\$1,360.00
	ML20987				

\*Must specify: SAF for Fail Safe or SEC for Fail Secure.



Ordering Example Details

**ML20900 ECL**  
 Escutcheon Trim

ML20914 Single Cylinder  
 SEC Fail Secure  
 133 Josef Family Lever  
 L Escutcheon  
 613 Finish  
 RHR Handing  
 24 AD 24 Volt AC/DC

Stock Order

Quantity	Series/Function	Fail Safe/Fail Secure	Trim	Finish	Hand	Voltage
24	ML20914	SEC	133L	613	RHR	24 AD



ASSA ABLOY

# Electrically Controlled Mortise Locksets

## ML20600 NAC Series Electrified Mortise Lock with High Security Monitoring

January 1, 2019

contemporary levers to complement the interior design of your next project

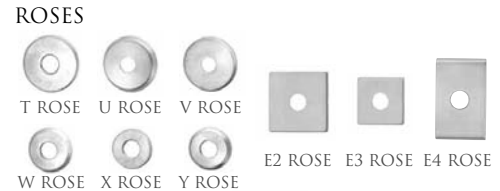

1. Handed: specify hand when ordering
2. Contact factory for current lead time
3. Specify thumbturn as quick code. Thumbturn backplate will match shape of rose chosen (i.e. round or square). Not available with escutcheons.

613E	Dark Oxidized Satin Bronze - Equivalent	605	Bright Brass, Clear Coated	618	Bright Nickel Plated
626	Satin Chromium Plated	606	Satin Brass, Clear Coated	619	Satin Nickel Plated
BSP	Black Suede Powder Coat	611	Bright Bronze, Clear Coated	625	Bright Chromium Plated
		612	Satin Bronze, Clear Coated	629	Bright Stainless Steel
		613	Dark Oxidized Satin Bronze, Oil Rubbed	630	Satin Stainless Steel
		613L	Dark Oxidized Satin Bronze, Clear Coated	722	Black Oxidized Bronze, Oil Rubbed

### Function

Lever with Escutcheons: L,R					
Single Cylinder	ML20606 x NAC	Fail Safe/Fail Secure	\$1,498.00		\$1,522.00
	ML20608 x NAC	Fail Safe/Fail Secure	\$1,573.00		\$1,597.00
No Cylinder Override	ML20607 x NAC	Fail Safe/Fail Secure	\$1,412.00		\$1,436.00
	ML20609 x NAC	Fail Safe/Fail Secure	\$1,487.00		\$1,511.00

Lever with Roses: V,U,T,Y,X,W,E2,E3,E4					
Single Cylinder	ML20606 x NAC	Fail Safe/Fail Secure	\$1,425.00		\$1,449.00
	ML20608 x NAC	Fail Safe/Fail Secure	\$1,500.00		\$1,524.00
No Cylinder Override	ML20607 x NAC	Fail Safe/Fail Secure	\$1,339.00		\$1,363.00
	ML20609 x NAC	Fail Safe/Fail Secure	\$1,414.00		\$1,438.00

\*Must specify: SAF for Fail Safe or SEC for Fail Secure.

### ML20600 High Security Monitoring Options

Description	Specify	Add or Deduct
Mercury and Lenel compatible 1KΩ/2KΩ resistance supervision	R01	Add \$100.00 per lockset
Software House compatible 1KΩ/2KΩ resistance supervision	R03	Add \$100.00 per lockset
AMAG compatible 4-state supervision	R04	Add \$100.00 per lockset
Deadbolt Privacy Function	PHR	Add \$100.00 per lockset
Deadbolt Privacy and Mercury / Lenel 1KΩ/2KΩ	PHRR01	Add \$200.00 per lockset
Deadbolt Privacy and Software House 1KΩ/2KΩ	PHRR03	Add \$200.00 per lockset
Deadbolt Privacy and AMAG 4-State	PHRR04	Add \$200.00 per lockset

Ordering Example Details

<b>BHMA</b> CERTIFIED ML20600 NAC Escutcheon Trim	ML20608	Single Cylinder
	SEC	Fail Secure
	104	Salvador Family Lever
	L	Escutcheon
	613	Finish
	RHR	Handing
	24 AD	24 Volt AC/DC

Stock Order

Quantity	Series/Function	Technology Code	Trim	Finish	Hand	Fail Safe/Fail Secure	High Security Monitoring Options
24	ML20608	NAC	133L	613	RHR	SEC	PHRR01



ASSA ABLOY, the global leader in door opening solutions

Corbin Russwin is a brand associated with ASSA ABLOY Access and Egress Hardware Group, Inc., an ASSA ABLOY Group company. Copyright © 2019, ASSA ABLOY Access and Egress Hardware Group, Inc. All rights reserved. Reproduction in whole or in part without the express written permission of ASSA ABLOY Access and Egress Hardware Group, Inc. is prohibited.

Contact us at: 800-543-3658 or visit [www.corbinrusswin.com](http://www.corbinrusswin.com). In Canada contact us at: 800-461-3007 or visit [www.assaabloydss.ca](http://www.assaabloydss.ca)

# Electrically Controlled Mortise Locksets

ML20900 Series: Muséo Levers, Escutcheons, Roses and Thumbturns

January 1, 2019

contemporary levers to complement the interior design of your next project

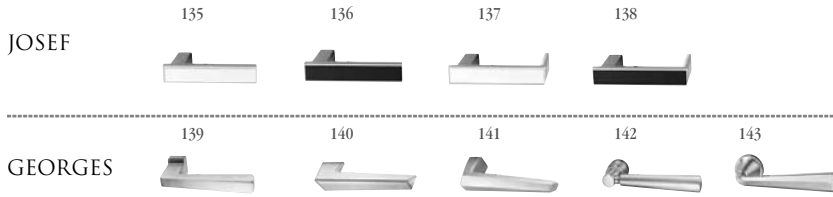

## ROSES

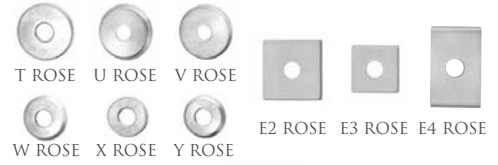

## ESCUTCHEONS



## THUMBTURNS<sup>3</sup>



1. Handed: specify hand when ordering
2. Contact factory for current lead time
3. Specify thumbturn as quick code. Thumbturn backplate will match shape of rose chosen (i.e. round or square). Not available with escutcheons.
4. ML20987 not available with L or R escutcheons.

613E	Dark Oxidized Satin Bronze - Equivalent	605	Bright Brass, Clear Coated	618	Bright Nickel Plated
626	Satin Chromium Plated	606	Satin Brass, Clear Coated	619	Satin Nickel Plated
BSP	Black Suede Powder Coat	611	Bright Bronze, Clear Coated	625	Bright Chromium Plated
		612	Satin Bronze, Clear Coated	629	Bright Stainless Steel
		613	Dark Oxidized Satin Bronze, Oil Rubbed	630	Satin Stainless Steel
		613L	Dark Oxidized Satin Bronze, Clear Coated	722	Black Oxidized Bronze, Oil Rubbed

## Function

Lever with Escutcheons: L,R					
Single Cylinder	ML20914	Fail Safe/Fail Secure*	\$1,399.00		\$1,423.00
	ML20906				
No Cylinder Override	ML20907	Fail Safe/Fail Secure*	\$1,313.00		\$1,337.00
	ML20915				
Double Cylinder	ML20932	Fail Safe/Fail Secure*	\$1,485.00		\$1,509.00
	ML20987				
Lever with Roses: V,U,T,Y,X,W,E2,E3,E4					
Single Cylinder	ML20914	Fail Safe/Fail Secure*	\$1,326.00		\$1,350.00
	ML20906				
No Cylinder Override	ML20907	Fail Safe/Fail Secure*	\$1,240.00		\$1,264.00
	ML20915				
Double Cylinder	ML20932	Fail Safe/Fail Secure*	\$1,412.00		\$1,436.00
	ML20987				

\*Must specify: SAF for Fail Safe or SEC for Fail Secure.

## Ordering Example Details

<b>ML20900 ECL</b>	ML20914	Single Cylinder
Escutcheon Trim	SEC	Fail Secure
	135	Josef Family Lever
	L	Escutcheon
	613	Finish
	RHR	Handing
	24 AD	24 Volt AC/DC



Stock Order								
Quantity	Series/Function	Technology Code	Trim	Finish	Hand	Voltage	Fail Safe/Fail Secure	High Security Monitoring Options
24	ML20914	NAC	135L	613	RHR	24 AD	SEC	PHRR01



ASSA ABLOY

# Electrically Controlled Mortise Locksets

## ML20600 NAC Series Electrified Mortise Lock with High Security Monitoring

January 1, 2019

contemporary levers to complement the interior design of your next project

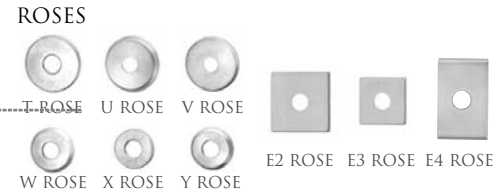
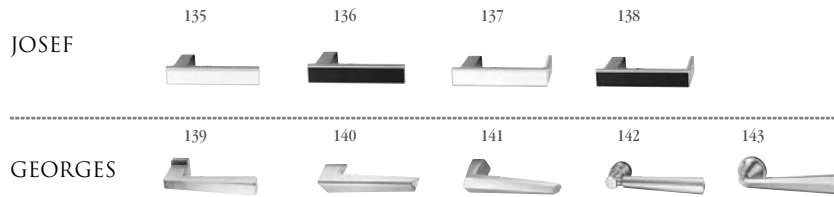

1. Handed: specify hand when ordering
2. Contact factory for current lead time
3. Specify thumbturn as quick code. Thumbturn backplate will match shape of rose chosen (i.e. round or square). Not available with escutcheons.

613E	Dark Oxidized Satin Bronze - Equivalent	605	Bright Brass, Clear Coated	618	Bright Nickel Plated
626	Satin Chromium Plated	606	Satin Brass, Clear Coated	619	Satin Nickel Plated
BSP	Black Suede Powder Coat	611	Bright Bronze, Clear Coated	625	Bright Chromium Plated
		612	Satin Bronze, Clear Coated	629	Bright Stainless Steel
		613	Dark Oxidized Satin Bronze, Oil Rubbed	630	Satin Stainless Steel
		613L	Dark Oxidized Satin Bronze, Clear Coated	722	Black Oxidized Bronze, Oil Rubbed

### Function

Lever with Escutcheons: L,R					
Single Cylinder	ML20606 x NAC	Fail Safe/Fail Secure	\$1,574.00		\$1,598.00
	ML20608 x NAC	Fail Safe/Fail Secure	\$1,649.00		\$1,673.00
No Cylinder Override	ML20607 x NAC	Fail Safe/Fail Secure	\$1,488.00		\$1,512.00
	ML20609 x NAC	Fail Safe/Fail Secure	\$1,563.00		\$1,587.00

Lever with Roses: V,U,T,Y,X,W,E2,E3,E4					
Single Cylinder	ML20606 x NAC	Fail Safe/Fail Secure	\$1,501.00		\$1,525.00
	ML20608 x NAC	Fail Safe/Fail Secure	\$1,576.00		\$1,600.00
No Cylinder Override	ML20607 x NAC	Fail Safe/Fail Secure	\$1,514.00		\$1,538.00
	ML20609 x NAC	Fail Safe/Fail Secure	\$1,589.00		\$1,613.00

\*Must specify: SAF for Fail Safe or SEC for Fail Secure.

### ML20600 High Security Monitoring Options

Description	Specify	Add or Deduct
Mercury and Lenel compatible 1KΩ/2KΩ resistance supervision	R01	Add \$100.00 per lockset
Software House compatible 1KΩ/2KΩ resistance supervision	R03	Add \$100.00 per lockset
AMAG compatible 4-state supervision	R04	Add \$100.00 per lockset
Deadbolt Privacy Function	PHR	Add \$100.00 per lockset
Deadbolt Privacy and Mercury / Lenel 1KΩ/2KΩ	PHRR01	Add \$200.00 per lockset
Deadbolt Privacy and Software House 1KΩ/2KΩ	PHRR03	Add \$200.00 per lockset
Deadbolt Privacy and AMAG 4-State	PHRR04	Add \$200.00 per lockset

**BHMA** CERTIFIED Ordering Example Details →

<b>ML20600 NAC</b> Escutcheon Trim	ML20608	Single Cylinder
	SEC	Fail Secure
	104	Salvador Family Lever
	L	Escutcheon
	613	Finish
	RHR	Handing
	24 AD	24 Volt AC/DC

Stock Order							
Quantity	Series/Function	Technology Code	Trim	Finish	Hand	Fail Safe/Fail Secure	High Security Monitoring Options
24	ML20608	NAC	135L	613	RHR	SEC	PHRR01



ASSA ABLOY, the global leader in door opening solutions

Corbin Russwin is a brand associated with ASSA ABLOY Access and Egress Hardware Group, Inc., an ASSA ABLOY Group company. Copyright © 2019, ASSA ABLOY Access and Egress Hardware Group, Inc. All rights reserved. Reproduction in whole or in part without the express written permission of ASSA ABLOY Access and Egress Hardware Group, Inc. is prohibited. Contact us at: 800-543-3658 or visit [www.corbinrusswin.com](http://www.corbinrusswin.com). In Canada contact us at: 800-461-3007 or visit [www.assaabloydss.ca](http://www.assaabloydss.ca)



Specify thumbturn as quick code. Thumbturn backplate will match shape of rose chosen (i.e. round or square)

NOTE: ML20987 not available with L or R escutcheons.

629	Bright Stainless Steel
630	Satin Stainless Steel

**Function**

Lever with Escutcheons: L,R			
Single Cylinder	ML20914	Fail Safe/Fail Secure*	\$1,347.00
	ML20906		
No Cylinder Override	ML20907	Fail Safe/Fail Secure*	\$1,261.00
	ML20915		
Double Cylinder	ML20932	Fail Safe/Fail Secure*	\$1,433.00
	ML20987		
Lever with Roses: V,U,T,Y,X,W,E2,E3,E4			
Single Cylinder	ML20914	Fail Safe/Fail Secure*	\$1,274.00
	ML20906		
No Cylinder Override	ML20907	Fail Safe/Fail Secure*	\$1,188.00
	ML20915		
Double Cylinder	ML20932	Fail Safe/Fail Secure*	\$1,360.00
	ML20987		

\*Must specify: SAF for Fail Safe or SEC for Fail Secure.

**BHMA** CERTIFIED

Ordering Example Details

<b>ML20900 ECL</b>	ML20914 Single Cylinder
Escutcheon	SAF Fail Safe
Trim	21M Piet Family Lever - Polished with Satin Insert
	L Escutcheon
	293029 Lever Finish
	Polished with satin stainless steel insert (630), polished stainless steel (629) shank and polished stainless steel (629) grip
	629 Lock Finish
	RHR Handing
	24 AD 24 Volt AC/DC

Stock Order							
Quantity	Series/Function	Fail Safe/Fail Secure	Trim	Lever Finish	Lock Finish	Hand	Voltage
2	ML20914	SAF	21ML	293029	629	RHR	24 AD



**ASSA ABLOY**

# Electrically Controlled Mortise Locksets

## ML20600 NAC Series Electrified Mortise Lock with High Security Monitoring

January 1, 2019

contemporary levers to complement the interior design of your next project

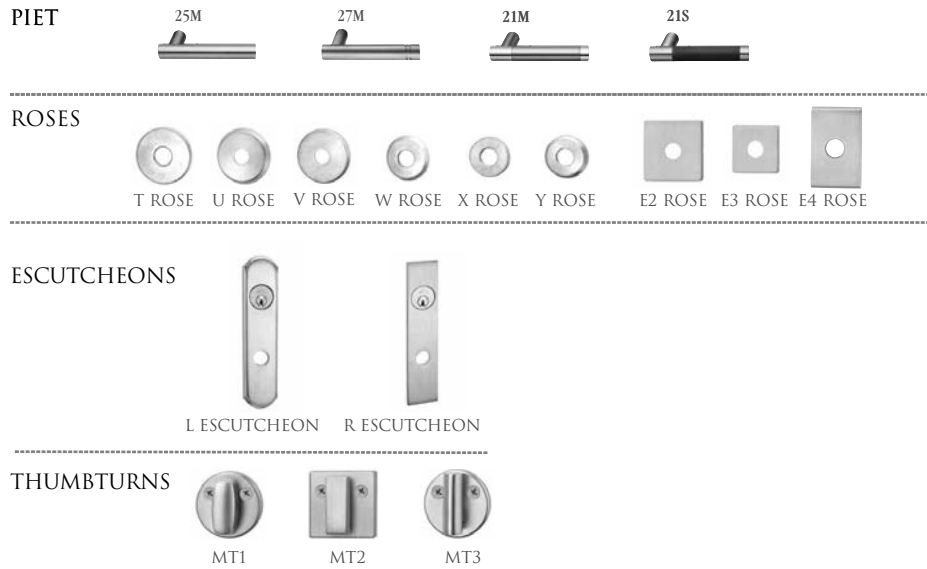

Specify thumbturn as quick code. Thumbturn backplate will match shape of rose chosen (i.e. round or square)

629	Bright Stainless Steel
630	Satin Stainless Steel

### Function

Lever with Escutcheons: L,R			
Single Cylinder	ML20606 x NAC	Fail Safe/Fail Secure*	\$1,522.00
	ML20608 x NAC		\$1,597.00
No Cylinder Override	ML20607 x NAC	Fail Safe/Fail Secure*	\$1,436.00
	ML20609 x NAC		\$1,511.00
Lever with Roses: V,U,T,Y,X,W,E2,E3,E4			
Single Cylinder	ML20606 x NAC	Fail Safe/Fail Secure*	\$1,449.00
	ML20608 x NAC		\$1,524.00
No Cylinder Override	ML20607 x NAC	Fail Safe/Fail Secure*	\$1,363.00
	ML20609 x NAC		\$1,438.00

### ML20600 High Security Monitoring Options

Description	Specify	Add or Deduct
Mercury and Lenel compatible 1KΩ/2KΩ resistance supervision	R01	Add \$100.00 per lockset
Software House compatible 1KΩ/2KΩ resistance supervision	R03	Add \$100.00 per lockset
AMAG compatible 4-state supervision	R04	Add \$100.00 per lockset
Deadbolt Privacy Function	PHR	Add \$100.00 per lockset
Deadbolt Privacy and Mercury / Lenel 1KΩ/2KΩ	PHRR01	Add \$200.00 per lockset
Deadbolt Privacy and Software House 1KΩ/2KΩ	PHRR03	Add \$200.00 per lockset
Deadbolt Privacy and AMAG 4-State	PHRR04	Add \$200.00 per lockset

\*Must specify: SAF for Fail Safe or SEC for Fail Secure.

Ordering Example Details

<b>ML20600 NAC</b>	ML20914 Single Cylinder
Escutcheon	SEC Fail Secure
Trim	21W Piet Family Lever - Wood Insert
<b>BHMA CERTIFIED</b>	L Escutcheon
	29BH29 Lever Finish Wood insert with polished stainless steel (629) shank and polished stainless steel (629) grip
	629 Lock Finish
	RHR Handing
	24 AD 24 Volt AC/DC

### Stock Order

Qty	Series/Function	Tech. Code	Trim	Lever Finish	Finish	Hand	Voltage	Fail Safe/Fail Secure	High Security Monitoring Options
2	ML20608	NAC	21ML	29BH29	629	RHR	24 AD	SEC	PHRR01



**ASSA ABLOY**

ASSA ABLOY, the global leader in door opening solutions

Corbin Russwin is a brand associated with ASSA ABLOY Access and Egress Hardware Group, Inc., an ASSA ABLOY Group company. Copyright © 2019, ASSA ABLOY Access and Egress Hardware Group, Inc. All rights reserved. Reproduction in whole or in part without the express written permission of ASSA ABLOY Access and Egress Hardware Group, Inc. is prohibited. Contact us at: 800-543-3658 or visit [www.corbinrusswin.com](http://www.corbinrusswin.com). In Canada contact us at: 800-461-3007 or visit [www.assaabloydss.ca](http://www.assaabloydss.ca)

*Electrically Controlled Mortise Locksets*  
 ML20900 Series: Muséo Levers, Escutcheons, Roses and Thumbturns

January 1, 2019

contemporary levers to complement the interior design of your next project

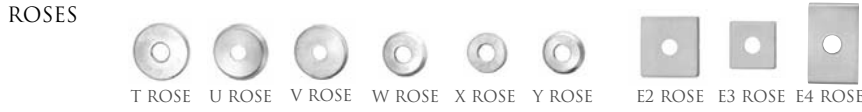

Specify thumbturn as quick code. Thumbturn backplate will match shape of rose chosen (i.e. round or square)

NOTE: ML20987 not available with L or R escutcheons.

629	Bright Stainless Steel
630	Satin Stainless Steel

**Function**

Lever with Escutcheons: L,R			
Single Cylinder	ML20914	Fail Safe/Fail Secure*	\$1,423.00
	ML20906		
No Cylinder Override	ML20907	Fail Safe/Fail Secure*	\$1,337.00
	ML20915		
Double Cylinder	ML20932	Fail Safe/Fail Secure*	\$1,509.00
	ML20987		
Lever with Roses: V,U,T,Y,X,W,E2,E3,E4			
Single Cylinder	ML20914	Fail Safe/Fail Secure*	\$1,350.00
	ML20906		
No Cylinder Override	ML20907	Fail Safe/Fail Secure*	\$1,264.00
	ML20915		
Double Cylinder	ML20932	Fail Safe/Fail Secure*	\$1,436.00
	ML20987		

\*Must specify: SAF for Fail Safe or SEC for Fail Secure.

**BHMA** OPENING DEVICES de Seta de Seta de Confid Ordering Example Details →

**ML20900 ECL**

Escutcheon	ML20914	Single Cylinder
Trim	SEC	Fail Secure
	21W	Piet Family Lever - Wood Insert
	L	Escutcheon
	29BH29	Lever Finish
		Wood insert with polished stainless steel (629) shank and polished stainless steel (629) grip
	629	Lock Finish
	RHR	Handing
	24 AD	24 Volt AC/DC

Stock Order							
Quantity	Series/Function	Fail Safe/Fail Secure	Trim	Lever Finish	Lock Finish	Hand	Voltage
2	ML20914	SEC	21ML	29BH29	629	RHR	24 AD



# Electrically Controlled Mortise Locksets

## ML20600 NAC Series Electrified Mortise Lock with High Security Monitoring

January 1, 2019

contemporary levers to complement the interior design of your next project

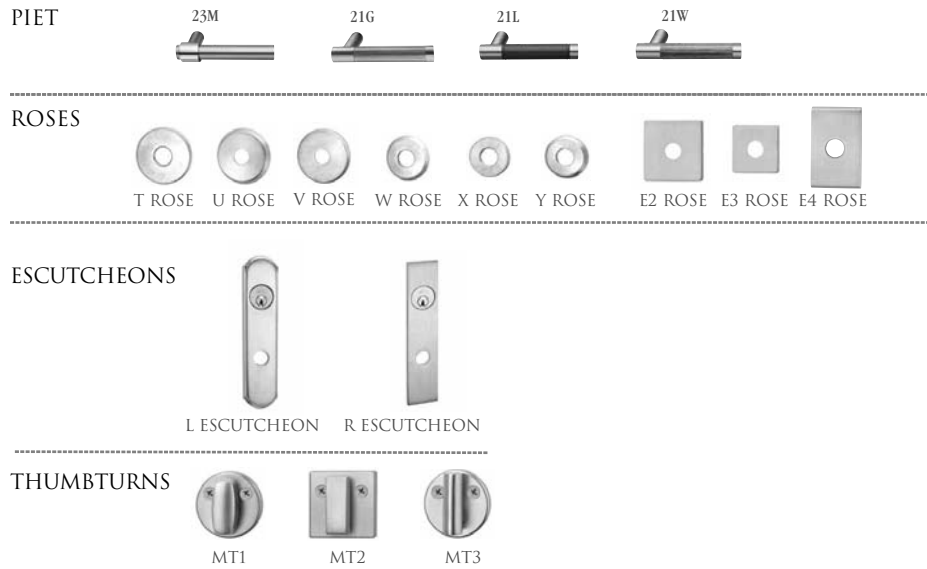

Specify thumbturn as quick code. Thumbturn backplate will match shape of rose chosen (i.e. round or square)

629	Bright Stainless Steel
630	Satin Stainless Steel

### Function

Lever with Escutcheons: L,R			
Single Cylinder	ML20606 x NAC	Fail Safe/Fail Secure*	\$1,598.00
	ML20608 x NAC		\$1,673.00
No Cylinder Override	ML20607 x NAC	Fail Safe/Fail Secure*	\$1,512.00
	ML20609 x NAC		\$1,587.00
Lever with Roses: V,U,T,Y,X,W,E2,E3,E4			
Single Cylinder	ML20606 x NAC	Fail Safe/Fail Secure*	\$1,525.00
	ML20608 x NAC		\$1,600.00
No Cylinder Override	ML20607 x NAC	Fail Safe/Fail Secure*	\$1,439.00
	ML20609 x NAC		\$1,514.00

## ML20600 High Security Monitoring Options

Description	Specify	Add or Deduct
Mercury and Lenel compatible 1KΩ/2KΩ resistance supervision	R01	Add \$100.00 per lockset
Software House compatible 1KΩ/2KΩ resistance supervision	R03	Add \$100.00 per lockset
AMAG compatible 4-state supervision	R04	Add \$100.00 per lockset
Deadbolt Privacy Function	PHR	Add \$100.00 per lockset
Deadbolt Privacy and Mercury / Lenel 1KΩ/2KΩ	PHRR01	Add \$200.00 per lockset
Deadbolt Privacy and Software House 1KΩ/2KΩ	PHRR03	Add \$200.00 per lockset
Deadbolt Privacy and AMAG 4-State	PHRR04	Add \$200.00 per lockset

\*Must specify: SAF for Fail Safe or SEC for Fail Secure.

**BHMA** COMPLYING WITH THE B208 AND B210 **Ordering Example Details**

<b>ML20600 NAC</b>	ML20608 Single Cylinder
Escutcheon Trim	SEC Fail Secure
	21W Piet Family Lever - Wood
	Insert
L	Escutcheon
29BH29	Lever Finish
	Wood insert with polished stainless steel (629)
	shank and polished stainless steel (629) grip
629	Lock Finish
RHR	Handing
24 AD	24 Volt AC/DC

Stock Order									
Qty	Series/Function	Tech. Code	Trim	Lever Finish	Finish	Hand	Voltage	Fail Safe/Fail Secure	High Security Monitoring Options
2	ML20608	NAC	21ML	29BH29	629	RHR	24 AD	SEC	PHRR01



ASSA ABLOY, the global leader in door opening solutions

Corbin Russwin is a brand associated with ASSA ABLOY Access and Egress Hardware Group, Inc., an ASSA ABLOY Group company. Copyright © 2019, ASSA ABLOY Access and Egress Hardware Group, Inc. All rights reserved. Reproduction in whole or in part without the express written permission of ASSA ABLOY Access and Egress Hardware Group, Inc. is prohibited. Contact us at: 800-543-3658 or visit [www.corbinrusswin.com](http://www.corbinrusswin.com). In Canada contact us at: 800-461-3007 or visit [www.assaabloydss.ca](http://www.assaabloydss.ca)



# Access 800® AC2 Mortise Locksets

ML20800 Series: Muséo Levers

January 1, 2019

contemporary levers to complement the interior design of your next project

# MUSÉO®

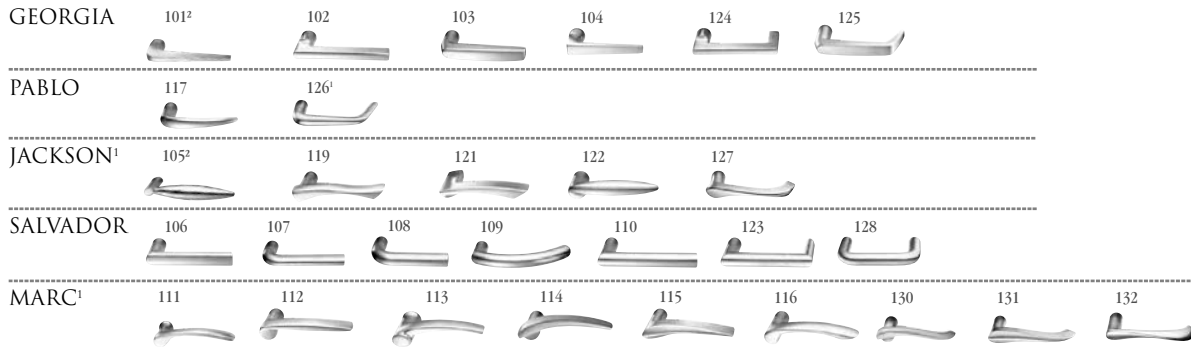

1. Handed: specify hand when ordering.
2. Contact factory for current lead time.

\*629 and \*630 finish options are Not available for all Muséo levers. Please refer to page 20 for availability.

613E	Dark Oxidized Satin Bronze - Equivalent	605	Bright Brass, Clear Coated	618	Bright Nickel Plated
626	Satin Chromium Plated	606	Satin Brass, Clear Coated	619	Satin Nickel Plated
BSP	Black Suede Powder Coat	611	Bright Bronze, Clear Coated	625	Bright Chromium Plated
		612	Satin Bronze, Clear Coated	629*	Bright Stainless Steel
		613	Dark Oxidized Satin Bronze, Oil Rubbed	630*	Satin Stainless Steel
		613L	Dark Oxidized Satin Bronze, Clear Coated	722	Black Oxidized Bronze, Oil Rubbed

Function	Description		
<b>Levers: Georgia, Pablo, Jackson, Salvador, Marc</b>			
ML20833	Without key override x M800	\$1,178.00	\$1,280.00
ML20834	With key override x M800	\$1,264.00	\$1,366.00
ML20835	Deadbolt without key override x M800	\$1,192.00	\$1,294.00
ML20836	Deadbolt with key override x M800	\$1,278.00	\$1,380.00
ML20837*	Dormitory Entry with Deadbolt and inside lever switch x M802	\$1,865.00	\$1,967.00
	Dormitory Entry with Deadbolt and inside lever switch x M803	\$1,930.00	\$2,032.00

\*ML20837 only compatible with proximity readers, M802 and M803

## Access 800® Options

Description	Specify Quick Code	Add
100 User, keypad only	M800	No Charge
2000 User, keypad only	M801	\$155.00
2000 User, proximity only	M802	\$587.00
2000 User, keypad and proximity	M803	\$652.00
2000 User, keypad and RF actuation	M804	\$369.00
2000 User, proximity and RF actuation	M805	\$801.00
2000 User, keypad, proximity and RF actuation	M806	\$865.00
Gasket	M99	No Charge



Ordering Example Details

<b>ML20800</b>	ML20834	Key Override
	114	Marc Family Lever
	619	Finish
	RHR	Handing

## Stock Order

Quantity	Series/Function	Technology Code	Trim	Finish	Hand	Option
24	ML20834	TCAC2	114Z	619	RHR	M801



**ASSA ABLOY**

# Access 800® AC2 Mortise Locksets

ML20800 Series: Muséo Levers

January 1, 2019

contemporary levers to complement the interior design of your next project



JOSEF



GEORGES



1. Handed: specify hand when ordering
2. Contact factory for current lead time

613E Dark Oxidized Satin Bronze - Equivalent  
626 Satin Chromium Plated  
BSP Black Suede Powder Coat

605 Bright Brass, Clear Coated  
606 Satin Brass, Clear Coated  
611 Bright Bronze, Clear Coated  
612 Satin Bronze, Clear Coated  
613 Dark Oxidized Satin Bronze, Oil Rubbed  
613L Dark Oxidized Satin Bronze, Clear Coated

618 Bright Nickel Plated  
619 Satin Nickel Plated  
625 Bright Chromium Plated  
629 Bright Stainless Steel  
630 Satin Stainless Steel  
722 Black Oxidized Bronze, Oil Rubbed

Function	Description		
<b>Levers: Georgia, Pablo, Jackson, Salvador, Marc</b>			
ML20833	Without key override x M800	\$1,256.00	\$1,280.00
ML20834	With key override x M800	\$1,342.00	\$1,366.00
ML20835	Deadbolt without key override x M800	\$1,270.00	\$1,294.00
ML20836	Deadbolt with key override x M800	\$1,356.00	\$1,380.00
ML20837*	Dormitory Entry with Deadbolt and inside lever switch x M802	\$1,943.00	\$1,967.00
	Dormitory Entry with Deadbolt and inside lever switch x M803	\$2,008.00	\$2,032.00

\*ML20837 only compatible with proximity readers, M802 and M803

## Access 800® Options

Description	Specify Quick Code	Add
100 User, keypad only	M800	No Charge
2000 User, keypad only	M801	\$155.00
2000 User, proximity only	M802	\$587.00
2000 User, keypad and proximity	M803	\$652.00
2000 User, keypad and RF actuation	M804	\$369.00
2000 User, proximity and RF actuation	M805	\$801.00
2000 User, keypad, proximity and RF actuation	M806	\$865.00
Gasket	M99	No Charge



Ordering Example Details

**ML20800** | ML20834 Key Override  
133 Josef Family Lever  
619 Finish  
RHR Handing

## Stock Order

Quantity	Series/Function	Technology Code	Trim	Finish	Hand	Option
24	ML20834	TCAC2	133Z	619	RHR	M801



**ASSA ABLOY**

ASSA ABLOY, the global leader in door opening solutions

Corbin Russwin is a brand associated with ASSA ABLOY Access and Egress Hardware Group, Inc., an ASSA ABLOY Group company. Copyright © 2019, ASSA ABLOY Access and Egress Hardware Group, Inc. All rights reserved. Reproduction in whole or in part without the express written permission of ASSA ABLOY Access and Egress Hardware Group, Inc. is prohibited. Contact us at: 800-543-3658 or visit [www.corbinrusswin.com](http://www.corbinrusswin.com). In Canada contact us at: 800-461-3007 or visit [www.assaabloydss.ca](http://www.assaabloydss.ca)

# Access 800® AC2 Mortise Locksets

ML20800 Series: Muséo Levers

January 1, 2019

contemporary levers to complement the interior design of your next project

# MUSÉO®

PIET



629	Bright Stainless Steel
630	Satin Stainless Steel

Function

Description

Levers: Piet

ML20833	Without key override x M800	\$1,280.00
ML20834	With key override x M800	\$1,366.00
ML20835	Deadbolt without key override x M800	\$1,294.00
ML20836	Deadbolt with key override x M800	\$1,380.00
ML20837 <sup>1</sup>	Dormitory Entry with Deadbolt and inside lever switch x M802	\$1,967.00
	Dormitory Entry with Deadbolt and inside lever switch x M803	\$2,032.00

## Access 800® Options

Description	Specify Quick Code	Add
100 User, keypad only	M800	No Charge
2000 User, keypad only	M801	\$155.00
2000 User, proximity only	M802	\$587.00
2000 User, keypad and proximity	M803	\$652.00
2000 User, keypad and RF actuation	M804	\$369.00
2000 User, proximity and RF actuation	M805	\$801.00
2000 User, keypad, proximity and RF actuation	M806	\$865.00



Ordering Example Details

**ML20800**

ML20834	Key Override
21MZ	Piet Family Lever - Polished with Satin Insert
293029	Lever Finish
	Polished with satin stainless steel insert (630), polished stainless steel (629) shank and polished stainless steel (629) grip
625	Lock Finish
RHR	Handing

## Stock Order

Quantity	Series/Function	Technology Code	Trim	Lever Finish	Lock <sup>2</sup> Finish	Hand	Option
2	ML20834	TCAC2	21MZ	293029	625	RHR	M801

<sup>1</sup>ML20837 only compatible with proximity readers, M802 and M803

<sup>2</sup>Escutcheons (lock finish) are plated to match satin stainless steel (630) and polished stainless steel (629) finishes.



**ASSA ABLOY**

# Access 800® AC2 Exit Devices

ED5000 Series: Muséo Levers

January 1, 2019

contemporary levers to complement the interior design of your next project

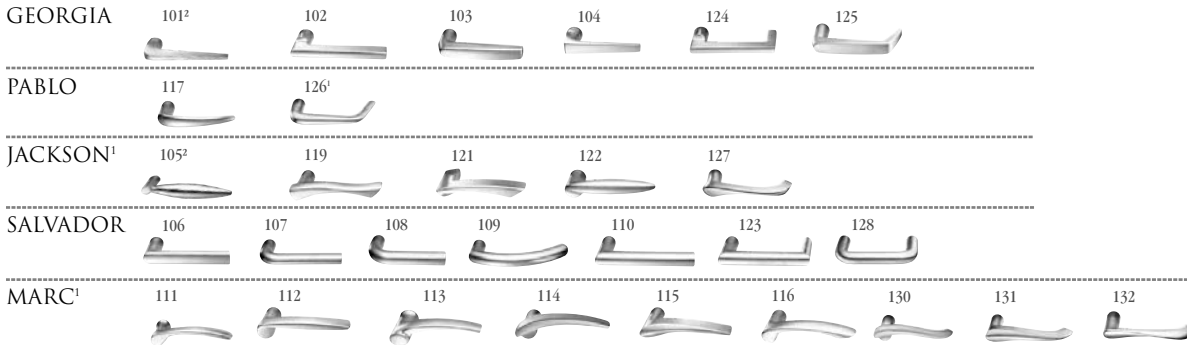

1. Handed: specify hand when ordering.
2. Contact factory for current lead time.

\*629 and \*630 finish options are Not available for all Muséo levers. Please refer to page 20 for availability.

### Levers: Georgia, Pablo, Jackson, Salvador, Marc

613E Dark Oxidized Satin Bronze - Equivalent	605 Bright Brass, Clear Coated	618 Bright Nickel Plated
630* Satin Stainless Steel	606 Satin Brass, Clear Coated	619 Satin Nickel Plated
BSP Black Suede Powder Coat	611 Bright Bronze, Clear Coated	625 Bright Chromium Plated
	612 Satin Bronze, Clear Coated	629* Bright Stainless Steel
	613 Dark Oxidized Satin Bronze, Oil Rubbed	722 Black Oxidized Bronze, Oil Rubbed
	613L Dark Oxidized Satin Bronze, Clear Coated	

Function	Description			
<b>Use with ED5200(S)(A) Rim/SecureBolt® Device</b>				
9833	Without key override x M800	\$1,265.00	\$1,285.00	Note: For key override, add Cylinder Quick Code Option and price. *When specifying function, prefix with lever design. Refer to page 224 for mechanical push bar pricing.
9834	With key override x M800			
<b>Use with ED5633(A)L &amp; ED5634(A)L Mortise Device</b>				
9M833	Without key override x M800	\$1,221.00	\$1,241.00	Note: For key override, add Cylinder Quick Code Option and price. See page 93. *When specifying function, prefix with lever design. Refer to page 224 for mechanical push bar pricing.
9M834	With key override x M800			

Notes: 9M833 and 9M834 cannot be retrofitted to an existing ED5000 Series mortise device. When ordered as "Trim Only" 9M833 and 9M834 will be furnished with the appropriate mortise lock (refer to Parts Price List for mortise lock body pricing). If a "Trim Only" order is intended for retrofitting and exit device with an M91 Bolt Monitor or an M93 Trim Monitor function, that function must be specified with the trim order to ensure the correct lock is furnished.

### Access 800® Options

Description	Specify Quick Code	Add
100 User, keypad only	M800	No Charge
2000 User, keypad only	M801	\$155.00
2000 User, proximity only	M802	\$587.00
2000 User, keypad and proximity	M803	\$652.00
2000 User, keypad and RF actuation	M804	\$369.00
2000 User, proximity and RF actuation	M805	\$801.00
2000 User, keypad, proximity and RF actuation	M806	\$865.00
Gasket	M99	No Charge

- Notes:
1. Available 0-bitted and Key Random (KR) only.
  2. Available 0-bitted only.

**BHMA CERTIFIED** Ordering Example Details  
**ED5000 Series**  
 112 Marc Family Lever  
 9M833 Mortise without key override function

Trim Only					
Quantity	Trim/Function	Technology Code	Finish	Hand	Options
24	1129M833	TCAC2	625	RHR	M800



ASSA ABLOY, the global leader in door opening solutions

Corbin Russwin is a brand associated with ASSA ABLOY Access and Egress Hardware Group, Inc., an ASSA ABLOY Group company. Copyright © 2019, ASSA ABLOY Access and Egress Hardware Group, Inc. All rights reserved. Reproduction in whole or in part without the express written permission of ASSA ABLOY Access and Egress Hardware Group, Inc. is prohibited. Contact us at: 800-543-3658 or visit [www.corbinrusswin.com](http://www.corbinrusswin.com). In Canada contact us at: 800-461-3007 or visit [www.assaabloydss.ca](http://www.assaabloydss.ca)

JOSEF



GEORGES



1. Handed: specify hand when ordering
2. Contact factory for current lead time

Levers: Georgia, Pablo, Jackson, Salvador, Marc

613E	Dark Oxidized Satin Bronze - Equivalent
630	Satin Stainless Steel
BSP	Black Suede Powder Coat

605	Bright Brass, Clear Coated
606	Satin Brass, Clear Coated
611	Bright Bronze, Clear Coated
612	Satin Bronze, Clear Coated
613	Dark Oxidized Satin Bronze, Oil Rubbed
613L	Dark Oxidized Satin Bronze, Clear Coated

618	Bright Nickel Plated
619	Satin Nickel Plated
625	Bright Chromium Plated
629	Bright Stainless Steel
722	Black Oxidized Bronze, Oil Rubbed

Function	Description				
<b>Use with ED5200(S)(A) Rim/SecureBolt® Device</b>					
9833	Without key override x M800	\$1,275.00	\$1,295.00	Note: For key override, add Cylinder Quick Code Option and price. *When specifying function, prefix with lever design. Refer to page 224 for mechanical push bar pricing.	
9834	With key override x M800				
<b>Use with ED5633(A)L &amp; ED5634(A)L Mortise Device</b>					
9M833	Without key override x M800	\$1,231.00	\$1,251.00		
9M834	With key override x M800				

Note: 9M833 and 9M834 cannot be retrofitted to an existing ED5000 Series mortise device. When ordered as "Trim Only" 9M833 and 9M834 will be furnished with the appropriate mortise lock (refer to Parts Price List for mortise lock body pricing). If a "Trim Only" order is intended for retrofitting and exit device with an M91 Bolt Monitor or an M93 Trim Monitor function, that function must be specified with the trim order to ensure the correct lock is furnished.

Access 800® Options

Description	Specify Quick Code	Add
100 User, keypad only	M800	No Charge
2000 User, keypad only	M801	\$155.00
2000 User, proximity only	M802	\$587.00
2000 User, keypad and proximity	M803	\$652.00
2000 User, keypad and RF actuation	M804	\$369.00
2000 User, proximity and RF actuation	M805	\$801.00
2000 User, keypad, proximity and RF actuation	M806	\$865.00
Gasket	M99	No Charge

Notes:

1. Available 0-bitted and Key Random (KR) only.
2. Available 0-bitted only.



Ordering Example Details

ED5000 Series

133  
9M833

Josef Family Lever  
Mortise without key  
override function

Trim Only

Quantity	Trim/Function	Technology Code	Finish	Hand	Options
24	1339M833	TCAC2	625	RHR	M800



ASSA ABLOY

# Access 800® AC2 Exit Devices

ED5000 Series: Muséo Levers

January 1, 2019

contemporary levers to complement the interior design of your next project



PIET



Function	Description		
<b>Use with ED5200(S)(A) Rim/SecureBolt® Device</b>			
9833	Without key override x M800		\$1,295.00
9834	With key override x M800		
<b>Use with ED5633(A)L &amp; ED5634(A)L Mortise Device</b>			
9M833	Without key override x M800		\$1,251.00
9M834	With key override x M800		

629	Bright Stainless Steel
630	Satin Stainless Steel

Note: 9M833 and 9M834 cannot be retrofitted to an existing ED5000 Series mortise device. When ordered as "Trim Only" 9M833 and 9M834 will be furnished with the appropriate mortise lock (refer to Parts Price List for mortise lock body pricing). If a "Trim Only" order is intended for retrofitting and exit device with an M91 Bolt Monitor or an M93 Trim Monitor function, that function must be specified with the trim order to ensure the correct lock is furnished.

## Access 800® Options

Description	Specify Quick Code	Add
100 User, keypad only	M800	No Charge
2000 User, keypad only	M801	\$155.00
2000 User, proximity only	M802	\$587.00
2000 User, keypad and proximity	M803	\$652.00
2000 User, keypad and RF actuation	M804	\$369.00
2000 User, proximity and RF actuation	M805	\$801.00
2000 User, keypad, proximity and RF actuation	M806	\$865.00
Gasket	M99	No Charge

- Notes:
1. Available 0-bitted and Key Random (KR) only.
  2. Available 0-bitted only.



### Ordering Example Details

<b>ED5000 Series</b>	21W	Piet Family Lever - Wood Insert
	9M833	Mortise without key override function
	29BH29	Lever Finish
		Wood insert with polished stainless steel (629) shank and polished stainless steel (629) grip
	625	Lock Finish
	RHR	Handing

Trim Only						
Quantity	Trim/Function	Technology Code	Lever Finish	Lock <sup>2</sup> Finish	Hand	Option
2	21W9M833	TCAC2	29BH29	625	RHR	M800

<sup>2</sup>Escutcheons (lock finish) are plated to match satin stainless steel (630) and polished stainless steel (629) finishes.



ASSA ABLOY, the global leader in door opening solutions

Corbin Russwin is a brand associated with ASSA ABLOY Access and Egress Hardware Group, Inc., an ASSA ABLOY Group company. Copyright © 2019, ASSA ABLOY Access and Egress Hardware Group, Inc. All rights reserved. Reproduction in whole or in part without the express written permission of ASSA ABLOY Access and Egress Hardware Group, Inc. is prohibited. In Canada contact us at: 800-543-3658 or visit [www.corbinrusswin.com](http://www.corbinrusswin.com). In Canada contact us at: 800-461-3007 or visit [www.assaabloydss.ca](http://www.assaabloydss.ca)

# Pushpad Exit Devices

ED4000 Series: Muséo Levers with 800 Series Escutcheon

January 1, 2019

contemporary levers to complement the interior design of your next project

# MUSÉO®

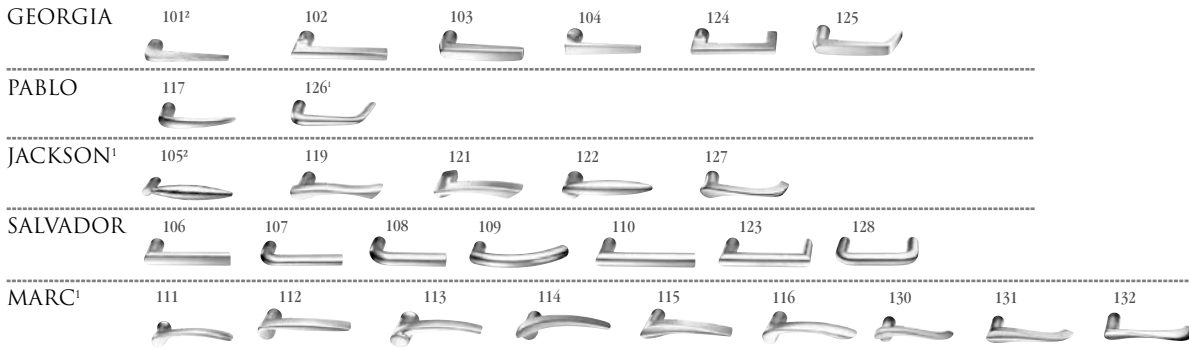

1. Handed: specify hand when ordering
2. Contact factory for current lead time

\*629 and \*630 finish options are Not available for all Muséo levers. Please refer to page 20 for availability.

613E	Dark Oxidized Satin Bronze - Equivalent
630*	Satin Stainless Steel
BSP	Black Suede Powder Coat

605	Bright Brass, Clear Coated
606	Satin Brass, Clear Coated
611	Bright Bronze, Clear Coated
612	Satin Bronze, Clear Coated
613	Dark Oxidized Satin Bronze, Oil Rubbed
613L	Dark Oxidized Satin Bronze, Clear Coated
618	Bright Nickel Plated
619	Satin Nickel Plated
625	Bright Chromium Plated
629*	Bright Stainless Steel
722	Black Oxidized Bronze, Oil Rubbed

### Function

<b>Rim/SVR/CVR</b>	810 850	Passage Dummy Nightlatch	\$658.00	\$684.00
<b>Options</b>	M60	Parabolic Escutcheon	Add \$78.00 per device	Add \$78.00 per device

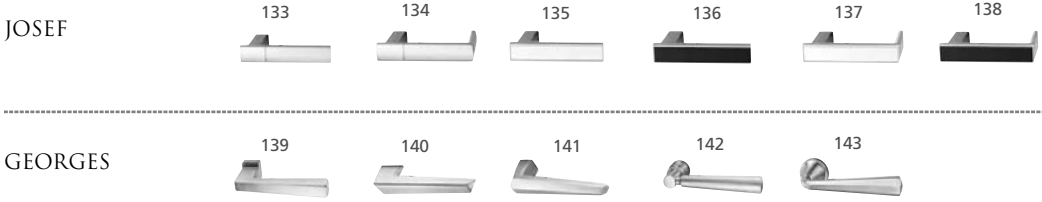

1. Handed: specify hand when ordering
2. Contact factory for current lead time

613E	Dark Oxidized Satin Bronze - Equivalent
630*	Satin Stainless Steel
BSP	Black Suede Powder Coat

605	Bright Brass, Clear Coated
606	Satin Brass, Clear Coated
611	Bright Bronze, Clear Coated
612	Satin Bronze, Clear Coated
613	Dark Oxidized Satin Bronze, Oil Rubbed
613L	Dark Oxidized Satin Bronze, Clear Coated
618	Bright Nickel Plated
619	Satin Nickel Plated
625	Bright Chromium Plated
629*	Bright Stainless Steel
722	Black Oxidized Bronze, Oil Rubbed

<b>Rim/SVR/CVR</b>	810 850	Passage Dummy Nightlatch	\$658.00	\$684.00
<b>Options</b>	M60	Parabolic Escutcheon	Add \$78.00 per device	Add \$78.00 per device



ASSA ABLOY

# Pushpad Exit Devices

ED4000 Series: Muséo Levers with 800 Series Escutcheon

January 1, 2019

contemporary levers to complement the interior design of your next project



PIET



Parabolic Trim  
Specify: M60

Standard Trim

629	Bright Stainless Steel
630	Satin Stainless Steel

### Function

<b>Rim/SVR/CVR</b>	810	Passage Dummy Nightlatch		\$684.00
	850			
<b>Options</b>	M60	Parabolic Escutcheon		Add \$78.00 per device



**ASSA ABLOY**

ASSA ABLOY, the global leader in door opening solutions

Corbin Russwin is a brand associated with ASSA ABLOY Access and Egress Hardware Group, Inc., an ASSA ABLOY Group company. Copyright © 2019, ASSA ABLOY Access and Egress Hardware Group, Inc. All rights reserved. Reproduction in whole or in part without the express written permission of ASSA ABLOY Access and Egress Hardware Group, Inc. is prohibited.

Contact us at: 800-543-3658 or visit [www.corbinrusswin.com](http://www.corbinrusswin.com). In Canada contact us at: 800-461-3007 or visit [www.assaabloydss.ca](http://www.assaabloydss.ca)



# Pushpad Exit Devices

ED5000 Series: Muséo Levers with 900 Series Escutcheon

January 1, 2019

contemporary levers to complement the interior design of your next project

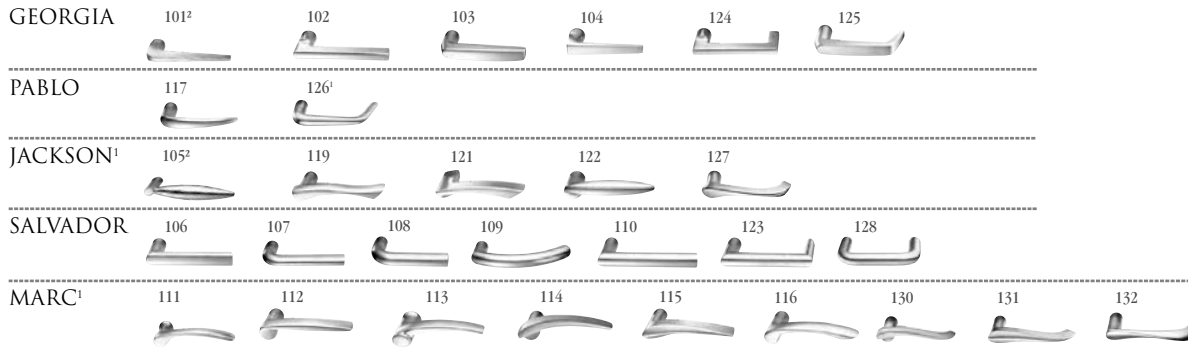

Parabolic Trim  
Specify: M60



Standard Trim

1. Handed: specify hand when ordering
2. Contact factory for current lead time

\*629 and \*630 finish options are Not available for all Muséo levers. Please refer to page 20 for availability.

613E	Dark Oxidized Satin Bronze - Equivalent	605	Bright Brass, Clear Coated
630*	Satin Stainless Steel	606	Satin Brass, Clear Coated
BSP	Black Suede Powder Coat	611	Bright Bronze, Clear Coated
		612	Satin Bronze, Clear Coated
		613	Dark Oxidized Satin Bronze, Oil Rubbed
		613L	Dark Oxidized Satin Bronze, Clear Coated
		618	Bright Nickel Plated
		619	Satin Nickel Plated
		625	Bright Chromium Plated
		629*	Bright Stainless Steel
		722	Black Oxidized Bronze, Oil Rubbed

## Function

<b>Rim/SVR/CVR</b>	910	Passage		
	950	Dummy		
	955	Classroom	\$658.00	\$684.00
	957	Nightlatch		
	959	Storeroom		
<b>Mortise</b>	9M10	Passage		
	9M50	Dummy	\$658.00	\$684.00
	9M55	Classroom		
	9M57	Nightlatch		
<b>Electrified</b>	9903	Fail Safe	\$1,046.00	\$1,072.00
	9905	Fail Secure		
<b>Options</b>	M60	Parabolic Escutcheon	Add \$78.00 per device	Add \$78.00 per device

## Ordering Example Details

- 111 Marc family lever
- 9M50 Dummy Trim; Mortise
- 625 Bright Chrome finish
- RHR Right Hand Reverse
- D214 2-1/4" Door Thickness
- M60 Parabolic Escutcheon Design (mechanical)



Trim Only					
Quantity	Trim/Function	Finish	Hand	Door Thickness	Option
24	1119M50	625	RHR	D214	M60



ASSA ABLOY

# Pushpad Exit Devices

ED5000 Series: Muséo Levers with 900 Series Escutcheon

January 1, 2019

contemporary levers to complement the interior design of your next project



## JOSEF



## GEORGES



Parabolic Trim  
Specify: M60



Standard Trim

1. Handed: specify hand when ordering
2. Contact factory for current lead time

613E	Dark Oxidized Satin Bronze - Equivalent	605	Bright Brass, Clear Coated
630	Satin Stainless Steel	606	Satin Brass, Clear Coated
BSP	Black Suede Powder Coat	611	Bright Bronze, Clear Coated
		612	Satin Bronze, Clear Coated
		613	Dark Oxidized Satin Bronze, Oil Rubbed
		613L	Dark Oxidized Satin Bronze, Clear Coated
		618	Bright Nickel Plated
		619	Satin Nickel Plated
		625	Bright Chromium Plated
		629	Bright Stainless Steel
		722	Black Oxidized Bronze, Oil Rubbed

## Function

Function	Model	Description	Price	Option Price
Rim/SVR/CVR	910	Passage		
	950	Dummy		
	955	Classroom	\$658.00	\$684.00
	957	Nightlatch		
	959	Storeroom		
Mortise	9M10	Passage		
	9M50	Dummy	\$658.00	\$684.00
	9M55	Classroom		
	9M57	Nightlatch		
Electrified	9903	Fail Safe	\$1,046.00	\$1,072.00
	9905	Fail Secure		
Options	M60	Parabolic Escutcheon	Add \$78.00 per device	Add \$78.00 per device

## Ordering Example Details

- 133 Josef family lever
- 9M50 Dummy Trim; Mortise
- 625 Bright Chrome finish
- RHR Right Hand Reverse
- D214 2-1/4" Door Thickness
- M60 Parabolic Escutcheon Design (mechanical)



Trim Only					
Quantity	Trim/Function	Finish	Hand	Door Thickness	Option
24	1339M50	625	RHR	D214	M60



ASSA ABLOY

ASSA ABLOY, the global leader in door opening solutions

Corbin Russwin is a brand associated with ASSA ABLOY Access and Egress Hardware Group, Inc., an ASSA ABLOY Group company. Copyright © 2019, ASSA ABLOY Access and Egress Hardware Group, Inc. All rights reserved. Reproduction in whole or in part without the express written permission of ASSA ABLOY Access and Egress Hardware Group, Inc. is prohibited.

Contact us at: 800-543-3658 or visit [www.corbinrusswin.com](http://www.corbinrusswin.com). In Canada contact us at: 800-461-3007 or visit [www.assaabloydss.ca](http://www.assaabloydss.ca)

# Pushpad Exit Devices

ED5000 Series: Muséo Levers with 900 Series Escutcheon

January 1, 2019

contemporary levers to complement the interior design of your next project



PIET



Parabolic Trim  
Specify: M60

Standard Trim

629	Bright Stainless Steel
630	Satin Stainless Steel

## Function

<b>Rim/SVR/CVR</b>	910	Passage	\$684.00
	950	Dummy	
	955	Classroom	
	957	Nightlatch	
	959	Storeroom	
<b>Mortise</b>	9M10	Passage	\$684.00
	9M50	Dummy	
	9M55	Classroom	
<b>Electrified</b>	9903	Fail Safe	\$1,072.00
	9905	Fail Secure	
<b>Options</b>	M60	Parabolic Escutcheon	Add \$78.00 per device



## Ordering Example Details

21M Piet Family Lever - Polished with Satin Insert  
 9M50 Dummy Trim; Mortise  
 293029 Lever Finish  
 Polished with satin stainless steel insert (630), polished stainless steel (629) shank and polished stainless steel (629) grip  
 629 Lock Finish  
 D214 2-1/4" Door Thickness  
 M60 Parabolic Escutcheon Design (mechanical)

Trim Only						
Quantity	Trim/Function	Lever Finish	Lock Finish	Hand	Door Thickness	Option
2	21M9M50	293029	629	RHR	D214	M60



ASSA ABLOY

**KEY SYSTEMS**
**PAGES**
**General Information:**

Standard Features: Keying, Keys, Pins	61
Keyway Availability	62
General Information	63
Policy	64
Construction Core Program	65
Keying, Stamping, Cut Keys	66
Bitting List	67
Key Wizard	68

**Key Blanks:**

Stamping, Standard, Pyramid, Access 3	69
Security Bow, Large Bow, Emergency Blanks, Emergency Master Key	70

**Access 3 AP Security Cylinders**

AP Fixed Core (Mortise/Rim), AP LFIC (Mortise/Rim)	71
AP LFIC, Fixed Core Component Cylinder, Deadlock Cylinder	72
AS Fixed Core (Mortise/Rim), AS LFIC (Mortise/Rim)	73
AS LFIC Core, AS Fixed Core Component Cylinder, AS Fixed Core Deadlock Cylinder	74
AHS Fixed Core (Mortise/Rim), AHS LFIC (Mortise/Rim)	75
AHS LFIC Core, AHS Fixed Core, Deadlock Cylinder, UL LFIC 6-Pin Housing (Mortise/Rim)	76

**Pyramid Cylinders:**

Fixed Core (Mortise/Rim)	77
Key-In-Lever/Knob High Security UL437 Listed	78
Interchangeable Core (Mortise/Rim)	79
Fixed Core (Mortise/Rim)	80
Key-In-Lever/Knob	81
Interchangeable Core (Mortise/Rim)	82

**Conventional Cylinders:**

Standard Mortise	83
Flexible Head Mortise, Concealed Shell Mortise	84
Special Function Mortise, Hotel Function Mortise, Brink Function Mortise	85
Non-Keyed Mortise, Thumbturn, Dummy, Rim Thumbturn Cylinders	86
Rim (.552 diameter Plug)	87
Key-In-Lever/Knob (.509 Plug), DL2200, DL3200 Series Cylindrical Deadlock	88
Key-In-Lever/Knob UT5200, CK4200, CK4400, G10, PL5000	89
Key-In-Lever/Knob (.552 dia Plug), Adams Rite 4025 Pull	90

**Interchangeable Core Cylinders:**

IC Mortise, Hotel Function IC Mortise	91
IC Rim, Core Only	92
LFIC Mortise Housing Only, LFIC Rim Housing Only	93
SFIC Mortise Housing Only, SFIC Rim Housing Only	94

**Security Cylinders:**

Standard Security Mortise	95
Special Function Security Mortise, Hotel, Blockout, Brink Function Cylinders	96
Security Rim	97
Security Key-In-Lever/Knob (.552 Plug)	98
Security Interchangeable Cylinders: IC Mortise, Hotel Function	99
Security Interchangeable Cylinders: IC Rim, Security Core	100

**Master Ring Cylinders:**

Standard Master Ring Cylinder	101
Flexible Head Master Ring Mortise	102
Master Ring Rim, CK4200 & UT5200 Series, Special Applications	103
Service Equipment	104

**Standard Features**

**Keying**

0-bitted except high security; random keying option offered at no charge

**Keys**

Two nickel silver keys

**Pins**

5-pin for 252, 752, 852 and A Class; all others furnished 6-pin

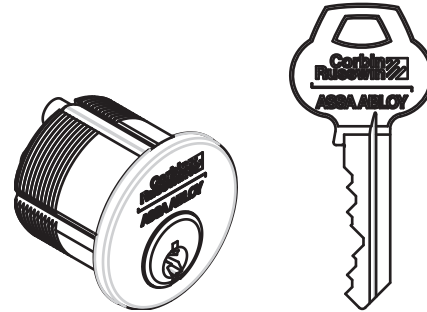

**Ordering Examples**

**Stock Order - Conventional Cylinder**

Quantity	Cylinder	Finish
25	CR1000	626

**Contract/Detailed Order - Conventional Cylinder**

Quantity	Keyset	Cylinder	Finish	Option
25	AA1	CR1000-138-A02-7	626	CKC2

**Stock Order - IC Cylinder**

Quantity	Cylinder	Finish
20	CR1080	626

**Contract/Detailed Order - IC Cylinder**

Quantity	Keyset	Cylinder	Finish	Misc.Option
4	AF3	CR1080-112-A04-7	606	CKC2

## Keyway Availability

Corbin Russwin keyways are separated into categories known as **Key Classes**, based on blade width and bitting dimensions. **Certain key blanks and cylinders are not available for certain key classes**, and notes to that effect appear in the catalog and price book. If you find a keyway exclusion notice and do not know the class of the keyway you need, refer to the list below.

Some keyways listed here are *inactive*. They remain available to support existing systems, but no *new systems* are generated on them.

Keyway	Remarks
26	Discontinued
27 Series	X Class (28 and 29 are inactive)
57 Series	X Class
59 Series	Z Class
60	Z Class
67 Series	X Class (68 and 69 are inactive)
70	Z Class
77 Series	X Class (77 and 78 are inactive)
97 and 99	X Class
252	852 Class (inactive)
752	752 Class (inactive)
852	852 Class (inactive)
981, 982, 983	981 Class (inactive)
A1 thru A24	A Class (inactive)
Access 3	Access 3
AR, BR, BL	X Class
D1 thru D4	DH Class
G	852 Class (inactive)
H1 thru H8	DH Class
L1 thru L4	Z Class (L2 formerly CCL)
N1 thru N28	N Class (inactive)
Pyramid	Pyramid
Protected	DH or Z Class
Restricted	DH or Z Class

## Keyway Name Changes

All Multiplex Keyways using letters with numbers are now standardized to have the letter first and number last. Also, keyway designation will no longer include the number of pins. K and Z designations are being replaced by the more common N and A Series, respectively. 960 and 970 Series are replaced by the more common 980 Series. Only the following Russwin® older keyways are affected:

Old Designation	Pins	New Designation
1N thru 28N	6	N1 thru N28
1K thru 28K	5 or 7	N1 thru N28
1A thru 24A	5	A1 thru A24
1Z thru 24Z	6	A1 thru A24
961, 962, 963	6	981, 982, 983
971, 972, 973	7	981, 982, 983

Category	Description	Price
Stock L4	Keyway used for stock orders and limited keying systems.	No Charge
Standard (see list at left)	Keyways in general use for keying systems.	No Charge
Restricted (not published)	Selective keyways for use in new and existing keying systems.	No Charge
Protected	Notice of Acceptance showing facilities name, address and contact information must be submitted to key records before orders can be processed. Key system administration approval required prior to processing of order.	No Charge
Pyramid	One of Corbin Russwin's line of high security cylinders	See Pyramid pages 77-82
Security	Old Emhart®/Security cylinders.	For existing systems only
Access 3	Corbin Russwin's highest level of key control.	See pages 71-76

## Key Systems Security Policy

The purpose of this security policy is to enforce our policies Access 3, Pyramid, Security, Protected & Restricted keyway product, including key system information.

No master key system information or security related product is to be given or sold to anyone other than the facility owner through written correspondence. Verification must be submitted (fax copy will be acceptable) to Key Systems Administration. The verification must be on the facility's letterhead and signed by a facility authorized systems administrator. Key Systems Administration does not maintain "Letters of Authorization" on file. Each order must be accompanied by proper authorization. Only after the authorization has been verified will the order be processed for production.

Also includes:

- Bitting information (even one bitting, absolutely no top-level master keys)
- Bitting lists (all formats; i.e., hard copy, disc)
- Key blanks and systems components for Access 3, Pyramid, protected and security cylinder systems.

Please note:

- No orders are to be processed through Key Systems Administration without proper authorization.
- Only orders with appropriate authorization attached will be given priority.
- Requests for systems information without proper authorization from the owner will be denied.
- Requests for information regarding the purchase of any systems support products as listed above will be referred to the local authorized sales agency.
- Refer to the current price lists for additional policies and procedures as they relate to this security policy.

Remember:

The purpose for the establishment of any security system is to provide an increased level of protection for the Facility owner.



## Construction Core Program

### How To Order

Use Quick Code CT6 for 6-PIN, CT7 for 7-PIN, and CTP for Access 3, Pyramid IC products. Use a separate purchase order or line item to order the permanent systems' core.

### Cut Keys

Specify the required number of change keys and control keys on the order. Two control keys are provided at no charge. Two change keys are provided at no charge for the first 20 units ordered. One additional change key is provided for every 10 additional units at no charge.

Examples: 25 units provide 2 operating keys; 30 units provide 3; 100 units provide 10. Additional keys will be invoiced at the prevailing cut key price.

### How To Return Cores

Contact your Customer Service Representative for a Returned Goods Authorization.

Provide the factory order number and year of the original order. Credit is issued for all cores returned in good operating condition, based on the price of a standard 6- or 7-pin core at the time of the original order.

Applicable discounts to the original unit are applied to the returned core.

Current pricing is as follows:	Price
6-PIN CONSTRUCTION CORE: (e.g. 8000-CT6) returned for credit	\$74.00
7-PIN CONSTRUCTION CORE: (e.g. 8000-CT7) returned for credit	\$76.00

## How To Price

Use Quick Code charts in lockset and exit device price sections.

1 ea. Lockset	ML2051 NSA 626	\$941.00	List Price
x Construction Core	CTP	\$74.00	List Price
		\$1,015.00	Subtotal
	Less 50/25% discount	\$380.63	Subtotal Net Price
1 ea. Pyramid Permanent Core	CR8027 x 626	\$129.00	List Price
	Less 50% discount	\$64.50	Net Price
		\$445.13	Subtotal Net Price
Return Construction Core	8000 Construction Core	\$74.00	List Price
	Less 50/25% discount	\$27.75	(Credit - RGA from factory)
		\$417.38	Your Total Cost

**Cylinders for Competitor Products:**

CORBIN RUSSWIN cylinders or cores for use in non-CORBIN RUSSWIN manufactured locking devices for which CORBIN RUSSWIN has an equivalent, will be assessed an additional Cylinder Service Fee. This fee applies to masterkeyed cylinder only orders, 1 bitted high security cylinders and zero or 1 bitted restricted cylinder orders.

### Keying

Description	Specify Quick Code	Add or Deduct
Keyed random <sup>3</sup>	KR	No Charge
Masterkey Service Fee. Applies to cylinders not being installed in Assa Abloy products		Consult Factory
Master keyed (all cylinders except CR8000, CR8020, CR8027 IC Core CR8500, CR8600, CR8700 core)	specify keyset	Add \$16.00 per cylinder
Master keyed Pyramid (except CR8020, CR8027 IC Core)	specify keyset	Add \$16.00 per cylinder
Master keyed Access 3 (except CR8500, CR8600, CR8700 IC Core)	specify keyset	Add \$16.00 per cylinder
Master keyed Security (including IC cylinder and core)	specify keyset	Add \$16.00 per cylinder
Master keyed (CR8000, CR8020, CR8027 IC Core CR8500, CR8600, CR8700)	specify keyset	No Charge
Master keyed to customer bittings or sample key	specify keyset	Add \$16.00 per cylinder
Construction master keyed <sup>1,2</sup>	CMK	Add \$16.00 per cylinder
Temporary Construction core, 6-pin (Red, Blue or Green) including Access 3 AP & AS	CT6R, CT6B, CT6G	No Charge
Temporary Construction core, 7-pin (Red, Blue or Green)	CT7R, CT7B, CT7G	No Charge
Temporary Construction core, 6-pin (Red, Blue or Green) Access 3 AHS	CT6AHR, CT6AHB, CT6AHG	No Charge
Temporary Construction core, Access 3 Pyramid	CTP	No Charge
Temporary Disposable core <sup>7</sup>	CT6D, CT7D, CTPD	No Charge
Small Format Temporary Disposable Cores <sup>7</sup>	CTSD	No Charge
Uncombined (Access 3, Pyramid, Security fixed and IC core) <sup>8</sup>	UC	Deduct \$8.00
Uncombined (conventional CR8000 IC core) <sup>8</sup>	UC	Deduct \$2.00
Bump-Resistant Cylinder; Standard on Access 3 except LFIC	BRP	Add \$23.00 per cylinder
More than 2 keys per lock	KY# (e.g., KY6)	See Cut Keys Section Below

### Stamping

Visual key control (VKC)		
- No stamping	VKC0	\$4.50
- Keys only	VKC1	No Charge
- Cylinders and Keys <sup>4</sup>	VKC2	\$8.00
- Cylinders only <sup>4</sup>	VKC3	\$8.00
Concealed key control (CKC)		
- CKC cylinders with VKC keys	CKC2	\$8.00
- CKC cylinders only <sup>4</sup>	CKC3	\$8.00
DO NOT DUPLICATE	Order by number	see pages 69-74
End user custom die stamps* for key bows <sup>6</sup>		\$4.00
Other stamping on keys or cylinders <sup>6</sup> (Up to 7 characters on cylinders)		\$3.00 per character

\* For development of custom key stamp add one-time charge of \$840.00<sup>6</sup>. Dies property of Corbin Russwin.

### Cut Keys

	Conventional Keyway <sup>5</sup> Restricted Keyway		Protected Keyway		Security Keys	Pyramid Keys	Access 3		
	10 Series Bow	50 Series Bow	10 Series Bow	50 Series Bow	KB90 or KB92	KB28	AP	AS	AHS
Extra cut change keys with lockset/cylinder	\$5.30	\$5.80	\$6.30	\$6.70	\$19.50	\$10.30	\$5.20	\$10.30	\$10.30
Cut change keys without lockset/cylinder	\$11.00	\$11.50	\$12.00	\$12.40	\$19.50	\$15.00	\$11.00	\$16.10	\$16.10
Cut master keys (all levels) and control keys with or without lockset/cylinder	\$11.00	\$11.50	\$12.00	\$12.40	\$19.50	\$15.00	\$11.00	\$16.10	\$16.10
Cut construction master keys with or without lockset/cylinder	\$11.00	\$11.50	\$12.00	\$12.40	N/A	N/A	\$11.00	\$16.10	NA

Note: Two (2) cut change keys are provided per lockset or cylinder at no charge. Keyblanks cannot be substituted for cut keys.

For keys with bows other than 10 and 90, specify "KB" + number as Quick Code, e.g. KB12. KB92 cannot be furnished with VKC or other markings. Cylinders pinned directly to GMK or MK level keys do not include cut keys. Please order GMK and MK keys separately.

Notes:

1. CMK Construction master keying charge is in addition to master keying charge.
2. CMK Construction master keying is not available in Pyramid or Security series.
3. Access 3 and Pyramid series is not available keyed random or 0-bit.
4. VKC2, VKC3 is not available in Access 3, Pyramid or Security series.
5. Conventional cut change keys are furnished standard with key section, system type and bitting number.
6. Discount 50% only.
7. Disposable cores ordered separately - \$37.00 per set. Sold in multiples of 10 sets.
8. Keys, springs, and spring covers not included.

<b>Presentation Keys</b>		<b>Discount 50% Only</b>	
Specify:	Key Symbol; Plating (nickel is standard); Stamping; Bow, if available for key class		
Standard Bow:	51 for all except below		
	90 for Security series	Nickel Plated	\$112.00
	10 for 6PIN 852 & A Class keys	Gold Plated	\$215.00

### Bitting Lists

A letter of authorization from the end user is required to release a copy of the bitting lists for a factory established system. To protect the security of keying systems, bitting lists will only be sent to the end user or his designated agent, via Certified Mail Return Receipt Requested or UPS AOD. Copies will not be transmitted via fax. The complete name and address where the bitting list is to be sent must be indicated on the letter of authorization and on the purchase order.

Master key system bitting lists will not be created by Corbin Russwin Key Systems Administration unless the request is accompanied by an order for factory keyed product. Corbin Russwin releases all liabilities for cylinders not pinned to factory master key systems.

<b>Number of Bittings</b>	<b>Discount 50% Only</b>
1-50	\$203.00
51-200	\$311.00
201-1000	\$415.00
1001-3000	\$523.00
3001-6000*	\$612.00
6001-9000*	\$908.00
Over 9000*	Consult Key Systems Administration

\*Lead times may vary; consult Key Systems Administration

**NOTE:** Bitting Lists requested for keysets ordered with factory keyed product for either a new or existing system will be provided at no charge, except when KeyWizard® disc requested. For existing system pricing above will apply. For new system see page 50.

- Additional Bittings or P.O.'s for Bitting Lists Only – **EXISTING MASTER KEY GROUPS**  
Up to 10 **total** for keysets tied to **existing** master key groups will be provided at no charge  
11 or more bittings will be charged per above chart
- Additional Bittings or P.O.'s for Bitting Lists Only – **NEW MASTER KEY GROUPS**  
Regardless of the quantity being requested, will be charged per above chart

**Bitting lists will be billed at 50% off of list price – No additional discounts will apply.**

These prices are for a hierarchial Master Key system with no cross-keying of selected keys.  
For special requirements or for systems prior to 1999, consult Key Systems Administration for a quote.

Corbin Russwin releases all liabilities for cylinders not pinned to factory master key systems.

#### Cylinders for Competitor Products:

CORBIN RUSSWIN cylinders or cores for use in non-CORBIN RUSSWIN manufactured locking devices for which CORBIN RUSSWIN has an equivalent, will be assessed an additional Cylinder Service Fee. This fee applies to masterkeyed cylinder only orders, 1 bitted high security cylinders and zero or 1 bitted restricted cylinder orders.

<b>Key Management Software</b>		<b>Discount 50% Only</b>
Key Wizard® - Special online ordering procedures - contact customer service for more information		
Single Version - Order part number 68092		\$1,170.00
Network Version - Order part number 68093		\$1,375.00
Upgrade from Single Version to Network Version - Order part number 68095		\$707.00
Corbin Russwin factory key system formatted for importing to KeyWizard®. For existing systems, see Bitting Lists pricing on page 65. Note: Not available for key systems established prior to 1999. May not be available for systems since 1999. Consult Key Systems Administration for eligibility of system.		\$549.00
<b>Key Systems Administration</b>		
Customer bittings and sample keys 1,2,3,4,5		Add \$16.00 per cylinder <b>(Discount of 50% only)</b>
<p>Notes:</p> <ol style="list-style-type: none"> <li>1. This charge is for keying to customer supplied bittings only.</li> <li>2. All cylinders requested to be keyed to combinations not supplied by Corbin Russwin will be subject to this charge.</li> <li>3. Corbin Russwin releases all liabilities, including key interchange, to systems generated by customer-supplied bittings and/or sample keys that are supplied by others.</li> <li>4. Purchase orders with customer-supplied bittings or sample keys not meeting Corbin Russwin's specifications will be processed 0-bitted in the specified keyway and exempt from upcharge.</li> <li>5. Master keying or CMK charges not included.</li> </ol> <p><b>Disclaimer</b> Corbin Russwin reserves the right to release total liability of any factory generated master key system which incorporates cross keying, both controlled and uncontrolled. A master key system incorporating cross keying yields less security and jeopardizes system expansion.</p>		
Cross Keying		No Charge
<p><b>Controlled Cross Keying:</b> A condition in which two or more different keys of the same level of keying and under the same higher level key(s) operate one cylinder by design; e.g., XAA1 operated by AA2.</p> <p><b>Uncontrolled Cross Keying:</b> A condition in which two or more different keys under different higher-level keys operate one cylinder by design; e.g., XAA1 operated by AB, AB1.</p>		

**Stamping Key Section on Key Blanks**

Key blanks are furnished standard with no key section ID. When so specified, key blanks can be stamped with the key section at no charge. The minimum quantity for this service is a box of 50 key blanks

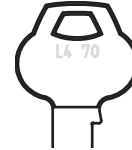

**Standard Bow, Nickel Silver (Order in multiples of 50)**



Coined Logo	Plain Both Sides	DO NOT DUPLICATE	US PROPERTY DO NOT DUPLICATE	RESTRICTED DO NOT DUPLICATE	Price Each		
					Standard Single Section	Restricted Single Section	Standard and Restricted Multi-Section**
(X1, Z1, R)*	(X4, Z4, P)*	(X5, Z5, P5)*	(X6, Z6, P6)*				
xx-5PIN-10	xx-5PIN-11	xx-5PIN-12	xx-5PIN-13	xx-5PIN-19	\$2.20	\$2.35	\$2.50
xx-6PIN-10	xx-6PIN-11	xx-6PIN-12	xx-6PIN-13	xx-6PIN-19			
xx-7PIN-10	xx-7PIN-11	xx-7PIN-12	xx-7PIN-13	xx-7PIN-19	\$2.27	\$2.42	\$2.52

\*(Old Reference)  
 \*\*Multi-section keys enter more than one keyway; eg. D12, H41, 2852, 9812, 59A, 57AD, 067, etc.  
 † Protected keyway keys will be stamped "Restricted"

**Pyramid (Available in quantities of 10, 25, 50 and multiples of 50)**

Standard bow furnished for all Pyramid Keys.

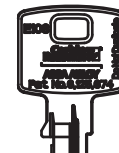

Key Blank Number	Description	Price Each
XX-7PIN-28	Single section	\$7.40
	Multi-section	\$14.00

**Access 3**



Key Blank Number	Description	Price Each
6PIN-38-AP	Standard key blanks for AP cylinders	\$3.90
6PIN-38-AS	Standard key blanks for AS & AHS cylinders	\$7.40

**Security Bow No other shape for security keys. (Order in multiples of 50)**

Not Available for 252, 752, 852, A, N, or X Class keys.

Inactive, for existing systems only.



Coined Logo	Plain Both Sides	DO NOT DUPLICATE	US PROPERTY DO NOT DUPLICATE	RESTRICTED DO NOT DUPLICATE	Price Each
xx-6PIN-90	xx-6PIN-91	xx-6PIN-92	xx-6PIN-93	xx-6PIN-99	\$7.40
xx-7PIN-90 for hotel EMK					\$9.60

**Large Bows (Order in multiples of 50)**

Large Not Available for 252, 752, 852 or A Class keys.



Plain Both Sides	DO NOT DUPLICATE	US PROPERTY DO NOT DUPLICATE	RESTRICTED DO NOT DUPLICATE	Price Each	PROTECTED DO NOT DUPLICATE	Price Each
(Y4 and S)	(Y5 and S5)	(Y6 and S6)				
xx-5PIN-51	xx-5PIN-52	xx-5PIN-53	xx-5PIN-59	\$3.50	xx-5PIN-59	\$5.30
xx-6PIN-51	xx-6PIN-52	xx-6PIN-53	xx-6PIN-59		xx-6PIN-59	
xx-7PIN-51	xx-7PIN-52	xx-7PIN-53	xx-7PIN-59		xx-7PIN-59	

**Emergency Key Blanks for Hotel Function Access 3 Cylinder**

Description	Key Number	Price Each
Emergency key for mortise AP cylinders	6PIN-38-E2-AP	\$5.40
Emergency key for mortise AS & AHS cylinders	6PIN-38-E2-AS	\$7.60
Emergency key for key-in lever AP cylinders	6PIN-38-E6-AP	\$5.40
Emergency key for key-in lever AS & AHS cylinders	6PIN-38-E2-AS	\$7.60

**Emergency Master Key Blanks for Hotel Function Cylinder (Order in multiples of 10)**

Non-IC mortise cylinder use 7PIN blanks, as already listed: xx-7PIN-51 & xx-7PIN-90. (Order in multiples of 50)

Not Available for 252, 752, 852 or A Class keys.



Lockset	EMK Blank	Price Each
IC Mortise	xx-6PIN-51-E1	\$5.40
IC Mortise, Security	xx-6PIN-90-E1	\$7.60
CK4229, including IC; CK4429	xx-6PIN-51-E4	\$5.40
CK4229 Security, Including IC	xx-6PIN-90-E4	\$7.60
CL3329, CL3429, CL3629 6PIN, Including IC	xx-6PIN-51-E8	\$5.40
CL3329, CL3429, CL3629 7PIN, Including IC	xx-7PIN-51-E8	\$5.40
1400/4300 and 5600/3300 Series	xx-6PIN-51-E5	\$6.40

**Mortise Cylinder**

Cylinder Number	Description	Finish: 605, 606, 611, 612, 613, 613E, 618, 619, 622, 625, 626, 629, 630, 722, BSP
CR1500-114	ML2000 Series mortise locks (including electrified and EAC devices)	\$86.00
CR1500-114	DL3000 and DL4100 deadlocks	
CR1500-112	ED5600, ED6600 and ED7600 exit devices	
CR1500-134	All ED5000 cylinder dogging, alarm units, delayed egress cylinders	
CR1501-114-A01	AP Hotel Mortise Cylinder	\$122.00

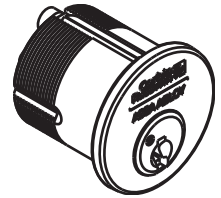

**Rim Cylinder**

Cylinder Number	Description	Finish: 605, 606, 611, 612, 613, 613E, 618, 619, 622, 625, 626, 629, 630, 722, BSP
CR3500-058	5/8" tailpiece	\$86.00
CR3500-138	1-3/8" M61 & M62 option for ED8200 and obsolete ED9200 exit device alarms; ED5202(A) inside cylinder	
CR3500-200	2" tailpiece	
CR3500-200N	2" ED4000/ED5000 night latch function	
CR3500-200V	2" vertical tailpiece	\$88.00
CR3500-312	3-1/2" tailpiece	
CR3500-312V	3-1/2" vertical tailpiece	

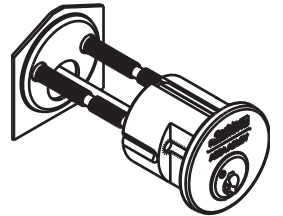

**AP LFIC - Mortise Cylinder**

Cylinder Number	Description	Finish: 605, 606, 611, 612, 613, 613E, 618, 619, 622, 625, 626, 629, 630, 722, BSP
CR1580-114	ML2000 Series mortise locks (including electrified and EAC devices)	\$160.00
CR1580-138	DL3000 and DL4100 deadlocks	\$163.00
CR1580-112	ED5600, ED6600 and ED7600 exit devices	
CR1580-134	All ED5000 cylinder dogging, alarm units, delayed egress cylinders	\$171.00



**AP LFIC - Rim Cylinder**

Cylinder Number	Description	Finish: 605, 606, 611, 612, 613, 613E, 618, 619, 622, 625, 626, 629, 630, 722, BSP
CR3580-058	5/8" tailpiece	\$160.00
CR3580-114	1-1/4" M61 & M62 option for ED8200 and ED9200 exit device alarms	
CR3580-178	1-7/8" tailpiece	
CR3580-178V	1-7/8" vertical tailpiece	
CR3580-318	3-1/8" tailpiece	\$162.00

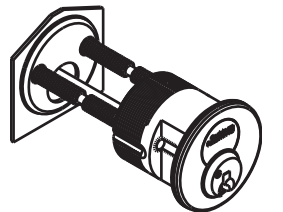

### AP LFIC Core

Cylinder Number	Description	Finish: 605, 606, 611, 612, 613, 613E, 618, 619, 622, 625, 626, 629, 630, 722, BSP
CR8500	All Corbin Russwin LFIC cylinders	\$74.00

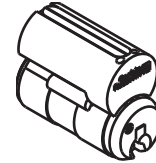

### AP Fixed Core Component Cylinder

Cylinder Number	Description	Finish: 606, 626
CR2500-031	CL3100 Series Vandal Resistant, CK4300 Knob	\$79.00
CR2500-033	CL3300, CL3500, CL3600 (June 2000 and after), CL3800, Lever Trim - A6/N6/PR6	
CR2500-033H	G10 Exit Device Knob Trim	
CR2500-037	CL3700 Lever, CK4700 Knob	
CR2500-039	CL3900	
CR2500-039L	CL3900 Lever (2" and 2-1/4" Thick Door)	
CR2500-044	CK4400	
CR2500-052	CK4200/UT5200	

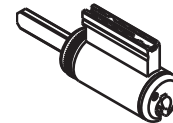

### AP Fixed Core Deadlock Cylinder

Cylinder Number	Description	Finish: 606, 626
CR4500-134-A51	DL2200/DL3200 Series	\$79.00
CR4500-134-A52		
CR4500-214-A52		

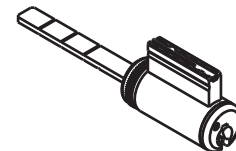

### AP Fixed Core Hotel Cylinder

Cylinder Number	Description	Finish: 606, 626
CR2501-031	CL3100 Series Vandal Resistant	\$93.00
CR2501-034	CL3300	



**AS Fixed Core - Mortise Cylinder**

Cylinder Number	Description	Finish: 605, 606, 611, 612, 613, 613E, 618, 619, 622, 625, 626, 629, 630, 722, BSP
CR1600-114	ML2000 Series mortise locks (including electrified and EAC devices)	\$135.00
CR1600-138	DL3000 and DL4100 deadlocks	
CR1600-112	ED5600, ED6600 and ED7600 exit devices	\$145.00
CR1600-134	All ED5000 cylinder dogging, alarm units, delayed egress cylinders	

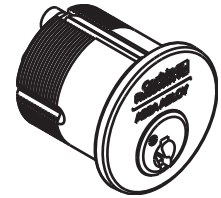

**AS Fixed Core - Rim Cylinder**

Cylinder Number	Description	Finish: 605, 606, 611, 612, 613, 613E, 618, 619, 622, 625, 626, 629, 630, 722, BSP
CR3600-058	5/8" tailpiece	\$135.00
CR3600-138	1-3/8" M61 & M62 option for ED8200 and obsolete ED9200 exit device alarms; ED5202(A) inside cylinder	
CR3600-200	2" tailpiece	
CR3600-200N	2" night latch function	
CR3600-200V	2" vertical tailpiece	
CR3600-312	3-1/2" tailpiece	\$137.00
CR3600-312V	3-1/2" vertical tailpiece	

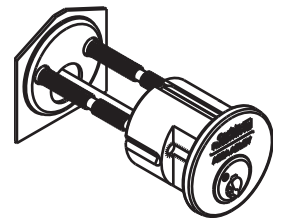

**AS LFIC - Mortise Cylinder**

Cylinder Number	Description	Finish: 605, 606, 611, 612, 613, 613E, 618, 619, 622, 625, 626, 629, 630, 722, BSP
CR1680-114	ML2000 Series mortise locks (including electrified and EAC devices)	\$209.00
CR1680-138	DL3000 and DL4100 deadlocks	\$212.00
CR1680-112	ED5600, ED6600 and ED7600 exit devices	
CR1680-134	All ED5000 cylinder dogging, alarm units, delayed egress cylinders	\$220.00



**AS LFIC - Rim Cylinder**

Cylinder Number	Description	Finish: 605, 606, 611, 612, 613, 613E, 618, 619, 622, 625, 626, 629, 630, 722, BSP
CR3680-058	5/8" tailpiece	\$209.00
CR3680-114	1-1/4" M61 & M62 option for ED8200 and ED9200 exit device alarms	
CR3680-178	1-7/8" tailpiece	
CR3680-178V	1-7/8" vertical tailpiece	
CR3680-318	3-1/8" tailpiece	\$211.00

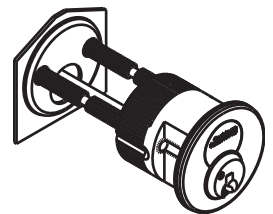

**AS LFIC Core**

Cylinder Number	Description	Finish: 605, 606, 611, 612, 613, 613E, 618, 619, 622, 625, 626, 629, 630, 722, BSP
CR8600	All Corbin Russwin LFIC Cylinders	\$123.00

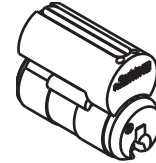

**AS Fixed Core Component Cylinder**

Cylinder Number	Description	Finish: 606, 626
CR2600-031	CL3100 Series Vandal Resistant, CK4300 Knob	\$128.00
CR2600-033	CL3300, CL3500, CL3600 (June 2000 and after), CL3800, Lever Trim - A6/N6/PR6	
CR2600-033H	G10 Exit Device Knob Trim	
CR2600-037	CL3700 Lever, CK4700 Knob	
CR2600-039	CL3900	
CR2600-039L	CL3900 Lever (2" and 2-1/4" Thick Door)	
CR2600-044	CK4400	
CR2600-052	CK4200/UT5200	

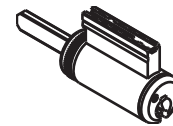

**AS Fixed Core Deadlock Cylinder**

Cylinder Number	Description	Finish: 606, 626
CR4600-134-A51	DL2200/DL3200 Series	\$128.00
CR4600-134-A52		
CR4600-214-A52		

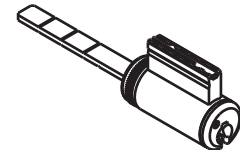

**AS Fixed Core Hotel Cylinder**

Cylinder Number	Description	Finish: 606, 626
CR2601-031	CL3100 Series Vandal Resistant	\$142.00
CR2601-034	CL3300	

### AHS Fixed Core - Mortise Cylinder

Cylinder Number	Description	Finish: 605, 606, 611, 612, 613, 613E, 618, 619, 622, 625, 626, 629, 630, 722, BSP
CR1700-114	ML2000 Series mortise locks (including electrified and EAC devices)	\$155.00
CR1700-138	DL3000 and DL4100 deadlocks	
CR1700-112	ED5600, ED6600 and ED7600 exit devices	\$165.00
CR1700-134	All ED5000 cylinder dogging, alarm units, delayed egress cylinders	

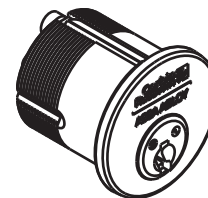

### AHS Fixed Core - Rim Cylinder

Cylinder Number	Description	Finish: 605, 606, 611, 612, 613, 613E, 618, 619, 622, 625, 626, 629, 630, 722, BSP
CR3700-058	5/8" tailpiece	\$155.00
CR3700-138	1-3/8" M61 & M62 option for ED8200 and obsolete ED9200 exit device alarms; ED5202(A) inside cylinder	
CR3700-200	2" tailpiece	
CR3700-200N	2" night latch function	
CR3700-200V	2" vertical tailpiece	\$157.00
CR3700-312	3-1/2" tailpiece	
CR3700-312V	3-1/2" vertical tailpiece	

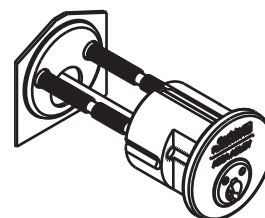

### AHS LFIC - Mortise Cylinder

Cylinder Number	Description	Finish: 605, 606, 611, 612, 613, 613E, 618, 619, 622, 625, 626, 629, 630, 722, BSP
CR1788-114	ML2000 Series mortise locks (including electrified and EAC devices)	\$229.00
CR1788-138	DL3000 and DL4100 deadlocks	\$232.00
CR1788-112	ED5600, ED6600 and ED7600 exit devices	
CR1788-134	All ED5000 cylinder dogging, alarm units, delayed egress cylinders	\$240.00



### AHS LFIC - Rim Cylinder

Cylinder Number	Description	Finish: 605, 606, 611, 612, 613, 613E, 618, 619, 622, 625, 626, 629, 630, 722, BSP
CR3788-058	5/8" tailpiece	\$229.00
CR3788-114	1-1/4" M61 & M62 option for ED8200 and ED9200 exit device alarms	
CR3788-178	1-7/8" tailpiece	
CR3788-178V	1-7/8" vertical tailpiece	
CR3788-318	3-1/8" tailpiece	\$231.00

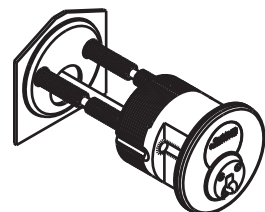

**AHS LFIC Core**

Cylinder Number	Description	Finish: 605, 606, 611, 612, 613, 613E, 618, 619, 622, 625, 626, 629, 630, 722, BSP
CR8700	All Corbin Russwin LFIC cylinders	\$143.00

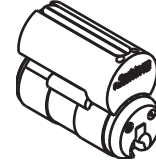
**AHS Fixed Core Component Cylinder**

Cylinder Number	Description	Finish: 606, 626
CR2700-031	CL3100 Series Vandal Resistant, CK4300 Knob	\$148.00
CR2700-033	CL3300, CL3500, CL3600 (June 2000 and after), CL3800, Lever Trim - A6/N6/PR6	
CR2700-033H	G10 Exit Device Knob Trim	
CR2700-037	CL3700 Lever, CK4700 Knob	
CR2700-039	CL3900	
CR2700-039L	CL3900 Lever (2" and 2-1/4" Thick Door)	
CR2700-044	CK4400	
CR2700-052	CK4200/UT5200	

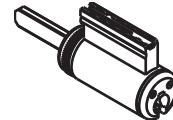
**AHS Fixed Core Hotel Cylinder**

Cylinder Number	Description	Finish: 606, 626
CR2701-031	CL3100 Series Vandal Resistant	\$162.00
CR2701-034	CL3300	

**AHS Fixed Core Deadlock Cylinder**

Cylinder Number	Description	Finish: 606, 626
CR4700-134-A51	DL2200/3200 Series	\$148.00
CR4700-134-A52		
CR4700-214-A52		

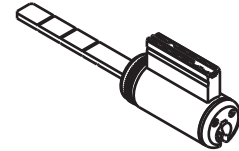
**UL LFIC 6-Pin Mortise Housing**

Cylinder Number	Description	Finish: 605, 606, 611, 612, 613, 613E, 618, 619, 622, 625, 626, 629, 630, 722, BSP
CR1078-114	ML2000 Series mortise locks (including electrified and EAC devices)	\$86.00
CR1078-138	DL3000 and DL4100 deadlocks	\$89.00
CR1078-112	ED5600, ED6600 and ED7600 exit devices	
CR1078-134	All ED5000 cylinder dogging, alarm units, delayed egress cylinders	\$97.00

**UL LFIC 6-Pin Rim Housing**

Cylinder Number	Description	Finish: 605, 606, 611, 612, 613, 613E, 618, 619, 622, 625, 626, 629, 630, 722, BSP
CR3078-058	5/8" tailpiece	\$86.00
CR3078-114	1-1/4" M61 & M62 option for ED8200 and ED9200 exit device alarms	
CR3078-178	1-7/8" tailpiece	
CR3078-178V	1-7/8" vertical tailpiece	
CR3078-318	3-1/8" tailpiece	

**Fixed Core Mortise**

7-Pin - No Cross Keying - Furnished standard with 610502 solid recessed collar unless otherwise indicated.  
High Security UL437 Listed.

**Cylinder Number Example**

To simplify ordering, options designated "standard" may be omitted from the ordering sequence.



Length		Cam		Finish	
114	(1-1/4")	A01	Cloverleaf (standard)	605	622
		A02	Straight	606	625
112	(1-1/2")	A03	Adams Rite® MS	611	626
		A04	DL4000 Deadlock	612	629
		A05	Adams Rite® 4070	613	630
		A06 <sup>2</sup>	Schlage® L9000	613E	722
				618	BSP
		A07	DL4100 Series Deadlock	619	
		A62	Straight		
		A92	Exit Grip O1, O2		
		A93 <sup>1</sup>	For Obsolete Corbin® 610 Series and Russwin®1403 Series Deadlock		
Cylinder No.				Price	
CR1020-114				\$174.00	

Notes: 1. Add \$2.00 per cylinder for A93 cam  
2. Add \$5.00 per cylinder for A06 cam

**Fixed Core Rim**

7-Pin - No Cross Keying - Furnished standard with 422F88 surface mount collar unless otherwise indicated.  
High Security UL437 Listed.

**Cylinder Number Example**

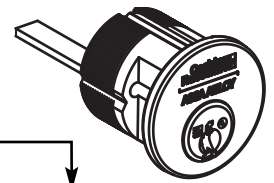
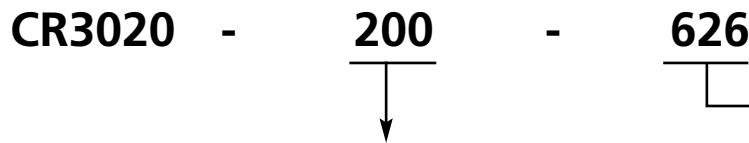

Tailpiece Length	Finish	
058 - 5/8"	605	622
138 - 1-3/8" M61 & M62 option for ED8200 and obsolete ED9200 exit device alarms	606	625
200 - 2"	611	626
	612	629
200N - 2" ED4000/ED5000 Night Latch Function	613	630
200V - 2" vertical	613E	722
312 - 3-1/2"	618	BSP
312V - 3-1/2" vertical	619	
Cylinder Number	Price	
CR3020 - _____	\$174.00	

**Key-In-Lever/Knob**

7-Pin - No Cross Keying

**High Security UL437 Listed**

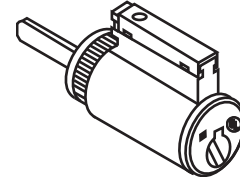

Cylinder Number	Used for	Finish: 606, 626
CR2020-031	CL3100 Lever, CK4300 Knob	\$165.00
CR2020-033	CL3300, CL3500, CL3800 [CL3600 (June 2000 and after)], A6, N6, PR6 Exit device trim	
CR2020-033H	G10 Exit device trim	
CR2020-034	CL3400, [CL3600 (prior to June 2000)], A5, N5 obsolete ED8000 trims	
CR2020-037	CL3700 Lever, CK4700 Knob	
CR2020-038	CL3800 Lever	
CR2020-039	CL3900 Lever	
CR2020-039L	CL3900 Lever (2" - 2-1/4" door)	
CR2020-051	G3 Exit Device Knob Trim	
CR2020-052	CK4200 Knob, UT5200 Knob and Lever	
CR4420-134-A51	DL2200, DL3200 Cylindrical Deadlock	
CR4420-134-A52	DL2200, DL3200 Cylindrical Deadlock	
CR4420-214-A52	DL2200, DL3200 Cylindrical Deadlock	

**Key-In-Lever/Knob**

For Other Manufacturers' Products

**High Security UL437 Listed**

Cylinder Number	Used for	Finish: 606, 626
CR2220-001-P21	Alarm Lock DL2500 Series	\$167.00
	Arrow® H Series Knobs and Levers	
	Arrow Q Series Levers	
	Sargent® 10 line*	
	Schlage® D Series Levers	
CR2220-002-P21	Schlage D Series Knobs	
CR2220-001-P22	Schlage AL and ND Series Levers	
CR2220-002-P22	Schlage A Series Knobs (PLY, etc.)	
CR2220-002-P23	Schlage A Series Knob (ORB only)	

\* When ordered with a 30- prefix, this cylinder is accepted without modification to the lever.

**IC Mortise**

7-Pin - No Cross Keying - Furnished standard with 610F02 solid recessed collar unless otherwise indicated.

**Cylinder Number Example**

To simplify ordering, options designated "standard" may be omitted from the ordering sequence.



**CR1030 - 114 - A01 - 626**



Length		Cam		Finish	
114	1-1/4"	A01	Cloverleaf (standard)	605	622
138	1-3/8"	A02	Straight	606	625
112	1-1/2"	A03	Adams Rite® MS & DL3000	611	626
134	1-3/4"	A04	DL4000 Deadlock	612	629
		A05	Adams Rite® 4070	613	630
		A06 <sup>2</sup>	Schlage® L9000	613E	722
		A07	DL4100 Series Deadlock	618	BSP
		A62	Straight	619	
		A92	Exit Grip 01, 02		
		A93 <sup>1</sup>	For Obsolete Corbin® 610 Series and Russwin® 1403 Series Deadlock		
Cylinder Number				Price	
CR1030-114				\$244.00	

- Notes: 1. Add \$2.00 per cylinder for A93 cam.  
2. Add \$5.00 per cylinder for A06 cam.

**IC Rim**

7-Pin - No Cross Keying - Furnished standard with 422F88 surface mount collar unless indicated.

**Cylinder Number Example**

**CR3030 - 178 - 626**

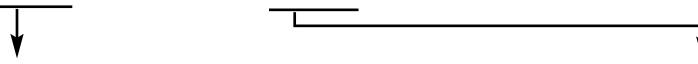
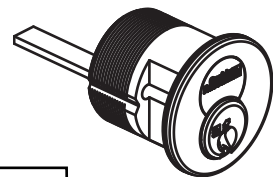

Tailpiece Length	Finish	
058 - 5/8"	605	622
114 - 1-1/4" M61 & M62 option for ED8200 and ED9200 exit device alarms	606	625
178 - 1-7/8"	611	626
178V - 1-7/8" vertical	612	629
318 - 3-1/8"	613	630
	613E	722
	618	BSP
	619	
Cylinder Number	Price	
CR3030-_____	\$244.00	

**Pyramid Core Only**

Cylinder Number	Price
CR8020	\$158.00

Note: For mortise and rim housing only, see page 93.

**Fixed Core Mortise**

7-Pin - No Cross Keying - Furnished standard with 605F43 spring collar unless otherwise indicated.

**Cylinder Number Example**

To simplify ordering, options designated "standard" may be omitted from the ordering sequence.

**CR1027 - 114 - A01 - 626**

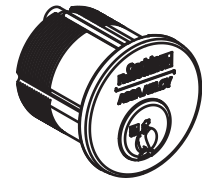

Length		Cam	Finish	
114	(1-1/4")	A01	605	622
		A02	606	625
112	(1-1/2")	A03	611	626
		A04	612	629
		A05	613	630
		A06 <sup>2</sup>	613E	722
		A07	618	BSP
		A62	619	
		A92		
		A93 <sup>1</sup>		
<b>Cylinder Number</b>			<b>Price</b>	
CR1027-114			\$144.00	

- Notes: 1. Add \$2.00 per cylinder for A93 cam.  
2. Add \$5.00 per cylinder for A06 cam.

**Fixed Core Rim**

7-Pin - No Cross Keying - Furnished standard with 422F88 surface mount collar unless otherwise indicated.

**Cylinder Number Example**

**CR3027 - 200 - 626**

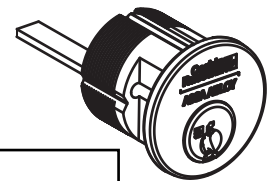

Tailpiece Length	Finish	
058 - 5/8"	605	622
138 - 1-3/8" M61 & M62 option for ED8200 and obsolete ED9200 exit device alarms	606	625
200 - 2"	611	626
200N - 2" ED4000/ED5000 Night Latch Function	612	629
200V - 2" (vertical)	613	630
312 - 3-1/2"	613E	722
312V - 3-1/2" (vertical)	618	BSP
	619	
<b>Cylinder Number</b>		<b>Price</b>
CR3027-_____		\$144.00



**Key-In-Lever/Knob**

7-Pin - No Cross Keying.

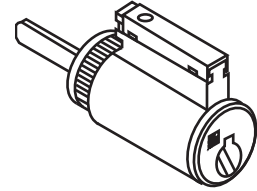

Cylinder Number	Used for	Finish: 606, 626
CR2027-031	CL3100 Lever, CK4300 Knob	\$137.00
CR2027-033	CL3300, CL3500, CL3800 [CL3600 (June 2000 and after)], A6, N6, PR6 Exit Device Trim	
CR2027-033H	G10 Exit device trim	
CR2027-034	CL3400, [CL3600 (before June 2000)], A5, N5 obsolete ED8000 trims	
CR2027-037	CL3700 Lever, CK4700 Knob	
CR2027-038	CL3800 Lever	
CR2027-039	CL3900 Lever	
CR2027-039L	CL3900 Lever (2" - 2-1/4" door)	
CR2027-051	G3 Exit Device Knob Trim	
CR2027-052	CK4200 knob, UT5200 Knob and Lever	
CR4427-134-A51	DL2200, DL3200 Cylindrical Deadlock	
CR4427-134-A52	DL2200, DL3200 Cylindrical Deadlock	
CR4427-214-A52	DL2200, DL3200 Cylindrical Deadlock	

**Key-In-Lever/Knob**

**For Other Manufacturer's Products**

Cylinder Number	Used for	Finish: 606, 626
CR2227-001-P21	Alarm Lock DL2500 Series	\$139.00
	Arrow® H Series Knobs and Levers	
	Arrow Q Series Levers	
	Sargent® 10 line (Enlarge Lever Hole)	
	Schlage® D Series Levers	
CR2227-002-P21	Schlage D Series Knobs	
CR2227-001-P22	Schlage AL and ND Series Levers	
CR2227-002-P22	Schlage A Series Knobs (PLY, etc.)	
CR2227-002-P23	Schlage A Series Knob (ORB only)	

**IC Mortise**

7-Pin - No Cross Keying - Furnished standard with 605F43 spring collar unless otherwise indicated.

**Cylinder Number Example**

To simplify ordering, options designated "standard" may be omitted from the ordering sequence.

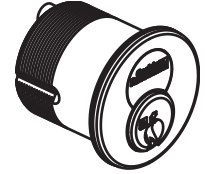

**CR1037 - 114 - A01 - 626**

Length	Cam	Finish	
114 1-1/4"	A01 Cloverleaf (standard)	605	622
138 1-3/8"	A02 Straight	606	625
112 1-1/2"	A03 Adams Rite® MS & DL3000	611	626
134 1-3/4"	A04 DL4000 Deadlock	612	629
	A05 Adams Rite® 4070	613	630
	A06 <sup>2</sup> Schlage® L9000	613E	722
	A07 DL4100 Series Deadlock	618	BSP
	A62 Straight	619	
	A92 Exit Grip 01, 02		
	A93 <sup>1</sup> For Obsolete Corbin® 610 Series and Russwin® 1403 Series Deadlock		
Cylinder Number		Price	
CR1037-114		\$215.00	

- Notes: 1. Add \$2.00 per cylinder for A93 cam.  
2. Add \$5.00 per cylinder for A06 cam.

**IC Rim**

7-Pin - No Cross Keying - Furnished standard with 422F88 surface mount collar unless otherwise indicated.

**Cylinder Number Example**

**CR3037 - 178 - 626**

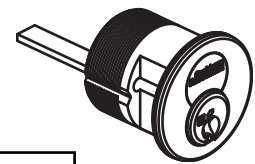

Tailpiece Length	Finish	
058 - 5/8"	605	622
	606	625
114 - 1-1/4" M61 & M62 option for ED8200 and ED9200 exit device alarms	611	626
178 - 1-7/8"	612	629
	613	630
178V - 1-7/8" vertical	613E	722
	618	BSP
318 - 3-1/8"	619	

Cylinder Number	Price
CR3037-_____	\$215.00

**Pyramid Core Only**

Cylinder Number	Price
CR8027	\$129.00

Note: For mortise and rim housing only, see page 93.

**Standard Mortise**

**Cylinder Number Example**

To simplify ordering, options designated "standard" may be omitted from the ordering sequence.

**CR1000 - 118 - A01 - 6 - L4**

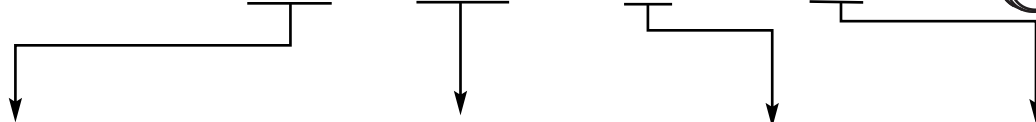
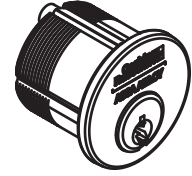

Length	Cam	Pins	Keyway
100 1" (5-pin only)	A01 Cloverleaf (standard)	5	L4
118 1-1/8" (standard)	A02 Straight	6 (standard)	(standard)
114 1-1/4"	A03 Adams Rite® MS	7	
138 1-3/8"	A04 DL4000 Deadlock		
112 1-1/2"	A05 Adams Rite 4070		
134 1-3/4"	A06 <sup>2</sup> Schlage® L9000		
200 2"	A07 DL4100 Series Deadlock		
	A62 Straight		
214 2-1/4"	A92 Exit Grip O1, O2		
212 2-1/2"	A93 <sup>1</sup> For Obsolete		
234 2-3/4"	Corbin® 610 Series and Russwin®		
300 3"	1403 Series Deadlock		
314 3-1/4"			
312 3-1/2"			
334 3-3/4"			

Cylinder Number	Finish: 605, 606, 611, 612, 613, 613E, 618, 619, 622, 625, 626, 629, 630, 722, BSP	
	5- OR 6-PIN	7-PIN
CR1000-100-__-5-Keyway	\$86.00	Not Available
CR1000-118-__-__-Keyway		
CR1000-114-__-__-Keyway		
CR1000-138-__-__-Keyway	\$86.00	\$88.00
CR1000-112-__-__-Keyway		
CR1000-134-__-__-Keyway	\$96.00	\$98.00
CR1000-200-__-__-Keyway		
CR1000-214-__-__-Keyway		
CR1000-212-__-__-Keyway	\$106.00	\$108.00
CR1000-234-__-__-Keyway		
CR1000-300-__-__-Keyway		
CR1000-314-__-__-Keyway	\$116.00	Not Available
CR1000-312-__-__-Keyway		
CR1000-334-__-__-Keyway		

Notes:

1. Add \$2.00 per cylinder for A93 cam.
2. Add \$5.00 per cylinder for A06 cam.

**Flexible Head Mortise**

**Cylinder Number Example**

To simplify ordering, options designated "standard" may be omitted from the ordering sequence.

**CR1100 - 118 - A01 - 6 - L4**



Length	Cam	Pins	Keyway
100 1" (6-pin standard)	A01 Cloverleaf (standard)	5	L4
118 1-1/8"	A02 Straight	6 (standard)	(standard)
114 1-1/4"		7	

Cylinder Number	Finish: 605, 606, 611, 612, 613, 613E, 618, 619, 622, 625, 626, 722, BSP	
	5- OR 6-PIN	7-PIN
CR1100-100-__ - __ - Keyway	\$162.00	Not Available
CR1100-118-__ - __ - Keyway		\$164.00
CR1100-114-__ - __ - Keyway	\$164.00	\$166.00

**Concealed Shell Mortise**

**Cylinder Number Example**

To simplify ordering, options designated "standard" may be omitted from the ordering sequence.

**CR1200 - 118 - A01 - 6 - L4**



Length	Cam	Pins	Keyways
100 1" (5-pin standard)	A01 Cloverleaf (standard)	5	L4
118 1-1/8" (6-pin standard)	A02 Straight	6 (standard)	(standard)
114 1-1/4"		7	
138 1-3/8"			
112 1-1/2"			

Cylinder Number	Finish: 606, 626	
	5- OR 6-PIN	7-PIN
CR1200-100-__ - 5 - Keyway	\$129.00	Not Available
CR1200-118-__ - __ - Keyway		
CR1200-114-__ - __ - Keyway		\$131.00
CR1200-138-__ - __ - Keyway		
CR1200-112-__ - __ - Keyway		

## Special Function Mortise

## Hotel Function\* Cylinders

To simplify ordering, you may specify only the first 4 digits (1001, 1101, 1201).

Cylinder Number	Description	Finish: 605, 606, 611, 612, 613, 613E, 618, 619, 625, 626, 629, 630, 722, BSP
CR1001-114-A01	Standard	\$125.00
CR1101-118-A01	Flex Head	\$149.00
CR1201-114-A01	Concealed Shell	\$139.00

\* Not available with D1, D2, L1, L2, 752, 852 or A class keyways.

## Brink Function Cylinders

Cylinder Number	Description	Finish: 605, 606, 611, 612, 613, 613E, 618, 619, 625, 626, 629, 630, 722, BSP
CR1004-118-A02	Standard Clockwise	\$113.00
CR1005-118-A02	Standard Counter-Clockwise	
CR1004-118-A05	For Brink "CKS" Clockwise	
CR1005-118-A05	For Brink "CKS" Counter - Clockwise	

Note: For Security series, see page 95.

## Cylinder for Discontinued Exit Device

Inside of Corbin® 3726-1/2, 3727-1/2 and Russwin® 736-1/2, 737-1/2

Cylinder Number	Finish: 605, 606, 611, 612, 613, 613E, 618, 619, 625, 626, 629, 630, 722, BSP
CR1006-118-A02	\$105.00

## Non-Keyed Mortise

## Thumbturn Cylinders

Cylinder Number	Description	Finish: 605, 606, 611, 612, 613, 613E, 618, 619, 625, 626, 629, 630, 722, BSP
CR1300-100-A02	Standard*	\$86.00
CR1300-118-A02		
CR1300-114-A02	Standard*	\$90.00
CR1300-138-A02		
CR1300-100-A03	Standard*	\$86.00
CR1300-118-A03		
CR1300-114-A03	Standard*	\$90.00
CR1300-138-A03		
CR1300-118-A93	Standard*	\$88.00
CR1303-100-A03	Classroom*	
CR1303-118-A03		Classroom*
CR1303-114-A03		
CR1303-138-A03		

## Dummy Cylinders

Cylinder Number	Finish: 605, 606, 611, 612, 613, 613E, 618, 619, 625, 626, 629, 630, 722, BSP
CR1400-118	\$73.00
CR1400-114	\$77.00
CR1400-138	\$81.00

## Rim Thumbturn Cylinders

Cylinder Number	Finish: 605, 606, 611, 612, 613, 613E, 618, 619, 625, 626, 629, 630, 722, BSP
CR3300 -138	\$81.00
CR3300-138-M34	\$96.00
CR3300-200	\$81.00
CR3300-200-M34	\$96.00

\* All CR1300 and CR1303 are available with M34 Ergonomic Thumbturn.

**Rim (.552 dia. Plug)**

**Cylinder Number Example**

To simplify ordering, options designated "standard" may be omitted from the ordering sequence.

**CR3000 - 200 - 6 - L4**

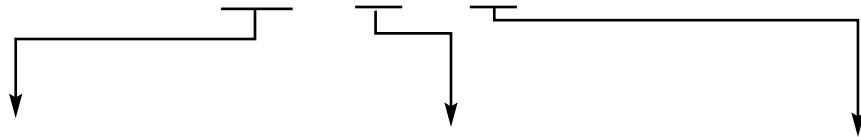
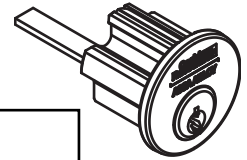

Tailpiece Length		Pins	Keyway
058	5/8"	5	L4 (Standard)
138	1-3/8" M61 & M62 option for ED8200 and obsolete ED9200 Exit Device Alarms	6 (Standard)	See page 61 for pricing of options.
200	2" (Standard)	7	
200N	2" ED4000/ED5000 Night Latch Function		
200V	2" Vertical		
312	3-1/2" (Thick door)		
312	3-1/2" (Thick door) Vertical		

Cylinder No.	Finish: 605, 606, 611, 612, 613, 613E, 618, 619, 622, 625, 626, 629, 630, 722, BSP	
	5- OR 6-PIN	7-PIN
CR3000-058      __- Keyway	\$86.00	\$88.00
CR3000-138      __- Keyway		
CR3000-200-      __- Keyway		
CR3000-200N-    __- Keyway		
CR3000-200V-    __- Keyway		
CR3000-312-      __- Keyway	\$88.00	\$90.00
CR3000-312V-    __- Keyway		

**Key-In-Lever/Knob (.509" plug)**

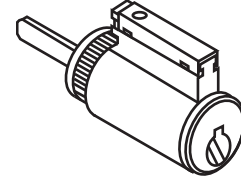

Cylinder Number		Finish: 606, 626		
		Series	6-PIN	7-PIN <sup>4</sup>
CR2000-031	Standard	CL3100, CK4300	\$79.00	\$81.00
CR2001-031 <sup>1</sup>	Hotel	CL3100	\$93.00	\$95.00
CR2400-031-C <sup>2</sup>	Schlage® C Keyway	CL3100	\$79.00	Not Available
CR2400-031-LA <sup>3</sup>	Sargent® LA Keyway	CL3100		
CR2000-033	Standard	CL3300, CL3500, CL3600, CL3800 <sup>B</sup>		\$81.00
CR2000-038	Standard	CL3800 <sup>A</sup>		
CR2001-034 <sup>1</sup>	Hotel	CL3300	\$93.00	\$95.00
CR2400-033-C <sup>2</sup>	Schlage® C keyway	CL3300, CL3500, CL3600, CL3800 <sup>B</sup>	\$79.00	Not Available
CR2400-033-LA <sup>3</sup>	Sargent® LA keyway			
CR2000-037	Standard	CL3700, CK4700		
CR2400-037-C <sup>2</sup>	Schlage® C keyway			
CR2400-037-LA	Sargent® LA keyway			
CR2000-039	Standard	CL3900	\$79.00	Not Available
CR2000-039L	2" to 2-1/4" Door			
CR2400-039-C <sup>2</sup>	Schlage® C keyway			
CR2400-039-LA <sup>3</sup>	Sargent® LA keyway			
CR2000-034	Standard	CL3400, CL3600 (Prior to June 2000)	\$79.00	\$81.00
CR2001-034 <sup>1</sup>	Hotel		\$93.00	\$95.00
CR2400-034-C <sup>2</sup>	Schlage® C keyway		\$79.00	Not Available
CR2400-034-LA <sup>3</sup>	Sargent® LA keyway			

Notes:

- 1. Not available in 752, 852 or A Class keyways.
- 2. Available 0-bitted & keyed random only.
- 3. Available 0-bitted only.
- 4. For 7-pin version suffix "-7" to number. Not available in 752, 852 or A Class keyways.
- A. CL3800 manf. 1993-1997
- B. CL3800 manf. 2006 -

**Cylindrical Deadlocks DL2200, DL3200 Series**

Cylinder Number		Door Thickness	Function	Finish: 606, 626 Price
CR4400-134-A51	6-Pin Conventional	All	11, 13, 17	\$79.00
CR4400-134-A52	6-Pin Conventional	1-3/8" to 1-3/4"	12	
CR4400-214-A52	6-Pin Conventional	2" to 2-1/4"	12	
CR4400-134-A51-7	7-Pin Conventional	All	11, 13, 17	\$81.00
CR4400-134-A52-7	7-Pin Conventional	1-3/8" to 1-3/4"	12	
CR4400-214-A52-7	7-Pin Conventional	2" to 2-1/4"	12	



**Key-In-Lever/Knob**
**For UT5200 & CK4200 Series Locksets (.552" dia plug)**

Cylinder Number	Description	Finish: 606, 626
CR2000-052	Standard	\$79.00
CR2001-052*	Hotel with Indicator	\$93.00
CR2100-052**	Discontinued Ronde & Continental Knob	\$93.00

**For CK4400 Series Locksets (.509" dia plug)**

Cylinder Number	Description	Finish: 606, 626
CR2000-044	All except below	\$79.00
CR2003-044	CK4455 & CK4482 before 8/93	
CR2001-044*	CK4429 with Indicator Pin New Style Straight Tailpiece	\$93.00
CR2001-066*	CK4429 with Indicator Pin Old Style Twisted Tailpiece	

**For G10 Exit Device Knob Trim**

Cylinder Number	Description	Finish: 606, 626
CR2000-033H	Standard	\$79.00

\* Not available with 752, 852 or A Class keyways.

\*\* Also available in 605, 611, 612, 613, 625 finishes. Not available with X Class keyways.

**For PL5000 Series Rekeyable Fixed Core Padlocks**

Cylinder Number	Description	Finish: 606, 626
CR2300	Standard 6-pin	\$79.00

**For B2, G2, G3 Exit Device Trim**

Cylinder Number	Description	Finish: 606, 626
CR2000-051	Standard 6-pin	\$79.00

## Key-In-Lever/Knob (.552 dia Plug)

For Other Manufacturers' Products

Cylinder Number	Description	Finish: 606, 626
CR2200-001-A21	Alarm Lock DL2500 Series	\$83.00
	Arrow® H Series Knobs and Levers	
	Arrow Q Series Levers	
	Sargent® 10 line*	
	Schlage® D Series Levers	
CR2200-001-A22	Schlage AL and ND Series Levers	
CR2200-002-A21	Schlage D Series Knobs	
CR2200-002-A23	Schlage A Series Knobs (ORB only)	
CR2200-002-A22	Schlage A Series Knobs (PLY, etc.)	
CR2200-003-A24	Lockwood® H Series Knobs (Enlarge Knob Hole)	
	CR2200-008	
CR2200-054	Yale® 5400, 6200 Knobs Only (Enlarge Knob Hole)	
CR2200-076	Sargent 7600 Integrallock	

\* When ordered with a 30- prefix, this cylinder is accepted without modification to the lever.

## For Adams Rite® 4025 Pull (.552" dia. Plug)

Cylinder Number	Description	Finish: 606, 626
CR4200-003-A47	Cylinder & Housing	\$135.00
CR4200-002-A47	Cylinder Only	\$79.00

**IC Mortise**

For Construction Core Program, see page 63.  
For housing only, see page 93.

**Cylinder Number Example**

To simplify ordering, options designated "standard" may be omitted from the ordering sequence.

**CR1080 - 114 - A01 - 6 - L4**

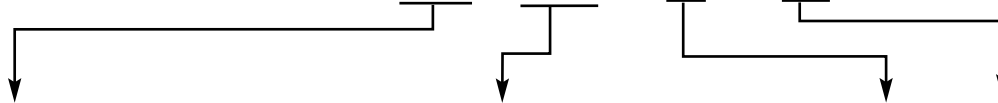
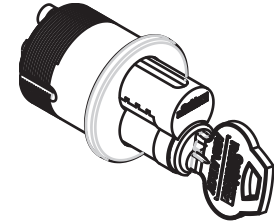

Length	Cam	Pins	Keyway
114 1-1/4" (6-pin standard)	A01 Cloverleaf (standard)	6 (standard)	L4 (standard)
138 1-3/8"	A02 Straight	7**	See page 61 for pricing of options.
112 1-1/2"	A03 Adams Rite® MS & DL300		
134 1-3/4"	A04 DL4000 Deadlock		
200 2"	A05 Adams Rite 4070		
214 2-1/4"	A06 <sup>2</sup> Schlage® L9000		
212 2-1/2"	A07 DL4100 Series Deadlock		
234 2-3/4"	A62 Straight		
	A92 Exit Group 01, 02		
	A93 <sup>1</sup> For obsolete Corbin® 610 Series and Russwin® 1403 Series Deadlocks		

Cylinder Number	Finish: 605, 606, 611, 612, 613, 613E, 618, 619, 622, 625, 626, 629, 630, 722, BSP	
	6- PIN	7-PIN
CR1080-114-	\$160.00	Not Available
CR1080-138-	\$163.00	Not Available
CR1080-112-__	\$163.00	\$167.00
CR1080-134-__	\$171.00	\$175.00
CR1080-200-	\$177.00	\$181.00
CR1080-214-	\$183.00	\$187.00
CR1080-212-	\$189.00	\$193.00
CR1080-234-	\$193.00	\$197.00

Notes:

1. Add \$2.00 per cylinder for A93 Cam.
2. Add \$5.00 per cylinder for A06 Cam.

**Hotel Function IC Mortise**

To simplify ordering, options designated "standard" may be omitted from the ordering sequence.

Cylinder Number	Finish: 605, 606, 611, 612, 613, 613E, 618, 619, 622, 625, 626, 629, 630, 722, BSP	
	6-PIN	7-PIN
CR1081-138-A01-6** (Hotel function uses E1-suffix EMK blank)	\$174.00	Not Available

- \*\* Not available with 752, 852 or A Class keyways.
- \*\* Only available in 1-1/2" and 1-3/4" length.

**IC Rim**

For Construction Core Program, see page 63.  
For housing only, see page 93.

**Cylinder Number Example**

To simplify ordering, options designated "standard" may be omitted from the ordering sequence.

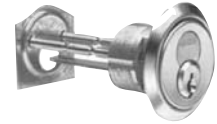

**CR3080 - 178 - 6 - L4**

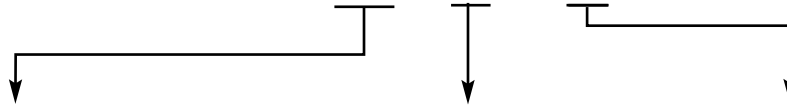

Tailpiece Length		Pins	Keyway
058	5/8" Tailpiece	6 Pin (standard)	L4 (standard)
178	1-7/8" (standard)	7 Pin	See page 61 for pricing of options
178V	1-7/8" Vertical		
318	3-1/8" (Thick door)		
114	1-1/4" M61 & M62 option for ED8200 and obsolete ED9200 exit device alarms		

Cylinder Number	Finish: 605, 606, 611, 612, 613, 613E, 618, 619, 622, 625, 626, 629, 630, 722, BSP	
	6 PIN	7 PIN
CR3080-058-	\$160.00	\$164.00
CR3080-178-__		
CR3080-178V-__		
CR3080-318-__	\$162.00	\$166.00
CR3080-114-__ (no back plate or screw)	\$162.00	\$166.00

**Core Only**



Cylinder Number (specify keyway)	Finish: 626, 606
CR8000 6-Pin Standard	\$74.00
CR8000EMK* 6-Pin Standard set to hotel mortise EMK	
CR8000-7 7-Pin	\$76.00
CR8001-034* 6-Pin for CL3329, hotel indicator pin	\$90.00
CR8001-034-7* 7-Pin for CL3329, hotel indicator pin	\$92.00
CR8001-042* 6-Pin for CK4229, hotel indicator pin	\$90.00

\* Not available with 752, 852 or A Class keyways.  
Note: For uncombined cores suffix "UC". See page 48 for deduct.

**LFIC Mortise Housing Only**

**Housing Number Example**

To simplify ordering, options designated "standard" may be omitted from the ordering sequence.



**CR1070 - 114 - A01 - 6**



Length	Cam		Pins
114 1-1/4" (6-pin standard)	A01	Cloverleaf (standard)	6 (standard)
138 1-3/8"	A02	Straight	7
112 1-1/2"	A03	Adams Rite® MS	
134 1-3/4"	A04	DL4000 Deadlock	
214 2-1/4"	A05	Adams Rite® 4070	
	A06 <sup>2</sup>	Schlage® L9000	
	A07	DL4100 Series Deadlock	
	A62	Straight	
	A92	Exit Group 01, 02	
	A93 <sup>1</sup>	For obsolete Corbin® 610 Series and Russwin® 1403 Series Deadlocks	

Cylinder Number	Finish: 605, 606, 611, 612, 613, 613E, 618, 619, 622, 625, 626, 629, 630, 722, BSP	
	6 PIN	7 PIN
CR1070-114-	\$86.00	Not Available
CR1070-138-	\$89.00	
CR1070-112-__-	\$89.00	\$91.00
CR1070-134-__-	\$97.00	\$99.00
CR1070-214-	\$103.00	Not Available
CR1071-138-A01 (Hotel function uses -E1 suffix EMK blank)	\$179.00	

**Notes:**

To simplify ordering, you may specify only "1071" since no length or cam variations exists.

1. Add \$2.00 per cylinder for A93 Cam.
2. Add \$5.00 per cylinder for A06 Cam.

**LFIC Rim Housing Only**

**CR3070 - 058 - 626**

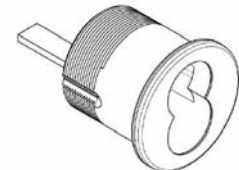
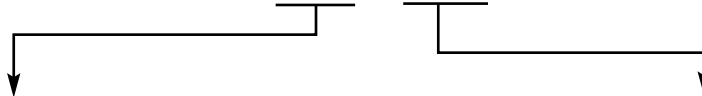

Cylinder Number	Finish : 605, 606, 611, 612, 613, 613E, 618, 619, 622, 625, 626, 629, 630, 722, BSP	
	6 PIN	7 PIN
CR3070-058- 5/8" tailpiece	\$86.00	\$88.00
CR3070-178-__ 1-7/8" tailpiece (standard)		
CR3070-178V-__ 1-7/8" vertical		
CR3070-318-__ 3-1/8" tailpiece (thick door)	\$88.00	\$90.00
CR3070-114-__ 1-1/4" tailpiece for M61, M62 exit alarm options. No back plate or screws.		

**SFIC Mortise Housing Only**

**Cylinder Number Example**

**CR1040 - 114 - A01 - 6**



Length	Cam	Pins
114 1-1/4" (6-pin standard)	A01 Cloverleaf (standard)	6 (standard)
	A02 Straight	
	A03 Adams Rite® MS	
	A04 DL4000 Series Deadlock	
	A05 Adams Rite 4070	
	A06 Schlage® L9000	
	A07 DL4100 Series	
	A62 MR Straight	
	A93 Obsolete Deadlocks Corbin® 610 Series and Russwin® 1403 Series	
138 1-3/8" (7-pin standard) 112 1-1/2" (7-pin standard) 134 1-3/4" (7-pin standard)	A01 Cloverleaf (standard)	7
	A02 Straight	
	A03 Adams Rite® MS	
	A04 DL4000 Series Deadlock	
	A05 Adams Rite 4070	
	A06 Schlage® L9000	
	A07 DL4100 Series	
	A62 MR Straight	
	A93 Obsolete Deadlocks Corbin® 610 Series and Russwin® 1403 Series	

Cylinder Number	Finish: 605, 606, 611, 612, 613, 613E, 618, 619, 622, 625, 626, 629, 630, 722, BSP	
	6 PIN	7 PIN
CR1040-114-__	\$86.00	Not Available
CR1040-138-__	\$89.00	\$91.00
CR1040-112-__	\$89.00	\$91.00
CR1040-134-__	\$97.00	\$99.00

**SFIC Rim Housing Only**

**CR3040 - 058 - 626**



Cylinder Number		Finish : 605, 606, 611, 612, 613, 613E, 618, 619, 622, 625, 626, 629, 630, 722, BSP	
		6 PIN	7 PIN
CR3040-058-	5/8" tailpiece	\$86.00	\$88.00
CR3040-178-__	1-7/8" tailpiece	\$86.00	\$88.00
CR3040-318-__	3-1/8" tailpiece	\$88.00	\$90.00

**Standard Security Mortise**

For Existing Systems Only.\*  
For uncombined cylinders, suffix "UC".  
See page 48 for deduct.

6-Pin Only - No Cross Keying - Available in Z and DH Class Keyways only.  
Available UC or master keyed only.  
Not available KR or 0-bitted.

\* L4, D1 and 60 keyway sections may be ordered Keyed Random only, without prior Key Systems Administration approval

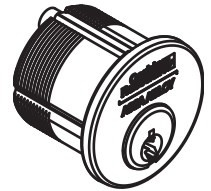

**Cylinder Number Example**

To simplify ordering, options designated "standard" may be omitted from the ordering sequence.

**CR1010 - 118 - A01 - L4**

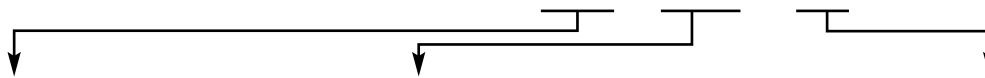

Length		Cam		Keyway
118	1-1/8" (standard)	A01	Cloverleaf (standard)	L4 (standard)
114	1-1/4"	A02	Straight	Available only with Z and DH Class keyways. See page 61 for pricing of options.
138	1-3/8"	A03	Adams Rite® MS & DL3000	
112	1-1/2"	A04	DL4000 Deadlock	
134	1-3/4"	A05	Adams Rite 4070	
200	2"	A06 <sup>2</sup>	Schlage® L9000	
214	2-1/4"	A07	DL4100 Series Deadlock	
		A62	Straight	
		A92	Exit Grip 01, 02	
212	2-1/2"	A93 <sup>1</sup>	For obsolete Corbin® 610 Series and Russwin® 1403 Series Deadlocks	
234	2-3/4"			

Cylinder Number	Finish: 605, 606, 611, 612, 613, 613E, 618, 619, 622, 625, 626, 629, 630, 722, BSP
CR1010-118-__	\$197.00
CR1010-114-__	
CR1010-138-__	\$205.00
CR1010-112-__	\$227.00
CR1010-134-__	\$237.00
CR1010-200-__	\$243.00
CR1010-214-__	\$249.00
CR1010-212-__	\$257.00
CR1010-234-__	\$261.00

Notes:

1. Add \$2.00 per cylinder for A93 Cam.
2. Add \$5.00 per cylinder for A06 Cam.

## Special Function Security Mortise

For Existing Systems Only.\*  
 6-Pin Only - No Cross Keying - Available in Z and DH Class Keyways only.  
 Available UC or master keyed only.  
 Not available KR or 0-bitted.  
 \* L4, D1 and 60 keyway sections may be ordered Keyed Random only, without prior Key Systems Administration approval

## Hotel Function Cylinders

Cylinder Number	Description	Finish: 605, 606, 611, 612, 613, 613E, 618, 619, 622, 625, 626, 629, 630, 722, BSP
CR1011-114-A01	1-1/4" Cloverleaf cam only	\$215.00

To simplify ordering, you may specify only "1011" since no length or cam variations exist.  
 For uncombined cylinders, suffix "UC". See page 48 for deduct.  
 Not available in D1, D2, L1 or L2 keyways.

## Blockout Function Cylinders

Cylinder Number	Description	Finish: 605, 606, 611, 612, 613, 613E, 618, 619, 622, 625, 626, 629, 630, 722, BSP
CR1012-114-A01	Cloverleaf	\$208.00
CR1012-114-A02	Straight	
CR1012-114-A03	DL3000 Series, Adams Rite® MS	
CR1012-114-A04	DL4000 Series Deadlock	
CR1012-114-A07	DL4100 Series Deadlock	
CR1012-114-A05	Adams Rite 4070	
CR1012-114-A93	Obsolete Corbin® 610 Series and Russwin® 1403 Series Deadlock	\$210.00

## Brink Function Cylinders

Cylinder Number	Description	Finish: 605, 606, 611, 612, 613, 613E, 618, 619, 622, 625, 626, 629, 630, 722, BSP
CR1014-118-A02	Standard Clockwise	\$201.00
CR1015-118-A02	Standard Counterclockwise	
CR1014-118-A05	For Brink "CKS" Clockwise	
CR1015-118-A05	For Brink "CKS" Counterclockwise	



**Security Rim**

For Existing Systems Only.\*

6-Pin Only - No Cross Keying - Available in Z and DH Class Keyways Only.  
Available UC or master keyed only. Not available KR or 0-bitted.

\* L4, D1 and 60 keyway sections may be ordered Keyed Random only, without prior Key Systems Administration approval

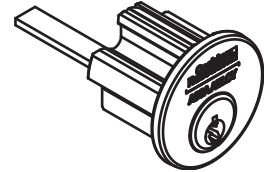

**Cylinder Number Example**

To simplify ordering, options designated "standard" may be omitted from the ordering sequence.

**CR3010 - 200 - L4**

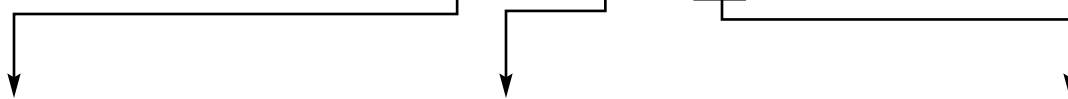

Function	Tailpiece Length	Keyway
<b>For 3010 Only:</b>	<b>For 3010 Only:</b>	L4 (standard) Available only with Z and DH Class keyways. See page 61 for pricing of options.
0 (standard)	200 2" (standard)	
2 Blockout	200V 2" vertical	
	312 3-1/2" (thick door)	
	312V 3-1/2" (thick door) vertical	
	058 5/8" Tailpiece	
	138 1-3/8" M61 and M62 option for ED8200 . . . . . and obsolete ED9200 exit device alarms	
	<b>For 3012 Only:</b>	
	178 1-7/8" (standard)	
	178V 1-7/8" vertical	
	318 3-1/8" (thick door)	
	318V 3-1/8" (thick door) vertical	

Cylinder Number	Finish: 605, 606, 611, 612, 613, 613E, 618, 619, 622, 625, 626, 629, 630, 722, BSP
CR3010-058-__	\$197.00
CR3010-200-__	
CR3010-200V-__	
CR3010-312-__	\$199.00
CR3010-312V-__	
CR3010-138-__ No back plate or screws	\$197.00
CR3012-178-__	\$205.00
CR3012-178V-__	
CR3012-318-__	\$207.00
CR3012-318V-__	

**Security Key-In-Lever/Knob**

For Existing Systems Only.\*  
6-Pin Only - No Cross Keying - Available in Z and DH Class Keyways Only.  
Available UC or master keyed only. Not available KR or 0-bitted.

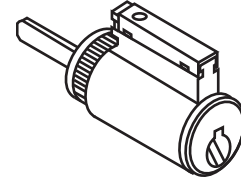

\* L4, D1 and 60 keyway sections may be ordered Keyed Random only, without prior Key Systems Administration approval

**For Key-In-Lever/Knob Trim (.552" plug)**

Cylinder Number	Series	Finish: 606, 626
2010-031	CL3100, CK4300	\$188.00
2010-033	CL3300, CL3500, CL3800*, [CL3600 (June 2000 and after)]	
2010-034	CL3400, [CL3600 (prior to June 2000)]	
2010-038	CL3800 <sup>A</sup>	
2010-039	CL3900	
2010-039L	CL3900 ( 2 - 2-1/4" door)	
2010-052	CK4200, UT5200	
2011-042	CK4229 Hotel Function*	\$202.00
2010-051	B2, G2 Exit Device Knob Trim	\$188.00
4410-134-A51	DL2200, DL3200 Cylindrical Deadlock	\$188.00
4410-134-A52	DL2200, DL3200 Cylindrical Deadlock	\$188.00
4410-214-A52	DL2200, DL3200 Cylindrical Deadlock	\$188.00

For uncombined cylinders suffix "UC" - See page 48 for deduct.  
\*Not available with 752, 852, or A Class Keyways.

Notes: A CL3800 manf. 1993-1997  
B CL3800 manf. 2006 -

**For Other Manufacturers' Products (.552" plug)**

Cylinder Number	Series	Finish: 606, 626
2210-001-A21	Alarm Lock DL2500 Series	\$192.00
	Arrow® H Series Knobs and Levers	
	Arrow Q Series Levers	
	Sargent® 10 line*	
	Schlage® D Series Levers	
2210-001-A22	Schlage AL and ND Series Levers	
2210-002-A21	Schlage D Series Knobs	
2210-002-A23	Schlage A Series Knobs (ORB, only)	
2210-002-A22	Schlage A Series Knobs (PLY, ect)	
2210-003-A24	Lockwood® H Series Knobs (enlarge knob hole)	
2210-008	Sargent 7, 8, 9 Line (enlarge knob hole)	
2210-054	Yale® 5400, 6200 Knobs only (enlarge knob hole)	

\* When ordered with a 30- prefix, this cylinder is accepted without modification to the lever.

**IC Mortise**

For Existing Systems Only.\*  
For Construction Core Program, see page 63. For housing only, see page 93.

6-Pin Only - No Cross Keying - Available in Z and DH Class Keyways Only.  
Available UC or master keyed only. Not available KR or 0-bitted.

\* L4, D1 and 60 keyway sections may be ordered Keyed Random only, without prior Key Systems Administration approval

**Cylinder Number Example**

To simplify ordering, options designated "standard" may be omitted from the ordering sequence.

**CR1090 - 114 - A01- L4**

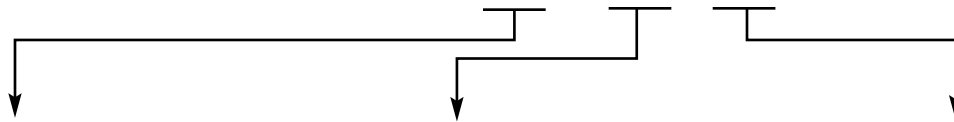
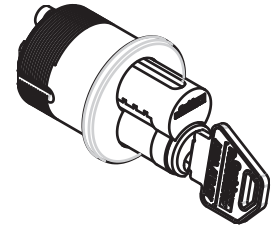

Length	Cam	Keyway
114 1-1/4" (standard)	A01 Cloverleaf (standard)	L4 (standard) Available only with Z and DH Class keyways. See page 61 for pricing of options.
138 1-3/8"	A02 Straight	
112 1-3/8"	A03 Adams Rite® MS & DL3000	
134 1-3/4"	A04 DL4000 Deadlock	
	A05 Adams Rite 4070	
	A06 <sup>2</sup> Schlage® L9000	
	A07 DL4100 Series Deadlock	
	A62 Straight	
	A92 Exit Grip 01, 02	
	A93 <sup>1</sup> For obsolete Corbin® 610 Series and Russwin® 1403 Series Deadlocks	

Cylinder Number	Finish: 605, 606, 611, 612, 613, 613E, 618, 619, 622, 625, 626, 629, 630, 722, BSP
CR1090-114-	\$269.00
CR1090-138-	\$272.00
CR1090-112-	
CR1090-134-	\$280.00

- Notes:  
1. Add \$2.00 per cylinder for A93 Cam.  
2. Add \$5.00 per cylinder for A06 Cam.

**Hotel Function IC Mortise**

Cylinder Number	Finish: 605, 606, 611, 612, 613, 613E, 618, 619, 622, 625, 626, 629, 630, 722, BSP
CR1091-138-A01 Hotel function uses - E1 suffix EMK blank	\$283.00

To simplify ordering, you may specify only "1091" since no length or cam variations exist.

**IC Rim**

For Existing Systems Only.\*  
 For Construction Core Program, see page 63.  
 For housing only, see page 93.  
 6-Pin Only - No Cross Keying - Available in Z and DH Class Keyways Only. Available UC or master keyed only. Not available 0-bitted.  
 \* L4, D1 and 60 keyway sections may be ordered Keyed Random only, without prior Key Systems Administration approval

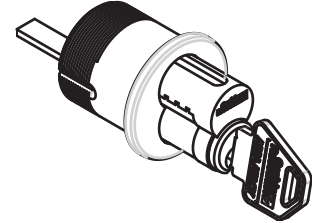

**Cylinder Number Example**

To simplify ordering, options designated "standard" may be omitted from the ordering sequence.

**CR3090 - 178 - L4**

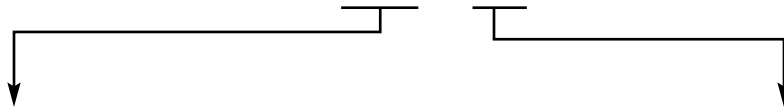

Tailpiece Length		Keyway
058	5/8" Tailpiece	L4 (standard). Available only with Z and DH Class keyways. See page 61 for pricing of options.
178	1-7/8" (standard)	
178V	1-7/8" (standard) vertical	
318	3-1/8" (thick door)	
114	1-1/4" for M61 and M62 option alarmed exit devices	

Cylinder Number	Finish: 605, 606, 611, 612, 613, 613E, 618, 619, 622, 625, 626, 629, 630, 722, BSP
CR3090-058	\$269.00
CR3090-178	
CR3090-178V	
CR3090-318	\$271.00
CR3090-114 No back plate or screws	\$271.00

**Security Core Only**

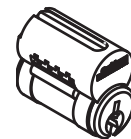

Cylinder Number	Finish: 605, 606, 611, 612, 613, 613E, 618, 619, 622, 625, 626, 722, BSP
CR8010 6-pin standard	\$183.00
CR8010EMK 6-pin standard set to hotel mortise EMK	
CR8011-042 6-pin for CK4229, hotel indicator pin	\$197.00

For uncombined cores, suffix "UC," see page 48 for deduct.

**Standard Master Ring Mortise**

**Cylinder Number Example**

To simplify ordering, options designated "standard" may be omitted from the ordering sequence.

**CR1060 - 118 - A61 - 6 - L4**

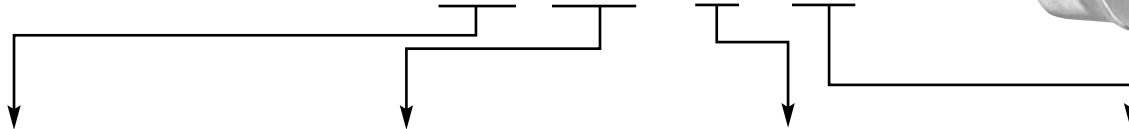

Length	Cam	Pins	Keyway
100 1" (5-pin only)	A61 New Cloverleaf (standard) (for locks made after 5/93; requires thumbturn hub 562F41-2)	5	L4 (standard) See page 61 for pricing of options.
118 1-1/8" (std)	A62 Straight	6 (standard)	
114 1-1/4"	A63* Large Short	7 (optional for 1-3/8" only)	
138 1-3/8"	A64* Large Long		
134 1-3/4"	A65* Old Cloverleaf (formerly 11A)		
112 1-1/2"			
200 2"			
214 2-1/4"			
212 2-1/2"			
234 2-3/4"			
300 3"			

Cylinder Number	Finish: 605, 606, 611, 612, 613, 613E, 618, 619, 622, 625, 626, 722, BSP
CR1060-100-__-5	\$133.00
CR1060-118-__-__	
CR1060-114-__-__	
CR1060-138-__-__	\$143.00
CR1060-112-__-__	
CR1060-134-__-__	
CR1060-200-__-__	\$153.00
CR1060-214-__-__	
CR1060-212-__-__	
CR1060-234-__-__	\$153.00
CR1060-300-__-__	

\*Add \$2.00 per cylinder for A63, A64 and A65 Cam.

**Flexible Head Master Ring Mortise**

**Cylinder Number Example**

To simplify ordering, options designated "standard" may be omitted from the ordering sequence.

**CR1160 - 118 - A61 - 6 - L4**

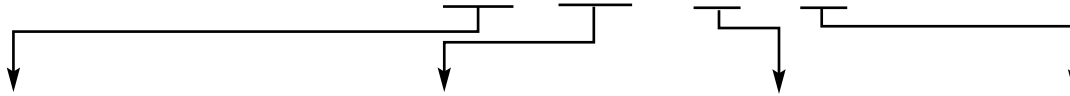

Length	Cam	Pins	Keyway
100 1" (6-pin std)	A61 New Cloverleaf (standard) (for locks made after 5/93; requires thumbturn hub 562F41-2)	5	L4 (standard) See page 61 for pricing of options.
118 1-1/8"		6 (standard)	
114 1-1/4"	A62 Straight		
	A63* Large Short		
	A64* Large Long		
	A65* Old Cloverleaf (formerly 11A)		

Cylinder Number	Finish: 605, 606, 611, 612, 613, 613E, 618, 619, 622, 625, 626, 722, BSP
CR1160-100-__-__	\$171.00
CR1160-118-__-__	
CR1160-114-__-__	

\* Add \$2.00 per cylinder for A63, A64 or A65 Cam.

**Dummy Master Ring Mortise Cylinders**

Cylinder Number	Finish: 605, 606, 611, 612, 613, 613E, 618, 619, 622, 625, 626, 722, BSP
CR1460-118	\$125.00
CR1460-114	
CR1460-138	
CR1460-112	

<b>Master Ring Rim</b>
------------------------

Cylinder Number (Specify Keyway)	Finish: 605, 606, 611, 612, 613, 613E, 618, 619, 622, 625, 626, 722, BSP
CR3060-200      Standard horizontal tailpiece	\$133.00
CR3060-312      Thick door, horizontal tailpiece	
CR3060-200V      Vertical tailpiece	
CR3060-312V      Thick door, vertical tailpiece	

<b>For CK4200 &amp; UT5200 Series Locksets (.552" dia. plug)</b>
--

Cylinder Number	Finish: 606, 626
CR2060-052      Standard	\$112.00
CR2061-042*      CK4229 Hotel with indicator pin	\$138.00
CR2160-052**      Discontinued Ronde and Continental Knob	\$122.00

\* Not Available with 752, 852 or A Class keyways.  
 \*\* Also Available in 605, 611, 612, 613, 625 finishes.  
 Not Available with X Class and certain restricted keyways.

<b>Master Ring Special Applications For Exit Device Operators (.552" plug)</b>
--

Cylinder Number	Finish: 606, 626
CR4266-001-A02      ED6800 x B5 or B6 trim ED7400 x 03 or 04 trim	\$126.00
CR4266-001-A92      ED6800 x 01 or 02 trim	

**Pin Kits**

Description	Catalog Number	Part Number	Price
Corbin Russwin System 70 and Pre-System 70, 752, 852 and A Class keyways Not for System 70 Security	PK-1070	610F538	\$902.00
Corbin® Z Class and Russwin® DH Class keyways System 70, all cylinders except Security	PK-70-ZDH	602F129	\$601.00
Russwin N Class System, all cylinders	PK-70-N	602F119	\$469.00
Corbin X Class, all cylinders	PK-70-X	602F109	\$459.00
Pyramid High Security cylinders	PK-20-HS	694F968	\$1,237.00
Pyramid Security cylinders	PK-20-PS	715F968	\$913.00
Security cylinders, including interchangeable core, blockout and Brink	PK-70-HS	610F529	\$1,704.00
Access 3 Key System AP only	PK-30-AP	763F088	\$879.00
Access 3 Key System - AP, AS, AHS	PK-30-MASTER	763F098	\$1,280.00

**Tools**

Description	Catalog Number	Part Number	Price
Tool kit - contains 1 each: CT-4, CT-11, CT-19, CT-21, CT-22, CT-23, CT-54	CT-93	612F588	\$297.00
Plug follower, .509" brass	CT-4	073F992	\$29.00
Pin chamber reamer	CT-5	239F758	\$81.00
Pin chamber burring tool	CT-7	382F188	\$214.00
Loading tool for .509" shell	CT-10	577F499	\$81.00
Key gauge, all Corbin® key classes	CT-11	239F377	\$29.00
Tweezers (was CT-6)	CT-19	239F368	\$34.00
Plug follower, .496	CT-20	694F972	\$14 (order in mult.of 10)
Key gauge, Pyramid	CT-20K	698F367	\$29.00
Key gauge, Access 3	CT-30K		
Key gauge, Russwin® N	CT-21	603F277	
Key gauge, Russwin® D & H	CT-22	604F197	
Key gauge, Russwin® 981/852	CT-23	604F187	
Plug follower, .552" brass	CT-54	073F982	\$36.00
IC mortise cylinder installation wrench	CT-80	363F612	\$50.00
Follower, disposable, .509" plug		484F729	\$1.00 (order in mult. Of 50)
Follower, disposable, .552" plug		484F739	\$0.50 (order in mult. Of 100)



ACCESS CONTROL	PAGES
Access 800® AC2 Microshield®	105
<b>ML20800 Series:</b>	
ML20800 Standard Features & Ordering Examples	106
ML20800 Lever Designs & Options	107
ML20800 Cylinder & Keying Options	108
ML20800 Door Thickness, Strike Options, Miscellaneous Options	109
<b>CL33800 Series:</b>	
CL33800 Standard Features & Ordering Examples	110
CL33800 Lever Designs & Options	111
CL33800 Cylinder & Keying Options	112
CL33800 Door Thickness, Strike Options, Miscellaneous Options	113
<b>ED5000 Series:</b>	
ED5000 Standard Features & Ordering Examples	114
ED5200 Series Lever Designs & Options	115
ED5633 & ED5634 Series Lever Designs & Options	116
ED5000 Series Cylinder & Keying Options	117
ED5000 Series Strike, Door Thickness, Width, Miscellaneous Options	118
ED5000 Series Electrified Options, Delayed Egress Options, Accessories	119
WM800 Reader/Controller	120
<b>Wiring Diagram Services &amp; Accessories:</b>	
Custom Wiring, Keypads, Controllers, Software	121
Credentials, Hardware, Gaskets, Accessories	122



Look for the   
MicroShield icon.

**MicroShield®**

As part of their promise to provide innovative solutions to their customers, certain ASSA ABLOY Group brands offer the MicroShield® technology, a silver-based antimicrobial coating designed to inhibit the growth of bacteria.

MicroShield® is a registered trademark of Yale Security Inc., an ASSA ABLOY Group company.

Product	Series	MicroShield® Coated Components
Access 800®	All	Levers* and escutcheons

**AVAILABLE FINISHES**

- MicroShield® is available on 626 and 630. Other finishes available by Special Product Application Request Form only.
- Specify 626C (satin chrome plated) or 630C (satin stainless steel) when ordering.
- MicroShield® coating will be applied over 626 and 630 finishes. All components will match 626.

*Note: MicroShield® coating will only be applied to "high touch" components.*

Description	Add
Mortise Locks	Add \$64.00
Cylindrical Locks	Add \$64.00
Exit Devices & Outside Trims (ordered together)	Add \$79.00 (when ordered together)
Exit Devices & Trims (ordered separately)	Add \$64.00

**ML20800 Mortise  
Standard Features**

**Handing**

Handed; quick reversible

**Door Thickness**

1-3/4"

**Backset**

2-3/4" Standard

**Strike**

ANSI straight lip  
4-7/8" x 1-1/4" x 1-1/8"

**Cylinder**

1000-138-A01, 6-pin, L4, keyed random,  
finished standard for 1-3/4" door

**Keys**

Two nickel silver standard

**Weight**

11 lbs

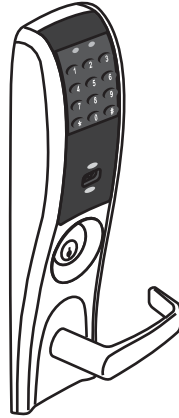

**ML20800 Mortise Lock Ordering Examples**

**Stock Order**

Quantity	Series/Function	Technology Code	Trim	Finish	Hand	Credential Quick Code
24	ML20834	TCAC2	LSZ	626	RHR	M803

**Split Trim/Finish Order**

Quantity	Series/Function	Technology Code	Trim		Finish		Hand	Credential Quick Code
			Outside	Inside	Outside	Inside		
24	ML20834	TCAC2	LSZ	CSZ	626	606	RHR	M803

**Contract/Detailed Order**

Quantity	Keypad	Series/Function	Technology Code	Trim	Finish	Hand	Door Thickness	Optional Strike	Credential Quick Code	Optional Cylinder	Keying
24	AA1	ML20834	TCAC2	LSZ	626	RHR	D214	SA200	M803	C7	VKC3

**Lever Design: ASZ, CSZ, DSZ, ESZ, LSZ, NSZ, PSZ, RSZ**

**Lever:** Cast    **Escutcheon:** Zinc Die Cast

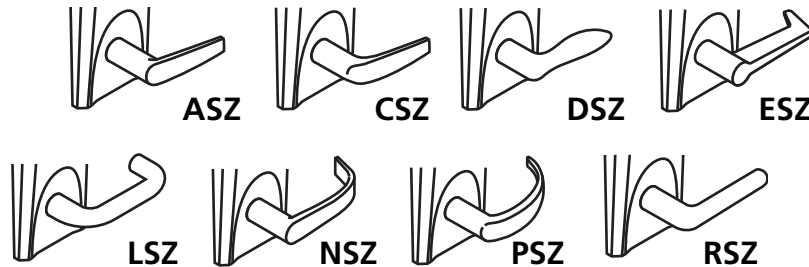

**Lever Design: FSZ, MSZ, TSZ, ZSZ**

**Lever:** Cast    **Escutcheon:** Zinc Die Cast



Function	Description	ASZ, CSZ, DSZ, ESZ, LSZ, NSZ, PSZ, RSZ		FSZ, MSZ, TSZ, ZSZ	
		Finish: 613E, 626, BSP	Finish: 605, 606, 611, 612, 613, 613L, 618, 619, 625, 630, 722	Finish: 613E, 626, BSP	Finish: 605, 606, 611, 612, 613, 613L, 618, 619, 625, 722
ML20833	Without key override x M800	\$1,178.00	\$1,280.00	\$1,178.00	\$1,280.00
ML20834	With key override x M800	\$1,264.00	\$1,366.00	\$1,264.00	\$1,366.00
ML20835	Deadbolt without key override x M800	\$1,192.00	\$1,294.00	\$1,192.00	\$1,294.00
ML20836	Deadbolt with key override x M800	\$1,278.00	\$1,380.00	\$1,278.00	\$1,380.00
ML20837*	Dormitory Entry with Deadbolt and inside leverswitch x M802	\$1,865.00	\$1,967.00	\$1,865.00	\$1,967.00
	Dormitory Entry with Deadbolt and inside leverswitch x M803	\$1,930.00	\$2,032.00	\$1,930.00	\$2,032.00

**Access 800® Options**

Description	Specify	Add
100 User, keypad only	M800	No Charge
2000 User, keypad only	M801	\$155.00
2000 User, proximity only	M802	\$587.00
2000 User, keypad and proximity	M803	\$652.00
2000 User, keypad and RF actuation**	M804	\$369.00
2000 User, proximity and RF actuation**	M805	\$801.00
2000 User, keypad, proximity and RF actuation**	M806	\$865.00

\* ML20837 only compatible with proximity readers, M802 and M803

\*\* Note: RF Fob must be ordered separately. See page 104.

**Mortise Lockset ML20800 Series Cylinder Options**

For Key Override function only

Description	Specify	Add or Deduct
Conventional 6-pin	(standard)	No Charge
Conventional 7-pin	7P	Add \$2.00 per cylinder
Less Standard Cylinder	LC	Deduct \$86.00 per cylinder
Access 3 Patented	AP	No Charge
Access 3 Security	AS	Add \$56.00 per cylinder
Access 3 High Security, UL 437	AHS	Add \$79.00 per cylinder
Access 3 IC Patented	ACP	Add \$74.00 per cylinder
Access 3 IC Security	ACS	Add \$123.00 per cylinder
Access 3 IC High Security, UL 437	ACHS	Add \$143.00 per cylinder
Pyramid Security Fixed Core	PS	Add \$58.00 per cylinder
Pyramid Security IC	PCS	Add \$129.00 per cylinder
Pyramid High Security Fixed Core	PHS	Add \$86.00 per cylinder
Pyramid High Security IC	PCHS	Add \$158.00 per cylinder
Pyramid IC with Temporary Construction Core	CTP	Add \$74.00 per cylinder
Pyramid IC with Temporary Disposable Core	CTPD	No Charge
Pyramid IC Less Core	CLP	No Charge
Security	HS	Add \$111.00 per cylinder
Security IC	CHS	Add \$183.00 per cylinder
IC 6-pin	C6	Add \$74.00 per cylinder
IC 6-pin with Temporary Construction Core (Red)	CT6R	Add \$74.00 per cylinder
IC 6-pin with Temporary Construction Core (Blue)	CT6B	Add \$74.00 per cylinder
IC 6-pin with Temporary Construction Core (Green)	CT6G	Add \$74.00 per cylinder
IC 6-pin with Temporary Disposable Core	CT6D	No Charge
IC 6-pin Less Core	CL6	No Charge
SFIC 6-pin with Less Core	CLS6	No Charge
IC 6-pin with SFIC disposable temporary core	CT6SD	No Charge
IC 7-pin	C7	Add \$76.00 per cylinder
IC 7-pin with Temporary Construction Core (Red)	CT7R	Add \$76.00 per cylinder
IC 7-pin with Temporary Construction Core (Blue)	CT7B	Add \$76.00 per cylinder
IC 7-pin with Temporary Construction Core (Green)	CT7G	Add \$76.00 per cylinder
IC 7-pin with Temporary Disposable Core	CT7D	Add \$2.00 per cylinder
IC 7-pin Less Core	CL7	Add \$2.00 per cylinder
SFIC 7-pin with Less Core	CLS7	Add \$2.00 per cylinder
IC 7-pin with SFIC disposable temporary core	CT7SD	Add \$2.00 per cylinder

**Keying Options\***

Description	Specify	Add or Deduct
0-Bitted with 2 blank keys	(standard)	No Charge
Keyed random	KR	No Charge
Construction master keyed <sup>1,2</sup>	CMK	Add \$16.00 per cylinder
Visual key control (VKC)		
- No Stamping	VKC0	\$4.50
- Keys only	VKC1	No Charge
- Cylinders and Keys <sup>3</sup>	VKC2	\$8.00
- Cylinders only <sup>3</sup>	VKC3	\$8.00
Concealed key control (CKC)		
- CKC cylinders with VKC keys	CKC2	\$8.00
- CKC cylinders only <sup>3</sup>	CKC3	\$8.00
More than 2 keys per lock	KY# (e.g., KY6)	See page 66 - Cut Keys Section

\*For key bows other than 10 and 90, specify "KB" + bow number as Quick Code, e.g. KB12.

- Notes:
1. CMK Construction master keying charge is in addition to master keying charge.
  2. CMK Construction master keying is not available in Pyramid or Security series.
  3. VKC2, VKC3, CKC3 are not available in Pyramid or Security series.

**Door Thickness**

Description	Specify	Add or Deduct
1-3/4"	(standard)	
2"	D200	No Charge
2-1/4"	D214	

**Strike Options\***

(To purchase strike separately, see catalog or parts manual for part no.)

Lip Length	ANSI Straight Lip - Specify	ANSI Curved Lip - Specify	Add or Deduct
7/8"	SS078	N/A	No Charge
1-1/8"	(standard)	N/A	
1-1/4"	SS114	SA114	
1-3/8"	SS138	SA138	
1-1/2"	SS112	SA112	
1-3/4"	SS134	SA134	Add \$16.00 per lockset
2"	SS200	SA200	
2-1/4"	SS214	SA214	
2-1/2"	SS212	SA212	
2-3/4"	SS234	SS234	
3"	SS300	SA300	

Description	Door Thickness	Specify	Add or Deduct
Open Back Strike	1-3/4"	SB134	Add \$82.00 per lockset
Open Back Strike	2"	SB200	Add \$124.00 per lockset
Open Back Strike	2-1/4"	SB214	
Rabbeted front and strike		SR118	Add \$86.00 per lockset

\* If door thickness is standard or has been specified and no special door or frame condition exists, then only the first two characters of the optional strike Quick Code must be specified (e.g. "SA").

The correct lip length will be determined by our order entry system based on the standard or specified door thickness.

**Miscellaneous Options**

Description	Specify	Add or Deduct
Torx® head screws	M04	Add \$24.00 per lockset
ANSI wrought strike box	M17	No Charge
Knurling outside and inside <sup>1</sup>	M20	Add \$137.00 per lockset
Knurling outside only <sup>1</sup>	M21	Add \$69.00 per lockset
Knurling inside only	M22	Add \$69.00 per lockset
Abrasive coat outside and inside <sup>1</sup>	M23	Add \$85.00 per lockset
Abrasive coat inside only <sup>1</sup>	M24	Add \$43.00 per lockset
Abrasive coat outside only	M25	Add \$43.00 per lockset
Power/Remote Unlocking Harness	M35	Add \$47.00 per lockset
Forced/Propped Door <sup>2</sup>	M861	Add \$12.50 per lockset

Notes:

1. Not available with Vineyard™ or Muséo® levers.
2. Not compatible with M800

**CL33800 Cylindrical  
Standard Features**

**Handing**

Non-handed

**Door Thickness**

1-3/4" - 2"

**Backset**

2-3/4" Standard

**Strike**

ANSI curved lip

4-7/8" x 1-1/4" x 1-1/4"

**Cylinder**

6-pin, L4, keyed random,  
0-bitted standard

**Keys**

Two nickel silver standard

**Weight**

9.5 lbs

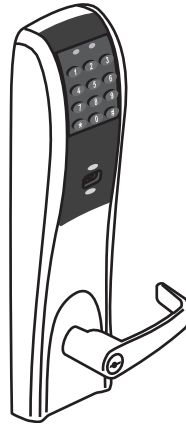

**CL33800 Cylindrical Lock Ordering Examples**

**Stock Order**

Quantity	Series/ Function	Technology Code	Trim	Finish	Hand	Credential Quick Code
100	CL33834	TCAC2	NZZ	626	RHR	M803

**Split Trim/Finish Order**

Quantity	Series/ Function	Technology Code	Trim		Finish		Hand	Credential Quick Code
			Outside	Inside	Outside	Inside		
12	CL33834	TCAC2	NZZ	AZZ	626	625	LH	M803

**Contract/Detailed Order**

Quantity	Keypad	Series/ Function	Technology Code	Trim	Finish	Hand	Door Thickness	Backset	Optional Strike	Credential Quick Code	Optional Cylinder	Keying
24	AA1	CL33834	TCAC2	NZZ	626	RHR	D214	B334	SC114	M802	C6	VKC3

**Lever Design: AZZ, NZZ, PZZ**

**Lever:** Zinc Die Cast

**Escutcheon:** Zinc Die Cast



Function	Description	AZZ, NZZ, PZZ, FZZ	
		Finish: 613E, 626, BSP	Finish: 611, 605, 606, 612, 613, 613L, 618, 619, 625, 722
CL33834	With key override x M800	\$1,143.00	\$1,238.00

**Access 800® Options**

Description	Specify	Add
100 User, keypad only	M800	No Charge
2000 User, keypad only	M801	\$155.00
2000 User, proximity only	M802	\$587.00
2000 User, keypad and proximity	M803	\$652.00
2000 User, keypad and RF actuation*	M804	\$369.00
2000 User, proximity and RF actuation*	M805	\$801.00
2000 User, keypad, proximity and RF actuation*	M806	\$865.00

\* Note: RF Fob must be ordered separately. See page 104.



**Cylindrical Lockset CL33800 Series Cylinder Options**

Description	Specify	Add or Deduct
Conventional 6-pin	(standard)	No Charge
Conventional 7-pin	7P	Add \$2.00 per cylinder
Less Standard Cylinder	LC	Deduct \$79.00 per cylinder
Access 3 Patented	AP	No Charge
Access 3 Security	AS	Add \$56.00 per cylinder
Access 3 High Security, UL 437	AHS	Add \$79.00 per cylinder
Access 3 IC Patented	ACP	Add \$74.00 per cylinder
Access 3 IC Security	ACS	Add \$123.00 per cylinder
Access 3 IC High Security, UL 437	ACHS	Add \$143.00 per cylinder
Pyramid Security Fixed Core	PS	Add \$58.00 per cylinder
Pyramid Security IC	PCS	Add \$129.00 per cylinder
Pyramid High Security Fixed Core	PHS	Add \$86.00 per cylinder
Pyramid High Security IC	PCHS	Add \$158.00 per cylinder
Pyramid IC Less Core	CLP	No Charge
Security	HS	Add \$111.00 per cylinder
Security IC	CHS	Add \$183.00 per cylinder
IC 6-pin	C6	Add \$74.00 per cylinder
IC 6-pin with Temporary Construction Core (Red)	CT6R	Add \$74.00 per cylinder
IC 6-pin with Temporary Construction Core (Blue)	CT6B	Add \$74.00 per cylinder
IC 6-pin with Temporary Construction Core (Green)	CT6G	Add \$74.00 per cylinder
IC 6-pin with Temporary Disposable Core	CT6D	No Charge
IC 6-pin Small Format Disposable Core	CTSD	No Charge
IC 6-pin Less Core	CL6	No Charge
IC 7-pin	C7	Add \$76.00 per cylinder
IC 7-pin with Temporary Construction Core (Red)	CT7R	Add \$76.00 per cylinder
IC 7-pin with Temporary Construction Core (Blue)	CT7B	Add \$76.00 per cylinder
IC 7-pin with Temporary Construction Core (Green)	CT7G	Add \$76.00 per cylinder
IC 7-pin with Temporary Disposable Core	CT7D	No Charge
IC 7-pin Less Core	CL7	No Charge
Lockset furnished in Schlage® C Keyway <sup>1</sup>	C	No Charge
Lockset furnished in SARGENT® LA Keyway <sup>2</sup>	LA	No Charge

**Keying Options\***

Description	Specify	Add or Deduct
0-Bitted with 2 blank keys	(standard)	No Charge
Keyed random	KR	No Charge
Construction master keyed <sup>1, 2</sup>	CMK	Add \$16.00 per cylinder
Visual key control (VKC)		
- No Stamping	VKC0	\$4.50
- Keys only	VKC1	No Charge
- Cylinders and Keys <sup>3</sup>	VKC2	\$8.00
- Cylinders only <sup>3</sup>	VKC3	\$8.00
Concealed key control (CKC)		
- CKC cylinders with VKC keys	CKC2	\$8.00
- CKC cylinders only <sup>3</sup>	CKC3	\$8.00
More than 2 keys per lock	KY# (e.g., KY6)	See page 66 - Cut Keys Section

\*For key bows other than 10 and 90, specify "KB" + bow number as Quick Code, e.g. KB12.

Notes:

1. CMK Construction master keying charge is in addition to master keying charge.
2. CMK Construction master keying is not available in Pyramid or Security series.
3. VKC2, VKC3, CKC3 are not available in Pyramid or Security series.

**Door Thickness Options**

Description	Specify	Add or Deduct
1-3/4"	(standard)	
2"	D214	Add \$6.00 per lockset

**Backset Options**

Description	Specify	Add or Deduct
2-3/4"	(standard)	No Charge
3-3/4"	B334	Add \$15.00 to lockset
5"	B500	Add \$24.00 to lockset

**Strike Options\***

(To purchase strike separately, see catalog or parts manual for part no.)

Lip Length	ANSI Straight Lip - Specify	ANSI Curved Lip - Specify	Add or Deduct
1"	SA100	SC100	No Charge
1-1/8"	SA118	SC118	
1-1/4"	(standard)	SC114	
1-3/8"	SA138	SC138	
1-1/2"	SA112	SC112	Add \$16.00 per lockset
1-3/4"	SA134	SC134	
2"	SA200	SC200	
2-1/4"	SA214	SC214	
2-1/2"	SA212	SC212	
2-3/4"	SA234	SC234	
3"	SA300	SC300	Add \$86.00 per lockset
Rabbeted front and strike		SR118	

\*If door thickness is standard or has been specified and no special door or frame condition exists, then only the first two characters of the optional strike Quick Code must be specified (e.g. "SC").

The correct lip length will be determined by our order entry system based on the standard or specified door thickness.

**Miscellaneous Options**

Description	Specify	Add or Deduct
Torx® head screws	M04	Add \$24.00 per lockset
Less cylinder, with tailpiece for Schlage® cylinder	M06	No Charge
Lever to accept Best® type core (NZZ & PZZ designs only)	M08	No Charge
Lever to accept Sargent® cylinder (NZZ & PZZ design only)	M09	No Charge
Rounded corners on latch front	M13	Add \$2.50 per latch
3/4" (19mm) throw fire latch	M16	Add \$100.00 per lockset
ANSI wrought strike box	M17	No Charge
Knurling outside and inside	M20	Add \$137.00 per lockset
Knurling outside only	M21	Add \$69.00 per lockset
Knurling inside only	M22	Add \$69.00 per lockset
Abrasive coat outside and inside	M23	Add \$85.00 per lockset
Abrasive coat inside only	M24	Add \$43.00 per lockset
Abrasive coat outside only	M25	Add \$43.00 per lockset
Power/Remote Unlocking Harness	M35	Add \$47.00 per lockset
Lever to accept Schlage® interchangeable core (NZZ & PZZ design only)	M69	No Charge
Forced door/propped door <sup>2</sup>	M861	Add \$12.50 per lockset

Notes: 2. Not compatible with M800

**ED5000 Exit Devices**  
**Standard Features**

**Handing**

Device non-handed; lever trim is handed

**Door Thickness**

1-3/4" Standard

**Stile**

4-1/2" Minimum width

**Strike**

Rim Device: Surface mounted 3/8" diameter roller strike

Mortise Device: ANSI curved lip strike

**Projection**

3-1/4" active, 2-3/4" dogged

**Trim**

Cylinder is not included. See page 117 for Cylinder options.

**Weight**

8.5 lbs



**ED5000 Series Exit Devices Ordering Examples**

**Exit Device Only**

Quantity	Series/Function	Finish	Hand	Misc. Options
24	ED5200S	626	RHR	M51-M54

**Trim Only**

Quantity	Trim/Function	Technology Code	Finish	Hand	Credential Quick Code
24	N9M833ET	TCAC2	625	RHR	M800

**Exit Device with Trim**

Quantity	Exit Device	Trim/Function	Technology Code	Finish	Hand	Cylinder Option	Door Thickness	Optional Strike	Door Width	Misc. Options	Credential Quick Code
65	ED5634L	N9M834ET	TCAC2	605	LHR	6P	D200	SB134	W048	M51-M54 & M800	M800

**Contract/Detailed Order - Rim Exit Device with Trim**

Quantity	Keyset	Exit Device	Trim/Function	Technology Code	Finish	Hand	Door Width	Credential Quick Code	Cylinder Option
36	AA1	ED5200	C9M834ET	TCAC2	626	LHR	W048	M804	79

**Removable Mullion**

Quantity	Mullion	Misc. Options
24	CR908A	M57

**Mortise Exit Only**

Trim Type	Function	Panic	Fire
Lever	Entry without key override	ED5600L	ED5600AL
Lever	Entry with key override	ED5634L	ED5634AL

**ED5200(S)(A) Rim/SecureBolt® Device**  
**Lever Design: A, C, D, E, L, N, PR, R**

**Lever:** Cast      **Keypad/Controller Escutcheon:** Zinc Die Cast  
**Trim Escutcheon:** Forged

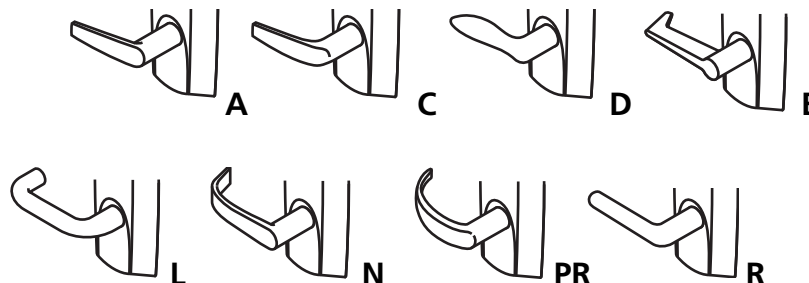

**Lever Design: FR, M, TS, Z**

**Lever:** Cast      **Keypad/Controller Escutcheon:** Zinc Die Cast  
**Trim Escutcheon:** Forged

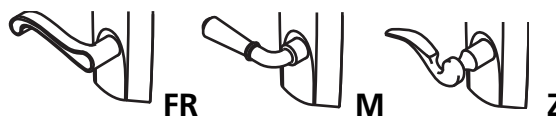

**Use with ED5200(S)(A) Rim/SecureBolt® Device**

Note: Exit Device ordered separately, starting on page 201.

Function*	Description	A, C, D, E, L, N, R, PR		FR, M, Z	
		Finish: 613E, 630, BSP	Finish: 605, 606, 611, 612, 613, 618, 619, 625, 626, 629, 722	Finish: 613E, 626, BSP	Finish: 605, 606, 611, 612, 613, 618, 619, 625, 722
9833ET	Without key override x M800	\$1,265.00	\$1,285.00	\$1,265.00	\$1,285.00
9834ET	With key override x M800				

Note: For key override add Cylinder Quick Code Option and price.

\*When specifying function, prefix with lever design.

Refer to ED7000 sections for mechanical push bar pricing.

Refer to the ED5000 section push pad exit device for order info.

**Access 800® Options**

Description	Specify	Add
100 User, keypad only	M800	No Charge
2000 User, keypad only	M801	\$155.00
2000 User, proximity only	M802	\$587.00
2000 User, keypad and proximity	M803	\$652.00
2000 User, keypad and RF actuation*	M804	\$369.00
2000 User, proximity and RF actuation*	M805	\$801.00
2000 User, keypad, proximity and RF actuation*	M806	\$865.00

\* Note: RF Fob must be ordered separately. See page 104.

**ED5633(A)L & ED5634(A)L Mortise Device**

**Lever Design: A, C, D, E, L, N, PR, R**

**Lever:** Cast

**Keypad/Controller Escutcheon:** Zinc Die Cast

**Trim Escutcheon:** Forged

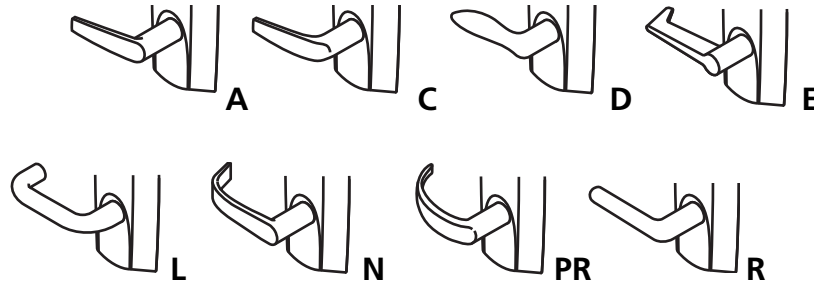

**Lever Design: FR, M, TS, Z**

**Lever:** Cast

**Keypad/Controller Escutcheon:** Zinc Die Cast

**Trim Escutcheon:** Forged

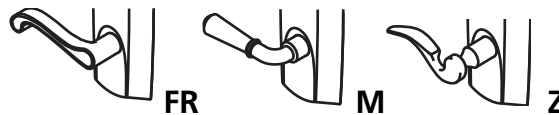

**Use with ED5633(A)L & ED5634(A)L Mortise Device**

Note: Exit Device ordered separately, starting on page 201.

Function*	Description	A, C, D, E, L, N, R, PR		FR, M, Z	
		Finish: 613E, 630, BSP	Finish: 605, 606, 611, 612, 613, 618, 619, 625, 626, 629, 722	Finish: 613E, 626, BSP	Finish: 605, 606, 611, 612, 613, 618, 619, 625, 722
9M833ET	Without key override x M800	\$1,221.00	\$1,241.00	\$1,221.00	\$1,241.00
9M834ET	With key override x M800				

Note: 9M833ET and 9M834ET cannot be retrofitted to an existing ED5600 Series mortise device. When ordered as "Trim Only", 9M833ET and 9M834ET will be furnished with the appropriate mortise lock (refer to Parts Price List for mortise lock body pricing). If a "Trim Only" order is intended for retrofitting and exit device with an M91 Bolt Monitor or an M93 Trim Monitor function, that function must be specified with the trim order to ensure the correct lock is furnished.

Note: For key override, add Cylinder Quick Code Option and price. See page 117.

\*When specifying function, prefix with lever design.

Refer to ED7000 sections for mechanical push bar pricing.

Refer to the ED5000 section push pad exit device for order info.

**Access 800® Options**

Description	Specify	Add
100 User, keypad only	M800	No Charge
2000 User, keypad only	M801	\$155.00
2000 User, proximity only	M802	\$587.00
2000 User, keypad and proximity	M803	\$652.00
2000 User, keypad and RF actuation*	M804	\$369.00
2000 User, proximity and RF actuation*	M805	\$801.00
2000 User, keypad, proximity and RF actuation*	M806	\$865.00
Gasket	M99	No Charge

Notes: 1. Available 0-bitted and Key Random (KR) only.

2. Available 0-bitted only.

\* Note: RF Fob must be ordered separately. See page 104.

**Exit Device ED5000 Series Cylinder Options\***

Description	Specify	Add or Deduct
Conventional 6-pin	6P**	Add \$86.00 per cylinder
Conventional 7-pin	7P	Add \$88.00 per cylinder
Access 3 Patented	AP	Add \$86.00 per cylinder
Access 3 Security	AS	Add \$135.00 per cylinder
Access 3 High Security, UL 437	AHS	Add \$155.00 per cylinder
Access 3 IC Patented	ACP	Add \$160.00 per cylinder
Access 3 IC Security	ACS	Add \$209.00 per cylinder
Access 3 IC High Security, UL 437	ACHS	Add \$223.00 per cylinder
Pyramid Security Fixed Core	PS	Add \$144.00 per cylinder
Pyramid Security IC	PCS	Add \$215.00 per cylinder
Pyramid High Security Fixed Core	PHS	Add \$174.00 per cylinder
Pyramid High Security IC	PCHS	Add \$244.00 per cylinder
Pyramid IC with Temporary Construction Core	CTP	Add \$160.00 per cylinder
Pyramid IC with Temporary Disposable Core	CTPD	Add \$86.00 per cylinder
Pyramid IC Less Core	CLP	Add \$86.00 per cylinder
Security	HS	Add \$197.00 per cylinder
Security IC	CHS	Add \$269.00 per cylinder
IC 6-pin	C6	Add \$160.00 per cylinder
IC 6-pin with Temporary Construction Core (Red)	CT6R	Add \$160.00 per cylinder
IC 6-pin with Temporary Construction Core (Blue)	CT6B	Add \$160.00 per cylinder
IC 6-pin with Temporary Construction Core (Green)	CT6G	Add \$160.00 per cylinder
IC 6-pin with Temporary Disposable Core	CT6D	Add \$86.00 per cylinder
IC 6-pin less core	CL6	Add \$86.00 per cylinder
SFIC 6-pin with Less Core	CLS6	Add \$86.00 per cylinder
IC 6-pin with SFIC disposable temporary core	CT6SD	Add \$86.00 per cylinder
IC 7-pin	C7	Add \$164.00 per cylinder
IC 7-pin with Temporary Construction Core (Red)	CT7R	Add \$164.00 per cylinder
IC 7-pin with Temporary Construction Core (Blue)	CT7B	Add \$164.00 per cylinder
IC 7-pin with Temporary Construction Core (Green)	CT7G	Add \$164.00 per cylinder
IC 7-pin with Temporary Disposable Core	CT7D	Add \$88.00 per cylinder
IC 7-pin less core	CL7	Add \$88.00 per cylinder
SFIC 7-pin with Less Core	CLS7	Add \$88.00 per cylinder
IC 7-pin with SFIC disposable temporary core	CT7SD	Add \$88.00 per cylinder

\*Optional dogging cylinder will be furnished with the same mechanism and keyed alike with the trim cylinder, unless otherwise specified. If different keying or cylinder type is required, specify outside (trim) first, then inside (dogging) cylinder.

\*\*6P cylinder option is supplied in 6-pin, L4 keyway, 0-bitted with two nickel silver keys.

**Keying Options\***

Description	Specify	Add or Deduct
0-Bitted with 2 blank keys	(standard)	No Charge
Keyed random	KR	No Charge
Construction master keyed <sup>1,2</sup>	CMK	Add \$16.00 per cylinder
Visual key control (VKC)		
- No stamping	VKC0	\$4.50
- Keys only	VKC1	No Charge
- Cylinders and keys <sup>3</sup>	VKC2	\$8.00
- Cylinders only <sup>3</sup>	VKC3	\$8.00
Concealed key control (CKC)		
- CKC cylinders with VKC keys	CKC2	\$8.00
- CKC cylinders only <sup>3</sup>	CKC3	\$8.00
More than 2 keys per lock	KY# (e.g., KY6)	See page 66 - Cut Keys Section

\*For key bows other than 10 and 90, specify "KB" + bow number as Quick Code, e.g. KB12.

Notes:

1. CMK Construction master keying charge is in addition to master keying charge.
2. CMK Construction master keying is not available in Pyramid or Security series.
3. VKC2, VKC3, CKC3 are not available in Pyramid or Security series.

**Strike Options\***

Description	Specify	Add or Deduct
Mortise Device		
-ANSI strike for pair of doors w/astragal (7/8" L to C)	SS078	No Charge
-Open back strike for 1-3/4" door	SB134	Add \$80.00 per lockset
-Open back strike for 2-1/4" door	SB214	\$128.00

\*(To purchase strike separately, see catalog or parts manual for part no.)

**Door Thickness Options**

Description	Specify	Add or Deduct
1-3/4"	(standard)	No Charge
2"	D200	No Charge
2-1/4"	D214	No Charge

**Door Width Options**

Description	Specify	Add or Deduct
24"	W024	Add \$292.00 per device
36"	(standard)	No Charge
48"	W048	Add \$35.00 per device

**Miscellaneous Options**

Description	Specify	Add or Deduct
Torx® Head Screws	M04	Add \$44.00 per device
ANSI wrought strike box (mortise)	M17	No Charge
Knurling outside & inside (embossed touchbar - device side) <sup>1</sup>	M20	Add \$145.00 per device
Knurling outside only (trim side) <sup>1</sup>	M21	Add \$68.00 per device
Knurling inside only (embossed touchbar - device side)	M22	Add \$77.00 per device
Abrasive coat outside and inside (trim and device) <sup>1</sup>	M23	Add \$92.00 per device
Abrasive coat inside only (device side)	M24	Add \$48.00 per device
Abrasive coat outside only (trim side) <sup>1</sup>	M25	Add \$44.00 per device
Power/Remote Unlocking Harness	M35	Add \$47.00 per lockset
Less dogging	M51	No Charge
Cylinder dogging	M52	Add \$78.00 per device
Sex nuts and bolts (SNBs)	M54	No Charge
Shim kit (for vision light)	M58	Add \$96.00 per device
Wood screws for use on fire-rated solid wood or wood core doors	M64	No Charge
Forced/Propped Door <sup>2</sup>	M861	Add \$12.50 per lockset

Notes: 1. Not available with Vineyard™ or Muséo® levers.  
 2. Not compatible with M800

**Electrified Options**

Description	Specify	Add or Deduct
Exit Alarm Device (cylinder not included)	M61	\$709.00
Bolt Position Monitoring	M91	Add \$217.00
Touchbar Monitoring or Signaling	M92*	Add \$204.00
Outside Monitoring or Signaling	M93	Add \$204.00
Motor Latch Retraction	MELR	\$835.00
Electric Dogging	M97	Add \$416.00

\*M92 is included with M861 option.

**Delayed Egress Options**

Description	Specify	Add or Deduct
Delayed Egress (15-second delay)	D	Add \$1533.00
30-second delay (may be accepted by local jurisdiction)	M88	\$107.00
BOCA 15-second delay	M89	\$107.00
BOCA 30-second delay	M90	\$107.00

**Electrified Accessories**

Description	Specify	Add or Deduct
Power Supply 9VDC Output	784	\$453.00
Power Supply 1.0 Amp @ 24 VDC Output	BPS-24-1	\$327.00
Power Supply 2 Amp @ 24 VDC Output	BPS-24-2	\$664.00
SPDT Maintained Switch (includes LED)	MKA	\$124.00
SPDT Maintained Switch (includes LED)	MKAN	\$197.00
SPDT Momentary Switch (includes LED)	MK	\$197.00
SPDT Momentary Switch (illuminated)	PB3	\$146.00
SPDT Maintained (Alt. Action) Switch	PB3EA	\$115.00
Sonalert 90lbs. @ 2ft. 12-24VDC mounted on one gang stainless steel plate	PZ1	\$97.00
Alarm Kit (cylinder is not included)**	ED50AK	\$805.00
Concealed transfer for over 120° swing doors	EPTL	\$129.00

\*\*Alarm Kit cannot be installed in the field to surface vertical rod device.

Any attempt to do so voids all warranties



**WM800**

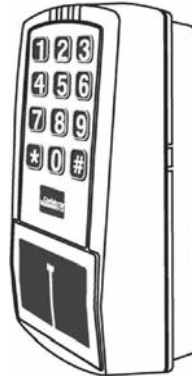

Function	Description	Finish: Dark Gray
WM800	Reader/Controller	\$1,111.00

Includes weather gasket and glass mounting kit

**Custom Wiring Diagram Services:**

Part Number	Description	Price
WD-BASIC	Basic riser / elevation diagrams	Contact 800-810-WIRE (9473) for pricing
WD-SPEC	Specification package	
WD-P2P	Point to Point package	
WD-SYSPK	System Package	
WD-SWP	Special Wiring Package	

**Keypad Versions (w/Ribbon Cable)**

Part Number	Description	Price
708F809	M800 (100 user, keypad only)	\$202.00
708F089	M801, M803, M804, M806 (2000 user keypad and keypad + prox)	\$475.00
708F099	M802, M805 (2000 user prox only)	\$387.00

**100 User Controllers – Contact 800-810-WIRE (9473) for pricing**

Part Number	Description	Price
708F819	M800 (100 user, keypad only) - Cylindrical	\$418.00
708F829	M800 (100 user, keypad only) - Mortise/Exits	

**2000 User Cylindrical Controllers**

Part Number	Description	Price
712F009	M801 (2000 user, keypad)	\$695.00
712F019	M802 or M803 (2000 user prox only or keypad + prox)	\$1,024.00
712F029	M804 (2000 user keypad + RF*)	\$926.00
712F039	M805 or M806 (prox + RF* or keypad + prox + RF*)	\$1,312.00

**2000 User Mortise & Exit Controllers**

Part Number	Description	Price
712F049	M801 (2000 user, keypad)	\$695.00
712F059	M802 or M803 (2000 user prox only or keypad + prox)	\$1,024.00
712F069	M804 (2000 user keypad + RF*)	\$926.00
712F079	M805 or M806 (prox + RF* or keypad + prox + RF*)	\$1,312.00

**Software**

Part Number	Description	Price
790F139	SoloPlus™ Software	\$339.00

\* Note: RF Fob must be ordered separately. See page 104.

**Credentials**

Part Number	Description	Order Multiples*	Order Minimums	Price (Each)
767F479	C/R 26 bit iCLASS 210 blank	Order 25-	100	\$11.00
767F489	HID 26 bit iCLASS 210 blank	Order 25-	100	
794F329	C/R 26 bit ISO Prox II blank	Order 25-	100	
794F359	HID® 26 bit ISO Prox II with logo	Order 25-	100	
794F369	HID 26 bit ISO Prox II without logo	Order 25-	100	
794F429	C/R MicroProx® tag	Order 10-	100	\$9.00
794F449	HID MicroProx tag with customer site code	Order 10-	100	
708F999	RF FOB	Order 1	1	\$101.00

\*Sold only in multiples of the number indicated.

Note: For HID credentials, site/facility code and card sequence numbers must be specified.

**Hardware**

Part Number	Description	Price
708F979	Conduit	\$14.00
793F039	784 Remote power supply (includes Plug-in Wall Transformer, 12 feet of shielded wire)	\$462.00
793F049	Plug in wall transformer	\$60.00
793F059	Cable assembly - power supply	\$57.00
793F069	Power/remote unlocking harness	\$62.00
793F089	12 V 1.2 A/Hr. Gel Cell Battery	\$67.00
793F199	Battery, Alkaline (AA) (single battery)	\$3.00
793F029	Ribbon Cable	\$35.00
712F089	New Enrollment Station	\$731.00
712F119	Forced/Propped Door Harness; when ordered separately	\$25.00
M861	Forced/Propped Door Function ordered with device	Add \$12.50 per lockset
M35	Power/Remote Unlocking Harness; ordered with device	Add \$47.00 per lockset
711F989	Power/Remote Unlocking Harness; when ordered separately	\$60.00

**Gaskets**

Part Number	Description	Price
794F509	Exit device - Keypad	\$10.40
794F519	Exit device trim	\$10.40
794F529	Cylindrical lock	\$14.00
794F539	Mortise lock	\$14.00

**Accessories**

Part Number	Description	Price
790F109	Data Transfer Device (DTD)	\$783.00

Notes: 1. Data Transfer Device (DTD) package includes: Handheld DTD, SoloPlus software CD, USB cable, four (4) AA batteries, instructions and a lanyard.

**MORTISE LOCKSETS & TRIM**
**PAGES**
**ML2000 Series:**

MicroShield®	123
ML2000 Series	124
ML2000 Series: LWA, RWA, LWN, LWM, LWP, LWR	125
ML2000 Series: LSA, LSN, LSM, LSP, LSR	126
ML2000 Series: ASA, CSA, NSA, PSA, RSA, NSM, NSN, NSP, NSR	127
ML2000 Series: DSA, ESA, DSM, DSN, DSP, DSR	128
ML2000 Series: GZA, GZB, GZF, GZH, YZA, YZB, YZF, YZH, GZM, GZP, GZR	129
ML2000 Series Vineyard Collection: FSG, MSG, ZSG, FSL, MSL, ZSL	130
ML2000 Series: Deadbolts: M, N, P, L, R	131
Vandal Resistant Trim: CSV, NSV	132

**ML20900 Series/ML20600 Series NAC:**

ML20900 Series: LWA, RWA, LWM, LWN, LWR, ASA, CSA, LSA, NSA, PSA, RSA, NSM, NSN, NSR	133
ML20600 Series NAC: LWA, RWA, LWM, LWN, LWR, ASA, CSA, LSA, NSA, PSA, RSA, NSM, NSN, NSR	134
ML20900 Series: DSA, ESA, DSM, DSN, DSR, CSV, NSV	135
ML20600 Series NAC: DSA, ESA, DSM, DSN, DSR, CSV, NSV	136
ML20900 Series Vineyard Collection: FSG, MSG, ZSG, FSL, MSL, ZSL	137
ML20600 Series NAC Vineyard Collection: FSG, MSG, ZSG, FSL, MSL, ZSL	138
ML20900 Series: GZA, GZB, GZF, GZH, YZA, YZB, YZF, YZH, GZM, GZP, GZR	139
ML20600 & ML20900 Series: Voltage, Electrified Options, Accessories	140
ML2000 & ML20900 Series: Ordering Example, Conversion Kits	141

**ML2000/20900 Series:**

ML2000 & ML20900 Series Cylinder & Keying Options	142
ML2000 & ML20900 Series Cylinder & Keying Options (Continued), ML2000/20900 Strike Options	143
ML2000 & ML20900 Series Door Thickness with Locksets Mortised on Center, Panel Applications	144
ML2000 & ML20900 Series Miscellaneous Options, Thumbturn Options	145
Blank Page	146



Look for the  *MicroShield* icon.

**MicroShield®**

As part of their promise to provide innovative solutions to their customers, certain ASSA ABLOY Group brands offer the MicroShield® technology, a silver-based antimicrobial coating designed to inhibit the growth of bacteria.

MicroShield® is a registered trademark of Yale Security Inc., an ASSA ABLOY Group company.

Product	Series	MicroShield® Coated Components
Mortise Locks	ML2000 Series	Knobs/Levers, roses and/or escutcheons

**AVAILABLE FINISHES**

- MicroShield® is available on 626 and 630. Other finishes available by Special Product Application Request Form only.
- Specify 626C (satin chrome plated) or 630C (satin stainless steel) when ordering.
- MicroShield® coating will be applied over 626 and 630 finishes. All components will match 626.

*Note: MicroShield® coating will only be applied to "high touch" components.*

**HOW TO ORDER**

Product	How to Order
Mortise Locks	ML2055 x LWA x 626C x RHR

Description	Add
Mortise Locks	Add \$64.00

**Standard Features**

**Handing**

Field reversible

**Door Thickness**

1-3/4"

**Backset**

2-3/4"

**Warranty**

10 Years

**Strike**

ANSI straight lip  
4-7/8" x 1-1/4" x 1-1/8" lip to center

**Cylinder**

Brass, 6-pin, L4 keyway, 0-bitted

**Keys**

Two nickel silver keys

**Case Quantity**

6

**Case Weight**

Variable

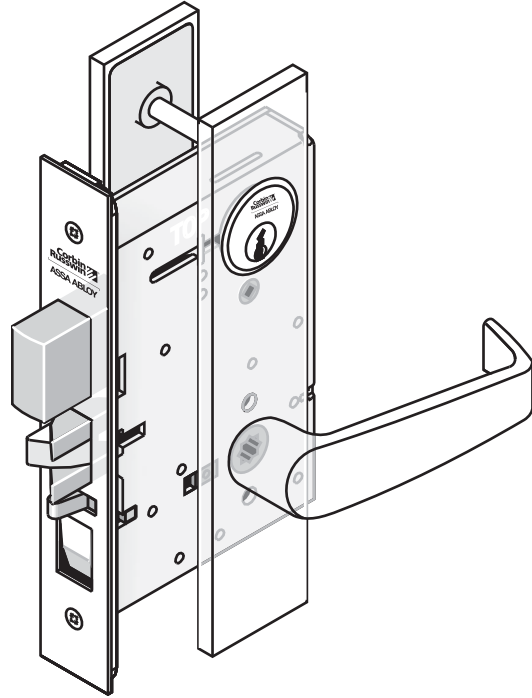

**Ordering Example**

**Stock Order**

Quantity	Series/Function	Trim	Finish	Hand
100	ML2055	LSB	626	RHR

**Split Trim/Split Finish**

Quantity	Series/Function	Trim		Finish		Hand
		Outside	Inside	Outside	Inside	
12	ML2055	LSB	GRC	626	625	RHR

Split trim is not available mixing escutcheon with sectional trim or with a different escutcheon

**Contract/Detailed Order**

Quantity	Keyset	Series/Function	Trim	Finish	Hand	Strike	Misc. Options	Cylinder and Keying
24	AA1	ML2055	LSB	626	RHR	SA200	M17-M26	C7-VKC3

**Working Trim Only**

Quantity	Function only	Trim	Finish	Hand	Door Thickness	Misc. Options
6	ML2055	LWA	626	RHR	D214	M31

(includes grip and spindle, rose or escutcheon, thumbturn, adapters and screws)

**High Security Monitoring Option Order**

Quantity	Series/Function	Technology Code	Trim	Finish	Hand	Fail Safe/ Fail Secure	High Security Monitoring Options
24	ML20608	NAC	ASA	626	RHR	SEC	PHRR01

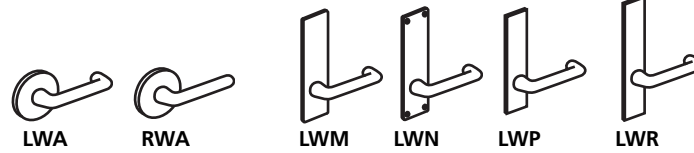

LWA RWA  
Lever: Wrought  
Rose: Wrought

LWM LWN LWP  
Lever: Wrought  
Escutcheon: Wrought

LWR  
Lever: Wrought  
Escutcheon: Solid Stainless Steel  
or Forged Brass

<b>Levers: LW, RW</b>	
<b>Roses: A</b>	
Roses: B, F (see note 1)	
613E, 626, BSP	605, 606, 611, 612, 613, 618, 619, 625, 629, 630, 722

<b>Levers: LW, RW</b>	
<b>Escutcheons: M, N, P</b>	
613E, 626, BSP	605, 606, 611, 612, 613, 618, 619, 625, 629, 630, 722

<b>Levers: LW, RW</b>	
<b>Escutcheons: R (see note 2)</b>	
613E, 626, BSP	605, 606, 611, 612, 613, 618, 619, 625, 629, 630, 722

Function	Model	Description	Price 1	Price 2	Price 3	Price 4	Price 5	Price 6
Non-Keyed	ML2010	Passage	\$640.00	\$664.00	\$660.00	\$684.00	\$714.00	\$738.00
	ML2020	Privacy						
	ML2030	Privacy	\$759.00	\$783.00	\$779.00	\$803.00	\$833.00	\$857.00
	ML2060	Privacy	\$696.00	\$720.00	\$716.00	\$740.00	\$770.00	\$794.00
	ML2050	Half Dummy	\$350.00	\$362.00	\$360.00	\$384.00	\$387.00	\$411.00
	ML2070	Full Dummy	\$700.00	\$724.00	\$720.00	\$744.00	\$774.00	\$798.00
	ML2080	Half Active Dummy Trim	\$303.00	\$315.00	\$323.00	\$347.00	\$377.00	\$401.00
	ML2090	Full Active Dummy Trim	\$653.00	\$677.00	\$673.00	\$697.00	\$727.00	\$751.00
Single Cylinder	ML2003	Classroom						
	ML2051	Office						
	ML2055	Classroom	\$770.00	\$794.00	\$790.00	\$814.00	\$844.00	\$868.00
	ML2056	Classroom						
	ML2057	Storeroom						
	ML2069	Institution Privacy						
	ML2053	Entrance						
	ML2054	Entrance	\$783.00	\$807.00	\$803.00	\$827.00	\$857.00	\$881.00
ML2058	Entrance Holdback							
ML2068	Privacy or Apartment							
Single Cylinder with Deadbolt	ML2024	Entrance						
	ML2048	Entrance						
	ML2049	Storeroom Deadbolt						
	ML2065	Dormitory	\$806.00	\$830.00	\$826.00	\$850.00	\$880.00	\$904.00
	ML2059	Security Storeroom						
	ML2067	Apartment						
	ML2073	Classroom Security						
	ML2075	Entrance/Office						
ML2029	Hotel	\$861.00	\$885.00	\$881.00	\$905.00	\$935.00	\$959.00	
Double Cylinder	ML2002	Classroom Intruder						
	ML2032	Institution						
	ML2042	Entrance	\$856.00	\$880.00	\$876.00	\$900.00	\$930.00	\$954.00
	ML2052	Classroom Intruder						
	ML2087	Security Vestibule					N/A	N/A
Double Cylinder with Deadbolt	ML2022	Store Door						
	ML2062	Intruder Deadbolt						
	ML2072	Classroom Security	\$892.00	\$916.00	\$912.00	\$936.00	\$966.00	\$990.00
	ML2082	Intruder						
	ML2092	Dormitory Security Institution						
Full Working Trim (Quick Code M31) No cylinder; includes thumbturn lever			\$543.00	\$567.00	\$563.00	\$587.00	\$617.00	\$641.00

**NOTE:**

1 - Rose substitutions for LWA, RWA: 2-1/4" cast rose in place of 2-1/4" wrought rose, substitute letter "B" in place of "A" (e.g. LWB). **Add \$38.00 per lockset.** 2-7/8" cast rose in place of 2-1/4" wrought rose, substitute letter "F" in place of "A" (e.g. RWF). **Add \$52.00 per lockset.**

2 - "R" Escutcheon trims are available for 1 3/8", 1 3/4", 2", or 2 1/4" door thickness only.



**LSA**

Lever: Cast  
Rose: Wrought

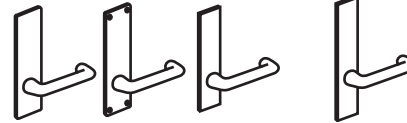

**LSM**

**LSN**

**LSP**

**LSR**

Lever: Cast  
Escutcheon: Wrought

Lever: Cast  
Escutcheon: Solid Stainless Steel  
or Forged Brass

<b>Levers: LS</b>	
<b>Roses: A</b>	
Roses: B, F (see note 1)	
<b>613E, 626, BSP</b>	<b>605, 606, 611, 612, 613, 618, 619, 625, 629, 630, 722</b>

<b>Levers: LS</b>	
<b>Escutcheons: M, N, P</b>	
<b>613E, 626, BSP</b>	<b>605, 606, 611, 612, 613, 618, 619, 625, 629, 630, 722</b>

<b>Levers: LS</b>	
<b>Escutcheons: R (see note 2)</b>	
<b>613E, 626, BSP</b>	<b>605, 606, 611, 612, 613, 618, 619, 625, 629, 630, 722</b>

Function								
	Model	Description	Price 1	Price 2	Price 3	Price 4	Price 5	Price 6
Non-Keyed	ML2010	Passage	\$662.00	\$749.00	\$805.00	\$829.00	\$839.00	\$863.00
	ML2020	Privacy						
	ML2030	Privacy	\$768.00	\$860.00	\$911.00	\$935.00	\$945.00	\$969.00
	ML2060	Privacy	\$737.00	\$827.00	\$880.00	\$904.00	\$914.00	\$938.00
	ML2050	Half Dummy	\$251.00	\$345.00	\$446.00	\$470.00	\$463.00	\$487.00
	ML2070	Full Dummy	\$502.00	\$596.00	\$892.00	\$916.00	\$926.00	\$950.00
	ML2080	Half Active Dummy Trim	\$450.00	\$539.00	\$398.00	\$422.00	\$442.00	\$466.00
ML2090	Full Active Dummy Trim	\$701.00	\$790.00	\$844.00	\$868.00	\$878.00	\$902.00	
Single Cylinder	ML2003	Classroom						
	ML2051	Office						
	ML2055	Classroom	\$818.00	\$912.00	\$961.00	\$985.00	\$995.00	\$1,019.00
	ML2056	Classroom						
	ML2057	Storeroom						
	ML2069	Institution Privacy						
	ML2053	Entrance						
ML2054	Entrance	\$831.00	\$926.00	\$974.00	\$998.00	\$1,008.00	\$1,032.00	
ML2058	Entrance Holdback							
ML2068	Privacy or Apartment							
Single Cylinder with Deadbolt	ML2024	Entrance						
	ML2048	Entrance						
	ML2049	Storeroom Deadbolt						
	ML2065	Dormitory	\$854.00	\$950.00	\$997.00	\$1,021.00	\$1,031.00	\$1,055.00
	ML2059	Security Storeroom						
	ML2067	Apartment						
	ML2073	Classroom Security						
ML2075	Entrance/Office							
ML2029	Hotel	\$909.00	\$1,008.00	\$1,052.00	\$1,076.00	\$1,086.00	\$1,110.00	
Double Cylinder	ML2002	Classroom Intruder						
	ML2032	Institution						
	ML2042	Entrance	\$904.00	\$1,003.00	\$1,047.00	\$1,071.00	\$1,081.00	\$1,105.00
	ML2052	Classroom Intruder						
ML2087	Security Vestibule					N/A	N/A	
Double Cylinder with Deadbolt	ML2022	Store Door						
	ML2062	Intruder Deadbolt						
	ML2072	Classroom Security Intruder	\$940.00	\$1,041.00	\$1,083.00	\$1,107.00	\$1,117.00	\$1,141.00
	ML2082	Dormitory						
ML2092	Security Institution							
Full Working Trim (Quick Code M31) No cylinder; includes thumbturn lever			\$538.00	\$632.00	\$795.00	\$819.00	\$829.00	\$853.00

NOTE: 1 - Rose substitutions for LSA: 2-1/4" cast rose in place of 2-1/4" wrought rose, substitute letter "B" in place of "A" (e.g. LSB). **Add \$38.00 per lockset.**  
 2-7/8" cast rose in place of 2-1/4" wrought rose, substitute letter "F" in place of "A" (e.g. LSF). **Add \$52.00 per lockset.**  
 2 - "R" Escutcheon trims are available for 1 3/8", 1 3/4", or 2 1/4" door thickness only



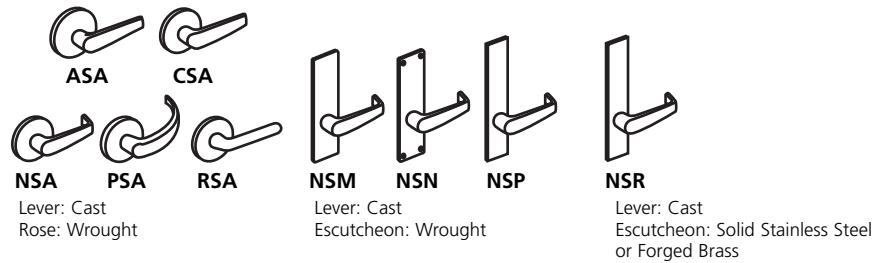

<b>Levers: AS, CS, NS, PS, RS</b>	
<b>Roses: A</b>	
<b>Roses: B, F (see note 1)</b>	
<b>613E, 626, BSP</b>	<b>605, 606, 611, 612, 613, 618, 619, 625, 629, 630, 722</b>

<b>Levers: AS, CS, NS, PS, RS</b>	
<b>Escutcheons: M, N, P</b>	
<b>613E, 626, BSP</b>	<b>605, 606, 611, 612, 613, 618, 619, 625, 629, 630, 722</b>

<b>Levers: AS, CS, NS, PS, RS</b>	
<b>Escutcheons: R (see note 2)</b>	
<b>613E, 626, BSP</b>	<b>605, 606, 611, 612, 613, 618, 619, 625, 629, 630, 722</b>

Function	Model	Description	613E, 626, BSP	605, 606, 611, 612, 613, 618, 619, 625, 629, 630, 722	613E, 626, BSP	605, 606, 611, 612, 613, 618, 619, 625, 629, 630, 722	613E, 626, BSP	605, 606, 611, 612, 613, 618, 619, 625, 629, 630, 722
Non-Keyed	ML2010	Passage	\$785.00	\$809.00	\$805.00	\$829.00	\$839.00	\$863.00
	ML2020	Privacy	\$891.00	\$915.00	\$911.00	\$935.00	\$945.00	\$969.00
	ML2030	Privacy	\$860.00	\$884.00	\$880.00	\$904.00	\$914.00	\$938.00
	ML2050	Half Dummy	\$436.00	\$448.00	\$446.00	\$470.00	\$463.00	\$487.00
	ML2070	Full Dummy	\$872.00	\$896.00	\$892.00	\$916.00	\$926.00	\$950.00
	ML2080	Half Active Dummy Trim	\$388.00	\$400.00	\$398.00	\$422.00	\$442.00	\$466.00
	ML2090	Full Active Dummy Trim	\$824.00	\$848.00	\$844.00	\$868.00	\$878.00	\$902.00
Single Cylinder	ML2003	Classroom	\$941.00	\$965.00	\$961.00	\$985.00	\$995.00	\$1,019.00
	ML2051	Office						
	ML2055	Classroom						
	ML2056	Classroom	\$954.00	\$978.00	\$974.00	\$998.00	\$1,008.00	\$1,032.00
	ML2057	Storeroom						
	ML2069	Institution Privacy						
	ML2053	Entrance						
ML2054	Entrance							
ML2058	Entrance Holdback							
ML2068	Privacy or Apartment							
Single Cylinder with Deadbolt	ML2024	Entrance	\$977.00	\$1,001.00	\$997.00	\$1,021.00	\$1,031.00	\$1,055.00
	ML2048	Entrance						
	ML2049	Storeroom Deadbolt						
	ML2065	Dormitory						
	ML2059	Security Storeroom						
	ML2067	Apartment						
	ML2073	Classroom Security						
ML2075	Entrance/Office							
ML2029	Hotel	\$1,032.00	\$1,056.00	\$1,052.00	\$1,076.00	\$1,086.00	\$1,110.00	
Double Cylinder	ML2002	Classroom Intruder	\$1,027.00	\$1,051.00	\$1,047.00	\$1,071.00	\$1,081.00	\$1,105.00
	ML2032	Institution						
	ML2042	Entrance						
	ML2052	Classroom Intruder						
	ML2087	Security Vestibule					N/A	N/A
Double Cylinder with Deadbolt	ML2022	Store Door	\$1,063.00	\$1,087.00	\$1,083.00	\$1,107.00	\$1,117.00	\$1,141.00
	ML2062	Intruder Deadbolt						
	ML2072	Classroom Security Intruder						
	ML2082	Dormitory						
	ML2092	Security Institution						
Full Working Trim (Quick Code M31) No cylinder; includes thumbturn lever			\$775.00	\$799.00	\$795.00	\$819.00	\$829.00	\$853.00

NOTE: 1 - Rose substitutions for ASA, CSA, etc.: 2-1/4" cast rose in place of 2-1/4" wrought rose, substitute letter "B" in place of "A" (e.g. NSB). **Add \$38.00 per lockset.**  
 2-7/8" cast rose in place of 2-1/4" wrought rose, substitute letter "F" in place of "A" (e.g. NSF). **Add \$52.00 per lockset.**  
 2 - "R" Escutcheon trims are available for 1 3/8", 1 3/4", or 2 1/4" door thickness only



**DSA**      **ESA**  
Lever: Cast  
Rose: Wrought

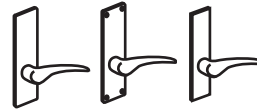

**DSM**    **DSN**    **DSP**  
Lever: Cast  
Escutcheon: Wrought



**DSR**  
Lever: Cast  
Escutcheon: Solid Stainless Steel  
or Forged Brass

<b>Lever: DS, ES</b>	
<b>Roses: A</b>	
<b>Roses: B, F (see note 1)</b>	
<b>613E, 626, BSP</b>	<b>605, 606, 611, 612, 613, 618, 619, 625, 629, 630, 722</b>

<b>Lever: DS, ES</b>	
<b>Escutcheons: M, N, P</b>	
<b>613E, 626, BSP</b>	<b>605, 606, 611, 612, 613, 618, 619, 625, 629, 630, 722</b>

<b>Lever: DS, ES</b>	
<b>Escutcheons: R (see note 2)</b>	
<b>613E, 626, BSP</b>	<b>605, 606, 611, 612, 613, 618, 619, 625, 629, 630, 722</b>

Function								
Non-Keyed	ML2010	Passage	\$811.00	\$835.00	\$831.00	\$855.00	\$865.00	\$889.00
	ML2020	Privacy	\$917.00	\$941.00	\$927.00	\$951.00	\$971.00	\$995.00
	ML2030	Privacy						
	ML2060	Privacy	\$886.00	\$910.00	\$913.00	\$937.00	\$940.00	\$964.00
	ML2050	Half Dummy	\$462.00	\$486.00	\$472.00	\$496.00	\$489.00	\$513.00
	ML2070	Full Dummy	\$924.00	\$948.00	\$944.00	\$968.00	\$978.00	\$1,002.00
	ML2080	Half Active Dummy Trim	\$388.00	\$412.00	\$398.00	\$422.00	\$415.00	\$439.00
	ML2090	Full Active Dummy Trim	\$850.00	\$874.00	\$870.00	\$894.00	\$904.00	\$928.00
Single Cylinder	ML2003	Classroom						
	ML2051	Office						
	ML2055	Classroom	\$967.00	\$991.00	\$987.00	\$1,011.00	\$1,021.00	\$1,045.00
	ML2056	Classroom						
	ML2057	Storeroom						
	ML2069	Institution Privacy						
	ML2053	Entrance						
	ML2054	Entrance	\$980.00	\$1,004.00	\$1,000.00	\$1,024.00	\$1,034.00	\$1,058.00
ML2058	Entrance Holdback							
ML2068	Privacy or Apartment							
Single Cylinder with Deadbolt	ML2024	Entrance						
	ML2048	Entrance						
	ML2049	Storeroom Deadbolt						
	ML2065	Dormitory	\$1,003.00	\$1,027.00	\$1,023.00	\$1,047.00	\$1,057.00	\$1,081.00
	ML2059	Security Storeroom						
	ML2067	Apartment						
	ML2073	Classroom Security						
	ML2075	Entrance/Office						
ML2029	Hotel	\$1,058.00	\$1,082.00	\$1,078.00	\$1,102.00	\$1,112.00	\$1,136.00	
Double Cylinder	ML2002	Classroom Intruder						
	ML2032	Institution						
	ML2042	Entrance	\$1,053.00	\$1,077.00	\$1,073.00	\$1,097.00	\$1,107.00	\$1,131.00
	ML2052	Classroom Intruder						
	ML2087	Security Vestibule					N/A	N/A
Double Cylinder with Deadbolt	ML2022	Store Door						
	ML2062	Intruder Deadbolt						
	ML2072	Classroom Security Intruder	\$1,089.00	\$1,113.00	\$1,109.00	\$1,133.00	\$1,143.00	\$1,167.00
	ML2082	Dormitory						
	ML2092	Security Institution						
Full Working Trim (Quick Code M31) No cylinder; includes thumbturn lever			\$827.00	\$851.00	\$847.00	\$871.00	\$881.00	\$905.00

**NOTE:**

1 - Rose substitutions for DSA, ESA: 2-1/4" cast rose in place of 2-1/4" wrought rose, substitute letter "B" in place of "A" (e.g. DSB). **Add \$38.00 per lockset.**  
 2-7/8" cast rose in place of 2-1/4" wrought rose, substitute letter "F" in place of "A" (e.g. ESF). **Add \$52.00 per lockset.**  
 2 - "R" Escutcheon trims are available for 1 3/8", 1 3/4", or 2 1/4" door thickness only

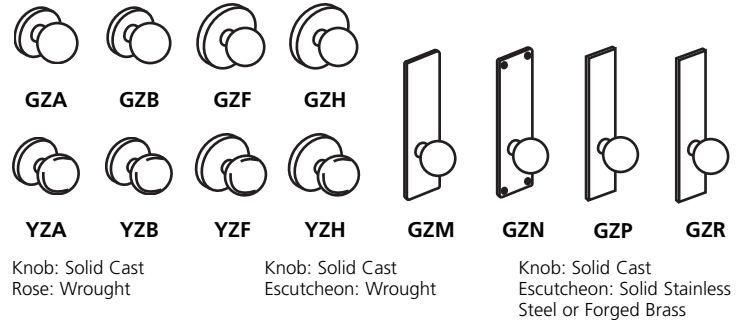

<b>Knobs: GZ, YZ Roses: A, H Roses: B, F (see note 2)</b>	
613E, 626, BSP	605, 606, 611, 612, 613, 618, 619, 625, 722

<b>Knobs: GZ, YZ Escutcheons: M, N, P</b>	
613E, 626, BSP	605, 606, 611, 612, 613, 618, 619, 625, 722

<b>Knobs: GZ, YZ Escutcheons: R (see note 1)</b>	
613E, 626, BSP	605, 606, 611, 612, 613, 618, 619, 625, 722

Function	Model	Description	613E, 626, BSP	605, 606, 611, 612, 613, 618, 619, 625, 722	613E, 626, BSP	605, 606, 611, 612, 613, 618, 619, 625, 722	613E, 626, BSP	605, 606, 611, 612, 613, 618, 619, 625, 722
Non-Keyed	ML2010	Passage	\$854.00	\$878.00	\$874.00	\$898.00	\$908.00	\$932.00
	ML2020	Privacy	\$924.00	\$948.00	\$944.00	\$968.00	\$978.00	\$1,002.00
	ML2030	Privacy						
	ML2060	Privacy	\$910.00	\$934.00	\$930.00	\$954.00	\$964.00	\$988.00
	ML2050	Half Dummy	\$469.00	\$493.00	\$479.00	\$491.00	\$496.00	\$508.00
	ML2070	Full Dummy	\$938.00	\$962.00	\$958.00	\$982.00	\$992.00	\$1,016.00
	ML2080	Half Active Dummy Trim	\$388.00	\$412.00	\$398.00	\$422.00	\$415.00	\$427.00
	ML2090	Full Active Dummy Trim	\$857.00	\$881.00	\$877.00	\$901.00	\$911.00	\$935.00
Single Cylinder	ML2003	Classroom						
	ML2051	Office						
	ML2055	Classroom	\$974.00	\$998.00	\$994.00	\$1,018.00	\$1,028.00	\$1,052.00
	ML2056	Classroom						
	ML2057	Storeroom						
	ML2069	Institution Privacy						
	ML2053	Entrance						
	ML2054	Entrance	\$987.00	\$1,011.00	\$1,007.00	\$1,031.00	\$1,041.00	\$1,065.00
	ML2058	Entrance Holdback						
ML2068	Privacy or Apartment							
Single Cylinder with Deadbolt	ML2024	Entrance						
	ML2048	Entrance						
	ML2049	Storeroom Deadbolt						
	ML2065	Dormitory	\$1,010.00	\$1,034.00	\$1,030.00	\$1,054.00	\$1,064.00	\$1,088.00
	ML2059	Security Storeroom						
	ML2067	Apartment						
	ML2073	Classroom Security						
	ML2075	Entrance/Office						
ML2029	Hotel	\$1,065.00	\$1,089.00	\$1,085.00	\$1,109.00	\$1,119.00	\$1,143.00	
Double Cylinder	ML2002	Classroom Intruder						
	ML2032	Institution						
	ML2042	Entrance	\$1,060.00	\$1,084.00	\$1,080.00	\$1,104.00	\$1,114.00	\$1,138.00
	ML2052	Classroom Intruder						
	ML2087	Security Vestibule					N/A	N/A
Double Cylinder with Deadbolt	ML2022	Store Door						
	ML2062	Intruder Deadbolt						
	ML2072	Classroom Security Intruder	\$1,096.00	\$1,120.00	\$1,116.00	\$1,140.00	\$1,150.00	\$1,174.00
	ML2082	Dormitory						
	ML2092	Security Institution						
Full Working Trim (Quick Code M31) No cylinder; includes thumbturn lever.			\$841.00	\$865.00	\$861.00	\$885.00	\$895.00	\$919.00

**NOTE 1:** "R" Escutcheon trims are available for 1 3/8", 1 3/4", or 2 1/4" door thickness only.

**NOTE 2:** Rose substitutions: 2-1/4" cast rose in place of 2-1/4" wrought rose, substitute letter "B" in place of "A" (e.g. GZB). **Add \$38.00 per lockset.**  
2-7/8" cast rose in place of 2-1/4" wrought rose, substitute letter "F" in place of "A" (e.g. GZF). **Add \$52.00 per lockset.**

**Lever Designs: FSG, MSG, ZSG**



**Frascati**



**Lever: Rose:**  
Cast Cast



**FSG**



**MSG**



**ZSG**

**Merlot**



**Lever Designs: FSL, MSL<sup>1</sup>, ZSL**



**Lever: Escutcheon:**  
Cast Cast



**FSL**



**MSL**



**ZSL**

**Zinfandel**



Function	Description	FSG, MSG, ZSG		FSL, MSL, ZSL		
		613E, 626, BSP	605, 606, 611, 612, 613 <sup>2</sup> , 613L <sup>2</sup> , 618, 619, 625, 722	613E, 626, BSP	605, 606, 611, 612, 613 <sup>2</sup> , 613L <sup>2</sup> , 618, 619, 625, 722	
Non-Keyed	ML2010	Passage	\$811.00	\$835.00	\$865.00	\$889.00
	ML2020	Privacy	\$917.00	\$941.00	\$971.00	\$995.00
	ML2030	Privacy				
	ML2060	Privacy	\$886.00	\$910.00	\$940.00	\$964.00
	ML2050	Half Dummy	\$462.00	\$486.00	\$489.00	\$513.00
	ML2070	Full Dummy	\$924.00	\$948.00	\$978.00	\$1,002.00
	ML2080	Half Active Dummy Trim	\$388.00	\$412.00	\$415.00	\$439.00
	ML2090	Full Active Dummy Trim	\$850.00	\$874.00	\$904.00	\$928.00
Single Cylinder	ML2003	Classroom	\$967.00	\$991.00	\$1,021.00	\$1,045.00
	ML2051	Office				
	ML2055	Classroom				
	ML2056	Classroom Holdback				
	ML2057	Storeroom				
	ML2069	Institution Privacy				
	ML2053	Entrance	\$980.00	\$1,004.00	\$1,034.00	\$1,058.00
	ML2054	Entrance				
ML2058	Entrance Holdback					
ML2068	Privacy or Apartment					
Single Cylinder with Deadbolt	ML2024	Entrance	\$1,003.00	\$1,027.00	\$1,057.00	\$1,081.00
	ML2048	Entrance				
	ML2049	Storeroom Deadbolt				
	ML2059	Dormitory				
	ML2065	Security Storeroom				
	ML2067	Apartment				
	ML2073	Classroom Security				
	ML2075	Entrance/Office				
ML2029	Hotel	\$1,058.00	\$1,082.00	\$1,112.00	\$1,136.00	
Double Cylinder	ML2002	Classroom Intruder	\$1,053.00	\$1,077.00	\$1,107.00	\$1,131.00
	ML2032	Institution				
	ML2042	Entrance				
	ML2052	Classroom Intruder				
	ML2087	Security Vestibule	N/A	N/A		
Double Cylinder with Deadbolt	ML2022	Store Door	\$1,089.00	\$1,113.00	\$1,143.00	\$1,167.00
	ML2062	Intruder Deadbolt				
	ML2072	Classroom Security Intrude				
	ML2082	Dormitory				
	ML2092	Security Institution				
Full Working Trim (Quick Code M31) No cylinder; includes thumbturn lever			\$827.00	\$851.00	\$881.00	\$905.00

Notes: 1. Escutcheon trims are available for 1-3/8", 1-3/4" or 2-1/4" door thicknesses only.  
2. 613 finish is brass base lever & rose/escutcheon

**Deadbolt Only**

Include lockcase, armored front, strike, screw pack, cylinder(s) and thumbturn lever.

**Ordering Example**

Quantity	Series/Function	Trim Design (Escutcheon Type Only)	Finish	Door Thickness
12	ML2013	N	626	D138

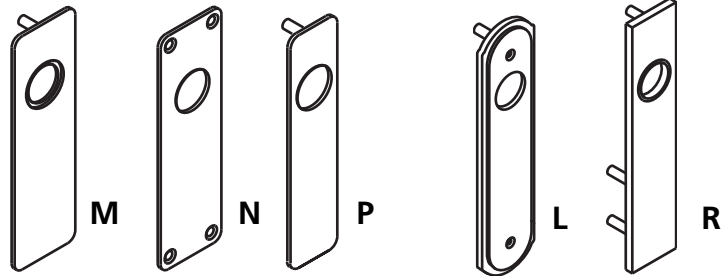

Deadlock No Trim

613E, 626, BSP	605, 606, 611, 612, 613, 618, 619, 625, 629, 630, 722
----------------	---

Wrought

M, N, P	
613E, 626, BSP	605, 606, 611, 612, 613, 618, 619, 625, 629, 630, 722

Solid Stainless Steel or Forged Brass

L, R	
613E, 626, BSP	605, 606, 611, 612, 613, 618, 619, 625, 629, 630, 722

**Function**

Single Cylinder	ML2011	\$385.00	\$391.00	\$441.00	\$447.00	\$513.00	\$519.00
Double Cylinder	ML2012	\$471.00	\$477.00	\$555.00	\$561.00	\$644.00	\$650.00
Cylinder x Thumbturn	ML2013	\$402.00	\$408.00	\$486.00	\$492.00	\$575.00	\$581.00
Classroom Function Cylinder x Thumbturn	ML2017	\$402.00	\$408.00	\$486.00	\$492.00	\$575.00	\$581.00

**NOTE:**

Escutcheon trims are available for 1 3/8", 1 3/4", or 2 1/4" door thickness only

**Vandal Resistant Trim**

**Lever Designs: CSV, NSV**



**Citation**



**Newport**

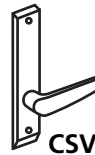

**CSV**



**NSV**

Lever: Cast  
Escutcheon: Cast

**CSV, NSV**

**630**



**Function**

Non-Keyed	ML2010VR	Passage	\$1,325.00
	ML2020VR	Privacy	\$1,431.00
	ML2030VR	Privacy	\$1,400.00
	ML2060VR	Privacy	\$1,400.00
Single Cylinder	ML2051VR	Office	\$1,481.00
	ML2055VR	Classroom	
	ML2056VR	Classroom Holdback	
	ML2057VR	Storeroom	\$1,494.00
	ML2069VR	Institution Privacy	
	ML2053VR	Entrance	
	ML2054VR	Entrance	
ML2058VR	Entrance Holdback		
Single Cylinder with Deadbolt	ML2024VR	Entrance	\$1,517.00
	ML2048VR	Entrance	
	ML2059VR	Security Storeroom	
	ML2065VR	Dormitory	
	ML2067VR	Apartment	
	ML2073VR	Classroom Security	
	ML2075VR	Entrance/Office	
ML2029VR	Hotel	\$1,572.00	
Double Cylinder	ML2032VR	Institution	\$1,567.00
	ML2042VR	Entrance	
	ML2052VR	Classroom Intruder	
	ML2022VR	Store Door	\$1,603.00
	ML2062VR	Intruder Deadbolt	
	ML2072VR	Classroom Security Intruder	
	ML2082VR	Dormitory	
ML2092VR	Security Institution		
Deadlock	ML2011VR	Single Cylinder	\$1,205.00
	ML2013VR	Cylinder x Thumbturn	\$1,205.00
	ML2017VR	Double Cylinder	\$1,291.00
	ML2012VR	Double Cylinder	\$1,291.00
Full Working Trim (Quick Code M31) No cylinder; includes thumbturn lever			\$1,133.00

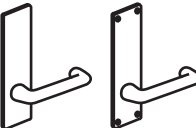
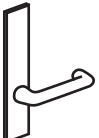
NOTE:  
Escutcheon trims are available for 1 3/4", 2", or 2 1/4" door thickness only

			 <b>LWA    RWA</b> Lever: Wrought Rose: Wrought		 <b>LWM    LWN</b> Lever: Wrought Escutcheon: Wrought		 <b>LWR</b> Lever: Wrought Escutcheon: Solid Stainless Steel or Forged Brass	
			<b>Levers: LW, RW</b> <b>Roses: A</b> Roses: B, F (see note 1)		<b>Levers: LW, RW</b> <b>Escutcheons: M, N</b>		<b>Levers: LW, RW</b> <b>Escutcheons: R</b> (see note 2)	
Description	Function	Option (See Note 3)	613E, 626, BSP	605, 606, 611, 612, 613, 618, 619, 625, 629, 630, 722	613E, 626, BSP	605, 606, 611, 612, 613, 618, 619, 625, 629, 630, 722	613E, 626, BSP	605, 606, 611, 612, 613, 618, 619, 625, 629, 630, 722
Single Cylinder	ML20914	Fail Safe/Fail Secure	\$988.00	\$1,012.00	\$1,008.00	\$1,032.00	\$1,062.00	\$1,086.00
	ML20906							
No Cylinder Override	ML20907	Fail Safe/Fail Secure	\$902.00	\$926.00	\$922.00	\$946.00	\$976.00	\$1,000.00
	ML20915							
Double Cylinder	ML20932	Fail Safe/Fail Secure	\$1,074.00	\$1,098.00	\$1,094.00	\$1,118.00	\$1,148.00	\$1,172.00
	ML20987						N/A	N/A

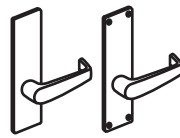
			 <b>ASA    CSA    LSA</b> Lever: Cast Rose: Wrought		 <b>NSM    NSN</b> Lever: Cast Escutcheon: Wrought		 <b>NSR</b> Lever: Cast Escutcheon: Solid Stainless Steel or Forged Brass	
			<b>Levers: AS, CS, LS, NS, PS, RS</b> <b>Roses: A</b> Roses: B, F (see note 1)		<b>Levers: AS, CS, LS, NS, PS, RS</b> <b>Escutcheons: M, N</b>		<b>Levers: AS, CS, LS, NS, PS, RS</b> <b>Escutcheons: R</b> (see note 2)	
Description	Function	Option (See Note 3)	613E, 626, BSP	605, 606, 611, 612, 613, 618, 619, 625, 629, 630, 722	613E, 626, BSP	605, 606, 611, 612, 613, 618, 619, 625, 629, 630, 722	613E, 626, BSP	605, 606, 611, 612, 613, 618, 619, 625, 629, 630, 722
Single Cylinder	ML20914	Fail Safe/Fail Secure	\$1,159.00	\$1,183.00	\$1,179.00	\$1,203.00	\$1,213.00	\$1,237.00
	ML20906							
No Cylinder Override	ML20907	Fail Safe/Fail Secure	\$1,073.00	\$1,097.00	\$1,093.00	\$1,117.00	\$1,127.00	\$1,151.00
	ML20915							
Double Cylinder	ML20932	Fail Safe/Fail Secure	\$1,245.00	\$1,269.00	\$1,265.00	\$1,289.00	\$1,299.00	\$1,323.00
	ML20987						N/A	N/A

NOTES:  
 1 - Rose substitutions for LWA, LSA, etc.: 2-1/4" cast rose in place of 2-1/4" wrought rose, substitute letter "B" in place of "A" (e.g. LSB). Add \$38.00 per lockset.  
 2-7/8" cast rose in place of 2-1/4" wrought rose, substitute letter "F" in place of "A" (e.g. LWF). Add \$52.00 per lockset.  
 2 - "R" Escutcheon trims are available for 1 3/8", 1 3/4" or 2 1/4" door thickness only.  
 3. Must Specify: SAF for Fail Safe or SEC for Fail Secure.

 **ElectroLynx®**  
 As part of their promise to provide innovative, fast and effective high security solutions to their customers, certain ASSA ABLOY Group brands offer *ElectroLynx®*, a universal quick-connect system that simplifies the electrification of the door opening.

# Electrified Mortise Lock with High Security Monitoring ML20600 Series NAC

January 1, 2019

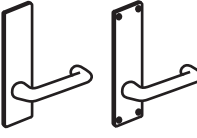
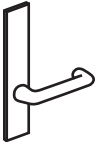
			 <p><b>LWA RWA</b></p> <p>Lever: Wrought Rose: Wrought</p>		 <p><b>LWM LWN</b></p> <p>Lever: Wrought Escutcheon: Wrought</p>		 <p><b>LWR</b></p> <p>Lever: Wrought Escutcheon: Solid Stainless Steel or Forged Brass</p>	
			<p><b>Levers: LW, RW Roses: A Roses: B, F (see note 1)</b></p>		<p><b>Levers: LW, RW Escutcheons: M, N</b></p>		<p><b>Levers: LW, RW Escutcheons: R (see note 2)</b></p>	
Description	Function	Option (See Note 3)	613E, 626, BSP	605, 606, 611, 612, 613, 618, 619, 625, 629, 630, 722	613E, 626, BSP	605, 606, 611, 612, 613, 618, 619, 625, 629, 630, 722	613E, 626, BSP	605, 606, 611, 612, 613, 618, 619, 625, 629, 630, 722
Single Cylinder	ML20606 x NAC	Fail Safe/Fail Secure	\$1,163.00	\$1,187.00	\$1,183.00	\$1,207.00	\$1,237.00	\$1,261.00
	ML20608 x NAC		\$1,238.00	\$1,262.00	\$1,258.00	\$1,282.00	\$1,312.00	\$1,336.00
No Cylinder Override	ML20607 x NAC	Fail Safe/Fail Secure	\$1,077.00	\$1,101.00	\$1,097.00	\$1,121.00	\$1,151.00	\$1,175.00
	ML20609 x NAC		\$1,152.00	\$1,176.00	\$1,172.00	\$1,196.00	\$1,226.00	\$1,250.00

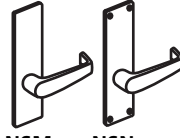
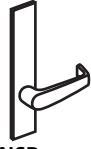
			 <p><b>ASA CSA LSA</b></p>			 <p><b>NSM NSN</b></p>		 <p><b>NSR</b></p>	
			<p>Lever: Cast Rose: Wrought</p>			<p>Lever: Cast Escutcheon: Wrought</p>		<p>Lever: Cast Escutcheon: Solid Stainless Steel or Forged Brass</p>	
			<p><b>Levers: AS, CS, LS, NS, PS, RS Roses: A Roses: B, F (see note 1)</b></p>			<p><b>Levers: AS, CS, LS, NS, PS, RS Escutcheons: M, N</b></p>		<p><b>Levers: AS, CS, LS, NS, PS, RS Escutcheons: R (see note 2)</b></p>	
Description	Function	Option (See Note 3)	613E, 626, BSP	605, 606, 611, 612, 613, 618, 619, 625, 629, 630, 722	613E, 626, BSP	605, 606, 611, 612, 613, 618, 619, 625, 629, 630, 722	613E, 626, BSP	605, 606, 611, 612, 613, 618, 619, 625, 629, 630, 722	
Single Cylinder	ML20606 x NAC	Fail Safe/Fail Secure	\$1,334.00	\$1,358.00	\$1,354.00	\$1,378.00	\$1,388.00	\$1,412.00	
	ML20608 x NAC		\$1,409.00	\$1,433.00	\$1,429.00	\$1,453.00	\$1,463.00	\$1,487.00	
No Cylinder Override	ML20607 x NAC	Fail Safe/Fail Secure	\$1,073.00	\$1,097.00	\$1,268.00	\$1,292.00	\$1,302.00	\$1,326.00	
	ML20609 x NAC		\$1,148.00	\$1,172.00	\$1,343.00	\$1,367.00	\$1,377.00	\$1,401.00	

**NOTES:**

- 1 - Rose substitutions for LWA, LSA, etc.: 2-1/4" cast rose in place of 2-1/4" wrought rose, substitute letter "B" in place of "A" (e.g. LSB). Add \$38.00 per lockset.
- 2-7/8" cast rose in place of 2-1/4" wrought rose, substitute letter "F" in place of "A" (e.g. LWF). Add \$52.00 per lockset.
- 2 - "R" Escutcheon trims are available for 1 3/8", 1 3/4" or 2 1/4" door thickness only.
- 3. Must Specify: SAF for Fail Safe or SEC for Fail Secure.



**ElectroLynx®**

As part of their promise to provide innovative, fast and effective high security solutions to their customers, certain ASSA ABLOY Group brands offer *ElectroLynx®*, a universal quick-connect system that simplifies the electrification of the door opening.



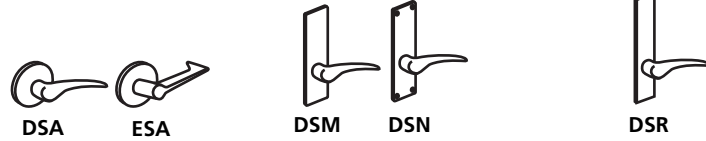

Lever: Cast  
Rose: Wrought

Lever: Cast  
Escutcheon: Wrought

Lever: Cast  
Escutcheon: Solid Stainless Steel  
or Forged Brass

Description	Function	Option (See Note 3)	Lever: DS, ES Roses: A Roses: B, F (see note 1)		Lever: DS, ES Escutcheons: M, N		Lever: DS, ES Escutcheons: R (see note 2)	
			613E, 626, BSP	605, 606, 611, 612, 613, 618, 619, 625, 629, 630, 722	613E, 626, BSP	605, 606, 611, 612, 613, 618, 619, 625, 629, 630, 722	613E, 626, BSP	605, 606, 611, 612, 613, 618, 619, 625, 629, 630, 722
Single Cylinder	ML20914	Fail Safe/Fail Secure	\$1,185.00	\$1,209.00	\$1,205.00	\$1,229.00	\$1,239.00	\$1,263.00
	ML20906							
No Cylinder Override	ML20907	Fail Safe/Fail Secure	\$1,099.00	\$1,123.00	\$1,119.00	\$1,143.00	\$1,153.00	\$1,177.00
	ML20915							
Double Cylinder	ML20932	Fail Safe/Fail Secure	\$1,271.00	\$1,295.00	\$1,291.00	\$1,315.00	\$1,325.00	\$1,349.00
	ML20987	Security Vestibule					N/A	N/A

**NOTES:**

- 1 - Rose substitutions for DSA, ESA: 2-1/4" cast rose in place of 2-1/4" wrought rose, substitute letter "B" in place of "A" (e.g.DSB). **Add \$38.00 per lockset.**  
2-7/8" cast rose in place of 2-1/4" wrought rose, substitute letter "F" in place of "A" (e.g. ESF). **Add \$52.00 per lockset.**
- 2 - "R" Escutcheon trims are available for 1 3/8", 1 3/4", or 2 1/4" door thickness only.
- 3. Must Specify: SAF for Fail Safe or SEC for Fail Secure.

**Lever Designs: CSV, NSV**

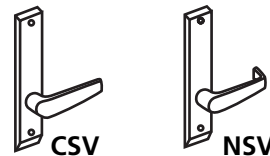

Lever: Cast  
Escutcheon: Cast

Description	Function	Option (See Note 3)	CSV, NSV	
			Finish: 630	
Single Cylinder	ML20914	Fail Safe/Fail Secure	\$1,618.00	
	ML20906			
No Cylinder Override	ML20907	Fail Safe/Fail Secure	\$1,532.00	
	ML20915			
Double Cylinder	ML20932	Fail Safe/Fail Secure	\$1,704.00	

**Note:**

- Escutcheon trims are available for 1 3/8", 1 3/4", or 2 1/4" door thickness only.
- 3. Must Specify: SAF for Fail Safe or SEC for Fail Secure.



**ElectroLynx®**

As part of their promise to provide innovative, fast and effective high security solutions to their customers, certain ASSA ABLOY Group brands offer ElectroLynx®, a universal quick-connect system that simplifies the electrification of the door opening.

# Electrified Mortise Lock with High Security Monitoring ML20600 Series NAC

January 1, 2019



Lever: Cast  
Rose: Wrought

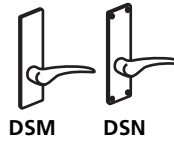

Lever: Cast  
Escutcheon: Wrought



Lever: Cast  
Escutcheon: Solid Stainless Steel  
or Forged Brass

Description	Function	Option (See Note 3)	Lever: DS, ES Roses: A Roses: B, F (see note 1)		Lever: DS, ES Escutcheons: M, N		Lever: DS, ES Escutcheons: R (see note 2)	
			613E, 626, BSP	605, 606, 611, 612, 613, 618, 619, 625, 629, 630, 722	613E, 626, BSP	605, 606, 611, 612, 613, 618, 619, 625, 629, 630, 722	613E, 626, BSP	605, 606, 611, 612, 613, 618, 619, 625, 629, 630, 722
Single Cylinder	ML20606 x NAC	Fail Safe/Fail Secure	\$1,360.00	\$1,384.00	\$1,380.00	\$1,404.00	\$1,414.00	\$1,438.00
	ML20608 x NAC		\$1,435.00	\$1,459.00	\$1,455.00	\$1,479.00	\$1,489.00	\$1,513.00
No Cylinder Override	ML20607 x NAC	Fail Safe/Fail Secure	\$1,274.00	\$1,298.00	\$1,294.00	\$1,318.00	\$1,328.00	\$1,352.00
	ML20609 x NAC		\$1,349.00	\$1,373.00	\$1,369.00	\$1,393.00	\$1,403.00	\$1,427.00

**NOTES:**

- 1 - Rose substitutions for DSA, ESA: 2-1/4" cast rose in place of 2-1/4" wrought rose, substitute letter "B" in place of "A" (e.g.DSB). **Add \$38.00 per lockset.**  
2-7/8" cast rose in place of 2-1/4" wrought rose, substitute letter "F" in place of "A" (e.g. ESF). **Add \$52.00 per lockset.**
- 2 - "R" Escutcheon trims are available for 1 3/8", 1 3/4", or 2 1/4" door thickness only.
- 3. Must Specify: SAF for Fail Safe or SEC for Fail Secure.

**Lever Designs: CSV, NSV**

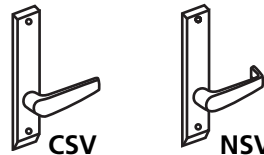

Lever: Cast  
Escutcheon: Cast

Description	Function	Option (See Note 3)	CSV, NSV	
			Finish: 630	
Single Cylinder	ML20606 x NAC	Fail Safe/Fail Secure	\$1,793.00	
	ML20608 x NAC		\$1,868.00	
No Cylinder Override	ML20607 x NAC	Fail Safe/Fail Secure	\$1,707.00	
	ML20609 x NAC		\$1,782.00	

- Note:  
Escutcheon trims are available for 1 3/8", 1 3/4", or 2 1/4" door thickness only.
- 3. Must Specify: SAF for Fail Safe or SEC for Fail Secure.



**ElectroLynx®**  
As part of their promise to provide innovative, fast and effective high security solutions to their customers, certain ASSA ABLOY Group brands offer ElectroLynx®, a universal quick-connect system that simplifies the electrification of the door opening.

**Lever Designs: FSG, MSG, ZSG**



Frascati



**Lever: Rose:**  
Cast Cast



FSG



MSG



ZSG

Merlot



**Lever Designs: FSL, MSL, ZSL**



Zinfandel



**Lever: Escutcheon:**  
Cast Cast



FSL



MSL



ZSL

Description	Function	Option (See Note 3)	FSG, MSG, ZSG		FSL, MSL, ZSL	
			Finish: 613E, 626, BSP	Finish: 605, 606, 611, 612, 613 <sup>2</sup> , 613L <sup>2</sup> , 618, 619, 625, 722	Finish: 613E, 626, BSP	Finish: 605, 606, 611, 612, 613 <sup>2</sup> , 613L <sup>2</sup> , 618, 619, 625, 722
Single Cylinder	ML20914	Fail Safe/Fail Secure	\$1,185.00	\$1,209.00	\$1,239.00	\$1,263.00
	ML20906					
No Cylinder Override	ML20907	Fail Safe/Fail Secure	\$1,099.00	\$1,123.00	\$1,153.00	\$1,177.00
	ML20915					
Double Cylinder	ML20932	Fail Safe/Fail Secure	\$1,271.00	\$1,295.00	\$1,325.00	\$1,349.00

Notes:

1. Escutcheon trims are available for 1-3/8", 1-3/4" or 2-1/4" door thicknesses only.
2. 613 finish is brass base lever & rose/escutcheon.
3. Must Specify: SAF for Fail Safe or SEC for Fail Secure



**ElectroLynx®**

As part of their promise to provide innovative, fast and effective high security solutions to their customers, certain ASSA ABLOY Group brands offer *ElectroLynx®*, a universal quick-connect system that simplifies the electrification of the door opening.

**Lever Designs: FSG, MSG, ZSG**



Frascati



**Lever: Rose:**  
Cast Cast



FSG



MSG



ZSG

Merlot



**Lever Designs: FSL, MSL, ZSL**



Zinfandel



**Lever: Escutcheon:**  
Cast Cast



FSL



MSL



ZSL

Description	Function	Option (See Note 3)	FSG, MSG, ZSG		FSL, MSL, ZSL	
			Finish: 613E, 626, BSP	Finish: 605, 606, 611, 612, 613 <sup>2</sup> , 613L <sup>2</sup> , 618, 619, 625, 722	Finish: 613E, 626, BSP	Finish: 605, 606, 611, 612, 613 <sup>2</sup> , 613L <sup>2</sup> , 618, 619, 625, 722
Single Cylinder	ML20606 x NAC	Fail Safe/Fail Secure	\$1,360.00	\$1,384.00	\$1,380.00	\$1,404.00
	ML20608 x NAC		\$1,435.00	\$1,459.00	\$1,455.00	\$1,479.00
No Cylinder Override	ML20607 x NAC	Fail Safe/Fail Secure	\$1,274.00	\$1,298.00	\$1,294.00	\$1,318.00
	ML20609 x NAC		\$1,349.00	\$1,373.00	\$1,369.00	\$1,393.00

Notes:

1. Escutcheon trims are available for 1-3/8", 1-3/4" or 2-1/4" door thicknesses only.
2. 613 finish is brass base lever & rose/escutcheon.
3. Must Specify: SAF for Fail Safe or SEC for Fail Secure



**ElectroLynx®**

As part of their promise to provide innovative, fast and effective high security solutions to their customers, certain ASSA ABLOY Group brands offer *ElectroLynx®*, a universal quick-connect system that simplifies the electrification of the door opening.

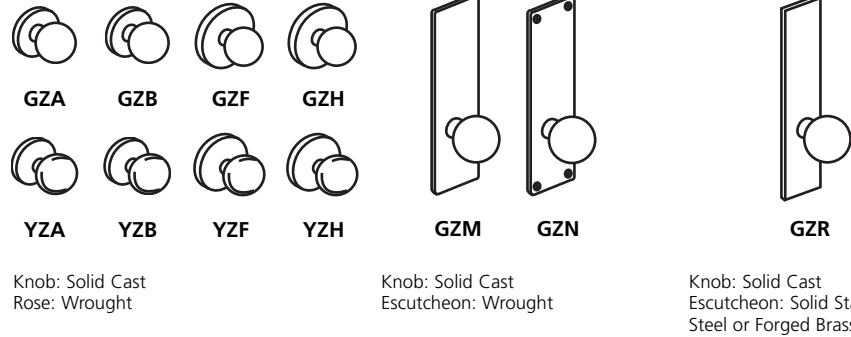

<b>Knobs: GZ, YZ</b> <b>Roses: A, H</b> <b>Roses: B, F (see note 2)</b>	
613E, 626, BSP	605, 606, 611, 612, 613, 618, 619, 625, 722

<b>Knobs: GZ, YZ</b> <b>Escutcheons: M, N</b>	
613E, 626, BSP	605, 606, 611, 612, 613, 618, 619, 625, 722

<b>Knobs: GZ, YZ</b> <b>Escutcheons: R (see note 1)</b>	
613E, 626, BSP	605, 606, 611, 612, 613, 618, 619, 625, 722

Description	Function	Option (See Note 3)	Knobs: GZ, YZ Roses: A, H Roses: B, F (see note 2)		Knobs: GZ, YZ Escutcheons: M, N		Knobs: GZ, YZ Escutcheons: R (see note 1)	
			613E, 626, BSP	605, 606, 611, 612, 613, 618, 619, 625, 722	613E, 626, BSP	605, 606, 611, 612, 613, 618, 619, 625, 722	613E, 626, BSP	605, 606, 611, 612, 613, 618, 619, 625, 722
Single Cylinder	ML20914	Fail Safe/ Fail Secure	\$1,192.00	\$1,216.00	\$1,212.00	\$1,236.00	\$1,246.00	\$1,270.00
	ML20906							
No Cylinder Override	ML20907	Fail Safe/ Fail Secure	\$1,106.00	\$1,130.00	\$1,126.00	\$1,150.00	\$1,160.00	\$1,184.00
	ML20915							
Double Cylinder	ML20932	Fail Safe/ Fail Secure	\$1,278.00	\$1,302.00	\$1,298.00	\$1,322.00	\$1,332.00	\$1,356.00
	ML20987						N/A	N/A

**NOTE 1:** "R" Escutcheon trims are available for 1 3/8", 1 3/4", or 2 1/4" door thickness only.

**NOTE 2:** Rose substitutions: 2-1/4" cast rose in place of 2-1/4" wrought rose, substitute letter "B" in place of "A" (e.g. GZB). **Add \$38.00 per lockset.**  
2-7/8" cast rose in place of 2-1/4" wrought rose, substitute letter "F" in place of "A" (e.g. GZF). **Add \$52.00 per lockset.**

**NOTE 3:** Must Specify: SAF for Fail Safe or SEC for Fail Secure.



**ElectroLynx®**

As part of their promise to provide innovative, fast and effective high security solutions to their customers, certain ASSA ABLOY Group brands offer *ElectroLynx®*, a universal quick-connect system that simplifies the electrification of the door opening.

## Fail Safe/Fail Secure

Description	Specify Quick Code
Fail Safe	SAF
Fail Secure	SEC

## Electrified Options for ML20900

Description	Specify Quick Code	Add or Deduct
Latchbolt Monitor	M91	\$188.00
Request to Exit (REX)	M92	\$186.00
Security monitor	M105	\$327.00
Latchbolt monitor x request to exit	M91 x M92	\$374.00
Request to Exit x security monitor	M92 x M105	\$513.00

## Accessories

Part No.	Description	Add or Deduct
BPS-24-1	Power Supply 24V 1 AMP	\$327.00
BPS-12-1	Power Supply 12V 1 AMP	
BPS-24-2	Power Supply 24V 2 AMP	\$664.00
BPS-12-3	Power Supply 12V 3 AMP	

## ML20600 High Security Monitoring Options

## EcoFlex® Mortise Lock End-of-Line Resistors and Deadbolt Privacy Options

Description	Specify Quick Code	Add or Deduct
Mercury and Lenel compatible 1KΩ/2KΩ resistance supervision	R01	Add \$100.00 per lockset
Software House compatible 1KΩ/2KΩ resistance supervision	R03	Add \$100.00 per lockset
AMAG compatible 4-state supervision	R04	Add \$100.00 per lockset
Deadbolt Privacy Function	PHR	Add \$100.00 per lockset
Deadbolt Privacy and Mercury / Lenel 1KΩ/2KΩ	PHRR01	Add \$200.00 per lockset
Deadbolt Privacy and Software House 1KΩ/2KΩ	PHRR03	Add \$200.00 per lockset
Deadbolt Privacy and AMAG 4-State	PHRR04	Add \$200.00 per lockset



### ElectroLynx®

As part of their promise to provide innovative, fast and effective high security solutions to their customers, certain ASSA ABLOY Group brands offer *ElectroLynx*®, a universal quick-connect system that simplifies the electrification of the door opening.

**Lock Only**

Includes lockcase, armored front, strike and screw pack. Cylinder(s) and thumbturn lever are not included.

**Ordering Example**

Quantity	Series/Function	Trim See Key Below	Finish	Door Thickness	Optional Strike
12	ML2055	LL	626	D138	SS078

Trim Key					
KK	Knob x Knob	LK	Lever x Knob	HL	Lever Inside only
LL	Lever x Lever	KL	Knob x Lever	HK	Knob inside Only

Function	Description	LL, LK, KL, HL, HK <sup>2</sup> , KK <sup>2</sup>		
		Available in all listed mortise trim finishes		
Non-Keyed	ML2010	Passage	\$364.00	
	ML2020	Privacy	\$438.00	
	ML2030	Privacy		
	ML2060	Privacy		
Single Cylinder	ML2051	Office	\$402.00	
	ML2003	Classroom	\$415.00	
	ML2053	Entrance		
	ML2054	Entrance	\$415.00	
	ML2055	Classroom	\$402.00	
	ML2056	Classroom Holdback		
	ML2057	Storeroom		
	ML2058	Entrance Holdback	\$415.00	
	ML2068	Privacy and Apartment	\$402.00	
ML2069	Institution Privacy			
Single Cylinder with Deadbolt	ML2024	Entrance	\$438.00	
	ML2048	Entrance		
	ML2059	Security Storeroom		
	ML2065	Dormitory		
	ML2067	Apartment		
	ML2073	Classroom Security		
	ML2075	Entrance/Office		
ML2029	Hotel	\$447.00		
Double Cylinder	ML2002	Classroom Intruder	\$402.00	
	ML2022	Store Door		
	ML2032	Institution		
	ML2042	Entrance		
	ML2052	Classroom Intruder		
	ML2062	Intruder Deadbolt		
	ML2072	Classroom Security Intruder		
	ML2082	Dormitory		
	ML2087	Security Institution		
Single Cylinder	ML20914	Fail Safe/Fail Secure	\$620.00	
	ML20906			
No Cylinder Override	ML20907	Fail Safe/Fail Secure		
	ML20915			
Double Cylinder	ML20932	Fail Safe/Fail Secure		
	ML20987	Security Vestibule		
No Cylinder Override	ML20833	Without key override		\$770.00
Single Cylinder	ML20834	With key override		
Deadbolt without key override	ML20835	Deadbolt without key override		
Single Cylinder with deadbolt	ML20836	Deadbolt with key override		

**Conversion Kits**

Part Number	Description	Price
683F34	Knob operation to lever operation <sup>1</sup>	\$44.00

 Notes: 1. Kits contain internal lock parts only. Order knobs, spindles, escutcheons, cylinders and collars separately.  
 2. For master ring, specify quick code MR-LC. Add \$20.00. Not available for ML20900 series.

### Cylinder & Keying Options

Description	Specify Quick Code	Add or Deduct
Conventional 6-pin	(standard)	No Charge
Conventional 7-pin	7P	Add \$2.00 per cylinder
Less Standard Cylinder	LC	Deduct \$86.00 per cylinder
Less Hotel Cylinder	LC	Deduct \$124.00 per cylinder
Less Master Ring Cylinder <sup>3</sup>	MR-LC	Deduct \$40.00 per cylinder
Less Concealed Shell Cylinder	PO-LC	Add \$5.00 per lockset
Access 3 Patented	AP	No Charge
Access 3 Security	AS	Add \$56.00 per cylinder
Access 3 High Security, UL 437	AHS	Add \$79.00 per cylinder
Access 3 IC Patented	ACP	Add \$74.00 per cylinder
Access 3 IC Security	ACS	Add \$123.00 per cylinder
Access 3 IC High Security, UL 437	ACHS	Add \$143.00 per cylinder
Pyramid Security Fixed Core <sup>2</sup>	PS	Add \$58.00 per cylinder
Pyramid Security IC <sup>2</sup>	PCS	Add \$129.00 per cylinder
Pyramid High Security Fixed Core <sup>2</sup>	PHS	Add \$86.00 per cylinder
Pyramid High Security IC <sup>2</sup>	PCHS	Add \$158.00 per cylinder
Pyramid IC with Temporary Construction Core <sup>2,4</sup>	CTP	Add \$74.00 per cylinder
Pyramid IC with Temporary Disposable Core <sup>2,4</sup>	CTPD	No Charge
Pyramid IC Less Core <sup>2</sup>	CLP	No Charge
Security <sup>5</sup>	HS	Add \$111.00 per cylinder
Security IC <sup>1,5</sup>	CHS	Add \$183.00 per cylinder
Blockout Function Cylinder	BO	Add \$105.00 per cylinder
IC 6-pin	C6	Add \$74.00 per cylinder
IC 6-pin with Temporary Construction Core (Red)	CT6R	Add \$74.00 per cylinder
IC 6-pin with Temporary Construction Core (Blue)	CT6B	Add \$74.00 per cylinder
IC 6-pin with Temporary Construction Core (Green)	CT6G	Add \$74.00 per cylinder
IC 6-pin with Temporary Disposable Core	CT6D	No Charge
IC 6-pin Less Core	CL6	No Charge
SFIC 6-pin with Less Core <sup>2</sup>	CLS6	No Charge
IC 6-pin with SFIC disposable temporary core <sup>2</sup>	CT6SD	No Charge
IC 7-pin <sup>2</sup>	C7	Add \$76.00 per cylinder
IC 7-pin with Temporary Construction Core (Red) <sup>2</sup>	CT7R	Add \$76.00 per cylinder
IC 7-pin with Temporary Construction Core (Blue) <sup>2</sup>	CT7B	Add \$76.00 per cylinder
IC 7-pin with Temporary Construction Core (Green) <sup>2</sup>	CT7G	Add \$76.00 per cylinder
IC 7-pin with Temporary Disposable Core <sup>2</sup>	CT7D	Add \$2.00 per cylinder
IC 7-pin Less Core <sup>2</sup>	CL7	Add \$2.00 per cylinder
SFIC 7-pin with Less Core <sup>2</sup>	CLS7	Add \$2.00 per cylinder
IC 7-pin with SFIC disposable temporary core <sup>2</sup>	CT7SD	Add \$2.00 per cylinder
Master Ring <sup>3</sup>	MR	Add \$67.00 per cylinder
Flex Head Cylinder, 6-pin (sectional trim)	FX6	Add \$71.00 per cylinder
Flex Head Cylinder, 7-pin (sectional trim)	FX7	Add \$73.00 per cylinder
Flex Head Master Ring (sectional trim)	FXM	Add \$118.00 per cylinder
Plug only to show, 6-pin (concealed shell) (available for M and R escutcheons and single cylinder functions only)	P06	Add \$88.00 per lockset
Plug only to show, 7-pin (concealed shell) (available for M and R escutcheons and single cylinder functions only)	P07	Add \$90.00 per lockset
Laser Engraving	LASER	Add \$20.00 per lockset

**Notes:**

1. CHS ordered with CT6 option no charge.
2. Pyramid series and IC-7 pin are not available in ML2029 function.
3. Available for "M" escutcheon and sectional trim only. Not available for 17, 29 or 32 functions, and ECL functions. Not available for ML20900 series.
4. Refer to Key construction core program, pg. 63 for example of CTP option pricing.
5. For existing systems only.



**Cylinder & Keying Options\* (con't)**

Description	Specify Quick Code	Add or Deduct
0-Bitted with two blank keys <sup>5</sup>	(standard)	No Charge
Keyed Random <sup>4</sup>	KR	No Charge
Master keyed (all cylinders except 8000, 8020, 8027 IC core)	specify keyset	Add \$16.00 per cylinder
Master keyed Pyramid	specify keyset	Add \$16.00 per cylinder
Master keyed Security (including IC cylinder and core)	specify keyset	Add \$16.00 per cylinder
Master keyed (8000, 8020, 8027 IC core)	specify keyset	No Charge
Master keyed to customer bittings or sample key	specify keyset	Add \$16.00 per cylinder
Construction master keyed <sup>1,2</sup>	CMK	Add \$16.00 per cylinder
Visual key control (VKC)		
- No Stamping	VKC0	\$4.50
- Keys only	VKC1	No Charge
- Cylinders and Keys <sup>3</sup>	VKC2	\$8.00
- Cylinders only <sup>3</sup>	VKC3	\$8.00
Concealed key control (CKC)		
- CKC cylinders with VKC keys	CKC2	\$8.00
- CKC cylinders only <sup>3</sup>	CKC3	\$8.00
More than 2 keys per lock	KY# (e.g., KY6)	See page 66 - Cut Keys Section

\*Double Cylinder Keying: Unless otherwise specified, both cylinders of ML2012, 2022, 2032, 2052, 2062, 2072, 2082, 2092 function locks will be keyed alike. The inside cylinder of 42 function locks will be keyed to the master key(s) only, while the outside cylinder will include the change key. If different is required, specify outside cylinder first, then inside cylinder. For key bows other than 10 and 90, specify "KB" + bow number as Quick Code, e.g. KB12. No extra charge.

**Notes:**

1. CMK Construction master keying charge is in addition to master keying charge.
2. CMK Construction master keying is not available in Pyramid series cylinders.
3. VKC2, VKC3, CKC3 are not available in Pyramid or Security series.
4. Pyramid series is not available keyed random.
5. Security series is not available 0-bitted.

**Strike Options\***

(To purchase strike separately, see catalog or parts manual for part no.)

Lip Length	ANSI Straight Lip - Specify Quick Code	ANSI Curved Lip - Specify Quick Code	Add or Deduct
7/8"	SS078	N/A	No Charge
1-1/8"	(standard)	N/A	
1-1/4"	SS114	SA114	
1-3/8"	SS138	SA138	
1-1/2"	SS112	SA112	
1-3/4"	SS134	SA134	Add \$16.00 per lockset
2"	SS200	SA200	
2-1/4"	SS214	SA214	
2-1/2"	SS212	SA212	
2-3/4"	SS234	SA234	
3"	SS300	SA300	

Description	Door Thickness	Specify Quick Code	Add or Deduct
Open Back Strike	1-3/4"	SB134	Add \$82.00 per lockset
Open Back Strike	2"	SB200	Add \$124.00 per lockset
Open Back Strike	2-1/4"	SB214	
Rabbeted front and strike		SR118	Add \$86.00 per lockset

\* If door thickness is standard or has been specified and no special door or frame condition exist, then only the first two characters of the optional strike Quick Code must be specified (e.g. "SA"). The correct lip length will be determined by our order entry system based on the standard or specified door thickness.

**Door Thickness with Locksets Mortised on Center**

(Note: Door thickness with panel not to exceed 2" from centerline of lock.)

Door Thickness	Sectional Rose Trim Specify Quick Code	Escutcheon <sup>1,2</sup> Trim Specify Quick Code	Add or Deduct
1-3/4" (standard)	—	—	No Charge
1-3/8"	D138	D138	Add \$56
1-7/8"	D178	N/A	No Charge
2"	D200	D200	
2-1/8"	D218	N/A	
2-1/4"	D214	D214	
2-3/8"	D238	D238	Add \$92.00 per lockset
2-1/2"	D212	D212	
2-5/8"	D258	D258	
2-3/4"	D234	D234	
2-7/8"	D278	D278	
3"	D300	D300	
3-1/8"	D318	D318	
3-1/4"	D314	D314	
3-3/8"	D338	D338	
3-1/2"	D312	D312	
3-5/8"	D358	D358	
3-3/4"	D334	D334	
3-7/8"	D378	D378	
4"	D400	D400	

**Notes:**

- For 2-3/8" to 4" door thickness: throughbolts and thumbturn lever spindle for 4" door will be provided. Throughbolts and spindles may be field cut.
- "VR" and "T" escutcheons are only available for 1-3/8", 1-3/4" and 2-1/4" door thicknesses.

**Panel Applications**

Specify Quick Code	Description	Add or Deduct
PNL1	Centerline of lockcase to edge of panel not to exceed 2"	Add \$92.00 per lockset

**Note:**

- When ordering, specify door thickness (less panel), panel thickness, and side of door panel will be applied (outside or inside).

**Custom Laser Engraving- LASER**
**Laser engraving processing charge (all engraving types)**

- \$250 net per order. Charge will be applied to production order when placed.

**Single Vanity, Logo or Other (same engraving on all parts)**

- Lever - \$10 net add each
- Mortise Escutcheon - \$10 net add each
- HPSK Paddle - \$10 net add each

**Unique laser engraving (i.e. Room Number, Apartment Number, etc)**

- \$12 net add each (per piece)

**Miscellaneous Options**

Description	Specify Quick Code	Add or Deduct
Split designs and split finishes	Outside Trim x Inside Trim	Higher set price prevails
Spanner head screws	M02	Add \$18.00 per lockset
Torx® head screws (n/a with N escutcheon)	M04	Add \$24.00 per lockset
ANSI wrought strike box	M17	No Charge
Occupancy indicator (hotel function only)	M19	No Charge
Single Occupancy Indicator - Secure/Unsecure (Outside)	M19S*	Add \$88.00 per lockset
Single Occupancy Indicator - Vacant/Occupied (Outside)	M19V*	Add \$88.00 per lockset
Single Occupancy Indicator - Secure/Unsecure (Inside)	M19N*	Add \$88.00 per lockset
Double Occupancy Indicator - Secure/Unsecure (Outside)	M19SN*	Add \$168.00 per lockset
Double Indicator Vacant/Occupied (Outside)	M19VN*	Add \$168.00 per lockset
Secure/Unsecure (Inside)		
Knurling outside and inside	M20 <sup>1</sup>	Add \$137.00 per lockset
Knurling outside only	M21 <sup>1</sup>	Add \$69.00 per lockset
Knurling inside only	M22 <sup>1</sup>	Add \$69.00 per lockset
Abrasive coat outside and inside	M23 <sup>1</sup>	Add \$85.00 per lockset
Abrasive coat inside only	M24 <sup>1</sup>	Add \$43.00 per lockset
Abrasive coat outside only	M25 <sup>1</sup>	Add \$43.00 per lockset
Non-ferrous lockcase	M26	Add \$250.00 per lockset
Lead wrapped case	M29	Add \$265.00 per lockset
Half trim (for ML2010, ML2020, ML2022, ML2024, ML2029, ML2030, ML2032, ML2052, ML2053, ML2055, ML2056, ML2057, ML2058, ML2059, ML2062, ML2065 only) supplied with inside trim only	M30**	Deduct \$40.00 per lockset
Working trim only	M31	See pages 125 thru 132
Latch Hold Back 42, 51, 52, 55, 57 functions	LHB	Add \$40.00 per lockset
HPSK Positive Pull Stop Kit (813F068)		Add \$16.00
HPSK "PUSH" & "PULL" Identification (non-handed)	M38	Add \$20.00
HPSK Security Lever (not available on non-keyed functions)	M111	No Charge

\*Refer to ML2000 catalog for available indicators by locking function. Not available w/ BHSS or BLSS trim.

\*\*Not available with BHSS trim. Requires special application for BLSS, HSS, and HPSK trim.

**Electrified Options for ML20900**

Description	Specify Quick Code	Add or Deduct
Latchbolt Monitor	M91	\$188.00
Request to Exit (REX)	M92	\$186.00
Security monitor	M105	\$327.00
Latchbolt monitor x request to exit	M91 x M92	\$374.00
Request to Exit x security monitor	M92 x M105	\$513.00

**Thumbturn Options**

Specify door thickness	Specify Quick Code	Add or Deduct
Ergonomic	M34 <sup>2</sup>	Add \$14.00 per TT
Decorative	MT1	No Charge
Decorative square	MT2	No Charge
Decorative cylinder	MT3	No Charge

**MT1**

**MT2**

**MT3**

Notes:

1. Not available on Vineyard™ Collection.
2. M34 is not available with M19N, M19VN or M19SN.

Note: Thumbturn backplate will match shape of rose chosen (i.e. round or square)

Blank Page

**SPECIALTY HARDWARE****PAGES**

MicroShield® Specialty Hardware Finishes, How to Order, Pricing	147
Behavioral Health Series™ Lever Design: BHSS	148
Behavioral Health Series™ Lever Design: BLSS	149
Anti-Harm Knob Trim Knob Design: HSS	150
Specialty Hardware HPSK Trim	151
<b>HP3000 Series Tubular Lock with Push/Pull Trim:</b>	
HP3000 Series Features & Ordering Example	152
HP3000 Series Strike, Door Thickness, Backset, Miscellaneous Options	153



Look for the  *MicroShield* icon.

**MicroShield®**

As part of their promise to provide innovative solutions to their customers, certain ASSA ABLOY Group brands offer the MicroShield® technology, a silver-based antimicrobial coating designed to inhibit the growth of bacteria.

MicroShield® is a registered trademark of Yale Security Inc., an ASSA ABLOY Group company.

Product	Trim	MicroShield® Coated Components
Specialty Hardware	BHSS, BLSS, HSS, HPSK	Knobs/Levers, roses and/or escutcheons

**AVAILABLE FINISHES**

- MicroShield® is available on 626 and 630. Other finishes available by Special Product Application Request Form only.
- Specify 626C (satin chrome plated) or 630C (satin stainless steel) when ordering.
- MicroShield® coating will be applied over 626 and 630 finishes. All components will match 626.

*Note: MicroShield® coating will only be applied to "high touch" components.*

**HOW TO ORDER**

Product	How to Order
Mortise Locks	ML2055 x BHSS x 630C x RHR

Description	Add
Cylindrical Locks & Mortise Locks	Add \$64.00

**Behavioral Health Series™**

**Lever Design: BHSS**

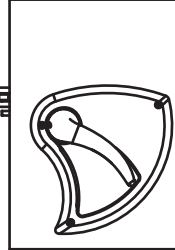

**BHSS**

Lever: Cast  
Escutcheon: Cast

**630**

			630
Non-Keyed	ML2010	Passage	\$1,628.00
	ML2020	Privacy	\$1,747.00
	ML2030	Privacy	
	ML2060	Privacy	\$1,685.00
Single Cylinder	ML2003	Classroom	\$1,763.00
	ML2051	Office	
	ML2055	Classroom	
	ML2056	Classroom HB	
	ML2057	Storeroom	\$1,780.00
	ML2069	Institution Privacy	
	ML2053	Entrance	
	ML2054	Entrance	
	ML2058	Entrance Holdback	
Single Cylinder with Deadbolt	ML2068	Privacy or Apartment	\$1,799.00
	ML2024	Entrance	
	ML2048	Entrance	
	ML2065	Dormitory	
	ML2059	Security Storeroom	
	ML2067	Apartment	
	ML2073	Classroom Security	
	ML2075	Entrance/Office	
Double Cylinder	ML2029	Hotel	\$1,854.00
	ML2002	Classroom Intruder	\$1,849.00
	ML2032	Institution	
	ML2042	Entrance	
	ML2052	Classroom Intruder	
ML2087	Security Vestibule		
Double Cylinder with Deadbolt	ML2022	Store Door	\$1,885.00
	ML2062	Intruder Deadbolt	
	ML2072	Classroom Security Intruder	
	ML2082	Dormitory	
	ML2092	Security Institution	
Single Cylinder	ML20906	Fail Safe/Fail Secure	\$1,981.00
	ML20914		
No Cylinder Override	ML20907	Fail Safe/Fail Secure	\$1,814.00
	ML20915		
Double Cylinder	ML20932	Fail Safe/Fail Secure	\$2,067.00
	ML20987		
Full Working Trim	M31	No cylinder; includes thumbturn lever	\$1,264.00

**Behavioral Health Series™**

**Lever Design: BLSS**

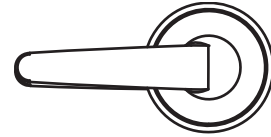

**BLSS**

Lever: Cast  
Rose: Wrought

			630
Non-Keyed	ML2010	Passage	\$1,566.00
	ML2030	Privacy	\$1,685.00
	ML2060	Privacy	\$1,623.00
Single Cylinder	ML2055	Classroom	\$1,701.00
	ML2057	Storeroom	
	ML2069	Institution Privacy	\$1,718.00
	ML2054	Entrance	
Single Cylinder with Deadbolt	ML2024	Entrance	\$1,737.00
	ML2065	Dormitory	
	ML2067	Apartment	
Double Cylinder	ML2032	Institution	\$1,787.00
	ML2042	Entrance	
	ML2052	Classroom Intruder	
	ML2087	Security Vestibule	
Double Cylinder with Deadbolt	ML2022	Store Door	\$1,823.00
	ML2062	Intruder Deadbolt	
Single Cylinder	ML20906	Fail Safe/Fail Secure	\$1,919.00
	ML20914		
No Cylinder Override	ML20907	Fail Safe/Fail Secure	\$1,833.00
	ML20915		
Double Cylinder	ML20932	Fail Safe/Fail Secure	\$2,005.00
	ML20987		
Full Working Trim	M31	No cylinder; includes thumbturn lever	\$1,202.00



**Anti-Harm Knob Trim**

**Knob Design: HSS**



**HSS**

<b>HSS<sup>1</sup></b>
<b>630<sup>2</sup></b>

Function	Model	Description	Price
Non-Keyed	ML2010	Passage Knob: Brass	\$1,367.00
	ML2020	Privacy	\$1,778.00
	ML2060	Privacy	\$1,747.00
	ML2090	Full Active Dummy Trim	\$1,396.00
Single Cylinder	ML2003	Classroom	\$1,828.00
	ML2051	Office	
	ML2055	Classroom	
	ML2056	Classroom Holdback	
	ML2057	Storeroom	\$1,843.00
	ML2069	Institution Privacy	
	ML2053	Entrance	
	ML2054	Entrance	
	ML2058	Entrance Holdback	
ML2068	Privacy or Apartment		
Single Cylinder with Deadbolt	ML2024	Entrance	\$1,864.00
Double Cylinder	ML2002	Classroom Intruder	\$1,914.00
	ML2032	Institution	
	ML2042	Entrance	
	ML2052	Classroom Intruder	
	ML2087	Security Vestibule	
Double Cylinder with Deadbolt	ML2022	Store Door	\$1,950.00
	ML2092	Security Institution	
Deadlock	ML2011	Single Cylinder	\$568.00
	ML2012	Double Cylinder	\$654.00
	ML2013	Cylinder x Thumbturn	\$598.00
	ML2017	Classroom Function Cylinder x Thumbturn	
Single Cylinder	ML20906	Fail Safe/Fail Secure	\$2,046.00
	ML20914		
No Cylinder Override	ML20907	Fail Safe/Fail Secure	\$1,960.00
	ML20915		
Double Cylinder	ML20932	Fail Safe/Fail Secure	\$2,132.00
	ML20987		

Notes:  
 1. Sectional lever trim x HSS available.  
 2. 619 finish provided to match 630 finish.

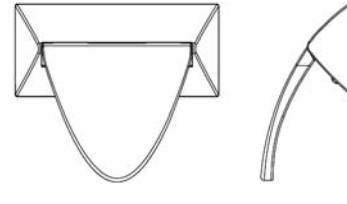

**HPSK**  
Lever: Cast  
Rose: Wrought

Function			630
Non-Keyed	ML2010	Passage	\$1,009.00
	ML2020	Privacy	\$1,041.00
	ML2030	Privacy	
	ML2060	Privacy	\$1,037.00
Single Cylinder	ML2003	Classroom	\$1,120.00
	ML2051	Office	
	ML2055	Classroom	
	ML2056	Classroom	
	ML2057	Storeroom	
	ML2069	Institution Privacy	\$1,133.00
	ML2053	Entrance	
	ML2054	Entrance	
	ML2058	Entrance Holdback	
Single Cylinder with Deadbolt	ML2024	Entrance	\$1,156.00
	ML2048	Entrance	
	ML2065	Dormitory	
	ML2059	Security Storeroom	
	ML2067	Apartment	
	ML2073	Classroom Security	
	ML2075	Entrance/Office	\$1,211.00
	ML2029	Hotel	
Double Cylinder	ML2002	Classroom Intruder	\$1,206.00
	ML2032	Institution	
	ML2042	Entrance	
	ML2052	Classroom Intruder	
	ML2087	Security Vestibule	
Double Cylinder with Deadbolt	ML2022	Store Door	\$1,292.00
	ML2062	Intruder Deadbolt	
	ML2072	Classroom Security Intruder	
	ML2082	Dormitory	
	ML2092	Security Institution	
Single Cylinder	ML20906	Fail Safe/Fail Secure	\$1,338.00
	ML20914		
No Cylinder Override	ML20907	Fail Safe/Fail Secure	\$1,252.00
	ML20915		
Double Cylinder	ML20932	Fail Safe/Fail Secure	\$1,309.00
	ML20987		
Full Working Trim	M31	No cylinder, includes thumbturn lever	\$590.00

**Standard Features**

**Handing**

Passage (HP3010) function is non-handed  
Privacy (HP3020) function is handed

**Door Thickness**

1-3/4" (44mm) standard.  
Optional door thicknesses available

**Backset (5" - Standard)**

5" (127mm) standard.  
Optional: 2-3/4" (70mm) and 7" (177mm)

**Strike**

ANSI curved lip strike standard, 4-7/8" x 1-1/4" x 1-1/4" lip to center.

Optional strikes, lip lengths and ANSI wrought strike box available

**Latchbolt**

Brass, 1/2" (13mm) throw

**Covers**

Cast stainless steel

**Paddles**

Cast stainless steel



**Ordering Example**

**Stock Order**

Series/Function	Trim	Finish	Hand*
HP3010	HPSK	630	RH

\*Passage (HP3010) function is non-handed and privacy (HP3020) function is handed.

Function	Description	Finish
		630
HP3010	Passage	\$435.00
HP3020	Privacy	\$564.00

<b>Strike Options</b>				
Lip to Center	ANSI Curved Lip. Specify	Curved Lip Box. Specify	Full Lip. Specify	Add or Deduct
1" (25mm)	SA100	SC100		No Charge
1-1/8" (29mm)	SA118	SC118		
1-1/4" (32mm)	(standard)	SC114	SF114*	
1-3/8" (35mm)	SA138	SC138		
1-1/2" (38mm)	SA112	SC112		
1-3/4" (44mm)	SA134	SC134		Add \$16.00 per lockset
2" (51mm)	SA200	SC200		
2-1/4" (57mm)	SA214	SC214		
2-1/2" (57mm)	SA212	SC212		
2-3/4" (70mm)	SA234	SC234		
3" (76mm)	SA300	SC300		
* Specify SFR114 for rounded corner.				
<b>Door Thickness Options</b>				
Description	Specify Quick Code	Add or Deduct		
1-3/4" (44mm)	(standard)	No Charge		
2" (51mm)	D200			
2-1/4" (57mm)	D214			
<b>Backset Options</b>				
Description	Specify Quick Code	Add or Deduct		
2-3/4" (70mm)	B234	No Charge		
5" (127mm)	(standard)			
7" (177mm)	B700	Add \$6.00 per lockset		
<b>Miscellaneous Options</b>				
Description	Specify Quick Code	Add or Deduct		
Spanner head screws	M02	Add \$18.00 per lockset		
Torx® head screws	M04	Add \$24.00 per lockset		
Latch front, rounded corners	M13	Add \$2.50 per latch		
ANSI wrought strike box	M17	No Charge		
Lead lining. Specify Push or Pull side.	M28	Add \$272.00 per lockset		
"PUSH & PULL" Identification*	M38	Add \$20.00		
Retrofit Kit (part no. 791F39)		Add \$54.00		
HP3000 Positive Pull Stop Kit (813F068)		Add \$16.00		

**CYLINDRICAL LOCKS**
**PAGES**
**Grade 1 Vandal Resistant Cylindrical Lever Locksets CL3100 Series:**

MicroShield® Cylindrical Locksets Finishes, How to Order, Pricing	154
CL3100 Series Standard Features, Ordering Examples	155
CL3100 Series Lever Designs	156
CL3100 Series Cylinder Options	157
CL3100 Series Keying Options	158
CL3100 Series Door Thickness, Backset, Strike Options	159
CL3100 Series Miscellaneous Options	160

**Grade 1 Extra Heavy-Duty Cylindrical Lever Locksets CL3300 Series:**

CL3300 Series Standard Features & Ordering Examples	161
CL3300 Series Lever Designs	162
CL3300 Series Cylinder Options	163
CL3300 Series Keying Options	164
CL3300 Series Door Thickness, Backset, Strike Options	165
CL3300 Series Miscellaneous Options	166

**Grade 1 Heavy-Duty Cylindrical Lever Locksets CL3500 Series:**

CL3500 Series Standard Features & Ordering Examples	167
CL3500 Series Lever Designs	168
CL3500 Series Cylinder Options	169
CL3500 Series Keying Options	170
CL3500 Series Door Thickness, Backset, Strike Options	171
CL3500 Series Miscellaneous Options	172

**Grade 2 Standard-Duty Lever Locksets CL3800 Series:**

CL3800 Series Standard Features & Ordering Options	173
CL3800 Series Lever Designs	174
CL3800 Series Cylinder & Keying Options	175
CL3800 Series Door Thickness, Backset, Strike, Miscellaneous Options	176

**Grade 1 Heavy-Duty Cylindrical Knob Locksets CK4300 Series:**

CK4300 Series Standard Features & Ordering Example	177
CK4300 Series Knob Designs, Cylinder Keying Options	178
CK4300 Series Strike, Backset, Door Thickness, Miscellaneous Options	179

**Grade 2 Standard-Duty Cylindrical Knob Locksets CK4400 Series:**

CK4400 Series Standard Features & Ordering Example	180
CK4400 Series Knob Designs, Cylinder & Keying Options, Backset Options	181
CK4400 Series Strike, Miscellaneous Options	182



CL3100  
CL3300  
CL3500  
CL3800

**MicroShield®**

As part of their promise to provide innovative solutions to their customers, certain ASSA ABLOY Group brands offer the MicroShield® technology, a silver-based antimicrobial coating designed to inhibit the growth of bacteria.

MicroShield® is a registered trademark of Yale Security Inc., an ASSA ABLOY Group company.

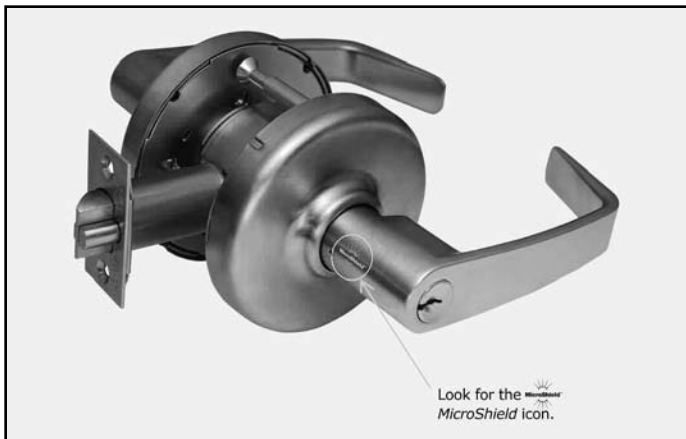

Product	Series	MicroShield® Coated Components
Cylindrical Locks	CL3100, CL3300, CL3500, and CL3800 Series	Levers*, roses

**AVAILABLE FINISHES**

- MicroShield® is available on 626. Other finishes available by Special Product Application Request Form only.
- Specify 626C (satin chrome plated) when ordering.
- MicroShield® coating will be applied over 626 finish. All components will match 626.

\* MicroShield® coating will only be applied to "high touch" components.

**HOW TO ORDER**

Product	How to Order
Cylindrical Locks	CL3355 x NZD x 626C

Description	Add
Cylindrical Locks	Add \$64.00

**Standard Features**

**Handing**

Non-handed

**Door Thickness**

1-3/4" - 2 standard

**Backset**

2-3/4" standard

**Strike**

ANSI curved lip  
4-7/8" x 1-1/4" x 1-1/4" lip to center

**Cylinder**

Brass, 6-pin, L4 keyway, 0-bitted

**Keys**

Two nickel silver keys

**Case Quantity**

6

**Case Weight**

32 lbs

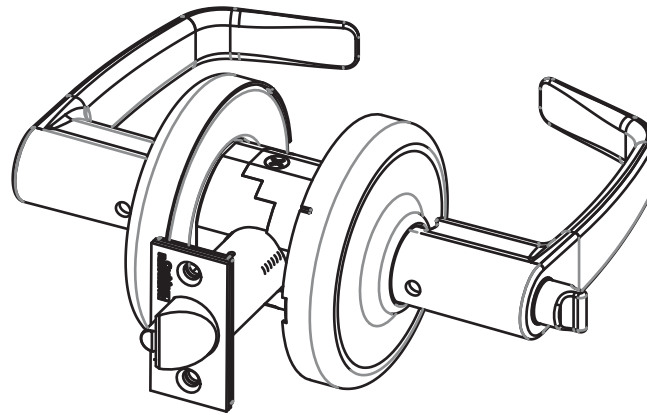

**Ordering Examples**

**Stock Order**

Quantity	Series/Function	Trim	Finish	Hand
100	CL3155	NZD	626	RHR

**Split Finish Order**

Quantity	Series/Function	Finish		Hand
		Outside	Inside	
12	CL3155	626	625	RHR

**Note:** Higher set price prevails

**Contract/Detailed Order**

Quantity	Keyset	Series/Function	Trim	Finish	Hand	Strike	Misc. Options	Cylinder and Keying
24	AA1	CL3155	NZD	626	RHR	SA112	M17	C6-VKC3

**Lever Designs:**



**Levers**

**Roses**

**Lever:**

Die cast zinc

**Rose:**

Brass

**Newport**



**Armstrong**



**Princeton**



C ROSE



D ROSE



E ROSE



K ROSE

Function	Description		AZC, AZD, AZE, AZK, NZC, NZD, NZE, NZK, PZC, PZD, PZE, PZK	
			Finish: 613E, 626, BSP	Finish: 605, 606, 611, 612, 613, 613L, 618, 619, 625, 722
CL3110	Non-Keyed	Passage	\$475.00	\$491.00
CL3120		Privacy	\$541.00	\$557.00
CL3120H		Hospital Privacy		
CL3140NT		Exit Latch		
CL3150		Half Dummy	\$213.00	\$221.00
CL3170		Full Dummy	\$419.00	\$435.00
CL3180		Passage x blank plate	\$541.00	\$557.00
CL3151	Single Cylinder	Entrance	\$638.00	\$654.00
CL3155		Classroom		
CL3157		Storeroom		
CL3161		Entrance	\$652.00	\$668.00
CL3175		Corridor/dormitory	\$716.00	\$732.00
CL3193		Service Station		
CL3129		Hotel		
CL3132	Double Cylinder	Institution	\$727.00	\$743.00
CL3152		Classroom Intruder		
CL3162		Communicating		
CL3172		Public Toilet		



<b>Cylinder Options</b>		
<b>Description</b>	<b>Specify Quick Code</b>	<b>Add or Deduct</b>
Conventional 6-pin	(standard)	No Charge
Conventional 7-pin	7P	Add \$2.00 per cylinder
Less Cylinder <sup>4</sup>	LC	Deduct \$79.00 per cylinder
Access 3 Patented	AP	No Charge
Access 3 Security	AS	Add \$56.00 per cylinder
Access 3 High Security, UL 437	AHS	Add \$79.00 per cylinder
Access 3 IC Patented	ACP	Add \$74.00 per cylinder
Access 3 IC Security	ACS	Add \$123.00 per cylinder
Access 3 IC High Security, UL 437	ACHS	Add \$143.00 per cylinder
Pyramid Security Fixed Core <sup>3</sup>	PS	Add \$58.00 per cylinder
Pyramid Security IC <sup>3</sup>	PCS	Add \$129.00 per cylinder
Pyramid High Security Fixed Core <sup>3</sup>	PHS	Add \$86.00 per cylinder
Pyramid High Security IC <sup>3</sup>	PCHS	Add \$158.00 per cylinder
Pyramid IC with Temporary Construction Core	CTP	Add \$74.00 per cylinder
Pyramid IC with Temporary Disposable Core	CTPD	No Charge
Pyramid IC Less Core	CLP	No Charge
Security <sup>3</sup>	HS	Add \$111.00 per cylinder
Security IC <sup>3</sup>	CHS	Add \$183.00 per cylinder
IC 6-pin	C6	Add \$74.00 per cylinder
IC 6-pin with Temporary Construction Core (Red)	CT6R	Add \$74.00 per cylinder
IC 6-pin with Temporary Construction Core (Blue)	CT6B	Add \$74.00 per cylinder
IC 6-pin with Temporary Construction Core (Green)	CT6G	Add \$74.00 per cylinder
IC 6-pin with Temporary Disposable Core	CT6D	No Charge
Small Format Temporary Disposable Core	CTSD	No Charge
IC 6-pin Less Core <sup>3</sup>	CL6	No Charge
IC 7-pin	C7	Add \$76.00 per cylinder
IC 7-pin with Temporary Construction Core (Red)	CT7R	Add \$76.00 per cylinder
IC 7-pin with Temporary Construction Core (Blue)	CT7B	Add \$76.00 per cylinder
IC 7-pin with Temporary Construction Core (Green)	CT7G	Add \$76.00 per cylinder
IC 7-pin with Temporary Disposable Core	CT7D	No Charge
IC 7-pin Less Core <sup>3</sup>	CL7	
Lockset furnished in Schlage® C Keyway <sup>1, 3</sup>	C	
Lockset furnished in Sargent® LA Keyway <sup>2, 3</sup>	LA	

**Notes:**

1. Available 0-bitted & key random (KR) only.
2. Available 0-bitted only.
3. Not available in CL3129 function.
4. CL3129 function is not available less cylinder.

**Keying Options\***

Description	Specify Quick Code	Add or Deduct
0-Bitted with 2 blank keys	(standard)	No Charge
Keyed random	KR	
Master keyed (all cylinders except 8000, 8020, 8027 IC core)	Specify keyset	Add \$16.00 per cylinder
Master keyed Pyramid	Specify keyset	
Master keyed Security (including IC cylinder and core)	Specify keyset	
Master keyed (8000, 8020, 8027 IC core)	Specify keyset	No Charge
Master keyed to customer bittings or sample key	Specify keyset	Add \$16.00 per cylinder
Construction master keyed <sup>1,2</sup>	CMK	Add \$16.00 per cylinder
Visual key control (VKC)		
-No stamping	VKC0	\$4.50
-Keys only	VKC1	No Charge
-Cylinder and Keys <sup>3</sup>	VKC2	\$8.00
-Cylinders only <sup>3</sup>	VKC3	\$8.00
Concealed key control (CKC)		
-CKC cylinders with VKC keys	CKC2	\$8.00
-CKC cylinders only <sup>3</sup>	CKC3	\$8.00
More than 2 keys per lock	KY# (e.g., KY6)	See page 66 - Cut Keys Section

## Notes:

1. CMK Construction master keying charge is in addition to master keying charge.
2. CMK Construction master keying is not available in Pyramid or Security series.
3. VKC2, VKC3, CKC3 are not available in Access 3, Pyramid or Security series.

\*Double cylinder keying: unless otherwise specified, both cylinders of 32, 52 and 62 functions will be keyed alike. The inside cylinder of 72 function will be keyed to the master key(s) only, while the outside cylinder will include the change key.

If different keying is required, specify outside cylinder first, then inside cylinder.

For key bows other than 10 and 90, specify 'KB' + bow number as Quick Code, e.g. KB12.

**Door Thickness Options**

Description	Specify Quick Code	Add or Deduct
1-3/4" - 2"	(standard)	No Charge
Over 2" up to 2-1/4"	D214	

**Backset Options**

Description	Specify Quick Code	Add or Deduct
2-3/4"	(standard)	No Charge
3-3/4"	B334	Add \$15.00 to lockset
5"	B500	Add \$24.00 to lockset

**Strike Options<sup>2</sup>** (to purchase strike separately, see catalog or parts manual for part no.)

Lip Length	ANSI Curved Lip - Specify Quick Code	Curved Lip Box - Specify Quick Code	Add or Deduct
1"	SA100	SC100	No Charge
1-1/8"	SA118	SC118	
1-1/4"	(standard)	SC114	
1-3/8"	SA138	SC138	
1-1/2"	SA112	SC112	
1-3/4"	SA134	SC134	Add \$16.00 per lockset
2"	SA200	SC200	
2-1/4"	SA214	SC214	
2-1/2"	SA212	SC212	
2-3/4"	SA234	SC234	
3"	SA300	SC300	

<sup>1,2</sup>If door thickness is standard or has been specified and no special door or frame condition exist, then only the first two characters of the optional strike Quick Code must be specified (e.g. "SC").  
The correct lip length will be determined by our order entry system based on the standard or specified door thickness.

**Miscellaneous Options**

Description	Specify Quick Code	Add or Deduct
Spanner head screws	M02	Add \$18.00 per lockset
Torx® head screws	M04	Add \$24.00 per lockset
Less cylinder and with tailpiece for Schlage® fixed core cylinder (AZ, NZ & PZ designs) <sup>2</sup>	M06	No Charge
Lever to accept 6 or 7-pin SFIC (AZ, NZ & PZ designs) <sup>2</sup>	M08	No Charge
Lever to accept Sargent® fixed core cylinder (AZ, NZ & PZ designs) <sup>2</sup>	M09	No Charge
Security Lever (not available on non-keyed functions)	M111	No Charge
3/4" throw fire latch x 2-3/4" backset (not available for CL3120, 29, 40, and 93 functions)  <div style="display: flex; justify-content: space-between;"> <div style="width: 30%;">                     Finishes Available                      605                      606                      626                 </div> <div style="width: 30%;">                     Matching Lock Finish                      605                      606, 611, 612, 613                      625, 626                 </div> </div>	M16	Add \$100.00 per lockset
ANSI wrought strike box	M17	No Charge
Knurling outside and inside	M20	Add \$137.00 per lockset
Knurling outside only	M21	Add \$69.00 per lockset
Knurling inside only	M22	Add \$69.00 per lockset
Abrasive coat outside and inside	M23	Add \$85.00 per lockset
Abrasive coat inside only	M24	Add \$43.00 per lockset
Abrasive coat outside only	M25	Add \$43.00 per lockset
Lead lining (roses)	M28	Add \$164.00 per lockset
Lever to accept Schlage® LFIC (AZ, NZ & PZ designs) <sup>2</sup>	M69	No Charge
Lever to accept Yale® 6-pin fixed core cylinder (NZ & PZ designs only) <sup>2</sup>	YC	
Lever to accept Yale® 7-pin fixed core cylinder (NZ & PZ designs only) <sup>2</sup>	YC7	
Lever to accept Yale® 6-pin LFIC (NZ & PZ designs only) <sup>2</sup>	YRC	
Lever to accept Yale® 7-pin LFIC (NZ & PZ designs only) <sup>2</sup>	YRC7	
STC 55 Acoustical Door Kit	M112	

**Notes:**

2. Not available in CL3129 function.

**Standard Features**

**Handing**

Non-handed except FZD

**Door Thickness**

1-3/4" - 2"

**Backset**

2-3/4"

**Strike**

ANSI curved lip  
4-7/8" x 1-1/4" x 1-1/4" lip to center

**Cylinder**

Brass, 6-pin, L4 keyway, 0-bitted

**Keys**

Two nickel silver keys

**Case Quantity**

6

**Case Weight**

32 lbs

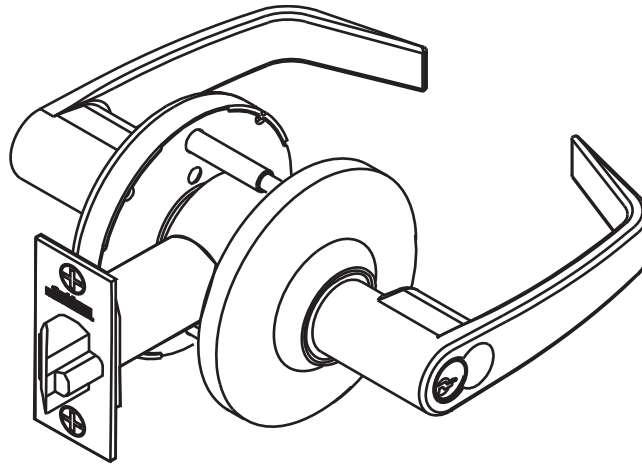

**Ordering Examples**

**Stock Order**

Quantity	Series/Function	Trim	Finish	Hand
100	CL3355	NZD	626	RHR

**Split Trim/Split Finish Order**

Quantity	Series/Function	Trim		Finish		Hand
		Outside	Inside	Outside	Inside	
12	CL3355	NZD	AZD	626	625	RHR

**Contract/Detailed Order**

Quantity	Keyset	Series/Function	Trim	Finish	Hand	Strike	Misc. Options	Cylinder and Keying
24	AA1	CL3355	NZD	626	RHR	SA112	M17	C6-VKC3

**Lever Designs: AZD, NZD, PZD, FZD**



**Lever:**

Die cast zinc

**Rose:**

Wrought Brass



**Armstrong**



**Newport**



**Princeton**



**Frascati**



Function	Description	AZD, NZD, PZD, FZD		
		Finish: 613E, 626, BSP	Finish: 605, 606, 611, 612, 613, 613L, 618, 619, 625, 722	
CL3310	Non-Keyed	Passage	\$476.00	\$492.00
CL3380		Passage x Blank Plate		
CL3390		Passage x Turnpiece	\$529.00	\$545.00
CL3320		Privacy		
CL3320H		Hospital Privacy	\$624.00	\$640.00
CL3320TO		Time Out Lock		
CL3340		Patio	\$529.00	\$545.00
CL3340NT		Exit Latch		
CL3350		Half Dummy	\$194.00	\$202.00
CL3370		Full Dummy	\$388.00	\$404.00
CL3351	Single Cylinder	Entrance		
CL3355		Classroom	\$624.00	\$640.00
CL3357		Storeroom		
CL3359		Storeroom or Public Restroom		
CL3361		Entrance	\$637.00	\$653.00
CL3375		Corridor/Dormitory		
CL3393		Service Station	\$691.00	\$707.00
CL3329		Hotel		
CL3381		Keyed x Blank Plate	\$624.00	\$640.00
CL3391		Keyed x Blank Plate		
CL3332	Double Cylinder	Institution		
CL3352		Classroom Intruder	\$715.00	\$731.00
CL3362		Communicating		
CL3372		Public Toilet		
CL33903*	Electrified	Fail Safe	\$849.00	\$865.00
CL33905*		Fail Secure		



**\*ElectroLynx®**

As part of their promise to provide innovative, fast and effective, and higher security solutions to their customers, ASSA ABLOY Group companies offer ElectroLynx, a universal quick-connect system that simplifies the electrification of the door opening. ElectroLynx® is a registered trademark of ASSA ABLOY, Inc.

<b>Cylinder Options</b>		
<b>Description</b>	<b>Specify Quick Code</b>	<b>Add or Deduct</b>
Conventional 6-pin	(standard)	No Charge
Conventional 7-pin	7P	Add \$2.00 per cylinder
Less Cylinder <sup>4</sup>	LC	Deduct \$79.00 per cylinder
Access 3 Patented	AP	No Charge
Access 3 Security	AS	Add \$56.00 per cylinder
Access 3 High Security, UL 437	AHS	Add \$79.00 per cylinder
Access 3 IC Patented	ACP	Add \$74.00 per cylinder
Access 3 IC Security	ACS	Add \$123.00 per cylinder
Access 3 IC High Security, UL 437	ACHS	Add \$143.00 per cylinder
Pyramid Security Fixed Core <sup>3</sup>	PS	Add \$58.00 per cylinder
Pyramid Security IC <sup>3</sup>	PCS	Add \$129.00 per cylinder
Pyramid High Security Fixed Core <sup>3</sup>	PHS	Add \$86.00 per cylinder
Pyramid High Security IC <sup>3</sup>	PCHS	Add \$158.00 per cylinder
Pyramid IC with Temporary Construction Core	CTP	Add \$74.00 per cylinder
Pyramid IC with Temporary Disposable Core	CTPD	No Charge
Pyramid IC Less Core	CLP	No Charge
Security <sup>3</sup>	HS	Add \$111.00 per cylinder
Security IC <sup>3</sup>	CHS	Add \$183.00 per cylinder
IC 6-pin	C6	Add \$74.00 per cylinder
IC 6-pin with Temporary Construction Core (Red)	CT6R	Add \$74.00 per cylinder
IC 6-pin with Temporary Construction Core (Blue)	CT6B	Add \$74.00 per cylinder
IC 6-pin with Temporary Construction Core (Green)	CT6G	Add \$74.00 per cylinder
IC 6-pin with Temporary Disposable Core	CT6D	No Charge
Small Format Temporary Disposable Core	CTSD	No Charge
IC 6-pin Less Core <sup>3</sup>	CL6	No Charge
IC 7-pin	C7	Add \$76.00 per cylinder
IC 7-pin with Temporary Construction Core (Red)	CT7R	Add \$76.00 per cylinder
IC 7-pin with Temporary Construction Core (Blue)	CT7B	Add \$76.00 per cylinder
IC 7-pin with Temporary Construction Core (Green)	CT7G	Add \$76.00 per cylinder
IC 7-pin with Temporary Disposable Core	CT7D	No Charge
IC 7-pin Less Core <sup>3</sup>	CL7	
Lockset furnished in Schlage® C Keyway <sup>1, 3</sup>	C	
Lockset furnished in Sargent® LA Keyway <sup>2, 3</sup>	LA	

**Notes:**

1. Available 0-bitted & key random (KR) only.
2. Available 0-bitted only.
3. Not available in CL3329 function.
4. CL3329 function is not available less cylinder.

**Keying Options\***

Description	Specify Quick Code	Add or Deduct
0-Bitted with 2 blank keys	(standard)	No Charge
Keyed random	KR	
Master keyed (all cylinders except 8000, 8020, 8027 IC core)	Specify keyset	Add \$16.00 per cylinder
Master keyed Pyramid	Specify keyset	
Master keyed Security (including IC cylinder and core)	Specify keyset	
Master keyed (8000, 8020, 8027 IC core)	Specify keyset	No Charge
Master keyed to customer bittings or sample key	Specify keyset	Add \$16.00 per cylinder
Construction master keyed <sup>1,2</sup>	CMK	Add \$16.00 per cylinder
Visual key control (VKC)		
-No stamping	VKC0	\$4.50
-Keys only	VKC1	No Charge
-Cylinder and Keys <sup>3</sup>	VKC2	\$8.00
-Cylinders only <sup>3</sup>	VKC3	\$8.00
Concealed key control (CKC)		
-CKC cylinders with VKC keys	CKC2	\$8.00
-CKC cylinders only <sup>3</sup>	CKC3	\$8.00
More than 2 keys per lock	KY# (e.g., KY6)	See page 66 - Cut Keys Section

## Notes:

1. CMK Construction master keying charge is in addition to master keying charge.
2. CMK Construction master keying is not available in Access 3, Pyramid or Security series.
3. VKC2, VKC3, CKC3 are not available in Access 3, Pyramid or Security series.

\*Double cylinder keying: unless otherwise specified, both cylinders of 32 and 82 functions will be keyed alike. The inside cylinder of 72 function will be keyed to the master key(s) only, while the outside cylinder will include the change key.

If different keying is required, specify outside cylinder first, then inside cylinder.

For key bows other than 10 and 90, specify 'KB' + bow number as Quick Code, e.g. KB12.



**Door Thickness Options**

Description	Specify Quick Code	Add or Deduct
1-3/4" - 2"	(standard)	No Charge
Over 2" up to 2-1/4"	D214	

**Backset Options**

Description	Specify Quick Code	Add or Deduct
2-3/4"	(standard)	No Charge
3-3/4"	B334	Add \$15.00 to lockset
5"	B500	Add \$24.00 to lockset

**Strike Options\*** (to purchase strike separately, see catalog or parts manual for part no.)

Lip Length	ANSI Curved Lip - Specify Quick Code	Curved Lip Box - Specify Quick Code	Add or Deduct
1"	SA100	SC100	No Charge
1-1/8"	SA118	SC118	
1-1/4"	(standard)	SC114	
1-3/8"	SA138	SC138	
1-1/2"	SA112	SC112	
1-3/4"	SA134	SC134	Add \$16.00 per lockset
2"	SA200	SC200	
2-1/4"	SA214	SC214	
2-1/2"	SA212	SC212	
2-3/4"	SA234	SC234	
3"	SA300	SC300	

Description	Specify Quick Code	Add or Deduct
Rabbeted front and strike	SR118	Add \$86.00 per lockset

\*If door thickness is standard or has been specified and no special door or frame condition exist, then only the first two characters of the optional strike Quick Code must be specified (e.g. "SC").  
The correct lip length will be determined by our order entry system based on the standard or specified door thickness.

**Miscellaneous Options**

Description	Specify Quick Code	Add or Deduct
Split designs and split finishes	Outside Trim x Inside Trim	Higher set price prevails
Spanner head screws	M02	Add \$18.00 per lockset
Torx® head screws	M04	Add \$24.00 per lockset
Less cylinder and with tailpiece for Schlage® fixed core cylinder (all designs) <sup>2</sup>	M06	No Charge
Lever to accept 6 or 7-pin SFIC <sup>2</sup> (NZD, FZD and PZD designs only)	M08	No Charge
Lever to accept Sargent® fixed core cylinder (all designs) <sup>2</sup>	M09	No Charge
1-1/8" latch front, rounded corners	M13	Add \$2.50 per latch
3/4" throw fire latch x 2-3/4" backset (not available for CL3320, 29, 40, and 93 functions) <div style="display: flex; justify-content: space-between;"> <div style="width: 30%;">                     Finishes Available                      605                      606                      626                 </div> <div style="width: 30%;">                     Matching Lock Finish                      605                      606, 611, 612, 613                      625, 626                 </div> </div>	M16	Add \$100.00 per lockset
ANSI wrought strike box	M17	No Charge
Knurling outside and inside	M20	Add \$137.00 per lockset
Knurling outside only	M21	Add \$69.00 per lockset
Knurling inside only	M22	Add \$69.00 per lockset
Abrasive coat outside and inside	M23	Add \$85.00 per lockset
Abrasive coat inside only	M24	Add \$43.00 per lockset
Abrasive coat outside only	M25	Add \$43.00 per lockset
Lead lining (roses)	M28	Add \$164.00 per lockset
Lever to accept Schlage® LFIC <sup>2</sup> (NZD and PZD designs only)	M69	No Charge
Request to Exit (REX) Switch (CL33900 only)	M92	\$186.00
CL33900 Series electrified options		
12VAC/DC <sup>1</sup>	12 AD	No Charge
24VAC/DC	24 AD	

**Notes:**

1. Voltage is universal for AC or DC current.
2. Not available in CL3329 function.

**Standard Features**

**Handing**

Non-handed

**Door Thickness**

1-3/4"

**Backset**

2-3/4"

**Strike**

ANSI curved lip  
4-7/8" x 1-1/4" x 1-1/4" lip to center

**Cylinder**

Brass, 6-pin, L4 keyway  
0-bitted

**Keys**

Two nickel silver keys

**Case Quantity**

6

**Case Weight**

26 lbs

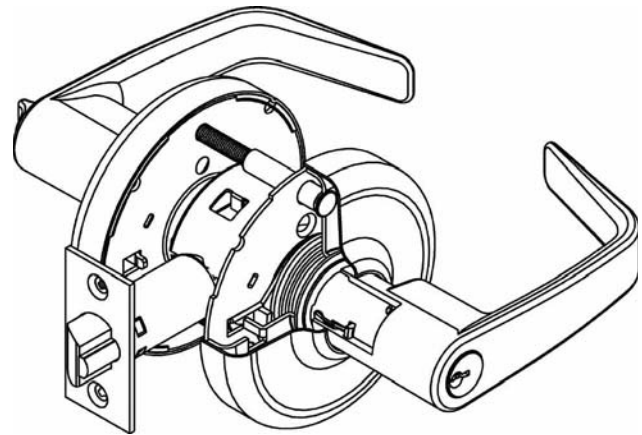

**Ordering Examples**

**Stock Order**

Quantity	Series/Function	Trim	Finish	Hand
100	CL3555	NZD	626	RH

**Split Trim/Split Finish Order**

Quantity	Series/Function	Trim		Finish		Hand
		Outside	Inside	Outside	Inside	
12	CL3555	NZD	AZD	626	625	RH

**Contract/Detailed Order**

Quantity	Keyset	Series/Function	Trim	Finish	Hand	Strike	Misc. Options	Cylinder and Keying
24	AA1	CL3555	NZD	626	RH	SA112	M17	C6-VKC3

**Lever Designs: AZD**



**Lever:**  
Die cast zinc

**Rose:**  
Wrought Brass



**AZD**

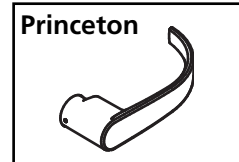
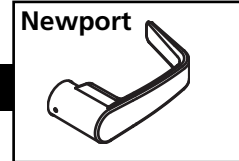

**Lever Designs: NZD**



**Lever:**  
Die cast zinc

**Rose:**  
Wrought Brass



**NZD**

**Lever Designs: PZD**



**Lever:**  
Die cast zinc

**Rose:**  
Wrought Brass



**PZD**

Function	Description	AZD, NZD, PZD	
		Finish: 613E, 626, BSP	Finish: 605, 606, 611, 612, 613, 613L, 618, 619, 625, 722
CL3510	Passage	\$438.00	\$454.00
CL3580	Passage x Blank Plate	\$482.00	\$498.00
CL3520	Privacy		
CL3550	Half Dummy	\$194.00	\$202.00
CL3570	Full Dummy	\$388.00	\$404.00
CL3551	Entrance	\$546.00	\$562.00
CL3555	Classroom		
CL3557	Storeroom		
CL3561	Office or Privacy		
CL3581	Keyed x Blank Plate	\$625.00	\$641.00
CL3582	Store Door		

<b>Cylinder Options</b>		
<b>Description</b>	<b>Specify Quick Code</b>	<b>Add or Deduct</b>
Conventional 6-pin	(standard)	No Charge
Conventional 7-pin	7P	Add \$2.00 per cylinder
Less Cylinder	LC	Deduct \$79.00 per cylinder
Access 3 Patented	AP	No Charge
Access 3 Security	AS	Add \$56.00 per cylinder
Access 3 High Security, UL 437	AHS	Add \$79.00 per cylinder
Access 3 IC Patented	ACP	Add \$74.00 per cylinder
Access 3 IC Security	ACS	Add \$123.00 per cylinder
Access 3 IC High Security, UL 437	ACHS	Add \$143.00 per cylinder
Pyramid Security Fixed Core	PS	Add \$58.00 per cylinder
Pyramid Security IC	PCS	Add \$129.00 per cylinder
Pyramid High Security Fixed Core	PHS	Add \$86.00 per cylinder
Pyramid High Security IC	PCHS	Add \$158.00 per cylinder
Pyramid IC with Temporary Construction Core	CTP	Add \$74.00 per cylinder
Pyramid IC with Temporary Disposable Core	CTPD	No Charge
Pyramid IC Less Core	CLP	No Charge
Security	HS	Add \$111.00 per cylinder
Security IC	CHS	Add \$183.00 per cylinder
IC 6-pin	C6	Add \$74.00 per cylinder
IC 6-pin with Temporary Construction Core (Red)	CT6R	Add \$74.00 per cylinder
IC 6-pin with Temporary Construction Core (Blue)	CT6B	Add \$74.00 per cylinder
IC 6-pin with Temporary Construction Core (Green)	CT6G	Add \$74.00 per cylinder
IC 6-pin with Temporary Disposable Core	CT6D	No Charge
Small Format Temporary Disposable Core	CTSD	No Charge
IC 6-pin less core	CL6	No Charge
IC 7-pin	C7	Add \$76.00 per cylinder
IC 7-pin with Temporary Construction Core (Red)	CT7R	Add \$76.00 per cylinder
IC 7-pin with Temporary Construction Core (Blue)	CT7B	Add \$76.00 per cylinder
IC 7-pin with Temporary Construction Core (Green)	CT7G	Add \$76.00 per cylinder
IC 7-pin with Temporary Disposable Core	CT7D	No Charge
IC 7-pin Less Core	CL7	No Charge
Lockset furnished in Schlage® C Keyway <sup>1</sup>	C	
Lockset furnished in Sargent® LA Keyway <sup>2</sup>	LA	

**Notes:**

1. Available 0-bitted & key random (KR) only.
2. Available 0-bitted only.

**Keying Options\***

Description	Specify Quick Code	Add or Deduct
0-Bitted with 2 blank keys	(standard)	No Charge
Keyed random	KR	
Master keyed (all cylinders except 8000, 8020, 8027 IC core)	Specify keyset	Add \$16.00 per cylinder
Master keyed Pyramid	Specify keyset	
Master keyed Security (including IC cylinder and core)	Specify keyset	
Master keyed (8000, 8020, 8027 IC core)	Specify keyset	No Charge
Master keyed to customer bittings or sample key	Specify keyset	Add \$16.00 per cylinder
Construction master keyed <sup>1,2</sup>	CMK	Add \$16.00 per cylinder
Visual key control (VKC)		
-No stamping	VKC0	\$4.50
-Keys only	VKC1	No Charge
-Cylinder and Keys <sup>3</sup>	VKC2	\$8.00
-Cylinders only <sup>3</sup>	VKC3	\$8.00
Concealed key control (CKC)		
-CKC cylinders with VKC keys	CKC2	\$8.00
-CKC cylinders only <sup>3</sup>	CKC3	\$8.00
More than 2 keys per lock	KY# (e.g., KY6)	See page 66 - Cut Keys Section

## Notes:

1. CMK Construction master keying charge is in addition to master keying charge.
2. CMK Construction master keying is not available in Access 3, Pyramid or Security series.
3. VKC2, VKC3, CKC3 are not available in Access 3, Pyramid or Security series.

\*Double cylinder keying: unless otherwise specified, both cylinders of 82 functions will be keyed alike.

If different keying is required, specify outside cylinder first, then inside cylinder.

For key bows other than 10 and 90, specify "KB" + bow number as Quick Code, e.g. KB12.

**Door Thickness Options**

Description	Specify Quick Code	Add or Deduct
1-3/4"	(standard)	No Charge
1-3/8"	D138**1	

**Backset Options**

Description	Specify Quick Code	Add or Deduct
2-3/8"	B238 <sup>1</sup>	No Charge
2-3/4"	B234 (standard)	
3-3/4"	B334	Add \$15.00 to lockset
5"	B500	Add \$24.00 to lockset

**Strike Options\*** (to purchase strike separately, see catalog or parts manual for part no.)

Lip Length	ANSI Curved Lip Specify Quick Code	Curved Lip Box Specify Quick Code	Full Lip Specify Quick Code	Add or Deduct
1"	SA100	SC100	SF118	No Charge
1-1/8"	SA118	SC118		
1-1/4"	(standard)	SC114		
1-3/8"	SA138	SC138		
1-1/2"	SA112	SC112		
1-3/4"	SA134	SC134		Add \$16.00 per lockset
2"	SA200	SC200		
2-1/4"	SA214	SC214		
2-1/2"	SA212	SC212		
2-3/4"	SA234	SC234		
3"	SA300	SC300		

Description	Specify Quick Code	Add or Deduct
Rabbeted front and strike	SR118	Add \$86.00 per lockset

\*If door thickness is standard or has been specified and no special door or frame condition exist, then only the first two characters of the optional strike Quick Code must be specified (e.g. "SC").

The correct lip length will be determined by our order entry system based on the standard or specified door thickness.

\*\*If D138 is specified, 2-3/8" backset latch will be supplied unless B234 option is also specified.

1. M14 and B238 (2-3/8" backset) standard with D138 (1-3/8" door thickness) option.

**Miscellaneous Options**

Description	Specify Quick Code	Add or Deduct
Split designs and split finishes	Outside Trim x Inside Trim	Higher set price prevails
Spanner head screws	M02	Add \$18.00 per lockset
Torx® head screws	M04	Add \$24.00 per lockset
Less cylinder and with tailpiece for Schlage® fixed core cylinder (all designs)	M06	No Charge
Lever to accept 6 or 7-pin SFIC (NZD & PZD design only)	M08	No Charge
Lever to accept Sargent® fixed core cylinder (all designs) (NZD design only)	M09	No Charge
Lever to accept Schlage® LFIC (NZD & PZD design only)	M69	No Charge
1-1/8" latch front, rounded corners	M13	Add \$2.50 per latch
1" latch front, square corners <sup>1</sup>	M14	Add \$6.00 per lockset
1" latch front, rounded corners	M15	Add \$2.50 per latch
ANSI wrought strike box	M17	No Charge
Knurling outside and inside	M20	Add \$137.00 per lockset
Knurling outside only	M21	Add \$69.00 per lockset
Knurling inside only	M22	Add \$69.00 per lockset
Abrasive coat outside and inside only	M23	Add \$85.00 per lockset
Abrasive coat inside only	M24	Add \$43.00 per lockset
Abrasive coat outside only	M25	Add \$43.00 per lockset
1-1/8" latch front, square corners (standard for 2-3/4" and 5" backsets)	M32	No Charge

**Note:**

1. M14 and B238 (2-3/8" backset) standard with D138 (1-3/8" door thickness) option.



**Standard Features**

**Handing**

Non-handed

**Door Thickness**

1-3/8" - 1-7/8"  
Available in 2" - 2-1/4" upon request

**Backset**

2-3/4" standard

**Strike**

ANSI curved lip  
4-7/8" x 1-1/4" x 1-1/4" lip to center

**Cylinder**

Brass, 6-pin, L4 keyway  
0-bitted

**Keys**

Two nickel silver keys

**Case Quantity**

6

**Case Weight**

32 lbs

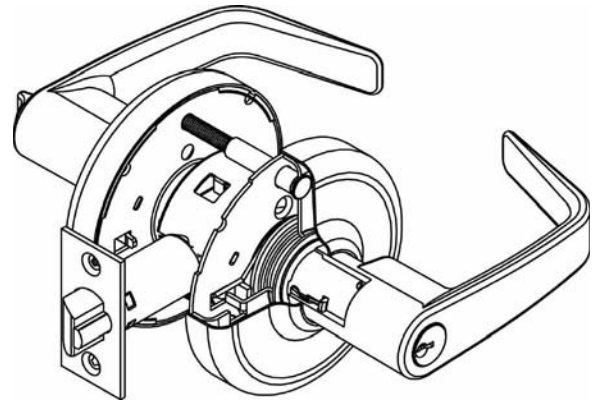

**Ordering Examples**

**Stock Order**

Quantity	Series/Function	Trim	Finish	Hand
100	CL3855	NZD	626	RHR

**Split Trim/Split Finish Order**

Quantity	Series/Function	Trim		Finish		Hand
		Outside	Inside	Outside	Inside	
12	CL3855	NZD	AZD	626	625	RHR

**Contract/Detailed Order**

Quantity	Keyset	Series/Function	Trim	Finish	Hand	Strike	Misc. Options	Cylinder and Keying
24	AA1	CL3855	NZD	626	RHR	SA112	M02	C6-VKC3

**Lever Designs: AZD, NZD, PZD**



**Lever:**  
Die cast zinc

**Rose:**  
Wrought Brass

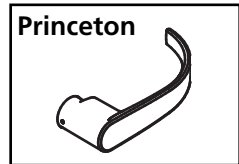
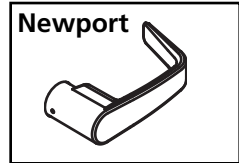

Function	Description	AZD, NZD, PZD	
		Finish: 613E, 626, BSP	Finish: 605, 606, 611, 612, 613, 613L, 618, 619, 625, 722
CL3810	Passage	\$200.00	\$216.00
CL3880	Passage x Blank Plate	\$220.00	\$236.00
CL3820	Privacy		
CL3850	Half Dummy	\$112.00	\$118.00
CL3870	Full Dummy	\$212.00	\$228.00
CL3851	Entrance	\$276.00	\$292.00
CL3855	Classroom		
CL3857	Storeroom		
CL3861	Office		

### Cylinder & Keying Options

Description	Specify Quick Code	Add or Deduct
Conventional 6-pin	(standard)	No Charge
Conventional 7-Pin	7P	Add \$2.00 per cylinder
Less Cylinder	LC	Deduct \$79.00 per cylinder
Access 3 Patented	AP	No Charge
Access 3 Security	AS	Add \$56.00 per cylinder
Access 3 High Security, UL 437	AHS	Add \$79.00 per cylinder
Access 3 IC Patented	ACP	Add \$74.00 per cylinder
Access 3 IC Security	ACS	Add \$123.00 per cylinder
Access 3 IC High Security, UL 437	ACHS	Add \$143.00 per cylinder
Pyramid Security Fixed Core <sup>3</sup>	PS	Add \$58.00 per cylinder
Pyramid Security IC <sup>3</sup>	PCS	Add \$129.00 per cylinder
Pyramid High Security Fixed Core <sup>3</sup>	PHS	Add \$86.00 per cylinder
Pyramid High Security IC <sup>3</sup>	PCHS	Add \$158.00 per cylinder
Pyramid IC with Temporary Construction Core	CTP	Add \$74.00 per cylinder
Pyramid IC with Temporary Disposable Core	CTPD	No Charge
Pyramid IC Less Core	CLP	No Charge
Security	HS	Add \$111.00 per cylinder
Security IC	CHS	Add \$183.00 per cylinder
IC 6-pin	C6	Add \$74.00 per cylinder
IC 6-pin with Temporary Construction Core (Red)	CT6R	Add \$74.00 per cylinder
IC 6-pin with Temporary Construction Core (Blue)	CT6B	Add \$74.00 per cylinder
IC 6-pin with Temporary Construction Core (Green)	CT6G	Add \$74.00 per cylinder
IC 6-pin with Temporary Disposable Core	CT6D	No Charge
Small Format Temporary Disposable Core	CTSD	No Charge
IC 6-pin Less Core	CL6	No Charge
IC 7-Pin	C7	Add \$76.00 per cylinder
IC 7-Pin with Temporary Construction Core (Red)	CT7R	Add \$76.00 per cylinder
IC 7-Pin with Temporary Construction Core (Blue)	CT7B	Add \$76.00 per cylinder
IC 7-Pin with Temporary Construction Core (Green)	CT7G	Add \$76.00 per cylinder
IC 7-Pin with Temporary Disposable Core	CT7D	No Charge
IC 7-Pin Less Core	CL7	No Charge
Lockset furnished in Schlage® C Keyway <sup>1</sup>	C	No Charge
Lockset furnished in SARGENT® LA Keyway <sup>2</sup>	LA	No Charge
0-Bitted with 2 blank keys	(standard)	No Charge
Keyed random	KR	No Charge
Master keyed (all cylinders except 8000, 8020, 8027 IC core)	Specify keyset	Add \$16.00 per cylinder
Master keyed Pyramid	Specify keyset	
Master keyed Security (including IC cylinder and core)	Specify keyset	
Master keyed (8000, 8020, 8027 IC core)	Specify keyset	
Master keyed to customer bittings or sample key	Specify keyset	Add \$16.00 per cylinder
Construction master keyed <sup>3,4</sup>	CMK	Add \$16.00 per cylinder
Visual key control (VKC)		
-No stamping	VKC0	\$4.50
-Keys only	VKC1	No Charge
-Cylinder and Keys <sup>5</sup>	VKC2	\$8.00
-Cylinders only <sup>5</sup>	VKC3	\$8.00
Concealed key control (CKC)		
-CKC cylinders with VKC keys	CKC2	\$8.00
-CKC cylinders only <sup>2</sup>	CKC3	\$8.00
More than 2 keys per lock	KY# (e.g., KY6)	See page 66 - Cut Keys Section

**Notes:**

1. Available 0-bitted & key random (KR) only.
  2. Available 0-bitted only.
  3. CMK Construction master keying charge is in addition to master keying charge.
  4. CMK Construction master keying is not available in Pyramid or Security series.
  5. VKC2, VKC3, CKC3 are not available in Access 3, Pyramid or Security series.
- For key bows other than 10 and 90, specify "KB" + bow number as Quick Code, e.g. KB12. No extra charge.

**Door Thickness Options**

Description	Specify Quick Code	Add or Deduct
1-3/8" — 1-7/8"	(standard)	No Charge
2" — 2-1/4"	D214	Add \$5.00 per lockset

**Backset Options**

Description	Specify Quick Code	Add or Deduct
2-3/8"	B238 <sup>1</sup>	No Charge
2-3/4"	(standard)	
3-3/4"	B334	Add \$12.00 to lockset
5"	B500	Add \$14.00 to lockset

**Strike Options\*** (to purchase strike separately, see catalog or parts manual for part no.)

Lip Length	ANSI Curved Lip Specify Quick Code	Curved Lip Box Specify Quick Code	Full Lip Specify Quick Code	Full Lip Radius Corner Specify Quick Code	Add or Deduct
1"	SA100	SC100			No Charge
1-1/8"	SA118	SC118			
1-1/4"	(standard)	SC114	SF114	SFR114	
1-3/8"	SA138	SC138			
1-1/2"	SA112	SC112			
1-3/4"	SA134	SC134			Add \$16.00 per lockset
2"	SA200	SC200			
2-1/4"	SA214	SC214			
2-1/2"	SA212	SC212			
2-3/4"	SA234	SC234			
3"	SA300	SC300			

\*If door thickness is standard or has been specified and no special door or frame condition exist, then only the first two characters of the optional strike Quick Code must be specified (e.g. "SC"). The correct lip length will be determined by our order entry system based on the standard or specified door thickness.

**Miscellaneous Options**

Description	Specify Quick Code	Add or Deduct
Split designs and split finishes	Outside Trim x Inside Trim	Higher set price prevails
Spanner head screws	M02	Add \$18.00 per lockset
Torx® head screws	M04	Add \$24.00 per lockset
Less cylinder and with tailpiece for Schlage® fixed core cylinder (all designs)	M06	No Charge
Lever to accept 6 or 7-pin SFIC (FZD, NZD & PZD design only)	M08	No Charge
Lever to accept Sargent® fixed core cylinder (all designs) (NZD & PZD design only)	M09	No Charge
1-1/8" latch front, rounded corners	M13	Add \$2.50 per latch
1" latch front, square corners <sup>1</sup>	M14	Add \$6.00 per lockset
1" latch front, rounded corners	M15	Add \$2.50 per latch
ANSI wrought strike box	M17	No Charge
Knurling outside and inside	M20	Add \$137.00 per lockset
Knurling outside only	M21	Add \$69.00 per lockset
Knurling inside only	M22	Add \$69.00 per lockset
Abrasive coat outside and inside only	M23	Add \$85.00 per lockset
Abrasive coat inside only	M24	Add \$43.00 per lockset
Abrasive coat outside only	M25	Add \$43.00 per lockset
1-1/8" latch front, square corners (standard for 2-3/4" and 5" backsets)	M32	No Charge
Lever to accept Schlage® LFIC (NZD & PZD designs only)	M69	No Charge

Note:

1. M14 and B238 (2-3/8" backset) standard with D138 (1-3/8" door thickness) option.

**Standard Features**

**Handing**

Field reversible

**Door Thickness**

1-3/4" - 2"

**Backset**

2-3/4"

**Strike**

ANSI curved lip 4-7/8" - 1-1/4" x  
1-1/4" lip to center

**Cylinder**

Brass, 6-pin, L4 keyway  
0-bitted

**Keys**

Two nickel silver keys

**Case Quantity**

10

**Case Weight**

32 lbs

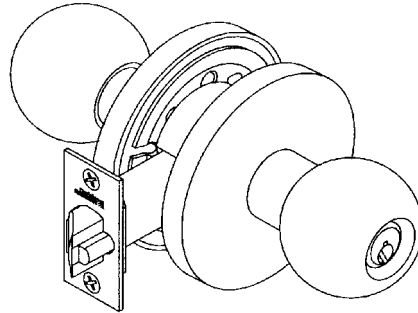

**Ordering Example**

**Stock Order**

Quantity	Series/Function	Trim	Finish	Hand
100	CK4355	GRD	630	RHR

**Contract/Detailed Order**

Quantity	Keyset	Series/Function	Trim	Finish	Hand	Strike	Misc. Options	Cylinder and Keying
24	AA1	CK4355	GRD	630	RHR	SA112	M02	VKC3

### Knob Designs: GRD

**Knob:**

 Wrought  
Reinforced

**Rose:**

 Wrought  
Reinforced

Function	Description		GRD
			Finish: 605, 613E, 630
CK4310	Non-Keyed	Passage	\$576.00
CK4320		Privacy	\$647.00
CK4350		Half Dummy	\$248.00
CK4351	Single Cylinder	Entrance	\$715.00
CK4355		Classroom	
CK4357		Storeroom	
CK4332	Double Cylinder	Institution	\$779.00

### Cylinder Options

Description	Specify Quick Code	Add or Deduct
Conventional 6-pin	(standard)	No Charge
Less (1) Cylinder	LC	Deduct \$79.00 per cylinder
Access 3 Patented	AP	No Charge
Access 3 Security	AS	Add \$55.00 per cylinder
Access 3 High Security, UL 437	AHS	Add \$79.00 per cylinder
Pyramid Security Fixed Core	PS	Add \$55.00 per cylinder
Pyramid High Security Fixed Core	PHS	Add \$82.00 per cylinder
Security	HS	Add \$105.00 per cylinder

### Keying Options\*

Description	Specify Quick Code	Add or Deduct
0-Bitted with 2 blank keys	(standard)	No Charge
Keyed random	KR	
Master keyed	Specify keyset	Add \$16.00 per cylinder
Master keyed Pyramid	Specify keyset	Add \$16.00 per cylinder
Master keyed Security	Specify keyset	Add \$16.00 per cylinder
Master keyed	Specify keyset	No Charge
Master keyed to customer bittings or sample key	Specify keyset	Add \$16.00 per cylinder
Construction master keyed <sup>1,2</sup>	CMK	Add \$16.00 per cylinder
Visual key control (VKC)		
-No stamping	VKC0	\$4.50
-Keys only	VKC1	No Charge
-Cylinder and Keys <sup>3</sup>	VKC2	\$8.00
-Cylinders only <sup>3</sup>	VKC3	\$8.00
Concealed key control (CKC)		
-CKC cylinders with VKC keys	CKC2	\$8.00
-CKC cylinders only <sup>3</sup>	CKC3	\$8.00
More than 2 keys per lock	KY# (e.g., KY6)	See page 66 - Cut Keys Section

**Notes:**

1. CMK Construction master keying charge is in addition to master keying charge.
2. CMK Construction master keying is not available in Pyramid or Security series.
3. VKC2, VKC3, CKC3 are not available in Access 3, Pyramid or Security series.

\*Double cylinder keying: unless otherwise specified, both cylinders of 32 functions will be keyed alike.  
If different keying is required, specify outside cylinder first, then inside cylinder.  
For key bows other than 10 and 90, specify "KB" + bow number as Quick Code, e.g. KB12. No extra charge.

**Strike Options\***

To purchase strike separately, see catalog or parts manual for part number.

Lip Length	ANSI Curved Lip - Specify Quick Code	Curved Lip Box - Specify Quick Code	Add or Deduct
1"	SA100	SC100	No Charge
1-1/8"	SA118	SC118	
1-1/4"	(standard)	SC114	
1-3/8"	SA138	SC138	
1-1/2"	SA112	SC112	
1-3/4"	SA134	SC134	
2"	SA200	SC200	Add \$16.00 per lockset
2-1/4"	SA214	SC214	
2-1/2"	SA212	SC212	
2-3/4"	SA234	SC234	
3"	SA300	SC300	

\*If door thickness is standard or has been specified and no special door or frame condition exist, then only the first two characters of the optional strike Quick code must be specified(e.g. "SC").  
The correct lip length will be determined by our order entry system based on the standard or specified door thickness.

**Backset Options**

Description	Specify Quick Code	Add or Deduct
2-3/4"	(standard)	No Charge

**Door Thickness Options**

Description	Specify Quick Code	Add or Deduct
1-3/4" - 2"	(standard)	No Charge

**Miscellaneous Options**

Description	Specify Quick Code	Add or Deduct
Spanner head screws	M02	Add \$18.00 per lockset
Torx® head screws	M04	Add \$24.00 per lockset
ANSI wrought strike box	M17	No Charge

**Standard Features**

**Handing**

Field reversible

**Door Thickness**

1-3/8" - 1-3/4"

**Backset**

2-3/4"

**Strike**

ANSI curved Lip 4-7/8" x 1-1/4"  
x 1-1/4" lip to center

**Cylinder**

Brass, 6-pin, L4 keyway,  
0-bitted

**Keys**

Two nickel silver keys

**Case Quantity**

20

**Case Weight**

40 lbs

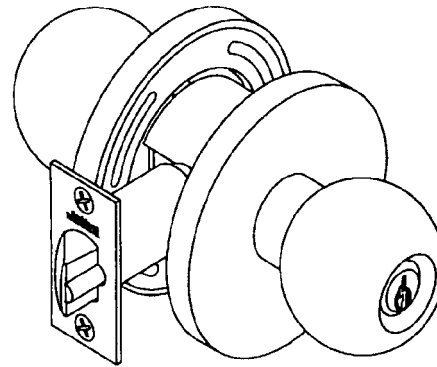

**Ordering Example**

**Stock Order**

Quantity	Series/Function	Trim	Finish	Hand
100	CK4451	GWC	630	RHR

**Split Trim/Split Finish Order** (Privacy function CK4430 only: inside finish 629 only)

Quantity	Series/Function	Finish	Finish		Hand
			Outside	Inside	
12	CK4430	GWC	605	629	RHR

**Contract/Detailed Order**

Quantity	Keyset	Series/Function	Trim	Finish	Hand	Strike	Misc. Options	Cylinder and Keying
24	AA1	CK4451	GWC	630	RHR	SA200	M17	VKC1

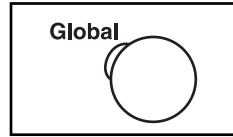

**Knob Designs: GWC**
**Knob:**  
Wrought

**Rose:**  
Wrought  
Reinforced

Function	Description	GWC		
		Finish: 630	Finish: 605, 612, 613, 629	
CK4410	Non-Keyed	Passage	\$187.00	\$203.00
CK4480		Communicating		
CK4430		Privacy	\$206.00	\$222.00
CK4440		Patio		
CK4450	Half Dummy	\$158.00	\$166.00	
CK4451	Single Cylinder	Entrance	\$264.00	\$280.00
CK4455		Classroom		
CK4457		Storeroom		
CK4429		Hotel		
CK4482	Double Cylinder	Storeroom	\$343.00	\$359.00

**Cylinder & Keying Options\***

Description	Specify Quick Code	Add or Deduct
Conventional 6-pin	(standard)	No Charge
Less (1) cylinder	LC	Deduct \$79.00 per cylinder
Less hotel cylinder	LC	Deduct \$93.00
0-Bitted with 2 blank keys	(standard)	No Charge
Keyed random	KR	No Charge
Master keyed*	specify keyset	Add \$16.00 per cylinder
Master keyed to customer bittings or sample key	specify keyset	Add \$16.00 per cylinder
Construction master keyed <sup>1</sup>	CMK	Add \$16.00 per cylinder
Visual key control (VKC)		
-No stamping	VKC0	\$4.50
-Keys only	VKC1	No Charge
Concealed key control (CKC)		
-CKC cylinders with VKC keys	CKC2	\$8.00
-CKC cylinders only	CKC3	\$8.00
More than 2 keys per lock	KY# (e.g., KY6)	See page 66 - Cut Keys Section

Notes:

1. CMK Construction master keying charge is in addition to master keying charge.

\*Both cylinders of double cylinder function locksets will be keyed alike, unless otherwise specified.

If different keying is required, specify outside cylinder first, then inside cylinder.

For key bows other than 10 and 90, specify "KB" + bow number as Quick Code, e.g. KB12. No extra charge.

**Backset Options**

Description	Specify Quick Code	Add or Deduct
2-3/8"	B238	No Charge
2-3/4"	(standard)	
3-3/4"	B334	Add \$12.00 to lockset
5"	B500	Add \$14.00 to lockset

### Strike Options\*

To purchase strike separately, see catalog or parts manual for part no.

### Strike Options\* (to purchase strike separately, see catalog or parts manual for part no.)

Lip Length	ANSI Curved Lip Specify Quick Code	Curved Lip Box Specify Quick Code	Full Lip Specify Quick Code	Full Lip Radius Corner Specify Quick Code	Add or Deduct
1"	SA100	SC100			No Charge
1-1/8"	SA118	SC118			
1-1/4"	(standard)	SC114	SF114	SFR114	
1-3/8"	SA138	SC138			
1-1/2"	SA112	SC112			Add \$16.00 per lockset
1-3/4"	SA134	SC134			
2"	SA200	SC200			
2-1/4"	SA214	SC214			
2-1/2"	SA212	SC212			
2-3/4"	SA234	SC234			
3"	SA300	SC300			

\*If door thickness is standard or has been specified and no special door or frame condition exist, then only the first two characters of the optional strike Quick Code must be specified (e.g. "SC").

### Miscellaneous Options

Description	Specify Quick Code	Add or Deduct
Split designs and split finishes	Outside Trim x Inside Trim	Higher set price prevails
NOTE: Split finish on inside must be 629 for CK4430 only.		
1" latch front, square corners (for 2-3/8" backset only)	M14	Add \$6.00 per lockset
ANSI wrought strike box	M17	No Charge
Abrasive coat outside and inside	M23	Add \$85.00 per lockset
Abrasive coat inside only	M24	Add \$43.00 per lockset
Abrasive coat outside only	M25	Add \$43.00 per lockset

**AUXILIARY HARDWARE**
**PAGES**
**Pre-Assembled Unit Locksets:**

UT5200 Series Standard Features & Ordering Examples	183
UT5200 Series Lever Designs	184
UT5200 Series Cylinder Options	185
UT5200 Series Keying Options	186
UT5200 Series Strike, Miscellaneous Options	187
Notes	188

**PL5000 Series Padlocks:**

PL5000 Series Standard Features & Ordering Example	189
PL5000 Series Cylinder & Keying, Miscellaneous Options	190

**DL2200 Series Cylindrical Deadlocks:**

DL2200 Series Standard Features & Ordering Example	191
DL2200 Series Cylinder & Keying Options	192
DL2200 Series Strike, Door Thickness, Miscellaneous Options	193

**DL3000 Series Cylindrical Deadlocks:**

DL3000 Series Standard Features & Ordering Example	194
DL3000 Series Cylinder & Keying Options	195
DL3000 Series Strike, Door Thickness, Miscellaneous Options	196

**DL3200 Series Cylindrical Deadlocks:**

DL3200 Series Standard Features & Ordering Example	197
DL3200 Series Cylinder & Keying Options	198
DL3200 Series Strike, Door Thickness, Miscellaneous Options	199

**DL4100 Series Mortise Deadlocks:**

DL4100 Series Standard Features & Ordering Example	200
DL4100 Series Cylinder & Keying Options	201
DL4100 Series Strike, Door Thickness, Miscellaneous Options	202

**Standard Features**

**Handing**

Specify hand

**Door Thickness**

1-3/4" only

**Backset**

2-3/4" only

**Strike**

ANSI curved lip 4-7/8" x 1-1/4" x 1-1/4" lip to center

**Cylinder**

Brass, 6-pin, L4 keyway, 0-bitted

**Keys**

Two nickel silver keys

**Case Quantity**

6 leversets  
9 knobsets

**Case Quantity**

36

**Case Weight**

45 lbs

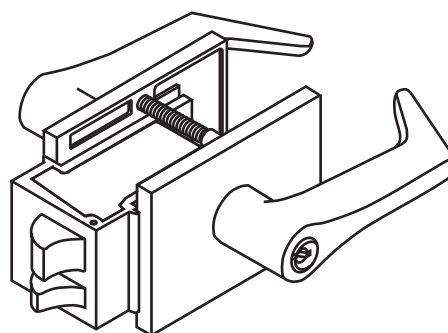

Now available with MicroShield® antimicrobial finish. Specify 626C finish (\$35.00 upcharge per lockset)

**Ordering Example**

**Stock Order**

Quantity	Series/Function	Trim	Finish	Hand
100	UT5251	ESE	626	RH

**Split Trim/Split Finish Order**

Quantity	Series/Function	Trim	Finish		Hand
			Outside	Inside	
12	UT5251	ESE	626	625	RHR

**Contract/Detailed Order**

Quantity	Keyset	Series/Function	Trim	Finish	Hand	Strike	Misc. Options	Cylinder and Keying
24	AA1	UT5251	ESE	626	RHR	SC200	M21	MR-VKC3

**Lever Designs: ESE**

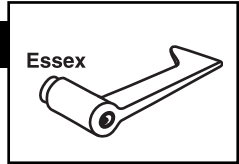

**Lever:**  
Forged

**Escutcheon:**  
Forged



Function	Description		ESE
			Finish: 612, 613, 613E, 625, 626
UT5210	Non-keyed	Passage or Closet	\$1,206.00
UT5220		Privacy	\$1,288.00
UT5251	Single Cylinder	Entrance	\$1,374.00
UT5255		Classroom	
UT5257		Storeroom	
UT5282	Double Cylinder	Store Door	\$1,453.00

**Cylinder Options**

Description	Specify Quick Code	Add or Deduct
Conventional 6-pin	(standard)	No Charge
Less (1) Cylinder	LC	Deduct \$79.00 per cylinder
Access 3 Patented	AP	No Charge
Access 3 Security	AS	Add \$56.00 per cylinder
Access 3 High Security, UL 437	AHS	Add \$79.00 per cylinder
Access 3 IC Patented	ACP	Add \$74.00 per cylinder
Access 3 IC Security	ACS	Add \$123.00 per cylinder
Access 3 IC High Security, UL 437	ACHS	Add \$143.00 per cylinder
Pyramid Security Fixed Core	PS	Add \$58.00 per cylinder
Pyramid Security IC	PCS	Add \$129.00 per cylinder
Pyramid High Security Fixed Core	PHS	Add \$86.00 per cylinder
Pyramid High Security IC	PCHS	Add \$158.00 per cylinder
Pyramid IC with Temporary Construction Core	CTP	Add \$74.00 per cylinder
Pyramid IC with Temporary Disposable Core	CTPD	No Charge
Pyramid IC Less Core	CLP	No Charge
Security	HS	Add \$111.00 per cylinder
Security IC	CHS	Add \$183.00 per cylinder
IC 6-pin	C6	Add \$74.00 per cylinder
IC 6-pin with Temporary Construction Core (Red)	CT6R	Add \$74.00 per cylinder
IC 6-pin with Temporary Construction Core (Blue)	CT6B	Add \$74.00 per cylinder
IC 6-pin with Temporary Construction Core (Green)	CT6G	Add \$74.00 per cylinder
IC 6-pin with Temporary Disposable Core	CT6D	No Charge
IC 6-pin with Small Format Temporary Disposable Core	CTSD	No Charge
IC 6-pin Less Core	CL6	No Charge
IC 7-pin	C7	Add \$76.00 per cylinder
IC 7-pin with Temporary Construction Core (Red)	CT7R	Add \$76.00 per cylinder
IC 7-pin with Temporary Construction Core (Blue)	CT7B	Add \$76.00 per cylinder
IC 7-pin with Temporary Construction Core (Green)	CT7G	Add \$76.00 per cylinder
IC 7-pin with temporary Disposable Core	CT7D	No Charge
IC 7-pin Less Core	CL7	No Charge
Master Ring	MR	\$47.00

**Keying Options\***

Description	Specify Quick Code	Add or Deduct
0-Bitted with 2 blank keys	(standard)	No Charge
Keyed Random	KR	
Master keyed (all cylinders except 8000, 8020, 8027 IC core)	Specify keyset	Add \$16.00 per cylinder
Master keyed Pyramid	Specify keyset	
Master keyed Security (including IC cylinder and core)	Specify keyset	
Master keyed (8000, 8020, 8027 IC core)	Specify keyset	No Charge
Master keyed to customer bittings or sample key	Specify keyset	Add \$16.00 per cylinder
Construction master keyed <sup>1,2</sup>	CMK	Add \$16.00 per cylinder
Visual key control (VKC)		
-No stamping	VKC0	\$4.50
-Keys only	VKC1	No Charge
-Cylinder and Keys <sup>3</sup>	VKC2	\$8.00
-Cylinders only <sup>3</sup>	VKC3	
Concealed key control (CKC)		
-CKC cylinders with VKC keys	CKC2	\$8.00
-CKC cylinders only <sup>3</sup>	CKC3	
More than 2 keys per lock	KY# (e.g., KY6)	See page 66 - Cut Keys Section

**Notes:**

1. CMK Construction master keying charge is in addition to master keying charge.
2. CMK Construction master keying is not available in Pyramid or Security series.
3. VKC2, VKC3, CKC3 are not available in Access 3, Pyramid or Security series.

\*Double cylinder keying: unless otherwise specified, both cylinders of 32 and 82 functions will be keyed alike. The inside cylinder of 72 function will be keyed to the master key(s) only, while the outside cylinder will include the change key.

If different keying is required, specify outside cylinder first, then inside cylinder.

For key bows other than 10 and 90, specify "KB" + bow number as Quick Code, e.g. KB12. No extra charge.

**Strike Options\***

To purchase strike separately, see catalog for part no.

Lip Length	ANSI Curved Lip Specify Quick Code	T-Strike Curved Lip Box Specify Quick Code	Add or Deduct
1-1/4"	Standard	NA	No Charge
2"	N/A	SC200	Add \$16.00 per lockset
2-1/8"	N/A	SC218	
2-1/4"	N/A	SC214	
2-1/2"	N/A	SC212	
2-3/4"	N/A	SC234	
3"	N/A	SC300	

Lip Length	ANSI Straight Lip For Door Pair** Quick Code	For Door Pair** Quick Code	Add or Deduct
1-13/16"	SA136	SP136	No Charge

Lip length	ANSI Straight Lip For Extended Lip Escutcheon Quick Code	For Extended Lip Escutcheon Quick Code	Add or Deduct
15/16"	Standard when Extended Lip Option is Specified	SX156	No Charge

\*If door thickness is standard or has been specified and no special door or frame condition exist, then only the first two characters of the optional strike Quick code must be specified (e.g. "SC").

The correct lip length will be determined by our order entry system based on the standard or specified door thickness.

\*\* Lip is measured from back of strike.

**Miscellaneous Options**

Description	Specify Quick Code	Add or Deduct
Split designs and split finishes	Outside Trim x Inside Trim	Higher set price prevails
Spanner head screws	M02	Add \$18.00 per lockset
Torx® head screws (on strike)	M04	Add \$24.00 per lockset
Lever to accept 6 or 7-pin SFIC (ESE only)	M08	Deduct \$20.00 per lockset
Extended lip escutcheon (for single door reverse bevel; 630 finish to match 626 only)	M11	Add \$52.00 per lockset
Knurling outside and inside	M20	Add \$137.00 per lockset
Knurling outside only	M21	Add \$69.00 per lockset
Knurling Inside only	M22	
Abrasive coat outside and inside	M23	
Abrasive coat inside only	M24	Add \$43.00 per lockset
Abrasive coat outside only	M25	
Lead lining escutcheon	M28	Add \$90.00 per escutcheon
Unstaked lever retainer	M33	No Charge



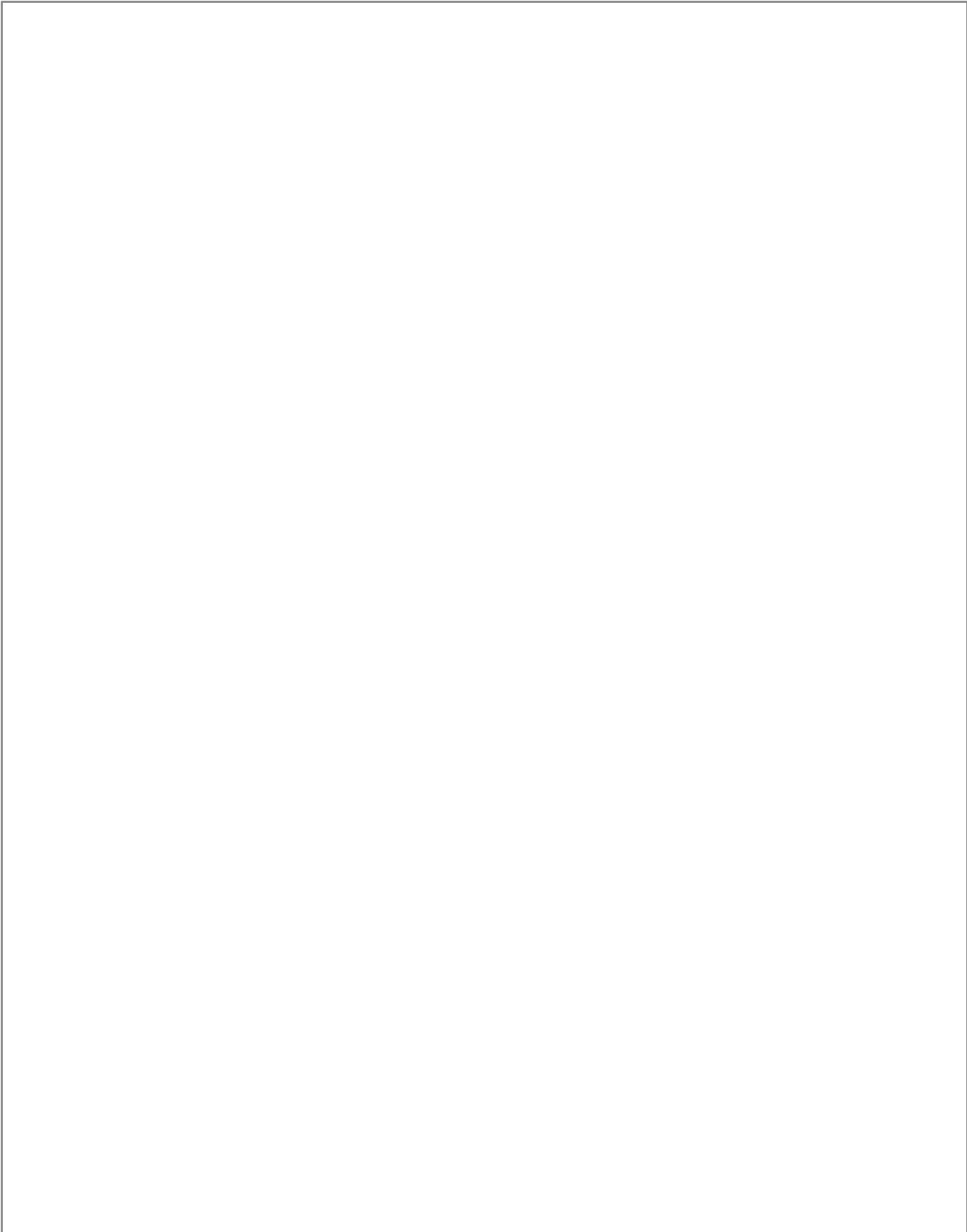

**Standard Features**
**Case**

Extruded Brass

**Shackle**

1 1/32" (8.7mm) diameter hardened steel (PL5000 Series), brass (PL5100 Series) or stainless steel (PL5200 Series)

**Locking**

Ball-bearing locking heel and toe

**Cylinder**

 RFC model: 6-pin Fixed Core (2300)  
 IC model: 6-pin & Pyramid IC (8000 series)  
 L4 keyway standard

**Case Quantity**

36

**Case Weight**

27 lbs

**Ordering Example**
**Stock Order**

Quantity	Series/Function
10	PL5000R

**Access 3 Order**

Quantity	Series/Function	Misc. Options
8	PL5070	ACP M44

**Contract Order**

Quantity	Keyset	Series/Function	Shackle Length	Misc. Options
10	AA1	PL5080	258	M45

**Padlocks**

Hardened Steel Shackle	Brass Shackle	Description	List Price
PL5000R	PL5100R	Rekeyable Fixed Core (RFC)	\$101.00
PL5070*	PL5170*	Interchangeable core (IC), less core	\$107.00
PL5080	PL5180	IC 6-pin	\$181.00
PL5090	PL5190	IC security	\$290.00
PL5030	PL5130	Pyramid High Security (IC)	\$265.00
PL5037	PL5137	Pyramid Security (IC)	\$236.00

Stainless Steel Shackle	Description	List Price
PL5200R	Rekeyable Fixed Core (RFC)	\$106.00
PL5270*	Interchangeable core (IC), less core	\$112.00
PL5280	IC 6-pin	\$186.00
PL5290	IC security	\$295.00
PL5230	Pyramid High Security (IC)	\$270.00
PL5237	Pyramid Security (IC)	\$241.00

**Shackle Length Options with Padlocks**

Description	Specify Quick Code	Add or Deduct
7/8"	(standard)	No Charge
2-5/8"	258	Add \$5.00 to padlock

\* Access 3 is only available with Less Core.

**Cylinder & Keying Options\***

Description	Specify Quick Code	Add or Deduct
Access 3 IC Patented	ACP	Add \$74.00 per cylinder
Access 3 IC Security	ACS	Add \$123.00 per cylinder
Access 3 IC High Security, UL 437	ACHS	Add \$143.00 per cylinder
Keyed random (standard for Pyramid & IC security padlocks)	KR	No Charge
0-Bitted (not available for Pyramid & IC security padlocks)	(standard)	
Master Keyed RFC	specify keyset	Add \$16.00 per cylinder
Master Keyed IC security	specify keyset	
Master Keyed IC 6-pin & Pyramid IC	specify keyset	No Charge
Master Keyed to customer bittings or sample key	specify keyset	Add \$16.00 per cylinder
Construction Master Keyed (RFC & IC 6-pin padlocks only) <sup>1,2</sup>	CMK	Add \$16.00 per cylinder
Temporary construction core (IC 6-pin padlocks only) (Red)	CT6R	No Charge
Temporary Construction Core (IC 6-pin padlocks only) (Blue)	CT6B	No Charge
Temporary Construction Core (IC 6-pin padlocks only) (Green)	CT6G	No Charge
Visual key control (VKC)		
- No Stamping	VKC0	\$4.50
- Keys only	VKC1	No Charge
- Locks and Keys <sup>3</sup> (RFC & IC 6-pin padlocks only)	VKC2	\$8.00
- Locks only <sup>3</sup> (RFC & IC 6-pin padlocks only)	VKC3	
Concealed key control (CKC) (IC 6-pin & IC security padlocks only)		
- CKC cores with VKC keys <sup>4</sup>	CKC2	\$8.00
- CKC cores only <sup>3,4</sup>	CKC3	
More than 2 keys per lock	KY# (e.g., KY6)	See page 66 - Cut Keys Section
Rekeybale FC (RFC) Less Cylinder	LC	Deduct \$20.00

**Notes:**

1. CMK Construction master keying charge is in addition to master keying charge.
  2. CMK is not available in Pyramid or Security series.
  3. VKC2, VKC3, CKC3 are not available in Access 3, Pyramid or Security series.
  4. CKC2, CKC3 is not available in PL5000, PL5100, PL5070 or PL5170 padlock.
- \*For key bows other than 10 and 90, specify "KB" + bow number as Quick Code, e.g. KB12. No extra charge.

**Miscellaneous Options**

Description	Specify Quick Code	Add or Deduct
Chain and clevis attached	M44	Add \$4.00 per padlock
Custom die stamped case* (specify existing die number or lettering specifications for artwork)	M45**	Add \$5.5 per padlock

\*To create new die stamp, contact factory. Provide artwork with request for quotation.  
Die stamps remain the property of Corbin Russwin.

\*\*Only available on PL5200 Series stainless steel shackle padlocks.

**ANSI/BHMA 156.5  
Grade 2**

**Standard Features**

**Handing**

Non-handed

**Door Thickness**

1-3/8" - 2-1/4"

**Backset**

2-3/4" (standard)  
2-3/8" available

**Strike**

2-3/4" x 1-1/8"

**Cylinder**

Brass 6-pin,  
0-bitted, L4 keyway

**Keys**

Two nickel silver keys

**Case Quantity**

14

**Case Weight**

30 lbs

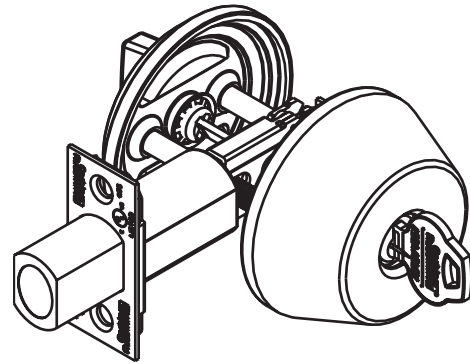

**Ordering Example**

**Stock Order**

Quantity	Series/Function	Finish
30	DL2213	626

**Contract Order**

Quantity	Keypad	Finish	Keypad	Optional Strike
30	DL2213	626	AA1	SS134

Function	Description	Finish: 613E, 626, BSP	Finish: 605, 606, 612, 613, 625
DL2213	Single Cylinder	\$107.00	\$111.00
DL2212	Double Cylinder	\$139.00	\$145.00
DL2217	Classroom	\$107.00	\$111.00
DL2211	Cylinder x Blank		
DL2260	Thumbturn x Blank	\$78.00	\$82.00

### Cylinder & Keying Options\*

Description	Specify Quick Code	Add or Deduct
Conventional 6-pin	(standard)	No Charge
Conventional 7-pin	7P	Add \$2.00 per cylinder
Less cylinder	LC	No Deduct
Interchangeable core (IC) 6-pin	C6	Add \$74.00 per cylinder
IC 6-pin less core	CL6	No Charge
SFIC 6-pin with Less Core	CLS6	No Charge
IC 6-pin with temporary construction core	CT6	Add \$74.00 per cylinder
IC 7-pin	C7	Add \$76.00 per cylinder
IC 7-pin less core	CL7	No Charge
SFIC 7-pin with Less Core	CLS7	No Charge
IC 7-pin with temporary construction core	CT7	Add \$76.00 per cylinder
Security	HS	Add \$111.00 per cylinder
Security IC	CHS	Add \$183.00 per cylinder
Access 3 Patented	AP	No Charge
Access 3 Security	AS	Add \$56.00 per cylinder
Access 3 High Security, UL 437	AHS	Add \$79.00 per cylinder
Access 3 IC Patented	ACP	Add \$74.00 per cylinder
Access 3 IC Security	ACS	Add \$123.00 per cylinder
Access 3 IC High Security, UL 437	ACHS	Add \$143.00 per cylinder
Pyramid High Security Fixed Core	PHS	Add \$86.00 per cylinder
Pyramid High Security IC	PCHS	Add \$158.00 per cylinder
Pyramid Security Fixed Core	PS	Add \$58.00 per cylinder
Pyramid Security IC	PCS	Add \$129.00 per cylinder
0-Bitted with two blank keys	(standard)	No Charge
Keyed Random	KR	No Charge
Construction Master Keyed (not available for Pyramid & Security cylinders)'	CMK	Add \$16.00 per cylinder
<b>Visual key control (VKC)</b>		
- Keys only	VKC1	No Charge
- Cylinders and Keys (not for Access 3, Pyramid, HS or CHS)	VKC2	\$8.00
- Cylinders only (not for Access 3, Pyramid, HS or CHS)	VKC3	
<b>Concealed key control (CKC)</b>		
- CKC cylinders with VKC keys	CKC2	\$8.00
- CKC cylinders only	CKC3	
More than 2 keys per lock	KY# (e.g., KY6)	See page 66 - Cut Keys Section

**Notes:**

1. CMK Construction master keying charge is in addition to master keying charge.

\*Both cylinders of double cylinder deadlocks are keyed alike, unless otherwise specified. If different keying is required, specify outside cylinder first, then inside cylinder.

For key bows other than 10 and 90, specify 'KB' + bow number as Quick Code, e.g. KB12.

Note: KB92 cannot be furnished with VKC or other markings.

**Strike Options**

To purchase strike separately, see catalog or parts manual for part no.

Lip Length	ANSI Straight Lip - Specify Quick Code	Add or Deduct
7/8"	SS078	No Charge
1-1/8"	SS118	
1-1/4"	SS114	
1-3/8"	SS138	
1-1/2"	SS112	
1-3/4"	SS134	
2"	SS200	Add \$16.00 per lockset
2-1/4"	SS214	
2-1/2"	SS212	
2-3/4"	SS234	
3"	SS300	

**Door Thickness Options**

Description	Specify Quick Code	Add or Deduct
1-3/8"	D138	No Charge
1-3/4"	(standard)	No Charge
2"	D200	No Charge
2-1/4"	D214	No Charge

**Miscellaneous Options**

Description	Specify Quick Code	Add or Deduct
1" (25mm) bolt front, square corners	M14	Add \$6.00 per lockset
ANSI wrought strike box	M17	
Plastic box for standard strike	(standard)	
2-3/8" (60mm) backset bolt	B238	

**Standard Features**

**Handing**

Non-handed, except DL3017 function

**Door Thickness**

1-3/4" - 2-1/4"

**Backset**

2-3/4" (standard)

**Strike**

Wrought brass or bronze  
2-3/4" x 1-1/8" with  
wrought box

**Cylinder**

Brass 6-pin,  
0-bitted, L4 keyway

**Keys**

Two nickel silver keys

**Weight**

2.5 lbs each

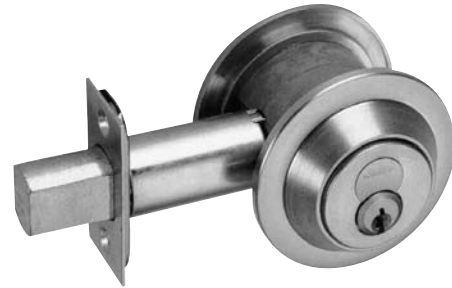

**Ordering Example**

**Stock Order**

Quantity	Series/Function	Finish
30	DL3013	626

**Contract Order**

Quantity	Keypad	Finish	Keypad	Optional Strike
30	DL3013	626	AA1	SD002

Function	Description	Finish: 605, 606, 612 613 613E, 618, 619, 625, 626, 722, BSP
DL3013	Single Cylinder	\$250.00
DL3012	Double Cylinder	\$336.00
DL3017	Classroom*	\$256.00
DL3011	Cylinder x Blank	\$250.00
DL3060	Thumbturn x Blank	

\*Thumbturn will not project deadbolt. Specify hand.

### Cylinder & Keying Options\*

Description	Specify Quick Code	Add or Deduct
Conventional 6-pin	(standard)	No Charge
Conventional 7-pin	7P	Add \$2.00 per cylinder
Less cylinder	LC	Deduct \$86.00 per cylinder
Access 3 Patented	AP	No Charge
Access 3 Security	AS	Add \$56.00 per cylinder
Access 3 High Security, UL 437	AHS	Add \$79.00 per cylinder
Access 3 IC Patented	ACP	Add \$74.00 per cylinder
Access 3 IC Security	ACS	Add \$123.00 per cylinder
Access 3 IC High Security, UL 437	ACHS	Add \$143.00 per cylinder
Pyramid Security fixed core	PS	Add \$58.00 per cylinder
Pyramid Security IC	PCS	Add \$129.00 per cylinder
Pyramid High Security fixed core	PHS	Add \$74.00 per cylinder
Pyramid High Security IC	PCHS	Add \$158.00 per cylinder
Pyramid IC with Temporary Construction Core	CTP	Add \$74.00 per cylinder
Security	HS	Add \$111.00 per cylinder
Security IC	CHS	Add \$183.00 per cylinder
IC 6-pin	C6	Add \$74.00 per cylinder
IC 6-pin with temporary construction core	CT6	\$74.00
UL IC 6-Pin Housing Less Core	CL6AH	
UL IC 6-Pin Housing with Disposable Core	CTAHD	
UL IC 6-Pin Housing with (Red/Blue/Green) Temporary Construction Core	CT6AH(R/B/G)	\$160.00
IC 6-pin less core	CL6	No Charge
SFIC 6-pin with Less Core	CLS6	
SFIC 7-pin less core	CLS7	
IC 7-pin	C7	Add \$76.00 per cylinder
IC 7-pin Less Core	CL7	Add \$2.00 per cylinder
IC 7-pin with Temporary Construction Core	CT7 (R/B/G)	Add \$76.00 per cylinder
0-Bitted with 2 blank keys	(standard)	No Charge
Keyed random	KR	
Construction master keyed <sup>1,2</sup>	CMK	Add \$16.00 per cylinder
Visual key control (VKC)		
- Keys only	VKC1	No Charge
- Cylinders and Keys <sup>3</sup>	VKC2	\$8.00
- Cylinders only <sup>3</sup>	VKC3	
Concealed key control (CKC)		
- CKC cylinders with VKC keys	CKC2	\$8.00
- CKC cylinders only <sup>3</sup>	CKC3	
More than 2 keys per lock	KY# (e.g., KY6)	See page 66 - Cut Keys Section

**Notes:**

1. CMK Construction master keying charge is in addition to master keying charge.
2. CMK is not available in Pyramid or Security series.
3. VKC2, VKC3, CKC3 are not available in Access 3, Pyramid or Security series.  
\*Both cylinders of double cylinder deadlocks are keyed alike, unless otherwise specified. If different keying is required, specify outside cylinder first, then inside cylinder. For key bows other than 10 and 90, specify "KB" + bow number as Quick Code, e.g. KB12. No extra charge.
4. Refer to page 47 for example of CTP option pricing.



**Strike Options\***

To purchase strike separately, see catalog or parts manual for part no.

Lip Length	ANSI Straight Lip - Specify Quick Code	Add or Deduct
7/8"	SS078	No Charge
1-1/8"	SS118	
1-1/4"	SS114	
1-3/8"	SS138	
1-1/2"	SS112	
1-3/4"	SS134	Add \$16.00 per lockset
2"	SS200	
2-1/4"	SS214	
2-1/2"	SS212	
2-3/4"	SS234	
3"	SS300	

**Strike Options (No lip)**

	Specify Quick Code	Add or Deduct
2-3/4" x 1-1/8"	(standard)	No Charge
3-1/2" x 1-1/8"	SD001	

**Door Thickness Options**

Description	Specify Quick Code	Add or Deduct
1-3/8" (Not available in IC option)	D138	No Charge
1-3/4" - 2"	(standard)	
2-1/4"	D214	Add \$7.00 per deadlock

**Miscellaneous Options**

Description	Specify Quick Code	Add or Deduct
ANSI wrought box	M17	No Charge
Ergonomic Thumbturn	M34	Add \$14.00
Wrought box for standard strike	(standard)	No Charge
2-3/8" backset	B238	

**Standard Features**

**Handing**

Non-handed

**Door Thickness**

1-3/8" - 2-1/4"

**Backset**

2-3/4" (standard)  
2-3/8" available

**Strike**

2-3/4" x 1-1/8"

**Cylinder**

Brass 6-pin,  
0-bitted, L4 keyway

**Keys**

Two nickel silver keys

**Case Quantity**

14

**Case Weight**

30 lbs

**ANSI/BHMA 156.5**

**Grade 1**

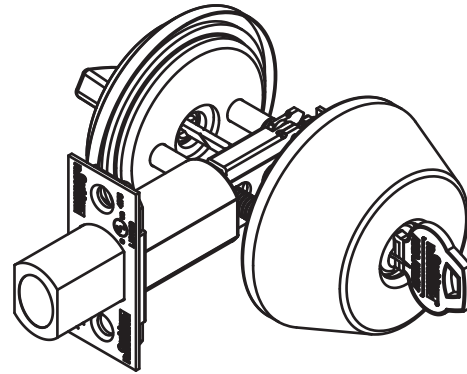

**Ordering Example**

**Stock Order**

Quantity	Series/Function	Finish
30	DL3213	626

**Contract Order**

Quantity	Keypad	Finish	Keypad	Optional Strike
30	DL3213	626	AA1	SS134

Function	Description	Finish: 613E, 626, BSP	Finish: 605, 606, 612, 613, 625
DL3213	Single Cylinder	\$192.00	\$199.00
DL3212	Double Cylinder	\$271.00	\$278.00
DL3217	Classroom	\$192.00	\$199.00
DL3211	Cylinder x Blank		
DL3260	Thumbturn x Blank	\$167.00	\$171.00

## Cylinder & Keying Options\*

Description	Specify Quick Code	Add or Deduct
Conventional 6-pin	(standard)	No Charge
Conventional 7-pin	7P	Add \$2.00 per cylinder
Less (1) cylinder	LC	Deduct \$79.00 per cylinder
IC 6-pin	C6	Add \$74.00 per cylinder
SFIC 6-pin with Less Core	CLS6	No Charge
IC 6-pin less core	CL6	No Charge
IC 6-pin with temporary construction core	CT6	Add \$74.00 per cylinder
IC 7-pin	C7	Add \$76.00 per cylinder
IC 7-pin with temporary construction core	CT7	Add \$76.00 per cylinder
SFIC 7-pin with Less Core	CLS7	No Charge
IC 7-pin less core	CL7	No Charge
Security	HS	Add \$111.00 per cylinder
Security IC	CHS	Add \$183.00 per cylinder
Access 3 Patented	AP	No Charge
Access 3 Security	AS	Add \$56.00 per cylinder
Access 3 High Security, UL 437	AHS	Add \$79.00 per cylinder
Access 3 IC Patented	ACP	Add \$74.00 per cylinder
Access 3 IC Security	ACS	Add \$123.00 per cylinder
Access 3 IC High Security, UL 437	ACHS	Add \$143.00 per cylinder
Pyramid High Security Fixed Core	PHS	Add \$86.00 per cylinder
Pyramid High Security IC	PCHS	Add \$158.00 per cylinder
Pyramid Security Fixed Core	PS	Add \$58.00 per cylinder
Pyramid Security IC	PCS	Add \$129.00 per cylinder
0-Bitted with 2 blank keys	(standard)	No Charge
Keyed Random	KR	
Construction Master Keyed (not available for Pyramid & Security cylinders) <sup>1</sup>	CMK	Add \$16.00 per cylinder
Visual key control (VKC)		
- Keys only	VKC1	No Charge
- Cylinders and Keys (not for Access 3, Pyramid, CHS)	VKC2	\$8.00
- Cylinders only (not for Access 3, Pyramid, CHS)	VKC3	
Concealed key control (CKC)		
- CKC cylinders with VKC keys	CKC2	\$8.00
- CKC cylinders only	CKC3	
More than 2 keys per lock	KY# (e.g., KY6)	See page 66 - Cut Keys Section

**Notes:**

1. CMK Construction master keying charge is in addition to master keying charge.

\*Both cylinders of double cylinder deadlocks are keyed alike, unless otherwise specified. If different keying is required, specify outside cylinder first, then inside cylinder.

For key bows other than 10 and 90, specify 'KB' + bow number as Quick Code, e.g. KB12.

NOTE: KB92 cannot be furnished with VKC or other markings.

**Strike Options**

To purchase strike separately, see catalog or parts manual for part no.

Lip Length	ANSI Straight Lip - Specify Quick Code	Add or Deduct
7/8"	SS078	No Charge
1-1/8"	SS118	
1-1/4"	SS114	
1-3/8"	SS138	
1-1/2"	SS112	
1-3/4"	SS134	Add \$16.00 per lockset
2"	SS200	
2-1/4"	SS214	
2-1/2"	SS212	
2-3/4"	SS234	
3"	SS300	

**Door Thickness Options**

Description	Specify Quick Code	Add or Deduct
1-3/8"	D138	No Charge
1-3/4"	(standard)	
2"	D200	
2-1/4"	D214	

**Miscellaneous Options**

Description	Specify Quick Code	Add or Deduct
1" (25mm) bolt front, square corners	M14	No Charge
ANSI wrought strike box	M17	
Plastic box for standard strike	(standard)	
2-3/8" (60mm) backset bolt	B238	

**Standard Features**

**Handing**

Non-handed

**Door Thickness**

1-3/4"

**Backset**

2-3/4"

**Strike**

Wrought brass or bronze  
3-1/2" x 1-1/8"

**Cylinder**

6-pin, L4 keyway, 0-bitted

**Keys**

Two nickel silver keys

**Weight**

2.25 lbs each

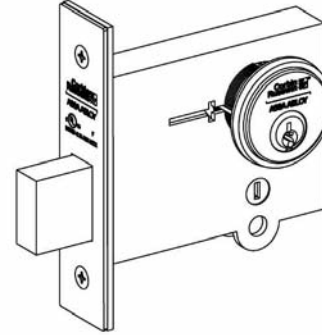

**Ordering Example**

**Stock Order**

Quantity	Series/Function	Finish
30	DL4113	626

**Contract Order**

Quantity	Keyset	Finish	Keyset	Optional Strike
30	DL4113	626	AA1	SS118

Function	Description	Finish: 613E, 626, BSP	Finish: 605, 606, 611, 612, 613, 618, 619, 625
DL4113	Single Cylinder	\$335.00	\$340.00
DL4112	Double Cylinder	\$373.00	\$378.00
DL4117	Classroom*	\$335.00	\$340.00
DL4111	Cylinder x Blank	\$287.00	\$292.00
DL4122	Double Cylinder x Thumbturn*	\$421.00	\$426.00
DL4160	Thumbturn x Blank	\$249.00	\$254.00

\*Thumbturn will not project deadbolt.

**Cylinder & Keying Options\***

Description	Specify Quick Code	Add or Deduct
Conventional 6-pin	(standard)	No Charge
Conventional 7-pin	7P	Add \$2.00 per cylinder
Less cylinder	LC	Deduct \$86.00 per cylinder
Access 3 Patented	AP	No Charge
Access 3 Security	AS	Add \$56.00 per cylinder
Access 3 High Security, UL 437	AHS	Add \$79.00 per cylinder
Access 3 IC Patented	ACP	Add \$74.00 per cylinder
Access 3 IC Security	ACS	Add \$123.00 per cylinder
Access 3 IC High Security, UL 437	ACHS	Add \$143.00 per cylinder
Pyramid High Security fixed core	PS	Add \$86.00 per cylinder
Pyramid High Security IC	PCS	Add \$158.00 per cylinder
Pyramid High Security fixed core	PHS	Add \$86.00 per cylinder
Pyramid High Security IC	PCHS	Add \$158.00 per cylinder
Security	HS	Add \$111.00 per cylinder
Security IC	CHS	Add \$183.00 per cylinder
IC 6-pin	C6	Add \$74.00 per cylinder
IC 6-pin less core	CL6	No Charge
SFIC 6-pin with Less Core <sup>2</sup>	CLS6	No Charge
IC 6-pin with SFIC disposable temporary core <sup>2</sup>	CT6SD	No Charge
IC 6-pin with temporary construction core	CT6	Add \$74.00 per cylinder
UL IC 6-Pin Housing Less Core	CL6AH	
UL IC 6-Pin Housing with Disposable Core	CTAHD	\$160.00
UL IC 6-Pin Housing with (Red/Blue/Green) Temporary Construction Core	CT6AH(R/B/G)	
IC 7-pin	C7	Add \$76.00 per cylinder
IC 7-pin less core	CL7	Add \$2.00 per cylinder
IC 7-pin with temporary construction core	CT7	Add \$76.00 per cylinder
SFIC 7-pin with Less Core <sup>2</sup>	CLS7	Add \$2.00 per cylinder
IC 7-pin with SFIC disposable temporary core <sup>2</sup>	CT7SD	Add \$2.00 per cylinder
0-Bitted with 2 blank keys	(standard)	No Charge
Keyed random	KR	
Construction master keyed <sup>1, 2</sup>	CMK	Add \$16.00 per cylinder
Visual key control (VKC)		
- Keys only	VKC1	No Charge
- Cylinders and Keys <sup>3</sup>	VKC2	\$8.00
- Cylinders only <sup>3</sup>	VKC3	
Concealed key control (CKC)		
- CKC cylinders with VKC keys	CKC2	\$8.00
- CKC cylinders only <sup>3</sup>	CKC3	
More than 2 keys per lock	KY# (e.g., KY6)	See page 66 - Cut Keys Section

## Notes:

1. CMK Construction master keying charge is in addition to master keying charge.

2. CMK is not available in Pyramid or Security series.

3. VKC2, VKC3, CKC3 are not available in Access 3, Pyramid or Security series.

\*Both cylinders of double cylinder deadlocks are keyed alike, unless otherwise specified. If different keying is required, specify outside cylinder first, then inside cylinder.

For key bows other than 10 and 90, specify "KB" + bow number as Quick Code, e.g. KB12.

4. Refer to page 47 for example of CTP option pricing.

**Strike Options**

To purchase strike separately, see catalog for part no.

Lip length	ANSI Straight Lip Specify Quick Code	Add or Deduct
7/8"	SS078	Add \$16.00 per lockset
1-1/8"	SS118	
1-1/4"	SS114	
1-3/8"	SS138	
1-1/2"	SS112	
1-3/4"	SS134	
2"	SS200	
2-1/4"	SS214	
2-1/2"	SS212	
2-3/4"	SS234	
3"	SS300	

**Door Thickness Options**

Description	Specify Quick Code	Add or Deduct
1-3/4" - 2"	(standard)	No Charge
2-1/4"	D214	
2-1/2"	D212	Add \$20.00 per dead lock
2-3/4"	D234	
3"	D300	
3-1/4"	D314	Add \$32.00 per deadlock
3-1/2"	D312	
3-5/8"	D358	
3-3/4"	D334	
3-7/8"	D378	
4"	D400	

**Miscellaneous Options**

Description	Specify Quick Code	Add or Deduct
Spanner head screws	M02	Add \$18.00 per lockset
Torx head screws	M04	Add \$24.00 per lockset
ANSI wrought box	M17	No Charge
Lead wrapped case	M29	Add \$265.00 per lockset
Ergonomic Thumbturn (specify door thickness)	M34	Add \$14.00 per TT
Box for standard strike	M40	No Charge

**MULTI-POINT LOCKS**
**PAGES**
**FE5400S Series Multi-Point Exit Device Latching System:**

FE5400S Series Standard Features	203
FE5400S Series Ordering Examples, Pricing	204
FE5400S Series Heavy-Duty Trim Designs: A9 Armstrong, C9 Citation, D9 Dirke, E9 Essex	205
FE5400S Series Heavy-Duty Trim Designs: L9 Lustra, N9 Newport, R9 Regis, PR9 Princeton	206
FE5400S Series Heavy-Duty Trim Designs: G9, TH900 Pull/Thumbpiece, P9 Pull	207
FE5400S Series Heavy-Duty Trim Designs: FR9 Frascati, M9 Merlot, Z9 Zinfandel	208
FE5400S Series Heavy-Duty Trim Designs: Museo® Georgia, Pablo, Jackson, Salvador, Marc, Piet	209
FE5400S Series Electrically Controlled Trim Designs: A9 Armstrong, C9 Citation, D9 Dirke, E9 Essex	210
FE5400S Series Electrically Controlled Trim Designs: L9 Lustra, N9 Newport, R9 Regis, PR9 Princeton	211
FE5400S Series Electrically Controlled Trim Designs: FR9 Frascati, M9 Merlot, Z9 Zinfandel	212
FE5400S Series Electrically Controlled Trim Designs: Museo® Georgia, Pablo, Jackson, Salvador, Marc, Piet	213
FE5400S Series Electrified Options & Accessories	214
FE5400S Series Cylinder & Keying Options	215
FE5400S Series Door Height, Door Width, Door Thickness, Miscellaneous Options	216
FE5400S Series Removable Mullions & Options	217
FE5400S Series Notes	218

**FE6600 Series Multi-Point Latching System:**

FE6600 Series Standard Features	219
FE6600 Series: LWA, RWA, LW1, LWN, LWP, LWR, ASA, CSA, LSA, NSA, PSA, RSA, NSM, NSN, NSR	220
FE6600 Series Designs: Georgia, Pablo, Jackson, Salvador, Marc	221
FE6600 Series Designs: Josef	222
FE6600 Series Designs: Josef, Georges	223
FE6600 Series Designs: Piet	224
FE6600 Series Designs: Piet	225
FE6600 Series Vandal Resistant Trim: ASV, CSV, DSV, ESV, LSV, NSV, PSV, RSV	226
FE6600 Series Cylinder & Keying Options	227
FE6600 Series Cylinder & Keying Options (Con't), Strike Options	228
FE6600 Series Door Thickness, Options, Thumbturn Options, Strike Options	229
Blank Page	230

**FE6700 Series Storm Shutter Multi-Point Latching System:**

FE6700 Series Standard Features, Ordering Example	231
FE6700 Series Designs	232
FE6700 Series Optional Cylinder & Keying Options	233
FE6700 Series Optional Cylinder & Keying Options, Shutter Thickness, Shutter Height, Miscellaneous Options	234

**MP9800 Series Multi-Point Vertical Rod Lock:**

MP9800 Series Standard Features	235
MP9800 Series Levers: Armstrong, Citation, Dirke, Essex, Lustra, Newport, Regis, Princeton, Georgia, Pablo, Jackson, Salvador, Marc	236
MP9800 Series Levers: Armstrong, Citation, Dirke, Essex, Lustra, Newport, Regis, Princeton, Georgia, Pablo, Jackson, Salvador, Marc, Freewheeling Trim, Electromechanical	237
MP9800A Series Levers: Armstrong, Citation, Dirke, Essex, Lustra, Newport, Regis, Princeton, Georgia, Pablo, Jackson, Salvador, Marc	238
MP9800A Series Levers: Armstrong, Citation, Dirke, Essex, Lustra, Newport, Regis, Princeton, Georgia, Pablo, Jackson, Salvador, Marc, Freewheeling Trim, Electromechanical	239
MP9800 Series Piet Levers, Freewheeling Trim, Electromechanical	240
MP9800A Series Piet Levers, Freewheeling Trim, Electromechanical	241
MP9800 Series Josef, Georges Levers, Freewheeling Trim, Electromechanical	242
MP9800A Series Josef, Georges Levers, Freewheeling Trim, Electromechanical	243
MP9800 Series Cylinder Options, Keying Options	244
MP9800 Series Door Height Options, Door Width Options, Door Thickness, Motorized Electric Latch Retraction	245
MP9800 Series Miscellaneous Options	246



# FE5400S

## Multi-Point Exit Device Latching System

January 1, 2019

### Standard Features

#### Handing

Device is non-handed  
Lever trim is handed

#### Bar Length

Standard: 36" (914mm) bar fits 30" - 36"  
(762mm-914mm) door

#### Door Height

7'0" (2134mm) standard

#### Door Thickness

1-3/4" (44mm) standard

#### Stile

Minimum width 4-1/2" (114mm).

#### Projection

3-1/4" (83mm) active, 2-3/4" (70mm) dogged.

#### Cylinders

Cylinder not included unless specified.

#### Warranty

Seven-year limited

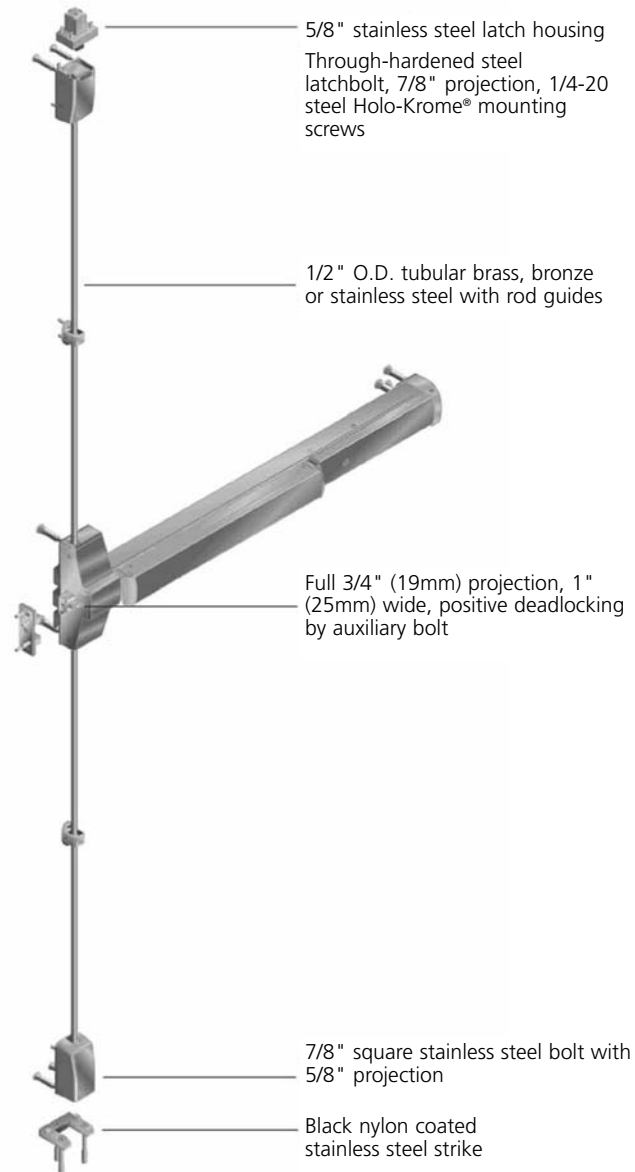

# FE5400S

## Multi-Point Exit Device Latching System



### Ordering Examples

January 1, 2019

#### Exit Device Only

Quantity	Series/ Function	Finish	Hand	Misc. Options
65	FE5400S	626	RHR	M51

#### Trim Only

Quantity	Trim/ Function	Finish	Hand	Door Thickness
24	N955ET	625	RHR	D214

#### Exit Device with Trim

Quantity	Exit Device	Trim/ Function	Finish	Hand	Door Thickness	Door Width	Misc. Options
65	FE5400S	N955ET	605	LHR	D214	W048	M51

#### Contract/Detailed Order — Exit Device with Trim

Quantity	Keyset	Exit Device	Trim/ Function	Finish	Hand	Door Height	Door Width	Misc. Options	Cylinder Option
36	AA1	FE5400S	C955ET	626	LHR	HO800	W048	M52	7P

### Pricing

#### 36" Device Only

Includes device, strike(s) and screw pack. No cylinder or trim.

FE5400S Series			
Function	Description	Finish: 613E, 630 <sup>1</sup> , BSP	Finish: 605, 606, 611, 612, 613, 618, 619, 625, 626, 629, 722
FE5400S	Panic	\$3,489.00	\$3,569.00
FE5400SA	3 Hour Fire Rated	\$3,659.00	\$3,739.00

Caution: Be sure of your measurements. Exit devices are NOT returnable.

# FE5400S

## Multi-Point Exit Device Latching System

January 1, 2019

### FE5400S Series Heavy-Duty Trim

Cylinder is not included.

#### Escutcheon Trim Design: A9 Armstrong

**Lever:** Cast      **Escutcheon:** Forged



Function	Description	Finish: 613E, 630 <sup>1</sup> , BSP	Finish: 605, 606, 611, 612, 613, 618, 619, 625, 626, 629 <sup>2</sup> , 722
A910ET	Passage	\$658.00	\$684.00
A950ET	Dummy		
A955ET	Classroom <sup>3</sup>		
A959ET	Storeroom		

#### Escutcheon Trim Design: C9 Citation

**Lever:** Cast      **Escutcheon:** Forged



Function	Description	Finish: 613E, 630 <sup>1</sup> , BSP	Finish: 605, 606, 611, 612, 613, 618, 619, 625, 626, 629 <sup>2</sup> , 722
C910ET	Passage	\$658.00	\$684.00
C950ET	Dummy		
C955ET	Classroom <sup>3</sup>		
C959ET	Storeroom		

#### Escutcheon Trim Design: D9 Dirke

**Lever:** Cast      **Escutcheon:** Forged



Function	Description	Finish: 613E, 630 <sup>1</sup> , BSP	Finish: 605, 606, 611, 612, 613, 618, 619, 625, 626, 629 <sup>2</sup> , 722
D910ET	Passage	\$658.00	\$684.00
D950ET	Dummy		
D955ET	Classroom <sup>3</sup>		
D959ET	Storeroom		

#### Escutcheon Trim Design: E9 Essex

**Lever:** Cast      **Escutcheon:** Forged



Function	Description	Finish: 613E, 630 <sup>1</sup> , BSP	Finish: 605, 606, 611, 612, 613, 618, 619, 625, 626, 629 <sup>2</sup> , 722
E910ET	Passage	\$658.00	\$684.00
E950ET	Dummy		
E955ET	Classroom <sup>3</sup>		
E959ET	Storeroom		

**Notes:**

1. 619 finish provided to match 630 finish
2. 618 finish provided to match 629 finish.
3. Classroom function trim may be converted to storeroom function by a simple field adjustment. No additional parts required.

# FE5400S

## Multi-Point Exit Device Latching System

### FE5400S Series Heavy-Duty Trim

January 1, 2019

Cylinder is not included.

#### Escutcheon Trim Design: L9 Lustra



**Lever:** Cast

**Escutcheon:** Forged



Function	Description	Finish: 613E, 630 <sup>1</sup> , BSP	Finish: 605, 606, 611, 612, 613, 618, 619, 625, 626, 629 <sup>2</sup> , 722
L910ET	Passage	\$658.00	\$684.00
L950ET	Dummy		
L955ET	Classroom <sup>3</sup>		
L959ET	Storeroom		

#### Escutcheon Trim Design: N9 Newport



**Lever:** Cast

**Escutcheon:** Forged



Function	Description	Finish: 613E, 630 <sup>1</sup> , BSP	Finish: 605, 606, 611, 612, 613, 618, 619, 625, 626, 629 <sup>2</sup> , 722
N910ET	Passage	\$658.00	\$684.00
N950ET	Dummy		
N955ET	Classroom <sup>3</sup>		
N959ET	Storeroom		

#### Escutcheon Trim Design: R9 Regis



**Lever:** Cast

**Escutcheon:** Forged



Function	Description	Finish: 613E, 630 <sup>1</sup> , BSP	Finish: 605, 606, 611, 612, 613, 618, 619, 625, 626, 629 <sup>2</sup> , 722
R910ET	Passage	\$658.00	\$684.00
R950ET	Dummy		
R955ET	Classroom <sup>3</sup>		
R959ET	Storeroom		

#### Escutcheon Trim Design: PR9 Princeton



**Lever:** Cast

**Escutcheon:** Forged



Function	Description	Finish: 613E, 630 <sup>1</sup> , BSP	Finish: 605, 606, 611, 612, 613, 618, 619, 625, 626, 629 <sup>2</sup> , 722
PR910ET	Passage	\$658.00	\$684.00
PR950ET	Dummy		
PR955ET	Classroom <sup>3</sup>		
PR959ET	Storeroom		

**Notes:**

1. 619 finish provided to match 630 finish. - Escutcheons only
2. 618 finish provided to match 629 finish. - Escutcheons only
3. Classroom function trim may be converted to storeroom function by a simple field adjustment. No additional parts required.

**FE5400S**  
Multi-Point Exit Device Latching System

January 1, 2019

**FE5400S Series Heavy-Duty Trim**

Cylinder is not included.

**Escutcheon Trim Design: G9**

**Lever:** Cast      **Escutcheon:** Forged



Function	Description	Finish: 613E, 630 <sup>1</sup> , BSP	Finish: 605, 606, 612, 613, 618, 619, 625, 626, 629 <sup>2</sup> , 722
G910ET	Passage	\$658.00	\$684.00
G950ET	Dummy		
G955ET	Classroom <sup>3</sup>		
G959ET	Storeroom		

Notes:

1. 619 finish provided to match 630 finish. - Escutcheons only
2. 618 finish provided to match 629 finish. - Escutcheons only
3. Classroom function trim may be converted to storeroom function by a simple field adjustment. No additional parts required.

**Escutcheon Trim Design: TH900 Pull/Thumbpiece**

**Grip:** Extruded      **Escutcheon:** Forged



Function	Description	Finish: 613E, 630 <sup>1</sup> , BSP	Finish: 605, 606, 611, 612, 613, 618, 619, 625, 626, 629 <sup>2</sup> , 722
TH910ET	Passage	\$475.00	\$501.00
TH950ET	Dummy (No thumbpiece)	\$445.00	\$471.00
TH955ET	Classroom <sup>3</sup>	\$475.00	\$501.00
TH959ET	Storeroom	\$445.00	\$471.00

**Escutcheon Trim Design: P9 Pull**



**Pull:** Extruded      **Escutcheon:** Forged



Function	Description	Finish: 613E, 630 <sup>1</sup> , BSP	Finish: 605, 606, 611, 612, 613, 618, 619, 625, 626, 629 <sup>2</sup> , 722
P950ET*	Dummy	\$408.00	\$434.00

\* Specify Hand. Field Reversible.

# FE5400S

## Multi-Point Exit Device Latching System

### FE5400S Series Heavy-Duty Trim

January 1, 2019

Cylinder is not included.

#### Escutcheon Trim Design: FR9 Frascati\*



**Lever:** Cast

**Escutcheon:** Forged



\* Handed Lever. Handing cannot be changed in the field.



Function	Description	Finish: 613E, 626, BSP	Finish: 605, 606, 611, 612, 613, 618, 619, 625, 629, 722
FR910ET	Passage	\$658.00	\$684.00
FR950ET	Dummy		
FR955ET	Classroom <sup>3</sup>		
FR959ET	Storeroom		

#### Escutcheon Trim Design: M9 Merlot



**Lever:** Cast

**Escutcheon:** Forged



Function	Description	Finish: 613E, 626, BSP	Finish: 605, 606, 611, 612, 613, 618, 619, 625, 629, 722
M910ET	Passage	\$658.00	\$684.00
M950ET	Dummy		
M955ET	Classroom <sup>3</sup>		
M959ET	Storeroom		

#### Escutcheon Trim Design: Z9 Zinfandel\*



**Lever:** Cast

**Escutcheon:** Forged



\* Handed Lever. Handing cannot be changed in the field.



Function	Description	Finish: 613E, 626, BSP	Finish: 605, 606, 611, 612, 613, 618, 619, 625, 629, 722
Z910ET	Passage	\$658.00	\$684.00
Z950ET	Dummy		
Z955ET	Classroom <sup>3</sup>		
Z959ET	Storeroom		

Notes:

3. Classroom function trim may be converted to storeroom function by a simple field adjustment. No additional parts required.

**FE5400S**  
Multi-Point Exit Device Latching System

January 1, 2019

**FE5400S Series Heavy-Duty Trim**

Cylinder is not included.

**Escutcheon Trim Design: Muséo®**



GEORGIA

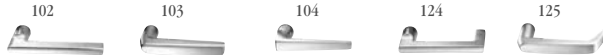

PABLO



JACKSON



SALVADOR



MARC



Parabolic Trim  
Specify: M60



Standard Trim

Function	Description	Finish: 613E, 630 <sup>1</sup> , BSP	Finish: 605, 606, 611, 612, 613, 613L, 618, 619, 625, 626, 629*, 722
910ET	Passage	\$658.00	\$684.00
950ET	Dummy		
955ET	Classroom		
959ET	Storeroom		

\*629 and \*630 finish options are Not available for all Muséo levers. Please refer to page 20 for availability.

**Escutcheon Trim Design: Muséo®**



PIET



Function	Description	Finish: 629, 630
910ET	Passage	\$684.00
950ET	Dummy	
955ET	Classroom	
959ET	Storeroom	

**FE5400S**  
Multi-Point Exit Device Latching System

January 1, 2019

**FE5400S Series Electrically Controlled Trim**

Cylinder is not included.

**Escutcheon Trim Design: A9 Armstrong** 

**Lever:** Cast    **Escutcheon:** Forged



Function	Description	Finish: 613E, 630', BSP	Finish: 605, 606, 611, 612, 613, 618, 619, 625, 626, 629 <sup>2</sup> , 722
A9903ET*	Fail Safe	\$1,046.00	\$1,072.00
A9905ET*	Fail Secure		

**Escutcheon Trim Design: C9 Citation** 

**Lever:** Cast    **Escutcheon:** Forged



Function	Description	Finish: 613E, 630', BSP	Finish: 605, 606, 611, 612, 613, 618, 619, 625, 626, 629 <sup>2</sup> , 722
C9903ET*	Fail Safe	\$1,046.00	\$1,072.00
C9905ET*	Fail Secure		

**Escutcheon Trim Design: D9 Dirke\*** 

**Lever:** Cast    **Escutcheon:** Forged

\* Handed Lever. Handing cannot be changed in the field.

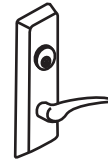

Function	Description	Finish: 613E, 630', BSP	Finish: 605, 606, 611, 612, 613, 618, 619, 625, 626, 629 <sup>2</sup> , 722
D9903ET*	Fail Safe	\$1,046.00	\$1,072.00
D9905ET*	Fail Secure		

**Escutcheon Trim Design: E9 Essex** 

**Lever:** Cast    **Escutcheon:** Forged



Function	Description	Finish: 613E, 630', BSP	Finish: 605, 606, 611, 612, 613, 618, 619, 625, 626, 629 <sup>2</sup> , 722
E9903ET*	Fail Safe	\$1,046.00	\$1,072.00
E9905ET*	Fail Secure		

- Notes:
1. 619 finish provided to match 630 finish. - Escutcheons only
  2. 618 finish provided to match 629 finish. - Escutcheons only



\*ElectroLynx®  
As part of their promise to provide innovative, fast and effective high security solutions to their customers, certain ASSA ABLOY Group brands offer **ElectroLynx®**, a universal quick-connect system that simplifies the electrification of the door opening.



**FE5400S Series Electrically Controlled Trim**

January 1, 2019

Cylinder is not included.

**Escutcheon Trim Design: L9 Lustra** 

**Lever:** Cast    **Escutcheon:** Forged



Function	Description	Finish: 613E, 630', BSP	Finish: 605, 606, 611, 612, 613, 618, 619, 625, 626, 629 <sup>2</sup> , 722
L9903ET*	Fail Safe	\$1,046.00	\$1,072.00
L9905ET*	Fail Secure		

**Escutcheon Trim Design: N9 Newport** 

**Lever:** Cast    **Escutcheon:** Forged

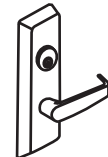

Function	Description	Finish: 613E, 630', BSP	Finish: 605, 606, 611, 612, 613, 618, 619, 625, 626, 629 <sup>2</sup> , 722
N9903ET*	Fail Safe	\$1,046.00	\$1,072.00
N9905ET*	Fail Secure		

**Escutcheon Trim Design: R9 Regis** 

**Lever:** Cast    **Escutcheon:** Forged

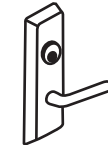

Function	Description	Finish: 613E, 630', BSP	Finish: 605, 606, 611, 612, 613, 618, 619, 625, 626, 629 <sup>2</sup> , 722
R9903ET*	Fail Safe	\$1,046.00	\$1,072.00
R9905ET*	Fail Secure		

**Escutcheon Trim Design: PR9 Princeton** 

**Lever:** Cast    **Escutcheon:** Forged



Function	Description	Finish: 613E, 630', BSP	Finish: 605, 606, 611, 612, 613, 618, 619, 625, 626, 629 <sup>2</sup> , 722
PR9903ET*	Fail Safe	\$1,046.00	\$1,072.00
PR9905ET*	Fail Secure		

Notes:

1. 619 finish provided to match 630 finish. - Escutcheons only
2. 618 finish provided to match 629 finish. - Escutcheons only



**\*ElectroLynx®**

As part of their promise to provide innovative, fast and effective high security solutions to their customers, certain ASSA ABLOY Group brands offer *ElectroLynx*®, a universal quick-connect system that simplifies the electrification of the door opening.

**FE5400S**  
Multi-Point Exit Device Latching System

**FE5400S Series Electrically Controlled Trim**

January 1, 2019

Cylinder is not included.

**Escutcheon Trim Design: FR9 Frascati** 

**Lever:** Cast **Escutcheon:** Forged



Function	Description	Finish: 613E, 626, BSP	Finish: 605, 606, 611, 612, 613, 618, 619, 625, 629, 722
FR9903ET*	Fail Safe	\$1,046.00	\$1,072.00
FR9905ET*	Fail Secure		

**Escutcheon Trim Design: M9 Merlot** 

**Lever:** Cast **Escutcheon:** Forged



Function	Description	Finish: 613E, 626, BSP	Finish: 605, 606, 611, 612, 613, 618, 619, 625, 629, 722
M9903ET*	Fail Safe	\$1,046.00	\$1,072.00
M9905ET*	Fail Secure		

**Escutcheon Trim Design: Z9 Zinfandel** 

**Lever:** Cast **Escutcheon:** Forged



Function	Description	Finish: 613E, 626, BSP	Finish: 605, 606, 611, 612, 613, 618, 619, 625, 629, 722
Z9903ET*	Fail Safe	\$1,046.00	\$1,072.00
Z9905ET*	Fail Secure		



**\*ElectroLynx®**

As part of their promise to provide innovative, fast and effective high security solutions to their customers, certain ASSA ABLOY Group brands offer **ElectroLynx®**, a universal quick-connect system that simplifies the electrification of the door opening.

**FE5400S**  
Multi-Point Exit Device Latching System

January 1, 2019

**FE5400S Series Electrically Controlled Trim**

Cylinder is not included.

**Escutcheon Trim Design: Muséo®**



GEORGIA

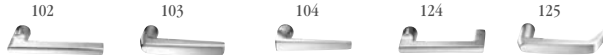

PABLO



JACKSON



SALVADOR



MARC



Parabolic Trim  
Specify: M60



Standard Trim

Function	Description	Finish: 613E, 630 <sup>1</sup> , BSP	Finish: 605, 606, 611, 612, 613, 613L, 618, 619, 625, 626, 629*, 722
9903ET**	Fail Safe	\$1,046.00	\$1,072.00
9905ET**	Fail Secure		

\*629 and \*630 finish options are Not available for all Muséo levers. Please refer to page 20 for availability.

**Escutcheon Trim Design: Muséo®**



PIET



Function	Description	Finish: 629, 630
9903ET**	Fail Safe	\$1,072.00
9905ET**	Fail Secure	



**\*\*ElectroLynx®**

As part of their promise to provide innovative, fast and effective high security solutions to their customers, certain ASSA ABLOY Group brands offer **ElectroLynx®**, a universal quick-connect system that simplifies the electrification of the door opening.

# FE5400S Electrically Controlled Trim



## Electrified Options

January 1, 2019

Description	Specify Quick Code	Add or Deduct
Touchbar Monitoring or Signaling/Request to Exit (REX)	M92*	Add \$204.00
Outside Trim Monitoring or Signaling	M93*	Add \$204.00
SPDT Lock and Unlock security monitor switch (Electric Trim Only)	M98*	Add \$196.00
Trim gasket for exterior applications (Electric Trim Only)	M99	Add \$22.00

## Electrified Accessories

Part Number	Description	Specify	Price
709F649	Power Supply 1 Amp @ 12VDC Output	BPS-12-1	\$327.00
709F659	Power Supply 3 Amp @ 12VDC Output	BPS-12-3	\$664.00
709F609	Power Supply 2 Amp @ 24VDC Output	BPS-24-1	\$327.00
709F619	Power Supply 2 Amp @ 24VDC Output	BPS-24-2	\$664.00
709F629	Power Supply 4 Amp @ 24VDC Output	BPS-24-4	\$1,122.00
704F288	Concealed transfer (for over 120-degree swing door)	EPTL	\$129.00
709F689	(1) SPDT Maintained Switch (Includes LED)	MKA	\$124.00
709F709	(1) SPDT Momentary Switch (Includes LED)	MK	\$197.00
709F759	(1) SPDT Maintained (Alternating Action) Switch	PB3EA	\$115.00
709F729	DPDT Momentary Key Switch	2' MK2	\$226.00
704F719	Narrow Stile Momentary Key Switch	MKN	\$197.00
709F789	Sonalert 90db @ 2 ft. 12-24VDC Mounted on one gang stainless steel plate.	PZ1	\$97.00



### \*ElectroLynx®

As part of their promise to provide innovative, fast and effective high security solutions to their customers, certain ASSA ABLOY Group brands offer *ElectroLynx*®, a universal quick-connect system that simplifies the electrification of the door opening.

# FE5400S Electrically Controlled Trim

## Multi-Point Exit Device Latching System

January 1, 2019

### Cylinder Options\*

Description	Specify Quick Code	Add or Deduct
Conventional 6-pin	6P**	Add \$86.00 per cylinder
Conventional 7-pin	7P	Add \$88.00 per cylinder
Access 3 Patented	AP	No Charge
Access 3 Security	AS	Add \$56.00 per cylinder
Access 3 High Security, UL 437	AHS	Add \$79.00 per cylinder
Access 3 IC Patented	ACP	Add \$74.00 per cylinder
Access 3 IC Security	ACS	Add \$123.00 per cylinder
Access 3 IC High Security, UL 437	ACHS	Add \$143.00 per cylinder
Pyramid Security fixed core	PS	Add \$144.00 per cylinder
Pyramid Security IC	PCS	Add \$215.00 per cylinder
Pyramid High Security fixed core	PHS	Add \$174.00 per cylinder
Pyramid High Security IC	PCHS	Add \$244.00 per cylinder
Pyramid IC with temporary construction core	CTP	Add \$160.00 per cylinder
Pyramid IC with temporary disposable core	CTPD	Add \$86.00 per cylinder
Pyramid IC less core	CLP	Add \$86.00 per cylinder
Security	HS	Add \$197.00 per cylinder
Security IC	CHS	Add \$269.00 per cylinder
Blockout function	BO	Add \$179.00 per cylinder
IC 6-pin	C6	Add \$160.00 per cylinder
IC 6-pin with temporary construction core (Red)	CT6R	Add \$160.00 per cylinder
IC 6-pin with temporary construction core (Blue)	CT6B	Add \$160.00 per cylinder
IC 6-pin with temporary construction core (Green)	CT6G	Add \$160.00 per cylinder
IC 6-pin with temporary disposable core	CT6D	Add \$86.00 per cylinder
IC 6-pin less core	CL6	Add \$86.00 per cylinder
SFIC 6-pin with Less Core	CLS6	Add \$86.00 per cylinder
IC 6-pin with SFIC disposable temporary core	CT6SD	Add \$86.00 per cylinder
IC 7-pin	C7	Add \$164.00 per cylinder
IC 7-pin with temporary construction core (Red)	CT7R	Add \$164.00 per cylinder
IC 7-pin with temporary construction core (Blue)	CT7B	Add \$164.00 per cylinder
IC 7-pin with temporary construction core (Green)	CT7G	Add \$164.00 per cylinder
IC 7-pin with temporary disposable core	CT7D	Add \$88.00 per cylinder
IC 7-pin less core	CL7	Add \$88.00 per cylinder
SFIC 7-pin with Less Core	CLS7	Add \$88.00 per cylinder
IC 7-pin with SFIC disposable temporary core	CT7SD	Add \$88.00 per cylinder

\*Optional dogging cylinder will be furnished with the same mechanism and keyed alike with the trim cylinder, unless otherwise specified. If different keying or cylinder type is required, specify outside (trim) first, then inside (dogging) cylinder.

\*\*6P cylinder option is supplied in 6-pin, L4 keyway, 0-bitted with two nickel silver keys.

### Keying Accessories\*

Description	Specify Quick Code	Add or Deduct
0-Bitted with 2 blank keys	(standard)	No Charge
Keyed random	KR	No Charge
Master keyed (all cylinders except 8000, 8020, 8027 IC)	specify keyset	Add \$16.00 per cylinder
Master keyed Pyramid	specify keyset	Add \$16.00 per cylinder
Master keyed Security (including IC cylinder and core)	specify keyset	Add \$16.00 per cylinder
Master keyed (8000, 8020, 8027 IC core)	specify keyset	No Charge
Master keyed to customer bittings or sample key	specify keyset	Add \$16.00 per cylinder
Construction master keyed <sup>1,2</sup>	CMK	Add \$16.00 per cylinder
Visual key control (VKC)		
- No Stamping	VKC0	\$4.50
- Keys only	VKC1	No Charge
- Cylinders and Keys <sup>3</sup>	VKC2	\$8.00
- Cylinders only <sup>3</sup>	VKC3	\$8.00
Concealed key control (CKC)		
- CKC cylinders with VKC keys	CKC2	\$8.00
- CKC cylinders only <sup>3</sup>	CKC3	\$8.00
More than 2 keys per lock	KY# (e.g., KY6)	See page 66 - Cut Keys Section

\*For key bows other than 10 and 90, specify "KB" + bow number as Quick Code, e.g. KB12.

Notes:

1. CMK Construction master keying charge is in addition to master keying charge.

2. CMK Construction master keying is not available in Pyramid or Security series.

3. VKC2, VKC3, CKC3 are not available in Pyramid or Security series.

# FE5400S Electrically Controlled Trim Multi-Point Exit Device Latching System



## Door Height Options

January 1, 2019

Door Height	Specify Quick Code	Add or Deduct
7'0"	(standard)	No Charge
7'2"	H0702	No Charge
7'6"	H0706	No Charge
8'0"	H0800	No Charge

## Door Width Options

Door Width	Specify Quick Code	Add or Deduct
32"	W032	No Charge
36"	(standard)	No Charge
42"	W042	No Charge
48"	W048	Add \$35.00 per device

## Door Thickness Options

Door Thickness	Specify Quick Code	Add or Deduct
1-3/4"	(standard)	No Charge
2"	D200	No Charge
2-1/4"	D214	No Charge

## Miscellaneous Options

Description	Specify	Add or Deduct
Knurling outside and inside (Embossed Touchbar - device side)	M20	Add \$145.00 per device
Knurling outside only (trim side)	M21	Add \$68.00 per device
Knurling inside only (Embossed Touchbar - device side)	M22	Add \$77.00 per device
Abrasive coat outside and inside (trim and device)	M23	Add \$92.00 per device
Abrasive coat inside only (device side)	M24	Add \$48.00 per device
Abrasive coat outside only (trim side)	M25	Add \$44.00 per device
PathLite™ Photoluminescent Touchbar cover	M49	Add \$348.00 per device
Less dogging	M51	No Charge
Cylinder dogging (less cylinder)	M52	Add \$78.00 per device
Mullion stabilizer	M57	Add \$62.00 per mullion
Parabolic Design Exit Trim	M60	Add \$78.00 per device
MicroShield® Antimicrobial finish coating	626C	Add \$64.00 (Exit Devices & Trims (ordered separately))
		Add \$79.00 (Exit Devices & Outside Trims (ordered together))
MicroShield® Antimicrobial finish coating	630C	Add \$64.00 (Exit Devices & Trims (ordered separately))
		Add \$79.00 (Exit Devices & Outside Trims (ordered together))

# FE5400S

## Multi-Point Exit Device Latching System



### Removable Mullions

January 1, 2019

Door Height	Description	Specify	Price
Up to 7'0"	Steel Mullion - 3 Hour Fire Rated, Windstorm Certified	CRFE707A <sup>4</sup>	\$1,145.00
Up to 8'0"	Steel Mullion - 3 Hour Fire Rated, Windstorm Certified	CRFE708A <sup>4</sup>	\$1,155.00

Note:

- For use with UL listed door assemblies that comply to FEMA 361 and ICC 500.  
For the latest listings on compliant door assemblies visit our website at [corbinrusswin.com](http://corbinrusswin.com)

### Options

Description	Specify Quick Code	Add or Deduct
Door frame filler block for double rabbetted frames	M95	Add \$42.00 per mullion
Door frame angle bracket for aluminum frames	M96	Add \$42.00 per mullion

FE5400S

Notes



*January 1, 2019*



## FE6600 Series

### FE66600 Series Multi-Point Locks

January 1, 2019

<b>Door</b>	1-3/4" thick door only; fully integrated – FE66600 is part of a complete ASSA ABLOY windstorm solution utilizing CECO StormPro® 361 and CURRIES StormPro® 361 doors and frames and McKINNEY® StormPro® hinges
<b>Mounting</b>	Supplied fasteners are for metal doors with throughbolts for trim
<b>Hand</b>	Handed; specify RHR, LHR, RH or LH
<b>Lockbody</b>	Unique mortise lockbody assembly used specifically for FEMA applications
<b>Top Bolt</b>	Adjustable stainless steel 3/4" square bolt with 11/16" engagement; 5/16" steel reinforcement plate
<b>Bottom Bolt</b>	Adjustable stainless steel 3/4" square bolt with 5/8" engagement; 1/4" steel reinforcement plate
<b>Center Bolts</b>	Latchbolt is stainless steel with 3/4" projection. One piece, anti-friction reversible catch. Deadbolt is one piece hardened stainless steel with 1" projection
<b>Lock Front</b>	1/8" steel mortise front reinforced with 13/64" thick lock edge stiffener Center Bolt Strike 1/4" thick stainless steel
<b>Backset</b>	2-3/4" standard
<b>Door Thickness</b>	1-3/4" standard
<b>Door Height</b>	7'0" - 8'0"
<b>Maximum Opening</b>	Single door 4'0" x 8'0" and double doors 8'0" x 8'0"
<b>UL Fire Listed</b>	UL 3-hour fire rating
<b>Trim</b>	Multiple sectional and escutcheon mortise trim with Standard or Muséo levers
<b>Functions</b>	<ul style="list-style-type: none"> <li>- Classroom</li> <li>- Storeroom</li> <li>- Dormitory/Exit</li> <li>- Privacy</li> </ul>
<b>Cylinder</b>	Multiple mortise cylinders

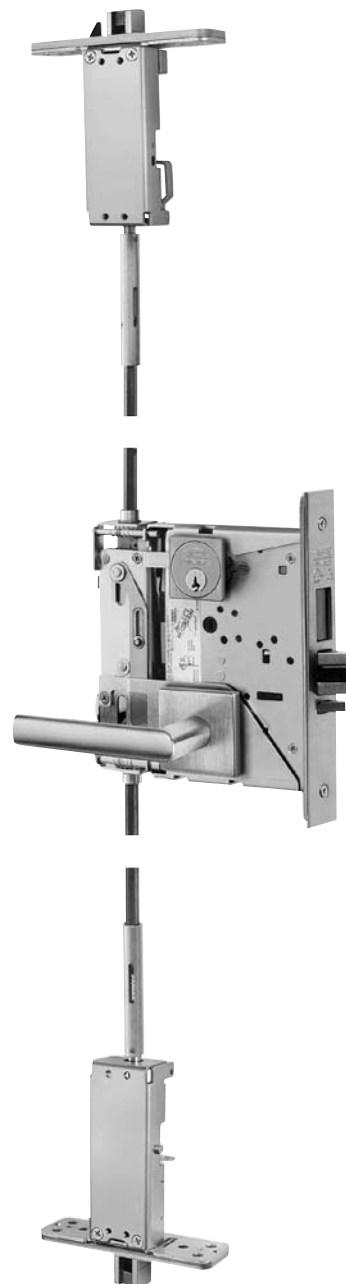

## How to Order

### Ordering Example

Quantity	Series/ Function	Trim	Finish	Hand
100	FE6618	ASM	626	RHR

This product is part of a complete tornado assembly and must be used with a Ceco or Curries StormPro door. Concealed vertical rods, top and bottom bolts, and mortise lock body cassette will be factory installed. All other hardware components are shipped directly to the customer and must be installed by a factory trained installer.

# FE6600 Series Multi-Point Locks

January 1, 2019

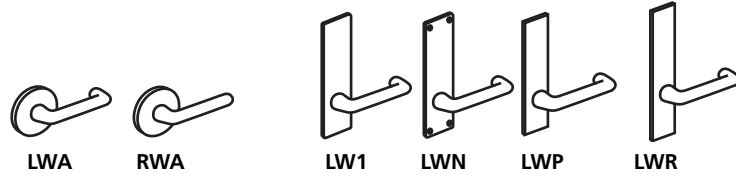

Lever: Wrought  
Rose: Wrought

Lever: Wrought  
Escutcheon: Wrought

Lever: Wrought  
Escutcheon: Solid Stainless Steel  
or Forged Brass

Description/Function	Levers: LW, RW Roses: A, G		Levers: LW, RW Escutcheons: M, N, LW1		Levers: LW, RW Escutcheons: RE1/RE2, RE3/RE4	
	613E, 626, BSP	605, 606, 611, 612, 613, 618, 619, 625, 629, 630, 722	613E, 626, BSP	605, 606, 611, 612, 613, 618, 619, 625, 629, 630, 722	613E, 626, BSP	605, 606, 611, 612, 613, 618, 619, 625, 629, 630, 722
FE6618 - Classroom FE6620 - Privacy FE6622 - Store Door FE6624 - Storeroom Door FE6630 - Privacy Bath/Bedroom FE6662 - Classroom Security Intruder Deadbolt FE6665 - Dormitory FE6672 - Classroom Security Intruder Deadbolt FE6673 - Classroom Security Intruder Deadbolt FE6675 - Security Deadbolt FE6680 - Passage Lever x Blank Plate	\$3,431.00	\$3,455.00	\$3,451.00	\$3,475.00	\$3,505.00	\$3,529.00
<b>Electrified Mortise Locks</b> FE66609 x NAC SAF/SEC	\$3,631.00	\$3,655.00	\$3,651.00	\$3,675.00	\$3,705.00	\$3,729.00

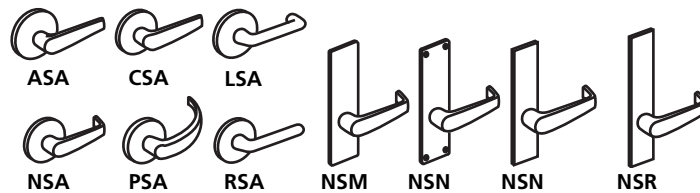

Lever: Cast  
Rose: Wrought

Lever: Cast  
Escutcheon: Wrought

Lever: Cast  
Escutcheon: Solid Stainless Steel  
or Forged Brass

Description/Function	Levers: AS, CS, ES, LS, NS, PS, RS Roses: A, G		Levers: AS, CS, ES, LS, NS, PS, RS Escutcheons: M, N, LW1		Levers: AS, CS, ES, LS, NS, PS, RS Escutcheons: RE1/RE2, RE3/RE4	
	613E, 626, BSP	605, 606, 611, 612, 613, 618, 619, 625, 629, 630, 722	613E, 626, BSP	605, 606, 611, 612, 613, 618, 619, 625, 629, 630, 722	613E, 626, BSP	605, 606, 611, 612, 613, 618, 619, 625, 629, 630, 722
FE6618 - Classroom FE6620 - Privacy FE6622 - Store Door FE6624 - Storeroom Door FE6630 - Privacy Bath/Bedroom FE6662 - Classroom Security Intruder Deadbolt FE6665 - Dormitory FE6672 - Classroom Security Intruder Deadbolt FE6673 - Classroom Security Intruder Deadbolt FE6675 - Security Deadbolt FE6680 - Passage Lever x Blank Plate	\$3,431.00	\$3,455.00	\$3,451.00	\$3,475.00	\$3,505.00	\$3,529.00
<b>Electrified Mortise Locks</b> FE66609 x NAC SAF/SEC	\$3,631.00	\$3,655.00	\$3,651.00	\$3,675.00	\$3,705.00	\$3,729.00

# FE6600 Series Multi-Point Locks

January 1, 2019

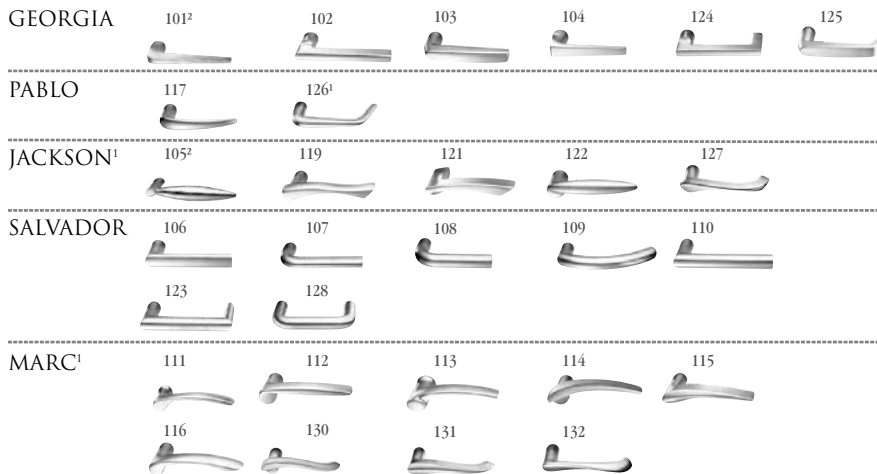

## ROSES

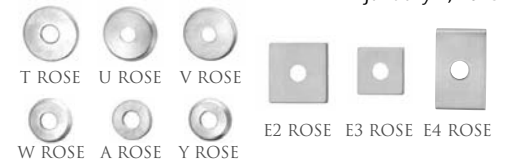

## ESCUTCHEONS



## THUMBTURNS³



1. Handed: specify hand when ordering
2. Contact factory for current lead time
3. Specify thumbturn as quick code. Thumbturn backplate will match shape of rose chosen (i.e. round or square). Not available with escutcheons.

\*629 and \*630 finish options are Not available for all Muséo levers. Please refer to page 20 for availability.

613E Dark Oxidized Satin Bronze - Equivalent  
626 Satin Chromium Plated  
BSP Black Suede Powder Coat

605 Bright Brass, Clear Coated  
606 Satin Brass, Clear Coated  
611 Bright Bronze, Clear Coated  
612 Satin Bronze, Clear Coated  
613 Dark Oxidized Satin Bronze, Oil Rubbed  
613L Dark Oxidized Satin Bronze, Clear Coated

618 Bright Nickel Plated  
619 Satin Nickel Plated  
625 Bright Chromium Plated  
629\* Bright Stainless Steel  
630\* Satin Stainless Steel  
722 Black Oxidized Bronze, Oil Rubbed

### Function

Lever with Escutcheons: L, CE, RE1		
FE6618 - Classroom FE6620 - Privacy FE6622 - Store Door FE6624 - Storeroom Door FE6630 - Privacy Bath/Bedroom FE6662 - Classroom Security Intruder Deadbolt FE6665 - Dormitory FE6672 - Classroom Security Intruder Deadbolt FE6673 - Classroom Security Intruder Deadbolt FE6675 - Security Deadbolt FE6680 - Passage Lever x Blank Plate	\$3,471.00	\$3,495.00
<b>Electrified Mortise Locks</b> FE66609 x NAC SAF/SEC	\$3,671.00	\$3,695.00

Lever with Roses: A, T, U, V, W, Y, E2, E3, E4		
FE6618 - Classroom FE6620 - Privacy FE6622 - Store Door FE6624 - Storeroom Door FE6630 - Privacy Bath/Bedroom FE6662 - Classroom Security Intruder Deadbolt FE6665 - Dormitory FE6672 - Classroom Security Intruder Deadbolt FE6673 - Classroom Security Intruder Deadbolt FE6675 - Security Deadbolt FE6680 - Passage Lever x Blank Plate	\$3,431.00	\$3,455.00
<b>Electrified Mortise Locks</b> FE66609 x NAC SAF/SEC	\$3,631.00	\$3,655.00

# FE6600 Series Multi-Point Locks

January 1, 2019



## ROSES

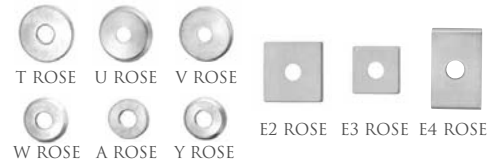

## ESCUTCHEONS



## THUMBTURNS<sup>3</sup>



1. Handed: specify hand when ordering
2. Contact factory for current lead time
3. Specify thumbturn as quick code. Thumbturn backplate will match shape of rose chosen (i.e. round or square). Not available with escutcheons.

613E	Dark Oxidized Satin Bronze - Equivalent	605	Bright Brass, Clear Coated	618	Bright Nickel Plated
626	Satin Chromium Plated	606	Satin Brass, Clear Coated	609	Satin Nickel Plated
BSP	Black Suede Powder Coat	611	Bright Bronze, Clear Coated	625	Bright Chromium Plated
		612	Satin Bronze, Clear Coated	629	Bright Stainless Steel
		613	Dark Oxidized Satin Bronze, Oil Rubbed	630	Satin Stainless Steel
		613L	Dark Oxidized Satin Bronze, Clear Coated	722	Black Oxidized Bronze, Oil Rubbed

## Function

Lever with Escutcheons: L, CE, RE1		
FE6618 - Classroom		
FE6620 - Privacy		
FE6622 - Store Door		
FE6624 - Storeroom Door		
FE6630 - Privacy Bath/Bedroom		
FE6662 - Classroom Security Intruder Deadbolt	\$3,540.00	\$3,564.00
FE6665 - Dormitory		
FE6672 - Classroom Security Intruder Deadbolt		
FE6673 - Classroom Security Intruder Deadbolt		
FE6675 - Security Deadbolt		
FE6680 - Passage Lever x Blank Plate		
<b>Electrified Mortise Locks</b>		
FE66609 x NAC SAF/SEC	\$3,740.00	\$3,764.00

Lever with Roses: A, T, U, V, W, E2, E3, E4		
FE6618 - Classroom		
FE6620 - Privacy		
FE6622 - Store Door		
FE6624 - Storeroom Door		
FE6630 - Privacy Bath/Bedroom		
FE6662 - Classroom Security Intruder Deadbolt	\$3,500.00	\$3,524.00
FE6665 - Dormitory		
FE6672 - Classroom Security Intruder Deadbolt		
FE6673 - Classroom Security Intruder Deadbolt		
FE6675 - Security Deadbolt		
FE6680 - Passage Lever x Blank Plate		
<b>Electrified Mortise Locks</b>		
FE66609 x NAC SAF/SEC	\$3,700.00	\$3,724.00

# FE6600 Series Multi-Point Locks

January 1, 2019

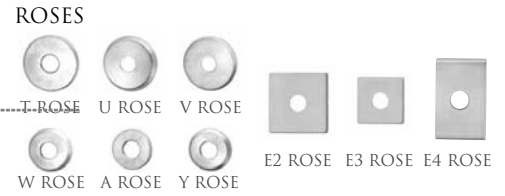
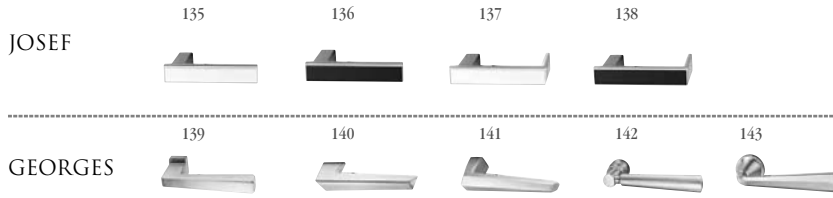

### ESCUTCHEONS



### THUMBTURNS<sup>3</sup>



1. Handed: specify hand when ordering
2. Contact factory for current lead time
3. Specify thumbturn as quick code. Thumbturn backplate will match shape of rose chosen (i.e. round or square). Not available with escutcheons.

613E Dark Oxidized Satin Bronze - Equivalent	605 Bright Brass, Clear Coated	618 Bright Nickel Plated
626 Satin Chromium Plated	606 Satin Brass, Clear Coated	619 Satin Nickel Plated
BSP Black Suede Powder Coat	611 Bright Bronze, Clear Coated	625 Bright Chromium Plated
	612 Satin Bronze, Clear Coated	629 Bright Stainless Steel
	613 Dark Oxidized Satin Bronze, Oil Rubbed	630 Satin Stainless Steel
	613L Dark Oxidized Satin Bronze, Clear Coated	722 Black Oxidized Bronze, Oil Rubbed

### Function

Lever with Escutcheons: L, CE, RE1		
FE6618 - Classroom		
FE6620 - Privacy		
FE6622 - Store Door		
FE6624 - Storeroom Door		
FE6630 - Privacy Bath/Bedroom		
FE6662 - Classroom Security Intruder Deadbolt	\$3,557.00	\$3,581.00
FE6665 - Dormitory		
FE6672 - Classroom Security Intruder Deadbolt		
FE6673 - Classroom Security Intruder Deadbolt		
FE6675 - Security Deadbolt		
FE6680 - Passage Lever x Blank Plate		
<b>Electrified Mortise Locks</b>		
FE66609 x NAC SAF/SEC	\$3,757.00	\$3,781.00
Lever with Roses: A, T, U, V, W, E2, E3, E4		
FE6618 - Classroom		
FE6620 - Privacy		
FE6622 - Store Door		
FE6624 - Storeroom Door		
FE6630 - Privacy Bath/Bedroom		
FE6662 - Classroom Security Intruder Deadbolt	\$3,517.00	\$3,541.00
FE6665 - Dormitory		
FE6672 - Classroom Security Intruder Deadbolt		
FE6673 - Classroom Security Intruder Deadbolt		
FE6675 - Security Deadbolt		
FE6680 - Passage Lever x Blank Plate		
<b>Electrified Mortise Locks</b>		
FE66609 x NAC SAF/SEC	\$3,717.00	\$3,741.00

# FE6600 Series Multi-Point Locks

January 1, 2019

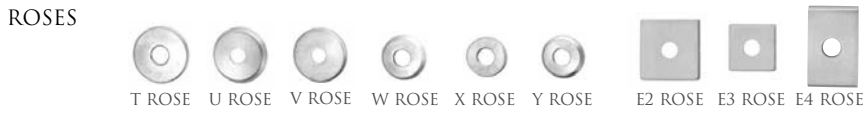

Specify thumbturn as quick code. Thumbturn backplate will match shape of rose chosen (i.e. round or square)

629	Bright Stainless Steel
630	Satin Stainless Steel

## Function

Lever with Escutcheons: L, CE, RE1	
FE6618 - Classroom FE6620 - Privacy FE6622 - Store Door FE6624 - Storeroom Door FE6630 - Privacy Bath/Bedroom FE6662 - Classroom Security Intruder Deadbolt FE6665 - Dormitory FE6672 - Classroom Security Intruder Deadbolt FE6673 - Classroom Security Intruder Deadbolt FE6675 - Security Deadbolt FE6680 - Passage Lever x Blank Plate	\$3,564.00
<b>Electrified Mortise Locks</b> FE66609 x NAC SAF/SEC	\$3,764.00

Lever with Roses: A, T, U, V, W, E2, E3, E4	
FE6618 - Classroom FE6620 - Privacy FE6622 - Store Door FE6624 - Storeroom Door FE6630 - Privacy Bath/Bedroom FE6662 - Classroom Security Intruder Deadbolt FE6665 - Dormitory FE6672 - Classroom Security Intruder Deadbolt FE6673 - Classroom Security Intruder Deadbolt FE6675 - Security Deadbolt FE6680 - Passage Lever x Blank Plate	\$3,524.00
<b>Electrified Mortise Locks</b> FE66609 x NAC SAF/SEC	\$3,724.00

# FE6600 Series Multi-Point Locks

January 1, 2019

## PIET

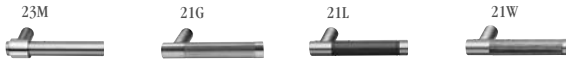

## ROSES



## ESCUTCHEONS

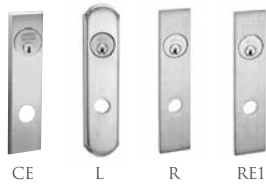

## THUMBTURNS



Specify thumbturn as quick code. Thumbturn backplate will match shape of rose chosen (i.e. round or square)

629 Bright Stainless Steel  
630 Satin Stainless Steel

## Function

Lever with Escutcheons: L, CE, RE1	
FE6618 - Classroom FE6620 - Privacy FE6622 - Store Door FE6624 - Storeroom Door FE6630 - Privacy Bath/Bedroom FE6662 - Classroom Security Intruder Deadbolt FE6665 - Dormitory FE6672 - Classroom Security Intruder Deadbolt FE6673 - Classroom Security Intruder Deadbolt FE6675 - Security Deadbolt FE6680 - Passage Lever x Blank Plate	\$3,581.00
Electrified Mortise Locks	
FE66609 x NAC SAF/SEC	\$3,781.00

Lever with Roses: A, T, U, V, W, E2, E3, E4	
FE6618 - Classroom FE6620 - Privacy FE6622 - Store Door FE6624 - Storeroom Door FE6630 - Privacy Bath/Bedroom FE6662 - Classroom Security Intruder Deadbolt FE6665 - Dormitory FE6672 - Classroom Security Intruder Deadbolt FE6673 - Classroom Security Intruder Deadbolt FE6675 - Security Deadbolt FE6680 - Passage Lever x Blank Plate	\$3,541.00
Electrified Mortise Locks	
FE66609 x NAC SAF/SEC	\$3,741.00

FE6600 Series  
Multi-Point Locks

January 1, 2019

**Vandal Resistant Trim: ASV, CSV, DSV, ESV, LSV, NSV, PSV, RSV** 

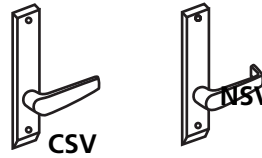

Lever: Cast  
Escutcheon: Cast

Description/Function	CSV, NSV
	Finish: 630
FE6622 - Store Door FE6624 - Storeroom Door FE6630 - Privacy Bath/Bedroom FE6662 - Classroom Security Intruder Deadbolt FE6665 - Dormitory FE6672 - Classroom Security Intruder Deadbolt	\$3,895.00
<b>Electrified Mortise Locks</b> FE66609 x NAC SAF/SEC	\$4,095.00



# FE6600 Series

## Multi-Point Locks



January 1, 2019

### Cylinder & Keying Options

Description	Specify Quick Code	Add or Deduct
Conventional 6-pin	(standard)	No Charge
Conventional 7-pin	7P	Add \$2.00 per cylinder
Less Standard Cylinder	LC	Deduct \$86.00 per cylinder
Less Concealed Shell Cylinder	PO-LC	Add \$5.00 per lockset
Access 3 Patented	AP	No Charge
Access 3 Security	AS	Add \$56.00 per cylinder
Access 3 High Security, UL 437	AHS	Add \$79.00 per cylinder
Access 3 IC Patented	ACP	Add \$74.00 per cylinder
Access 3 IC Security	ACS	Add \$123.00 per cylinder
Access 3 IC High Security, UL 437	ACHS	Add \$143.00 per cylinder
Pyramid Security Fixed Core	PS	Add \$58.00 per cylinder
Pyramid Security IC	PCS	Add \$129.00 per cylinder
Pyramid High Security Fixed Core	PHS	Add \$86.00 per cylinder
Pyramid High Security IC	PCHS	Add \$158.00 per cylinder
Pyramid IC with Temporary Construction Core <sup>3</sup>	CTP	Add \$74.00 per cylinder
Pyramid IC with Temporary Disposable Core <sup>3</sup>	CTPD	No Charge
Pyramid IC Less Core	CLP	No Charge
Security <sup>4</sup>	HS	Add \$111.00 per cylinder
Security IC <sup>1,4</sup>	CHS	Add \$183.00 per cylinder
Blockout Function Cylinder	BO	Add \$105.00 per cylinder
IC 6-pin	C6	Add \$74.00 per cylinder
IC 6-pin with Temporary Construction Core (Red)	CT6R	Add \$74.00 per cylinder
IC 6-pin with Temporary Construction Core (Blue)	CT6B	Add \$74.00 per cylinder
IC 6-pin with Temporary Construction Core (Green)	CT6G	Add \$74.00 per cylinder
IC 6-pin with Temporary Disposable Core	CT6D	No Charge
IC 6-pin Less Core	CL6	No Charge
SFIC 6-pin with Less Core	CLS6	No Charge
IC 6-pin with SFIC disposable temporary core	CT6SD	No Charge
IC 7-pin	C7	Add \$76.00 per cylinder
IC 7-pin with Temporary Construction Core (Red)	CT7R	Add \$76.00 per cylinder
IC 7-pin with Temporary Construction Core (Blue)	CT7B	Add \$76.00 per cylinder
IC 7-pin with Temporary Construction Core (Green)	CT7G	Add \$76.00 per cylinder
IC 7-pin with Temporary Disposable Core	CT7D	Add \$2.00 per cylinder
IC 7-pin Less Core	CL7	Add \$2.00 per cylinder
SFIC 7-pin with Less Core	CLS7	Add \$2.00 per cylinder
IC 7-pin with SFIC disposable temporary core	CT7SD	Add \$2.00 per cylinder
Master Ring <sup>2</sup>	MR	Add \$67.00 per cylinder
Flex Head Cylinder, 6-pin (sectional trim)	FX6	Add \$71.00 per cylinder
Flex Head Cylinder, 7-pin (sectional trim)	FX7	Add \$73.00 per cylinder
Flex Head Master Ring (sectional trim)	FXM	Add \$118.00 per cylinder
Plug only to show, 6-pin (concealed shell) (available for M and R escutcheons and single cylinder functions only)	P06	Add \$88.00 per lockset
Plug only to show, 7-pin (concealed shell) (available for M and R escutcheons and single cylinder functions only)	P07	Add \$90.00 per lockset

Notes:

1. CHS ordered with CT6 option no charge.
3. Refer to Key construction core program, pg. 63 for example of CTP option pricing.
4. For existing systems only.

# FE6600 Series Multi-Point Locks



January 1, 2019

## Cylinder & Keying Options\* (con't)

Description	Specify Quick Code	Add or Deduct
0-Bitted with two blank keys <sup>5</sup>	(standard)	No Charge
Keyed Random <sup>4</sup>	KR	No Charge
Master keyed (all cylinders except 8000, 8020, 8027 IC core)	specify keyset	Add \$16.00 per cylinder
Master keyed Pyramid	specify keyset	Add \$16.00 per cylinder
Master keyed Security (including IC cylinder and core)	specify keyset	Add \$16.00 per cylinder
Master keyed (8000, 8020, 8027 IC core)	specify keyset	No Charge
Master keyed to customer bittings or sample key	specify keyset	Add \$16.00 per cylinder
Construction master keyed <sup>1,2</sup>	CMK	Add \$16.00 per cylinder
Visual key control (VKC)		
- No Stamping	VKC0	\$4.50
- Keys only	VKC1	No Charge
- Cylinders and Keys <sup>3</sup>	VKC2	\$8.00
- Cylinders only <sup>3</sup>	VKC3	\$8.00
Concealed key control (CKC)		
- CKC cylinders with VKC keys	CKC2	\$8.00
- CKC cylinders only <sup>3</sup>	CKC3	\$8.00
More than 2 keys per lock	KY# (e.g., KY6)	See page 64 - Cut Keys Section

**Notes:**

1. CMK Construction master keying charge is in addition to master keying charge.
2. CMK Construction master keying is not available in Pyramid series cylinders.
3. VKC2, VKC3, CKC3 are not available in Pyramid or Security series.
4. Pyramid series is not available keyed random.
5. Security series is not available 0-bitted.

## Strike Options\*

Lip Length	ANSI Straight Lip - Specify Quick Code	ANSI Curved Lip - Specify Quick Code	Add or Deduct
7/8"	SS078	N/A	No Charge

\* If door thickness is standard or has been specified and no special door or frame condition exist, then only the first two characters of the optional strike Quick Code must be specified (e.g. "SA").

The correct lip length will be determined by our order entry system based on the standard or specified door thickness.

# FE6600 Series

## Multi-Point Locks

January 1, 2019

### Door Thickness with Locksets Mortised on Center

Door Thickness	Sectional Rose Trim Specify Quick Code	Escutcheon <sup>1,2</sup> Trim Specify Quick Code	Add or Deduct
1-3/4" (standard)	—	—	No Charge

### Options

Description	Specify Quick Code	Add or Deduct
Split designs and split finishes	Outside Trim x Inside Trim	Higher set price prevails
Spanner head screws	M02	Add \$18.00 per lockset
Torx® head screws (n/a with N escutcheon)	M04	Add \$24.00 per lockset
Single Occupancy Indicator - Secure/Unsecure (Outside)	M19S*	Add \$88.00 per lockset
Single Occupancy Indicator - Vacant/Occupied (Outside)	M19V*	Add \$88.00 per lockset
Double Occupancy Indicator - Secure/Unsecure (Outside) Secure/Unsecure (Inside)	M19SN*	Add \$168.00 per lockset
Double Indicator Vacant/Occupied (Outside) Secure/Unsecure (Inside)	M19VN*	Add \$168.00 per lockset
Knurling outside and inside	M20 <sup>1</sup>	Add \$137.00 per lockset
Knurling outside only	M21 <sup>1</sup>	Add \$69.00 per lockset
Knurling inside only	M22 <sup>1</sup>	Add \$69.00 per lockset
Abrasive coat outside and inside	M23 <sup>1</sup>	Add \$85.00 per lockset
Abrasive coat inside only	M24 <sup>1</sup>	Add \$43.00 per lockset
Abrasive coat outside only	M25 <sup>1</sup>	Add \$43.00 per lockset
Working trim only	M31	See pages 101 thru 111

### Thumbturn Options

Specify door thickness	Specify Quick Code	Add or Deduct
Ergonomic	M34 <sup>2</sup>	Add \$14.00 per TT
Decorative	MT1	No Charge
Decorative square	MT2	No Charge
Decorative cylinder	MT3	No Charge



MT1



MT2



MT3

Notes:

1. Not available on Vineyard™ Collection.
2. M34 is not available with M19N, M19VN or M19SN.

Note: Thumbturn backplate will match shape of rose chosen (i.e. round or square)

### Strike Options

Part Number	Description
726F577	Top Strike Pack
726F587	Bottom Strike Pack
726F607	Center Strike Pack

### Dogging Indicator Kit

AUX188 x FIN -Dogging Indicator kit if ordered separately

### Price

\$476.00

This product is part of a complete tornado assembly and must be used with a Ceco or Curries StormPro door. Concealed vertical rods, top and bottom bolts, and mortise lock body cassette will be factory installed. All other hardware components are shipped directly to the customer and must be installed by a factory trained installer.

**FE6600 Series**  
Multi-Point Locks



*January 1, 2019*

# FE6700

## Storm Shutter Multi-Point Latching System

January 1, 2019

### Standard Features

#### Handing

Device is handed

#### Shutter Thickness

FE6700 is for use with standard 1-3/4" thick shutters

#### Cylinder Furnished with:

Brass, 6-pin, L4 keyway, 0-bitted, 1-1/8" standard for FE6755 Classroom Function. Optional cylinders available; see Quick Codes

#### Warranty

Seven-year limited

#### UL Approved

Meets FEMA P320 (2014), P361 (2015) and ICC 500-2014 for inswing shutters 2'8" w x 3'00" h min to 4'0" w x 6'8" h max.

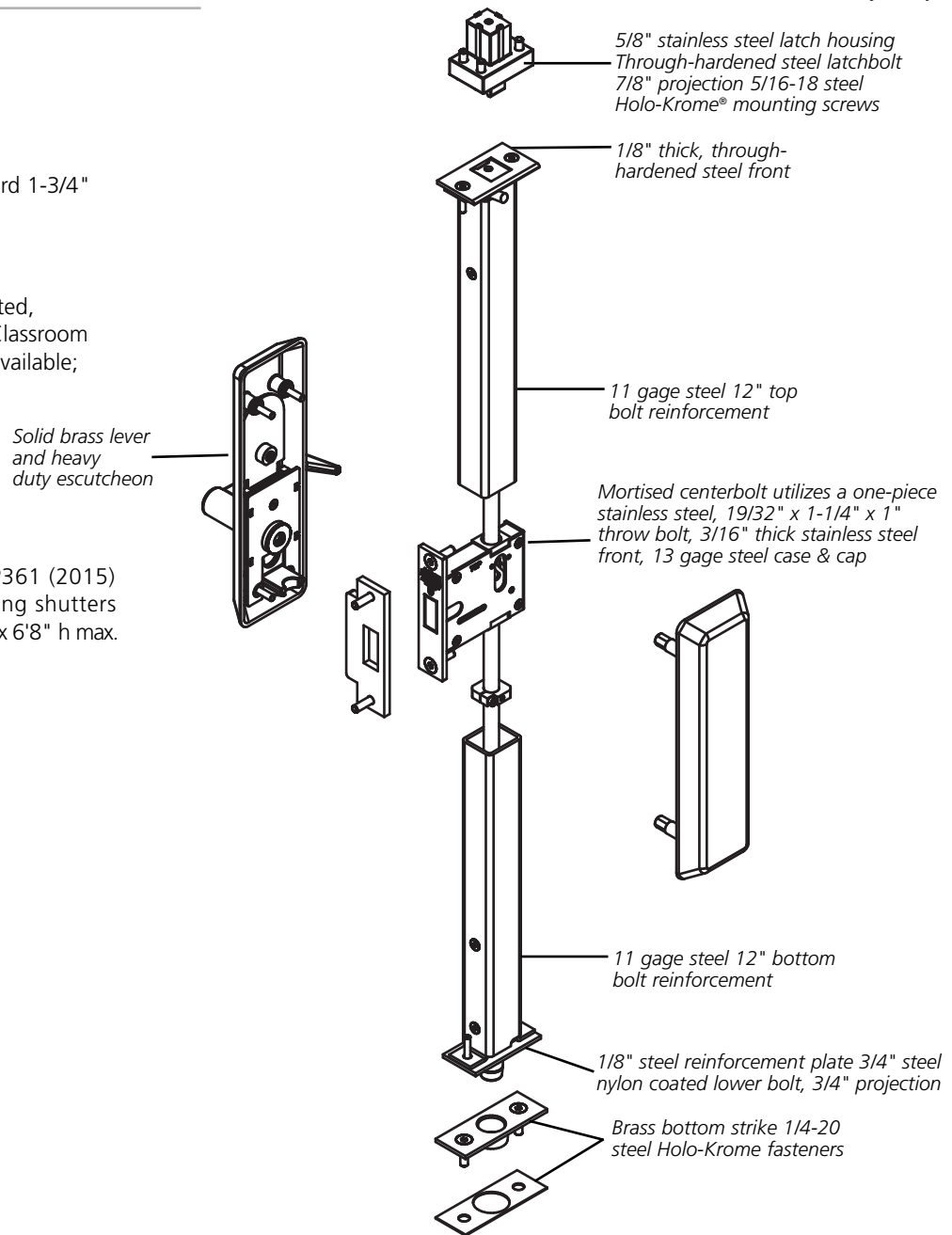

### Ordering Example

#### Stock Order

Quantity	Series/ Function	Trim	Finish	Hand	Shutter Height
100	FE6780	FSH	626	RH	H0400

**FE6700**  
Storm Shutter Multi-Point Latching System

January 1, 2019

**Lever: Solid cast**  
**Escutcheon: Forged**

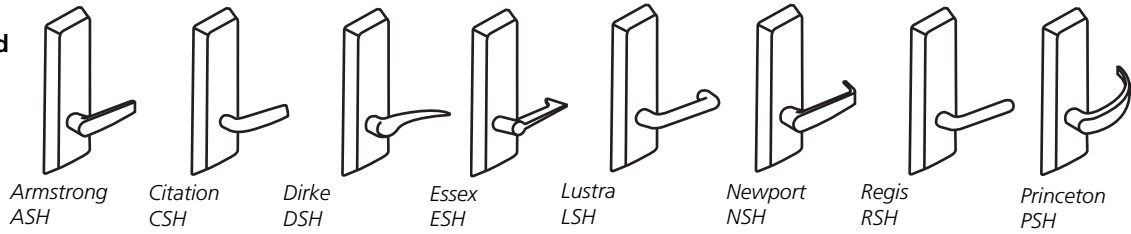

**FE6700 Series**

Function	Description	ASH, CSH, DSH, ESH, LSH, NSH, PSH, RSH			
		Finish Group 1		Finish Group 2	
		613E Dark Oxidized Satin Bronze	605 Polished Brass	619 Satin Nickel	
		630 Satin Stainless Steel(1)	606 Satin Brass	625 Polished Chrome	
		BSP Black Suede Powder Coat	611 Polished Bronze	629 Polished Stainless Steel(1)	
			612 Satin Bronze	626 Satin Chrome	
			613 Oil Rubbed Bronze	722 Black Oil Rubbed Bronze	
			618 Polished Nickel		
<b>For Typical Shutter Applications</b>					
FE6780	Passage Lever x Blank Plate				
<b>Optional Functions</b>		\$3,481.00		\$3,491.00	
FE6710	Passage or Closet				
FE6755	Classroom <sup>3</sup>				

1. H escutcheon is a brass forging finished to match 629 and 630 finishes  
3. Collar is required depending on length and type of cylinder. See Miscellaneous Options section on page 199.

**Lever: Solid Cast**  
**Escutcheon: Forged**

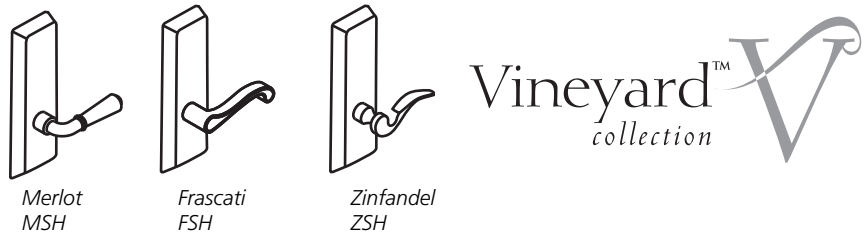

**FE6700 Series**

Function	Description	FSH, MSH, ZSH			
		Finish Group 1		Finish Group 2	
		613E Dark Oxidized Satin Bronze	605 Polished Brass	619 Satin Nickel	
		626 Satin Chrome	606 Satin Brass	625 Polished Chrome	
		BSP Black Suede Powder Coat	611 Polished Bronze	722 Black Oil Rubbed Bronze	
			612 Satin Bronze		
			613 Oil Rubbed Bronze		
			618 Polished Nickel		
<b>For Typical Shutter Applications</b>					
FE6780	Passage Lever x Blank Plate				
<b>Optional Functions</b>		\$3,481.00		\$3,491.00	
FE6710	Passage or Closet				
FE6755	Classroom <sup>3</sup>				

3. Collar is required depending on length and type of cylinder. See Miscellaneous Options section on page 199.

# FE6700

## Storm Shutter Multi-Point Latching System



January 1, 2019

### Optional Cylinder & Keying Options

Description	Specify Quick Code	Add or Deduct
Conventional 6-pin	6P**	Add \$86.00 per cylinder
Conventional 7-pin	7P	Add \$88.00 per cylinder
Access 3 Patented	AP	Add \$86.00 per cylinder
Access 3 Security	AS	Add \$135.00 per cylinder
Access 3 High Security, UL 437	AHS	Add \$155.00 per cylinder
Access 3 IC Patented	ACP	Add \$160.00 per cylinder
Access 3 IC Security	ACS	Add \$209.00 per cylinder
Access 3 IC High Security, UL 437	ACHS	Add \$223.00 per cylinder
Pyramid Security fixed core	PS	Add \$144.00 per cylinder
Pyramid Security IC	PCS	Add \$215.00 per cylinder
Pyramid High Security fixed core	PHS	Add \$174.00 per cylinder
Pyramid High Security IC	PCHS	Add \$244.00 per cylinder
Pyramid IC with temporary construction core	CTP	Add \$160.00 per cylinder
Pyramid IC with temporary disposable core	CTPD	Add \$86.00 per cylinder
Pyramid IC less core	CLP	Add \$86.00 per cylinder
Security	HS	Add \$197.00 per cylinder
Security IC	CHS	Add \$269.00 per cylinder
Blockout function	BO	Add \$179.00 per cylinder
IC 6-pin	C6	Add \$160.00 per cylinder
IC 6-pin with temporary construction core (Red)	CT6R	Add \$160.00 per cylinder
IC 6-pin with temporary construction core (Blue)	CT6B	Add \$160.00 per cylinder
IC 6-pin with temporary construction core (Green)	CT6G	Add \$160.00 per cylinder
IC 6-pin with temporary disposable core	CT6D	Add \$86.00 per cylinder
IC 6-pin less core	CL6	Add \$86.00 per cylinder
SFIC 6-pin with Less Core	CLS6	Add \$86.00 per cylinder
IC 6-pin with SFIC disposable temporary core	CT6SD	Add \$86.00 per cylinder
IC 7-pin	C7	Add \$164.00 per cylinder
IC 7-pin with temporary construction core (Red)	CT7R	Add \$164.00 per cylinder
IC 7-pin with temporary construction core (Blue)	CT7B	Add \$164.00 per cylinder
IC 7-pin with temporary construction core (Green)	CT7G	Add \$164.00 per cylinder
IC 7-pin with temporary disposable core	CT7D	Add \$88.00 per cylinder
IC 7-pin less core	CL7	Add \$88.00 per cylinder
SFIC 7-pin with Less Core	CLS7	Add \$88.00 per cylinder
IC 7-pin with SFIC disposable temporary core	CT7SD	Add \$88.00 per cylinder

\*Optional dogging cylinder will be furnished with the same mechanism and keyed alike with the trim cylinder, unless otherwise specified. If different keying or cylinder type is required, specify outside (trim) first, then inside (dogging) cylinder.

\*\*6P cylinder option is supplied in 6-pin, L4 keyway, 0-bitted with two nickel silver keys.

# FE6700

## Storm Shutter Multi-Point Latching System



### Optional Cylinder & Keying Options (con't)

January 1, 2019

Description	Specify	Add or Deduct
0-Bitted with two blank keys <sup>5</sup>	(standard)	No Charge
Keyed Random <sup>4</sup>	KR	No Charge
Master keyed (all cylinders except 8000, 8020, 8027 IC core)	specify keyset	Add \$16.00 per cylinder
Master keyed Pyramid	specify keyset	Add \$16.00 per cylinder
Master keyed Security (including IC cylinder and core)	specify keyset	Add \$16.00 per cylinder
Master keyed (8000, 8020, 8027 IC core)	specify keyset	No Charge
Master keyed to customer bittings or sample key	specify keyset	Add \$16.00 per cylinder
Construction master keyed <sup>1,2</sup>	CMK	Add \$16.00 per cylinder
Visual key control (VKC)		
- No Stamping	VKC0	\$4.50
- Keys only	VKC1	No Charge
- Cylinders and Keys <sup>3</sup>	VKC2	\$8.00
- Cylinders only <sup>3</sup>	VKC3	\$8.00
Concealed key control (CKC)		
- CKC cylinders with VKC keys	CKC2	\$8.00
- CKC cylinders only <sup>3</sup>	CKC3	\$8.00
More than 2 keys per lock	KY# (e.g., KY6)	See page 66 - Cut Keys Section

Notes:

1. CMK Construction master keying charge is in addition to master keying charge.
2. CMK Construction master keying is not available in Pyramid series cylinders.

3. VKC2, VKC3, CKC3 are not available in Pyramid or Security series.
4. Pyramid series is not available keyed random.
5. Security series is not available 0-bitted.

### Shutter Thickness

Description	Specify
1-3/4"	(standard)

### Shutter Height Options

Description	Specify
2'8" - 4'6"	H0400
4'6" - 6'8"	H0500

### Miscellaneous Options

Description	Specify	Add or Deduct
Torx Screws	M04	Add \$18.00 per lockset
1-1/8" cylinder collar (for 6-pin mortise cylinder) <sup>12</sup>	721F36	No Charge
1-1/4" cylinder collar (for 7-pin mortise cylinder) <sup>12</sup>	721F37	No Charge
1-1/2" cylinder collar (for 7-pin IC mortise cylinder) <sup>12</sup>	721F38	No Charge
MicroShield® Antimicrobial finish coating	630C	Add \$79.00 per lockset
MicroShield Antimicrobial finish coating	626C	Add \$79.00 per lockset

Notes:

1. For optional FE6755 classroom function, collar is required depending on length and type of cylinder.
2. Specify as optional collar when ordering cylinders only.



# MP9800 Series

## Multi-Point Vertical Rod Lock

### Standard Features

#### Handing

Field Reversible.

#### Doors

1-3/4" (44mm) door thickness standard,  
2-1/4" backset standard.

#### Mounting

Supplied fasteners are for metal doors with through-bolts for trim.

#### Rods

Steel. Top and bottom bolt travels 7/16" (11mm)  
Projection adjustable up to 3/4" (19mm).

#### Latching

Top and Bottom or Top only (M55).

#### Trim

Available with all lever designs.

#### Cylinder

See cylinders page 12.

#### Applications

Single or Double Door.

#### Thermal Pins

MP9800A x M55: devices are supplied with ONE thermal pin per  
fire-rated device, for installation on pairs of fire-rated doors.

#### Warranty

5 year.

**Featuring Ecoflex Technology**



Available Function Combinations:		Inside Function (N)									
		10	45*	49*	50	52	55*	59*	903*	905*	
Outside Function (E)	Blank Escutcheon Plate	01	X	X	X			X	X	X	X
	Passage only (No cylinder)	10	X	X	X			X	X		
	No outside Operation (No Cylinder); Pull Only	40+	X	X	X					X	X
	Class Room Key Outside Unlocks/locks Trim	45	X	X	X						
	Key unlocks Trim; Trim retracts latch; Trim relocks when key is removed	49	X	X	X					X	X
	Freewheeling Trim; No Outside Operation	50						X	X		
	Key outside unlocks/locks O/S trim; Key inside unlocks/locks O/S trim	52					X				
	Freewheeling Trim; Key Outside Unlocks/locks Trim	55	X			X		X	X		
	Freewheeling Trim; Key unlocks Trim;	59	X		X		X	X			
	Trim retracts latch/Trim relocks when key is removed										
	Electrified Trim - Fail Safe	903	X	X	X						X
Electrified Trim - Fail Secure	905	X	X	X						X	X

\* **Not recommended for use on any door used for Life Safety egress + Rigid lever**

\*Specify voltage desired for 903 and 905 functions (12VDC/24VDC)

### Ordering Examples

Qty	Device	Exterior Trim/Function			Interior Trim/Function			Finish	Hand	Door Thickness	Door Height	Misc. Options	Voltage for Electrified Trim
		Lever	Exterior	Function	Lever	Interior	Function						
65	MP9800	D	E	49	D	N	10	605	LHR	D214	H0800	M55	12V

### Contract/Detailed Order

Qty	Keyset	Series	Exterior Trim/Function			Interior Trim/Function			Finish	Hand	Door Thickness	Door Hght	Misc. Opts	Cyl Opts	Voltage for Electrified Trim
			Lever	Exterior	Function	Lever	Interior	Function							
36	AA1	MP9800A	101	E	50	101	N	55	626	LHR	D214	H1000	M93	7P	12V

# MP9800 Series

## Multi-Point Vertical Rod Lock

Lever: Solid Cast  
Escutcheon: Forged

January 1, 2019

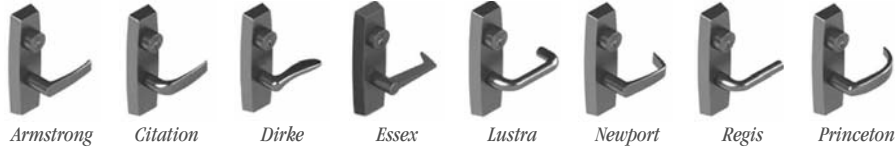

GEORGIA	101	102	103	104	124	125				
PABLO	117	126								
JACKSON	105	119	121	122	127					
SALVADOR	106	107	108	109	110	123	128			
MARC	111	112	113	114	115	116	130	131	132	

Note: Must designate E for exterior function or N for interior function when specifying order.

MP9800		613E, 626, BSP, WSP	605 606 611 612 613 618 625
Lever (E) x 01 x Lever (N) x *49	Blank Escutcheon Plate		
Lever (E) x 01 x Lever (N) x *45	Blank Escutcheon Plate		
Lever (E) x 01 x Lever (N) x 10	Blank Escutcheon Plate		
Lever (E) x 01 x Lever (N) x *55	Blank Escutcheon Plate		
Lever (E) x 01 x Lever (N) x 59	Blank Escutcheon Plate		
Lever (E) x 10 x Lever (N) x *49	Passage only (No cylinder)		
Lever (E) x 10 x Lever (N) x *45	Passage only (No cylinder)		
Lever (E) x 10 x Lever (N) x 10	Passage only (No cylinder)		
Lever (E) x 10 x Lever (N) x *55	Passage only (No cylinder)		
Lever (E) x 10 x Lever (N) x *59	Passage only (No cylinder)	\$2,005.00	\$2,079.00
Lever (E) x 40 x Lever (N) x *49	No outside Operation (No Cylinder); Pull Only		
Lever (E) x 40 x Lever (N) x *45	No outside Operation (No Cylinder); Pull Only		
Lever (E) x 40 x Lever (N) x 10	No outside Operation (No Cylinder); Pull Only		
Lever (E) x 45 x Lever (N) x *49	Class Room Key Outside Unlocks/locks Trim		
Lever (E) x 45 x Lever (N) x *45	Class Room Key Outside Unlocks/locks Trim		
Lever (E) x 45 x Lever (N) x 10	Class Room Key Outside Unlocks/locks Trim		
Lever (E) x 49 x Lever (N) x *10	Key unlocks Trim; Trim retracts latch; Trim relocks when key is removed		
Lever (E) x 49 x Lever (N) x *45	Key unlocks Trim; Trim retracts latch; Trim relocks when key is removed		
Lever (E) x 49 x Lever (N) x *49	Key unlocks Trim; Trim retracts latch; Trim relocks when key is removed		

\* Not recommended for use on any door used for Life Safety egress.

# MP9800 Series

## Multi-Point Vertical Rod Lock

January 1, 2019

<b>MP9800 Freewheeling Trim</b>		613E, 626, BSP, WSP	605 606 611 612 613 618 625
Lever (E) x 50 x Lever (N) x *55	Freewheeling Trim; No Outside Operation	\$2,005.00	\$2,079.00
Lever (E) x 50 x Lever (N) x *59	Freewheeling Trim; No Outside Operation		
Lever (E) x 52 x Lever (N) x 52	Key outside unlocks/locks O/S trim; Key inside unlocks/locks O/S trim		
Lever (E) x 55 x Lever (N) x *10	Freewheeling Trim; Key Outside Unlocks/locks Trim		
Lever (E) x 55 x Lever (N) x 50	Freewheeling Trim; Key Outside Unlocks/locks Trim		
Lever (E) x 55 x Lever (N) x *55	Freewheeling Trim; Key Outside Unlocks/locks Trim		
Lever (E) x 55 x Lever (N) x *59	Freewheeling Trim; Key Outside Unlocks/locks Trim		
Lever (E) x 59 x Lever (N) x *10	Freewheeling Trim; Key unlocks Trim; Trim retracts latch/Trim relocks when key is removed		
Lever (E) x 59 x Lever (N) x 50	Freewheeling Trim; Key unlocks Trim; Trim retracts latch/Trim relocks when key is removed		
Lever (E) x 59 x Lever (N) x *55	Freewheeling Trim; Key unlocks Trim; Trim retracts latch/Trim relocks when key is removed		
Lever (E) x 59 x Lever (N) x *59	Freewheeling Trim; Key unlocks Trim; Trim retracts latch/Trim relocks when key is removed		
<b>MP9800 Electromechanical</b>			
Lever (E) x 01 x Lever (N) x *903	Blank Escutcheon Plate	\$2,172.00	\$2,245.00
Lever (E) x 01 x Lever (N) x *905	Blank Escutcheon Plate		
Lever (E) x 40 x Lever (N) x *903	No outside Operation (No Cylinder); Pull Only		
Lever (E) x 40 x Lever (N) x *905	No outside Operation (No Cylinder); Pull Only		
Lever (E) x 49 x Lever (N) x *903	Key unlocks Trim; Trim retracts latch; Trim relocks when key is removed		
Lever (E) x 49 x Lever (N) x *905	Key unlocks Trim; Trim retracts latch; Trim relocks when key is removed		
Lever (E) x 903 x Lever (N) x 10	Electrified Trim - Fail Safe	\$2,341.00	\$2,415.00
Lever (E) x 903 x Lever (N) x *45	Electrified Trim - Fail Safe		
Lever (E) x 905 x Lever (N) x 10	Electrified Trim - Fail Secure		
Lever (E) x 905 x Lever (N) x *45	Electrified Trim - Fail Secure		
Lever (E) x 905 x Lever (N) x *903	Electrified Trim - Fail Secure		
Lever (E) x 905 x Lever (N) x *905	Electrified Trim - Fail Secure		
Lever (E) x 903 x Lever (N) x *903	Electrified Trim - Fail Safe		
Lever (E) x 903 x Lever (N) x *905	Electrified Trim - Fail Safe		

\* Not recommended for use on any door used for Life Safety egress.

**MP9800 Series**  
Multi-Point Vertical Rod Lock

Lever: Solid Cast  
Escutcheon: Forged

January 1, 2019

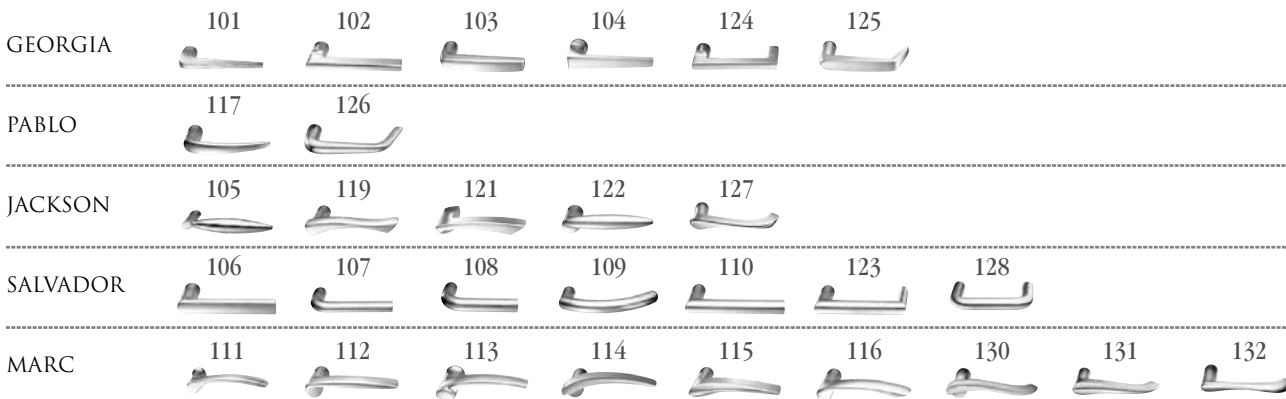
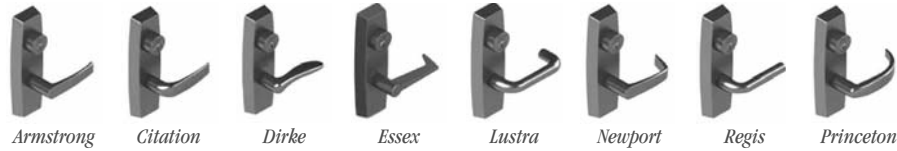

Note: Must designate E for exterior function or N for interior function when specifying order.

<b>MP9800A</b>		<b>613E, 626, BSP, WSP</b>	<b>605 606 611 612 613 618 625</b>
Lever (E) x 01 x Lever (N) x *49	Blank Escutcheon Plate	\$2,175.00	\$2,248.00
Lever (E) x 01 x Lever (N) x *45	Blank Escutcheon Plate		
Lever (E) x 01 x Lever (N) x 10	Blank Escutcheon Plate		
Lever (E) x 01 x Lever (N) x *55	Blank Escutcheon Plate		
Lever (E) x 01 x Lever (N) x *59	Blank Escutcheon Plate		
Lever (E) x 10 x Lever (N) x *49	Passage only (No cylinder)		
Lever (E) x 10 x Lever (N) x *45	Passage only (No cylinder)		
Lever (E) x 10 x Lever (N) x 10	Passage only (No cylinder)		
Lever (E) x 10 x Lever (N) x *55	Passage only (No cylinder)		
Lever (E) x 10 x Lever (N) x *59	Passage only (No cylinder)		
Lever (E) x 40 x Lever (N) x *49	No outside Operation (No Cylinder); Pull Only		
Lever (E) x 40 x Lever (N) x *45	No outside Operation (No Cylinder); Pull Only		
Lever (E) x 40 x Lever (N) x 10	No outside Operation (No Cylinder); Pull Only		
Lever (E) x 45 x Lever (N) x *49	Class Room Key Outside Unlocks/locks Trim		
Lever (E) x 45 x Lever (N) x *45	Class Room Key Outside Unlocks/locks Trim		
Lever (E) x 45 x Lever (N) x 10	Class Room Key Outside Unlocks/locks Trim		
Lever (E) x 49 x Lever (N) x *10	Key unlocks Trim; Trim retracts latch; Trim relocks when key is removed		
Lever (E) x 49 x Lever (N) x *45	Key unlocks Trim; Trim retracts latch; Trim relocks when key is removed		
Lever (E) x 49 x Lever (N) x *49	Key unlocks Trim; Trim retracts latch; Trim relocks when key is removed		

\* Not recommended for use on any door used for Life Safety egress.

# MP9800 Series

## Multi-Point Vertical Rod Lock

January 1, 2019

<b>MP9800A Freewheeling Trim</b>		<b>613E, 626, BSP, WSP</b>	<b>605 606 611 612 613 618 625</b>
Lever (E) x 50 x Lever (N) x *55	Freewheeling Trim; No Outside Operation	\$2,175.00	\$2,248.00
Lever (E) x 50 x Lever (N) x *59	Freewheeling Trim; No Outside Operation		
Lever (E) x 52 x Lever (N) x 52	Key outside unlocks/locks O/S trim; Key inside unlocks/locks O/S trim		
Lever (E) x 55 x Lever (N) x *10	Freewheeling Trim; Key Outside Unlocks/locks Trim		
Lever (E) x 55 x Lever (N) x 50	Freewheeling Trim; Key Outside Unlocks/locks Trim		
Lever (E) x 55 x Lever (N) x *55	Freewheeling Trim; Key Outside Unlocks/locks Trim		
Lever (E) x 55 x Lever (N) x *59	Freewheeling Trim; Key Outside Unlocks/locks Trim		
Lever (E) x 59 x Lever (N) x *10	Freewheeling Trim; Key unlocks Trim; Trim retracts latch/Trim relocks when key is removed		
Lever (E) x 59 x Lever (N) x 50	Freewheeling Trim; Key unlocks Trim; Trim retracts latch/Trim relocks when key is removed		
Lever (E) x 59 x Lever (N) x *55	Freewheeling Trim; Key unlocks Trim; Trim retracts latch/Trim relocks when key is removed		
Lever (E) x 59 x Lever (N) x *59	Freewheeling Trim; Key unlocks Trim; Trim retracts latch/Trim relocks when key is removed		
<b>MP9800A Electromechanical</b>		\$2,341.00	\$2,415.00
Lever (E) x 01 x Lever (N) x *903	Blank Escutcheon Plate		
Lever (E) x 01 x Lever (N) x *905	Blank Escutcheon Plate		
Lever (E) x 40 x Lever (N) x *903	No outside Operation (No Cylinder); Pull Only		
Lever (E) x 40 x Lever (N) x *905	No outside Operation (No Cylinder); Pull Only		
Lever (E) x 49 x Lever (N) x *903	Key unlocks Trim; Trim retracts latch; Trim relocks when key is removed		
Lever (E) x 49 x Lever (N) x *905	Key unlocks Trim; Trim retracts latch; Trim relocks when key is removed		
Lever (E) x 903 x Lever (N) x 10	Electrified Trim - Fail Safe		
Lever (E) x 903 x Lever (N) x *45	Electrified Trim - Fail Safe		
Lever (E) x 905 x Lever (N) x 10	Electrified Trim - Fail Secure		
Lever (E) x 905 x Lever (N) x *45	Electrified Trim - Fail Secure		
Lever (E) x 905 x Lever (N) x *903	Electrified Trim - Fail Secure	\$2,511.00	\$2,584.00
Lever (E) x 905 x Lever (N) x *905	Electrified Trim - Fail Secure		
Lever (E) x 903 x Lever (N) x *903	Electrified Trim - Fail Safe		
Lever (E) x 903 x Lever (N) x *905	Electrified Trim - Fail Safe		

\* Not recommended for use on any door used for Life Safety egress.

# MP9800 Series

## Multi-Point Vertical Rod Lock

January 1, 2019



<b>MP9800</b>		
	Piet 21G, 21L, 21M, 21S, 21W, 23M, 25M, 27M	629, 630
Lever (E) x 01 x Lever (N) x *49	Blank Escutcheon Plate	\$2,187.00
Lever (E) x 01 x Lever (N) x *45	Blank Escutcheon Plate	
Lever (E) x 01 x Lever (N) x 10	Blank Escutcheon Plate	
Lever (E) x 01 x Lever (N) x *55	Blank Escutcheon Plate	
Lever (E) x 01 x Lever (N) x 59	Blank Escutcheon Plate	
Lever (E) x 10 x Lever (N) x *49	Passage only (No cylinder)	
Lever (E) x 10 x Lever (N) x *45	Passage only (No cylinder)	
Lever (E) x 10 x Lever (N) x 10	Passage only (No cylinder)	
Lever (E) x 10 x Lever (N) x *55	Passage only (No cylinder)	
Lever (E) x 10 x Lever (N) x *59	Passage only (No cylinder)	
Lever (E) x 40 x Lever (N) x *49	No outside Operation (No Cylinder); Pull Only	
Lever (E) x 40 x Lever (N) x *45	No outside Operation (No Cylinder); Pull Only	
Lever (E) x 40 x Lever (N) x 10	No outside Operation (No Cylinder); Pull Only	
Lever (E) x 45 x Lever (N) x *49	Class Room Key Outside Unlocks/locks Trim	
Lever (E) x 45 x Lever (N) x *45	Class Room Key Outside Unlocks/locks Trim	
Lever (E) x 45 x Lever (N) x 10	Class Room Key Outside Unlocks/locks Trim	
Lever (E) x 49 x Lever (N) x *10	Key unlocks Trim; Trim retracts latch; Trim relocks when key is removed	
Lever (E) x 49 x Lever (N) x *45	Key unlocks Trim; Trim retracts latch; Trim relocks when key is removed	
Lever (E) x 49 x Lever (N) x *49	Key unlocks Trim; Trim retracts latch; Trim relocks when key is removed	
<b>MP9800 Freewheeling Trim</b>		
Lever (E) x 50 x Lever (N) x *55	Freewheeling Trim; No Outside Operation	\$2,187.00
Lever (E) x 50 x Lever (N) x *59	Freewheeling Trim; No Outside Operation	
Lever (E) x 52 x Lever (N) x 52	Key outside unlocks/locks O/S trim; Key inside unlocks/locks O/S trim	
Lever (E) x 55 x Lever (N) x *10	Freewheeling Trim; Key Outside Unlocks/locks Trim	
Lever (E) x 55 x Lever (N) x 50	Freewheeling Trim; Key Outside Unlocks/locks Trim	
Lever (E) x 55 x Lever (N) x *55	Freewheeling Trim; Key Outside Unlocks/locks Trim	
Lever (E) x 55 x Lever (N) x *59	Freewheeling Trim; Key Outside Unlocks/locks Trim	
Lever (E) x 59 x Lever (N) x *10	Freewheeling Trim; Key unlocks Trim; Trim retracts latch/Trim relocks when key is removed	
Lever (E) x 59 x Lever (N) x 50	Freewheeling Trim; Key unlocks Trim; Trim retracts latch/Trim relocks when key is removed	
Lever (E) x 59 x Lever (N) x *55	Freewheeling Trim; Key unlocks Trim; Trim retracts latch/Trim relocks when key is removed	
Lever (E) x 59 x Lever (N) x *59	Freewheeling Trim; Key unlocks Trim; Trim retracts latch/Trim relocks when key is removed	
<b>MP9800 Electromechanical</b>		
Lever (E) x 01 x Lever (N) x *903	Blank Escutcheon Plate	\$2,354.00
Lever (E) x 01 x Lever (N) x *905	Blank Escutcheon Plate	
Lever (E) x 40 x Lever (N) x *903	No outside Operation (No Cylinder); Pull Only	
Lever (E) x 40 x Lever (N) x *905	No outside Operation (No Cylinder); Pull Only	
Lever (E) x 49 x Lever (N) x *903	Key unlocks Trim; Trim retracts latch; Trim relocks when key is removed	
Lever (E) x 49 x Lever (N) x *905	Key unlocks Trim; Trim retracts latch; Trim relocks when key is removed	
Lever (E) x 903 x Lever (N) x 10	Electrified Trim - Fail Safe	
Lever (E) x 903 x Lever (N) x *45	Electrified Trim - Fail Safe	
Lever (E) x 905 x Lever (N) x 10	Electrified Trim - Fail Secure	
Lever (E) x 905 x Lever (N) x *45	Electrified Trim - Fail Secure	
Lever (E) x 905 x Lever (N) x *903	Electrified Trim - Fail Secure	\$2,523.00
Lever (E) x 905 x Lever (N) x *905	Electrified Trim - Fail Secure	
Lever (E) x 903 x Lever (N) x *903	Electrified Trim - Fail Safe	
Lever (E) x 903 x Lever (N) x *905	Electrified Trim - Fail Safe	

\* Not recommended for use on any door used for Life Safety egress.

# MP9800 Series

## Multi-Point Vertical Rod Lock

January 1, 2019



<b>MP9800A</b>		
	Piet 21G, 21L, 21M, 21S, 21W, 23M, 25M, 27M	629, 630
Lever (E) x 01 x Lever (N) x *49	Blank Escutcheon Plate	\$2,357.00
Lever (E) x 01 x Lever (N) x *45	Blank Escutcheon Plate	
Lever (E) x 01 x Lever (N) x 10	Blank Escutcheon Plate	
Lever (E) x 01 x Lever (N) x *55	Blank Escutcheon Plate	
Lever (E) x 01 x Lever (N) x 59	Blank Escutcheon Plate	
Lever (E) x 10 x Lever (N) x *49	Passage only (No cylinder)	
Lever (E) x 10 x Lever (N) x *45	Passage only (No cylinder)	
Lever (E) x 10 x Lever (N) x 10	Passage only (No cylinder)	
Lever (E) x 10 x Lever (N) x *55	Passage only (No cylinder)	
Lever (E) x 10 x Lever (N) x *59	Passage only (No cylinder)	
Lever (E) x 40 x Lever (N) x *49	No outside Operation (No Cylinder); Pull Only	
Lever (E) x 40 x Lever (N) x *45	No outside Operation (No Cylinder); Pull Only	
Lever (E) x 40 x Lever (N) x 10	No outside Operation (No Cylinder); Pull Only	
Lever (E) x 45 x Lever (N) x *49	Class Room Key Outside Unlocks/locks Trim	
Lever (E) x 45 x Lever (N) x *45	Class Room Key Outside Unlocks/locks Trim	
Lever (E) x 45 x Lever (N) x 10	Class Room Key Outside Unlocks/locks Trim	
Lever (E) x 49 x Lever (N) x *10	Key unlocks Trim; Trim retracts latch; Trim relocks when key is removed	
Lever (E) x 49 x Lever (N) x *45	Key unlocks Trim; Trim retracts latch; Trim relocks when key is removed	
Lever (E) x 49 x Lever (N) x *49	Key unlocks Trim; Trim retracts latch; Trim relocks when key is removed	
<b>MP9800A Freewheeling Trim</b>		
Lever (E) x 50 x Lever (N) x *55	Freewheeling Trim; No Outside Operation	\$2,357.00
Lever (E) x 50 x Lever (N) x *59	Freewheeling Trim; No Outside Operation	
Lever (E) x 52 x Lever (N) x 52	Key outside unlocks/locks O/S trim; Key inside unlocks/locks O/S trim	
Lever (E) x 55 x Lever (N) x *10	Freewheeling Trim; Key Outside Unlocks/locks Trim	
Lever (E) x 55 x Lever (N) x 50	Freewheeling Trim; Key Outside Unlocks/locks Trim	
Lever (E) x 55 x Lever (N) x *55	Freewheeling Trim; Key Outside Unlocks/locks Trim	
Lever (E) x 55 x Lever (N) x *59	Freewheeling Trim; Key Outside Unlocks/locks Trim	
Lever (E) x 59 x Lever (N) x *10	Freewheeling Trim; Key unlocks Trim; Trim retracts latch/Trim relocks when key is removed	
Lever (E) x 59 x Lever (N) x 50	Freewheeling Trim; Key unlocks Trim; Trim retracts latch/Trim relocks when key is removed	
Lever (E) x 59 x Lever (N) x *55	Freewheeling Trim; Key unlocks Trim; Trim retracts latch/Trim relocks when key is removed	
Lever (E) x 59 x Lever (N) x *59	Freewheeling Trim; Key unlocks Trim; Trim retracts latch/Trim relocks when key is removed	
<b>MP9800A Electromechanical</b>		
Lever (E) x 01 x Lever (N) x *903	Blank Escutcheon Plate	\$2,523.00
Lever (E) x 01 x Lever (N) x *905	Blank Escutcheon Plate	
Lever (E) x 40 x Lever (N) x *903	No outside Operation (No Cylinder); Pull Only	
Lever (E) x 40 x Lever (N) x *905	No outside Operation (No Cylinder); Pull Only	
Lever (E) x 49 x Lever (N) x *903	Key unlocks Trim; Trim retracts latch; Trim relocks when key is removed	
Lever (E) x 49 x Lever (N) x *905	Key unlocks Trim; Trim retracts latch; Trim relocks when key is removed	
Lever (E) x 903 x Lever (N) x 10	Electrified Trim - Fail Safe	
Lever (E) x 903 x Lever (N) x *45	Electrified Trim - Fail Safe	
Lever (E) x 905 x Lever (N) x 10	Electrified Trim - Fail Secure	
Lever (E) x 905 x Lever (N) x *45	Electrified Trim - Fail Secure	
Lever (E) x 905 x Lever (N) x *903	Electrified Trim - Fail Secure	\$2,693.00
Lever (E) x 905 x Lever (N) x *905	Electrified Trim - Fail Secure	
Lever (E) x 903 x Lever (N) x *903	Electrified Trim - Fail Safe	
Lever (E) x 903 x Lever (N) x *905	Electrified Trim - Fail Safe	

\* Not recommended for use on any door used for Life Safety egress.

**MP9800 Series**  
Multi-Point Vertical Rod Lock

JOSEF

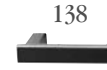

January 1, 2019

GEORGES



**MP9800**

	Josef, Georges Levers	613E, 626, BSP, WSP	605 606 611 612 613 618 625
Lever (E) x 01 x Lever (N) x *49	Blank Escutcheon Plate	\$2,107.00	\$2,187.00
Lever (E) x 01 x Lever (N) x *45	Blank Escutcheon Plate		
Lever (E) x 01 x Lever (N) x 10	Blank Escutcheon Plate		
Lever (E) x 01 x Lever (N) x *55	Blank Escutcheon Plate		
Lever (E) x 01 x Lever (N) x 59	Blank Escutcheon Plate		
Lever (E) x 10 x Lever (N) x *49	Passage only (No cylinder)		
Lever (E) x 10 x Lever (N) x *45	Passage only (No cylinder)		
Lever (E) x 10 x Lever (N) x 10	Passage only (No cylinder)		
Lever (E) x 10 x Lever (N) x *55	Passage only (No cylinder)		
Lever (E) x 10 x Lever (N) x *59	Passage only (No cylinder)		
Lever (E) x 40 x Lever (N) x *49	No outside Operation (No Cylinder); Pull Only		
Lever (E) x 40 x Lever (N) x *45	No outside Operation (No Cylinder); Pull Only		
Lever (E) x 40 x Lever (N) x 10	No outside Operation (No Cylinder); Pull Only		
Lever (E) x 45 x Lever (N) x *49	Class Room Key Outside Unlocks/locks Trim		
Lever (E) x 45 x Lever (N) x *45	Class Room Key Outside Unlocks/locks Trim		
Lever (E) x 45 x Lever (N) x 10	Class Room Key Outside Unlocks/locks Trim		
Lever (E) x 49 x Lever (N) x *10	Key unlocks Trim; Trim retracts latch; Trim relocks when key is removed		
Lever (E) x 49 x Lever (N) x *45	Key unlocks Trim; Trim retracts latch; Trim relocks when key is removed		
Lever (E) x 49 x Lever (N) x *49	Key unlocks Trim; Trim retracts latch; Trim relocks when key is removed		

**MP9800 Freewheeling Trim**

Lever (E) x 50 x Lever (N) x *55	Freewheeling Trim; No Outside Operation	\$2,107.00	\$2,187.00
Lever (E) x 50 x Lever (N) x *59	Freewheeling Trim; No Outside Operation		
Lever (E) x 52 x Lever (N) x 52	Key outside unlocks/locks O/S trim; Key inside unlocks/locks O/S trim		
Lever (E) x 55 x Lever (N) x *10	Freewheeling Trim; Key Outside Unlocks/locks Trim		
Lever (E) x 55 x Lever (N) x 50	Freewheeling Trim; Key Outside Unlocks/locks Trim		
Lever (E) x 55 x Lever (N) x *55	Freewheeling Trim; Key Outside Unlocks/locks Trim		
Lever (E) x 55 x Lever (N) x *59	Freewheeling Trim; Key Outside Unlocks/locks Trim		
Lever (E) x 59 x Lever (N) x *10	Freewheeling Trim; Key unlocks Trim; Trim retracts latch/Trim relocks when key is removed		
Lever (E) x 59 x Lever (N) x 50	Freewheeling Trim; Key unlocks Trim; Trim retracts latch/Trim relocks when key is removed		
Lever (E) x 59 x Lever (N) x *55	Freewheeling Trim; Key unlocks Trim; Trim retracts latch/Trim relocks when key is removed		
Lever (E) x 59 x Lever (N) x *59	Freewheeling Trim; Key unlocks Trim; Trim retracts latch/Trim relocks when key is removed		

**MP9800 Electromechanical**

Lever (E) x 01 x Lever (N) x *903	Blank Escutcheon Plate	\$2,273.00	\$2,354.00
Lever (E) x 01 x Lever (N) x *905	Blank Escutcheon Plate		
Lever (E) x 40 x Lever (N) x *903	No outside Operation (No Cylinder); Pull Only		
Lever (E) x 40 x Lever (N) x *905	No outside Operation (No Cylinder); Pull Only		
Lever (E) x 49 x Lever (N) x *903	Key unlocks Trim; Trim retracts latch; Trim relocks when key is removed		
Lever (E) x 49 x Lever (N) x *905	Key unlocks Trim; Trim retracts latch; Trim relocks when key is removed		
Lever (E) x 903 x Lever (N) x 10	Electrified Trim - Fail Safe	\$2,443.00	\$2,523.00
Lever (E) x 903 x Lever (N) x *45	Electrified Trim - Fail Safe		
Lever (E) x 905 x Lever (N) x 10	Electrified Trim - Fail Secure		
Lever (E) x 905 x Lever (N) x *45	Electrified Trim - Fail Secure		
Lever (E) x 905 x Lever (N) x *903	Electrified Trim - Fail Secure		
Lever (E) x 905 x Lever (N) x *905	Electrified Trim - Fail Secure		
Lever (E) x 903 x Lever (N) x *903	Electrified Trim - Fail Safe		
Lever (E) x 903 x Lever (N) x *905	Electrified Trim - Fail Safe		

\* Not recommended for use on any door used for Life Safety egress.



# MP9800 Series

## Multi-Point Vertical Rod Lock

January 1, 2019

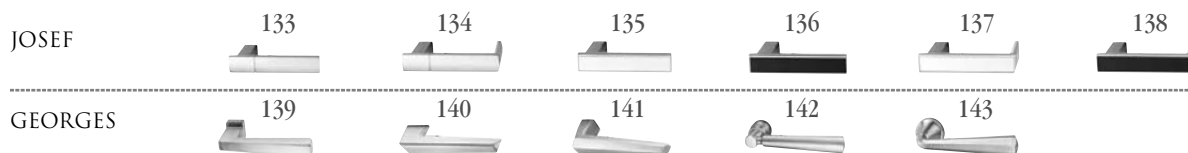

<b>MP9800A</b>		613E, 626, BSP, WSP	605 606 611 612 613 618 625
	<b>Josef, Georges Levers</b>		
Lever (E) x 01 x Lever (N) x *49	Blank Escutcheon Plate	\$2,277.00	\$2,357.00
Lever (E) x 01 x Lever (N) x *45	Blank Escutcheon Plate		
Lever (E) x 01 x Lever (N) x 10	Blank Escutcheon Plate		
Lever (E) x 01 x Lever (N) x *55	Blank Escutcheon Plate		
Lever (E) x 01 x Lever (N) x 59	Blank Escutcheon Plate		
Lever (E) x 10 x Lever (N) x *49	Passage only (No cylinder)		
Lever (E) x 10 x Lever (N) x *45	Passage only (No cylinder)		
Lever (E) x 10 x Lever (N) x 10	Passage only (No cylinder)		
Lever (E) x 10 x Lever (N) x *55	Passage only (No cylinder)		
Lever (E) x 10 x Lever (N) x *59	Passage only (No cylinder)		
Lever (E) x 40 x Lever (N) x *49	No outside Operation (No Cylinder); Pull Only		
Lever (E) x 40 x Lever (N) x *45	No outside Operation (No Cylinder); Pull Only		
Lever (E) x 40 x Lever (N) x 10	No outside Operation (No Cylinder); Pull Only		
Lever (E) x 45 x Lever (N) x *49	Class Room Key Outside Unlocks/locks Trim		
Lever (E) x 45 x Lever (N) x *45	Class Room Key Outside Unlocks/locks Trim		
Lever (E) x 45 x Lever (N) x 10	Class Room Key Outside Unlocks/locks Trim		
Lever (E) x 49 x Lever (N) x *10	Key unlocks Trim; Trim retracts latch; Trim relocks when key is removed		
Lever (E) x 49 x Lever (N) x *45	Key unlocks Trim; Trim retracts latch; Trim relocks when key is removed		
Lever (E) x 49 x Lever (N) x *49	Key unlocks Trim; Trim retracts latch; Trim relocks when key is removed		
<b>MP9800A Freewheeling Trim</b>			
Lever (E) x 50 x Lever (N) x *55	Freewheeling Trim; No Outside Operation	\$2,277.00	\$2,357.00
Lever (E) x 50 x Lever (N) x *59	Freewheeling Trim; No Outside Operation		
Lever (E) x 52 x Lever (N) x 52	Key outside unlocks/locks O/S trim; Key inside unlocks/locks O/S trim		
Lever (E) x 55 x Lever (N) x *10	Freewheeling Trim; Key Outside Unlocks/locks Trim		
Lever (E) x 55 x Lever (N) x 50	Freewheeling Trim; Key Outside Unlocks/locks Trim		
Lever (E) x 55 x Lever (N) x *55	Freewheeling Trim; Key Outside Unlocks/locks Trim		
Lever (E) x 55 x Lever (N) x *59	Freewheeling Trim; Key Outside Unlocks/locks Trim		
Lever (E) x 59 x Lever (N) x *10	Freewheeling Trim; Key unlocks Trim; Trim retracts latch/Trim relocks when key is removed		
Lever (E) x 59 x Lever (N) x 50	Freewheeling Trim; Key unlocks Trim; Trim retracts latch/Trim relocks when key is removed		
Lever (E) x 59 x Lever (N) x *55	Freewheeling Trim; Key unlocks Trim; Trim retracts latch/Trim relocks when key is removed		
Lever (E) x 59 x Lever (N) x *59	Freewheeling Trim; Key unlocks Trim; Trim retracts latch/Trim relocks when key is removed		
<b>MP9800A Electromechanical</b>			
Lever (E) x 01 x Lever (N) x *903	Blank Escutcheon Plate	\$2,443.00	\$2,523.00
Lever (E) x 01 x Lever (N) x *905	Blank Escutcheon Plate		
Lever (E) x 40 x Lever (N) x *903	No outside Operation (No Cylinder); Pull Only		
Lever (E) x 40 x Lever (N) x *905	No outside Operation (No Cylinder); Pull Only		
Lever (E) x 49 x Lever (N) x *903	Key unlocks Trim; Trim retracts latch; Trim relocks when key is removed		
Lever (E) x 49 x Lever (N) x *905	Key unlocks Trim; Trim retracts latch; Trim relocks when key is removed		
Lever (E) x 903 x Lever (N) x 10	Electrified Trim - Fail Safe	\$2,612.00	\$2,693.00
Lever (E) x 903 x Lever (N) x *45	Electrified Trim - Fail Safe		
Lever (E) x 905 x Lever (N) x 10	Electrified Trim - Fail Secure		
Lever (E) x 905 x Lever (N) x *45	Electrified Trim - Fail Secure		
Lever (E) x 905 x Lever (N) x *903	Electrified Trim - Fail Secure		
Lever (E) x 905 x Lever (N) x *905	Electrified Trim - Fail Secure		
Lever (E) x 903 x Lever (N) x *903	Electrified Trim - Fail Safe		
Lever (E) x 903 x Lever (N) x *905	Electrified Trim - Fail Safe		

\* Not recommended for use on any door used for Life Safety egress.

# MP9800 Series

## Multi-Point Vertical Rod Lock



January 1, 2019

*Cylinder Options	Specify	Add or Deduct
Conventional 6-pin	6P	Add \$86.00 per cylinder
Conventional 7-pin	7P	Add \$88.00 per cylinder
Access 3 Patented	AP	Add \$86.00 per cylinder
Access 3 Security	AS	Add \$135.00 per cylinder
Access 3 High Security, UL 437	AHS	Add \$155.00 per cylinder
Access 3 IC Patented	ACP	Add \$160.00 per cylinder
Access 3 IC Security	ACS	Add \$209.00 per cylinder
Access 3 IC High Security, UL 437	ACHS	Add \$223.00 per cylinder
Pyramid Security fixed core	PS	Add \$144.00 per cylinder
Pyramid Security IC	PCS	Add \$215.00 per cylinder
Pyramid High Security fixed core	PHS	Add \$174.00 per cylinder
Pyramid High Security IC	PCHS	Add \$244.00 per cylinder
Pyramid IC with temporary construction core	CTP	Add \$160.00 per cylinder
Pyramid IC with temporary disposable core	CTPD	Add \$86.00 per cylinder
Pyramid IC less core	CLP	Add \$86.00 per cylinder
Security	HS	Add \$197.00 per cylinder
Security IC	CHS	Add \$269.00 per cylinder
Blockout function	BO	Add \$179.00 per cylinder
IC 6-pin	C6	Add \$160.00 per cylinder
IC 6-pin with temporary construction core(Red)	CT6R	Add \$160.00 per cylinder
IC 6-pin with temporary construction core(Blue)	CT6B	Add \$160.00 per cylinder
IC 6-pin with temporary construction core(Green)	CT6G	Add \$160.00 per cylinder
IC 6-pin with temporary disposable core	CT6D	Add \$86.00 per cylinder
IC 6-pin less core	CL6	Add \$86.00 per cylinder
SFIC 6-pin with Less Core	CLS6	Add \$86.00 per cylinder
IC 6-pin with SFIC disposable temporary core	CT6SD	Add \$86.00 per cylinder
IC 7-pin	C7	Add \$164.00 per cylinder
IC 7-pin with temporary construction core(Red)	CT7R	Add \$164.00 per cylinder
IC 7-pin with temporary construction core(Blue)	CT7B	Add \$164.00 per cylinder
IC 7-pin with temporary construction core(Green)	CT7G	Add \$164.00 per cylinder
IC 7-pin with temporary disposable core	CT7D	Add \$88.00 per cylinder
IC 7-pin less core	CL7	Add \$88.00 per cylinder
SFIC 7-pin with Less Core	CLS7	Add \$88.00 per cylinder
IC 7-pin with SFIC disposable temporary core	CTS7SD	Add \$88.00 per cylinder
*Keying Options	Specify Quick Code	Add or Deduct
O-Bitted with 2 blank keys	STDKEY	No Charge
Keyed random	KR Specify Keyset	No Charge
Master keyed (all cylinders except 8000, 8020, 8027 IC core)	MK	Add \$16.00 per cylinder
Master keyed Pyramid	MK	Add \$16.00 per cylinder
Master keyed Security (including IC cylinder and core)	MK	Add \$16.00 per cylinder
Master keyed (8000, 8020, 8027 IC core)	MK-IC	No Charge
Master keyed to customer bittings or sample key	MK-CB	Add \$16.00 per cylinder
Construction master keyed	CMK	Add \$16.00 per cylinder
No Stamping	VKCO	\$4.50
Keys only	VKC1	No Charge
Cylinders and Keys	VKC2	\$8.00
Cylinders only	VKC3	\$8.00
CKC cylinders with VKC keys	CKC2	\$8.00
CKC cylinders only	CKC3	\$8.00

# MP9800 Series

## Multi-Point Vertical Rod Lock



January 1, 2019

Door Height Options	Specify	Add or Deduct
7'0"	Standard	No Charge
7'2"	H702	
7'6"	H706	
8'0"	H0800	
9'0"	H0900	
10'0"	H1000	
Door Thickness	Specify	Add or Deduct
1-3/4" (44mm)	Standard	No Charge
2" (51mm)	D200	No Charge
2-1/4" (57mm)	D214	No Charge
Motorized Electric Latch Retraction	Specify	Add or Deduct
Electric Latch Retraction	MELR	Add \$835.00 per device

# MP9800 Series

## Multi-Point Vertical Rod Lock



January 1, 2019

Miscellaneous Options	Specify	Add or Deduct
Spanner Head Screw	M02	Add \$33.00 per device
Torx® head screws	M04	Add \$44.00 per device
Knurling outside and inside	M20	Add \$145.00 per device
Knurling outside only	M21	Add \$68.00 per device
Knurling inside only	M22	Add \$77.00 per device
Abrasive coat outside and inside (trim and device)	M23	Add \$92.00 per device
Abrasive coat inside only (device side)	M24	Add \$48.00 per device
Abrasive coat outside only (trim side)	M25	Add \$44.00 per device
Less bottom vertical rod	M55	No Charge
Latchbolt Monitoring	M91	Add \$217.00 per device
O/S Lever Monitoring	M93	Add \$204.00 per device
I/S Lever Monitoring	M92	Add \$204.00 per device
Windstorm	M107	Add \$85.00 per device
Aluminum Door	MPAD	No Charge
Rectangular Back Plate (Required for Wood Door - MPWD)	MPER	
Back Plate (Required for Wood Door - MPWD)	MPES	
Lever Hold Back	MPHB	Add \$20.00 per device
Fire Rated Wood Door	MPWD	No Charge
aux control (classroom)	AUX155	Add \$605.00 per device
aux control (storeroom)	AUX159	Add \$605.00 per device
MicroShield® Antimicrobial finish coating	626C	Add \$64.00 (Exit Devices & Trims (ordered separately) Add \$79.00 (Exit Devices & Outside Trims (ordered together)
MicroShield® Antimicrobial finish coating	630C	Add \$64.00 (Exit Devices & Trims (ordered separately) Add \$79.00 (Exit Devices & Outside Trims (ordered together)

EXIT DEVICES	PAGES
MicroShield® How to Order, Pricing	247
MicroShield® Notes	248
<b>ED3000 Crossbar Series:</b>	
ED3000 Series Standard Features	249
ED3000 Series Ordering Examples	250
ED3000 Series: Rim ED3200	251
ED3000 Series: Surface Vertical Rod ED3400 Series, Mortise ED3600 Series	252
ED3000 Series Escutcheon Trim Designs: A33 Armstrong, C33 Citation, D33 Dirke, L33 Lustra	253
ED3000 Series Escutcheon Trim Designs: N33 Newport, PR33 Princeton, R33 Regis	254
ED3000 Series Escutcheon Trim Designs: T33 D Grip, T34 Round Grip, T35 Sectional Grip, Auxiliary Control/Inside Lever Assembly: 3357T Nightlatch	255
ED3000 Series Offset Pull Trim & Cylinder Options	256
ED3000 Series Keying Options	257
ED3000 Series Strike Options	258
ED3000 Series Miscellaneous, Door Width, Door Thickness, Door Height Options	259
ED3000 Series Mullions, Removable Mullions, Key Removable Mullions, Mullion Cylinder Options, Ordering Examples	260
<b>ED4000 Narrow Stile Pushpad Series:</b>	
ED4000 Series How to Order	261
ED4000 Series Standard Features	262
ED4000 Series Ordering Example	263
ED4000 Series: ED4200S, ED4200, ED4400, ED4800	264
ED4000 Series Escutcheon Trim Designs: A8 Armstrong, C8 Citation, D8 Dirke	265
ED4000 Series Escutcheon Trim Designs: E8 Essex, L8 Lustra, N8 Newport, R8 Regis	266
ED4000 Series Escutcheon Trim Designs: PR8 Princeton, G8 Global, F4 Plate, O8 Plate x Thumbturn	267
ED4000 Series Escutcheon Trim Designs: O14 Plate x Thumbturn, T14 Pull/Thumbpiece, P10 Pull, K1 Key Only	268
ED4000 Series Pull Trim & Accessories	269
ED4000 Series Cylinder & Keying Options	270
ED4000 Series Door Height Options for ED4400, ED4800 Series, Width, Thickness, Strike Options	271
ED4000 Series Miscellaneous Options, Removable Mullion	272
<b>ED5000 Pushpad Series:</b>	
ED5000 Series How to Order	273
ED5000 Series Standard Features	274
ED5000 Series Ordering Examples	275
ED5000 Series: ED5200S, ED5200, ED5400, ED5600, ED5800, ED5000DB	276
ED5000 Series Escutcheon Trim Designs: A9 Armstrong, C9 Citation, D9 Dirke	277
ED5000 Series Escutcheon Trim Designs: E9 Essex, L9 Lustra, N9 Newport, R9 Regis	278
ED5000 Series Escutcheon Trim Designs: PR9 Princeton, F9, G9, VT9	279
ED5000 Series Escutcheon Trim Designs: FR9 Frascati, M9 Merlot, Z9 Zinfandel	280
ED5000 Series Escutcheon Trim Designs: TH900 Pull/Thumbpiece, P9 Pull, K1 Key Only	281
ED5000 Series Escutcheon Trim Designs: A4M Armstrong, C9M Citation, D9M Dirke	282
ED5000 Series Escutcheon Trim Designs: E9M Essex, L9M Lustra, N9M Newport	283
ED5000 Series Escutcheon Trim Designs: R9M Regis, PR9M Princeton, F9, G9M	284
ED5000 Series Escutcheon Trim Designs: FR9M Frascati, M9M Merlot, Z9M Zinfandel	285
ED5000 Series Escutcheon Trim Designs: TH900, TH9M00 Pull/Thumbpiece,	286
ED5000 Series Escutcheon Trim Designs: P9M Pull, VT9M, K1M Key Only	287
ED5000 Series Escutcheon Trim Designs: L9 Lustra, N9 Newport, R9 Regis, PR9 Princeton	288
ED5000 Series Escutcheon Trim Designs: FR9 Frascati, M9 Merlot, Z9 Zinfandel	289
ED5000 Series Offset Pull Trim P12, P13, P14, Electrified Options, Delayed Egress Device, Retrofit MELR Kit:	290
ED5000 Series Electrified Accessories	291
ED5000 Series Cylinder & Keying Options	292
ED5000 Series Door Height, Door Width, Door Thickness, Strike Options	293
ED5000 Series Miscellaneous Options, Surface Bolt	294
ED5000 Series Mullions, Removable Mullions, Key Removable Mullions, Mullions Cylinder Options	295

**EXIT DEVICES**
**PAGES**
**ED7000 Narrow Stile Crossbar Series:**

ED7000 Series Standard Features	296
ED7000 Series Ordering Example	297
ED7000 Series: ED7200, ED7400, ED7600, ED7800	298
ED7000 Series Pull Trim Designs: P4 D Grip Pull, P5 Round Grip Pull, P6 Pull, P7 Plate	299
ED7000 Series Escutcheon Trim Designs: C4 Citation, D4 Dirke, O3 D Grip Operator, O4 Round Grip Operator	300
ED7000 Series Escutcheon Trim Designs: C4M Citation, D4M Dirke, G6M Global	301
ED7000 Series Escutcheon Trim Designs: T11M D Grip, T12M Round Grip, O5 Operator, Offset Pull Trim: P12, P13, P14	302
ED7000 Series Cylinder & Keying Options	303
ED7000 Series Strike Options	304
ED7000 Series Door Width, Door Thickness, Door Height, Miscellaneous Options	305
ED7000 Series Mortise Lock Only, Removable Mullion Ordering Example	306

**ED8000 Pushpad Series:**

ED8000 Series Standard Features	307
ED8000 Series Ordering Example	308
ED8000 Series: Rim ED8200, Vertical Rod ED8400	309
ED8000 Series Rose Trim Designs: A6 Armstrong, N6 Newport, PR6 Princeton	310
ED8000 Series Rose Trim G10 Global, Flat Plate Trim F1 Flat Plate, Pull Trim Design P1 Z-Pull	311
ED8000 Series Pull Trim: P2 Offset Pull, P8 Wing Pull, KO Key Only, Offset Pull Trim: P12, P13, P14	312
ED8000 Series Cylinder Options	313
ED8000 Series Keying, Door Width, Door Thickness, Door Height Options	314
ED8000 Series Miscellaneous & Strike Options	315
ED8000 Series Alarm Kit, Mullions, Door Height Options, Mullions Cylinder Options	316



Look for the   
MicroShield icon.

ED3000  
ED4000  
ED5000  
ED7000

**MicroShield®**

As part of their promise to provide innovative solutions to their customers, certain ASSA ABLOY Group brands offer the MicroShield® technology, a silver-based antimicrobial coating designed to inhibit the growth of bacteria.

MicroShield® is a registered trademark of Yale Security Inc., an ASSA ABLOY Group company.

Product	Series	MicroShield® Coated Components
Exit Devices	ED4000 and ED5000 Series	Inside rail, push rail, head cover, end cap* Outside trim: levers/pull* and escutcheons
	ED3000 and ED7000 Series	Active/Inactive case covers, cross bar, arms Outside trim: levers/pull* and escutcheons

**AVAILABLE FINISHES**

- MicroShield® is available on 626 and 630. Other finishes available by Special Product Application Request Form only.
- Specify 626C (satin chrome plated) or 630C (satin stainless steel) when ordering.
- MicroShield® coating will be applied over 626 and 630 finishes. All components will match 626.

*Note: MicroShield® coating will only be applied to “high touch” components.*

**HOW TO ORDER**

Product	How to Order
Exit Devices & Outside Trims (ordered together)	ED5200 x C955ET x 630C x LHR
Exit Devices & Trims (ordered separately)	N955ET x 630C x RHR

Description	Add
Exit Devices & Outside Trims (ordered together)	Add \$79.00 (when ordered together)
Exit Devices & Trims (ordered separately)	Add \$64.00

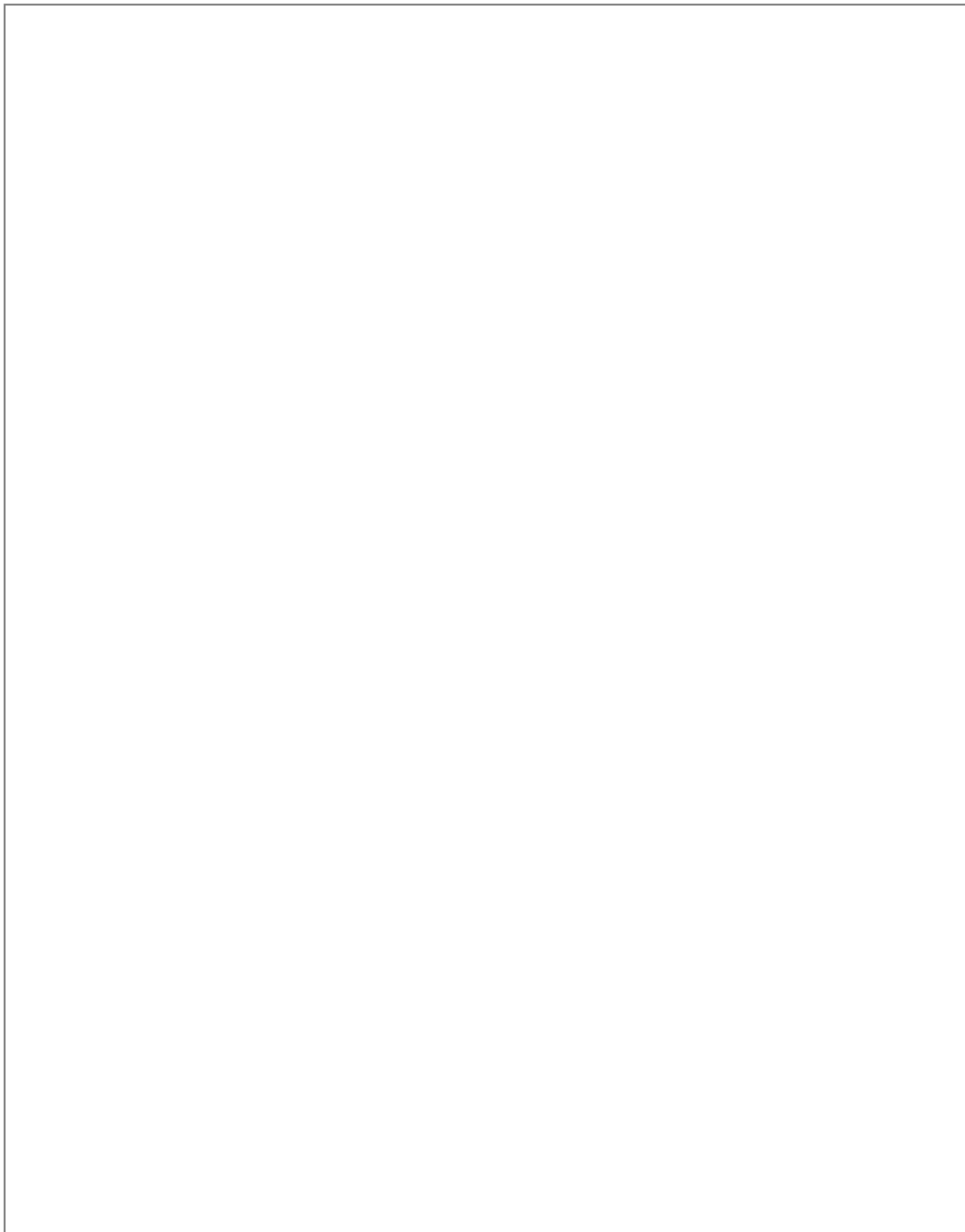



**Standard Features**

**Handing**

Handed, specify hand

**Door Thickness**

1-3/4"

**Backset**

2-3/4"

**Projection**

5-3/4"; 4-1/2" depressed

**Trim**

Cylinder is not included.  
See page 256 for  
cylinder options.

**Rim**

ED3200  
ED3200A

Panic  
3 Hour Fire Rated

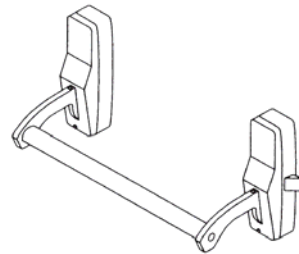

**Surface Vertical Rod**

ED3400  
ED3400A

Panic  
3 Hour Fire Rated

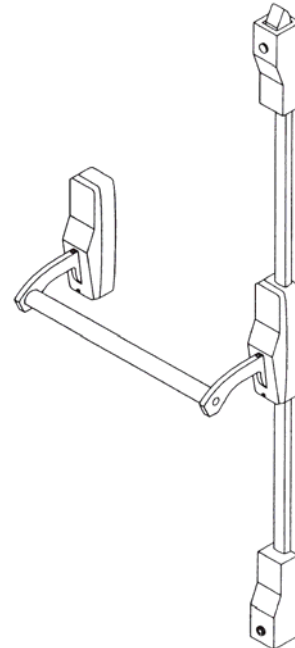

**Mortise**

ED3600  
ED3600A

Panic  
3 Hour Fire Rated

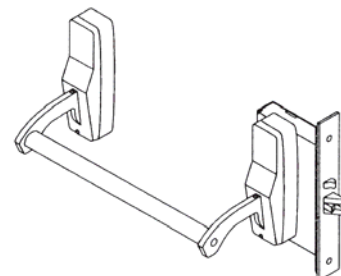

**Ordering Examples**
**Rim Exit Device**

Quantity	Exit Device	Finish	Hand	Misc. Options
20	ED3250	630	RHR	M51-M54

**Rim Exit Device with Trim**

Quantity	Exit Device	Trim	Finish	Hand	Door Thickness	Door Width	Misc. Options
50	ED3255A	A3355ET	630	RHR	D200	W048	M53

**Trim Only (Rim Exit Device or Vertical Rod)**

Quantity	Exit Device	Finish	Hand
10	L3310ET	606	RHR

**Surface Vertical Rod Exit Device with Trim**

Quantity	Exit Device	Trim	Finish	Hand	Door Thickness	Door Width	Misc. Options
50	ED3410	R3310ET	606	RHR	D214	W048	H1000

**Mortise Exit Device with Trim**

Quantity	Exit Device	Trim	Finish	Hand	Door Thickness	Strike	Door Width
50	ED3657	L3357ET	630	LHR	D200	SB200	W048

**Contract/Detailed Order - Rim Exit Device with Trim**

Quantity	Keyset	Exit Device	Trim	Finish	Hand	Door Thickness	Door Width	Optional Cylinders	Keying
50	AA1	ED3255	N3355ET	630	LHR	D200	W048	C6	VKC3

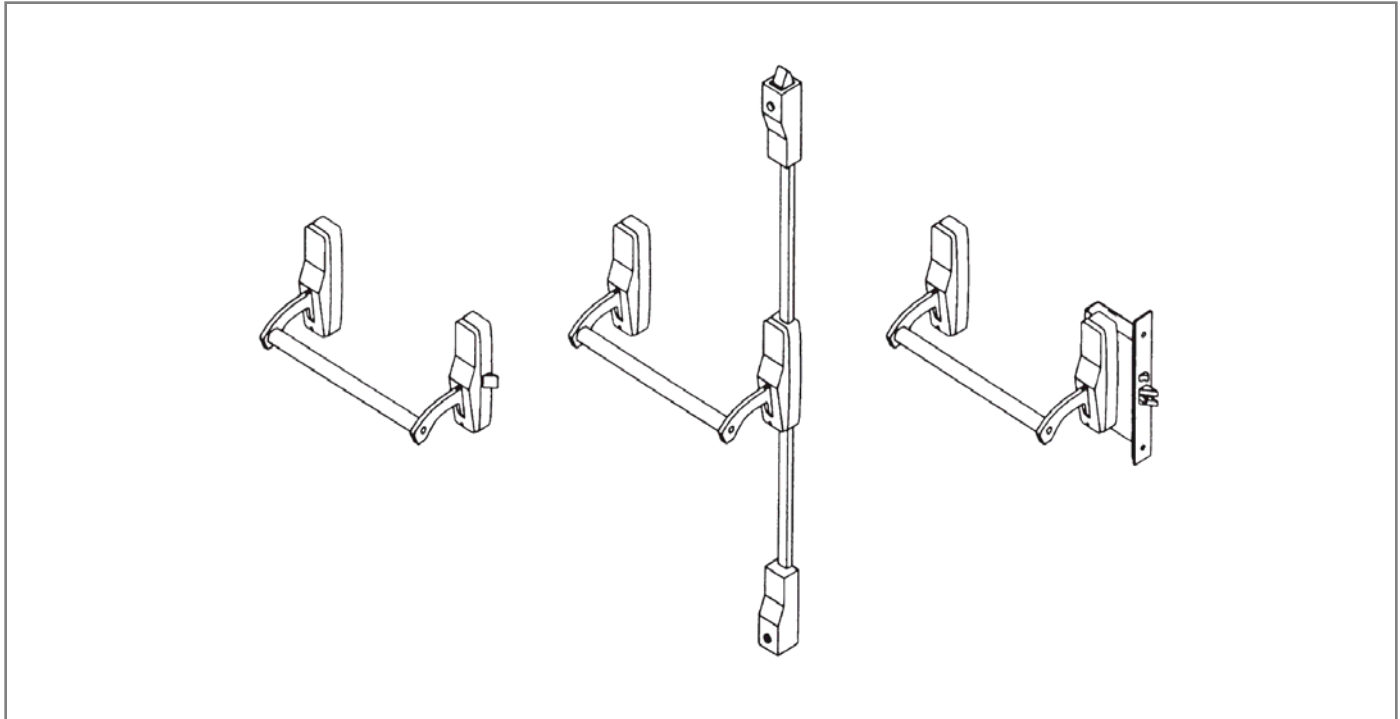

**36" Device Only**

Includes device, strike(s) and screw pack. No cylinder or trim.

**Rim ED3200 Series**

Function	Description	Finish: 613E	Finish: 605, 606, 611, 612, 613, 629, 630
ED3210	Panic device only (Passage)	\$1,819.00	\$1,989.00
ED3250	Panic device only (Dummy)		
ED3255	Panic (Classroom)		
ED3257	Panic (Nightlatch)		
ED3210T	Thumb Piece (Passage)		
ED3255T	Thumb Piece (Classroom)	\$1,989.00	\$2,159.00
ED3210A	3 Hour Fire Rated (Passage)		
ED3250A	3 Hour Fire Rated (Dummy)		
ED3255A	3 Hour Fire Rated (Classroom)		
ED3257A	3 Hour Fire Rated (Nightlatch)		
ED3210AT	Thumb Piece – 3 Hour Fire Rated (Passage)		
ED3255AT	Thumb Piece – 3 Hour Fire Rated (Classroom)		

**Caution:** Be sure of your measurements. Exit devices are NOT returnable.

Notes:

For doors over 1-3/4" thick, a Special Application Request must be submitted to the factory prior to approval and pricing.

**Surface Vertical Rod ED3400 Series**

Function	Description	Finish: 613E	Finish: 605, 606, 611, 612, 613, 629, 630
ED3410	Panic (Passage)	\$2,324.00	\$2,494.00
ED3450	Panic (Dummy)		
ED3455	Panic (Classroom)		
ED3457	Panic (Nightlatch)		
ED3410T	Thumb Piece (Passage)		
ED3455T	Thumb Piece (Classroom)	\$2,494.00	\$2,664.00
ED3410A	3 Hour fire rated (Passage)		
ED3450A	3 Hour fire rated (Dummy)		
ED3455A	3 Hour Fire Rated (Classroom)		
ED3457A	3 Hour Fire Rated (Nightlatch)		
ED3410AT	Thumb Piece – 3 Hour Fire Rated (Passage)		
ED3455AT	Thumb Piece – 3 Hour Fire Rated (Classroom)		

**Mortise ED3600 Series**

Function	Description	Finish: 613E	Finish: 605, 606, 611, 612, 613, 629, 630
ED3610	Panic (Passage)	\$2,099.00	\$2,269.00
ED3650	Panic (Dummy)		
ED3655	Panic (Classroom)		
ED3657	Panic (Nightlatch)		
ED3610T	Thumb Piece (Passage)		
ED3655T	Thumb Piece (Classroom)		
ED3610A	3 Hour fire rated (Passage)		
ED3650A	3 Hour fire rated (Dummy)		
ED3655A	3 Hour Fire Rated (Classroom)		
ED3657A	3 Hour Fire Rated (Nightlatch)		
ED3610AT	Thumb Piece – 3 Hour Fire Rated (Passage)		
ED3655AT	Thumb Piece – 3 Hour Fire Rated (Classroom)		

**Caution:** Be sure of your measurements. Exit devices are NOT returnable.

Notes:

For doors over 1-3/4" thick, a Special Application Request must be submitted to the factory prior to approval and pricing.

**ED3200/ED3200A/ED3400/ED3400A/ED3600/ED3600A Rim, Surface Vertical Rod, and Mortise Trim**

Cylinder is not included.

**Escutcheon Trim Design: A33 Armstrong**



**Lever:** Cast    **Escutcheon:** Cast

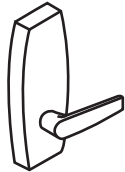

Function	Description	Finish: 613E, 626	Finish: 605, 606, 611, 612, 613, 618, 619, 625
A3310ET	Passage	\$519.00	\$555.00
A3350ET	Dummy		
A3355ET	Classroom		
A3357ET	Nightlatch – Rim		
A33V57ET	Nightlatch – SVR		
A33M57ET	Nightlatch – Mortise		

**Escutcheon Trim Design: C33 Citation**



**Lever:** Cast    **Escutcheon:** Cast



Function	Description	Finish: 613E, 626	Finish: 605, 606, 611, 612, 613, 618, 619, 625
C3310ET	Passage	\$519.00	\$555.00
C3350ET	Dummy		
C3355ET	Classroom		
C3357ET	Nightlatch – Rim		
C33V57ET	Nightlatch – SVR		
C33M57ET	Nightlatch – Mortise		

**Escutcheon Trim Design: D33 Dirke**



**Lever:** Cast    **Escutcheon:** Cast

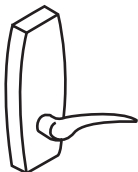

Function	Description	Finish: 613E, 626	Finish: 605, 606, 611, 612, 613, 618, 619, 625
D3310ET	Passage	\$519.00	\$555.00
D3350ET	Dummy		
D3355ET	Classroom		
D3357ET	Nightlatch – Rim		
D33V57ET	Nightlatch – SVR		
D33M57ET	Nightlatch – Mortise		

**Escutcheon Trim Design: L33 Lustra**



**Lever:** Cast    **Escutcheon:** Cast

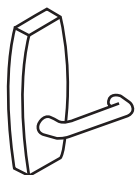

Function	Description	Finish: 613E, 626	Finish: 605, 606, 611, 612, 613, 618, 619, 625
L3310ET	Passage	\$519.00	\$555.00
L3350ET	Dummy		
L3355ET	Classroom		
L3357ET	Nightlatch – Rim		
L33V57ET	Nightlatch – SVR		
L33M57ET	Nightlatch – Mortise		

**ED3200/ED3200A/ED3400/ED3400A/ED3600/ED3600A Rim, Surface Vertical Rod, and Mortise Trim**

Cylinder is not included.

**Escutcheon Trim Design: N33 Newport**



**Lever:** Cast    **Escutcheon:** Cast



Function	Description	Finish: 613E, 626	Finish: 605, 606, 611, 612, 613, 618, 619, 625
N3310ET	Passage	\$519.00	\$555.00
N3350ET	Dummy		
N3355ET	Classroom		
N3357ET	Nightlatch – Rim		
N33V57ET	Nightlatch – SVR		
N33M57ET	Nightlatch – Mortise		

**Escutcheon Trim Design: PR33 Princeton**



**Lever:** Cast    **Escutcheon:** Cast



Function	Description	Finish: 613E, 626	Finish: 605, 606, 611, 612, 613, 618, 619, 625
PR3310ET	Passage	\$519.00	\$555.00
PR3350ET	Dummy		
PR3355ET	Classroom		
PR3357ET	Nightlatch – Rim		
PR33V57ET	Nightlatch – SVR		
PR33M57ET	Nightlatch – Mortise		

**Escutcheon Trim Design: R33 Regis**



**Lever:** Cast    **Escutcheon:** Cast

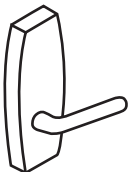

Function	Description	Finish: 613E, 626	Finish: 605, 606, 611, 612, 613, 618, 619, 625
R3310ET	Passage	\$519.00	\$555.00
R3350ET	Dummy		
R3355ET	Classroom		
R3357ET	Nightlatch – Rim		
R33V57ET	Nightlatch – SVR		
R33M57ET	Nightlatch – Mortise		

**ED3200/ED3200A/ED3400/ED3400A/ED3600/ED3600A Rim, Surface Vertical Rod, and Mortise Trim**

Cylinder is not included.

**Escutcheon Trim Design: T33 D Grip**

**Grip:** Extruded **Escutcheon:** Wrought



Function	Description	Finish: 613E, 626	Finish: 605, 606, 611, 612, 613, 618, 619, 625, 629, 630
T3310ET	Passage	\$339.00	\$367.00
T3350ET	Dummy		
T3355ET	Classroom		
T3357ET	Nightlatch – Rim		
T33M55ET	Classroom – Mortise		
T33M57ET	Nightlatch – Mortise		

**Escutcheon Trim Design: T34 Round Grip**

**Grip:** Extruded **Escutcheon:** Wrought



Function	Description	Finish: 613E, 626	Finish: 605, 606, 611, 612, 613, 618, 619, 625
T3410ET	Passage	\$339.00	\$367.00
T3450ET	Dummy		
T3455ET	Classroom		
T3457ET	Nightlatch – Rim		
T34M55ET	Classroom – Mortise		
T34M57ET	Nightlatch – Mortise		

**Escutcheon Trim Design: T35 Sectional Grip**

**Grip:** Extruded



Function	Description	Finish: 613E, 626	Finish: 605, 606, 611, 612, 613, 618, 619, 625, 629, 630
T3510ET	Passage	\$369.00	\$399.00
T3550ET	Dummy		
T3555ET	Classroom		
T3557ET	Nightlatch – Rim		
T35M55ET	Classroom – Mortise		
T35M57ET	Nightlatch – Mortise		

**Auxiliary Control/Inside Lever Assembly: 3357T Nightlatch**

Auxiliary Control



Function	Description	Finish: 613E, 626	Finish: 605, 606, 611, 612, 613, 618, 619, 625, 629, 630
3357T	Auxiliary Control/Inside Lever Assembly	\$678.00	\$714.00

Inside Lever Assembly



**Offset Pull Trim: P12, P13, P14**

Offset Pull Trim	Part Number	Finish: 613E, 630, BSP	Finishes: 605, 606, 612, 613, 626, 629
P12	716F50M X Finish	\$270.00	\$284.00
P13	716F51M X Finish	\$330.00	\$344.00
P14	716F52M X Finish	\$233.00	\$247.00

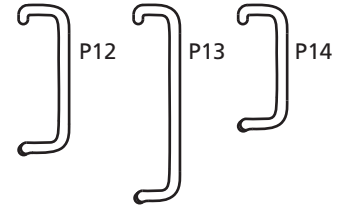
**Cylinder Options**

Description	Specify	Add or Deduct
Conventional 6-pin	6P*	Add \$86.00 per cylinder
Conventional 7-pin	7P	Add \$88.00 per cylinder
Access 3 Patented	AP	Add \$86.00 per cylinder
Access 3 Security	AS	Add \$135.00 per cylinder
Access 3 High Security, UL 437	AHS	Add \$155.00 per cylinder
Access 3 IC Patented	ACP	Add \$160.00 per cylinder
Access 3 IC Security	ACS	Add \$209.00 per cylinder
Access 3 IC High Security, UL 437	ACHS	Add \$223.00 per cylinder
Pyramid Security fixed core	PS	Add \$144.00 per cylinder
Pyramid Security IC	PCS	Add \$215.00 per cylinder
Pyramid High Security fixed core	PHS	Add \$174.00 per cylinder
Pyramid High Security IC	PCHS	Add \$244.00 per cylinder
Pyramid IC with temporary construction core	CTP	Add \$160.00 per cylinder
Pyramid IC with temporary disposable core	CTPD	Add \$86.00 per cylinder
Pyramid IC less core	CLP	Add \$86.00 per cylinder
Security	HS	Add \$197.00 per cylinder
Security IC	CHS	Add \$269.00 per cylinder
Blockout function cylinder	BO	Add \$179.00 per cylinder
IC 6-pin	C6	Add \$160.00 per cylinder
IC 6-pin with temporary construction core (Red)	CT6R	Add \$160.00 per cylinder
IC 6-pin with temporary construction core (Blue)	CT6B	Add \$160.00 per cylinder
IC 6-pin with temporary construction core (Green)	CT6G	Add \$160.00 per cylinder
IC 6-pin with temporary disposable core	CT6D	Add \$86.00 per cylinder
IC 6-pin less core	CL6	Add \$86.00 per cylinder
SFIC 6-pin with Less Core	CLS6	Add \$86.00 per cylinder
IC 6-pin with SFIC disposable temporary core	CT6SD	Add \$86.00 per cylinder
IC 7-pin	C7**	Add \$164.00 per cylinder
IC 7-pin with temporary construction core (Red)	CT7R**	Add \$164.00 per cylinder
IC 7-pin with temporary construction core (Blue)	CT7B**	Add \$164.00 per cylinder
IC 7-pin with temporary construction core (Green)	CT7G**	Add \$164.00 per cylinder
IC 7-pin with temporary disposable core	CT7D**	Add \$88.00 per cylinder
IC 7-pin less core	CL7**	Add \$88.00 per cylinder
SFIC 7-pin with Less Core	CLS7**	Add \$88.00 per cylinder
IC 7-pin with SFIC disposable temporary core	CT7SD**	Add \$88.00 per cylinder

\*6P cylinder option is supplied in 6-pin, L4 keyway 0-bitted with two nickel silver keys.

IC 6-pin with temporary construction core CT6.

IC 7-pin with temporary construction core CT7.

\*\*Not available with Rim or SVR Lever Trim – Classroom Function.  
or SVR Lever Trim – Night Latch Function.



**Keying Options**

Description	Specify	Add or Deduct
0-Bitted with 2 blank keys	(standard)	No Charge
Keyed random	KR	No Charge
Construction master keyed <sup>1,2</sup>	CMK	Add \$16.00 per cylinder
Visual key control (VKC)		
- No Stamping	VKC0	\$4.50
- Keys only	VKC1	No Charge
- Cylinders and Keys <sup>3</sup>	VKC2	\$8.00
- Cylinders only <sup>3</sup>	VKC3	\$8.00
Concealed key control (CKC)		
- CKC cylinders with VKC keys	CKC2	\$8.00
- CKC cylinders only <sup>3</sup>	CKC3	\$8.00
More than 2 keys per lock	KY# (e.g., KY6)	See page 66 - Cut Keys Section

**Notes:**

1. CMK Construction master keying charge is in addition to master keying charge.
2. CMK Construction master keying is not available in Pyramid or Security series.
3. VKC2, VKC3, CKC3 are not available in Pyramid or Security series.

**Custom Laser Engraving- LASER**
**Laser engraving processing charge (all engraving types)**

- \$250 net per order. Charge will be applied to production order when placed.

**Single Vanity, Logo or Other (same engraving on all parts)**

- Lever - \$10 net add each
- Mortise Escutcheon - \$10 net add each
- HPSK Paddle - \$10 net add each

**Unique laser engraving (i.e. Room Number, Apartment Number, etc)**

- \$12 net add each (per piece)

**Strike Options**

To purchase strike separately see catalog for part no.

Description	Specify Quick Code	Add or Deduct
Fire rated rim strike on ED3200	(standard)	No Charge
Mortised adjustable rim strike	S04	
Rim x vertical rod strike for pairs of doors	S02	Add \$26.00 to device
Vertical rod flush bottom strike (ED3400 only)	S03	No Charge
Vertical rod surface projecting bottom strike on ED3400 device	(standard)	
Fire rated vertical rod bottom strike on ED3400A device	(standard)	
Fire rated vertical rod bottom strike for threshold	S06	

Description	Door Thickness	Specify	Add or Deduct
Curved lip ANSI strike	1-3/4"	SA114 (standard)	No Charge
	2"	SA138	
	2-1/4"	SA158	

Description	Door Thickness	Specify	Add or Deduct
Mortise straight lip ANSI strike on ED3600, ED3600A	1-3/4"	SS118	No Charge
	2"	SS138	
	2-1/4"	SS158	

Description	Door Thickness	Specify	Add or Deduct
Mortise open back strike	1-3/4"	SB134	Add \$80.00 per device
	2"	SB200	\$128.00
	2-1/4"	SB214	\$128.00

**Miscellaneous Options**

Description	Specify	Add or Deduct
Spanner head screws	M02	Add \$33.00 per device
Torx® screws for rim, mortise	M04	Add \$44.00 per device
Torx® screws for surface vertical rod		Add \$83 per device
Abrasive coat outside and inside (trim and device)	M23	Add \$92.00 per device
Abrasive coat inside only (device side)	M24	Add \$48.00 per device
Abrasive coat outside only (trim side)	M25	Add \$44.00 per device
Steel reinforced crossbar	M53	Add \$68.00 per device
Sex nuts and bolts (SNBs)	M54	No Charge
Mullion stabilizer	M57	Add \$62.00 per mullion
Shim for 2-3/4" backset on doors with 1/2" stop (rim devices only)	M59	No Charge
Flush transom bracket	M67	Add \$30.00 per device

**Door Width Options**

Description	Specify	Add or Deduct
36"	(standard)	No Charge
48"	W048	Add \$35.00 per device

**Door Thickness Options**

Description	Specify	Add or Deduct
1-3/4"	(standard)	No Charge
2"	D200	
2-1/4"	D214	

**Door Height Options**

Description	Specify	Add or Deduct
7'0" H0700	H0700	No Charge
7'2" H0702	H0702	
7'6" H0706	H0706	
8' (Standard)	(standard)	
8'6" H0806 (ED3400 device only)	H0806	Add \$82.00 per device
9' H0900 (ED3400 device only)	H0900	
10' H01000 (ED3400 device only)	H1000	

**Mullions**

Cylinder not included

**Ordering Example**

Quantity	Mullion Number
10	507

**Removable Mullion**

Description	Specify	Price
Up to 7'0" Steel Mullion - Panic Rated	CR907	\$661.00
Up to 8'0" Steel Mullion - Panic Rated	CR908	\$671.00
Up to 10'0" (ED3200 only), Steel Mullion - Panic Rated	CR910	\$797.00
Up to 7'0", Steel Mullion - 3 Hour Fire Rated	CR907A	\$918.00
Up to 8'0", Steel Mullion - 3 Hour Fire Rated	CR908A	\$928.00

**Key Removable Mullion**

Description	Specify	Price
Up to 7'0", key removable mullion, 1-1/2 Hour Fire Rated	CR907BKM <sup>1</sup>	\$1,414.00
Up to 8'0", key removable mullion, 1-1/2 Hour Fire Rated	CR908BKM <sup>1</sup>	\$1,424.00
Up to 10'0" (ED3200 only), key removable mullion, Panic Rated	CR910KM <sup>1</sup>	\$1,250.00
Door frame filler block for double rabbetted frames	M95	Add \$42.00 per mullion
Door frame angle bracket for aluminum frames	M96	Add \$42.00 per mullion

Note 1: Cylinder and collars not included, specify separately

**Mullions Cylinder Options**

Description	Specify	Add or Deduct
Conventional 6-pin	6P	Add \$86.00 per cylinder
Conventional 7-pin	7P	Add \$88.00 per cylinder
IC 6-pin	C6	Add \$160.00 per cylinder
IC 7-pin	C7	Add \$164.00 per cylinder
Pyramid High Security Fixed Core	PHS	Add \$174.00 per cylinder
Pyramid Security Fixed Core	PS	Add \$144.00 per cylinder
Pyramid High Security IC	PCHS	Add \$244.00 per cylinder
Pyramid Security IC	PCS	Add \$215.00 per cylinder
Security	HS	Add \$197.00 per cylinder
Security IC	CHS	Add \$269.00 per cylinder
IC 6-pin less core	CL6	Add \$86.00 per cylinder
IC 7-pin less core	CL7	Add \$88.00 per cylinder

**Mortise Lock Only**

Lock Number	Description	Finish: 605, 606, 611, 612, 613, 613E, 625, 626
MLE012	Lockbody for Nightlatch/Dummy function	\$612.00
MLE013	Lockbody for Classroom function	
MLE014	Lockbody for Passage function	
MLE015	Lockbody for Passage Thumbpiece function	
MLE016	Lockbody for Classroom Thumbpiece function	

**Ordering Example**
**Mortise Lock Only**

Quantity	Lock Number	Finish	Hand
2	MLE013	630	LHR



The PathLite™ patent pending technology offers a number of benefits:

- Requires no wiring or maintenance
- Recharges with exposure to ambient light
- Unaffected by heat or cold
- Non-toxic, will not rub or fade
- Vandal resistant
- Fire resistant and non-radioactive
- Green contrasting word "EXIT" centered on touchbar in 1-1/4" high lettering
- Cost effective; especially suited for existing buildings

PathLite™ photoluminescent exit devices meet New York City's newly adopted standards for requirement of photoluminescent signage and stairwell markings in all office buildings in excess of 75 feet in height.

**How To Order Complete Device**

Exit Device	Trim/Function	Finish	Hand	Misc. Options
ED4200	A810	630	RHR	M49

ED4200 x A810 x 630 x RHR x M49

Options	Specify	Price
24" , 36" , and 48" PathLite™ Photoluminescent Touchbar Cover	M49	Add: \$348.00

**How to Order Touchbar Cover Only**

Options	Part Number	Price
24" PathLite™ Photoluminescent Touchbar cover	710F797	\$374.00
36" PathLite™ Photoluminescent Touchbar cover	710F737	
48" PathLite™ Photoluminescent Touchbar cover	710F747	

**Standard Features**

**Handing**

Devices are field reversible; specify hand. Lever trims are handed; specify hand

**Door Thickness**

1-3/4"

Product	Minimum Stile
ED4200S	2"
ED4200SM	3 1/2"
ED4200SMA	3 1/2"
ED4200	2"
ED4200M	3 1/2"
ED4200MA	3 1/2"
ED4400	2"
ED4400M	3 1/2"
ED4400MA	3 1/2"
ED4800	2"
ED4800M	3 1/2"
ED4800MA	3 1/2"

**Projection**

3-1/4"; 2-3/4" dogged

**Trim**

Cylinder is not included. See page 270 for cylinder options

**Door Width**

36"

**SecureBolt®**

- ED4200S      Panic
- ED4200SM    Panic
- ED4200SMA   3 Hour Fire Rated

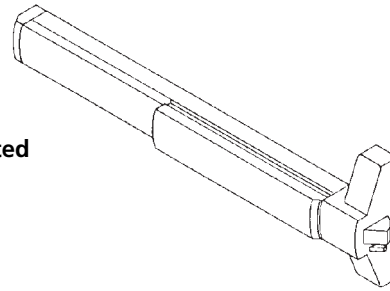

**Rim**

- ED4200      Panic
- ED4200M    Panic
- ED4200MA   3 Hour Fire Rated

**Surface Vertical Rod**

- ED4400      Panic
- ED4400M    Panic
- ED4400MA   3 Hour Fire Rated

**Concealed Vertical Rod**

- ED4800      Panic
- ED4800M    Panic
- ED4800MA   3 Hour Fire Rated

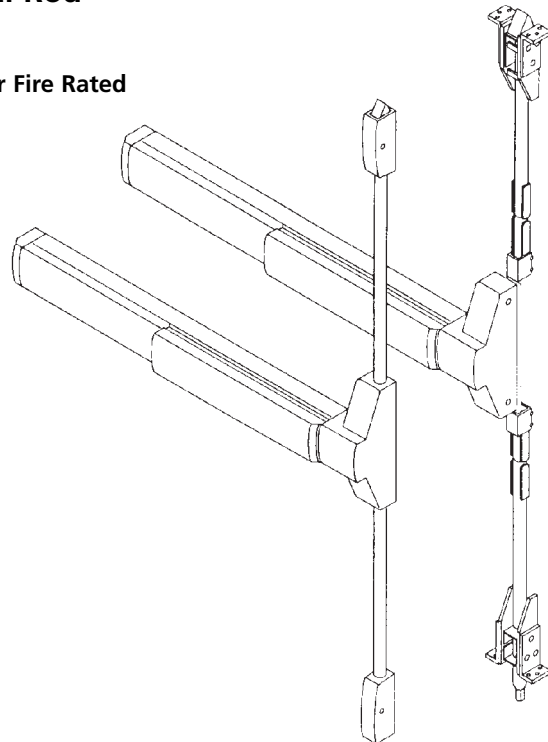

**Ordering Example**
**Exit Device Only**

Quantity	Exit Device	Finish	Hand	Misc. Options
20	ED4200	606	RHR	M51-M54

**Removable Mullions**

Quantity	Mullion	Finish	Misc. Options
12	CR808	695	M57

**Exit Device with Trim**

Quantity	Exit Device	Trim/Function	Finish	Hand	Door Thickness	Door Width	Door Height	Misc. Options
10	ED4400	N855ET	605	LHR	D200	W048	H0706	M51-M54

**Trim Only**

Quantity	Trim/Function	Finish	Hand	Door Thickness
24	N855ET	625	RHR	D214

**Contract/Detailed Order - Rim Exit Device with Trim**

Quantity	Keypad	Exit Device	Trim/Function	Finish	Hand	Door Height	Optional Strike	Door Width	Misc. Options	Optional Cylinder
36	AA1	ED4400	C855ET	626	LHR	H0800	S09	W048	M52-M54	7P

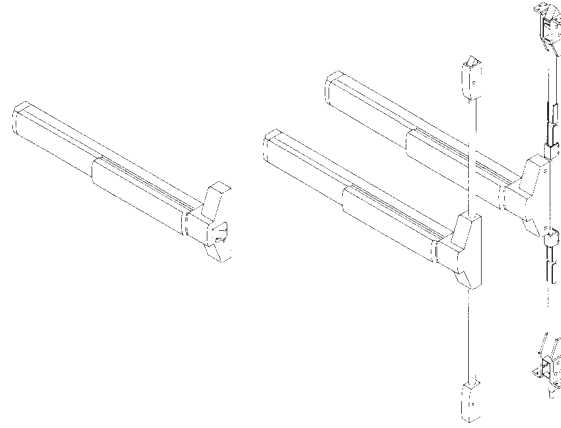

**36" Device Only, See Quick Code section for 24" and 48" door width options**

Includes device, strike(s) and screw pack. No cylinder or trim.

**SecureBolt® ED4200S Series**

Function	Description	Finish: 613E, 630, BSP	Finish: 605, 606, 611, 612, 613, 618, 619, 625, 629, 722
ED4200S	Panic	\$2,040.00	\$2,120.00
ED4200SM	Panic	\$2,040.00	\$2,120.00
ED4200SMA	3 Hour Fire Rated	\$2,210.00	\$2,290.00

**Rim ED4200 Series**

Function	Description	Finish: 613E, 630, BSP	Finish: 605, 606, 611, 612, 613, 618, 619, 625, 629, 722
ED4200	Panic	\$1,972.00	\$2,052.00
ED4200M	Panic	\$1,972.00	\$2,052.00
ED4200MA	3 Hour Fire Rated	\$2,142.00	\$2,222.00

**Vertical Rod ED4400 Series**

Function	Description	Finish: 613E, 630, BSP	Finish: 605, 606, 611, 612, 613, 618, 619, 625, 629, 722
ED4400	Panic	\$2,282.00	\$2,362.00
ED4400M	Panic	\$2,282.00	\$2,362.00
ED4400MA	3 Hour Fire Rated	\$2,452.00	\$2,532.00

**Concealed V.R. ED4800 Series**

Function	Description	Finish: 613E, 630, BSP	Finish: 605, 606, 611, 612, 613, 618, 619, 625, 629, 722
ED4800	Panic	\$2,543.00	\$2,623.00
ED4800M	Panic	\$2,543.00	\$2,623.00
ED4800MA	3 Hour Fire Rated	\$2,713.00	\$2,793.00

Caution: Be sure of your measurements. Exit devices are NOT returnable.



**ED4200S/ED4200/ED4400/ED4800 SecureBolt®, Rim, Surface and Concealed V.R. Trim**

Cylinder is not included.

**Escutcheon Trim Design: A8 Armstrong**



**Lever:** Cast

**Escutcheon:** Wrought



Function	Description	Finish: 613E, 630, BSP	Finish: 605, 606, 611, 612, 613, 618, 619, 625, 626, 629, 722
A810ET	Passage	\$614.00	\$640.00
A850ET	Dummy		
A855ET	Classroom <sup>1</sup>		
A859ET	Storeroom		

**Escutcheon Trim Design: C8 Citation**



**Lever:** Cast

**Escutcheon:** Wrought



Function	Description	Finish: 613E, 630, BSP	Finish: 605, 606, 611, 612, 613, 618, 619, 625, 626, 629, 722
C810ET	Passage	\$614.00	\$640.00
C850ET	Dummy		
C855ET	Classroom <sup>1</sup>		
C859ET	Storeroom		

**Escutcheon Trim Design: D8 Dirke**



**Lever:** Cast

**Escutcheon:** Wrought



Function	Description	Finish: 613E, 630, BSP	Finish: 605, 606, 611, 612, 613, 618, 619, 625, 626, 629, 722
D810ET	Passage	\$614.00	\$640.00
D850ET	Dummy		
D855ET	Classroom <sup>1</sup>		
D859ET	Storeroom		

Note:

1. Classroom function trim may be converted to storeroom function by a simple field adjustment. No additional parts required.

**ED4200S/ED4200/ED4400/ED4800 SecureBolt®, Rim, Surface and Concealed V.R. Trim**

Cylinder is not included.

**Escutcheon Trim Design: E8 Essex**



**Lever:** Cast

**Escutcheon:** Wrought



Function	Description	Finish: 613E, 630, BSP	Finish: 605, 606, 611, 612, 613, 618, 619, 625, 626, 629, 722
E810ET	Passage	\$614.00	\$640.00
E850ET	Dummy		
E855ET	Classroom <sup>1</sup>		
E859ET	Storeroom		

**Escutcheon Trim Design: L8 Lustra**



**Lever:** Cast

**Escutcheon:** Wrought



Function	Description	Finish: 613E, 630, BSP	Finish: 605, 606, 611, 612, 613, 618, 619, 625, 626, 629, 722
L810ET	Passage	\$614.00	\$640.00
L850ET	Dummy		
L855ET	Classroom <sup>1</sup>		
L859ET	Storeroom		

**Escutcheon Trim Design: N8 Newport**



**Lever:** Cast

**Escutcheon:** Wrought



Function	Description	Finish: 613E, 630, BSP	Finish: 605, 606, 611, 612, 613, 618, 619, 625, 626, 629, 722
N810ET	Passage	\$614.00	\$640.00
N850ET	Dummy		
N855ET	Classroom <sup>1</sup>		
N859ET	Storeroom		

**Escutcheon Trim Design: R8 Regis**



**Lever:** Cast

**Escutcheon:** Wrought



Function	Description	Finish: 613E, 630, BSP	Finish: 605, 606, 611, 612, 613, 618, 619, 625, 626, 629, 722
R810ET	Passage	\$614.00	\$640.00
R850ET	Dummy		
R855ET	Classroom <sup>1</sup>		
R859ET	Storeroom		

Note: 1. Classroom function trim may be converted to storeroom function by a simple field adjustment. No additional parts required.

**ED4200S/ED4200/ED4400/ED4800 SecureBolt®, Rim, Surface and Concealed V.R. Trim**

Cylinder is not included.

**Escutcheon Trim Design: PR8 Princeton**



**Lever:** Cast

**Escutcheon:** Wrought



Function	Description	Finish: 613E, 630, BSP	Finish: 605, 606, 611, 612, 613, 618, 619, 625, 626, 629, 722
PR810ET	Passage	\$614.00	\$640.00
PR850ET	Dummy		
PR855ET	Classroom <sup>1</sup>		
PR859ET	Storeroom		

**Escutcheon Trim Design: G8 Global**

**Knob:** Wrought

**Escutcheon:** Wrought



Function	Description	Finish: 613E, 630, BSP	Finish: 605, 606, 611, 612, 613, 618, 619, 625, 626, 629, 722
G810ET	Passage	\$567.00	\$593.00
G850ET	Dummy		
G855ET	Classroom <sup>1</sup>		
G859ET	Storeroom		

**Escutcheon Trim Design: F4 Plate**

**Plate:** Wrought



Function	Description	Finish: 613E, 630, BSP	Finish: 605, 606, 611, 612, 613, 618, 619, 625, 626, 629, 722
F450ET	Dummy	\$232.00	\$258.00
F457ET	Nightlatch		

**Escutcheon Trim Design: O8 Plate x Thumbturn**

**Plate:** Wrought

**Thumbturn:** Cast



Function	Description	Finish: 613E, 630, BSP	Finish: 605, 606, 612, 613, 722
O810	Passage	\$492.00	\$518.00
O855 <sup>1</sup>	Classroom		
O859	Storeroom		

Note:

1. Classroom function trim may be converted to storeroom function by a simple field adjustment. No additional parts required.

**ED4200S/ED4200/ED4400/ED4800 SecureBolt®, Rim, Surface and Concealed V.R. Trim**

Cylinder is not included.

**Escutcheon Trim Design: O14 Plate x Thumbturn**

**Pull:** Cast      **Escutcheon:** Wrought      **Thumbturn:** Cast



Function	Description	Finish: 613E, 630, BSP	Finish: 605, 606, 611, 612, 613, 618, 619, 625, 626, 629, 722
O1410ET	Passage	\$603.00	\$629.00
O1455ET <sup>1</sup>	Classroom		
O1459ET	Storeroom		

**Escutcheon Trim Design: T14 Pull/Thumbpiece**

**Grip:** Cast      **Escutcheon:** Wrought



Function	Description	Finish: 613E, 630, BSP	Finish: 605, 606, 611, 612, 613, 618, 619, 625, 626, 629, 722
T1410ET	Passage	\$582.00	\$608.00
T1450ET	Dummy	\$512.00	\$538.00
T1455ET <sup>1</sup>	Classroom	\$582.00	\$608.00
T1457ET	Nightlatch (see note 2)	\$512.00	\$538.00

**Escutcheon Trim Design: P10 Pull**



**Pull:** Extruded      **Escutcheon:** Wrought



Function	Description	Finish: 613E, 630, BSP	Finish: 605, 606, 611, 612, 613, 618, 619, 625, 626, 629, 722
P1050ET	Dummy	\$587.00	\$613.00
P1057ET	Nightlatch (see note 2)		

**Escutcheon Trim Design: K1 Key Only**

Note: Available with cylinder option only. Example: K157 x 6P



Function	Description	Finish: 605, 606, 611, 612, 613, 618, 619, 622, 625, 626, 722
K157ET	Nightlatch <sup>2</sup>	\$57.00

Notes:

- Classroom function trim may be converted to storeroom function by a simple field adjustment. No additional parts required.
- Not recommended for use on surface or concealed vertical rod exit devices.

**Offset Pull Trim: P12, P13, P14**

Offset Pull Trim	Part Number	Finishes: 613E, 630, BSP	Finishes: 605, 606, 612, 613, 626, 629
P12	716F50M X Finish	\$270.00	\$284.00
P13	716F51M X Finish	\$330.00	\$344.00
P14	716F52M X Finish	\$233.00	\$247.00

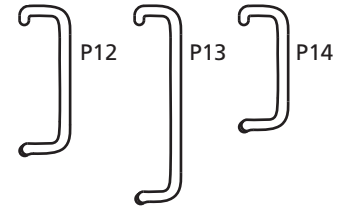
**Electrified Options for Exit Devices**

Description	Specify	Add or Deduct
Exit Alarm Device (cylinder is not included)	M61	\$709.00
Bolt Position Monitoring	M91*	Add \$217.00
Touchbar Monitoring or Signaling/Request to Exit (REX)	M92*	Add \$204.00
Outside Trim Monitoring or Signaling	M93*	
Motor Latch Retraction	MELR	\$835.00
Electric Dogging	M97	Add \$416.00

**Delayed Egress Device**

Description	Specify	Add or Deduct
Delayed Egress (Suffix the letter D to device. Ex: ED4200)	D	Add \$1533.00
30-Second Delay	M88*	\$107.00
BOCA 15-Second Delay	M89*	
BOCA 30-Second Delay	M90*	

**Electrified Accessories**

Part Number	Description	Specify	Price
709F609	Power Supply 1 Amp (controls 1 'D' device)	BPS-24-1	\$327.00
709F619	Power Supply 2 Amp (controls 2 'D' devices or 1 "D" with SAF or SEC)	BPS-24-2	\$664.00
709F269	Power Supply 4 amp 24VDC	BPS-24-4	\$1,122.00
704F288	Concealed transfer (for over 120-degree swing door)	EPTL	\$129.00
709F689	(1) SPDT Maintained Switch (Includes LED)	MKA	\$129.00
709F709	(1) SPDT Momentary Switch (Includes LED)	MK	\$197.00
709F749	(1) SPDT Momentary Switch (Illuminated)	PB2	\$151.00
709F759	(1) SPDT Maintained (Alternating Action) Switch	PB3EA	\$115.00
709F769	(1) SPDT Momentary Switch (Illuminated)	PB3	\$146.00
709F779	(1) SPDT Momentary Switch	PB3ER	\$97.00
709F729	DPDT Momentary Key Switch	MK2	\$226.00
709F699	Narrow Stile Key Switch (Alt. action)	MKAN	\$197.00
709F719	Narrow Stile Momentary Key Switch	MKN	\$197.00
709F789	Sonalert 90db @ 2 ft. 12-24VDC. Mounted on one gang stainless steel plate.	PZ1	\$97.00
	Alarm Kit (cylinder is not included) <sup>1</sup>	ED40AK	\$805.00
709F679	Door Cord	TSB-C	\$41.00
741F739	Digital Entry System (4 users)	DK-12	\$36.00
709F809	Digital Entry System (59 users) ST finish	FADK-26SS	\$693.00
709F819	Digital Entry System (59 users) Black finish	DK-26BK	\$693.00
709F669	Power Transfer	EPT	\$97.00

**Notes:**

- Alarm kit cannot be installed in the field to surface vertical rod exit device. Any attempt to do so voids all warranties.

**\*ElectroLynx®**

As part of their promise to provide innovative, fast and effective high security solutions to their customers, certain ASSA ABLOY Group brands offer *ElectroLynx®*, a universal quick-connect system that simplifies the electrification of the door opening.

**Cylinder Options\***

Description	Specify	Add or Deduct
Conventional 6-pin	6P**	Add \$86.00 per cylinder
Conventional 7-pin	7P	Add \$88.00 per cylinder
Access 3 Patented	AP	Add \$86.00 per cylinder
Access 3 Security	AS	Add \$135.00 per cylinder
Access 3 High Security, UL 437	AHS	Add \$155.00 per cylinder
Access 3 IC Patented	ACP	Add \$160.00 per cylinder
Access 3 IC Security	ACS	Add \$209.00 per cylinder
Access 3 IC High Security, UL 437	ACHS	Add \$223.00 per cylinder
Pyramid Security fixed core	PS	Add \$144.00 per cylinder
Pyramid Security IC	PCS	Add \$215.00 per cylinder
Pyramid High Security fixed core	PHS	Add \$174.00 per cylinder
Pyramid High Security IC	PCHS	Add \$244.00 per cylinder
Pyramid IC with temporary construction core	CTP	Add \$160.00 per cylinder
Pyramid IC with temporary disposable core	CTPD	Add \$86.00 per cylinder
Pyramid IC less core	CLP	Add \$86.00 per cylinder
Security	HS	Add \$197.00 per cylinder
Security IC	CHS	Add \$269.00 per cylinder
Blockout function	BO	Add \$179.00 per cylinder
IC 6-pin	C6	Add \$160.00 per cylinder
IC 6-pin with temporary construction core (Red)	CT6R	Add \$160.00 per cylinder
IC 6-pin with temporary construction core (Blue)	CT6B	Add \$160.00 per cylinder
IC 6-pin with temporary construction core (Green)	CT6G	Add \$160.00 per cylinder
IC 6-pin with temporary disposable core	CT6D	Add \$86.00 per cylinder
IC 6-pin less core	CL6	Add \$86.00 per cylinder
SFIC 6-pin with Less Core	CLS6	Add \$86.00 per cylinder
IC 6-pin with SFIC disposable temporary core	CT6SD	Add \$86.00 per cylinder
IC 7-pin	C7	Add \$164.00 per cylinder
IC 7-pin with temporary construction core ( Red)	CT7R	Add \$164.00 per cylinder
IC 7-pin with temporary construction core ( Blue)	CT7B	Add \$164.00 per cylinder
IC 7-pin with temporary construction core ( Green)	CT7G	Add \$164.00 per cylinder
IC 7-pin with temporary disposable core	CT7D	Add \$88.00 per cylinder
IC 7-pin less core	CL7	Add \$88.00 per cylinder
SFIC 7-pin with Less Core	CLS7	Add \$88.00 per cylinder
IC 7-pin with SFIC disposable temporary core	CT7SD	Add \$88.00 per cylinder

\*Optional dogging cylinder will be furnished with the same mechanism and keyed alike with the trim cylinder, unless otherwise specified. If different keying or cylinder type is required, specify outside (trim) first, then inside (dogging) cylinder.

\*\*6P cylinder option is supplied in 6-pin, L4 keyway, 0-bitted with two nickel silver keys.

**Keying Options\***

Description	Specify	Add or Deduct
0-Bitted with 2 blank keys	(standard)	No Charge
Keyed random	KR	No Charge
Master keyed (all cylinders except 8000, 8020, 8027 IC)	specify keyset	Add \$16.00 per cylinder
Master keyed Pyramid	specify keyset	Add \$16.00 per cylinder
Master keyed Security (including IC cylinder and core)	specify keyset	Add \$16.00 per cylinder
Master keyed (8000, 8020, 8027 IC core)	specify keyset	No Charge
Master keyed to customer bittings or sample key	specify keyset	Add \$16.00 per cylinder
Construction master keyed <sup>1,2</sup>	CMK	Add \$16.00 per cylinder
Visual key control (VKC)		
- No Stamping	VKC0	\$4.50
- Keys only	VKC1	No Charge
- Cylinders and Keys <sup>3</sup>	VKC2	\$8.00
- Cylinders only <sup>3</sup>	VKC3	\$8.00
Concealed key control (CKC)		
- CKC cylinders with VKC keys	CKC2	\$8.00
- CKC cylinders only <sup>3</sup>	CKC3	\$8.00
More than 2 keys per lock	KY# (e.g., KY6)	See page 66 - Cut Keys Section

\*For key bows other than 10 and 90, specify "KB" + bow number as Quick Code, e.g. KB12.

Notes:

1. CMK Construction master keying charge is in addition to master keying charge.
2. CMK Construction master keying is not available in Pyramid or Security series.
3. VKC2, VKC3, CKC3 are not available in Pyramid or Security series.

**Door Height Options**
**ED4400 Device**

Door Height	Specify	Add or Deduct
7'0"	(standard)	No Charge
7'2"	H0702	
7'6"	H0706	
8'0"	H0800	
9'0"	H0900	Add \$82.00 per device
10'0"	H1000	

**ED4800 Device**

Door Height	Specify	Add or Deduct
8'0"	(standard)	No Charge
8'2"	H0802	
8'6"	H0806	
9'0"	H0900	Add \$82.00 per device
10'0"	H1000	

**Door Width Options**

Door Width	Specify	Add or Deduct
24"	W024	Add \$292.00 per device
36"	(standard)	No Charge
48"	W048	Add \$35.00 per device

**Door Thickness Options**

Door Thickness	Specify	Add or Deduct
1-3/4"	(standard)	No Charge
2"	D200	
2-1/4"	D214	

**Strike Options**

Description	Specify	Add or Deduct
Surface or concealed vertical rod	S09	No Charge
Bottom strike for 1/2" threshold		
Flush transom top strike bracket	M67	Add \$30.00 per device

**Miscellaneous Options**

Description	Specify	Add or Deduct
Torx® screws for rim, concealed vertical rod, mortise	M04	Add \$44.00 per device
Torx® screws for surface vertical rod	M04	Add \$83.00 per device
Knurling outside and inside (Embossed Touchbar - device side)	M20	Add \$145.00 per device
Knurling outside only (trim side)	M21	Add \$68.00 per device
Knurling inside only (Embossed Touchbar - device side)	M22	Add \$77.00 per device
Abrasive coat outside and inside (trim and device)	M23	Add \$92.00 per device
Abrasive coat inside only (device side)	M24	Add \$48.00 per device
Abrasive coat outside only (trim side)	M25	Add \$44.00 per device
Pathlite™ Photoluminescent Touchbar cover	M49	Add \$348.00 per device
Less dogging	M51	No Charge
Cylinder dogging (less cylinder)	M52	Add \$78.00 per device
Sex nuts and bolts (SNBs)	M54	No Charge
Mullion stabilizer*	M57	Add \$62.00 per mullion
Shim kit (for vision light)		
- All rim and concealed vertical rod	M58	Add \$96.00 per device
- All surface vertical rod	M58	Add \$96.00 per device
End Cap Reinforcement (used with standard end cap only)	M109	Add \$78.00 per device
Flush End Cap	M110	No Charge

**Removable Mullion**
**Ordering Example**

Quantity	Mullion Number	Finish
10	CR808	628

Door Height	Specify	Finish	Price
Up to 8'0"	CR808	628	\$1,432.00
Up to 8'0"	CR808	695	\$1,644.00

\*Standard with all 808 mullions.

**Custom Laser Engraving- LASER**
**Laser engraving processing charge (all engraving types)**

- \$250 net per order. Charge will be applied to production order when placed.

**Single Vanity, Logo or Other (same engraving on all parts)**

- Lever - \$10 net add each
- Mortise Escutcheon - \$10 net add each
- HPSK Paddle - \$10 net add each

**Unique laser engraving (i.e. Room Number, Apartment Number, etc)**

- \$12 net add each (per piece)





The PathLite™ patent pending technology offers a number of benefits:

- Requires no wiring or maintenance
- Recharges with exposure to ambient light
- Unaffected by heat or cold
- Non-toxic, will not rub off or fade
- Vandal resistant
- Fire resistant and non-radioactive
- Green contrasting word "EXIT" centered on touchbar in 1-1/4" high lettering
- Cost effective; especially suited for existing buildings

PathLite™ photoluminescent exit devices meet New York City's newly adopted standards for requirement of photoluminescent signage and stairwell markings in all office buildings in excess of 75 feet in height.

**How To Order Complete Device**

Exit Device	Trim/Function	Finish	Hand	Misc. Options
ED5200	N910ET	630	RHR	M49

ED5200 x N910 x 630 x RHR x M49

Options	Specify	Price
24", 36", and 48" PathLite™ Photoluminescent Touchbar Cover	M49	Add \$348.00 per device

**How to Order Touchbar Cover Only**

Options	Part Number	Price
24" PathLite™ Photoluminescent Touchbar cover	710F797	\$374.00
36" PathLite™ Photoluminescent Touchbar cover	710F737	
48" PathLite™ Photoluminescent Touchbar cover	710F747	

**Standard Features**

**Handing**

Devices are field reversible; specify hand. Lever trims are handed; specify hand.

Note:  
Specify hand for all double cylinder exit devices

**Door Thickness**

1-3/4"

**Door Width**

36"

**Projection**

3-1/4"; 2-3/4" dogged

**Trim**

Cylinder is not included.  
See page 292 for cylinder options.

**SecureBolt®**

- ED5200S Panic
- ED5200SA 3 Hour Fire Rated
- ED5202S Double Cylinder Panic, SecureBolt®
- ED5202SA Double Cylinder, Secure Bolt, 3 Hour Fire Rated

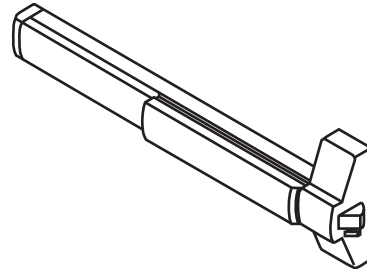

**RIM**

- ED5200 Panic
- ED5200A 3 Hour Fire Rated
- ED5202 Double Cylinder Panic
- ED5202A Double Cylinder; 3 Hour fire rated

**Vertical Rod**

- ED5400 Panic
- ED5470 Panic
- ED5400A 3 Hour Fire Rated
- ED5470B 1-1/2 Hour Fire Rated

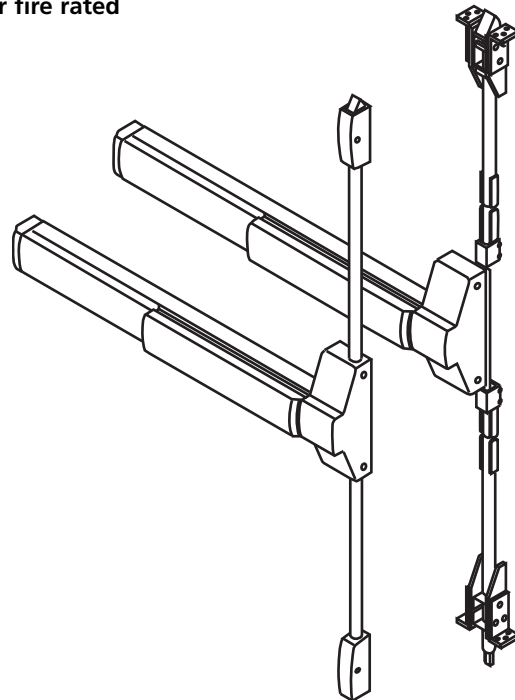

**Concealed Vertical Rod**

- ED5800 Panic
- ED5860 Panic
- ED5800A 3 Hour Fire Rated
- ED5860B 1-1/2 Hour Fire Rated

**Mortise**

- ED5600 Panic
- ED5600A 3 Hour Fire Rated
- ED5602L Double Cylinder Panic (Classroom Function)
- ED5602AL Double Cylinder (Classroom Function); 3 Hour Fire Rated

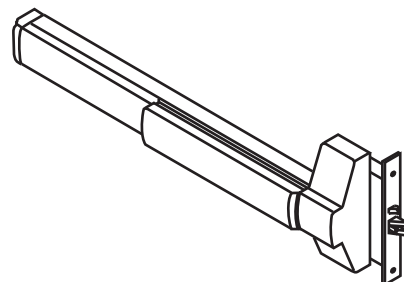

**Ordering Examples**
**Exit Device with Trim**

Quantity	Exit Device	Trim/Function	Finish	Hand	Door Thickness	Optional Strike	Door Width	Misc. Options
36	ED5600L	N9M55ET	605	LHR	D200	SB134	W048	M51-M54

**Trim Only**

Quantity	Trim/Function	Finish	Hand	Door Thickness
24	N955ET	625	RHR	D214

**Contract/Detailed Order - Rim Exit Device with Trim**

Quantity	Keypad	Exit Device	Trim/Function	Finish	Hand	Door Thickness	Door Width	Misc. Options	Optional Cylinder
36	AA1	ED5200	C955ET	613E	LHR	D200	W048	M52-M54	6P

**Notes:**

M55 less bottom rod option is available on ED5470(B) and ED5860(B) devices only.  
H0900 and H1000 options are available on ED5470(B) and ED5860(B) devices only.  
Non fire rated devices do not have a door size limitation set by UL.

**36" Device Only**

Includes device, strike(s) and screw pack. No cylinder or trim.

**SecureBolt® ED5200S Series**

Function	Description	Finish: 613E, 630, BSP	Finish: 605, 606, 611, 612, 613, 618, 619, 625, 629, 722
ED5200S	Panic	\$1,590.00	\$1,686.00
ED5202S <sup>1</sup>	Double Cylinder Panic <i>Classroom function Trim only</i>	\$1,812.00	\$1,908.00
ED5200SA	3 Hour Fire Rated	\$1,760.00	\$1,856.00
ED5202SA <sup>1</sup>	Double Cylinder 3 Hour Fire Rated <i>Classroom function Trim only</i>	\$1,982.00	\$2,078.00

**Rim ED5200 Series**

Function	Description	Finish: 613E, 630, BSP	Finish: 605, 606, 611, 612, 613, 618, 619, 625, 629, 722
ED5200	Panic	\$1,522.00	\$1,618.00
ED5202 <sup>1</sup>	Double Cylinder Panic <i>Classroom function Trim only</i>	\$1,744.00	\$1,840.00
ED5200A	3 Hour Fire Rated	\$1,692.00	\$1,788.00
ED5202A <sup>1</sup>	Double Cylinder 3 Hour Fire Rated <i>Classroom function Trim only</i>	\$1,914.00	\$2,010.00

**Vertical Rod ED5400 Series**

Function	Description	Finish: 613E, 630, BSP	Finish: 605, 606, 611, 612, 613, 618, 619, 625, 629, 722
ED5400	Panic	\$2,068.00	\$2,164.00
ED5470	Panic	\$2,134.00	\$2,230.00
ED5400A	3 Hour Fire Rated	\$2,238.00	\$2,334.00
ED5470B	1-1/2 Hour Fire Rated	\$2,304.00	\$2,400.00

**Mortise ED5600 Series**

Function	Description	Finish: 613E, 630, BSP	Finish: 605, 606, 611, 612, 613, 618, 619, 625, 629, 722
ED5600K	Panic	\$2,036.00	\$2,132.00
ED5657K			
ED5600L			
ED5657L			
ED5600T			
ED5657T			
ED5602L <sup>1</sup>	Double Cylinder Panic <i>Classroom function Trim only</i>	\$2,258.00	\$2,354.00
ED5600AK	3 Hour Fire Rated	\$2,206.00	\$2,302.00
ED5657AK			
ED5600AL			
ED5657AL			
ED5600AT			
ED5657AT			
ED5602AL <sup>1</sup>	Double Cylinder 3 Hour Fire Rated <i>Classroom function Trim only</i>	\$2,428.00	\$2,524.00
ED5633L	Access 800® Only - Panic – Without Cylinder	\$2,036.00	\$2,132.00
ED5634L	Access 800® Only - Panic – With Cylinder	\$2,036.00	\$2,132.00
ED5633AL	Access 800® Only - 3 Hour Fire Rated – Without Cylinder	\$2,206.00	\$2,302.00
ED5634AL	Access 800® Only - 3 Hour Fire Rated – With Cylinder	\$2,206.00	\$2,302.00

**Concealed V.R. ED5800 Series**

Function	Description	Finish: 613E, 630, BSP	Finish: 605, 606, 611, 612, 613, 619, 625, 629, 722
ED5800	Panic	\$2,325.00	\$2,421.00
ED5860	Panic	\$2,457.00	\$2,553.00
ED5800A	3 Hour Fire Rated	\$2,495.00	\$2,591.00
ED5860B	1-1/2 Hour Fire Rated	\$2,627.00	\$2,723.00

**Inactive Bar ED5000DB Series**

Function	Description	Finish: 613E, 630, BSP	Finish: 605, 606, 611, 612, 613, 619, 625, 629, 722
ED5000DB	Inactive Bar	\$750.00	\$846.00

1. Specify handing for double cylinder devices  
 Only classroom function trim can be used with double cylinder devices.  
 Caution: Be sure of your measurements. Exit devices are NOT returnable.

**ED5200S/ED5200/ED5400/ED5800 SecureBolt®, Rim, Surface and CVR Heavy-Duty Trim**

Cylinder is not included.

**Escutcheon Trim Design: A9 Armstrong**



**Lever:** Cast

**Escutcheon:** Forged



Function	Description	Finish: 613E, 630 <sup>1</sup> , BSP	Finish: 605, 606, 611, 612, 613, 618, 619, 625, 626, 629 <sup>2</sup> , 722
A910ET	Passage	\$658.00	\$684.00
A950ET	Dummy		
A955ET	Classroom <sup>3,4</sup>		
A957ET	Nightlatch <sup>5</sup>		
A959ET	Storeroom		

**Escutcheon Trim Design: C9 Citation**



**Lever:** Cast

**Escutcheon:** Forged



Function	Description	Finish: 613E, 630 <sup>1</sup> , BSP	Finish: 605, 606, 611, 612, 613, 618, 619, 625, 626, 629 <sup>2</sup> , 722
C910ET	Passage	\$658.00	\$684.00
C950ET	Dummy		
C955ET	Classroom <sup>3,4</sup>		
C957ET	Nightlatch <sup>5</sup>		
C959ET	Storeroom		

**Escutcheon Trim Design: D9 Dirke**



**Lever:** Cast

**Escutcheon:** Forged



Function	Description	Finish: 613E, 630 <sup>1</sup> , BSP	Finish: 605, 606, 611, 612, 613, 618, 619, 625, 626, 629 <sup>2</sup> , 722
D910ET	Passage	\$658.00	\$684.00
D950ET	Dummy		
D955ET	Classroom <sup>3,4</sup>		
D957ET	Nightlatch <sup>5</sup>		
D959ET	Storeroom		

Notes:

1. 619 finish provided to match 630 finish
2. 618 finish provided to match 629 finish.
3. Classroom function trim may be converted to storeroom function by a simple field adjustment. No additional parts required.
4. Only Classroom function may be used with Double Cylinder exit devices.
5. Not recommended for use with surface or concealed vertical rod exit devices (ED5400, ED5800)

**ED5200S/ED5200/ED5400/ED5800 SecureBolt®, Rim, Surface and CVR Heavy-Duty Trim**

Cylinder is not included.

**Escutcheon Trim Design: E9 Essex**



**Lever:** Cast      **Escutcheon:** Forged



Function	Description	Finish: 613E, 630 <sup>1</sup> , BSP	Finish: 605, 606, 611, 612, 613, 618, 619, 625, 626, 629 <sup>2</sup> , 722
E910ET	Passage	\$658.00	\$684.00
E950ET	Dummy		
E955ET	Classroom <sup>3,4</sup>		
E957ET	Nightlatch <sup>5</sup>		
E959ET	Storeroom		

**Escutcheon Trim Design: L9 Lustra**



**Lever:** Cast      **Escutcheon:** Forged



Function	Description	Finish: 613E, 630 <sup>1</sup> , BSP	Finish: 605, 606, 611, 612, 613, 618, 619, 625, 626, 629 <sup>2</sup> , 722
L910ET	Passage	\$658.00	\$684.00
L950ET	Dummy		
L955ET	Classroom <sup>3,4</sup>		
L957ET	Nightlatch <sup>5</sup>		
L959ET	Storeroom		

**Escutcheon Trim Design: N9 Newport**



**Lever:** Cast      **Escutcheon:** Forged



Function	Description	Finish: 613E, 630 <sup>1</sup> , BSP	Finish: 605, 606, 611, 612, 613, 618, 619, 625, 626, 629 <sup>2</sup> , 722
N910ET	Passage	\$658.00	\$684.00
N950ET	Dummy		
N955ET	Classroom <sup>3,4</sup>		
N957ET	Nightlatch <sup>5</sup>		
N959ET	Storeroom		

**Escutcheon Trim Design: R9 Regis**



**Lever:** Cast      **Escutcheon:** Forged



Function	Description	Finish: 613E, 630 <sup>1</sup> , BSP	Finish: 605, 606, 611, 612, 613, 618, 619, 625, 626, 629 <sup>2</sup> , 722
R910ET	Passage	\$658.00	\$684.00
R950ET	Dummy		
R955ET	Classroom <sup>3,4</sup>		
R957ET	Nightlatch <sup>5</sup>		
R959ET	Storeroom		

Notes:  
 1. 619 finish provided to match 630 finish. - Escutcheons only  
 2. 618 finish provided to match 629 finish. - Escutcheons only  
 3. Classroom function trim may be converted to storeroom function by a simple field adjustment. No additional parts required.  
 4. Only Classroom function trim may be used with Double Cylinder exit devices.  
 5. Not recommended for use with surface or concealed vertical rod exit devices (ED5400, ED5800)

**ED5200S/ED5200/ED5400/ED5800 SecureBolt®, Rim, Surface and CVR Heavy-Duty Trim**

Cylinder is not included.

**Escutcheon Trim Design: PR9 Princeton**



**Lever:** Cast

**Escutcheon:** Forged



Function	Description	Finish: 613E, 630 <sup>1</sup> , BSP	Finish: 605, 606, 611, 612, 613, 618, 619, 625, 626, 629 <sup>2</sup> , 722
PR910ET	Passage	\$658.00	\$684.00
PR950ET	Dummy		
PR955ET	Classroom <sup>3,4</sup>		
PR957ET	Nightlatch <sup>5</sup>		
PR959ET	Storeroom		

**Escutcheon Trim Design: F9**

**Lever:** Cast

**Escutcheon:** Forged



Function	Description	Finish: 613E, 630 <sup>1</sup> , BSP	Finish: 605, 606, 611, 612, 613, 618, 619, 625, 626, 629 <sup>2</sup> , 722
F950ET	Dummy	\$282.00	\$308.00
F957ET	Nightlatch <sup>5</sup>		

**Escutcheon Trim Design: G9**

**Lever:** Cast

**Escutcheon:** Forged



Function	Description	Finish: 613E, 630 <sup>1</sup> , BSP	Finish: 605, 606, 611, 612, 613, 618, 619, 625, 626, 629 <sup>2</sup> , 722
G910ET	Passage	\$658.00	\$684.00
G950ET	Dummy		
G955ET	Classroom <sup>3,4</sup>		
G957ET	Nightlatch <sup>5</sup>		
G959ET	Storeroom		

**Escutcheon Trim Design: VT9**

**Plate:** Stamped or Formed Stainless Steel



Function	Description	Finish: 630 <sup>1</sup>
VT957ET	Nightlatch <sup>6</sup>	\$593.00
VTL957ET	Nightlatch with Lip <sup>6</sup>	
VT950ET	Pull	
VTL950ET	Pull with Lip	

Notes:

1. 619 finish provided to match 630 finish. - Escutcheons only
2. 618 finish provided to match 629 finish. - Escutcheons only
3. Classroom function trim may be converted to storeroom function by a simple field adjustment. No additional parts required.

4. Only Classroom function trim may be used with Double Cylinder exit devices.
5. Not recommended for use with surface or concealed vertical rod exit devices (ED5400, ED5800)
6. VT957 and VTL957 trims are handed and not reversible

**ED5200S/ED5200/ED5400/ED5800 SecureBolt®, Rim, Surface and CVR Heavy-Duty Trim**

Cylinder is not included.

**Escutcheon Trim Design: FR9 Frascati\***



**Escutcheon:** Forged

\* Handed Lever. Handing cannot be changed in the field.



Function	Description	Finish: 613E, 626, BSP	Finish: 605, 606, 611, 612, 613, 618, 619, 625, 722
FR910ET	Passage	\$658.00	\$684.00
FR950ET	Dummy		
FR955ET	Classroom <sup>3,4</sup>		
FR957ET	Nightlatch <sup>5</sup>		
FR959ET	Storeroom		

**Escutcheon Trim Design: M9 Merlot**



**Escutcheon:** Forged

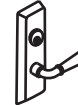

Function	Description	Finish: 613E, 626, BSP	Finish: 605, 606, 611, 612, 613, 618, 619, 625, 722
M910ET	Passage	\$658.00	\$684.00
M950ET	Dummy		
M955ET	Classroom <sup>3,4</sup>		
M957ET	Nightlatch <sup>5</sup>		
M959ET	Storeroom		

**Escutcheon Trim Design: Z9 Zinfandel\***



**Escutcheon:** Forged

\* Handed Lever. Handing cannot be changed in the field.



Function	Description	Finish: 613E, 626, BSP	Finish: 605, 606, 611, 612, 613, 618, 619, 625, 722
Z910ET	Passage	\$658.00	\$684.00
Z950ET	Dummy		
Z955ET	Classroom <sup>3,4</sup>		
Z957ET	Nightlatch <sup>5</sup>		
Z959ET	Storeroom		

Notes:

3. Classroom function trim may be converted to storeroom function by a simple field adjustment. No additional parts required.

4. Only Classroom function trim may be used with Double Cylinder exit devices.  
5. Not recommended for use with surface or concealed vertical rod exit devices.



**ED5200S/ED5200/ED5400/ED5800 SecureBolt®, Rim, Surface and CVR Trim**

Cylinder is not included.

**Escutcheon Trim Design: TH900 Pull/Thumbpiece**

**Grip:** Extruded

**Escutcheon:** Forged



Function	Description	Finish: 613E, 630 <sup>1</sup> , BSP	Finish: 605, 606, 611, 612, 613, 618, 619, 625, 626, 629 <sup>2</sup> , 722
TH910ET	Passage	\$475.00	\$501.00
TH950ET	Dummy (No thumbpiece)	\$445.00	\$471.00
TH955ET	Classroom <sup>3,4</sup>	\$475.00	\$501.00
TH957ET	Nightlatch <sup>5</sup> (No thumbpiece)	\$445.00	\$471.00
TH959ET	Storeroom	\$445.00	\$471.00

**Escutcheon Trim Design: P9 Pull**



**Pull:** Extruded

**Escutcheon:** Forged



Function	Description	Finish: 613E, 630 <sup>1</sup> , BSP	Finish: 605, 606, 611, 612, 613, 618, 619, 625, 626, 629 <sup>2</sup> , 722
P950ET*	Dummy	\$408.00	\$434.00
P957ET*	Nightlatch <sup>5</sup>		

\* Specify Hand. Field Reversible.

**Escutcheon Trim Design: K1 Key Only**

**Note:** Only available with cylinder option. Example K157 x 6P



Function	Description	Finish: 605, 606, 611, 612, 613, 618, 619, 622, 625, 626, 722
K157ET	Nightlatch <sup>5</sup>	\$57.00

Note:

1. 619 finish provided to match 630 finish. - Escutcheons only
2. 618 finish provided to match 629 finish. - Escutcheons only
3. Classroom function trim may be converted to storeroom function by a simple field adjustment. No additional parts required.
4. Only Classroom function trim may be used with Double Cylinder exit devices.
5. Not recommended for use on surface or concealed vertical rod exit devices.

**ED5600 Mortise Heavy-Duty Trim**

Cylinder is not included.

**Escutcheon Trim Design: A4M Armstrong**



**Lever:** Cast

**Escutcheon:** Forged



Function	Description	Finish: 613E, 630 <sup>1</sup> , BSP	Finish: 605, 606, 611, 612, 613, 618, 619, 625, 626, 629 <sup>2</sup> , 722
A9M10ET	Passage <sup>3</sup>	\$658.00	\$684.00
A9M50ET	Dummy <sup>3</sup>		
A9M55ET	Classroom <sup>4, 5</sup>		
A9M57ET	Nightlatch <sup>4</sup>		

**Escutcheon Trim Design: C9M Citation**



**Lever:** Cast

**Escutcheon:** Forged



Function	Description	Finish: 613E, 630 <sup>1</sup> , BSP	Finish: 605, 606, 611, 612, 613, 618, 619, 625, 626, 629 <sup>2</sup> , 722
C9M10ET	Passage <sup>3</sup>	\$658.00	\$684.00
C9M50ET	Dummy <sup>3</sup>		
C9M55ET	Classroom <sup>4, 5</sup>		
C9M57ET	Nightlatch <sup>4</sup>		

**Escutcheon Trim Design: D9M Dirke\***



**Lever:** Cast

**Escutcheon:** Forged

\* Handed Lever. Handing cannot be changed in the field.

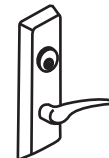

Function	Description	Finish: 613E, 630 <sup>1</sup> , BSP	Finish: 605, 606, 611, 612, 613, 618, 619, 625, 626, 629 <sup>2</sup> , 722
D9M10ET	Passage <sup>3</sup>	\$658.00	\$684.00
D9M50ET	Dummy <sup>3</sup>		
D9M55ET	Classroom <sup>4, 5</sup>		
D9M57ET	Nightlatch <sup>4</sup>		

- Notes:
1. 619 finish provided to match 630 finish. - Escutcheons only
  2. 618 finish provided to match 629 finish. - Escutcheons only
  3. Dummy and passage functions are the same. For dummy function, mortise lock body must be installed in the locked mode. No additional parts required.
  4. Classroom and nightlatch function trims are the same. Trim function must be specified when ordered with an exit device to ensure that the correct lock body is supplied.
  5. Only Classroom function trim may be used with Double Cylinder exit devices.

**ED5600 Mortise Heavy-Duty Trim**

Cylinder is not included.

**Escutcheon Trim Design: E9M Essex**



**Lever:** Cast

**Escutcheon:** Forged



Function	Description	Finish: 613E, 630 <sup>1</sup> , BSP	Finish: 605, 606, 611, 612, 613, 618, 619, 625, 626, 629 <sup>2</sup> , 722
E9M10ET	Passage <sup>3</sup>	\$658.00	\$684.00
E9M50ET	Dummy <sup>3</sup>		
E9M55ET	Classroom <sup>4, 5</sup>		
E9M57ET	Nightlatch <sup>4</sup>		

**Escutcheon Trim Design: L9M Lustra**



**Lever:** Cast

**Escutcheon:** Forged



Function	Description	Finish: 613E, 630 <sup>1</sup> , BSP	Finish: 605, 606, 611, 612, 613, 618, 619, 625, 626, 629 <sup>2</sup> , 722
L9M10ET	Passage <sup>3</sup>	\$658.00	\$684.00
L9M50ET	Dummy <sup>3</sup>		
L9M55ET	Classroom <sup>4, 5</sup>		
L9M57ET	Nightlatch <sup>4</sup>		

**Escutcheon Trim Design: N9M Newport**



**Lever:** Cast

**Escutcheon:** Forged



Function	Description	Finish: 613E, 630 <sup>1</sup> , BSP	Finish: 605, 606, 611, 612, 613, 618, 619, 625, 626, 629 <sup>2</sup> , 722
N9M10ET	Passage <sup>3</sup>	\$658.00	\$684.00
N9M50ET	Dummy <sup>3</sup>		
N9M55ET	Classroom <sup>4, 5</sup>		
N9M57ET	Nightlatch <sup>4</sup>		

Notes:

1. 619 finish provided to match 630 finish. - Escutcheons only
2. 618 finish provided to match 629 finish. - Escutcheons only
3. Dummy and passage functions are the same. For dummy function, mortise lock body must be installed in the locked mode. No additional parts required.
4. Classroom and nightlatch function trims are the same. Trim function must be specified when ordered with an exit device to ensure that the correct lock body is supplied.
5. Only Classroom function trim may be used with Double Cylinder exit devices.

**ED5600 Mortise Heavy-Duty Trim**

Cylinder is not included.

**Escutcheon Trim Design: R9M Regis**



**Lever:** Cast

**Escutcheon:** Forged



Function	Description	Finish: 613E, 630 <sup>1</sup> , BSP	Finish: 605, 606, 611, 612, 613, 618, 619, 625, 626, 629 <sup>2</sup> , 722
R9M10ET	Passage <sup>3</sup>	\$658.00	\$684.00
R9M50ET	Dummy <sup>3</sup>		
R9M55ET	Classroom <sup>4,5</sup>		
R9M57ET	Nightlatch <sup>4</sup>		

**Escutcheon Trim Design: PR9M Princeton**



**Lever:** Cast

**Escutcheon:** Forged



Function	Description	Finish: 613E, 630 <sup>1</sup> , BSP	Finish: 605, 606, 611, 612, 613, 618, 619, 625, 626, 629 <sup>2</sup> , 722
PR9M10ET	Passage <sup>3</sup>	\$658.00	\$684.00
PR9M50ET	Dummy <sup>3</sup>		
PR9M55ET	Classroom <sup>4,5</sup>		
PR9M57ET	Nightlatch <sup>4</sup>		

**Escutcheon Trim Design: F9**

**Escutcheon:** Forged



Function	Description	Finish: 613E, 630 <sup>1</sup> , BSP	Finish: 605, 606, 611, 612, 613, 618, 619, 625, 626, 629 <sup>2</sup> , 722
F950ET	Dummy	\$282.00	\$308.00
F9M57ET	Nightlatch <sup>4</sup>		

**Escutcheon Trim Design: G9M**

**Escutcheon:** Forged



Function	Description	Finish: 613E, 630 <sup>1</sup> , BSP	Finish: 605, 606, 611, 612, 613, 618, 619, 625, 626, 629 <sup>2</sup> , 722
G9M10ET	Passage <sup>3</sup>	\$658.00	\$684.00
G9M50ET	Dummy <sup>3</sup>		
G9M55ET	Classroom <sup>4,5</sup>		
G9M57ET	Nightlatch <sup>4</sup>		

Notes:

1. 619 finish provided to match 630 finish. - Escutcheons only
2. 618 finish provided to match 629 finish. - Escutcheons only
3. Dummy and passage functions are the same. For dummy function, mortise lock body must be installed in the locked mode. No additional parts required.
4. Classroom and nightlatch function trims are the same. Trim function must be specified when ordered with an exit device to ensure that the correct lock body is supplied.
5. Only Classroom function trim may be used with Double Cylinder exit devices.

**ED5600 Mortise Heavy-Duty Trim**

Cylinder is not included.

**Escutcheon Trim Design: FR9M Frascati\***



**Lever:** Cast

**Escutcheon:** Forged



\* Handed Lever. Handing cannot be changed in the field.



Function	Description	Finish: 613E, 626, BSP	Finish: 605, 606, 611, 612, 613, 618, 619, 625, 722
FR9M10ET	Passage <sup>1</sup>	\$658.00	\$684.00
FR9M50ET	Dummy <sup>1</sup>		
FR9M55ET	Classroom <sup>2, 3</sup>		
FR9M57ET	Nightlatch <sup>2</sup>		

**Escutcheon Trim Design: M9M Merlot**



**Lever:** Cast

**Escutcheon:** Forged

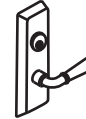

Function	Description	Finish: 613E, 626, BSP	Finish: 605, 606, 611, 612, 613, 618, 619, 625, 722
M9M10ET	Passage <sup>1</sup>	\$658.00	\$684.00
M9M50ET	Dummy <sup>1</sup>		
M9M55ET	Classroom <sup>2, 3</sup>		
M9M57ET	Nightlatch <sup>2</sup>		

**Escutcheon Trim Design: Z9M Zinfandel\***



**Lever:** Cast

**Escutcheon:** Forged



\* Handed Lever. Handing cannot be changed in the field.



Function	Description	Finish: 613E, 626, BSP	Finish: 605, 606, 611, 612, 613, 618, 619, 625, 722
Z9M10ET	Passage <sup>1</sup>	\$658.00	\$684.00
Z9M50ET	Dummy <sup>1</sup>		
Z9M55ET	Classroom <sup>2, 3</sup>		
Z9M57ET	Nightlatch <sup>2</sup>		

Notes:

- Dummy and passage functions are the same. For dummy function, mortise lock body must be installed in the locked mode. No additional parts required.
- Classroom and nightlatch function trims are the same. Trim function must be specified when ordered with an exit device to ensure that the correct lock body is supplied.
- Only Classroom function trim may be used with Double Cylinder exit devices.

**Mortise Trim Design: ED5600**

Cylinder is not included.

**Escutcheon Trim Design: TH900, TH9M00 Pull/Thumbpiece**

**Grip:** Extruded      **Escutcheon:** Forged



Function	Description	Finish: 613E, 630 <sup>1</sup> , BSP	Finish: 605, 606, 611, 612, 613, 618, 619, 625, 626, 629 <sup>2</sup> , 722
TH9M10ET	Passage	\$475.00	\$501.00
TH950ET	Dummy (No Thumbpiece)	\$445.00	\$471.00
TH9M55ET	Classroom <sup>3</sup>	\$475.00	\$501.00
TH9M57ET	Nightlatch (No Thumbpiece)	\$445.00	\$471.00

**Escutcheon Trim Design: P9M Pull**



**Pull:** Extruded      **Escutcheon:** Forged



Function	Description	Finish: 613E, 630 <sup>1</sup> , BSP	Finish: 605, 606, 611, 612, 613, 618, 619, 625, 626, 629 <sup>2</sup> , 722
P950ET*	Dummy	\$408.00	\$434.00
P9M57ET*	Nightlatch		

\*Specify Hand. Field Reversible.

**Escutcheon Trim Design: VT9M**

**Plate:** Stamped or Formed Stainless Steel



Function	Description	Finish: 630
VT9M57ET	Nightlatch	\$593.00
VTL9M57ET	Nightlatch with Lip	

Note: For mortise exit dummy functions, specify VT950 and VTL950

**Escutcheon Trim Design: K1M Key Only**

Note: Available with cylinder option only. Example: K1M57 x 6P



Function	Description	Finish: 605, 606, 611, 612, 613, 618, 619, 622, 625, 626, 722
K1M57ET	Nightlatch	\$57.00

Note:  
 1. 619 finish provided to match 630 finish. - Escutcheons only  
 2. 618 finish provided to match 629 finish. - Escutcheons only  
 3. Only Classroom function trim may be used with Double Cylinder exit devices.

**ED5200S/ED5200/ED5400/ED5800 SecureBolt®, Rim, Surface & CVR Heavy-Duty Trim**

Cylinder is not included.

**Escutcheon Trim Design: A9 Armstrong**



**Lever:** Cast    **Escutcheon:** Forged



Function	Description	Finish: 613E, 630', BSP	Finish: 605, 606, 611, 612, 613, 618, 619, 625, 626, 629 <sup>2</sup> , 722
A9903ET*	Fail Safe	\$1,046.00	\$1,072.00
A9905ET*	Fail Secure		

**Escutcheon Trim Design: C9 Citation**



**Lever:** Cast    **Escutcheon:** Forged



Function	Description	Finish: 613E, 630', BSP	Finish: 605, 606, 611, 612, 613, 618, 619, 625, 626, 629 <sup>2</sup> , 722
C9903ET*	Fail Safe	\$1,046.00	\$1,072.00
C9905ET*	Fail Secure		

**Escutcheon Trim Design: D9 Dirke\***



**Lever:** Cast    **Escutcheon:** Forged  
\* Handed Lever. Handing cannot be changed in the field.

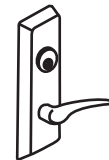

Function	Description	Finish: 613E, 630', BSP	Finish: 605, 606, 611, 612, 613, 618, 619, 625, 626, 629 <sup>2</sup> , 722
D9903ET*	Fail Safe	\$1,046.00	\$1,072.00
D9905ET*	Fail Secure		

**Escutcheon Trim Design: E9 Essex**



**Lever:** Cast    **Escutcheon:** Forged



Function	Description	Finish: 613E, 630', BSP	Finish: 605, 606, 611, 612, 613, 618, 619, 625, 626, 629 <sup>2</sup> , 722
E9903ET*	Fail Safe	\$1,046.00	\$1,072.00
E9905ET*	Fail Secure		

Notes:  
1. 619 finish provided to match 630 finish. - Escutcheons only  
2. 618 finish provided to match 629 finish. - Escutcheons only



\*ElectroLynx®  
As part of their promise to provide innovative, fast and effective high security solutions to their customers, certain ASSA ABLOY Group brands offer *ElectroLynx*®, a universal quick-connect system that simplifies the electrification of the door opening.

**ED5200S/ED5200/ED5400/ED5800 SecureBolt®, Rim, Surface & CVR Heavy-Duty Trim**

Cylinder is not included.

**Escutcheon Trim Design: L9 Lustra**



**Lever:** Cast    **Escutcheon:** Forged



Function	Description	Finish: 613E, 630 <sup>1</sup> , BSP	Finish: 605, 606, 611, 612, 613, 618, 619, 625, 626, 629 <sup>2</sup> , 722
L9903ET*	Fail Safe	\$1,046.00	\$1,072.00
L9905ET*	Fail Secure		

**Escutcheon Trim Design: N9 Newport**



**Lever:** Cast    **Escutcheon:** Forged



Function	Description	Finish: 613E, 630 <sup>1</sup> , BSP	Finish: 605, 606, 611, 612, 613, 618, 619, 625, 626, 629 <sup>2</sup> , 722
N9903ET*	Fail Safe	\$1,046.00	\$1,072.00
N9905ET*	Fail Secure		

**Escutcheon Trim Design: R9 Regis**



**Lever:** Cast    **Escutcheon:** Forged

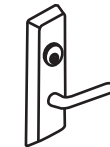

Function	Description	Finish: 613E, 630 <sup>1</sup> , BSP	Finish: 605, 606, 611, 612, 613, 618, 619, 625, 626, 629 <sup>2</sup> , 722
R9903ET*	Fail Safe	\$1,046.00	\$1,072.00
R9905ET*	Fail Secure		

**Escutcheon Trim Design: PR9 Princeton**



**Lever:** Cast    **Escutcheon:** Forged



Function	Description	Finish: 613E, 630 <sup>1</sup> , BSP	Finish: 605, 606, 611, 612, 613, 618, 619, 625, 626, 629 <sup>2</sup> , 722
PR9903ET*	Fail Safe	\$1,046.00	\$1,072.00
PR9905ET*	Fail Secure		

Notes:  
 1. 619 finish provided to match 630 finish. - Escutcheons only  
 2. 618 finish provided to match 629 finish. - Escutcheons only



\*ElectroLynx®  
 As part of their promise to provide innovative, fast and effective high security solutions to their customers, certain ASSA ABLOY Group brands offer *ElectroLynx*®, a universal quick-connect system that simplifies the electrification of the door opening.



**ED5200S/ED5200/ED5400/ED5800 SecureBolt®, Rim, Surface & CVR Heavy-Duty Trim**

Cylinder is not included.

**Escutcheon Trim Design: FR9 Frascati**



**Lever:** Cast **Escutcheon:** Forged



Function	Description	Finish: 613E, 626, BSP	Finish: 605, 606, 611, 612, 613, 618, 619, 625, 722
FR9903ET*	Fail Safe	\$1,046.00	\$1,072.00
FR9905ET*	Fail Secure		

**Escutcheon Trim Design: M9 Merlot**



**Lever:** Cast **Escutcheon:** Forged



Function	Description	Finish: 613E, 626, BSP	Finish: 605, 606, 611, 612, 613, 618, 619, 625, 722
M9903ET*	Fail Safe	\$1,046.00	\$1,072.00
M9905ET*	Fail Secure		

**Escutcheon Trim Design: Z9 Zinfandel**



**Lever:** Cast **Escutcheon:** Forged



Function	Description	Finish: 613E, 626, BSP	Finish: 605, 606, 611, 612, 613, 618, 619, 625, 722
Z9903ET*	Fail Safe	\$1,046.00	\$1,072.00
Z9905ET*	Fail Secure		



\*ElectroLynx®

As part of their promise to provide innovative, fast and effective high security solutions to their customers, certain ASSA ABLOY Group brands offer *ElectroLynx*®, a universal quick-connect system that simplifies the electrification of the door opening.

**Offset Pull Trim: P12, P13, P14**

Offset Pull Trim	Part Number	Finish: 613E, 630, BSP	Finishes: 605, 606, 612, 613, 626, 629
P12	716F50M X Finish	\$270.00	\$284.00
P13	716F51M X Finish	\$330.00	\$344.00
P14	716F52M X Finish	\$233.00	\$247.00

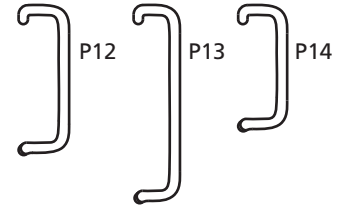
**Electrified Options for Exit Devices**

Description	Specify	Add or Deduct
Exit Alarm Device (cylinder is not included)	M61	\$709.00
Bolt Position Monitoring	M91*	Add \$217.00
Touchbar Monitoring or Signaling/Request to Exit (REX)	M92*	Add \$204.00
Outside Trim Monitoring or Signaling	M93*	
Motor Latch Retraction	MELR	\$835.00
Electric Dogging	M97*	Add \$416.00
SPDT Lock and Unlock security monitor switch (Electric Trim Only)	M98*	Add \$196.00
Trim gasket for exterior applications (Electric Trim Only)	M99	Add \$22.00
Mortise device lock with Outside Trim Control (Fail Safe)	SAF <sup>2</sup> *	\$713.00
Mortise device lock with Outside Trim Control (Fail Secure)	SEC <sup>2</sup> *	

**Delayed Egress Device**

Description	Suffix	Add or Deduct
Delayed Egress (Suffix the letter D to device. Ex: ED4200)	D	Add \$1533.00
30-Second Delay	M88*	\$107.00
BOCA 15-Second Delay	M89*	
BOCA 30-Second Delay	M90*	

**Notes:**

- Alarm kit cannot be installed in the field to surface vertical rod exit device. Any attempt to do so voids all warranties.
- Only available with ED5600(A) (Except knob trim)
- M88, M89 and M90 are available only as options for suffix "D" Delayed Egress Exit Devices.
- The following options cannot be ordered together on the same device: a) M94 or M97 & D; b) M94 x M97; c) M52 x M97; d) M97 x M107; e) M61 or M92 & D; f) M61 x M92; g) M61 x M52; h) M52 & D; i) ED5600 x M91 & M93; j) ED5600 SAF or SEC x M91 or M93; k) Surface vertical rod exit devices with M61 x M91, M92 or M93.

**\*ElectroLynx®**

As part of their promise to provide innovative, fast and effective high security solutions to their customers, certain ASSA ABLOY Group brands offer **ElectroLynx®**, a universal quick-connect system that simplifies the electrification of the door opening.

**Retrofit Kit: MELR rail assy, no switches, no latch, with controller, touchbar end cap**

Description	Specify	Price
Device ASSY, MELR 36"	727F158	\$835.00
Device ASSY, MELR 36" NS (Narrow Stile)	727F228	
Device ASSY, MELR 48"	727F238	
Device ASSY, MELR WS 36" Device	727F248	
Device ASSY, MELR WS 48" Device	727F258	

**Electrified Accessories**

Part Number	Description	Specify	Price
709F609	Power Supply 1 Amp (controls 1 "D" device)	BPS-24-1	\$327.00
709F619	Power Supply 2 Amp (controls 2 "D" devices or 1 "D" with SAF or SEC)	BPS-24-2	\$664.00
709F629	Power Supply 4 amp 24VDC	BPS-24-4	\$1,122.00
704F288	Concealed transfer (for over 120-degree swing door)	EPTL	\$129.00
709F689	(1) SPDT Maintained Switch (Includes LED)	MKA	\$129.00
709F709	(1) SPDT Momentary Switch (Includes LED)	MK	\$197.00
709F749	(1) SPDT Momentary Switch (Illuminated)	PB2	\$151.00
709F759	(1) SPDT Maintained (Alternating Action) Switch	PB3EA	\$115.00
709F769	(1) SPDT Momentary Switch (Illuminated)	PB3	\$146.00
709F779	(1) SPDT Momentary Switch	2' PB3ER	\$97.00
709F729	DPDT Momentary Key Switch	2' MK2	\$226.00
709F699	Narrow Stile Key Switch (Alt. action)	MKAN	\$197.00
704F719	Narrow Stile Momentary Key Switch	MKN	\$197.00
709F789	Sonalert 90db @ 2 ft. 12-24VDC Mounted on one gang stainless steel plate.	PZ1	\$97.00
	Alarm Kit (cylinder is not included) <sup>1</sup>	ED50AK	\$805.00
709F679	Door Cord	TSB-C	\$41.00
741F739	Digital Entry System (4 users)	DK-12	\$246.00
709F809	Digital Entry System (59 users) SS finish	FADK-26SS	\$693.00
709F819	Digital Entry System (59 users) Black finish	DK-26BK	\$693.00
709F669	Power Transfer	EPT	\$97.00
709F989	Remote Power Harness – 36"		\$134.00
709F999	Remote Power Harness – 48"		\$148.00

**Custom Laser Engraving- LASER**
**Laser engraving processing charge (all engraving types)**

- \$250 net per order. Charge will be applied to production order when placed.

**Single Vanity, Logo or Other (same engraving on all parts)**

- Lever - \$10 net add each
- Mortise Escutcheon - \$10 net add each
- HPSK Paddle - \$10 net add each

**Unique laser engraving (i.e. Room Number, Apartment Number, etc)**

- \$12 net add each (per piece)

**Cylinder Options\***

Description	Specify	Add or Deduct
Conventional 6-pin	6P**	Add \$86.00 per cylinder
Conventional 7-pin	7P	Add \$88.00 per cylinder
Access 3 Patented	AP	Add \$86.00 per cylinder
Access 3 Security	AS	Add \$135.00 per cylinder
Access 3 High Security, UL 437	AHS	Add \$155.00 per cylinder
Access 3 IC Patented	ACP	Add \$160.00 per cylinder
Access 3 IC Security	ACS	Add \$209.00 per cylinder
Access 3 IC High Security, UL 437	ACHS	Add \$223.00 per cylinder
Pyramid Security fixed core	PS	Add \$144.00 per cylinder
Pyramid Security IC	PCS	Add \$215.00 per cylinder
Pyramid High Security fixed core	PHS	Add \$174.00 per cylinder
Pyramid High Security IC	PCHS	Add \$244.00 per cylinder
Pyramid IC with temporary construction core	CTP	Add \$160.00 per cylinder
Pyramid IC with temporary disposable core	CTPD	Add \$86.00 per cylinder
Pyramid IC less core	CLP	Add \$86.00 per cylinder
Security	HS	Add \$197.00 per cylinder
Security IC	CHS	Add \$269.00 per cylinder
Blockout function	BO	Add \$179.00 per cylinder
IC 6-pin	C6	Add \$160.00 per cylinder
IC 6-pin with temporary construction core (Red)	CT6R	Add \$160.00 per cylinder
IC 6-pin with temporary construction core (Blue)	CT6B	Add \$160.00 per cylinder
IC 6-pin with temporary construction core (Green)	CT6G	Add \$160.00 per cylinder
IC 6-pin with temporary disposable core	CT6D	Add \$86.00 per cylinder
IC 6-pin less core	CL6	Add \$86.00 per cylinder
SFIC 6-pin with Less Core	CLS6	Add \$86.00 per cylinder
IC 6-pin with SFIC disposable temporary core	CT6SD	Add \$86.00 per cylinder
IC 7-pin	C7	Add \$164.00 per cylinder
IC 7-pin with temporary construction core (Red)	CT7R	Add \$164.00 per cylinder
IC 7-pin with temporary construction core (Blue)	CT7B	Add \$164.00 per cylinder
IC 7-pin with temporary construction core (Green)	CT7G	Add \$164.00 per cylinder
IC 7-pin with temporary disposable core	CT7D	Add \$88.00 per cylinder
IC 7-pin less core	CL7	Add \$88.00 per cylinder
SFIC 7-pin with Less Core	CLS7	Add \$88.00 per cylinder
IC 7-pin with SFIC disposable temporary core	CT7SD	Add \$88.00 per cylinder

\*Optional dogging cylinder will be furnished with the same mechanism and keyed alike with the trim cylinder, unless otherwise specified. If different keying or cylinder type is required, specify outside (trim) first, then inside (dogging) cylinder.

\*\*6P cylinder option is supplied in 6-pin, L4 keyway, 0-bitted with two nickel silver keys.

**Keying Options\***

Description	Specify	Add or Deduct
0-Bitted with 2 blank keys	(standard)	No Charge
Keyed random	KR	No Charge
Master keyed (all cylinders except 8000, 8020, 8027 IC)	specify keyset	Add \$16.00 per cylinder
Master keyed Pyramid	specify keyset	Add \$16.00 per cylinder
Master keyed Security (including IC cylinder and core)	specify keyset	Add \$16.00 per cylinder
Master keyed (8000, 8020, 8027 IC core)	specify keyset	No Charge
Master keyed to customer bittings or sample key	specify keyset	Add \$16.00 per cylinder
Construction master keyed <sup>1,2</sup>	CMK	Add \$16.00 per cylinder
Visual key control (VKC)		
- No Stamping	VKC0	\$4.50
- Keys only	VKC1	No Charge
- Cylinders and Keys <sup>3</sup>	VKC2	\$8.00
- Cylinders only <sup>3</sup>	VKC3	\$8.00
Concealed key control (CKC)		
- CKC cylinders with VKC keys	CKC2	\$8.00
- CKC cylinders only <sup>3</sup>	CKC3	\$8.00
More than 2 keys per lock	KY# (e.g., KY6)	See page 66 - Cut Keys Section

\*For key bows other than 10 and 90, specify "KB" + bow number as Quick Code, e.g. KB12.

Notes:

1. CMK Construction master keying charge is in addition to master keying charge.

2. CMK Construction master keying is not available in Pyramid or Security series.

3. VKC2, VKC3, CKC3 are not available in Pyramid or Security series.

**Door Height Options**
**ED5400, ED5400A, ED5470(B) Devices**

Door Height	Specify	Add or Deduct
7'0"	(standard)	No Charge
7'2"	H0702	
7'6"	H0706	
8'0"	H0800	

**ED5800, ED5800A, ED5860(B) Devices**

Door Height	Specify	Add or Deduct
8'0"	(standard)	No Charge

**ED5470(B), ED5860(B) Devices**

Door Height	Specify	Add or Deduct
9'0" <sup>1</sup>	H0900	Add \$82.00 per device
10'0" <sup>1</sup>	H1000	

**Door Width Options**

Door Width	Specify	Add or Deduct
24"	W024	Add \$292.00 per device
36"	(standard)	No Charge
48"	W048	Add \$35.00 per device

**Door Thickness Options**

Door Thickness	Specify	Add or Deduct
1-3/4"	(standard)	No Charge
2"	D200	
2-1/4"	D214	

**Strike Options**

Description	Specify	Add or Deduct
Rim x Vertical Rod on pairs of doors	S02	Add \$36.00 per device
Surface or Concealed Vertical Rod device bottom strike for 1/2" threshold	S09	No Charge
Flush transom top strike bracket	M67	Add \$30.00 per device
Mortise Device		
-ANSI wrought strike box	M17	No Charge
-ANSI strike for pair of doors w/astragal (7/8" L to C)	SS078	
-Open back strike for 1-3/4" door	SB134	Add \$80.00 per device
-Open back strike for 2-1/4" door	SB214	\$128.00

Note:

1. H0900 and H1000 options for ED5470(B), ED5860(B) devices only

**Miscellaneous Options**

Description	Specify	Add or Deduct
Torx® screws for rim, concealed vertical rod, mortise	M04	Add \$44.00 per device
Torx® screws for surface vertical rod	M04	Add \$83.00 per device
Knurling outside and inside (Embossed Touchbar - device side) <sup>1</sup>	M20	Add \$145.00 per device
Knurling outside only (trim side) <sup>1</sup>	M21	Add \$68.00 per device
Knurling inside only (Embossed Touchbar - device side)	M22	Add \$77.00 per device
Abrasive coat outside and inside (trim and device)	M23	Add \$92.00 per device
Abrasive coat inside only (device side)	M24	Add \$48.00 per device
Abrasive coat outside only (trim side)	M25	Add \$44.00 per device
Pathlite™ Photoluminescent Touchbar cover	M49	Add \$348.00 per device
Less dogging	M51	No Charge
Cylinder dogging (less cylinder)	M52	Add \$78.00 per device
Sex nuts and bolts (SNBs)	M54	No Charge
Less bottom vertical rod <sup>2</sup>	M55	
Narrow stile cover	M56	No Charge
Shim kit (for vision light)		
- All rim and concealed vertical rod	M58	Add \$72.00 per device
- All surface vertical rod	M58	Add \$96.00 per device
- All mortise exit devices	M58	Add \$96.00 per device
Parabolic Design Exit Trim	M60	Add \$78.00 per device
Wood screws For use on fire rated solid wood or wood core doors	M64	No Charge
Windstorm Certified products for ED5200S(A) and ED5470(B) Only <sup>3, 4, 5</sup>	M107	Add \$85.00 per device
End Cap Reinforcement (used with standard end cap only)	M109	Add \$78.00 per device
Flush End Cap	M110	No Charge

**Notes:**

1. Not available with VT9, VTL9, VT9M and VTL9M trim.
2. Available with ED5470 and ED5860 series only.
3. ED5200S(A) x M107 requires through bolts.
4. ED5470(B) maximum opening height is 8'0".
5. Contact Ceco, Curries® or Fleming for detailed frame/door requirements and limitations.

**Surface Bolt™**

Description	Specify	Price
Surface Bolt Kit For Approved Windstorm Code Applications - bright zinc plated finish	988CR	\$140.00

**Mullions**
**Ordering Example**

Quantity	Mullion Number
10	907A

**Removable Mullions**

Door Height	Description	Specify	Price
Up to 7'0"	Steel Mullion - Panic Rated	CR907	\$661.00
Up to 8'0"	Steel Mullion - Panic Rated	CR908	\$671.00
Up to 10'0" (ED5200, ED5200S only)	Steel Mullion - Panic Rated	CR910	\$797.00
Up to 7'0"	Steel Mullion - 3 Hour Fire Rated	CR907A	\$918.00
Up to 8'0"	Steel Mullion - 3 Hour Fire Rated	CR908A	\$928.00
Up to 7'0"	Steel Mullion - 3 Hour Fire Rated, Windstorm Certified	CRFE707A <sup>1</sup>	\$1,145.00
Up to 8'0"	Steel Mullion - 3 Hour Fire Rated, Windstorm Certified	CRFE708A <sup>1</sup>	\$1,155.00

**Key Removable Mullions**

Door Height	Description	Specify	Price
Up to 7'0"	Steel Mullion - 1-1/2 Hour Fire Rated	CR907BKM <sup>2</sup>	\$1,414.00
Up to 8'0"	Steel Mullion - 1-1/2 Hour Fire Rated	CR908BKM <sup>2</sup>	\$1,424.00
Up to 10'0" (ED5200, ED5200S only)	Steel Mullion - Panic Rated	CR910KM <sup>2</sup>	\$1,250.00
Up to 7'0"	Steel Mullion - 3 Hour Fire Rated, Windstorm Certified	CRWS707AKM <sup>2</sup>	\$1,607.00
Up to 8'0"	Steel Mullion - 3 Hour Fire Rated, Windstorm Certified	CRWS708AKM <sup>2</sup>	\$1,617.00

**Notes:**

1 For use with UL approved door assemblies that comply to FEMA 361 and FEMA 320 guidelines.

For the latest listings on compliant door assemblies visit our website at [corbinrusswin.com](http://corbinrusswin.com)

2 Cylinder and collars not included, specify separately

**Mullions Cylinder Options**

Description	Specify	Add or Deduct
Conventional 6-pin	6P	Add \$86.00 per cylinder
Conventional 7-pin	7P	Add \$88.00 per cylinder
IC 6-pin	C6	Add \$160.00 per cylinder
IC 7-pin	C7	Add \$164.00 per cylinder
Pyramid High Security Fixed Core	PHS	Add \$174.00 per cylinder
Pyramid Security Fixed Core	PS	Add \$144.00 per cylinder
Pyramid High Security IC	PCHS	Add \$244.00 per cylinder
Pyramid Security IC	PCS	Add \$215.00 per cylinder
Security	HS	Add \$197.00 per cylinder
Security IC	CHS	Add \$269.00 per cylinder
IC 6-pin less core	CL6	Add \$86.00 per cylinder
IC 7-pin less core	CL7	Add \$88.00 per cylinder

**Options**

Description	Specify	Add or Deduct
Door frame filler block for double rabbetted frames	M95	Add \$42.00 per mullion
Door frame angle bracket for aluminum frames	M96	Add \$42.00 per mullion
Mullion stabilizer	M57	Add \$62.00 per mullion

**Standard Features**

**Handing**

Handed, specify hand

**Door Thickness**

1-3/4"

**Backset**

2-3/4"

**Projection**

4-7/8"; 3-1/8" depressed

**Trim**

Cylinder is not included.  
See page 303 for  
cylinder options.

**Rim**

ED7200

Panic

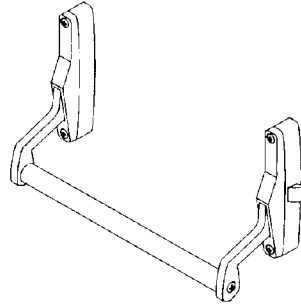

**Vertical Rod**

ED7400

Panic

**Concealed Vertical Rod**

ED7800

Panic

ED7800A

3 Hour Fire Rated

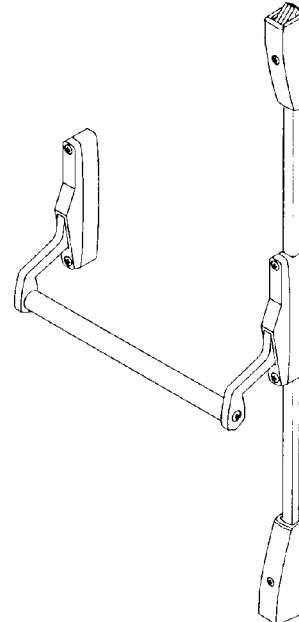

**Mortise**

ED7600

Panic

ED7600A

3 Hour Fire Rated

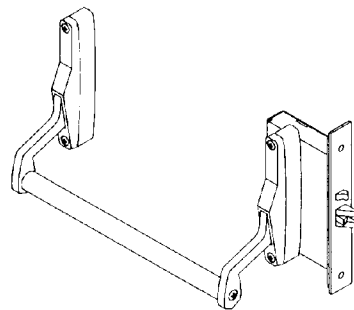



**Ordering Example**
**Rim Exit Device**

Quantity	Exit Device	Finish	Hand	Misc. Options
20	ED7200	606	RHR	M51-M54

**Rim Exit Device with Trim**

Quantity	Exit Device	Trim/Function	Finish	Hand	Door Thickness	Door Width	Misc. Options
50	ED7200	P557ET	630	LHR	D214	W048	M53

**Trim Only (Rim Device)**

Quantity	Exit Device	Finish
10	P457ET	630

**Vertical Rod Exit Device with Trim**

Quantity	Exit Device	Trim/Function	Finish	Hand	Door Thickness	Door Width	Misc. Options
50	ED7401	C455ET	613	RHR	D214	W048	H1000

**Mortise Exit Device with Trim**

Quantity	Exit Device	Trim/Function	Finish	Hand	Door Thickness	Strike	Door Width
50	ED7600A	T11M55ET	626	LHR	D200	SB200	W048

**Contract/Detailed Order - Rim Exit Device with Trim**

Quantity	Keyset	Exit Device	Trim/Function	Finish	Hand	Door Thickness	Door Width	Optional Cylinders	Keying
50	AA1	ED7200	P457ET	626	LHR	D200	W048	C6	VKC3

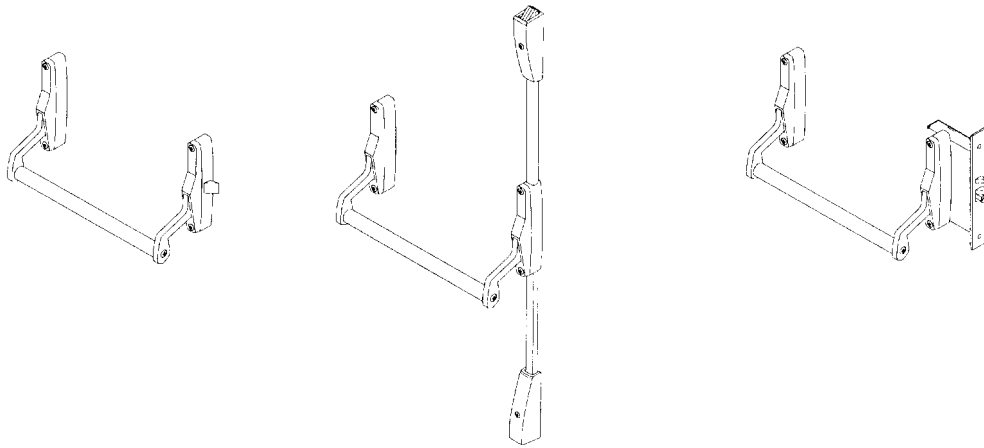

**36" Device Only**

Includes device, strike(s) and screw pack. No cylinder or trim.

**Rim ED7200 Series**

Function	Description	Finish: 613E, 626	Finish: 605, 606, 611, 612, 613, 618, 619, 625, 629, 630, 722
ED7200	Panic	\$2,742.00	\$2,819.00

**Vertical Rod ED7400 Series**

Function	Description	Finish: 613E, 626	Finish: 605, 606, 611, 612, 613, 618, 619, 625, 629, 630, 722
ED7400	Panic Exit Trim Only (accepts operator trim)	\$3,188.00	\$3,265.00
ED7401	Panic Exit Trim Only (accepts lever trim)		

**Mortise ED7600 Series**

Function	Description	Finish: 613E, 626	Finish: 605, 606, 611, 612, 613, 618, 619, 625, 629, 630, 722
ED7600	Panic	\$2,900.00	\$2,977.00
ED7600A	3 Hour Fire Rated		

**Concealed V.R. ED7800 Series**

Function	Description	Finish: 613E, 626	Finish: 605, 606, 611, 612, 613, 618, 619, 625, 629, 630, 722
ED7800	Panic	\$3,078.00	\$3,155.00
ED7800A	3 Hour Fire Rated	\$3,248.00	\$3,325.00

Caution: Be sure of your measurements. Exit devices are NOT returnable.

**ED7200 Rim Trim**

Cylinder is not included.

**Pull Trim Design: P4 D Grip Pull**



**Grip:** Extruded

**Escutcheon:** Wrought



Function	Description	Finish: 613E, 626	Finish: 605, 606, 611, 612, 613, 618, 619, 625, 629, 630, 722
P450ET	Dummy	\$369.00	\$397.00
P457ET	Nightlatch		

**Pull Trim Design: P5 Round Grip Pull**



**Grip:** Extruded

**Escutcheon:** Wrought



Function	Description	Finish: 613E, 626	Finish: 605, 606, 611, 612, 613, 618, 619, 625, 629, 630, 722
P550ET	Dummy	\$369.00	\$397.00
P557ET	Nightlatch		

**Pull Trim Design: P6 Pull**



**Grip:** Wrought  
MR option available

**Escutcheon:** Wrought



Function	Description	Finish: 613E, 626	Finish: 605, 606, 611, 612, 613, 618, 619, 625, 629, 630, 722
P650ET	Dummy	\$369.00	\$397.00
P657ET	Nightlatch		

**Pull Trim Design: P7 Plate**

**Escutcheon:** Wrought  
MR option available



Function	Description	Finish: 613E, 626	Finish: 605, 606, 611, 612, 613, 618, 619, 625, 629, 630, 722
P757ET	Nightlatch	\$361.00	\$389.00

**ED7400 Surface Vertical Rod Trim**

Cylinder is not included.

**Escutcheon Trim Design: C4 Citation**



**Lever:** Cast  
MR option available

**Escutcheon:** Wrought  
Available with ED7401 device only.



Function	Description	Finish: 613E, 626	Finish: 605, 606, 611, 612, 613, 618, 619, 625, 629, 630, 722
C455ET*	Classroom	\$772.00	\$800.00
C457ET*	Nightlatch		

\*1-3/4 doors only

**Escutcheon Trim Design: D4 Dirke**



**Lever:** Cast  
MR option available

**Escutcheon:** Wrought  
Available with ED7401 device only.



Function	Description	Finish: 613E, 626	Finish: 605, 606, 611, 612, 613, 618, 619, 625, 629, 630, 722
D455ET*	Classroom	\$772.00	\$800.00
D457ET*	Nightlatch		

\*1-3/4 doors only

**Escutcheon Trim Design: O3 D Grip Operator**



**Pull:** Extruded  
MR option available

**Escutcheon:** Cast  
Available with ED7400 only.



Function	Description	Finish: 613E, 626	Finish: 605, 606, 611, 612, 613, 618, 619, 625, 629, 630, 722
O355ET	Classroom	\$772.00	\$800.00
O356ET**	Nightlatch		
O357ET	Nightlatch		

**Escutcheon Trim Design: O4 Round Grip Operator**



**Pull:** Extruded  
MR option available

**Escutcheon:** Cast  
Available with ED7400 only.



Function	Description	Finish: 613E, 626	Finish: 605, 606, 611, 612, 613, 618, 619, 625, 629, 630, 722
O455ET	Classroom	\$772.00	\$800.00
O456ET**	Nightlatch		
O457ET	Nightlatch		

\*\*Key also used to hold top and bottom latchbolts in retracted position.

**ED7600 Mortise Trim**

Cylinder is not included.

**Escutcheon Trim Design: C4M Citation**



**Lever:** Cast

**Escutcheon:** Cast

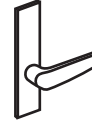

Function	Description	Finish: 613E, 626	Finish: 605, 606, 611, 612, 613, 618, 619, 625, 629, 630, 722
C4M10ET	Passage	\$772.00	\$800.00
C4M55ET	Classroom		

**Escutcheon Trim Design: D4M Dirke**



**Lever:** Cast

**Escutcheon:** Cast



Function	Description	Finish: 613E, 626	Finish: 605, 606, 611, 612, 613, 618, 619, 625, 629, 630, 722
D4M10ET	Passage	\$772.00	\$800.00
D4M55ET	Classroom		

**Escutcheon Trim Design: G6M Global**

**Knob:** Wrought Reinforced

**Escutcheon:** Cast



Function	Description	Finish: 613E, 626	Finish: 605, 606, 611, 612, 613, 618, 619, 625, 722
G6M10ET	Passage	\$772.00	\$800.00
G6M50ET	Dummy		
G6M55ET	Classroom		

**ED7600 Mortise Trim**

Cylinder is not included.

**Thumbpiece Trim Design: T11M D Grip**

**Grip:** Extruded      **Escutcheon:** Cast



Function	Description	Finish: 613E, 626	Finish: 605, 606, 611, 612, 613, 618, 619, 625, 629, 630, 722
T11M10ET	Passage	\$568.00	\$596.00
T11M50ET	Dummy		
T11M55ET	Classroom		
T11M57ET	Nightlatch		

**Thumbpiece Trim Design: T12M Round Grip**

**Grip:** Extruded      **Escutcheon:** Cast



Function	Description	Finish: 613E, 626	Finish: 605, 606, 611, 612, 613, 618, 619, 625, 629, 630, 722
T12M10ET	Passage	\$568.00	\$596.00
T12M50ET	Dummy		
T12M55ET	Classroom		
T12M57ET	Nightlatch		

**ED7800 Concealed Vertical Rod Trim**

Cylinder is not included.

**Trim Design: O5 Operator**

**Escutcheon:** Cast



Function	Description	Finish: 613E, 626	Finish: 605, 606, 611, 612, 613, 618, 619, 625, 629, 630, 722
O557ET	Nightlatch	\$275.00	\$311.00

**Offset Pull Trim: P12, P13, P14**

Offset Pull Trim	Part Number	Finish: 613E, 630	Finishes: 605, 606, 612, 613, 626, 629
P12	716F50M X Finish	\$270.00	\$284.00
P13	716F51M X Finish	\$330.00	\$344.00
P14	716F52M X Finish	\$233.00	\$247.00

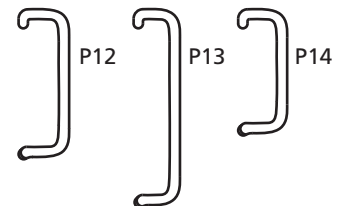

**Cylinder Options**

Description	Specify	Add or Deduct
Conventional 6-pin <sup>7</sup>	6P*	Add \$86.00 per cylinder
Conventional 7-pin <sup>7</sup>	7P	Add \$88.00 per cylinder
Access 3 Patented	AP	Add \$86.00 per cylinder
Access 3 Security	AS	Add \$135.00 per cylinder
Access 3 High Security, UL 437	AHS	Add \$155.00 per cylinder
Access 3 IC Patented	ACP	Add \$160.00 per cylinder
Access 3 IC Security	ACS	Add \$209.00 per cylinder
Access 3 IC High Security, UL 437	ACHS	Add \$223.00 per cylinder
Pyramid Security fixed core <sup>1, 5, 6</sup>	PS	Add \$144.00 per cylinder
Pyramid Security IC <sup>2, 6</sup>	PCS	Add \$215.00 per cylinder
Pyramid High Security fixed core <sup>1, 5, 6</sup>	PHS	Add \$174.00 per cylinder
Pyramid High Security IC <sup>2, 6</sup>	PCHS	Add \$244.00 per cylinder
Pyramid IC with temporary construction core <sup>2, 6</sup>	CTP	Add \$160.00 per cylinder
Pyramid IC with temporary disposable core <sup>1, 3, 6</sup>	CTPD	Add \$86.00 per cylinder
Pyramid IC less core <sup>2, 6</sup>	CLP	Add \$86.00 per cylinder
Security <sup>1</sup>	HS	Add \$197.00 per cylinder
Security IC <sup>2</sup>	CHS	Add \$269.00 per cylinder
Blockout function	BO	Add \$179.00 per cylinder
IC 6-pin <sup>2</sup>	C6	Add \$160.00 per cylinder
IC 6-pin with temporary construction core <sup>2</sup> (Red)	CT6R	Add \$160.00 per cylinder
IC 6-pin with temporary construction core <sup>2</sup> (Blue)	CT6B	Add \$160.00 per cylinder
IC 6-pin with temporary construction core <sup>2</sup> (Green)	CT6G	Add \$160.00 per cylinder
IC 6-pin with temporary disposable core <sup>2</sup>	CT6D	Add \$86.00 per cylinder
IC 6-pin less core <sup>2</sup>	CL6	Add \$86.00 per cylinder
SFIC 6-pin with Less Core	CLS6	Add \$86.00 per cylinder
IC 6-pin with SFIC disposable temporary core	CT6SD	Add \$86.00 per cylinder
IC 7-pin <sup>3</sup>	C7	Add \$164.00 per cylinder
IC 7-pin with temporary construction core <sup>3</sup> (Red)	CT7R	Add \$164.00 per cylinder
IC 7-pin with temporary construction core <sup>3</sup> (Blue)	CT7B	Add \$164.00 per cylinder
IC 7-pin with temporary construction core <sup>3</sup> (Green)	CT7G	Add \$164.00 per cylinder
IC 7-pin with temporary disposable core <sup>3</sup>	CT7D	Add \$88.00 per cylinder
IC 7-pin less core <sup>3</sup>	CL7	Add \$88.00 per cylinder
SFIC 7-pin with Less Core	CLS7	Add \$88.00 per cylinder
IC 7-pin with SFIC disposable temporary core	CT7SD	Add \$88.00 per cylinder
Less master ring cylinder <sup>4</sup>	MR-LC	No Charge
Master Ring <sup>4</sup>	MR	Add \$133.00 per cylinder

\*6P cylinder option is supplied in 6-pin, L4 keyway, 0-bitted with two nickel silver keys.

**Notes:**

- |                                    |  |  |
|------------------------------------|--|--|
| 1. Available on outside trim only. | 4. Available on C4, D4, OBS, O3, O4 trims only.          | 6. Pyramid is not available on ED7600 with door thicknesses over 2-1/4". |
| 2. Not available on O5 trim.       | 5. Not available on ED7600 C4M, D4M, E4M B5M, G6M trims. | 7. Not available on P4, P5, P5, P7 trims.                                |
| 3. Rim only.                       |  |  |

**Keying Options**

Description	Specify	Add or Deduct
0-Bitted with 2 blank keys	(standard)	No Charge
Keyed Random	KR	No Charge
Master Keyed (all cylinders except 8000, 8020, 8027 IC core)	specify keyset	Add \$16.00 per cylinder
Master Keyed Pyramid	specify keyset	Add \$16.00 per cylinder
Master Keyed Security (including IC cylinder and core)	specify keyset	Add \$16.00 per cylinder
Master Keyed (8000, 8020, 8027 IC core)	specify keyset	No Charge
Master Keyed to customer bittings or sample key	specify keyset	Add \$16.00 per cylinder
Construction master keyed <sup>1, 2</sup>	CMK	Add \$16.00 per cylinder
Visual key control (VKC)		
- No Stamping	VKC0	\$4.50
- Keys only	VKC1	No Charge
- Cylinders and Keys <sup>3</sup>	VKC2	\$8.00
- Cylinders only <sup>3</sup>	VKC3	\$8.00
Concealed key control (CKC)		
- CKC cylinders with VKC keys	CKC2	\$8.00
- CKC cylinders only <sup>3</sup>	CKC3	\$8.00
More than 2 keys per lock	KY# (e.g., KY6)	See page 66 - Cut Keys Section

- Notes:
1. CMK Construction master keying charge is in addition to master keying charge.
  2. CMK Construction master keying is not available in Pyramid or Security series.
  3. VKC2, VKC3, CKC3 are not available in Pyramid or Security series.

**Strike Options**

To purchase strike separately, see catalog for part no.

Description	Specify	Add or Deduct
Open rim strike on ED7200	(standard)	No Charge
Rim strike	S07	
Rim strike for aluminum frames with blade stops	S08	
Mortised adjustable rim strike	S04	
Vertical rod top strike on ED7400 device	(standard)	
Vertical rod bottom strike on ED7400	(standard)	
Vertical rod flush bottom strike on ED7400 device	S03	
Concealed vertical rod top strike on ED7800 device	(standard)	
Fire rated concealed vertical rod top strike on ED7800A device	(standard)	
Fire rated concealed vertical rod bottom strike on ED7800 and ED7800A devices	(standard)	

Description	Lip Length	Specify	Add or Deduct
Mortise straight lip ANSI strike on ED7600, ED7600A	1-1/8"	(standard)	No Charge
	1-1/4"	SS114	
	1-3/8"	SS138	
Mortise open back strike	1-3/4"	SB134	Add \$80.00 per device
	2"	SB200	\$128.00
	2-1/4"	SB214	

**Custom Laser Engraving- LASER**
**Laser engraving processing charge (all engraving types)**

- \$250 net per order. Charge will be applied to production order when placed.

**Single Vanity, Logo or Other (same engraving on all parts)**

- Lever - \$10 net add each
- Mortise Escutcheon - \$10 net add each
- HPSK Paddle - \$10 net add each

**Unique laser engraving (i.e. Room Number, Apartment Number, etc)**

- \$12 net add each (per piece)



<b>Door Width Options</b>		
Description	Specify	Add or Deduct
36"	(standard)	No Charge
48"	W048	Add \$35.00 per device
<b>Door Thickness Options</b>		
Description	Specify	Add or Deduct
1-3/4"	(standard)	No Charge
2" (Not available for ED7800 Series)	D200	
2-1/4" (Not available for ED7800 Series)	D214	
<b>Door Height Options</b>		
Description	Specify	Add or Deduct
7'6" (ED7400 devices)	(standard)	No Charge
7'2" (ED7400A & 7800A devices)	(standard)	
8'6" (ED7800 devices)	(standard)	
10'0" (ED7400 devices only)	H1000	Add \$82.00 per device
10'8" (ED7800 devices only)	H1008	
<b>Miscellaneous Options</b>		
Description	Specify	Add or Deduct
Spanner head screws	M02	Add \$33.00 per device
ANSI wrought strike box (for mortise only)	M17	No Charge
Knurling outside and inside (trim and device)	M20	Add \$145.00 per device
Knurling outside only (trim side)	M21	Add \$68.00 per device
Knurling inside only (device side)	M22	Add \$77.00 per device
Abrasive coat outside and inside (trim and device)	M23	Add \$92.00 per device
Abrasive coat inside only (device side)	M24	Add \$48.00 per device
Abrasive coat outside only (trim side)	M25	Add \$44.00 per device
Stainless steel crossbar <sup>1</sup>		
- When ordered with 626 or 630 finish	M50	No Charge
- All other finishes	M50	Add \$74.00 per device
Less dogging	M51	No Charge
Steel reinforced crossbar	M53	Add \$68.00 per device
Sex nuts and bolts (SNBs)	M54	No Charge
Shim for 2-3/4" backset on doors with 1/2" stop (for ED7200 only)	M59	Add \$22.00 per device
Less latch hold-back (for ED7200 and ED7600 devices only)	M66	No Charge
Note: 1. Not available with M22 or M20 option.		

**Mortise Lock Only**

Includes lockcase, armored front, strike and screw pack. No cylinder.

**Ordering Example**

Qty	Lock Number	Hand	Finish
10	MLE09	RHR	626

Lock Number	Description	Finish: 605, 606, 611, 612, 613, 622, 625, 626, 629, 630
MLE08	ED7600	\$595.00
MLE09	ED7600A	\$605.00

**Removable Mullion**
**Ordering Example**

Quantity	Mullion Number
10	CR507

Mullion Number	Description	Price
CR507	For doors up to 7'2"	\$665.00
CR508	For doors up to 8'0"	\$928.00
CR510	For doors up to 10'	\$797.00

**Standard Features****Handing**

ED8200 Non-handed

ED8400 Handed; specify hand

**Door Thickness**

1-3/4"

**Backset**

2-3/4"

**Bar Length**36 standard; 30", 42" and 48"  
available. Easily field cut to size.**Projection**

2-1/2"

**Trim**

Cylinder is not included.

See page 313 for  
cylinder options.**RIM**

ED8200

ED8200B

ED8200A

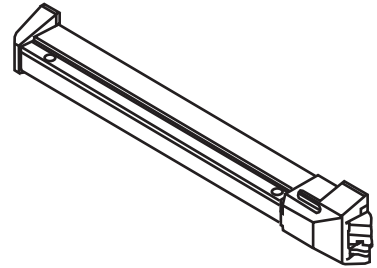
**Panic****1-1/2 Hour Fire Rated****3 Hour Fire Rated****VERTICAL ROD**

ED8400

ED8400A

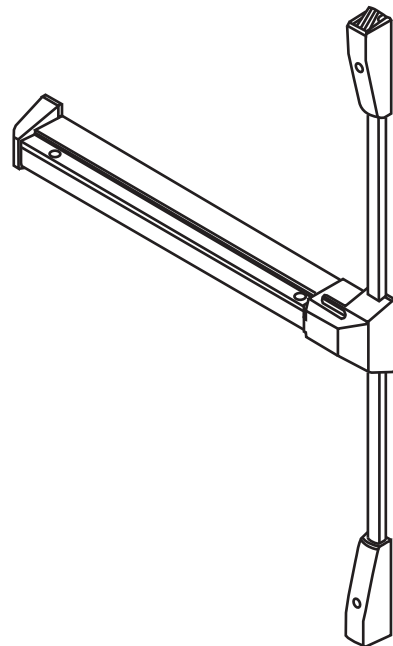
**Panic****3 Hour Fire Rated**

**Ordering Example**
**Rim Exit Device**

Quantity	Exit Device	Finish
20	ED8200	689

**Rim Exit Device with Trim**

Quantity	Exit Device	Trim/Function	Finish		Hand	Door Thickness	Door Width	Misc. Options
			Trim	Device				
50	ED8200A	A657ET	613	690	RHR	D200	W048	M58

**Trim Only (Rim or Vertical Rod)**

Quantity	Trim/Function	Finish	Hand
10	N655ET	606	RHR

**Vertical Rod Exit Device with Trim**

Quantity	Exit Device	Trim/Function	Finish		Hand	Optional Strike	Door Width	Height
			Trim	Device				
50	ED8400	PR610ET	626	689	RHR	S03	W048	H1000

**Contract/Detailed Order - Rim Exit Device with Trim**

Quantity	Keypad	Exit Device	Trim/Function	Finish		Hand	Door Thickness	Door Width	Optional Cylinder	Keying
				Trim	Device					
50	AA1	ED8200	N655ET	626	689	LHR	D200	W048	C6	VKC3

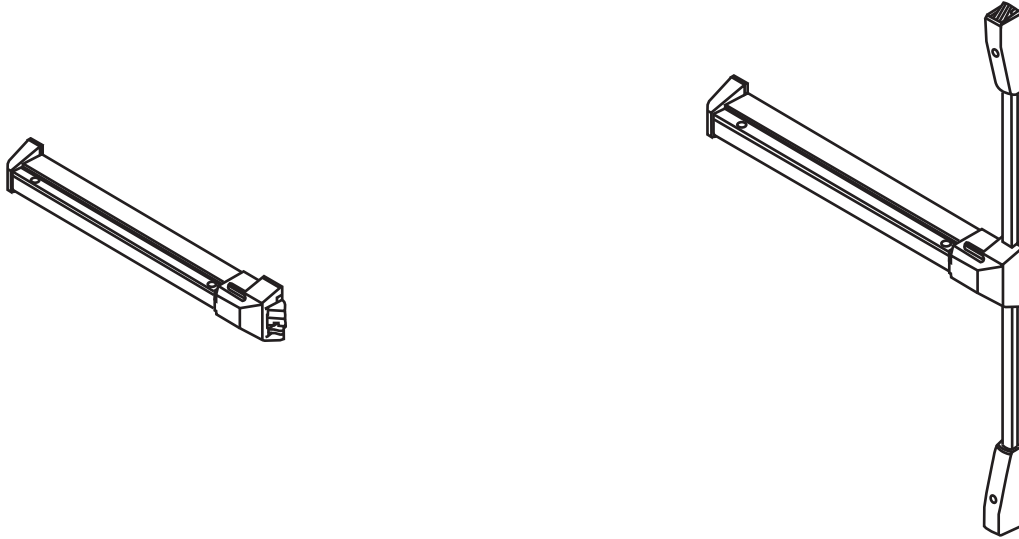

**30", 36" and 42" Exit Devices**

Includes device, strike(s) and screw pack. No cylinder or trim.

**Rim ED8200 Series**

Function	Description	Finish: 689, 690, 691
ED8200	Panic	\$539.00
ED8200B	1-1/2 Hour Fire Rated	\$611.00
ED8200A	3 Hour Fire Rated	\$692.00

**Vertical Rod ED8400 Series**

Function	Description	Finish: 689, 690, 691
ED8400	Panic	\$945.00
ED8400A	3 Hour Fire Rated	\$1,098.00

Caution: Be sure of your measurements. Exit devices are NOT returnable.

**ED8200/ED8400 Rim and Vertical Rod Trim**

Cylinder is not included, except where noted.

**Rose Trim Design: A6 Armstrong**



**Lever:** Die cast zinc  
Cylinder included

**Rose:** Wrought brass or bronze



Function	Description	Finish: 613E, 626, BSP	Finish: 605, 606, 611, 612, 613, 619, 625, 722
A610ET	Passage	\$312.00	\$322.00
A650ET	Dummy	\$312.00	\$322.00
A655ET	Classroom	\$338.00	\$348.00
A657ET	Nightlatch <sup>1</sup>		
A659ET	Storeroom		

**Rose Trim Design: N6 Newport**



**Lever:** Die cast zinc  
Cylinder included

**Rose:** Wrought brass or bronze



Function	Description	Finish: 613E, 626, BSP	Finish: 605, 606, 611, 612, 613, 619, 625, 722
N610ET	Passage	\$312.00	\$322.00
N650ET	Dummy	\$312.00	\$322.00
N655ET	Classroom	\$338.00	\$348.00
N657ET	Nightlatch <sup>1</sup>		
N659ET	Storeroom		

**Rose Trim Design: PR6 Princeton**



**Lever:** Die cast zinc  
Cylinder included

**Rose:** Wrought brass or bronze



Function	Description	Finish: 613E, 626, BSP	Finish: 605, 606, 611, 612, 613, 619, 625, 722
PR610ET	Passage	\$312.00	\$322.00
PR650ET	Dummy	\$312.00	\$322.00
PR655ET	Classroom	\$338.00	\$348.00
PR657ET	Nightlatch <sup>1</sup>		
PR659ET	Storeroom		

Note:  
1. Not recommended for use with ED8400 and ED8400A surface vertical rod exit devices.

**ED8200/ED8400 Rim and Vertical Rod Trim**

Cylinder is not included, except where noted.

**Rose Trim Design: G10 Global**

**Knob:** Wrought  
Cylinder included

**Rose:** Wrought brass or bronze



Function	Description	Finish: 613E, 626, BSP	Finish: 605, 606, 611, 612, 613, 619, 625, 722
G1010ET	Passage	\$293.00	\$303.00
G1055ET	Classroom	\$319.00	\$329.00
G1050ET	Dummy	\$293.00	\$303.00
G1057ET	Nightlatch <sup>1</sup>	\$319.00	\$329.00
G1059ET	Storeroom	\$319.00	\$329.00

**Flat Plate Trim Design: F1 Flat Plate**

**Plate:** Steel

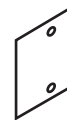

Function	Description	Finish: 613E, 626, BSP	Finish: 605, 606, 611, 612, 613, 619, 625, 722
F150ET	Dummy	\$83.00	\$93.00
F157ET	Nightlatch <sup>1</sup>		

**Pull Trim Design: P1 Z-Pull**



**Pull:** Extruded Aluminum



Function	Description	Finish: 613E, 626, BSP	Finish: 605, 606, 611, 612, 613, 619, 625, 722
P150ET	Dummy	\$252.00	\$262.00

Note:

1. Not recommended for use with ED8400 and ED8400A surface vertical rod exit devices.

**ED8200/ED8400 Rim and Vertical Rod Trim**

Cylinder is not included, except where noted.

**Pull Trim Design: P2 Offset Pull**



**Pull:** Extruded Aluminum



Function	Description	Finish: 613E, 626, BSP	Finish: 605, 606, 611, 612, 613, 619, 625, 722
P250ET	Dummy	\$292.00	\$302.00
P257ET	Nightlatch <sup>1</sup>		

**Pull Trim Design: P8 Wing Pull**



**Pull:** Extruded Aluminum



Function	Description	Finish: 689, 690, 691
P850ET	Dummy	\$85.00
P857ET	Nightlatch <sup>1</sup>	

**Trim Design: KO Key Only**

Note: Available with cylinder option only.  
Example: KO57 x 6P



Function	Description	Finish: 605, 606, 611, 612, 613, 619, 622, 625, 626, 722
KO57ET	Nightlatch <sup>1</sup>	\$57.00

**Offset Pull Trim: P12, P13, P14**

Offset Pull Trim	Part Number	Finishes: 613E, 630, BSP	Finishes: 605, 606, 612, 613, 626, 629
P12	716F50M X Finish	\$270.00	\$284.00
P13	716F51M X Finish	\$330.00	\$344.00
P14	716F52M X Finish	\$233.00	\$247.00

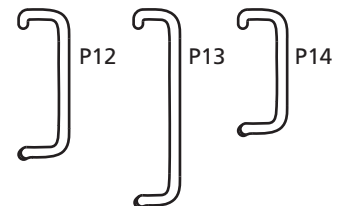

Note:

1. Not recommended for use with ED8400 and ED8400A surface vertical rod exit devices.



**Cylinder Options\***
**Rim Cylinder Trim**

Description	Specify	Add or Deduct
Conventional 6-pin	6P**	Add \$86.00 per cylinder
Conventional 7-pin	7P	Add \$88.00 per cylinder
Access 3 Patented	AP	Add \$86.00 per cylinder
Access 3 Security	AS	Add \$135.00 per cylinder
Access 3 High Security, UL 437	AHS	Add \$155.00 per cylinder
Access 3 IC Patented	ACP	Add \$160.00 per cylinder
Access 3 IC Security	ACS	Add \$209.00 per cylinder
Access 3 IC High Security, UL 437	ACHS	Add \$223.00 per cylinder
Pyramid Security fixed core	PS	Add \$144.00 per cylinder
Pyramid Security IC	PCS	Add \$215.00 per cylinder
Pyramid High Security fixed core	PHS	Add \$174.00 per cylinder
Pyramid High Security IC	PCHS	Add \$244.00 per cylinder
Pyramid IC with temporary construction core	CTP	Add \$160.00 per cylinder
Pyramid IC with temporary disposable core	CTPD	Add \$86.00 per cylinder
Pyramid IC less core	CLP	Add \$86.00 per cylinder
Security	HS	Add \$197.00 per cylinder
Security IC	CHS	Add \$269.00 per cylinder
IC 6-pin	C6	Add \$160.00 per cylinder
IC 6-pin with temporary construction core (Red)	CT6R	Add \$160.00 per cylinder
IC 6-pin with temporary construction core (Blue)	CT6B	Add \$160.00 per cylinder
IC 6-pin with temporary construction core (Green)	CT6G	Add \$160.00 per cylinder
IC 6-Pin with temporary disposable core	CT6D	Add \$86.00 per cylinder
IC 6-pin less core	CL6***	Add \$86.00 per cylinder
SFIC 6-pin with Less Core	CLS6	Add \$86.00 per cylinder
IC 6-pin with SFIC disposable temporary core	CT6SD	Add \$86.00 per cylinder
IC 7-pin	C7	Add \$164.00 per cylinder
IC 7-pin with temporary construction core (Red)	CT7R	Add \$164.00 per cylinder
IC 7-pin with temporary construction core (Blue)	CT7B	Add \$164.00 per cylinder
IC 7-pin with temporary construction core (Green)	CT7G	Add \$164.00 per cylinder
IC 7-Pin with temporary disposable core	CT7D	Add \$88.00 per cylinder
IC 7-pin less core	CL7	Add \$88.00 per cylinder
SFIC 7-pin with Less Core	CLS7	Add \$88.00 per cylinder
IC 7-pin with SFIC disposable temporary core	CT7SD	Add \$88.00 per cylinder
Blockout function	BO	Add \$179.00 per cylinder

**Knob and Lever Trim**

Description	Specify	Add or Deduct
Conventional 6-pin	6P**	No Charge
Conventional 7-pin	7P	Add \$2.00 per cylinder
Access 3 Patented	AP	No Charge
Access 3 Security	AS	Add \$56.00 per cylinder
Access 3 High Security, UL 437	AHS	Add \$79.00 per cylinder
Access 3 IC Patented	ACP	Add \$74.00 per cylinder
Access 3 IC Security	ACS	Add \$123.00 per cylinder
Access 3 IC High Security, UL 437	ACHS	Add \$143.00 per cylinder
Pyramid Security fixed core	PS	Add \$58.00 per cylinder
Pyramid Security IC	PCS	Add \$129.00 per cylinder
Pyramid High Security fixed core	PHS	Add \$86.00 per cylinder
Pyramid High Security IC	PCHS	Add \$158.00 per cylinder
Security	HS	Add \$111.00 per cylinder
Security IC	CHS	Add \$183.00 per cylinder
IC 6-pin	C6	Add \$74.00 per cylinder
IC 6-pin with temporary construction core (Red)	CT6R	Add \$74.00 per cylinder
IC 6-pin with temporary construction core (Blue)	CT6B	Add \$74.00 per cylinder
IC 6-pin with temporary construction core (Green)	CT6G	Add \$74.00 per cylinder
IC 6-pin with temporary disposable core	CT6D	No Charge
IC 6-pin less core	CL6	No Charge
IC 7-pin	C7	Add \$76.00 per cylinder
IC 7-pin with temporary construction core (Red)	CT7R	Add \$76.00 per cylinder
IC 7-pin with temporary construction core (Blue)	CT7B	Add \$76.00 per cylinder
IC 7-pin with temporary construction core (Green)	CT7G	Add \$76.00 per cylinder
IC 7-pin with temporary disposable core	CT7D	No Charge
IC 7-pin less core	CL7	No Charge
Less (1) cylinder	LC	Deduct \$79.00 per cylinder

\*Optional alarm unit cylinder and trim are keyed alike unless otherwise specified. If different keying is required, specify outside cylinder, then inside cylinder.

\*\*6P cylinder option is supplied in 6-pin, L4 keyway, 0-bitted with two nickel silver keys.  
\*\*\* Not available for G10 trim

**Keying Options\***

Description	Specify	Add or Deduct
0-Bitted with 2 blank keys	(standard)	No Charge
Keyed random	KR	No Charge
Master Keyed (all cylinders except (8000, 8020, 8027 IC core)	specify keyset	Add \$16.00 per cylinder
Master Keyed Pyramid	specify keyset	Add \$16.00 per cylinder
Master Keyed Security (including IC cylinder and core)	specify keyset	Add \$16.00 per cylinder
Master Keyed 8000, 8020, 8027 IC core	specify keyset	No Charge
Master Keyed to customer bittings or sample key	specify keyset	Add \$16.00 per cylinder
Construction master keyed <sup>1,2</sup>	CMK	Add \$16.00 per cylinder
Visual key control (VKC)		
- No Stamping	VKC0	\$4.50
- Keys only	VKC1	No Charge
- Cylinders and Keys <sup>3</sup>	VKC2	\$8.00
- Cylinders only <sup>3</sup>	VKC3	\$8.00
Concealed key control (CKC)		
- CKC cylinders with VKC keys	CKC2	\$8.00
- CKC cylinders only <sup>3</sup>	CKC3	\$8.00
More than 2 keys per lock	KY# (e.g., KY6)	See page 66 - Cut Keys Section

**Notes:**

1. CMK Construction master keying charge is in addition to master keying charge.
  2. CMK construction master keying is not available in Pyramid or Security Series.
  3. VKC2, VKC3, CKC3 are not available in Pyramid or Security series.
- \*For key bows other than 10 and 90, specify 'KB' + bow number as Quick Code, e.g. KB12. No extra charge.

**Door Width Options**

Door Width	Specify	Add or Deduct
36"	(standard)	No Charge
30"	W030	
42"	W042	
48"	W048	Add \$35.00 per device

**Door Thickness Options**

Door Thickness	Specify	Add or Deduct
1-3/8" (G10, A6, N6, PR6 Trim only)	D138	No Charge
1-3/4"	(standard)	
2"	D200	
2-1/4"	D214	

**Door Height Options**

Door Height	Specify	Add or Deduct
7'6" (ED8400 devices)	(standard)	No Charge
8'0" (ED8400A devices)	(standard)	
10'0" (ED8400 devices only)	H1000	

**Miscellaneous Options**

Description	Specify	Add or Deduct
Less cylinder with tailpiece for Schlage® cylinder (A6, N6, PR6 designs only)	M06	No Charge
Lever to accept 6- or 7-pin Best-type IC core (SFIC) (N6, PR6 design only)	M08	No Charge
Lever to accept Sargent® cylinder (N6, PR6 design only)	M09	
Lever to accept <i>Schlage</i> IC core (N6, PR6 design only)	M69	
Knurling outside only (trim side)	M21	Add \$69.00 per lockset
Abrasive coat outside and inside (trim and device)	M23	Add \$85.00 per lockset
Abrasive coat inside only (device side)	M24	Add \$43.00 per lockset
Abrasive coat outside only (trim side)	M25	Add \$43.00 per lockset
Less dogging	M51	No Charge
Sex nuts and bolts (SNBs) <sup>1</sup>	M54	No Charge
Mullion Stabilizer	M57	Add \$62.00 per mullion
Shim kit (for vision light)		
- Rim device	M58	Add \$62.00 to device
- Vertical Rod device	M58	Add \$110.00 to device
Shim for 2-3/4" backset on doors with 1/2" stop	M59	Add \$30.00 to device
Exit alarm (for rim devices only)		
- Rim	M61	Add \$572.00 to device
- 1-1/2" hour fire rated rim	M61	Add \$578.00 to device
Exit alarm with delay (for rim devices only)		
- Rim	M62	Add \$601.00 to device
- 1-1/2" hour fire rated rim	M62	Add \$597.00 to device

Note:

1. Not available with D138 option.

**Strike Options\***

Description	Specify	Add or Deduct
Rim strike on ED8200, ED8200B devices	(standard)	No Charge
Fire rated Rim strike on ED8200A devices		
Rim x Vertical Rod strike for pairs of doors	S02	Add \$36.00 to device
Vertical Rod top strike on ED8400 device	(standard)	No Charge
Vertical Rod surface projecting bottom strike on ED8400 device		
Vertical Rod flush bottom strike on ED8400 device	S03	No Charge
Fire rated Vertical Rod top strike on ED8400A device	(standard)	No Charge
Fire rated Vertical Rod bottom strike on ED8400A device	(standard)	No Charge

\*To purchase strike separately, see catalog or parts manual for part no.

**Custom Laser Engraving- LASER**
**Laser engraving processing charge (all engraving types)**

- \$250 net per order. Charge will be applied to production order when placed.

**Single Vanity, Logo or Other (same engraving on all parts)**

- Lever - \$10 net add each
- Mortise Escutcheon - \$10 net add each
- HPSK Paddle - \$10 net add each

**Unique laser engraving (i.e. Room Number, Apartment Number, etc)**

- \$12 net add each (per piece)

**Alarm Kit**

**Ordering Example**

Quantity	Kit Number	Finish	Options
4	ED82AK	689	M62

Function	Description	Finish: 689, 690, 691
ED82AK	Cylinder is not included, M61 option	\$752.00
ED82AK	Cylinder is not included, M62 option	\$752.00

**Removable Mullion (Cylinder not included)**

Cylinder not included

**Ordering Example**

Quantity	Mullion Number
10	508

**Door Height Options**

Door Height	Specify	Price
Up to 8'0" 3 hour fire rated	CR508	\$928.00
Up to 7'2"	CR507	\$665.00
(SFIC) Up to 10'0" (ED8200 only)	CR510	\$797.00
Up to 7'0" Steel Mullion - Panic Rated	CR907	\$661.00
Up to 8'0" Steel Mullion - Panic Rated	CR908	\$671.00
Up to 10'0" (ED8200 only), Steel Mullion - Panic Rated	CR910	\$797.00
Up to 7'0", Steel Mullion - 3 Hour Fire Rated	CR907A	\$918.00
Up to 8'0", Steel Mullion - 3 Hour Fire Rated	CR908A	\$928.00

**Options**

Description	Specify	Price
Up to 7'0", key removable mullion, 1-1/2 Hour Fire Rated	CR907BKM <sup>1</sup>	\$1,414.00
Up to 8'0", key removable mullion, 1-1/2 Hour Fire Rated	CR908BKM <sup>1</sup>	\$1,424.00
Up to 10'0" (ED8200 only), key removable mullion, Panic Rated	CR910KM <sup>1</sup>	\$1,250.00
Door frame filler block for double rabbeted frames	M95	Add \$42.00 per mullion
Door frame angle bracket for aluminum frames	M96	Add \$42.00 per mullion

Note 1: Cylinder and collars not included, specify separately

**Mullions Cylinder Options**

Description	Specify	Add or Deduct
Conventional 6-pin	6P	Add \$86.00 per cylinder
Conventional 7-pin	7P	Add \$88.00 per cylinder
IC 6-pin	C6	Add \$160.00 per cylinder
IC 7-pin	C7	Add \$164.00 per cylinder
Pyramid High Security Fixed Core	PHS	Add \$174.00 per cylinder
Pyramid Security Fixed Core	PS	Add \$144.00 per cylinder
Pyramid High Security IC	PCHS	Add \$244.00 per cylinder
Pyramid Security IC	PCS	Add \$215.00 per cylinder
Security	HS	Add \$197.00 per cylinder
Security IC	CHS	Add \$269.00 per cylinder
IC 6-pin less core	CL6	Add \$86.00 per cylinder
IC 7-pin less core	CL7	Add \$88.00 per cylinder

**DOOR CLOSERS**
**PAGES**
**DC3000 Series:**

DC3000 Series Standard Features	317
DC3000 Series Arm Options, Miscellaneous Options, Brackets, Door Thickness, Drop Plates, Finish Options	318

**DC5000 Series (Cam Action Door Closer):**

DC5000 Series Standard Features	319
DC5000 Series Arm Options, Door Thickness, Handing, Finish Options, Miscellaneous Options, Drop Plate	320

**DC6000 Series:**

DC6000 Series Standard Features	321
DC6200 Series, DC6400 Series	322
DC6000 Series Arm Options, Door Width Options, Finish Options, Door Thickness, Handing	323
DC6000 Series Miscellaneous Options, Blade Stop Spacer, Miscellaneous Brackets, Drop Plates	324

**DC8000 Series:**

DC8000 Series Standard Features	325
DC8200 Series (Factory Pre-Sized)	326
DC8000 Series Arm Options, Door Width Options, Finish Options	327
DC8000 Series Miscellaneous Options, Blade Stop Spacer, Miscellaneous Brackets	328
DC8000 Series Drop Plates	329

**DC46900 Series:**

DC46900 Series Safeguard™ Door Controls: Ordering Example, DC46900 Series, Voltage	330
--	-----

**DC62900 Series:**

DC62900 Series Electromechanical Door Controls: Ordering Example, DC62900 Series, Miscellaneous Options, Voltage	331
Notes	332

**Standard Features**

**Handing**

Non-handed

**Spring Power**

DC3200 Series: Non-sized fully adjustable 1 thru 6.

**Degree of Opening**

Up to 180° opening standard for regular, top jamb and parallel arm mounting.

**Case Quantity**

4

**Case Weight**

42 lbs

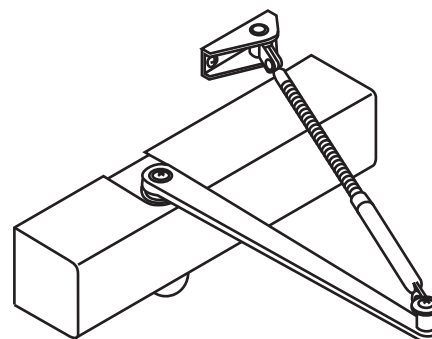

**Ordering Examples**

**Stock Order**

Quantity	Series/Mounting	Finish
48	DC3210	689

**Contract Order**

Quantity	Series/Mounting	Arm	Finish	Option
100	DC3210	A4	689	M54

**DC3200 Series**

Non-sized: full adjustability from sizes 1-6

Function	Description	Finish: 600, 689, 690, 691, 693, 696
DC3200	Regular arm	\$392.00
DC3210	Parallel arm	
DC3220	Top jamb	

DC3210 closers are tri-packed standard (for regular arm, top jamb or parallel arm mounting) unless specialty arm is requested.

**Arm Options**

Description	Specify Quick Code	Add or Deduct
Hold open arm	A1	Add \$67.00 per closer
Heavy-duty parallel arm with hold open	A2	Add \$86.00 per closer
Heavy-duty parallel arm	A3	Add \$43.00 per closer
Heavy-duty parallel arm with backstop	A4	Add \$80.00 per closer
Heavy-duty parallel arm with backstop & hold open	A5	Add \$150.00 per closer
Heavy-duty regular arm	A10	Add \$43.00 per closer

**Miscellaneous Options**

Description	Specify Quick Code	Add or Deduct
Sex nuts and bolts (SNB)	M54	No Charge
Backcheck intensity	(standard)	No Charge
Delayed Action	M71	Add \$42.00 per closer
Full ABS Cover	(standard)	No Charge
Corrosion protection	M75	Add \$40.00 per closer
Heavy-duty parallel arm flush transom bracket (499F30). Used with A2, A3, A4 & A5 arms	M79	Add \$37.00 per closer

**Miscellaneous Brackets**

Description	Specify Quick Code	Add or Deduct
Parallel arm flush transom bracket	M82	Add \$27.00 per closer
Parallel arm offset bracket	M83	Add \$29.00 per closer
Mortise arm bracket for regular arm mounting	M84	Add \$29.00 per closer
Angle Support bracket	M85	Add \$29.00 per closer

**Door Thickness**

Description	Specify
1-3/4"	(standard)

**Drop Plates**

Closer Plates	Old Quick Ship #	Full Cover	List price
DC3210	M80	597F58	\$67.00
DC3220	M80	188F65	\$60.00

**Finish Options**

Description	Add or Deduct
600, 613E, 689, 690, 691, 693, 696, BSP	(standard)

**Standard Features**

**Handing**

Non-handed

**Spring Power**

DC5000 Series: sizes 1 thru 6 fully adjustable.

**Degree of Opening**

110° opening range for Push Side and Pull Side installations.

**Slide Track**

Standard

**Case Weight**

DC5230 8 lbs.

DC5240 8 lbs.



**Ordering Example**

**Stock Order**

Quantity	Series/Mounting	Finish
100	DC5230	689

**Contract Order**

Quantity	Series/Mounting	Arm	Finish
100	DC5240	A1	689



<b>DC5000 Series</b>		
----------------------	--	--

Non-sized: full adjustability from sizes 1-6

Function	Description	Finish: 600, 689, 690, 691, 693, 696
DC5230	Pull Side Track	\$558.00
DC5240	Push Side Track	

<b>Arm Options</b>		
--------------------	--	--

Description	Specify Quick Code	Add or Deduct
Hold open arm	A1	\$34.00

<b>Door Thickness</b>	
-----------------------	--

Description	Specify
1-3/4"	(standard)

<b>Handing</b>	
----------------	--

Description	Specify
Left Hand	LH
Right Hand	RH
Left Hand Reverse	RH
Right Hand Reverse	LH

<b>Finish Options</b>	
-----------------------	--

Description	Add or Deduct
Painted finishes: 600, 689, 690, 691, 693, 696	(standard)

<b>Miscellaneous Options</b>		
------------------------------	--	--

Description	Specify Quick Code	Add or Deduct
Sex nuts and bolts (SNB)	M54	No Charge

<b>Drop Plate</b>		
-------------------	--	--

Description	Part Number	Add or Deduct
Drop Plate (Push side)	754F80	\$46.00

**Standard Features**

**Handing**

Non-handed

**Spring Power**

DC6200 Series: sizes 1 thru 6 non-sized fully adjustable.

DC6400 Series: sizes 1 thru 6 half-size adjustability.

**Degree of Opening**

Up to full 180° opening standard for regular, top jamb and parallel arm applications.

**Case Quantity**

4

**Case Weight**

DC6200 42 lbs

DC6400 42 lbs



**Ordering Example**

**Stock Order**

Quantity	Series/Mounting	Finish
100	DC6210	689

**Contract Order**

Quantity	Series/Mounting	Arm	Finish	Door Thickness
100	DC6406	A6	689	D138

**DC6200 Series**

Non-sized: full adjustability from sizes 1-6

Function	Description	Finish: 600, 689, 690, 691, 693, 696
DC6200	Regular arm	\$431.00
DC6210	Parallel arm	
DC6220	Top jamb	
DC6230	Pull side track**	\$496.00
DC6240	Push side track	

DC6210 closers are tri-packed standard (for regular arm, top jamb or parallel arm mounting) unless specialty arm is requested.  
 \*\*Minimum 3" top jamb required.

**DC6400 Series**

Sized: 1/2-size adjustability

Function	Description	Finish: 600, 689, 690, 691, 693, 696	
DC6401	Regular arm	\$431.00	
DC6402			Size 1
DC6403			Size 2
DC6404			Size 3
DC6405			Size 4
DC6406			Size 5
DC6411	Parallel arm	\$431.00	
DC6412			Size 1
DC6413			Size 2
DC6414			Size 3
DC6415			Size 4
DC6416			Size 5
DC6421	Top jamb	\$431.00	
DC6422			Size 1
DC6423			Size 2
DC6424			Size 3
DC6425			Size 4
DC6426			Size 5
DC6433	Pull side track	\$496.00	
DC6434			Size 3
DC6435			Size 4
DC6436			Size 5
DC6443	Push side track	\$496.00	
DC6444			Size 3
DC6445			Size 4
DC6446			Size 5

Note: See page 323 for plated finishes.

DC641X closers are tri-packed standard (for regular arm, top jamb or parallel arm mounting) unless specialty arm is requested.

**Arm Options**

Description	Specify Quick Code	Add or Deduct
Hold open arm	A1	Add \$67.00 per closer
Heavy-duty parallel arm with hold open	A2	Add \$86.00 per closer
Heavy-duty parallel arm	A3	Add \$43.00 per closer
Heavy-duty parallel arm with backstop	A4	Add \$80.00 per closer
Heavy-duty parallel arm with backstop & hold open	A5	Add \$150.00 per closer
Deep reveal (3-1/4" - 7-1/4")	A6	No Charge
Deep reveal with hold open	A8	Add \$67.00 per closer
Heavy-duty regular arm	A10	Add \$43.00 per closer
Heavy-duty Unitrol®	A11*	Add \$217.00 per closer
Heavy-duty Unitrol® with hold open	A12*	Add \$286.00 per closer
Heavy-duty parallel arm with extra clearance	A13	Add \$35.00 per closer
Heavy-duty friction hold open arm	A14	Add \$85.00 per closer
Push side track with hold open	A1	Add \$67.00 per closer

\* Specify door width

**Door Width Options**

Description	Specify Quick Code	Add or Deduct
A11, A12 door width 28" - 32"	W28	No Charge
A11, A12 door width 33" - 41"	W33	
A11, A12 door width 42" - 48"	W42	

**Finish Options\***

Description	Add or Deduct
	<b>605, 606, 611, 612, 625, 626</b>
Painted finishes: 600, 613E, 689, 690, 691, 693, 696, BSP	(standard)
Plated finishes: specify 605, 606, 611, 612, 625, 626	
Regular, parallel, hold open:	
- Plated arm & cover*	Add \$535.00 per closer
- Plated cover (metal)	Add \$218.00 per closer
- Plated arm*	Add \$317.00 per closer
Heavy-Duty arms (A2, A3, A4, A5, A10, A11, A12, A13, A14) are not available plated. Track & arm for track-type closers are not available plated.	

\*For split finish of closer cover and arm, specify cover first, then arm finish; e.g. DC6200 x 625 x 689.

**Door Thickness**

Description	Specify
1- 3/4"	(standard)
2"	D200

**Handing**

Description	Specify
Left Hand	LH
Right Hand	RH
Left Hand Reverse	RH
Right Hand Reverse	LH

**Miscellaneous Options**

Description	Specify Quick Code	Add or Deduct
Torx® Screws	M04	Add \$32.00 per closer
Sex nuts and bolts (SNB)	M54	No Charge
Backcheck intensity and location valves	(standard)	No Charge
Delayed Action	M71	Add \$42.00 per closer
Full ABS Cover	(standard)	No Charge
Full Metal Cover	M73	Add \$17.00 per closer
Extreme temperature fluid	(standard)	No Charge
Corrosion protection	M75	Add \$40.00 per closer
Security package*	M87	A2-Arm - Add \$125.00 per closer
		A3 Arm - Add \$82.00 per closer
		A4 Arm - Add \$119.00 per closer
		A5 Arm - Add \$189.00 per closer
		A10 Arm - Add \$82.00 per closer

\*M87 includes full metal cover, Torx® fasteners and A2, A3, A4, A5, or A10 arm. Specify arm when ordering.

**Blade Stop Spacer**

Description	Specify Quick Code	Add or Deduct
1/2" spacer (597F92)	M77	Add \$22.00 per closer
5/8" spacer (597F93)	M78	Add \$36.00 per closer

**Miscellaneous Brackets**

Description	Specify Quick Code	Add or Deduct
HD PA flush transom bracket (used with all parallel arms except the Unitrol®)	M79	Add \$37.00 per closer
Parallel arm flush transom bracket	M82	Add \$27.00 per closer
Parallel arm offset bracket	M83	Add \$29.00 per closer
Mortise arm bracket for regular arm mounting	M84	Add \$29.00 per closer
Angle support bracket	M85	Add \$29.00 per closer
Deep Reveal Reinforcement Kit	M103	Add \$29.00 per closer
Flush partition bracket	M104	Add \$24.00 per closer
Lead lined cover (metal cover only)	M108	Add \$173.00 per closer

**Drop Plates**

Closer Plates	Old Quick Ship #	Full Cover	List Price
DC6210, DC6410 (Parallel)	M80	597F58	\$67.00
DC6220, DC6420 (Top Jamb)	M80	188F65	\$60.00
DC6230, DC6430 (Pull Side)	M81	597F59	\$60.00
DC6240, DC6440 (Push Side)	M102	597F59	\$60.00

**Standard Features**

**Handing**

Non-handed

**Spring Power**

DC8200 Series: sizes 1 thru 6 non-sized fully adjustable.

DC8200 Series: sizes 1 thru 6 half-size adjustability.

**Degree of Opening**

Up to full 180° opening standard for regular, top jamb and parallel arm applications.

**Case Quantity**

4

**Case Weight**

DC8200 54 lbs



**Ordering Example**

**Stock Order**

Quantity	Series/Mounting	Finish
100	DC8210	689

**Contract Order**

Quantity	Series/Mounting	Arm	Finish	Door Thickness
100	DC8206	A6	689	D138

**DC8200 Series**

Non-sized full adjustability from sizes 1-6

Function	Description	Finish: 600, 689, 690, 691, 693, 696
DC8200	Regular arm	\$557.00
DC8210	Parallel arm	
DC8220	Top Jamb	
DC8230	Pull side track**	\$621.00
DC8240	Push side track	

DC8210 closers are tri-packed standard (for regular arm, top jamb or parallel arm mounting) unless specialty arm is requested.  
 \*Minimum 3" top jamb required.

**Factory Pre-Sized (available upon request)**

Function	Description		Finish: 600, 689, 690, 691, 693, 696
DC8201	Regular arm	Size 1	\$557.00
DC8202		Size 2	
DC8203		Size 3	
DC8204		Size 4	
DC8205		Size 5	
DC8206		Size 6	
DC8211	Parallel arm	Size 1	
DC8212		Size 2	
DC8213		Size 3	
DC8214		Size 4	
DC8215		Size 5	
DC8216		Size 6	
DC8221	Top Jamb	Size 1	
DC8222		Size 2	
DC8223		Size 3	
DC8224		Size 4	
DC8225		Size 5	
DC8226		Size 6	
DC8233	Pull side track	Size 3	\$621.00
DC8234		Size 4	
DC8235		Size 5	
DC8236		Size 6	
DC8243	Push side track	Size 3	
DC8244		Size 4	
DC8245		Size 5	
DC8246		Size 6	

DC821X closers are tri-packed standard (for regular arm, top jamb or parallel arm mounting) unless specialty arm is requested.

<b>Arm Options</b>		
<b>Description</b>	<b>Specify Quick Code</b>	<b>Add or Deduct</b>
Hold open arm	A1	Add \$67.00 per closer
Heavy-duty parallel arm with hold open	A2	Add \$86.00 per closer
Heavy-duty parallel arm	A3	Add \$43.00 per closer
Heavy-duty parallel arm with backstop	A4	Add \$80.00 per closer
Heavy-duty parallel arm with backstop & hold open	A5	Add \$150.00 per closer
Deep reveal (3-1/4" - 7-1/4")	A6	No Charge
Deep reveal with hold open	A8	Add \$67.00 per closer
Heavy-duty regular arm	A10	Add \$43.00 per closer
Unitrol® arm	A11*	Add \$217.00 per closer
Unitrol arm x hold open	A12*	Add \$286.00 per closer
Heavy-duty parallel arm with extra clearance	A13	Add \$35.00 per closer
Heavy-duty friction hold open	A14	Add \$85.00 per closer
Push side track with hold open	A1	Add \$67.00 per closer
*Specify door width		
<b>Door Width Options</b>		
<b>Description</b>	<b>Specify Quick Code</b>	<b>Add or Deduct</b>
A11, A12 - door width 28" - 32"	W28	No Charge
A11, A12 - door width 33" - 41"	W33	
A11, A12 - door width 42" - 48"	W42	
<b>Finish Options*</b>		
<b>Description</b>	<b>Add or Deduct</b>	
	<b>605, 606, 611, 612, 625, 626</b>	
Painted finishes: 600, 613E, 689, 690, 691, 693, 696, BSP	(standard)	
Plated finishes: specify 605, 606, 611, 612, 625, 626		
Regular, parallel, hold open:		
- Plated arm & cover*	Add \$535.00 per closer	
- Plated cover (metal)**	Add \$218.00 per closer	
- Plated arm*	Add \$317.00 per closer	
Heavy-Duty arms (A2, A3, A4, A5, A10, A11, A12, A13, A14) are not available plated. Track & arm for track-type closers are not available plated.		
*For split finish of closer cover and arm, specify cover first, then arm finish; e.g. DC6200 x 625 x 689. **Price of M73 option is not included.		



**Miscellaneous Options**

Description	Specify Quick Code	Add or Deduct
Torx® Screws	M04	Add \$32.00 per closer
Sex nuts and bolts (SNB)	M54	No Charge
Backcheck valve	(standard)	No Charge
Delayed Action	M71	Add \$42.00 per closer
Full ABS Cover	(standard)	No Charge
Full Metal Cover	M73	Add \$17.00 per closer
Extreme Temperature Fluid	(standard)	No Charge
Corrosion Protection	M75	Add \$40.00 per closer
Security Package*	M87	A2-Arm - Add \$125.00 per closer
		A3 Arm - Add \$82.00 per closer
		A4 Arm - Add \$119.00 per closer
		A5 Arm - Add \$189.00 per closer
		A10 Arm - Add \$82.00 per closer

\*M87 includes full metal cover, Torx® fasteners and A2, A3, A4, A5, A10 or A13. Specify arm when ordering

**Blade Stop Spacer**

Description	Specify Quick Code	Add or Deduct
1/2 " spacer (597F92)	M77	Add \$22.00 per closer
5/8 " spacer (597F93)	M78	Add \$36.00 per closer

**Miscellaneous Brackets**

Description	Specify Quick Code	Add or Deduct
HD PA flush transom bracket (used with all parallel arms except the Unitrol®)	M79	Add \$37.00 per closer
Parallel arm flush transom bracket	M82	Add \$27.00 per closer
Parallel arm offset bracket	M83	Add \$29.00 per closer
Mortise arm bracket for regular arm mounting	M84	Add \$29.00 per closer
Angle support bracket	M85	Add \$29.00 per closer
Deep reveal reinforcement kit	M103	Add \$29.00 per closer
Flush partition bracket (used with Unitrol® arm)	M104	Add \$24.00 per closer
Lead lined cover	M108	Add \$173.00 per closer

**Drop Plates**

Closer Series	Part Number	List Price
DC8200 (regular)	754F20	\$84.00
DC8200 (with concealed holder)	754F24	\$84.00
DC8210 (parallel)	754F25	\$84.00
DC8220 (top jamb)	754F24	\$84.00
DC8230 (pull side track)	754F20	\$84.00
DC8240 (push side track)	754F25	\$84.00

**Safeguard™ Door Controls**

Non-sized closer.  
689 and 690 Finishes.

**Ordering Example**

Quantity	Series/Mounting	Finish	Voltage
10	DC46920	689	24A

**DC46900 Series**

Model	Description	Price
DC46920	Pull side for RH and LH single doors and pair of doors	\$1,297.00
DC46925	Push side for LHR double egress doors	
DC46928	Pull side holder body with push side closer for reverse bevel doors	

**Voltage**

Description	Specify Quick Code
24VAC	24A
24VDC	24D
120VAC	120A

**Electromechanical Door Controls**

Sex nuts and bolts are furnished standard.  
 689 Finish.

**Ordering Example**

Quantity	Series/Mounting	Finish	Voltage	Options
24	DC62930	689	24A	M54

**DC62900 Series**

Model	Quick Code	Description	Finish: 600, 689, 690, 691, 693, 696
DC62930	ETD	Pull Side	Master Unit
DC62930	ET		Support Unit
DC62940	ETD	Push Side	Master Unit
DC62940	ET		Support Unit

**Miscellaneous Options**

Description	Specify Quick Code	Add or Deduct
Torx® machine screws	M04	Add \$32.00 per closer
Sex nuts and bolts		
- DC62930	(standard)	(standard)
- DC62940	(standard)	(standard)
Backcheck intensity valve	M70	Add \$33.00 per closer

**Voltage\***

Description	Specify Quick Code
24VAC	24A
24VDC	24D
120VAC	120A

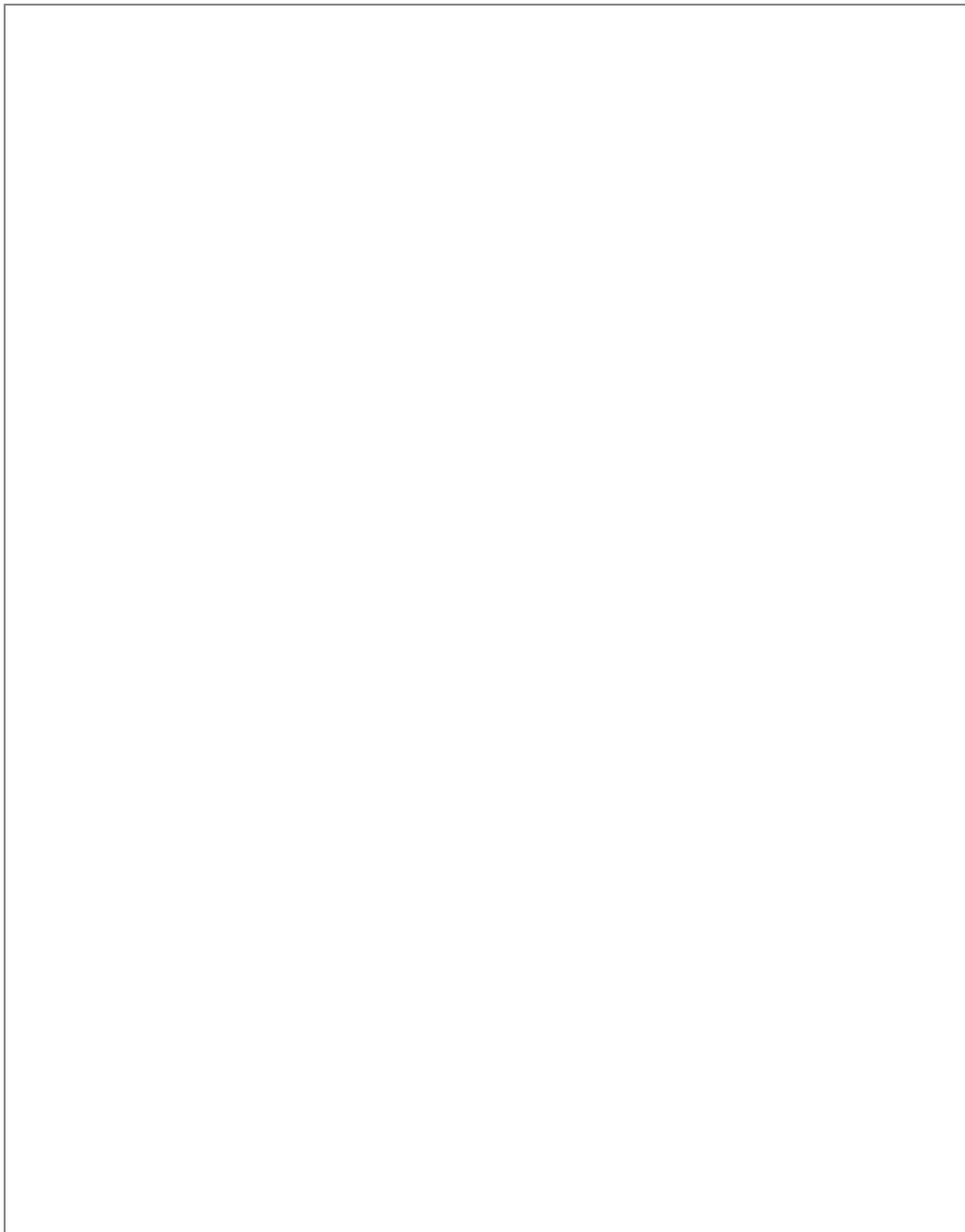

# Parts Price List

Number 32  
Effective January 1, 2019



PARTS	PAGES
<b>Key Systems</b>	
Plugs and Shells	334
Cylinder Parts	335-336
Standard Diameter Cylinder Collars	337
Master Ring Cylinder Collars	338
Tools	338
<b>Mortise Locksets and Trim</b>	
ML2000 – Mortise Locks	339 - 341
ML2000 – Mortise Trim	342 - 350
<b>Vandal Resistant Cylindrical Lever Locksets</b>	
CL3100 Series	351 - 353
<b>Extra Heavy-Duty Cylindrical Lever Locksets</b>	
CL3300 Series	354 - 356
<b>Heavy-Duty Cylindrical Lever Locksets</b>	
CL3500 Series	357 - 358
<b>Grade 2 Key-In-Lever</b>	
CL3700 Series	358
CL3800 Series	359 - 360
<b>Heavy-Duty Cylindrical Knob Locksets</b>	
CK4300 Series	361
<b>Standard-Duty Cylindrical Knob Locksets</b>	
CK4400 Series	362
CK4700 Series	362
<b>Pre-Assembled Unit Locksets</b>	
UT5200 Series	363 - 364
<b>Padlocks, Deadlocks and Push-Pull Latches</b>	
Padlocks	364
DL3000 Series Deadlocks	364
<b>ED4000 and ED5000 Series</b>	
Device Parts	365 - 367
Trim Parts	367 - 369
<b>Crossbar Exit Devices and Trims</b>	
ED7000 Series	370 - 374
<b>Pushpad Exit Devices and Trims</b>	
ED8000 Series	375 - 376
<b>Door Closers</b>	
DC3000/DC5000 Series	377
DC6000 Series	378
DC8000 Series	379
<b>Electronic Hardware Parts</b>	
DC46900 Series	380
DC62900 Series	380
Access 800® AC2 Series	380
<b>Part Number Index</b>	<b>381 - 392</b>

**PLUGS AND SHELLS**

**6-PIN PLUGS, BULK PACKS**

606, 626

PART NO.	DESCRIPTION	LIST PRICE
----------	-------------	------------

These packages are priced at a savings over individual plug prices. Keyway availability is limited to L4, D1, H1, 60, 59A1 and 981.

492K90	25 Pack for 1-1/8" Mortise	\$715.00
492K91	25 Pack for 3000 Rim	
492K92	50 Pack for CK4200, UT5200	\$1,430.00
610K48	50 Pack for CL3300	

**5- AND 6-PIN INDIVIDUAL PLUGS**

X CLASS	STANDARD	USED IN	LIST PRICE
487K10	121K10	1" Mortise (5-pin)	\$36.00
487K11	121K11	1-1/8" Mortise	
606K73	193K09	3-1/4" Mortise	\$64.00
606K74	193K10	3-1/2" Mortise	\$66.00
606K75	193K11	3-3/4" Mortise	\$68.00
487K38	197K51*	1001 Hotel Mortise	\$38.00
559K94	464K97	1004 Brink Mortise	\$40.00
559K95	468K87	1005 Brink Mortise	
488K99	488K98	CK4200, UT5200 (.552") and 2000051	\$36.00
564K53	574K05	CK4400, except below	\$45.00
564K60	564K52	CK4429 Hotel, old tailpiece	
564K59	579K14	CK4429, new tailpiece	
580K99	574K07	CK4455, CK4482, before 8/93	
596K29	585K24	CL3300, CL3500, CL3600, CL3700, CL3800	\$36.00
596K31	585K26	CL3329, CL3629 Hotel	\$47.00
489K49	186K75	2001051 (1429/3433EM)	\$47.00
534K25	245K37	2100/2160 (large head)	\$45.00
612K90	444K87	2200001 and 009	
612K91	444K89	2200002	
612K88	444K94	2200008	
612K93	444K88	2200054	
612K94	523K21	2200076	\$36.00
488K84	253K66	3000 Rim Cylinder	
610K46	146K80	4200002 for AR Pull	\$45.00
	195K68	4266 for MR Exit Operators	\$54.00
334K01	334K00	80006 Interchangeable Core	\$36.00
n/a	378K18	Fox Police Rim Cyl. (5-pin)	\$54.00

**7-PIN PLUGS**

606, 626

X CLASS	STANDARD	USED IN	LIST PRICE
---------	----------	---------	------------

487K13	292K95	1-1/4" Mortise	\$38.00
487K15	292K96	1-3/8" Mortise	
487K17	292K97	1-1/2" Mortise	
487K19	292K98	1-3/4" Mortise	\$50.00
487K21	292K99	2" Mortise	\$53.00
606K76	293K00	2-1/4" Mortise	
606K77	293K01	2-1/2" Mortise	
606K78	293K02	2-3/4" Mortise	
606K79	293K03	3" Mortise	\$55.00
596K30	585K25	CL3300 Non-Hotel	\$46.00
596K32	585K27	CL3329 Hotel	\$50.00
488K85	253K67	3000-7 Rim Cylinder	\$38.00
416K08	416K07	8000-7 Core	\$46.00

**SECURITY PLUGS (USE IN SECURITY SHELLS ONLY)**

PART NO.	DESCRIPTION	LIST PRICE
407K63	1-1/8" Mortise	\$55.00
407K64	1-1/4" and 1012 (Blockout)	
415K73	1-3/8" Mortise	\$61.00
415K74	1-1/2" Mortise	
518K73	1-3/4" Mortise	\$71.00
518K74	2" Mortise	\$74.00
518K75	2-1/4" Mortise	
518K76	2-1/2" Mortise	\$76.00
518K77	2-3/4" Mortise	
409K12*	1011 Mortise Hotel	\$55.00
481K19	1014 Brink Mortise	\$57.00
481K28	1015 Brink Mortise	
408K45	CK4200, UT5200	\$50.00
585K46	CL3300 Non-Hotel	\$61.00
444K97	2210001 and 009	\$61.00
444K98	2210002	\$55.00
444K96	2210008	\$61.00
444K99	2210054	\$55.00
407K65	3010 Rim Cylinder	\$50.00
483K01	3012 Rim (Blockout)	\$59.00
446K68	8010 Interchangeable Core	\$46.00

**PYRAMID STANDARD PLUGS**

696K43	Used with 1020	†Order 10-	\$50.00
798K912 x Fin	Used with 1020112	†Order 10-	
696K45	Used with 3020	†Order 10-	
696K46	Used with 2020	†Order 10-	
696K48	Used with 2020	†Order 10-	
696K52	Used with 8020, 8027	†Order 10-	
715K14	Used with 2220	†Order 10-	\$50.00

**PYRAMID SECURITY PLUGS**

716K43	Used with 1027	†Order 10-	\$50.00
798K922 x Fin	Used with 1027112	†Order 10-	
716K45	Used with 3027	†Order 10-	
716K46	Used with 2027 KIL	†Order 10-	
716K48	Used with 2027 KIK	†Order 10-	
716K16	Used with 2227	†Order 10-	

**PYRAMID SIDE PIN PLUGS**

628K852 x Fin	Used with 1020114	†Order 10-	\$50.00
628K972 x Fin	Used with 1020112	†Order 10-	
628K872 x Fin	Used with 3020	†Order 10-	
628K902 x Fin	Used with 2020052	†Order 10-	
628K882 x Fin	Used with 202003x	†Order 10-	
628K952 x Fin	Used with 2220	†Order 10-	
629K032 x Fin	Used with 8020, 8027	†Order 10-	\$50.00
628K992 x Fin	Used with 1027114	†Order 10-	
630K472 x Fin	Used with 1027112	†Order 10-	
629K002 x Fin	Used with 3027	†Order 10-	
629K022 x Fin	Used with 2027052	†Order 10-	
629K012 x Fin	Used with 202703x	†Order 10-	
629K042 x Fin	Used with 2227	†Order 10-	\$50.00

**6-PIN LOADED SHELLS, BULK PACKS**

Finishes available for rim and mortise shells: 605, 606, 612, 613, 625, 626

493F76	25 Pack for 1000118 Mortise	\$1,334.00
677F42	25 Pack for 1000114 Mortise	
493F77	25 Pack for 3000 Rim	
493F78	50 Pack for CK4200, UT5200	\$1,334.00
610F49	50 Pack for CL3300, CL3700	

\*Not available in D1, D2, L1, L2, 752, 852 or A class keyways.  
†Sold only in multiples of the number indicated. Price is each.



**CYLINDER PARTS**

PART NO.	DESCRIPTION	LIST PRICE	SOLD IN MULT. OF	PART NO.	DESCRIPTION	LIST PRICE	SOLD IN MULT. OF		
<b>PYRAMID SHELLS</b>				<b>SECURITY MASTER PINS</b>					
695F042 x Fin	Used with 1020114, 1027114, 3020058, 3027058	\$65.00	10+	407T314097	2L	\$4.50	20+		
695F052 x Fin	Used with 3020, 3027 (Slotted)			407T324097	2R				
696F502 x Fin	Used with 8020, 8027			407T334097	2S				
696F472	Used with 202052, 2027 (KIL))			407T314125	3L				
696F499	Used with 2020, 2027 (KIK)			407T324125	3R				
715F152	Used with 2220, 2227	\$57.00		407T334125	3S				
<b>PYRAMID SHELLS - SIDE PINS</b>				<b>SECURITY TOP PINS</b>					
628F922 x Fin	Used with 8020, 8027	\$57.00	10+	407T314153	4L	\$4.50	20+		
629F062 x Fin	Used with 1020114, 1027114, 3020058, 3027058			407T324153	4R				
630F482 x Fin	Used with 1020112, 1027112			407T334153	4S				
628F912	Used with 202052, 2027052			407T434193	Size 1 Long				
628F892	Used with 2020, 2027 (Levers)			407T434158	Size 2 Short				
628F962	Used with 2220, 2227 (Competitors)	\$57.00		<b>BUMP-RESISTANT TOP SPOOL PINS (VIAL OF 100 PINS)</b>					
629F072 x Fin	Used with 3020, 3027 (Slotted)	\$56.00		628F107171	Conventional	\$44.00	1		
<b>PYRAMID SIDE PINS (VIAL OF 20 PINS)</b>				<b>SPRINGS AND SPRING COVERS</b>					
630F494	Pyramid Side Pins - Vial Of 20 Pins	\$17.00		603F207	Spring, security and convent	\$0.20	100+		
<b>PYRAMID HIGH SECURITY PINS (VIAL OF 100 PINS)</b>				026F757	Spring, hotel mortise blocking pin				
<b>TOP PINS</b>				585F327	Spring, cylinder cap pin for 2000034 type	\$0.30	100+		
695F257031 - .031"	695F257173 - .173"	\$45.00	1	314F987	Spring for 2001034 indicator	\$0.20	100+		
695F257047 - .047"	695F257189 - .189"			217F422	Spring Cover, 5-pin brass	\$0.40	100+		
695F257063 - .063"	695F257204 - .204"			217F442	Spring Cover, 6-pin brass	\$0.40	100+		
695F257078 - .078"	695F257220 - .220"			314F887	Spring Cover, 6-pin stainless for most 2000 Series	\$0.60	50+		
695F257094 - .094"	695F257236 - .236"			217F432	Spring Cover, 7-pin brass	\$0.30	100+		
695F257110 - .110"	695F257252 - .252"			585F397	Spring Cover for 20000347	\$2.00	10+		
695F257126 - .126"	695F257267 - .267"			171F468	Spring for 1100 Series Cyl. Head	\$0.20	100+		
695F257141 - .141"	695F257283 - .283"			697F507	Spring for all Pyramid Cyls	\$0.20	100+		
695F257157 - .157"	695F257299 - .299"			<b>ACCESS 3 PINS (VIAL OF 100 PINS)</b>					
<b>BOTTOM PINS</b>				<b>Bottom Pins (BP)</b>					
695F247139 - .139"	695F247218 - .218"	\$45.00	1	763F002243	Bottom AP-1	\$23.00	1		
695F247155 - .155"	695F247234 - .234"			763F002273	Bottom AP-2				
695F247171 - .171"	695F247250 - .250"			763F002303	Bottom AP-3				
695F247187 - .187"	695F247265 - .265"			763F002333	Bottom AP-4				
695F247202 - .202"	695F247281 - .281"			763F002363	Bottom AP-5				
				763F002393	Bottom AP-6				
<b>PYRAMID SECURITY PINS (VIAL OF 100 PINS)</b>				<b>Master Pins (MP)</b>					
<b>TOP PINS</b>				763F012030	Master AP&AS-1	\$23.00	1		
695F252031 - .031"	695F252173 - .173"			763F012060	Master AP&AS-2				
695F252047 - .047"	695F252189 - .189"			763F012090	Master AP&AS-3				
695F252063 - .063"	695F252204 - .204"	763F012120	Master AP&AS-4						
695F252078 - .078"	695F252220 - .220"	763F012150	Master AP&AS-5						
695F252094 - .094"	695F252236 - .236"	<b>Top Pin - Bump Resistant</b>							
695F252110 - .110"	695F252252 - .252"	763F027120	Top-Spool AP-4	\$44.60	1				
695F252126 - .126"	695F252267 - .267"	763F027150	Top-Spool AP-5						
695F252141 - .141"	695F252283 - .283"	763F027180	Top-Spool AP-6						
695F252157 - .157"	695F252299 - .299"	763F027210	Top-Spool AP-7						
<b>BOTTOM PINS</b>						763F027240	Top-Spool AP-8		
695F244139 - .139"	695F244218 - .218"	763F027270	Top-Spool AP-9						
695F244155 - .155"	695F244234 - .234"	<b>Top Pin</b>							
695F244171 - .171"	695F244250 - .250"	763F012180	Top AP-6	\$23.00	1				
695F244187 - .187"	695F244265 - .265"	763F012210	Top AP/BU-7						
695F244202 - .202"	695F244281 - .281"	763F012240	Top AP/BU-8						
		763F012270	Top AP/BU-9						
<b>PINS (SPECIFY SIZE WHERE APPROPRIATE)</b>				<b>Build Up Pins (BU)</b>					
553F484 x length	Vial of 100 bottom pins (L Pins)	\$23.00	1	763F012300	BU-10	\$23.00	1		
553F502 x length	Vial of 100 spool top pins (J Pins)			763F012330	BU-11				
553F492 x length	Vial of 100 top pins (= master & Bu) (M Pins)			<b>CMK Wafer</b>					
546F978	Vial of 1500 construction balls	\$20.00	1	763F072	CMK Wafer	\$41.00	1		
197F527	Pin, blocking of 1001, 1011 (hotel)	\$2.00	50+	<b>SECURITY BOTTOM PINS</b>					
159F367	Ball bearing for wear resistance	\$2.00	100+	407T414242	2L	\$4.50	20+		
<b>SECURITY BOTTOM PINS</b>				407T424242	2R				
407T414242	2L	\$4.50	20+	407T414270	3L				
407T424242	2R			407T424270	3R				
407T414270	3L			407T414298	4L				
407T424270	3R			407T424298	4R				
407T414298	4L			407T414326	5L				
407T424298	4R			407T424326	5R				
407T414326	5L			407T414354	6L				
407T424326	5R			407T424354	6R				
407T414354	6L								
407T424354	6R								

†Sold only in multiples of the number indicated. Price is each.

**CYLINDER PARTS (CONT'D)**

PART NO.	DESCRIPTION	LIST PRICE	SOLD IN MULT. OF
<b>CAMS – CONVENTIONAL AND SECURITY</b>			
756F507	A01 Cloverleaf	\$5.50	10†
756F517	A02 Straight	\$5.50	10†
756F527	A03	\$5.50	10†
756F537	A04	\$5.50	10†
756F542	A05 AR4070	\$5.50	5†
756F557	A06	\$5.50	10
756F567	A07	\$6.50	10
756F582	A62	\$16.50	10
756F622	A92	\$4.50	10†
281F272	A93	\$8.50	10†
406F438	Cam for O5 Exit trim	\$11.00	1
<b>CAMS - LFIC VERSION</b>			
756F507	A01 Cloverleaf	\$5.50	10†
756F517	A02 Straight	\$5.50	
756F527	A03		
756F537	A04		
756F542	A05 AR4070	\$5.50	5†
756F557	A06	\$5.50	10
756F567	A07	\$6.50	10
756F582	A62 Straight	\$16.50	10
756F622	A92	\$4.50	10
362F432	A93	\$8.50	10†
<b>MASTER RING</b>			
562F402	A61 New Cloverleaf (locks after 5/93)	\$4.50	10†
756F582	A62 Straight	\$16.50	10†
121F012	A63	\$4.50	5†
135F192	A64	\$7.50	5†
025F722	A65 Old Cloverleaf (was 11A)	\$5.50	5†
<b>TAILPIECES</b>			
444F748	A21	\$2.00	20†
461F108	A22	\$2.50	10†
520F358	A23	\$4.50	10†
444F758	A24	\$2.50	10†
365F968	A38 (Fox square)	\$3.50	5†
329F998	A39 (Fox round)	\$6.00	5†
484F958	A41	\$2.50	10†
484F928	A42		
484F918	A43	\$2.00	20†
484F968	A44	\$4.00	10†
484F938	A45	\$3.00	10†
484F948	A46	\$4.00	10†
146F788	A47	\$14.50	1
585F337	For 20010346	\$2.00	20†
585F358	For 20010347	\$3.00	10†
622F298	For 20000346	\$3.50	10†
596F898	For 2000038		
622F308	For 20000336, 20000347	\$2.00	20†
489F028	For 2000051		
682F298	For 20000337	\$2.00	20†
186F748	For 2001051	\$2.00	20†
622F328	For 2400033	\$6.50	1
682F398	For 2400034		
685F098	For 2400037		
616F208	For 2400039	\$7.50	1
616F218	For 2400039L		
490F558	For 3000138	\$3.50	10†
253F768	For 3000200	\$2.00	20†
413F488	For 3000200V	\$3.50	10†
253F778	For 3000312	\$2.00	20†
413F498	For 3000312V	\$3.50	10†
582F298	For 3080114 for exit alarm options M61 & M62	\$4.00	10†
253F858	For 3080178	\$4.00	10†
284F138	For 3080318	\$3.00	10†
599F389	Kit for Sargent® in CL3600	\$9.50	1
601F229	Kit for Sargent in CL3400	\$10.00	1
622F328	For Schlage® cyl. in CL3400/CL3600	\$7.00	5†
715F108	P21	\$5.00	10†
715F118	P22		
715F128	P23		

PART NO.	DESCRIPTION	LIST PRICE	SOLD IN MULT. OF
<b>RETAINERS</b>			
173F798	.020" Plug Retainer-3300/5600,1400/4300	\$2.00	50†
368F918	.030" Plug Retainer-3000 and 3010 rim cylinders	\$2.00	20†
488F928	.032" Plug Retainer-2000052, 044 and 051	\$2.00	20†
333F998	Plug Retainer, LFIC, CK4400, 2200008, 2020 KIK	\$2.00	100†
334F238	Retainer, LFIC rim tailpiece	\$4.00	10†
365F958	Retainer, Fox Police rim cylinder	\$5.00	10†
250F088	Retainer for flex head cylinder	\$2.00	100†
680F645	Cap for 2000033, 034	\$4.50	10†
585F312	Cap Pin for 2000034	\$2.00	100†
219F888	Plug Retainer for 2060052	\$2.00	100†
<b>LFIC THROW MEMBERS</b>			
715F892	CK4200, UT5200	\$4.00	1
320F442	CK4200, UT5200 Best® knob	\$6.00	1
622F728	CL3400, CL3600 Series packet (before 6/2000) straight	\$4.50	10†
682F918	CL3300, CL3600 series packet (after 6/2000) twisted	\$6.00	10†
379F805	Used with 1030134, 1037134	\$41.00	1
628F825	Used with 1030114, 1037114, 1030138, 1037138, 3030, 3037	\$13.00	1
628F835	Used with 1030112, 1037112	\$16.00	1
362F153	Padlock	\$8.50	10†
<b>OTHER LFIC PARTS</b>			
353F868	Inner cam for 1071 (hotel)	\$8.50	5†
446F572	Control Sleeve for 8000 core	\$15.00	5†
446F582	Control Sleeve for 8010 core	\$18.00	5†
438F428	Mortise Cylinder Cam Screw	\$2.00	100†
334F128	Mortise Cylinder Cam Plate	\$2.50	20†
622F698	Security disk for CL3400, CL3600		
607F919	Spacer for 6-pin Best type core		
<b>OTHER MASTER RING CYLINDER PARTS</b>			
522F932	Adapter Bushing for MR	\$75.00	1
135F108	Backplate, MR rim	\$4.50	10†
158F062	Cam Spacer for A61, A62, A65	\$2.00	20†
700F575	Thumbturn Hub for A61 MR cam	\$33.00	1
562F422	Kit, A61 cam / hub conversion		
488F108	Mortise Cylinder Set Screw Pkt	\$2.50	20†
354F198	Thumbturn disk, A64 cam	\$88.00	1
197F357	Wave Washer for collar	\$4.50	10†
<b>OTHER MORTISE/RIM CYLINDER PARTS</b>			
253F758	Backplate, rim cylinder	\$2.00	20†
438F418	Cam Screw	\$2.00	100†
488F088	Mortise Cylinder Set Screw Pkt	\$2.00	20†
021F688	Screw, rim cyl. mounting, 2-9/32"	\$2.00	20†
021F718	Screw, rim cyl. mounting, 3-1/8"	\$4.50	10†
197F347	Wave Washer for collar	\$3.50	20†
129F848	Cylinder Nut	\$7.50	1
310F488	Thumbturn Disk, A02 cam	\$37.00	1
<b>OTHER KNOB/LEVER CYLINDER PARTS</b>			
596F879	Obsolete by new design		
585F387	2001034 Indicator fork	\$2.00	20†
585F377	2001034 Stabilizer Pin	\$2.50	20†
314F997	20010346 Indicator Pin	\$4.50	20†
585F407	20010347 Indicator Pin	\$7.50	1
585F367	Tailpiece Anchor, 2001034	\$2.00	20†
041F478	Key, hotel shut-out		
<b>PYRAMID CYLINDER PARTS</b>			
696F42	Blocking plate	\$4.50	20†
697F50	Tumbler spring	\$2.00	100†
217F43	Spring cover	\$2.00	100†
217F44	LFIC Spring cover	\$2.00	100†
696F51	Control sleeve	\$27.00	10†
628F932	Control sleeve - Used with 8020, 8027	\$29.00	10

†Sold only in multiples of the number indicated. Price is each.

## ASSA ABLOY

### STANDARD DIAMETER CYLINDER COLLARS

PART NO.	DESCRIPTION	LIST PRICE	SOLD IN MULT. OF	PART NO.	DESCRIPTION	LIST PRICE	SOLD IN MULT. OF
<b>STAMPED COLLARS</b>				<b>SOLID, RECESSED FOR CYLINDER HEAD (Cont'd)</b>			
253F97	Spring collar 605, 606, 612, 613, 618, 619, 622, 625, 626	\$7.00	10†	654F08	.556" for ED4000/ED5000 605, 606, 611, 612, 613, 622, 625, 626, 629, 630	\$24.00	1
428F66	2-Piece (was 574 1/2, H) 605, 606, 612, 613, 618, 619, 622, 625, 626	\$11.50	5† 1	609F37	.650" 605, 606, 611, 612, 613, 618, 619, 625, 626	\$34.00	1
549F52	.219" Straight (was 154 1/2, H1) 605, 606, 612, 613, 618, 619, 622, 625, 626	\$7.00	10†	609F38	.850" 605, 606, 611, 612, 613, 618, 619, 625, 626	\$34.00	1
605F43	.350 Tapered spring collar 605, 606, 612, 613, 618, 619, 622, 625, 626	\$7.00		134F05	With lip, .510" ED7400, ED7800 605, 606, 611, 612, 613, 618, 619, 622, 625, 626	\$34.00	1
<b>SPACER FOR FLEXIBLE HEAD CYLINDER</b>				<b>OTHER CYLINDER COLLARS</b>			
370F29	.125" (1/8")	\$38.00	1	416F39	Security .172" (was 95) 605, 606, 611, 612, 613, 618, 619, 625, 626	\$24.00	1
370F31	.250" (1/4")	\$38.00	1	303F25	Solid .312" (was 571/J) 605, 606, 611, 612, 613, 618, 619, 625, 626	\$33.00	1
252F82	.312" (5/16")	\$38.00	1	<b>RIM CYLINDER COLLARS</b>			
447F41	.031" (was 575 1/4, 910) 605, 606, 612, 613, 618, 619, 622, 625, 626	\$18.00	1	<b>Flush Mount (was 151/ R1290)</b>			
270F15	.156" 605, 606, 612, 613, 618, 619, 622, 625, 626	\$24.00	1	255F53	605, 606, 611, 612, 613, 618, 619, 622, 625, 626	\$18.00	10† 10† 1
447F42	.172" (was 575 3/8, 9106) 605, 606, 612, 613, 618, 619, 622, 625, 626	\$18.00	1	<b>Surface Mount</b>			
610F01	.221" (was 5574 3/4, C) 605, 606, 612, 613, 618, 619, 622, 625, 626	\$30.00	1	422F88	605, 606, 611, 612, 613, 618, 619, 622, 626, 625	\$18.00	5† 1
610F02	.289" (was 5574 1/4, L) 605, 606, 611, 612, 613, 618, 619, 625, 626	\$30.00	1				
654F07	.356" for ED4000/ED5000 605, 606, 611, 612, 613, 622, 625, 626, 629, 630	\$24.00	1				
447F43	.375" (was 575 9/16, 9109) 605, 606, 611, 612, 613, 618, 619, 625, 626	\$18.00	1				
609F36	.500" 605, 606, 611, 612, 613, 618, 619, 625, 626	\$32.00	1				

†Sold only in multiples of the number indicated. Price is each.

**MASTER RING CYLINDER COLLARS**

PART NO.	DESCRIPTION	LIST PRICE	SOLD IN MULT. OF
<b>SOLID, RECESSED FOR CYLINDER HEAD</b>			
447F44	<b>.031" (was 576 1/4, MR910)</b>	\$24.00	1
	605, 606, 611, 612, 613, 618, 619, 625, 626		
447F45	<b>.172" (was 576 3/8, MR9106)</b>	\$28.00	1
	605, 606, 611, 612, 613, 618, 619, 625, 626		
447F46	<b>.375" (was 576 9/16, MR9109)</b>	\$32.00	1
	605, 606, 611, 612, 613, 618, 619, 625, 626		
<b>SPACERS FOR FLEXIBLE HEAD CYLINDERS</b>			
366F70	.090" tapered	\$11.50	5
370F33	.094"		
370F35	.281"	\$11.50	1
<b>RIM CYLINDER COLLARS</b>			
255F54	<b>(was 151 3/4, T)</b>	\$18.00	1
	605, 606, 612, 613, 619, 625, 626		

PART NO.	DESCRIPTION	LIST PRICE
<b>CYLINDER SERVICE TOOLS</b>		
See main price book		
<b>LOCKSET INSTALLATION TOOLS</b>		
574F158	CK4400 Series Knob Removal Tool	\$2.50
506F57	CK4400 Series Knob Cover Removal Tool	\$7.00
391F658	Knob Release Tool, CK4200, ML2200 †Order 100-	\$2.00

## ASSA ABLOY

PART NO.	DESCRIPTION	LIST PRICE
<b>ARMORED FRONT</b>		
Finish: 605, 606, 611, 612, 612, 613, 619, 625, 626, 629**, 630**		
<b>Deadbolt</b>		
079F00	Armored front, 1-1/4" standard	\$35.00
079F02	Armored front, 1-1/8"	
<b>Deadbolt, latchbolt, aux. latch, toggle</b>		
402F29	Armored front, 1-1/4" standard	\$35.00
402F33	Armored front, 1-1/8"	
<b>Deadbolt, latchbolt, auxiliary latch</b>		
402F30	Armored front, 1-1/4" standard	\$35.00
402F34	Armored front, 1-1/8"	
<b>Deadbolt, latchbolt, toggle</b>		
402F31	Armored front, 1-1/4" standard	\$35.00
402F35	Armored front, 1-1/8"	
<b>Latchbolt, auxiliary latch, toggle</b>		
681F31	Armored front, 1-1/4" standard	\$35.00
681F30	Armored front, 1-1/8"	
681F41	LHB, 1-1/4"	
681F40	LHB, 1-1/16"	
<b>Blank Front</b>		
720F43	Armored front, 1-1/4"	\$35.00
720F46	Armored front, 1-1/16"	
<b>Filler Plate</b>		
334F998	USP Filler, 8" x 1-1/4"	
<b>Deadbolt, latchbolt</b>		
423F54	Armored front, 1-1/4" standard	\$35.00
423F57	Armored front, 1-1/8"	
<b>Latchbolt only</b>		
423F55	Armored front, 1-1/4" standard	\$35.00
423F58	Armored front, 1-1/8"	
<b>Latchbolt, auxiliary latch</b>		
624F49	Armored front, 1-1/4" standard	\$35.00
624F53	Armored front, 1-1/8"	

PART NO.	DESCRIPTION	LIST PRICE
<b>AUXILIARY LATCH</b>		
403F677	Auxiliary latch	\$16.00
<b>AUXILIARY LATCH LEVER</b>		
678F548	Auxiliary latch lever	\$5.50
<b>Auxiliary Latch Lever Spring</b>		
678F677	Auxiliary latch lever spring. †Order 100-	\$2.00
<b>CAP</b>		
700F278	Cap	\$24.00
<b>CASE &amp; FRONT SA</b>		
820F268 = 1-1/4" - STD		\$76.00
820F278 = 1-1/4" - ML2060/68		
820F348 = 1-1/8" - STD		
820F358 = 1-1/8" - ML2060/68		
<b>CYLINDER LATCH LEVER SA</b>		
701F748	Cylinder latch lever	\$2.00
753F098	Cylinder latch lever (functions 72, 73, 75 )	
<b>CYLINDER LATCH LEVER STOP</b>		
705F949	Cylinder latch lever stop	\$2.50
<b>CYLINDER SET SCREW BRACKET</b>		
402F738	Cylinder set screw bracket	\$5.50
<b>DEADBOLT</b>		
702F987	Deadbolt	\$41.00
753F697	Deadbolt ML2072	
<b>DEADBOLT SPRING</b>		
701F228	Deadbolt spring †Order 50-	\$2.00
<b>DEADLOCKING LEVER</b>		
602F198	Toggle Functions	\$4.00
624F488	Non-Toggle Functions	
<b>DEADLOCKING LEVER SPRING</b>		
700F907	Deadlocking lever spring	\$2.00
<b>FIXED STOP</b>		
684F559	Fixed stop	\$4.50
<b>HUB ALIGNMENT BRACKET</b>		
404F868	Hub alignment bracket	\$6.00
<b>HUB ALIGNMENT BRACKET SCREW</b>		
269F088	FHUM-PH #8-32 X 3/8" Screw †Order 20-	\$2.00
<b>HUB LEVER</b>		
820F008	Non Panic Egress	\$5.50
820F148	Panic Egress	

†Sold only in multiples of the number indicated. Price is each.  
 \*\*618, 619 finish provided to match 629, 630.

PART NO.	DESCRIPTION	LIST PRICE
<b>HUB LEVER SPRING</b>		
820F048	Hub lever spring †Order 10-	\$2.00
<b>HUB SPACER</b>		
684F119	Hub spacer	\$2.00
<b>KNOB HUB</b>		
820F088	Cap Side	\$21.00
820F168	Case Side	
<b>LATCHBOLT</b>		
688F177	Latchbolt	\$47.00
<b>LATCH LEVER SPRING</b>		
700F957	Latch lever spring	\$2.00
<b>LEVER HUB</b>		
820F068	Cap side	\$13.00
820F078	Case side	
<b>LEVER RETURN SPRING</b>		
404F858	Lever return spring †Order 20-	\$2.00
<b>LOCKING LEVER</b>		
852F307	ML2017 Locking Lever	\$23.00
852F318	ML2017 Spring	
<b>OCCUPANCY INDICATOR, ML2029</b>		
<b>605, 606, 611, 612, 613, 618, 619, 625, 626</b>		
416F84	1-3/4" door, sectional	\$82.00
429F08	1-3/8" door, sectional	\$82.00
484F74	2-1/4" door, sectional	\$82.00
416F49	Escutcheon trim - 1-3/4" door	\$63.00
<b>RETAINING RING</b>		
436F177	Retaining ring †Order 100-	\$2.00
<b>SCREW PACKETS</b>		
<b>Finish: 606, 612, 613, 619</b>		
429F41	Mounting screw pack, standard	\$4.50
488F09	Mounting screw pack, MR option	\$7.50
465F57	Mounting screw pack, M04 (VR)	\$24.00
616F12	Mounting screw pack, MR x M04	
<b>SPACER</b>		
466F229	Spacer	\$2.00
624F439	Spacer	
624F449	Spacer	
<b>SPACER SPRING</b>		
684F129	Spacer spring	\$2.00
<b>SPRINGS</b>		
403F568	Spring	\$8.50
688F017	Spring, kickoff	\$2.00
624F427	Spring	\$3.00

†Sold only in multiples of the number indicated. Price is each.

\*\*618, 619 finish provided to match 629, 630

PART NO.	DESCRIPTION	LIST PRICE
<b>STOP</b>		
684F055	Stop	\$4.50
<b>STOP LEVERS</b>		
700F708	Stop lever	\$2.00
624F478	Stop lever	\$5.50
681F448	Stop lever	\$2.00
682F018	Stop lever	\$5.50
700F748	Stop lever	\$2.00
753F078	Stop lever	
<b>STOP SCREW</b>		
684F067	Stop screw	\$2.00
<b>STOP SPRING</b>		
685F387	Stop spring	\$2.00
703F997	Stop spring	\$2.00
790F047	Aux Stop Spring	
<b>THUMBTURN LEVER HUB</b>		
624F455	Thumbturn lever hub	\$8.50
<b>TURNPIECE HUB – STANDARD</b>		
813F505	Turnpiece Hub, Standard	\$3.50
<b>TURNPIECE HUB – LARGE</b>		
701F705	Turnpiece Hub, Large	\$7.50
853F865	Turnpiece hub, large (ML2087 RH/RHR)	
853F875	Turnpiece hub, large (ML2087 LH/LHR)	
<b>STRIKES</b>		
<b>605, 606, 611, 612, 613, 619, 625, 626, 629**, 630**</b>		
<b>Latchbolt &amp; Deadbolt - Straight Lip</b>		
236L72M014FIN	7/8" Lip Length	\$34.00
236L72M016FIN	1" Lip Length	
236L72M018FIN	1-1/8" Lip Length	
236L72M020FIN	1-1/4" Lip Length	
236L72M022FIN	1-3/8" Lip Length	
236L72M024FIN	1-1/2" Lip Length	
236L72M028FIN	1-3/4" Lip Length	
236L72M032FIN	2" Lip Length	
236L72M036FIN	2-1/4" Lip Length	
236L72M40FIN	2-1/2" Lip Length	
236L72M44FIN	2-3/4" Lip Length	
236L72M48FIN	3" Lip Length	

PART NO.	DESCRIPTION	LIST PRICE	PART NO.	DESCRIPTION	LIST PRICE
<b>STRIKES (Cont'd)</b>			<b>STRIKE - MORTISE EXIT DEVICE - ED7600</b>		
<b>605, 606, 611, 612, 619, 613, 625, 626, 629**, 630**</b>			<b>689, 690, 691</b>		
<b>Latchbolt &amp; Deadbolt - Curved Lip (RH)</b>					
340L60M018FIN	1-1/8" Lip Length	RH	405L138M018FIN	1-1/8" Lip Length	LHR
340L60M020FIN	1-1/4" Lip Length	RH	405L138M020FIN	1-1/4" Lip Length	LHR
340L60M022FIN	1-3/8" Lip Length	RH	405L138M022FIN	1-3/8" Lip Length	LHR
340L60M024FIN	1-1/2" Lip Length	RH	405L148M018FIN	1-1/8" Lip Length	RHR
340L60M028FIN	1-3/4" Lip Length	RH	405L148M020FIN	1 1/4" Lip Length	RHR
340L60M032FIN	2" Lip Length	RH	405L148M022FIN	1 3/8" Lip Length	RHR
340L60M036FIN	2-1/4" Lip Length	RH	<b>STRIKE - OPEN BACK</b>		
340L60M040FIN	2-1/2" Lip Length	RH	<b>605, 606, 611, 612, 613, 619, 625, 626, 629**, 630**</b>		
340L60M044FIN	2-3/4" Lip Length	RH	411L63M016FIN	1-3/4" (016) Door	RHR
340L60M048FIN	3" Lip Length	RH	411L63M018FIN	2" (018) Door	LHR
<b>Latchbolt &amp; Deadbolt - Curved Lip (LH)</b>			411L63M020FIN	2-1/4" (020) Door	RHR
340L61M018FIN	1-1/8" Lip Length	LH	411L62M016FIN	1-3/4" (016) Door	LHR
340L617020FIN	1-1/4" Lip Length	LH	411L62M018FIN	2" (018) Door	RHR
340L61M022FIN	1-3/8" Lip Length	LH	411L62M020FIN	2-1/4" (020) Door	LHR
340L61M024FIN	1-1/2" Lip Length	LH	<b>STRIKE - RABBETED FRONT</b>		
340L61M028FIN	1-3/4" Lip Length	LH	<b>605, 606, 611, 612, 613, 619, 625, 626, 629**, 630**</b>		
340L61M032FIN	2" Lip Length	LH	318F64	Latch	RH/LHR
340L61M036FIN	2-1/4" Lip Length	LH	318F65	Deadbolt	RH/LHR
340L61M040FIN	2-1/2" Lip Length	LH	318F66	Latch and Deadbolt	RH/LHR
340L61M044FIN	2-3/4" Lip Length	LH	318F67	Latch	LH/RHR
340L61M048FIN	3" Lip Length	LH	318F68	Deadbolt	LH/RHR
			318F69	Latch and Deadbolt	LH/RHR

†Sold only in multiples of the number indicated. Price is each.

\*\*618, 619 finish provided to match 629, 630, except on 1-1/4" length curved lip strike

PART NO.	DESCRIPTION	LIST PRICE	PART NO.	DESCRIPTION	LIST PRICE
<b>TRIM ALIGNMENT (ADAPTER) PACKETS</b>			<b>TRIM ALIGNMENT (ADAPTER) PACKETS (Cont'd)</b>		
Finish: 605, 606, 611, 612, 613, 619, 625, 626, 629**, 630**			<b>Knob or Lever Trim Outside &amp; Blank Escutcheon Inside</b>		
<b>"P" Escutcheon</b>			466F45	1-3/8" door	\$41.00
<b>Knob or Lever Trim</b>			466F46	1-3/4" door	
466F73	1-3/8" door	\$56.00	466F47	2-1/4" door	\$41.00
466F74	1-3/4" door		<b>Sectional Trim</b>		
466F75	2-1/4" door	\$64.00	<b>Regularly Furnished with Working Trim</b>		
<b>Half Working Trim</b>			466F40	1-3/8" door	\$27.00
439F25	1-3/8" door	\$35.00	466F41	1-3/4" door	\$27.00
439F26	1-3/4" door		466F42	2-1/4" door	\$27.00
439F27	2-1/4" door		<b>Half Working Trim</b>		
<b>Lever/Knob (GZ/YZ) Half Dummy Trim</b>			437F40	1-3/8" door	\$27.00
488F31	"P" Escutcheon	\$72.00	437F41	1-3/4" door	
<b>Lever/Knob (GZ/YZ) Full Dummy Trim</b>			437F42	2-1/4" door	
854F19	"P" Escutcheon	\$72.00	<b>Half Dummy Trim</b>		
<b>Knob Half Dummy Trim</b>			438F38	Cast Knob*	\$70.00
437F28	"P" Escutcheon*	\$72.00	854F23	Lever/Knob (GZ/YZ)	\$43.00
<b>Wrought Knob Half Dummy Trim</b>			511F51	Wrought Knob*	\$54.00
511F52	"P" Escutcheon*	\$64.00	<b>Full Dummy Trim</b>		
<b>"M" and "N" Escutcheons</b>			854F11	Lever/Knob (GZ/YZ)	\$14.00
<b>Regularly Furnished with Working Trim</b>			<b>Inside Adapter Only - Lockbody</b>		
466F50	1-3/8" door	\$54.00	427F06	Knob Half Working Trim*	\$27.00
466F51	1-3/4" door	\$54.00	488F27	Lever/Knob (GZ/YZ) Half Working Trim	\$50.00
466F52	2-1/4" door	\$54.00	<b>Adjustable Locknut Assembly*</b>		
<b>Half Working Trim</b>			482F37	Adjustable Locknut Assembly	\$9.00
428F32	1-3/8" door	\$34.00	<b>Adjusting Bolt for Half Lever Trim</b>		
428F33	1-3/4" door		483F34	1-3/8" door	\$9.00
428F34	2-1/4" door		483F35	1-3/4" door	\$9.00
<b>Half Dummy Trim</b>			483F36	2-1/4" door	\$9.00
437F26	Knob*	\$61.00	<b>Cylinder Set Screw Packet</b>		
438F37	Cast Knob*	\$67.00	488F088	Standard †Order 20	\$2.00
854F27	Lever/Knob (GZ/YZ)	\$61.00	488F108	Master Ring	\$2.50
<b>Full Dummy Trim</b>			<b>Dowel Screw</b>		
854F15	Lever/Knob (GZ/YZ)	\$61.00	483F30	for Inside Lever/Knob (GZ/YZ)	\$3.50
			<b>Emergency Key</b>		
			605F42	for ML2020, ML2030, ML2060	\$5.50
			<b>E-Ring</b>		
			427F078	for working half trim adapter. †Order 100-	\$2.00

†Sold only in multiples of the number indicated. Price is each.

\*\*618, 619 finish provided to match 629, 630.

\*Discontinued product, only available as inventory allows.



## ASSA ABLOY

PART NO.	DESCRIPTION	605, 606, 611, 612, 613, 613E, 618, 619, 625, 626, 629, 630, 722
<b>"R" ESCUTCHEON - CAST</b>		
<b>Blank</b>		
426F52	Outside	
545F79	Inside	
<b>For Cylinder only</b>		
427F45	Outside	
545F88	Inside	
<b>For Grip only</b>		
427F43	Outside	
545F87	Inside	
<b>For Cylinder &amp; Grip</b>		
427F39	Outside	
545F80	Inside	
<b>For Thumbturn Lever only</b>		
545F84	Inside-1-3/8" door	\$223.00
545F86	Inside-2-1/4" door	
545F85	Inside-1-3/4" door	
<b>For Thumbturn Lever &amp; Grip</b>		
545F81	Inside-1-3/8" door	
545F83	Inside-2-1/4" door	
545F82	Inside-1-3/4" door	
<b>For Grip &amp; Emergency Key</b>		
427F47	Outside	
<b>For Cylinder, Grip &amp; Indicator</b>		
427F37	Outside-1-3/4" door	
427F36	Outside-1-3/8" door	
485F74	Outside-2-1/4" door	
PART NO.	DESCRIPTION	605, 606, 611, 612, 613, 613E, 618, 619, 625, 626, 629, 630, 722
<b>"N" ESCUTCHEON - WROUGHT</b>		
<b>Blank</b>		
544F93	Inside or Outside	
<b>For Cylinder only</b>		
544F80	Inside or Outside	
<b>For Grip only</b>		
544F76	Inside or Outside	
<b>For Cylinder &amp; Grip</b>		
544F77	Inside or Outside	
<b>For Thumbturn Lever only</b>		
544F89	Inside-1-3/4" door	
544F92	Inside-1-3/8" door	
544F91	Inside-2-1/4" door	\$124.00
<b>For Thumbturn Lever &amp; Grip</b>		
544F85	Inside-1-3/4" door	
544F87	Inside-2-1/4" door	
544F88	Inside-1-3/8" door	
<b>For Grip &amp; Emergency Key</b>		
544F79	Outside	
<b>For Cylinder, Grip &amp; Indicator</b>		
544F82	Outside-1-3/8" door	
544F83	Outside-1-3/4" door	
544F84	Outside-2-1/4" door	

PART NO.	DESCRIPTION	605, 606, 611, 612, 613, 613E, 618, 619, 625, 626, 629, 630, 722
<b>"M" ESCUTCHEON - WROUGHT</b>		
<b>Blank</b>		
383F82	Outside	
545F45	Inside	
<b>For Cylinder only</b>		
488F07	Outside	
751F16	Outside - Master Ring	
545F00	Inside	
751F17	Inside - Master Ring	
<b>For Grip only</b>		
488F04	Outside	
544F95	Inside	
<b>For Cylinder &amp; Grip</b>		
488F05	Outside - Conventional	
557F29	Outside - Master Ring	
544F96	Inside - Conventional	\$124.00
377F80	Inside - Master Ring	
<b>For Thumbturn Lever only</b>		
545F42	Inside-1-3/8" door	
545F43	Inside-1-3/4" door	
545F44	Inside-2-1/4" door	
<b>For Thumbturn Lever &amp; Grip</b>		
544F97	Inside-1-3/8" door	
544F98	Inside-1-3/4" door	
544F99	Inside-2-1/4" door	
<b>For Grip &amp; Emergency Key</b>		
544F94	Outside	
<b>For Cylinder, Grip &amp; Indicator</b>		
433F48	Outside-1-3/8" door	
433F49	Outside-1-3/4" door	
484F90	Outside-2-1/4" door	
<b>"P" ESCUTCHEON - WROUGHT</b>		
<b>Blank</b>		
544F46	Inside	
384F11	Outside	
<b>For Cylinder only</b>		
488F03	Outside	\$124.00
544F43	Inside	

PART NO.	DESCRIPTION	605, 606, 611, 612, 613, 613E, 618, 619, 626, 625, 629, 630, 722	
<b>"P" ESCUTCHEON - WROUGHT</b>			
<b>For Grip only</b>			
488F00	Outside	\$124.00	
544F39	Inside		
<b>For Cylinder &amp; Grip</b>			
488F01	Outside		
544F40	Inside		
<b>For Thumbturn Lever only</b>			
544F14	Inside-1-3/8" door		
544F44	Inside-2-1/4" door		
544F45	Inside-1-3/4" door		
<b>For Thumbturn Lever &amp; Grip</b>			
544F13	Inside-1-3/8" door		
544F41	Inside-2-1/4" door		
544F42	Inside-1-3/4" door		
<b>For Grip &amp; Emergency Key</b>			
544F38	Outside		
<b>For Cylinder, Grip &amp; Indicator</b>			
430F47	Outside-1-3/8" door		
435F00	Outside-1-3/4" door		
484F76	Outside-2-1/4" door		

PART NO.	DESCRIPTION	613E, 630	
<b>"V" ESCUTCHEON - CAST</b>			
<b>Blank</b>			
700F80	Outside	\$251.00	
700F40	Inside		
<b>For Cylinder only</b>			
700F83	Outside		
700F43	Inside		
<b>For Grip only</b>			
700F81	Outside		
700F41	Inside		
<b>For Cylinder &amp; Grip</b>			
700F82	Outside		
700F87	Outside - 7P & C6 (Use when collar is required)		
700F42	Inside		
700F47	Inside - 7P & C6 (Use when collar is required)		
<b>For Thumbturn Lever only</b>			
700F45	Inside		
<b>For Thumbturn Lever &amp; Grip</b>			
700F44	Inside		
<b>For Grip &amp; Emergency Key</b>			
700F84	Outside		
<b>For Cylinder, Grip &amp; Indicator</b>			
700F86	Outside		
700F46	Inside		

PART NO.	DESCRIPTION	LIST PRICE
<b>Hex Wrench</b>		
		<b>No Finish</b>
264F698	Hex Wrench	\$2.00
<b>Key Plate Packet</b>		
438F90	Key Plate Packet: 605, 606, 611, 612, 613, 619, 625, 626, 629**, 630**	\$25.00

\*\*618, 619 finish provided to match 629, 630.

PART NO.	DESCRIPTION	605, 606, 611, 612, 613, 613E, 625, 626	PART NO.	DESCRIPTION	605, 606, 611, 612, 613, 613E, 625, 626
<b>"GZ" KNOB - CAST*</b>			<b>"YZ" KNOB - CAST*</b>		
<b>Inside Knob</b>			<b>Inside Knob</b>		
854F04		\$181.00	854F09		\$181.00
<b>Outside Knob &amp; Spindle Assembly</b>			<b>Outside Knob &amp; Spindle Assembly</b>		
854F01	for 1-3/4" door	\$181.00	854F06	for 1-3/4" door	\$181.00
854F00	for 1-3/8" door		854F05	for 1-3/8" door	
854F03	for 2-1/4" door		854F08	for 2-1/4" door	
PART NO.	DESCRIPTION	605, 606, 611, 612, 613, 613E, 618, 619, 625, 626, 722			
<b>KNOBS - WROUGHT AND CAST "YW" KNOB - WROUGHT*</b>					
<b>Inside Knob</b>					
502F62		\$170.00			
<b>Outside Knob &amp; Spindle Assembly</b>					
689F33	for 1-3/4" door	\$170.00			
689F30	for 1-3/8" door				
689F39	for 2-1/4" door				
<b>"GS" KNOB - CAST*</b>					
<b>Inside Knob</b>					
503F15		\$277.00			
<b>Outside Knob &amp; Spindle Assembly</b>					
689F37	for 2-1/4" door	\$277.00			
689F31	for 1-3/4" door				
689F28	for 1-3/8" door				
PART NO.	DESCRIPTION	605, 606, 611, 612, 613, 613E, 625, 626			
<b>"SS" KNOB - CAST*</b>					
<b>Inside Knob</b>					
445F38		\$277.00			
<b>Outside Knob &amp; Spindle Assembly</b>					
445F43	for 1-3/4" door	\$277.00			
498F86	for 2" door				
498F87	for 2-1/4" door				
<b>"GW" KNOB - WROUGHT*</b>					
<b>Inside Knob</b>					
568F11		\$170.00			
<b>Outside Knob &amp; Spindle Assembly</b>					
689F60	for 1-3/4" door	\$170.00			
689F58	for 1-3/8" door				
689F62	for 2-1/4" door				
<b>"BW" KNOB - WROUGHT*</b>					
<b>Inside Knob</b>					
568F12		\$170.00			
<b>Outside Knob &amp; Spindle Assembly</b>					
502F10	for 1-3/4" door	\$170.00			
507F01	for 1-3/8" door				
511F73	for 2-1/4" door				
PART NO.	DESCRIPTION	605, 606, 611, 612, 613, 613E, 625, 626			
<b>"GR" KNOB - WROUGHT REINFORCED*</b>					
<b>Inside Knob</b>					
502F27		\$181.00			
<b>Outside Knob &amp; Spindle Assembly</b>					
689F52	for 1-3/4" door	\$181.00			
689F50	for 1-3/8" door				
689F54	for 2-1/4" door				
PART NO.	DESCRIPTION	LIST PRICE			
<b>Knob Release Tool</b>					
391F658	Knob Release Tool	\$2.00			
<b>Knob Shank Adapter</b>					
483F118	Knob Shank Adapter	\$7.50			
<b>Spring Clip</b>					
377F308	Spring Clip	\$2.00			

\*Discontinued product, only available as inventory allows.

PART NO.	DESCRIPTION	605, 606, 611, 612, 613, 613E, 618, 619, 625, 626, 629, 630, 722
<b>"AS" LEVER - CAST</b>		
<b>Inside Lever</b>		
670F37		
<b>Outside Lever &amp; Spindle Assembly</b>		
670F64	for 1-3/8" door	\$195.00
670F73	for 1-3/4" door	
671F09	for 2-1/4" door	
<b>"CS" LEVER - CAST</b>		
<b>Inside Lever</b>		
670F30		
<b>Outside Lever &amp; Spindle Assembly</b>		
670F57	for 1-3/8" door	\$195.00
670F66	for 1-3/4" door	
671F02	for 2-1/4" door	
<b>"DS" LEVER - CAST</b>		
<b>Inside Lever</b>		
670F32	LH/LHR	
670F31	RH/RHR	
<b>Outside Lever &amp; Spindle Assembly</b>		
670F59	for 1-3/8" door RH/RHR	\$195.00
670F68	for 1-3/4" door RH/RHR	
671F04	for 2-1/4" door RH/RHR	
670F58	for 1-3/8" door LH/LHR	
670F67	for 1-3/4" door LH/LHR	
671F03	for 2-1/4" door LH/LHR	
<b>"ES" LEVER - CAST</b>		
<b>Inside Lever</b>		
670F33		
<b>Outside Lever &amp; Spindle Assembly</b>		
670F60	for 1-3/8" door	\$195.00
670F69	for 1-3/4" door	
671F05	for 2-1/4" door	
<b>"LS" LEVER - CAST</b>		
<b>Inside Lever</b>		
670F34		
<b>Outside Lever &amp; Spindle Assembly</b>		
670F61	for 1-3/8" door	\$195.00
670F70	for 1-3/4" door	
671F06	for 2-1/4" door	
<b>"NS" LEVER - CAST</b>		
<b>Inside Lever</b>		
670F36		
<b>Outside Lever &amp; Spindle Assembly</b>		
670F63	for 1-3/8" door	\$195.00
670F72	for 1-3/4" door	
671F08	for 2-1/4" door	
<b>"PS" LEVER - CAST</b>		
<b>Inside Lever</b>		
670F38		
<b>Outside Lever &amp; Spindle Assembly</b>		
670F65	for 1-3/8" door	\$195.00
670F74	for 1-3/4" door	
671F10	for 2-1/4" door	
<b>"RS" LEVER - CAST</b>		
<b>Inside Lever</b>		
670F35		
<b>Outside Lever &amp; Spindle Assembly</b>		
670F62	for 1-3/8" door	\$195.00
670F71	for 1-3/4" door	
671F07	for 2-1/4" door	

PART NO.	DESCRIPTION	605, 606, 611, 612, 613, 613E, 618, 619, 625, 626, 629, 630, 722
<b>"LW" LEVER - WROUGHT</b>		
<b>Inside Lever</b>		
493F31		\$164.00
<b>Outside Lever &amp; Spindle Assembly</b>		
483F79	for 1-3/8" door	\$164.00
483F80	for 1-3/4" door	
483F81	for 2-1/4" door	
<b>"RW" LEVER - WROUGHT</b>		
<b>Inside Lever</b>		
493F34		\$164.00
<b>Outside Lever &amp; Spindle Assembly</b>		
483F82	for 1-3/8" door	\$164.00
483F83	for 1-3/4" door	
483F84	for 2-1/4" door	

PART NO.	DESCRIPTION	LIST PRICE
<b>NYLON BUSHING NO FINISH</b>		
698F22	Nylon Bushing †Order 100-	\$2.00
<b>ROSE PACKET</b>		
<b>Wrought Rose Packet- (Qty 2) 2-7/8" dia. (C)*</b>		
445F82	605, 606, 611, 612, 613, 613E, 618, 619, 625, 626, 722	\$71.00
<b>Wrought Rose Packet- (Qty 2) 3-1/2" dia. (D)*</b>		
445F83	605, 606, 611, 612, 613, 613E, 618, 619, 625, 626, 722	\$71.00
<b>Wrought Rose Packet- (Qty 2) 3" square (E)*</b>		
445F84	605, 606, 611, 612, 613, 613E, 618, 619, 625, 626, 722	\$71.00
<b>Cast Rose Packet - (Qty 2) 2-7/8" dia. (F)</b>		
447F24	605, 606, 611, 612, 613E, 618, 619, 625, 626, 629, 630, 722	\$174.00
<b>Cast Rose Packet- (Qty 2) 2-1/4" dia. (B)</b>		
447F25	605, 606, 611, 612, 613E, 618, 619, 625, 626, 629, 630, 722	\$90.00
<b>Wrought Rose Packet- (Qty 2) 2-1/4" dia. (A)</b>		
487F08	605, 606, 611, 612, 613E, 618, 619, 625, 626, 629, 630, 722	\$71.00
<b>Wrought Rose Packet- (Qty 2) 2-7/8" dia. (H)</b>		
853F05	605, 606, 611, 612, 613E, 618, 619, 625, 626, 629, 630, 722	\$71.00

PART NO.	DESCRIPTION	LIST PRICE
<b>ROSE REINFORCEMENT PACKET NO FINISH</b>		
445F869	Rose Reinforcement Packet*	\$6.50
<b>SCREW PACKET</b>		
<b>605, 606, 611, 612, 613, 619, 625, 626, 629, 630</b>		
569F45	For M & P half dummy trim*	\$7.50
429F317	Screw Packet for "N" Surface Mounted Escutcheon	\$9.00
616F088	Lock mounting, spanner	\$9.50
584F46	Escutcheon for 1-3/4" door, spanner	\$5.50
384F03	Escutcheon for 2" - 2-1/4" door, spanner	
616F078	T20 Torx® bit	\$13.00
269F098	Screw 1-32 x 1/4" OHMS-PH †Order 100-	\$2.00
<b>SPACER NO FINISH</b>		
497F528	Spacer for Cast Knob*	\$3.50
<b>SPINDLES NO FINISH</b>		
<b>LxL, KxK, LxK, KxL Spindle</b>		
499F828	1-3/8" door	\$35.00
499F838	1-3/4" door	
499F848	2-1/4" door	

†Sold only in multiples of the number indicated. Price is each.

\*Discontinued product, only available as inventory allows.

PART NO.	DESCRIPTION	LIST PRICE	PART NO.	DESCRIPTION	LIST PRICE
<b>INSIDE SPINDLE FOR HALF LEVER TRIM*</b>			<b>ERGONOMIC THUMBTURN KIT FOR ESCUTCHEON TRIM</b>		
	<b>(Knob x Knob) Spindle*</b>			<b>605, 606, 611, 612, 613, 619, 625, 626, 629, 630</b>	
680F348	1-3/8" door	\$18.00	711F002	for up to 4" door (must be field cut to size)	\$68.00
680F358	1-3/4" door	\$5.50	<b>WASHER FOR VANDAL RESISTANT TRIM</b>		
680F368	2-1/4" door	\$12.00	700F378	Washer	\$3.00
<b>VANDAL RESISTANT SPINDLE &amp; SCREW PACK</b>			<b>RETAINING RING FOR VANDAL RESISTANT TRIM</b>		
700F65	1-3/4" door	\$16.00	700F168	Retaining ring	\$2.00
700F66	2" door		<b>LEVER SPINDLE SPRING FOR VANDAL RESISTANT TRIM</b>		
700F67	2 -1/4" door		700F367	Lever spindle spring	\$2.00
<b>THIMBLE PACKET</b>			PART NO. X FINISH	DESCRIPTION	605, 606, 611, 612, 613, 613E, 618, 619, 625, 626, 629, 630, 722
432F86	<b>(Qty 2) for wrought escutcheon knob trim designs*</b>				
	605, 606, 611, 612, 613, 619, 625, 626, 629, 630	\$34.00	<b>INDICATORS – KEYED FUNCTION (SECURE)</b>		
445F85	<b>(Qty 2) for sectional knob trim designs*</b>		720F21	for 1-3/8" (35mm) door	\$97.00
	605, 606, 611, 612, 613, 619, 625, 626	\$42.00	720F22	for 1-3/4" (44mm) – 2" (51mm) door	
<b>THIMBLE WRENCH NO FINISH</b>			720F24	for 2-1/4" (57mm) door	
300F688	Thimble Wrench	\$4.50	720F25	for over 2-1/4" (57mm) door	
<b>THROUGHBOLT PACKET</b>			<b>INDICATORS – KEYED FUNCTION (VACANT)</b>		
	<b>605, 606, 611, 612, 613, 619, 625, 626, 629, 630</b>		741F21	for 1-3/8" door	\$97.00
	<b>"M" and "P" Escutcheons</b>		741F22	for 1-3/4" to 2" doors	
433F76	1-3/8" door	\$7.50	741F23	for 2-1/4" door	
433F77	1-3/4" door		741F24	for up to 3" door	
433F78	2-1/4" door		<b>INDICATORS – NON-KEYED FUNCTION (SECURE)</b>		
	<b>"R" Escutcheon</b>		721F16	for 1-3/8" (35mm) door	\$116.00
439F33	1-3/8" door	\$7.50	721F17	for 1-3/4" (44mm) – 2" (51mm) door	
439F34	1-3/4" door		721F18	for 2-1/4" (57mm) door	
439F35	2-1/4" door		721F19	for over 2-1/4" (57mm) door	
	<b>"T" Escutcheon (spanner head)*</b>		<b>INDICATORS – NON-KEYED FUNCTION (VACANT)</b>		
445F318	1-3/4" door	\$15.00	720F61	for 1-3/8" (35mm) door	\$116.00
498F928	2" to 2-1/4" door		720F62	for 1-3/4" (44mm) – 2" (51mm) door	
<b>THUMBTURN LEVER PACKET</b>			720F64	for 2-1/4" (57mm) door	
	<b>605, 606, 611, 612, 613, 625, 626, 629, 630</b>		720F65	for over 2-1/4" (57mm) door	
519F09	for 1-3/8" door	\$47.00	<b>THUMBTURN INDICATOR</b>		
519F10	for 1-3/4" door		723F69	for 1-3/8" (35mm) door	\$202.00
519F11	for 2-1/4" door		723F26	for 1-3/4" (44mm) – 2" (51mm) door	
519F12	for up to 3" door	791F59	for 2-1/4" (57mm) door		
581F96	for up to 3-1/2" door	\$60.00	791F60	for over 2-1/4" (57mm) door	
696F39	Blank Plate	\$60.00	<b>ERGONOMIC THUMBTURN LEVER PACKET FOR SECTIONAL TRIM</b>		
	<b>605, 606, 611, 612, 613, 619, 625, 626, 629, 630</b>		707F57	for 1-3/8" door	\$68.00
707F57	for 1-3/8" door	\$68.00	707F58	for 1-3/4" to 2" doors	
707F58	for 1-3/4" to 2" doors		707F59	for 2-1/4" door	
707F59	for 2-1/4" door		707F60	for up to 3" door	\$68.00
707F60	for up to 3" door	706F70	for up to 4" door		
706F70	for up to 4" door				

\*Discontinued product, only available as inventory allows.

**VINEYARD™ COLLECTION TRIM**

PART NO.	DESCRIPTION	605 , 606, 613E, 619, 625, 626
<b>INSIDE LEVERS</b>		
692F632	Frascati LH/LHR	\$256.00
692F642	Frascati RH/RHR	
692F662	Zinfandel LH/LHR	
692F672	Zinfandel RH/RHR	
692F652	Merlot	
<b>OUTSIDE LEVERS</b>		
692F762	Frascati for 1 3/4" door LH/LHR	\$256.00
692F752	Frascati for 1 3/4" door RH/RHR	
692F952	Zinfandel for 1 3/4" door LH/LHR	
692F942	Zinfandel for 1 3/4" door RH/RHR	
692F932	Merlot for 1 3/4" door	
<b>L ESCUTCHEON - CAST</b>		
<b>Blank</b>		
692F862	Inside	\$211.00
<b>For Cylinder Only</b>		
694F322	Inside	
694F522	Outside	
<b>For Grip Only</b>		
694F312	Inside	
694F442	Outside	
<b>For Cylinder &amp; Grip</b>		
694F332	Inside	
694F562	Outside	
<b>For Thumbturn Lever Only</b>		
694F352	Inside	
<b>For Thumbturn Lever &amp; Grip</b>		
694F392	Inside	
<b>For Grip &amp; Emergency Key</b>		
694F482	Outside	
<b>For Cylinder, Grip &amp; Indicator</b>		
694F602	Outside	
<b>For Grip x Plug Only</b>		
694F682	Outside	
<b>For Grip x Plug Only x Indicator</b>		
694F722	Outside	
<b>ROSES (PAIR)</b>		
694F802	G-Rose (All functions)	\$238.00



## LOCKSET PARTS

PART NO.	DESCRIPTION	LIST PRICE
<b>LEVERS – (Finish: 605,606,611,612,613,613E,613L,618,619,625,626,722)</b>		
790F215	NZ - Plain	\$82.00
790F225	NZ - Cylinder or Button	\$82.00
790F235	NZ - Emergency Key Hole	\$82.00
790F245	NZ - Intruder	\$82.00
790F335	NZ - Sargent® Cylinder Cutout	\$82.00
790F345	NZ - Sargent Cylinder Cutout - Intruder	\$82.00
790F395	NZ - Corbin Russwin LFIC - 6 Pin	\$82.00
790F405	NZ - Corbin Russwin LFIC - 6 Pin Intruder	\$82.00
790F415	NZ - Corbin Russwin LFIC - 7 Pin	\$82.00
790F425	NZ - Corbin Russwin LFIC - 7 Pin Intruder	\$82.00
790F515	NZ - SFIC Cutout	\$82.00
790F525	NZ - SFIC Cutout Intruder	\$82.00
790F575	NZ - Schlage® LFIC Cutout	\$82.00
790F585	NZ - Schlage® LFIC Cutout - Intruder	\$82.00
774F225	PZ Yale® Cylinder Cutout 6/7 Pin	\$82.00
798F295	PZ Yale® Cylinder Cutout 6/7 Pin - Intruder	\$82.00
774F945	PZ Yale® Cylinder Cutout 6/7 Pin	\$82.00
798F305	PZ Yale® Cylinder Cutout 6/7 Pin - Intruder	\$82.00
780F215	NZ Security - Plain	\$82.00
780F225	NZ Security - Cylinder or Button	\$82.00
780F235	NZ Security - Emergency Key Hole	\$82.00
780F245	NZ Security - Intruder	\$82.00
780F335	NZ Security - Sargent Cylinder Cutout	\$82.00
780F345	NZ Security - Sargent Cylinder Cutout - Intruder	\$82.00
780F395	NZ Security - Corbin Russwin LFIC - 6 Pin	\$82.00
780F405	NZ Security - Corbin Russwin LFIC - 6 Pin Intruder	\$82.00
780F415	NZ Security - Corbin Russwin LFIC - 7 Pin	\$82.00
780F425	NZ Security - Corbin Russwin LFIC - 7 Pin Intruder	\$82.00
780F515	NZ Security - SFIC Cutout	\$82.00
780F525	NZ Security - SFIC Cutout Intruder	\$82.00
780F575	NZ Security - Schlage® LFIC Cutout	\$82.00
780F585	NZ Security - Schlage® LFIC Cutout - Intruder	\$82.00
790F225	PZ Yale® Cylinder Cutout 6/7 Pin	\$82.00
790F245	PZ Yale® Cylinder Cutout 6/7 Pin - Intruder	\$82.00
776F215	AZ - Plain	\$82.00
776F225	AZ - Cylinder or Button	\$82.00
776F235	AZ - Emergency Key Hole	\$82.00
776F245	AZ - Intruder	\$82.00
776F335	AZ - Sargent® Cylinder Cutout	\$82.00
776F345	AZ - Sargent Cylinder Cutout - Intruder	\$82.00
776F395	AZ - Corbin Russwin LFIC - 6 Pin	\$82.00
776F405	AZ - Corbin Russwin LFIC - 6 Pin Intruder	\$82.00
776F415	AZ - Corbin Russwin LFIC - 7 Pin	\$82.00
776F425	AZ - Corbin Russwin LFIC - 7 Pin Intruder	\$82.00
776F515	AZ - SFIC Cutout	\$82.00
776F525	AZ - SFIC Cutout Intruder	\$82.00
776F575	AZ - Schlage® LFIC Cutout	\$82.00
776F585	AZ - Schlage® LFIC Cutout - Intruder	\$82.00
777F215	AZ Security - Plain	\$82.00
777F225	AZ Security - Cylinder or Button	\$82.00
777F235	AZ Security - Emergency Key Hole	\$82.00
777F245	AZ Security - Intruder	\$82.00
777F335	AZ Security - Sargent Cylinder Cutout	\$82.00
777F345	AZ Security - Sargent Cylinder Cutout - Intruder	\$82.00
777F395	AZ Security - Corbin Russwin LFIC - 6 Pin	\$82.00
777F405	AZ Security - Corbin Russwin LFIC - 6 Pin Intruder	\$82.00
777F415	AZ Security - Corbin Russwin LFIC - 7 Pin	\$82.00
777F425	AZ Security - Corbin Russwin LFIC - 7 Pin Intruder	\$82.00
777F515	AZ Security - SFIC Cutout	\$82.00
777F525	AZ Security - SFIC Cutout Intruder	\$82.00
777F575	AZ Security - Schlage® LFIC Cutout	\$82.00
777F585	AZ Security - Schlage® LFIC Cutout - Intruder	\$82.00

PART NO.	DESCRIPTION	LIST PRICE
<b>LEVERS – (Finish: 605,606,611,612,613,613E,613L,618,619,625,626,722)</b>		
778F215	PZ - Plain	\$82.00
778F225	PZ - Cylinder or Button	\$82.00
778F235	PZ - Emergency Key Hole	\$82.00
778F245	PZ - Intruder	\$82.00
778F335	PZ - Sargent® Cylinder Cutout	\$82.00
778F345	PZ - Sargent Cylinder Cutout - Intruder	\$82.00
778F395	PZ - Corbin Russwin LFIC - 6 Pin	\$82.00
778F405	PZ - Corbin Russwin LFIC - 6 Pin Intruder	\$82.00
778F415	PZ - Corbin Russwin LFIC - 7 Pin	\$82.00
778F425	PZ - Corbin Russwin LFIC - 7 Pin Intruder	\$82.00
778F515	PZ - SFIC Cutout	\$82.00
778F525	PZ - SFIC Cutout Intruder	\$82.00
778F575	PZ - Schlage® LFIC Cutout	\$82.00
778F585	PZ - Schlage® LFIC Cutout - Intruder	\$82.00
778F225	PZ Yale® Cylinder Cutout 6/7 Pin	\$82.00
778F245	PZ Yale® Cylinder Cutout 6/7 Pin - Intruder	\$82.00
774F965	PZ Yale® Cylinder Cutout 6/7 Pin	\$82.00
798F395	PZ Yale® Cylinder Cutout 6/7 Pin - Intruder	\$82.00
774F985	PZ Yale® Cylinder Cutout 6/7 Pin	\$82.00
798F405	PZ Yale® Cylinder Cutout 6/7 Pin - Intruder	\$82.00
779F215	PZ Security - Plain	\$82.00
779F225	PZ Security - Cylinder or Button	\$82.00
779F235	PZ Security - Emergency Key Hole	\$82.00
779F245	PZ Security - Intruder	\$82.00
779F335	PZ Security - Sargent Cylinder Cutout	\$82.00
779F345	PZ Security - Sargent Cylinder Cutout - Intruder	\$82.00
779F395	PZ Security - Corbin Russwin LFIC - 6 Pin	\$82.00
779F405	PZ Security - Corbin Russwin LFIC - 6 Pin Intruder	\$82.00
779F415	PZ Security - Corbin Russwin LFIC - 7 Pin	\$82.00
779F425	PZ Security - Corbin Russwin LFIC - 7 Pin Intruder	\$82.00
779F515	PZ Security - SFIC Cutout	\$82.00
779F525	PZ Security - SFIC Cutout Intruder	\$82.00
779F575	PZ Security - Schlage® LFIC Cutout	\$82.00
779F585	PZ Security - Schlage® LFIC Cutout - Intruder	\$82.00

PART NO.	DESCRIPTION	LIST PRICE
<b>ROSES</b>		
<b>D ROSE</b>		
678F252 Fin	626/613E	\$47.00
	605,606,611,612,613,613L,618,619,625,722	
<b>C ROSE</b>		
779F97 Fin	626/613E	\$47.00
	605,606,611,612,613,613L,618,619,625,722	
<b>ROSETTE FOR C &amp; K ROSE</b>		
778F90 Fin	626/613E	\$47.00
	605,606,611,612,613,613L,618,619,625,722	
<b>E ROSE</b>		
779F98 Fin	626/613E	\$47.00
	605,606,611,612,613,613L,618,619,625,722	
<b>ROSETTE FOR E ROSE</b>		
778F97 Fin	626/613E	\$47.00
	605,606,611,612,613,613L,618,619,625,722	
<b>K ROSE</b>		
779F99 Fin	626/613E	\$47.00
	605,606,611,612,613,613L,618,619,625,722	

**LOCKSET PARTS**

PART NO.	DESCRIPTION	LIST PRICE
<b>LATCH ASSEMBLIES</b>		
Standard		
780F81 Fin	10 Function	\$151.00
780F82 Fin	32, 40NT, 51, 52, 55, 57, 62, 72, and 80 Functions	
780F83 Fin	20 and 20H Functions	
780F84 Fin	29, 75, and 93 Functions	
780F85 Fin	61 Function	
3-3/4" Backset		
780F86 Fin	10 Function	\$151.00
780F87 Fin	32, 40NT, 51, 52, 55, 57, 62, 72, and 80 Functions	
780F88 Fin	20 and 20H Functions	
780F89 Fin	29, 75, and 93 Functions	
780F90 Fin	61 Function	
5" Backset		
780F91 Fin	10 Function	\$151.00
780F92 Fin	32, 40NT, 51, 52, 55, 57, 62, 72, and 80 Functions	
780F93 Fin	20 and 20H Functions	
780F94 Fin	29, 75, and 93 Functions	
780F95 Fin	61 Function	
3/4" Throw Fire Latch		
780F96 Fin	10, 51, 55, 57, 72, and 80 Functions	\$196.00

PART NO.	DESCRIPTION	LIST PRICE
<b>STRIKES</b>		
586L19	Curved Lip "T" Strike	\$24.00

PART NO.	DESCRIPTION	LIST PRICE
<b>SLEEVE ASSEMBLIES</b>		
STANDARD		
775F808	Outside Sleeve - 61 Function	\$162.00
776F002 Fin	Inside Sleeve - 51 Function	\$84.00
776F012 Fin	Inside Sleeve - 93 Function	\$84.00
776F022 Fin	Inside Sleeve - 61 Function	\$84.00
776F032 Fin	Inside Sleeve - 29 Function	\$162.00
776F042 Fin	Inside Sleeve - 20, 20H and 75 Functions	\$210.00
776F638	Outside Sleeve - 51,57,61,72, and 93 Functions	\$162.00
776F648	Outside Sleeve - 40NT Function	\$84.00
776F658	Outside Sleeve - 32 Function	\$151.00
776F668	Outside Sleeve - 55 and 62 Functions	\$151.00
776F678	Outside Sleeve - 29 Function	\$162.00
776F688	Outside Sleeve - 52 and 75 Functions	\$179.00
776F698	Outside Sleeve - 20 and 20H Functions	\$137.00
776F708	Inside Sleeve - 10, 55, and 80 Functions Outside Sleeve - 10 Function	\$75.00
776F848	Inside Sleeve - 52 and 72 Functions	\$210.00
776F858	Inside Sleeve - 32 Function	\$151.00
776F868	Inside Sleeve - 62 Function	\$151.00
776F878	Inside Sleeve - 40NT and 57 Functions	\$75.00

PART NO.	DESCRIPTION	LIST PRICE
<b>SLEEVE ASSEMBLIES</b>		
INTERCHANGEABLE CORE		
775F818	Outside Sleeve - 61 Function	\$162.00
776F718	Outside Sleeve - 51, 57, 72, 93 Functions	\$162.00
776F728	Outside Sleeve - 32 Function	\$151.00
776F738	Outside Sleeve - 55, 62 Functions	\$151.00
776F748	Outside Sleeve - 52, 75 Functions	\$179.00
776F918	Inside Sleeve - 61, 75 Functions	\$162.00
776F928	Inside Sleeve - 52, 72 Functions	\$151.00
776F938	Inside Sleeve - 32 Function	\$151.00
776F948	Inside Sleeve - 62 Function	\$148.00
3/4" THROW FIRE LATCH - STANDARD		
779F638	Outside Sleeve - 51, 57, 72 Functions	\$151.00
779F648	Outside Sleeve - 55 Function	\$151.00
779F658	Inside Sleeve - 72 Function Inside Sleeve - 57 Function	\$78.00
779F728	Inside Sleeve - 72 Function	\$210.00
779F738	Inside Sleeve - 57 Function	\$75.00
779F748	Inside Sleeve - 51 Function	\$151.00
3/4" THROW FIRE LATCH - INTERCHANGEABLE CORE		
779F758	Inside Sleeve - 72 Function	\$162.00
M111 SLEEVE ASSEMBLIES - STANDARD		
775F828	Outside Sleeve - 61 Function	\$162.00
776F758	Outside Sleeve - 51, 57, 72, 93 Functions	\$162.00
776F768	Outside Sleeve - 32 Function	\$151.00
776F778	Outside Sleeve - 55, 62 Functions	\$151.00
776F788	Outside Sleeve - 29 Function	\$162.00
776F798	Outside Sleeve - 52, 75 Functions	\$179.00
776F958	Inside Sleeve - 52, 72 Functions	\$210.00
776F968	Inside Sleeve - 32 Function	\$151.00
776F978	Inside Sleeve - 62 Function	\$151.00
M111 SLEEVE ASSEMBLIES - INTERCHANGEABLE CORE		
775F838	Outside Sleeve - 61 Function	\$162.00
776F808	Outside Sleeve - 51,57,61,72,93 Functions	\$162.00
776F818	Outside Sleeve - 32 Function	\$151.00
776F828	Outside Sleeve - 55, 62 Functions	\$151.00
776F838	Outside Sleeve - 52, 75 Functions	\$179.00
776F988	Inside Sleeve - 52, 72 Functions	\$151.00
776F998	Inside Sleeve - 32 Function	\$151.00
777F208	Inside Sleeve - 62 Function	\$151.00

PART NO.	DESCRIPTION	LIST PRICE
<b>COLLARS</b>		
778F888	Inside Collar	\$8.50
778F898	Outside Collar	\$8.50

PART NO.	DESCRIPTION	LIST PRICE
<b>TAILPIECES</b>		
778F788	Schlage® Fixed Core	\$18.00
780F658	SFIC Core	\$5.50
775F948	SARGENT Fixed Core	\$18.00
780F662	Schlage® LFIC	\$24.00
780F648	Corbin Russwin LFIC	\$2.00
774F878	Yale® LFIC 6-Pin	\$2.00
774F888	Yale® LFIC 7-Pin	\$2.00
780F808	Tail, Cylinder, 20H	\$2.00

### LOCKSET PARTS

PART NO.	DESCRIPTION	LIST PRICE
<b>MISCELLANEOUS</b>		
778F638	Collar/Rosette Installation Wrench	\$8.50
780F638	Allen Key Wrench	\$8.50
780F208	M111 Screwdriver	\$5.50
604F228 Fin	Screw Packet	\$18.00
775F908 Fin	Mounting Kit Packet (CL3150)	\$23.00
775F918 Fin	Mounting Kit Packet (CL3170)	\$23.00
753F598	Rose Installation Tool	\$7.50
778F868	Aligning Pin	\$2.00
779F787	Bearing Assembly	\$204.00
778F812	Emergency Release Cylinder	\$47.00
206F578	Screw, combo #8 PH	\$2.00
790F988	Inside Mounting Flange Assembly	\$118.00
790F998	Outside Mounting Flange Assembly	\$118.00
403F302 Fin	Cup Washer	\$3.50
305F318 Fin	Machine Screw 1/4-20 x 2-3/4"	\$4.50
269F808	Countersunk Flat Head Screw 10-24x3/8" (1-3/4" Door)	\$2.00
778F968	Anchor Plate	\$2.00
778F91 Fin	Rosette Plug	\$40.00
790F988	Flange SA, Mounting I/S	\$118.00
790F998	Flange SA, Mounting O/S	\$118.00
220F718	Screw, FHM-PH, 10-24X1/2"	\$2.00
779F797	Bearing SA, D200	\$204.00
779F807	Bearing SA, M16	\$181.00
790F208	Screw, FHM-PH, #4-40X1/2"	\$4.50
679F818	Emergency Release Tool	\$2.50
778F759	Cylinder Spacer for 6-Pin Fixed Core Corbin Russwin or Yale® Cylinder	\$2.50

## LOCKSET PARTS

PART NO.	DESCRIPTION	LIST PRICE	PART NO.	DESCRIPTION	LIST PRICE
<b>CHASSIS ASSEMBLY STANDARD</b>			<b>LEVERS 1-3/4" TO 2" DOORS (Cont'd)</b>		
785F008	for CL3310	\$162.00	596F825	NZD - SFIC (Best®) cylinder	\$108.00
785F118 Fin	for CL3320, CL3361	\$170.00	714F425	NZD - SFIC (Best®) cylinder CL3352 inside	
785F138 Fin	CL3320TO	\$162.00	690F975	NZD - Schlage® LFIC cylinder	
785F078 Fin	for CL3329	\$200.00	714F455	NZD - Schlage® LFIC cylinder CL3352 inside	
785F068	for CL3332	\$193.00	563F885	AZD - Plain	\$108.00
785F028 Fin	for CL3340	\$189.00	563F895	AZD - Cylinder or button	
785F038	for CL3340NT	\$172.00	714F005	AZD - CL3352 inside	
785F018 Fin	CL3351, CL3357	\$172.00	563F905	AZD - Emergency key hole	
785F048	for CL3352, CL3355	\$200.00	585F705	AZD - LFIC cylinder - 6 pin	\$108.00
785F148	for CL3359	\$172.00	714F305	AZD - LFIC cylinder - 6 pin CL3352 inside	
785F058	for CL3362	\$193.00	600F425	AZD - LFIC cylinder - 7 pin	
785F088	for CL3372	\$183.00	714F315	AZD - LFIC cylinder - 7 pin CL3352 inside	
785F158 Fin	CL3375	\$160.00	695F075	AZD - Sargent® cylinder	\$108.00
785F088	for CL3380, CL3390	\$183.00	714F035	AZD - Sargent® cylinder CL3352 inside	
785F108	for CL3381, CL3391	\$183.00	578F435	NZD - Sargent cylinder	
785F378 Fin	CL3393	\$445.00	714F125	NZD - Sargent cylinder CL3352 inside	
785F188	CL33903-12AD	\$445.00	799F505	PZD - plain	\$108.00
785F168	CL33903-24AD	\$445.00	799F515	PZD - Cylinder or button	
785F198	CL33905-12AD	\$445.00	799F535	PZD - CL3352 inside	
785F178	CL33905-24AD	\$445.00	799F525	PZD - Emergency key hole	
<b>CHASSIS ASSEMBLY, LFIC</b>			799F565	PZD - LFIC Cylinder - 6 pin	\$108.00
785F298	for CL3361	\$212.00	799F575	PZD - LFIC Cylinder - 6 pin CL3352 inside	
785F268 Fin	for CL3329	\$206.00	799F585	PZD - LFIC Cylinder - 7 pin	
785F258	for CL3332	\$189.00	799F595	PZD - LFIC Cylinder - 7 pin CL3352 inside	
785F218 Fin	for CL3351, CL3357, CL3393	\$206.00	799F805	PZD - SFIC (Best®) cylinder	\$108.00
785F238	for CL3352	\$189.00	799F815	PZD - SFIC (Best®) cylinder CL3352 inside	
785F228	for CL3355	\$206.00	799F825	PZD - Schlage® LFIC cylinder	
785F308	for CL3359	\$206.00	799F835	PZD - Schlage® LFIC cylinder CL3352 inside	
785F248	for CL3362	\$175.00	799F545	PZD - Sargent® cylinder	\$108.00
785F278	for CL3372	\$197.00	799F555	PZD - Sargent® cylinder CL3352 inside	
785F318 Fin	CL3375	\$175.00	712F205	FZD - LH plain	
785F288	for CL3381, CL3391	\$175.00	712F215	FZD - LH cylinder or button	
785F388 Fin	CL3393	\$445.00	712F385	FZD - LH CL3352 inside	\$108.00
785F348	CL33903-12AD	\$445.00	712F225	FZD - LH emergency key hole	
785F328	CL33903-24AD	\$445.00	715F245	FZD - LH LFIC cylinder - 6 pin	
785F358	CL33905-12AD	\$445.00	712F405	FZD - LH LFIC cylinder - 6 pin CL3352 inside	
785F338	CL33905-24AD	\$445.00	714F255	FZD - LH LFIC cylinder - 7 pin	\$108.00
<b>CYLINDER PARTS</b>			712F415	FZD - LH LFIC cylinder - 7 pin CL3352 inside	
622F308	Tailpiece 6-pin	\$2.00	712F265	FZD - LH SFIC (Best®) cylinder	
682F298	Tailpiece 7-pin	\$6.00	712F425	FZD - LH SFIC (Best®) cylinder CL3352 inside	
631F248	Corbin Russwin LFIC core kit	\$6.00	712F275	FZD - LH Schlage® LFIC cylinder	\$108.00
682F958	SFIC (Best®) tailpiece kit	\$18.00	712F435	FZD - LH Schlage® LFIC cylinder CL3352 inside	
682F969	Sargent® tailpiece kit	\$24.00	712F235	FZD - LH Sargent® cylinder	
697F942	Schlage® LFIC tailpiece kit	\$6.50	712F395	FZD - LH Sargent® cylinder CL3352 inside	
682F398	Schlage® tailpiece kit	\$35.00	712F505	FZD - RH plain	\$108.00
<b>HOUSING ASSEMBLIES</b>			712F515	FZD - RH cylinder or button	
783F208	Spring housing O/S	\$29.00	712F685	FZD - RH CL3352 inside	
783F308	Spring housing I/S 1 3/4" - 2"	\$29.00	712F525	FZD - RH emergency key hole	
783F408	Spring housing I/S 2 1/4"	\$108.00	712F545	FZD - RH LFIC cylinder - 6 pin	\$108.00
686F858	Dummy housing I/S	\$99.00	712F705	FZD - RH LFIC cylinder - 6 pin CL3352 inside	
686F868	Dummy housing O/S	\$108.00	712F555	FZD - RH LFIC cylinder - 7 pin	
<b>LEVERS 1-3/4" TO 2" DOORS</b>			712F715	FZD - RH LFIC cylinder - 7 pin CL3352 inside	
563F945	NZD - Plain	\$108.00	712F565	FZD - RH SFIC (Best®) cylinder	
563F955	NZD - Cylinder button				
714F065	NZD - CL3352 inside				
563F965	NZD - Emergency key hole				
585F715	NZD - LFIC cylinder - 6 pin	\$108.00	712F725	FZD - RH SFIC (Best®) cylinder CL3352 inside	
714F365	NZD - LFIC cylinder - 6 pin CL3352 inside				
600F415	NZD - LFIC cylinder - 7 pin				
714F375	NZD - LFIC cylinder - 7 pin CL3352 inside				
		\$108.00	712F575	FZD Schlage® LFIC cylinder	
		\$108.00	712F735	FZD Schlage® LFIC cylinder CL3352 inside	
		\$108.00	712F535	FDZ - RH Sargent® cylinder	
		\$108.00	712F695	FDZ - RH Sargent® cylinder CL3352 inside	

**LOCKSET PARTS**

PART NO.	DESCRIPTION	LIST PRICE	PART NO.	DESCRIPTION	LIST PRICE
<b>LEVERS 2 1/4" DOORS</b>			<b>LEVERS 2 1/4" DOORS (Cont'd)</b>		
684F825	NZD - Plain	\$108.00	712F335	FZD - LH Sargent® cylinder	\$108.00
684F835	NZD - Cylinder or button		712F455	FZD - LH Sargent® cylinder CL3352 inside	
714F215	NZD - CL3352 inside		712F605	FZD - RH plain	\$108.00
684F845	NZD - Emergency key hole		712F615	FZD - RH cylinder or button	
684F865	NZD - LFIC cylinder - 6 pin	712F745	FZD - RH CL3352 inside		
714F545	NZD - LFIC cylinder - 6 pin CL3352 inside	712F625	FZD - RH emergency key hole	\$108.00	
685F875	NZD - LFIC cylinder - 7 pin	712F645	FZD - RH LFIC cylinder - 6 pin		
714F555	NZD - LFIC cylinder - 7 pin CL3352 inside	712F765	FZD - RH LFIC cylinder - 6 pin CL3352 inside		
684F885	NZD - SFIC (Best®) cylinder	712F655	FZD - RH LFIC cylinder - 7 pin		\$108.00
714F605	NZD - SFIC (Best®) cylinder CL3352 inside	712F775	FZD - RH LFIC cylinder - 7 pin CL3352 inside		
690F985	NZD - Schlage® LFIC cylinder	712F665	FZD - RH SFIC (Best®) cylinder	\$108.00	
714F635	NZD - Schlage® LFIC cylinder CL3352 inside	712F785	FZD - RH SFIC (Best®) cylinder CL3352 inside		
684F855	NZD - Sargent® cylinder	712F675	FZD - RH Schlage® LFIC cylinder		\$108.00
714F275	NZD - Sargent® cylinder CL3352 inside	712F795	FZD - RH Schlage® LFIC cylinder CL3352 inside		
684F775	AZD - Plain	712F635	FZD - RH Sargent® cylinder	\$108.00	
684F785	AZD - Cylinder or button	712F755	FZD - RH Sargent® cylinder CL3352 inside		
714F155	AZD - CL3352 inside	\$108.00	<b>EMERGENCY RELEASE TOOL</b>		
684F795	AZD - Emergency key hole		679F818	Emergency Release Tool (CL3320)	\$2.00
684F805	AZD - LFIC cylinder - 6 pin		601F829	Emergency Release Label (CL3320)	
714F485	AZD - LFIC cylinder - 6 pin CL3352 inside		<b>LEVER INSERT</b>		
684F815	AZD - LFIC cylinder - 7 pin	\$108.00	585F729	Lever insert (black)	\$2.00
714F495	AZD - LFIC cylinder - 7 pin CL3352 inside		<b>LATCH ASSEMBLY</b>		
697F995	AZD - Sargent® cylinder		<b>2 3/4" Backsets</b>		
714F185	AZD - Sargent® cylinder CL3352 inside		586F16	Plain, square corner	\$75.00
799F605	PZD - Plain	596F66	Plain, round corner		
799F615	PZD - Cylinder or button	\$108.00	586F17	Deadlocking square corner	\$83.00
799F635	PZD - CL3352 inside		596F67	Deadlocking round corner	
799F625	PZD - Emergency key hole		586F18	Throw-Off square corner	
799F665	PZD - LFIC cylinder - 6 pin		596F68	Throw-Off round corner	
799F675	PZD - LFIC cylinder - 6 pin CL3352 inside	\$108.00	601F69	3/4" Through deadlocking fire latch square corner	\$108.00
799F685	PZD - LFIC cylinder - 7 pin		<b>3 3/4" Backsets</b>		
799F695	PZD - LFIC cylinder - 7 pin CL3352 inside		586F80	Plain, square corner	\$142.00
799F845	PZD - SFIC (Best®) cylinder		586F86	Plain, round corner	
799F855	PZD - SFIC (Best®) cylinder CL3352 inside	\$108.00	586F81	Deadlocking square corner	\$150.00
799F865	PZD - Schlage® LFIC cylinder		586F87	Deadlocking round corner	
799F875	PZD - Schlage LFIC cylinder CL3352 inside		586F82	Throw-Off square corner	
799F645	PZD - Sargent® cylinder		586F88	Throw-Off round corner	
799F655	PZD - Sargent® cylinder CL3352 inside	\$108.00	<b>5" Backsets</b>		
712F305	FZD - LH plain		598F20	Plain, square corner	\$101.00
712F315	FZD - LH cylinder or botton		601F24	Plain, round corner	
712F445	FZD - LH CL3352 inside		598F21	Deadlocking square corner	\$109.00
712F325	FZD - LH emergency key hole	601F25	Deadlocking round corner		
712F345	FZD - LH LFIC cylinder - 6 pin	598F22	Throw-Off square corner		
712F465	FZD - LH LFIC cylinder - 6 pin CL3352 inside	601F26	Throw-Off round corner		
712F355	FZD - LH LFIC cylinder - 7 pin	\$108.00			
712F475	FZD - LH LFIC cylinder - 7 pin CL3352 inside				
712F365	FZD - LH SFIC (Best®) cylinder				
712F485	FZD - LH SFIC (Best®) cylinder CL3352 inside				
712F375	FZD - LH Schlage® LFIC cylinder	\$108.00			
712F495	FZD - LH Schlage® LFIC cylinder CL3352 inside				

**LOCKSET PARTS**

PART NO.	DESCRIPTION	LIST PRICE
<b>LATCH &amp; STRIKE SCREW PACKS</b>		
604F228 Fin	Latch & ANSI (4 7/8") strike - phillips head	\$6.00
604F238 Fin	Latch & ANSI (4 7/8") strike - spanner head	\$14.00
604F248 Fin	Latch & ANSI (4 7/8") strike - Torx head	\$14.00
604F268 Fin	Latch & T (2 3/4") strike - phillips head	\$6.00
604F278 Fin	Latch & T (2 3/4") strike - spanner head	\$14.00
604F288 Fin	Latch & T (2 3/4") strike - Torx head	\$14.00
480F688 Fin	Rabbetted Strike - phillips head	\$6.00
596F618 Fin	Rabbetted Strike - spanner head	\$14.00
596F628 Fin	Rabbetted Strike - Torx head	\$14.00
<b>MOUNTING SCREW PACKS</b>		
682F608	1 3/4" - 2" doors (pre June 2004)	\$6.00
710F658	1 3/4" - 2" doors (after June 2004)	
682F618	Over 2" (pre June 2004)	\$9.50
710F668	Over 2" (after June 2004)	
682F628	CL3380, CL3381 1 3/4" - 2" doors	\$6.00
682F638	CL3380, CL3381 over 2" doors	\$9.50
682F64 Fin	CL3390, CL3391 1 3/4" - 2" phillips head	\$7.50
682F67 Fin	CL3390, CL3391 1 3/4" - 2" spanner head	\$14.00
682F68 Fin	CL3390, CL3391 1 3/4" - 2" Torx head	\$14.00
682F65 Fin	CL3390, CL3391 over 2" phillips head	\$46.00
682F86 Fin	CL3390, CL3391 over 2" spanner head	\$46.00
682F87 Fin	CL3390, CL3391 over 2" Torx head	\$46.00
684F44 Fin	CL3350 Half Dummy Trim - phillips head	\$9.50
684F45 Fin	CL3350 Half Dummy Trim - spanner head	\$46.00
684F46 Fin	CL3350 Half Dummy Trim - Torx head	\$46.00
684F528	CL3370 Half Dummy Trim	\$6.00
<b>BUTTONS</b>		
585F76 Fin	Turnbutton CL3351	\$21.00
585F77 Fin	Pushbutton CL3320, CL3320H, CL3320TO, CL3340, CL3361, CL3375	\$21.00
585F78 Fin	Hotel button CL3329	
585F79 Fin	Slotted button CL3393	

PART NO.	DESCRIPTION	LIST PRICE
<b>FRONT PLATE RABBETTED STRIKE</b>		
315F93 Fin*	606, 612, 619, 626, 605, 611, 613, 625	\$58.00
<b>RABBETTED STRIKE</b>		
315F94 Fin*	606, 612, 619, 626, 605, 611, 613, 625	\$58.00
601F283 Fin*	Rabbetted Strike & Front	\$91.00

**ROSES**

678F25 Fin	Rose	\$27.00
598F59 Fin	Blank Rose	\$27.00
710F618	Rose liner I/S 1 3/4" - 2" after June 2004	\$6.00
710F628	Rose liner I/S over 2" after June 2004	\$6.00
678F248	Rose liner O/S 1 3/4" - 2"	
678F498	Rose liner O/S over 2"	\$6.00
586F51 Fin	Thumbturn ass'y 1 3/4" - 2"	\$90.00
686F88 Fin	Thumbturn ass'y over 2"	
682F788	Rose liner CL3380, CL3381	\$27.00

**STRIKES - 4 7/8" ANSI CURVED LIP**

217L13M016	1" Lip Length	\$24.00
217L13M018	1 1/8" Lip Length	
217L13M020	1 1/4" Lip Length	
217L13M022	1 3/8" Lip Length	
217L13M024	1 1/2" Lip Length	
217L13M028	1 3/4" Lip Length	\$24.00
217L13M032	2" Lip Length	
217L13M036	2 1/4" Lip Length	
217L13M040	2 1/2" Lip Length	
217L13M044	2 3/4" Lip Length	
217L13M048	3" Lip Length	

**STRIKES - 2 3/4" T-CURVED LIP**

586L19M016	1" Lip Length	\$24.00
586L19M018	1 1/8" Lip Length	
586L19M020	1 1/4" Lip Length	
586L19M022	1 3/8" Lip Length	
586L19M024	1 1/2" Lip Length	
586L19M028	1 3/4" Lip Length	\$24.00
586L19M032	2" Lip Length	
586L19M036	2 1/4" Lip Length	
586L19M040	2 1/2" Lip Length	
586L19M044	2 3/4" Lip Length	
586L19M048	3" Lip Length	

**EMERGENCY RELEASE TOOL**

679F818	Emergency Release Tool (CL3320)	\$2.00
601F829	Emergency Release Label (CL3320)	

## ASSA ABLOY

PART NO.	DESCRIPTION	LIST PRICE
<b>BUTTONS</b>		<b>ALL FINISH</b>
585F762	CL3551 (Turn Button)	\$21.00
585F772	CL3520, 61 (Push Button)	\$19.00
<b>CASSETTE HOUSING O/S</b>		<b>NO FINISH</b>
796F378	Standard	\$30.00
686F858	CL3550, 70	\$108.00
<b>CASSETTE HOUSING I/S</b>		<b>NO FINISH</b>
796F408	CL3580, 81	\$21.00
686F868	CL3570	\$99.00
796F398	Standard I/S Spring Housing	\$11.00
<b>CHASSIS ASSEMBLY, STANDARD</b>		<b>NO FINISH</b>
796F208	CL3510	\$84.00
796F218	CL3520, 61	\$120.00
796F248	CL3580	\$120.00
796F228	CL3551, 57	\$120.00
796F238	CL3555	\$120.00
796F258	CL3581	\$136.00
796F268	CL3582	\$161.00
<b>CHASSIS ASSEMBLY, LFIC</b>		<b>NO FINISH</b>
796F318	CL3561	\$120.00
796F328	CL3551, 57	\$120.00
796F338	CL3555	\$127.00
796F358	CL3581	\$142.00
796F368	CL3582	\$168.00
<b>CYLINDER PARTS</b>		<b>NO FINISH</b>
622F308	Tailpiece 6-Pin	\$2.00
682F298	Tailpiece 7-pin	\$2.00
682F398	M06 - Schlage® tailpiece kit	\$6.50
682F969	M09 - Sargent® tailpiece kit	\$18.00
631F248	C6/C7 - LFIC tailpiece kit	\$6.00
682F958	M08 - small format IC kit	\$6.00
697F942	M69 - Schlage® IC tailpiece kit	\$24.00
<b>HOUSING ASSEMBLIES</b>		
796F388	Housing Assembly, I/S, D134	\$21.00
796F398	Housing Assembly, I/S, D138	\$16.00

PART NO.	DESCRIPTION	LIST PRICE
<b>LATCHES</b>		<b>ALL FINISH</b>
<b>Deadlocking Latches</b>		
599F92	2-3/8" backset x 1" front	\$65.00
599F95	2-3/8" backset x 1" round corner	
599F98	2-3/8" backset x 1-1/8" front	
600F01	2-3/8" backset x 1-1/8" round corner	
600F04	2-3/4" backset x 1" front	
600F07	2-3/4" backset x 1" round corner	
600F10	2-3/4" backset x 1-1/8" front	
600F13	2-3/4" backset x 1-1/8" round corner	\$90.00
600F63	3-3/4" backset x 1-1/8" front	
600F66	3-3/4" backset x 1-1/8" round corner	
600F69	5" backset x 1-1/8" front	\$90.00
600F72	5" backset x 1-1/8" round corner	
<b>Deadlocking Latches with Release (CL3520)</b>		
599F93	2-3/8" backset x 1" front	\$65.00
599F96	2-3/8" backset x 1" round corner	
599F99	2-3/8" backset x 1-1/8" front	
600F02	2-3/8" backset x 1-1/8" round corner	
600F05	2-3/4" backset x 1" front	
600F08	2-3/4" backset x 1" round corner	
600F11	2-3/4" backset x 1-1/8" front	
600F14	2-3/4" backset x 1-1/8" round corner	\$90.00
600F64	3 3/4" backset x 1 1/8" front	
600F67	3-3/4" backset x 1-1/8" round corner	\$90.00
600F70	5" backset x 1 1/8" front	
600F73	5" backset x 1-1/8" round corner	
<b>Plain Spring Latches (CL3610)</b>		
599F91	2-3/8" backset x 1" front	\$65.00
599F94	2-3/8" backset x 1" round corner	
599F97	2-3/8" backset x 1-1/8" front	
600F00	2-3/8" backset x 1-1/8" round corner	
600F03	2-3/4" backset x 1" front	
600F06	2-3/4" backset x 1" round corner	
600F09	2-3/4" backset x 1-1/8" front	
600F12	2-3/4" backset x 1-1/8" round corner	\$90.00
600F62	3-3/4" backset x 1-1/8" front	
600F65	3-3/4" backset x 1-1/8" round corner	\$90.00
600F68	5" backset x 1-1/8" front	
600F71	5" backset x 1-1/8" round corner	

# CL3500 Cylindrical Lock Series Heavy-Duty Lever Lockset

*January 1, 2019*

PART NO.	DESCRIPTION	LIST PRICE
<b>LEVERS</b>		<b>ALL FINISH</b>
598F815	AZD x plain	\$89.00
598F825	AZD x cylinder or button	\$89.00
598F835	AZD x emergency hole	\$89.00
598F905	AZD x C6 LFIC 6-pin	\$89.00
599F275	AZD x C7 LFIC 7-pin	\$89.00
797F845	NZD x plain	\$89.00
797F855	NZD x cylinder or button	\$89.00
797F865	NZD x emergency hole	\$89.00
797F875	NZD x M09 Sargent® cylinder	\$89.00
797F915	NZD x C6 LFIC 6-pin	\$89.00
797F925	NZD x C7 LFIC 7-pin	\$89.00
797F935	NZD x M69 Schlage LFIC	\$89.00
797F945	NZD x M08 SFIC	\$89.00
798F115	PZD x plain	\$89.00
798F125	PZD x cylinder or button	
798F135	PZD x emergency hole	
798F145	PZD x M09 Sargent® cylinder	\$89.00
798F155	PZD x C6 LFIC 6-pin	
798F165	PZD x C7 LFIC 7-pin	
798F175	PZD x M69 Schlage® LFIC	\$89.00
798F185	PZD x M08 SFIC	
<b>LEVER INSERT</b>		<b>ALL FINISH</b>
598F809	Standard	\$2.00
<b>MOUNTING SCREW PACK</b>		
796F118	Standard	\$4.00
797F828	Standard - CL3580, 81	\$12.50
684F448	CL3550 (ALL FINISH)	\$9.50
684F528	CL3570	\$6.00

PART NO.	DESCRIPTION	LIST PRICE
<b>ROSES</b>		<b>ALL FINISH</b>
678F252	Standard	\$29.00
598F592	Blank - CL3580, 81	\$29.00
<b>ROSE LINER O/S</b>		<b>NO FINISH</b>
678F248	Standard	\$5.50
682F788	CL3580, 81	\$27.00
<b>SCREW PACKS FOR LATCH &amp; STRIKE</b>		
604F228	For Latch & ANSI Strike	\$6.00
604F268	For Latch & (T strike)	\$6.00
<b>STRIKES</b>		<b>NO FINISH</b>
<b>ANSI Curved Lip Strike</b>		
217L13M016	1" Lip Length	\$24.00
217L13M018	1-1/8" Lip Length	
217L13M020	1-1/4" Lip Length	
217L13M022	1-3/8" Lip Length	
217L13M024	1-1/2" Lip Length	
217L13M028	1-3/4" Lip Length	\$24.00
217L13M032	2" Lip Length	
217L13M036	2-1/4" Lip Length	
217L13M040	2-1/2" Lip Length	
217L13M044	2-3/4" Lip Length	
217L13M048	3" Lip Length	
<b>STRIKE BOX</b>		<b>NO FINISH</b>
025F858	Curved lip (T strike)	\$3.00

## CL3700 Cylindrical Lock Series Grade 2 Key-In-Lever Locksets

<b>CL3700 SERIES</b>		
PART NO.	DESCRIPTION	LIST PRICE
<b>MISCELLANEOUS</b>		
679F818	Emergency Release Tool	\$2.50



### CL3800 PARTS

PART NO.	DESCRIPTION	LIST PRICE	PART NO.	DESCRIPTION	LIST PRICE
<b>BUTTONS</b>			<b>CYLINDER PARTS</b>		
<b>ALL FINISH</b>			<b>NO FINISH</b>		
585F762	CL3851 (Turn Button)	\$21.00	622F308	Tailpiece 6-Pin	\$2.00
585F772	CL3820, 40, 61 (Push Button)	\$19.00	682F298	Tailpiece 7-pin	\$2.00
585F792	CL3893 (Slotted Turn Button)	\$19.00	682F398	M06 - Schlage® tailpiece kit	\$18.00
<b>CASSETTE HOUSING O/S</b>			<b>NO FINISH</b>		
796F378	Standard	\$30.00	682F969	M09 - SARGENT® tailpiece kit	\$18.00
686F858	CL3850, 70	\$108.00	631F248	C6/C7 - LFIC tailpiece kit	\$6.00
<b>CASSETTE HOUSING I/S</b>			<b>NO FINISH</b>		
796F398	Standard - 1-3/8" to 1-7/8" door	\$16.00	682F958	M08 - SFIC kit	\$6.00
797F808	D214 - 2" to 2-1/4" door	\$21.00	697F942	M69 - Schlage® LFIC tailpiece kit	\$24.00
796F408	CL3880, 81	\$21.00	<b>LATCHES</b>		
686F868	CL3870	\$99.00	<b>ALL FINISH</b>		
<b>CHASSIS ASSEMBLY, STANDARD</b>			<b>NO FINISH</b>		
<b>NO FINISH</b>			<b>Deadlocking Latches</b>		
797F618	CL3810	\$51.00	599F92	2-3/8" backset x 1" front	\$65.00
797F628	CL3820, 61	\$58.00	599F95	2-3/8" backset x 1" round corner	
797F648	CL3840	\$58.00	599F98	2-3/8" backset x 1-1/8" front	
797F788	CL3840NT	\$58.00	600F01	2-3/8" backset x 1-1/8" round corner	
797F658	CL3880, 90	\$51.00	600F04	2-3/4" backset x 1" front	
797F668	CL3851, 57, 93	\$62.00	600F07	2-3/4" backset x 1" round corner	
797F688	CL3855	\$62.00	600F10	2-3/4" backset x 1-1/8" front	
797F708	CL3881, 91	\$62.00	600F13	2-3/4" backset x 1-1/8" round corner	\$90.00
797F728	CL3832	\$66.00	600F63	3-3/4" backset x 1-1/8" front	
797F748	CL3862	\$66.00	600F66	3-3/4" backset x 1-1/8" round corner	\$90.00
797F768	CL3872	\$66.00	600F69	5" backset x 1-1/8" front	\$90.00
<b>CHASSIS ASSEMBLY, IC</b>			<b>NO FINISH</b>		
<b>NO FINISH</b>			<b>Deadlocking Latches with Release (CL3820, 40, 93)</b>		
797F638	CL3861	\$60.00	599F93	2-3/8" backset x 1" front	\$65.00
797F678	CL3851, 57, 93	\$64.00	599F96	2-3/8" backset x 1" round corner	
797F698	CL3855	\$64.00	599F99	2-3/8" backset x 1-1/8" front	
797F718	CL3881, 91	\$64.00	600F02	2-3/8" backset x 1-1/8" round corner	
797F738	CL3832	\$68.00	600F05	2-3/4" backset x 1" front	
797F758	CL3862	\$68.00	600F08	2-3/4" backset x 1" round corner	
797F778	CL3872	\$68.00	600F11	2-3/4" backset x 1-1/8" front	
			600F14	2-3/4" backset x 1-1/8" round corner	\$90.00
			600F64	3 3/4" backset x 1 1/8" front	
			600F67	3-3/4" backset x 1-1/8" round corner	\$90.00
			600F70	5" backset x 1 1/8" front	\$90.00
			600F73	5" backset x 1-1/8" round corner	\$90.00
			<b>Plain Spring Latches (CL3610)</b>		
			599F91	2-3/8" backset x 1" front	\$65.00
			599F94	2-3/8" backset x 1" round corner	
			599F97	2-3/8" backset x 1-1/8" front	
			600F00	2-3/8" backset x 1-1/8" round corner	
			600F03	2-3/4" backset x 1" front	
			600F06	2-3/4" backset x 1" round corner	
			600F09	2-3/4" backset x 1-1/8" front	
			600F12	2-3/4" backset x 1-1/8" round corner	\$90.00
			600F62	3-3/4" backset x 1-1/8" front	
			600F65	3-3/4" backset x 1-1/8" round corner	\$80.00
			600F68	5" backset x 1-1/8" front	\$90.00
			600F71	5" backset x 1-1/8" round corner	\$82.00

## CL3800 PARTS

PART NO.	DESCRIPTION	LIST PRICE
<b>LEVERS 1-3/8" to 1-7/8" Doors</b>		<b>ALL FINISH</b>
598F815	AZD x plain	\$89.00
598F825	AZD x cylinder or button	\$89.00
598F835	AZD x emergency hole	\$89.00
598F905	AZD x C6 LFIC 6-pin	\$89.00
599F275	AZD x C7 LFIC 7-pin	\$89.00
797F845	NZD x plain	\$89.00
797F855	NZD x cylinder or button	\$89.00
797F865	NZD x emergency hole	\$89.00
797F875	NZD x M09 Sargent® cylinder	\$89.00
797F915	NZD x C6 LFIC 6-pin	\$89.00
797F925	NZD x C7 LFIC 7-pin	\$89.00
797F935	NZD x M69 Schlage LFIC	\$89.00
797F945	NZD x M08 SFIC	\$89.00
798F115	PZD x plain	\$89.00
798F125	PZD x cylinder or button	\$89.00
798F135	PZD x emergency hole	\$89.00
798F145	PZD x M09 Sargent® cylinder	\$89.00
798F155	PZD x C6 LFIC 6-pin	\$89.00
798F165	PZD x C7 LFIC 7-pin	\$89.00
798F175	PZD x M69 Schlage® LFIC	\$89.00
798F185	PZD x M08 SFIC	\$89.00
<b>LEVERS 2" to 2-1/4" Doors - D214</b>		<b>ALL FINISH</b>
684F775	AZD x plain	\$108.00
684F785	AZD x cylinder or button	\$106.00
684F795	AZD x emergency hole	\$106.00
684F805	AZD x C6 LFIC 6-pin	\$108.00
684F815	AZD x C7 LFIC 7-pin	\$106.00
684F825	NZD x plain	\$108.00
684F835	NZD x cylinder or button	\$106.00
684F845	NZD x emergency hole	\$106.00
684F855	NZD x M09 Sargent® cylinder	\$106.00
684F865	NZD x C6 LFIC 6-pin	\$108.00
684F875	NZD x C7 LFIC 7-pin	\$106.00
690F985	NZD x M69 Schlage® LFIC	\$106.00
684F885	NZD x M08 SFIC	\$108.00
798F215	PZD x plain	\$106.00
798F225	PZD x cylinder or button	\$106.00
798F235	PZD x emergency hole	\$106.00
798F245	PZD x M09 Sargent® cylinder	\$106.00
798F255	PZD x C6 LFIC 6-pin	\$106.00
798F265	PZD x C7 LFIC 7-pin	\$106.00
798F275	PZD x M69 Schlage® LFIC	\$106.00
798F285	PZD x M08 SFIC	\$106.00

PART NO.	DESCRIPTION	LIST PRICE
<b>LEVER INSERT</b>		<b>ALL FINISH</b>
598F809	Standard - 1-3/8" to 1-7/8" door	\$2.00
684F539	D214 - 2" to 2-1/4" door	\$42.00
<b>MOUNTING SCREW PACK</b>		
796F118	Standard - 1-3/8" to 1-7/8" door	\$4.00
797F818	D214 - 2" to 2-1/4" door	\$16.00
797F828	Standard - CL3880, 81, 90, 91	\$12.50
797F838	D214 - CL3880, 81, 90, 91	\$16.00
684F448	CL3850 (ALL FINISH)	\$9.50
684F528	CL3870	\$6.00
<b>ROSES</b>		<b>ALL FINISH</b>
678F252	Standard	\$29.00
598F592	Blank - CL3880, 81	\$29.00
<b>ROSE LINER O/S</b>		<b>NO FINISH</b>
678F248	Standard - 1-3/8" to 1-7/8" door	\$5.50
678F498	D214 - 2" to 2-1/4" door	\$6.00
682F788	CL3880, 81	\$27.00
<b>SCREW PACK FOR LATCH &amp; STRIKE</b>		<b>ALL FINISH</b>
604F228	For Latch & ANSI Strike	\$6.00
604F268	For Latch & 'T' or Full Lip Strike	\$6.00
<b>STRIKES*</b>		<b>ALL FINISH</b>
680L52	ANSI Curved Lip Blank Strike	\$24.00
586L19	T-Strike	
680L50	Full Lip Strike	
680L51	Full Lip Strike 1/4" Radius (Available Only 1-1/4" Lip)	\$15.00
<b>STRIKE BOX</b>		<b>NO FINISH</b>
025F858	Curved lip (T strike)	\$3.00
<b>THUMBTURNS</b>		<b>ALL FINISH</b>
586F512	Standard - CL3890, 91	\$90.00
686F882	D214 - CL3890, 91	\$90.00

\*Specify length and finish

### LOCKSET PARTS

PART NO.	DESCRIPTION	LIST PRICE	PART NO.	DESCRIPTION	LIST PRICE
<b>SCREW PACKET</b>			<b>STRIKE (Cont'd)</b>		
<b>605, 613E, 630</b>			<b>Curved Lip Box Strike</b>		
556F558	for CK4350 †Order 50-	\$2.00	586L19M016	1" Lip Length	\$24.00
604F268	for curved lip strike	\$5.00	586L19M018	1-1/8" Lip Length	
604F298	for curved lip strike x hex head (M04)	\$11.50	586L19M020	1-1/4" Lip Length	
604F278	for curved lip strike x spanner head (M02)	\$15.00	586L19M022	1-3/8" Lip Length	
604F288	for curved lip strike x Torx® head (M04)	\$14.00	586L19M024	1-1/2" Lip Length	
604F258	for hex head (M04)	\$4.50	586L19M028	1-3/4" Lip Length	
604F238	for spanner head (M02)	\$14.00	586L19M032	2" Lip Length	\$24.00
480F68	for SR118	\$5.00	586L19M036	2-1/4" Lip Length	
596F638	for SR118 & hex head (M04)	\$6.50	586L19M040	2-1/2" Lip Length	
596F618	for SR118 & spanner head (M02)	\$7.50	586L19M044	2-3/4" Lip Length	
596F628	for SR118 & Torx head (M04)	\$7.50	586L19M048	3" Lip Length	
604F228	standard	\$5.00			
604F248	for Torx head (M04)	\$14.00			
224F008*	Screw, Sems Assembly #8 -32 X 1-1/4" †Order 100-	\$2.00			
<b>STRIKE</b>					
<b>605, 613E, 630</b>					
<b>ANSI Curved Lip Strike</b>					
217L13M016	1" Lip Length	\$24.00			
217L13M018	1-1/8" Lip Length				
217L13M020	1-1/4" Lip Length				
217L13M022	1-3/8" Lip Length				
217L13M024	1-1/2" Lip Length				
217L13M028	1-3/4" Lip Length				
217L13M032	2" Lip Length	\$24.00			
217L13M036	2-1/4" Lip Length				
217L13M040	2-1/2" Lip Length				
217L13M044	2-3/4" Lip Length				
217L13M048	3" Lip Length				

†Sold only in multiples of the number indicated. Price is each.

## CK4400 SERIES

PART NO.	DESCRIPTION	LIST PRICE	PART NO.	DESCRIPTION	LIST PRICE
<b>STRIKES AND WROUGHT BOX</b>			<b>ROSE NO FINISH</b>		
ANSI TYPE 605, 606, 611, 612, 613, 619, 625, 626			579F11	Screw Packet & Strike Box	\$5.50
217L13M016	1" Lip to Center	\$24.00	580F387	Rose Sub Assembly, stainless I/S	\$16.00
217L13M018	1-1/8" Lip to Center		580F38	Rose Sub Assembly I/S	\$14.50
217L13M020	1-1/4" Lip to Center (standard)		<b>LATCHES</b>		
217L13M022	1-3/8" Lip to Center		574F29	2-3/8" deadlatch	\$38.00
217L13M024	1-1/2" Lip to Center		574F30	2-3/8" deadlatch with throw-off	
217L13M028	1-3/4" Lip to Center	574F55	2-3/4" deadlatch		
217L13M032	2" Lip to Center	574F56	2-3/4" deadlatch with throw-off		
217L13M036	2-1/4" Lip to Center	\$24.00	574F29 x574F25	3-3/4" deadlatch	\$67.00
217L13M040	2-1/2" Lip to center		574F30 x574F25	3-3/4" deadlatch with throw-off	
217L13M044	2-3/4" Lip to Center		574F29 x574F26	5" deadlatch	
217L13M048	3" Lip to Center		574F30 x574F26	5" deadlatch with throw-off	
<b>CURVED LIP BOX TYPE STRIKE</b>			<b>BACKSET EXTENDER KIT</b>		
605, 606, 611, 612, 613, 619, 625, 626			574F258	Extender ONLY (No Latch Unit) - Must be added to 2-3/8" Latch Unit	\$30.00
586L19M016	1" Lip Length	\$24.00	574F268	Extender ONLY (No Latch Unit) - Must be added to 2-3/8" Latch Unit	
586L19M018	1-1/8" Lip Length				
586L19M020	1-1/4" Lip Length				
586L19M022	1-3/8" Lip Length				
586L19M024	1-1/2" Lip Length				
586L19M028	1-3/4" Lip Length	\$24.00			
586L19M032	2" Lip Length				
586L19M036	2-1/4" Lip Length				
586L19M040	2-1/2" Lip Length				
586L19M044	2-3/4" Lip Length				
586L19M048	3" Lip Length				

### LOCKSET PARTS

PART NO.	DESCRIPTION	LIST PRICE	PART NO.	DESCRIPTION	LIST PRICE
<b>BUSHING NO FINISH</b>			<b>HUB SPACER NO FINISH</b>		
194F228	Bushing	\$3.50	060F338	for UT5210, 61 †Order 50-	\$2.00
<b>BUTTON ASSEMBLY 612, 613, 619, 625, 626</b>			070F428	for UT5220 †Order 50-	\$2.00
022F80	for UT5220	\$54.00	070F438	for UT5220 †Order 50-	\$4.00
157F11	for UT5251		606F038	for UT5255	\$2.00
156F43	for UT5261		067F428	for UT5257	\$3.50
<b>CHASSIS COVER NO FINISH</b>			<b>LEVER 612, 613, 619, 625, 626</b>		
138F888	Chassis Cover	\$6.50	582F122	cyl/button LH	\$198.00
<b>CHASSIS 612, 613, 619, 625, 626</b>			582F112	cyl/button RH	
496F33	for UT5210	\$311.00	582F142	cyl/button LH tactile	\$198.00
496F34	for UT5220		582F132	cyl/button RH tactile	
496F32	for UT5251, 55, 57, 72		489F892	LFIC 6-pin LH	\$198.00
198F71	for UT5261		489F882	LFIC 6-pin RH	
381F30	for UT5282		549F362	LFIC 6-pin LH tactile	\$204.00
<b>CORE HOUSING NO FINISH</b>			549F352	LFIC 6-pin RH tactile	
342F052	for 6-pin LFIC	\$11.50	613F232	LFIC 7-pin LH	\$198.00
442F952	for 7-pin LFIC		613F222	LFIC 7-pin RH	
613F352	for 6/7 pin Best-type LFIC	\$9.00	613F252	LFIC 7-pin LH tactile	\$204.00
<b>COUPLING NO FINISH</b>			613F242	LFIC 7-pin RH tactile	
131F278	Coupling	\$53.00	613F112	plain LH	\$198.00
<b>EMERGENCY KEY NO FINISH</b>			613F102	plain RH	
679F818	for UT5220	\$2.00	613F152	plain LH tactile	\$198.00
<b>ESCUTCHEON 612, 613, 619, 625, 626</b>			613F142	plain RH tactile	
144F33	for inside lever	\$153.00	613F132	priv. key hole LH	\$198.00
415F16	for outside knob		613F122	priv. key hole RH	
144F34	for outside lever		613F172	priv. key hole LH tactile	\$198.00
605F90	for inside lever, lead lined		613F162	priv. key hole RH tactile	
301F567	for outside lever, ext. lip 630 only		613F432	Best - type core prep LH	\$217.00
<b>GRIP RETAINER NO FINISH</b>			613F422	Best - type core prep RH	
078F078	Grip Retainer †Order 50-	\$2.00	<b>LEVER INSERT NO FINISH</b>		
<b>HUB NO FINISH</b>			613F029	Lever Insert †Order 50-	\$2.00
060F428	for all but UT5255	\$3.50	<b>LEVER SPRING ANCHOR NO FINISH</b>		
071F628	for UT5210	\$4.50	171F798	Lever Spring Anchor	\$16.00
081F778	for UT5220	\$5.00	<b>PIN NO FINISH</b>		
147F078	for UT5251, 55, 72	\$3.00	019F137	Pin, Spindle Drive †Order 50-	\$2.00
140F978	for UT5251, 57, 72	\$3.00	156F837	Pin, UT5261 shank †Order 50-	\$2.00
071F638	for UT5257	\$3.00	286F507	Pin, UT5282 spindle †Order 50-	\$2.00

†Sold only in multiples of the number indicated. Price is each.

PART NO.	DESCRIPTION	LIST PRICE
<b>PLUG DRIVER NO FINISH</b>		
144F888	Plug Driver & Spindle Assembly UT5282	\$39.00
168F818	Plug Driver Assembly	\$25.00
144F298	Plug Driver UT5251, 57, 72	\$15.00
606F018	Plug Driver UT5255	\$14.00
145F328	Plug Driver UT5282	\$39.00
<b>RETAINING RING NO FINISH</b>		
251F198	Retaining Ring for UT5282 Spindle †Order 100-	\$2.00
<b>SCREW 612, 619, 626, 613, 625</b>		
480F70	Screw Pkt. (strike mount'g) †Order 20-	\$2.50
<b>No Finish</b>		
249F768	Screw, Fixed Escutcheon †Order 50-	\$2.00
092F789	Screw, Strike Adjustment (nylon) †Order 50-	\$2.00
<b>SHANK, LEVER NO FINISH</b>		
102F198	for UT5210, 57 outside	\$47.00
102F378	for UT5220 inside	
114F678	for UT5220 outside	
188F758	for UT5251, 57, 72 outside	
188F738	for UT5251, 72 inside	\$53.00
605F768	for UT5255 inside	\$49.00
605F778	for UT5255 outside	\$49.00
156F658	for UT5261 inside	\$85.00
156F648	for UT5261 outside	\$57.00
102F278	for UT5282 inside	\$49.00
287F608	for UT5282 outside	\$72.00
<b>SHANK RETAINER NO FINISH</b>		
242F508	for lever †Order 50-	\$2.00

† Sold only in multiples of the number indicated. Price is each.

PART NO.	DESCRIPTION	LIST PRICE
<b>SPINDLE NO FINISH</b>		
201F188	for UT5220	\$7.50
144F308	for UT5251, 72	\$7.00
606F028	for UT5255	\$7.50
335F988	for UT5257	\$10.50
<b>SPRING NO FINISH</b>		
022F723	Spring, Button UT5220, 61 †Order 50-	\$2.00
103F458	Spring, Lever Return LH	\$9.00
103F448	Spring, Lever Return RH	\$9.00
060F053	Spring, Shoe UT5220, 61 †Order 100-	\$2.00
071F673	Spring, Spindle for UT5220 †Order 100-	\$2.00
249F773	Spring, Spindle for UT5251, 55, 57, 72 †Order 100-	\$2.00
261F118	Spring, Spindle for UT5282 †Order 100-	\$2.00
<b>STRIKE 612, 613, 625, 626</b>		
236L75M020	ANSI curved lip	\$23.00
610L44	ANSI straight lip	
610L43	ANSI straight lip for ext. esc.	
083L96M032	curved lip box, 2"	
083L96M036	curved lip box, 2-1/4"	
083L96M034	curved lip box, 2-1/8" (std)	
083L96M040	curved lip box, 2-1/2"	
083L96M048	curved lip box, 3"	
293L14	curved lip box for ext. lip esc.	
082L67	pairs of doors	
<b>THROUGHBOLT</b>		
222F85	Regular	\$5.50
223F29	Spanner head	\$5.00
<b>THROW MEMBER NO FINISH</b>		
320F442	for Best® style core	\$6.00
342F032	for Corbin Russwin core	\$6.00

**Padlocks and Deadlocks**

<b>PADLOCKS</b>			
PART NO.	DESCRIPTION	LIST PRICE	SOLD IN MULT. OF
422L842144	Chain & clevis, 9" brass	\$21.00	1
422L848144	Chain & clevis, 9" steel	\$19.00	1
303F242	Pin chamber cap	\$2.00	100
228F348	Plug retainer, oversize Spirol pin	\$2.00	100
244F647	Plug retainer, standard solid pin	\$2.00	20
405F772	Security disc	\$2.00	50
756F963	Throw member, LFIC models	\$8.50	10
<b>DL4100 SERIES DEADLOCK PARTS</b>			
PART NO.	DESCRIPTION	LIST PRICE	SOLD IN MULT. OF
796F46 x Fin	Outside Front	\$85.00	
796F30 x Fin	Thumbturn Assembly	\$71.00	
791F51 x Fin	Ergonomic Thumbturn Assembly	\$65.00	
<b>Mouting Packs:</b>			
791F82 Fin	Screw Pack - Standard Strike	\$21.00	
791F83 Fin	Spanner Head crew Pack - Standard Strike	\$14.00	
791F84 Fin	Torx Head Screw Pack - Standard Strike	\$14.00	
791F85 Fin	Screw Pack - ANSI Strike	\$5.00	
791F86 Fin	Spanner Head crew Pack - ANSI Strike	\$14.00	
791F87 Fin	Torx Head Screw Pack - ANSI Strike	\$14.00	
<b>Strikes:</b>			
796F43	Standard Strike	\$13.00	
240L08018	ANSI Strike 1-3/4" Door	\$21.00	
240L08020	ANSI Strike 2" Door	\$21.00	
240L08022	ANSI Strike 2-1/4" Door	\$21.00	
466F279	Strike Box	\$9.00	

<b>DL3000 SERIES DEADLOCKS</b>			
PART NO.	DESCRIPTION	LIST PRICE	SOLD IN MULT. OF
261F298	Allen wrench 5/64"	\$3.00	10
467F36	Bolt front	\$16.00	1
467F345	Cylinder housing	\$50.00	1
467F338	Cylinder housing screw	\$2.00	20
480F708	Screw pack for ANSI strike	\$2.50	20
480F69	Screw pack for strikes 424F83 and 394F19	\$3.50	20
283F81	Collar Base / Rose	\$46.00	1
<b>Strike, 2-3/4" x 1-1/8</b>			
424F838	605, 606, 611, 612, 613, 618, 619, 625, 626	\$29.00	1
		\$16.50	1
		\$21.00	1
394F198	Strike, 3-1/2" x 1-1/8"	\$20.00	1
<b>Strike, ANSI</b>			
423L71	611,613, and all other finishes	\$27.00	1
416F38	Security collar	\$41.00	1
467F358	Bolt, less front -2-3/4" B.S.	\$42.00	1
693F208	Bolt, less front -2-3/8" B.S.	\$42.00	1
467F378	Strike box	\$6.00	1
496F718	Strike box	\$5.00	1

DEVICE PARTS						
PART NO.	DESCRIPTION	LIST PRICE	PART NO.	DESCRIPTION	LIST PRICE	
<b>ACTIVE HEAD (FIELD REVERSIBLE, WHERE HANDED)</b>			<b>DELAYED EGRESS PC BOARDS</b>			
650F378	ED4200	\$242.00	704F269	DEED PC BD SA 36" NFPA-15	\$1,357.00	
681F618	ED4200S	\$258.00	704F279	DEED PC BD SA 36" NFPA-30		
650F418	ED4400 LHR	\$254.00	704F479	DEED PC BD SA 36" BOCA-15		
650F408	ED4400 RHR		704F489	DEED PC BD SA 36" BOCA-30		
650F468	ED4800 LHR	\$265.00	704F569	DEED PC BD SA 48" NFPA-15		
650F458	ED4800 RHR		704F579	DEED PC BD SA 48" NFPA-30		
650F358	ED5200	\$242.00	704F589	DEED PC BD SA 48" BOCA-15		
650F368	ED5200A	\$254.00	704F599	DEED PC BD SA 48" BOCA-30		
706F038	ED5202 RHR	\$284.00	<b>COVER, BAR 605, 606, 611, 612, 613, 619, 625, 626, 629, 630</b>			
706F048	ED5202 LHR		650F07	36"		\$53.00
706F058	ED5202A RHR	\$296.00	650F08	48"	\$53.00	
706F068	ED5202A LHR		<b>COVER, END</b>			
681F608	ED5200S(A)	\$258.00	<b>ED5000DB</b>			
706F078	ED5202S(A) RHR	\$300.00	650F93	605, 606, 611, 612, 613, 619, 625, 626, 629, 630	\$349.00	
706F088	ED5202S(A) LHR		<b>ED4000 36" cyl. dogging</b>			
650F398	ED5400(A) LHR	\$254.00	650F14	605, 606, 611, 612, 613, 619, 625, 626, 629, 630	\$149.00	
650F388	ED5400(A) RHR		<b>ED4000 36" standard</b>			
650F428	ED5600(A)	\$242.00	650F13	605, 606, 611, 612, 613, 619, 625, 626, 629, 630	\$147.00	
706F098	ED5602(A) RHR	\$284.00	<b>ED5000 36" cyl. dogging</b>			
706F108	ED5602(A) LHR		650F12	605, 606, 611, 612, 613, 619, 625, 626, 629, 630	\$149.00	
650F448	ED5800(A) LHR	\$265.00	<b>ED5000(A) 36" standard</b>			
650F438	ED5800(A) RHR		650F11	605, 606, 611, 612, 613, 619, 625, 626, 629, 630	\$147.00	
<b>ARMORED FRONT 605, 606, 611, 612, 613, 619, 625, 626, 629, 630</b>			<b>All 48" standard</b>			
650F06	ED5600	\$16.50	650F15	605, 606, 611, 612, 613, 619, 625, 626, 629, 630	\$160.00	
<b>BAR &amp; CARRIER ASSEMBLY</b>			<b>ED5000 36" cyl. dogging</b>			
650F248	All 48"	\$280.00	<b>ED5000(A) 36" standard</b>			
650F238	ED4000 36"	\$266.00	650F16	605, 606, 611, 612, 613, 619, 625, 626, 629, 630	\$162.00	
650F228	ED5000 36"		<b>All 48" cyl. dogging</b>			
<b>BAR CAP</b>			<b>COVER, TOP &amp; BOTTOM LATCH</b>			
650F189	Black nylon †Order 10-	\$4.50	<b>ED4400, ED5400(A)</b>			
<b>BOTTOM BOLT CASE</b>			650F64	605, 606, 611, 612, 613, 619, 625, 626, 629, 630	\$81.00	
650F588	ED4400, ED5400	\$43.00	<b>CYLINDER DOGGING KIT</b>			
650F598	ED5400A	\$47.00	<b>ED4000 36" bar</b>			
<b>BOTTOM BOLT PACKET</b>			653F13	605, 606, 611, 612, 613, 619, 625, 626, 629, 630	\$145.00	
650F778	ED4800	\$129.00	<b>ED5000 36" bar</b>			
698F038	ED5800(A)	\$114.00	653F12	605, 606, 611, 612, 613, 619, 625, 626, 629, 630	\$145.00	
<b>BOTTOM RAIL</b>			<b>All 48" bar</b>			
650F21	48"	\$168.00	653F14	605, 606, 611, 612, 613, 619, 625, 626, 629, 630	\$153.00	
	606, 612, 630		<b>DOGGING ASSEMBLY</b>			
	605, 613		<b>NO FINISH</b>			
	611, 625, 626, 629		650F968	Cylinder type	\$38.00	
<b>BOTTOM ROD &amp; COUPLER ASSEMBLY</b>			650F528	Hex Key type		
650F798	ED4800, ED5800(A)	\$97.00	<b>DOGGING CYLINDER NUT</b>			
<b>BOTTOM ROD &amp; END PIN ASSEMBLY 605, 606, 611, 612, 613, 618, 619, 625, 626, 629, 630, 722</b>			697F862	Dogging Cylinder Nut	\$15.00	
649F99 fin	Surface devices	\$155.00	<b>NO FINISH</b>			
<b>CARRIER BAR NO FINISH</b>			<b>NO FINISH</b>			
650F998	Internal	\$15.00	<b>NO FINISH</b>			
<b>COVER, ACTIVE HEAD 605, 606, 611, 612, 613, 619, 625, 626, 629, 630</b>			<b>NO FINISH</b>			
650F00	ED5200	\$196.00	<b>NO FINISH</b>			
650F03	ED4200		<b>NO FINISH</b>			
681F63	ED4200S		<b>NO FINISH</b>			
650F04	ED4400		<b>NO FINISH</b>			
650F05	ED4800		<b>NO FINISH</b>			
681F62	ED5200S		<b>NO FINISH</b>			
706F15	ED5602 RHR	\$207.00	<b>NO FINISH</b>			
706F16	ED5602 LHR		<b>NO FINISH</b>			

†Sold only in multiples of the number indicated. Price is each.

### DEVICE PARTS (Cont'd)

PART NO.	DESCRIPTION	LIST PRICE
<b>DOGGING CYLINDER SLEEVE</b>		
650F959	Dogging Cylinder Sleeve	\$8.50
<b>DOGGING HOLE PLUG</b>		
650F279	Dogging Hole Plug †Order 50-	\$2.00
<b>DOGGING KEY, HEX</b>		
656F408	5/32"	\$3.50
<b>END CAP RETROFIT KIT</b>		
704F66	End Cap Retrofit Kit	\$81.00
<b>END CAP</b>		
704F62	End Cap	\$60.00
710F00M	Flush End Cap Retrofit Kit (M110)	\$80.00
<b>END CLAMP PACKET</b>		
704F658	ED4200(S), ED5200S(A)	\$13.00
704F648	ED4000, ED5000(A)	
<b>FLUSH STRIKE TRANSOM BRACKET</b>		
650F878	Flush strike transom brkt., ED5400(A)	\$53.00
<b>LATCH PACKET</b>		
654F218	Latch pkt, ED4400, ED5400 †Order 10-	\$4.50
<b>MORTISE LOCK BODY</b>		
655F488RR	ED5610 knob - RHR	\$331.00
655F488LR	ED5610 knob - LHR	
650F698RR	ED5602, ED5610, ED5655 lever - RHR	\$331.00
650F698LR	ED5602, ED5610, ED5655 lever - LHR	
678F008RR	ED5610, ED5655 thumbpiece - RHR	\$331.00
678F008LR	ED5610, ED5655 thumbpiece - LHR	
650F678RR	ED5650,57 knob, lever/thumbpiece - RHR	\$331.00
650F678LR	ED5650,57 knob, lever/thumbpiece - LHR	
710F318LR	ED5634L - LHR	\$331.00
710F318RR	ED5634L - RHR	
710F328LR	ED5634L - LHR - M91	\$568.00
710F328RR	ED5634L - RHR - M91	
710F338LR	ED5634L - LHR - M93	\$552.00
710F338RR	ED5634L - RHR - M93	
<b>ADAPTER ASSEMBLY, MORTISE</b>		
706F462	ED5602(A)	\$32.00
<b>MOUNTING PACKET</b>		
650F578	ED4400, ED5400(A)	\$87.00
654F208	Non-rated, wood door †Order 20-	\$3.50
<b>900, WS700 &amp; FE700 SERIES MULLION PACKETS</b>		
<b>TOP RETAINER AND SCREW PACKET</b>		
713F518	907, 908, 910, 907A, 908A	\$205.00
713F938	FE707A, FE708A	\$213.00
713F948	907BKM, 908BKM, 910KM	\$205.00
713F958	WS707AKM, WS708AKM	\$213.00
<b>BOTTOM RETAINER AND SCREW PACKET</b>		
713F528	907, 908, 910, 907A, 908A	\$135.00
713F998	FE707A, FE708A	\$213.00
713F988	907BKM, 908BKM, 910KM	\$135.00
713F908	WS707AKM, WS708AKM	\$213.00
<b>LOCKING MECHANISM PACKET</b>		
744F258	907BKM, 908BKM, 910KM	\$443.00
744F208	WS707AKM, WS708AKM	\$460.00
<b>1-1/4" CYLINDER COLLAR PACKET<sup>1</sup></b>		
447F43	907BKM <sup>2</sup> , 908BKM <sup>2</sup> , 910KM <sup>2</sup>	\$19.00
610F01	WS707AKM <sup>2</sup> , WS708AKM <sup>2</sup>	\$30.00
<b>1-1/2" LFIC CYLINDER COLLAR PACKET<sup>1</sup></b>		
609F37	907BKM <sup>2</sup> , 908BKM <sup>2</sup> , 910KM <sup>2</sup>	\$34.00
609F36	WS707AKM <sup>2</sup> , WS708AKM <sup>2</sup>	\$32.00

Notes: 1. Cylinder collar packets contain a collar & spring washer.  
2. Specify finish when ordering packets.

PART NO.	DESCRIPTION	LIST PRICE
<b>ROD EXTENSION KIT (CONCEALED VERTICAL)</b>		
684F427	Rod Extension Kit, 24"	\$85.00
<b>ROD EXTENSION KIT (SURFACE VERTICAL)</b>		
<b>Rod Extension Kit, 2"</b>		
655F15	605, 606, 612, 613, 619, 625, 626, 629, 630	\$84.00
<b>Rod Extension Kit, 6"</b>		
655F16	605, 606, 612, 613, 619, 625, 626, 629, 630	\$97.00
<b>Rod Extension Kit, 12"</b>		
655F17	605, 606, 612, 613, 619, 625, 626, 629, 630	\$101.00
<b>Rod Extension Kit, 24"</b>		
684F42	605, 606, 612, 613, 619, 625, 626, 629, 630	\$103.00
<b>ROD GUIDE COVER</b>		
<b>Rod Guide Cover</b>		
650F63	605, 606, 612, 613, 619, 625, 626, 629, 630	\$33.00
<b>ROD GUIDE PACKET</b>		
<b>Rod Guide Packet</b>		
650F62	606, 612, 613, 626	\$20.00
<b>SCREWS</b>		
605, 606, 611, 612, 613, 619, 625, 626, 629, 630		
429F41	Pack, Armored Front †Order 20-606, 612, 613, 619	\$4.50
704F63	Packet, Cover 606,612,613,630 finish	\$4.00
656F668	#10-24 x 1/4" PH †Order 100-	\$2.00
650F538	Dogging Assembly †Order 50-	\$2.00
650F518	Latch head to carrier †Order 50-	\$2.00
650F288	Touch bar caps (622 only) †Order 50-	\$2.00
650F508	Trim slide †Order 100-	\$2.00
<b>SCREW PACK, TORX® PIN</b>		
701F60	ED4200(S), ED4800, ED5200(S), ED5800	\$16.50
701F61	ED4400, ED5400, ED5470	\$16.50
701F62	ED5600	\$18.00
701F63	ED5860	\$16.50
<b>SEX NUT PACKET</b>		
652F298	Sex Nut Packet (4 sex nuts)	\$20.00
<b>SHIM KIT</b>		
697F338	ED5200(S)(A), ED5600(A), ED5800(A)	\$111.00
697F348	ED5400(A)	\$132.00
697F358	ED4200(S), ED4800	\$111.00
697F368	ED4400	\$132.00
<b>SPRING, TOUCH PAD</b>		
656F41	Spring, Touch Pad	\$3.00
<b>STRIKE PACKET 622 FINISH ONLY</b>		
650F888	bottom for 1/2" threshold (S09)	\$60.00
650F318	ED4200(S), ED4800	\$58.00
730F778	ED5200(S)(A), ED5202(S)(A)	\$83.00
650L65	ED5600	\$37.00
650L657020	Mortise strike for ED5602(A)	\$37.00
653L157014	Mortise strike for doors with astragal	\$33.00
655F718	ED5200 x S02	\$60.00
653L163016	open back straight lip for 1-3/4" door	\$92.00
653L163020	open back straight lip for 2-1/4" door	\$123.00
653L183016	open back curved lip for 1-3/4" door	\$92.00
653L183020	open back curved lip for 2-1/4" door	\$123.00

†Sold only in multiples of the number indicated. Price is each.



### DEVICE PARTS (Cont'd)

PART NO.	DESCRIPTION	LIST PRICE	PART NO.	DESCRIPTION	LIST PRICE
<b>TOP LATCH</b>			<b>TOP STRIKE PACKET</b>		
650F738	Top Latch & Bracket Assembly, ED4800	\$188.00	650F548	Top strike packet	\$79.00
650F718	Top Latch & Bracket Assembly, ED5800	\$190.00	681F708	Top strike packet for ED5470B	\$30.00
650F728	Top Latch & Bracket Assembly, ED5800A	\$203.00	681F778	Top strike for ED5860B	\$34.00
650F558	Top Latch, ED4400, ED5400, ED5470	\$176.00	<b>TOUCH PAD CAP 622 ONLY</b>		
650F568	Top Latch, ED5400A, ED5470B	\$186.00	724F278	Touch Pad Cap, front	\$34.00
681F768	Top Latch, ED5860B	\$213.00	650F095	Touch Pad Cap, rear	\$28.00
681F718	Top Mtg. Plate for ED5470B	\$53.00	<b>TRIM SLIDE NO FINISH</b>		
<b>TOP ROD NO FINISH</b>			650F498	Trim Slide Retainer †Order 10-	\$4.00
650F818	Top Rod Tube, concealed	\$96.00	650F489	Trim Slide, ED4000	\$6.00
650F808	Top Rod, concealed	\$81.00			
	<b>Top Rod, surface</b>				
650F60 fin	605, 606, 611, 612, 613, 619, 625, 626, 629, 630	\$127.00			

### TRIM PARTS, GRIPS

DESIGN	STANDARD PART NO.	STANDARD PRICE 605, 606, 611, 612, 613, 619, 625, 626, 629, 630	KNURLED PART NO.	KNURLED PART PRICE	ABRASIVE PART NO.	ABRASIVE PART PRICE
A7	652F78		652F79		652F80	
C7	652F66		652F67		652F68	
D7 RHR	652F69		652F70		652F71	
D7 LHR	652F72		652F73		652F74	
E7	652F57		652F58		652F59	
G7	656F45		656F48		656F51	
L7	652F60		652F61		652F62	
N7	652F75		652F76		652F77	
PR7	652F81		652F82		652F83	
R7	652F63		652F64		652F65	
A7M	653F71		653F72		653F73	
C7M	653F59		653F60		653F61	
D7M RHR	653F62		653F63			
D7M LHR	653F65		653F66			
E7M	653F50					
G7M	656F44	\$167.00	656F47	\$232.00	656F50	\$209.00
L7M	653F53		653F54		653F55	
N7M	653F68		653F69		653F70	
PR7M	653F74		653F75		653F76	
R7M	653F56		653F57			
A8	653F05					
C8	652F93				652F95	
D8 RHR	652F96					
D8 LHR	652F99					
E8	652F84		652F85		652F86	
G8	656F46		656F49		656F52	
L8	652F87		652F88		652F89	
N8	653F02		653F03		653F04	
PR8	653F08		653F09		653F10	
R8	652F90				652F92	
08, 014	656F53		n/a		n/a	

†Sold only in multiples of the number indicated. Price is each.

### TRIM PARTS, GRIPS, ESCUTCHEONS (Cont'd)

DESIGN	STANDARD PART NO.	STANDARD PRICE 605, 606, 611, 612, 613, 619, 625, 626, 629, 630	KNURLED PART NO.	KNURLED PART PRICE	ABRASIVE PART NO.	ABRASIVE PART PRICE
A9	677F16	\$188.00	652F79	\$253.00	652F80	\$230.00
C9	677F15		652F67		652F68	
D9 RHR	677F26		652F70		652F71	
D9 LHR	677F27		652F73		652F74	
E9	677F13		652F58		652F59	
L9	677F04		652F61		652F62	
N9	677F05		652F76		652F77	
PR9	677F28		652F82		652F83	
R9	677F14		652F64		652F65	
A9M	653F71		653F72		653F73	
C9M	653F59		653F60		653F61	
D9M RHR	653F62		653F63			
D9M LHR	653F65		653F66			
E9M	653F50					
L9M	653F53		653F54		653F55	
N9M	653F68		653F69		653F70	
PR9M	653F74		653F75		653F76	
R9M	653F56		653F57			

DESIGN	PART NO.	LIST PRICE 605, 606, 613, 625, 626
FR9 RHR	698F64	\$188.00
FR9 LHR	698F66	
TS9	698F31	
Z9 RHR	698F68	
Z9 LHR	698F70	
M9	698F33	\$171.00
FR9M RHR	698F65	\$188.00
FR9M LHR	698F67	
TS9M	698F32	
Z9M RHR	698F69	
Z9M LHR	698F71	
M9M	698F34	\$171.00

PART NO.	DESCRIPTION	605, 606, 611, 612, 613, 613E, 619, 625, 626, 629, 630
656F58	x8 cyl. x knob	\$137.00
656F59	x8 cyl. x lever	\$145.00
656F60	x8 plain x knob or thumbturn	\$137.00
656F61	x8 plain x lever	\$145.00
651F00	F450	\$130.00
651F01	F457	
651F10	O14, T14 bottom	\$60.00
656F62	O1410 top	\$130.00
656F63	O1455/59 top	
651F09	T1410 top	\$119.00
651F06	T1450 top	\$114.00
651F08	T1455, T1459 top	\$119.00
651F04	T1457 top	\$114.00
733F41	F950	\$188.00
733F42	F957	
733F43	9M10, M50	
733F05	L910, G910	
733F44	L950, G950	
733F45	L955, G955	
783F06	L955, G955, L959, G959	
733F46	F9M57	
733F47	L957, G957	
733F48	DL910	
733F49	DL9M10, DL9M50	
733F50	DL955, DL959	
733F51	DL9M55, DL9M57	
733F52	DL957	
733F53	DL950	

†Sold only in multiples of the number indicated. Price is each.

### TRIM PARTS (Cont'd)

PART NO.	DESCRIPTION	LIST PRICE
<b>BUSHING, NYLON</b> NO FINISH		
652F239	Bushing, Nylon †Order 20-	\$4.50
<b>CLUTCH LEVER</b> NO FINISH		
651F538	Clutch Lever †Order 20-	\$4.00
<b>COTTER PIN</b> NO FINISH		
677F098	Cotter Pin †Order 100-	\$2.00
<b>COVER PLATE</b> NO FINISH		
651F858	Cover Plate, x8, O14, T14	\$14.00
<b>CYLINDER COLLAR</b>		
	various	see page 337
<b>GEAR &amp; BLACK HOUSING ASSEMBLY</b> NO FINISH		
651F638	Gear & Black Housing Assembly (all but x750)	\$16.00
651F648	Gear, levers	\$6.50
655F548	Gear, dummy lever	
<b>HEX NUT/BUSHING</b> NO FINISH		
651F398	Hex Nut/Bushing for spring	\$5.00
<b>HOUSING</b> NO FINISH		
651F675	Housing & Cam Assembly, x755, T1355	\$44.00
651F965	Housing & Cam Assembly, x855, x859, O/T1455/59	\$36.00
651F425	Housing, Cylinder, F2, F3, T1357, O/T1457	\$7.50
651F545	Housing, Tailpiece Assembly	\$30.00
706F015	Housing, Cylinder ED5202(S)(A), ED5602(A)	\$8.50
706F005	Housing, Cylinder, Trim, ED5202(S)(A), ED5602(A)	\$43.00
<b>HUB</b> NO FINISH		
652F228	Hub	\$25.00
651F655	Hub, lever	\$7.50
656F64	Hub, G knob	\$7.50
<b>LOCK WASHER</b> NO FINISH		
651F448	for screw post †Order 50-	\$2.00
<b>NUT</b> NO FINISH		
651F888	Nut, Cover Plate †Order 50-	\$2.00
651F928	Nut, Spring Post	\$5.50
<b>PIN</b> NO FINISH		
651F838	Pin, Clutch Lever †Order 50-	\$2.00
651F988	Pin, Groove, 5/32" x 1-1/8" for T1410, T1455, T145 †Order 50-	\$2.00
651F587	Pin, Thumbpiece, T13M †Order 20-	\$2.00
<b>PULL</b>		
651F372	Pull, Offset - 605, 606, 611, 612, 613, 619, 625, 626, 629, 630	\$140.00
651F362	Pull, Straight - 605, 606, 611, 612, 613, 619, 625, 626, 629, 630	\$114.00
<b>RACK &amp; TAILPIECE ASSEMBLY</b> NO FINISH		
651F828	x810, x855, x859, O14, T14	\$89.00
652F218	x850	\$77.00
<b>RETAINER, CLUTCH LEVER PIN</b> NO FINISH		
651F898	Retainer, Clutch Lever Pin †Order 100-	\$2.00
<b>RETAINING RING</b> NO FINISH		
651F608	Retaining Ring, T13M †Order 50-	\$2.00
<b>ELECTRIFIED LOCKBODY USED WITH "SAF" &amp; "SEC" ED5600L DEVICES:</b>		
677F768LR 626	LOCK SA-L5 MORT.SAFE LHR	\$763.00
677F768RR 626	LOCK SA-L5 MORT.SAFE RHR	\$763.00
677F778LR 626	LOCK SA-L5 MORT.SEC. LHR	\$763.00
677F778RR 626	LOCK SA-L5 MORT.SEC. RHR	\$763.00
<b>SCREW</b> NO FINISH		
655F028	Screw, Cylinder Mounting †Order 100-	\$2.00
651F878	Screw, FHM-PH #8-32 x 7/16" †Order 50-	\$2.00

PART NO.	DESCRIPTION	LIST PRICE
<b>SCREW (CONT'D)</b> NO FINISH		
656F658	Screw, Function	\$2.00
651F418	Screw, RHM-PH #1/4-20 x 5/8" †Order 50-	\$2.00
651F508	Screw, Tailpiece Plate, PHT-T-PH #6 x 3/8 †Order 50-	\$2.00
<b>SCREW PACKET, MOUNTING</b>		
652F128	1-3/4" - 2" door - 606, 612, 613, 619, 626	\$8.00
652F108	1-3/4" - 2" door - 606, 612, 613, 619, 626	\$6.00
652F118	2-1/4" door - 606, 612, 613, 619, 626	\$6.00
652F138	2-1/4" door - 606, 612, 613, 619, 626	\$8.00
652F148	F3, T13 for 1-3/4" - 2" door - 606, 612, 613, 619, 626	\$11.00
652F158	F3, T13 for 2-1/4" door - 606, 612, 613, 619, 626	\$11.00
<b>SCREW POST</b> NO FINISH		
783F048	Screw Post	\$6.50
<b>SLIDER, THUMBPIECE</b> NO FINISH		
651F498	Slider, Thumbpiece	\$6.00
<b>SPINDLE BRACKET</b> NO FINISH		
652F048	Spindle Bracket, lever	\$6.50
<b>SPINDLE NUT</b> NO FINISH		
651F738	Spindle Nut, x7 †Order 20-	\$2.00
652F098	Spindle Nut, x7M lever †Order 50-	\$2.00
<b>SPINDLE WASHER</b> NO FINISH		
652F068	Spindle washer, G Knob	\$4.50
652F058	Spindle Washer, Levers	\$4.50
<b>SPRING</b> NO FINISH		
651F948	Spring, Extension	\$2.00
651F758	Spring, Grip Return, knob †Order 10-	\$4.50
651F618	Spring, Grip Return, lever, LHR (red)	\$4.50
651F628	Spring, Grip Return, lever, RHR (blue)	
651F938	Spring, Rack, lever †Order 50-	\$2.00
651F478	Spring, Thumbpiece, T13	\$5.00
678F028	Spring, Thumbpiece T13M	\$7.00
651F408	Spring, various trim †Order 20-	\$2.00
651F868	Spring, various trim †Order 50-	\$2.00
<b>TAILPIECE ASSEMBLY</b> NO FINISH		
677F068	1-3/4" door without shim kit	\$39.00
655F698	2" - 2-1/4" door or 1 3/4" door with shim kit - TH9 series trims	\$39.00
655F708	2" - 2-1/4" door or std. door with shim kit - All trims except TH9 series	\$39.00
<b>THIMBLE INSERT</b>		
651F389	Knob & thumbturn †Order 50-	\$2.00
118F299	Lever †Order 100-	\$2.00
<b>THUMBPIECE BRACKET</b>		
651F578	Thumbpiece Bracket, T13M	\$20.00
<b>THUMBPIECE TAB</b> NO FINISH		
651F568	Thumbpiece Tab, T13M	\$3.00
<b>THUMBPIECE</b> 605, 606, 611, 612, 613, 619, 625, 626, 629, 630		
566F50	Thumbpiece, T13, T14	\$47.00
566F51	Thumbpiece, T13M	\$54.00
<b>WASHER</b> NO FINISH		
651F708	Washer under tailpiece †Order 50-	\$2.00
651F848	Washer, Grip †Order 20-	\$2.50

## ED7000 Series Crossbar Exit Devices

*January 1, 2019*

### ACTIVE & INACTIVE CASES

PART NO.	DESCRIPTION	LIST PRICE
<b>ACTIVE CASE ASSEMBLIES, COMPLETE</b>		
<b>LOCK BODY ASSEMBLY - CROSSBAR</b>		<b>SPECIFY HAND</b>

**No Finish**

424F428	MLE08 (ED 7600)	\$601.00
424F438	MLE09 (ED7600A)	

### STRIKES FOR CROSSBAR EXIT DEVICES

PART NO.	DESCRIPTION	LIST PRICE
269F73	ED7000 LHR with dogging	\$857.00
269F74	ED7000 RHR with dogging	
269F75	ED7000 LHR less dogging	\$809.00
269F76	ED7000 RHR less dogging	

#### VERTICAL ROD STRIKES 605, 606, 612, 613, 622, 626, 629

392F24	Top	\$93.00
392F22	Top	\$74.00
392F28	Bottom flush	\$59.00
392F29	Bottom surface	\$50.00
176F653	Top bracket	\$50.00
304F337	Bottom 630 only	\$33.00
304F347	Bottom 630 only	\$50.00
352F042	Bottom	\$33.00
352F05	Top	\$59.00
361F913	Bottom flush	\$59.00
123F22	Bottom	
183F857	Top 630 only	
502F75	Bottom mortised	\$35.00
502F96	Surface	\$45.00

### STRIKES FOR CROSSBAR EXIT DEVICES (Cont'd)

PART NO.	DESCRIPTION	LIST PRICE
<b>CONCEALED VERTICAL ROD STRIKES 605, 606, 612, 613, 622, 626</b>		

503F52	Bottom Strike	\$60.00
--------	---------------	---------

503F533	Fire Rated Bottom Strike	\$60.00
---------	--------------------------	---------

#### RIM EXIT DEVICE STRIKES 605, 606, 612, 613, 622, 626

142F43	Adj. Packet	\$138.00
--------	-------------	----------

467F733	Pack, rim vert. rod	\$93.00
---------	---------------------	---------

300F71	Packet	\$118.00
--------	--------	----------

499F598	Adj.	\$87.00
---------	------	---------

#### MORTISE STRIKES 605, 606, 612, 613, 619, 622, 625, 626

240L50	Stainless Mortise - LHR 629, 630 only	\$49.00
--------	---------------------------------------	---------

240L51	Stainless Mortise - RHR 629, 630 only
--------	---------------------------------------

411L63	Open Back - RHR	See page 341
--------	-----------------	--------------

411L62	Open Back - LHR	See page 341
--------	-----------------	--------------

#### LOW PROFILE EXIT DEVICE STRIKES

416F355	Strike 622 689, 690, 691	\$45.00
---------	--------------------------	---------

436F038	Strike, bottom	\$18.00
---------	----------------	---------

487M048589	Top Rod (for 10' Doors)	\$130.00
------------	-------------------------	----------

463F918	Flush Bottom Strike	\$21.00
---------	---------------------	---------

DEVICE PARTS					
PART NO.	DESCRIPTION	LIST PRICE	PART NO.	DESCRIPTION	LIST PRICE
122F188	Mounting Bracket	\$30.00	164F329	Nylon Washer †Order 50-	\$2.00
122F248	Washer †Order 100-	\$2.00	173F698	Stud	\$2.00
122F413	Lower Rod Guide	\$12.00	173F728	Nut	\$5.50
122F508	Lower Bolt Tube Sub Assembly	\$84.00	175F518	Rod Insert	\$20.00
122F518	Bottom Guide Sub Assembly	\$80.00	183F74	Top Latch Sub Assembly (with top rod doors 6'4" to 8'6")	\$376.00
122F568	Locking Lever	\$23.00	183F75	Top Latch Sub Assembly (with top rod door 8'6" to 10'8")	\$376.00
122F578	Locking Lever	\$16.00	184F825	Shim	\$20.00
122F593	Locking Lever Spring	\$25.00	184F948	Jam Nut	\$6.50
122F608	Locking Hub	\$13.00			
122F618	Locking Hub	\$6.50			
122F639	Spacer Washer (Nylon)	\$2.00			
122F643*	Handle Lever	\$118.00			
123F538	Dogging Key, 3/16" hex	\$3.50			
129F499	Sound Deadener	\$7.50			
129F848	Cylinder Nut	\$7.50			
134F05	Cylinder Collar	See page 337			
140F528	Stud †Order 20-	\$2.00			
141L548	Reinforcing Tube	\$144.00			
141L59	<b>Crossbar</b>				
	605, 606, 611, 612, 613, 619, 622, 625, 626, 629, 630	\$326.00			
142F44*	Adj. Strike	\$76.00			
143F248	Spring †Order 50-	\$2.00			
145F543*	Strike Plate	\$82.00			
148F367	Release Plunger Sub Assembly	\$24.00			
148F448	Mounting Wrench	\$5.50			

**DEVICE PARTS (Cont'd)**

PART NO.	DESCRIPTION	LIST PRICE	PART NO.	DESCRIPTION	LIST PRICE
213F117	Top Strike S/A (reveal less 5-1/2") <i>Obsolete</i>	\$91.00	264F958	Screw 12-24 x 7/8" RHMS-PH <i>Obsolete</i>	\$2.00
	629, 630			(Metal Doors) †Order 20-	
200F168	Screw 12-24 x 1/2" FHMS <i>Obsolete</i>	\$2.00	268F647	Washer †Order 50-	\$2.00
220F498	Screw 1/4-20 x 2" FHMS <i>Obsolete</i>	\$2.00	268F848	Screw 6-32 x 5/8" RHMS †Order 20- <i>Obsolete</i>	\$2.00
220F722	Screw 12-24 x 1/2" FHMS-PH <i>Obsolete</i>	\$2.00	268F878	Retainer Ring †Order 20-	
	†Order 20-			269F048	Cotter Pin †Order 50-
220F75	<b>Screw 1/4-20 x 5/8" FHMS-PH</b>	\$2.00	269F058	Lockwasher †Order 100-	\$2.00
	606, 619, 622, 625, 626, 630			269F08	<b>Screw 8-32 x 3/8" FHMS-PH</b>
	605, 611, 512, 613, 629	\$3.50		605, 606, 611, 613, 619, 625, 626, 630	
220F778	<b>Screw</b> 622, CDC, MTD, 613	\$2.00		<b>Lever</b>	\$307.00
220F827	Screw 1/4-20 x 1" FHMS-PH	\$3.50	269F31	605, 606, 611, 612, 619, 613, 619, 625, 626	
220F848	Screw 12-24 x 1-1/4" FHMS-PH	\$2.00	269F32	605, 606, 611, 612, 619, 613, 619, 625, 626	
220F85*	Screw 1/4-20 x 1-1/4" FHMS-PH x Anchor <i>Obsolete</i>	\$3.00	<b>COVER</b>		
221F948*	Mounting Screw	\$3.50	269F33	605, 606, 611, 612, 613, 619, 625, 626, 629, 630	\$318.00
222F71*	Throughbolt			269F34	605, 606, 611, 612, 613, 619, 625, 626, 629, 630
224F348	Screw 12 x 1" FHWS †Order 20- <i>Obsolete</i>	\$2.00	269F35	605, 606, 611, 612, 613, 619, 625, 626, 629, 630	\$318.00
224F392	Screw 14 x 1-1/4" FHWS †Order 20- <i>Obsolete</i>			269F36	<b>Active Case Less Cover, ED7200 RHR &amp; LHR</b>
224F448	Screw 14 x 1-1/2" FHWS <i>Obsolete</i>	\$3.00		605, 606, 611, 612, 613, 619, 625, 626, 629, 630	
224F508	Screw 14 x 2" FHWS †Order 20- <i>Obsolete</i>	\$2.00	269F378	Hub	\$41.00
225F998	Screw 12 x 1-1/2" OHWS-PH <i>Obsolete</i>	\$2.50	269F393	Latch Retractor	\$37.00
228F188	Roll Pin †Order 100- <i>Obsolete</i>	\$2.00	269F403	Latch Retractor	\$41.00
228F497	Roll Pin (79028-1250343)	\$2.00	269F413	Slide	\$49.00
228F517	Roll Pin (79028-1250500 St'd) †Order 100-	\$2.00	269F42	<b>Inactive Case S/A, all ED7000</b>	\$341.00
228F528	Roll Pin †Order 100- <i>Obsolete</i>	\$2.00		605, 606, 611, 612, 613, 619, 625, 626, 629, 630	
228F558	Roll Pin 1/8 x 3/4" †Order 100- <i>Obsolete</i>	\$2.00	269F468	Hold Back Sleeve	\$41.00
228F687	Roll Pin 156 x 9/16" †Order 50-	\$2.00	269F479	Nyliner	\$3.50
228F808	Roll Pin 187 x 3/4" †Order 100-	\$2.00	269F488	Lever Pivot	\$3.00
228F817	Roll Pin 187 x 1-15/16" †Order 20-	\$2.00	269F499	Bushing	\$4.00
228F847	Roll Pin 187 x 1-3/8" †Order 20-	\$2.00	269F528	Hub Shank	\$5.50
243F769	Stop Nut †Order 20- <i>Obsolete</i>	\$2.00	269F538	Latch Spring	\$3.50
243F798	Spring Lock Washer †Order 100- <i>Obsolete</i>	\$2.00	269F549	Button	\$2.00
243F808	1/4-20 x 5/8" FRMS-PH <i>Obsolete</i>	\$3.00	269F559	Washer †Order 50-	\$2.00
			269F569	Washer †Order 50-	
243F85	<b>Top Cover Sub Assembly</b>	\$149.00	269F578	Spring Washer	\$6.50
	605, 606, 611, 612, 613, 619, 625, 626, 629, 630 <i>Obsolete</i>			269F587	Latch Pin
249F33*	1/4-20 NC-2A x 1-1/4" Lg. Phillips OHMS	\$4.00	269F608	Inner Spring	\$6.50
253F118	Drive Screw †Order 100-	\$2.00	269F91*	Screw Packet	\$94.00
254F73	<b>Screw 8-32 x 3/8" OHMS-PH <i>Obsolete</i></b>	\$2.50	269F92*	Screw Packet	\$69.00
	605, 606, 611, 612, 613, 619, 625, 626, 630			270F01*	Screw Packet
255F41*	Screw 12-24 x 2" FHMS-PH	\$5.00	270F02*	Screw Packet	\$72.00
261F288	Screw 8-32 x 3/8" HSS Cone-SOC <i>Obsolete</i>	\$3.00	270F11*	Through Bolt	\$4.00
261F318	<b>Screw 5/16-24 x 1-1/2" FHMS-SOC</b>	\$3.50	282F325	Caulking Anchor <i>Obsolete</i>	\$4.50
	605, 611, 612, 613, 619, 625, 626, 630			282F357	Caulking Anchor
261F54	Cylinder Collar	\$29.00	284F67*	Lever RH <i>Obsolete</i>	\$121.00
261F658	Screw 1/4-20 x 1/2" PHMS	\$3.00			
262F901	River 3/32" x 5/32" †Order 100- <i>Obsolete</i>	\$2.00			

\*Specify Finish. Ø Subject to availability.

† Sold only in multiples of the number indicated. Price is each.

**DEVICE PARTS (Cont'd)**

PART NO.	DESCRIPTION	LIST PRICE	PART NO.	DESCRIPTION	LIST PRICE
284F977	Roll Pin †Order 50-	\$2.00	351F72	<b>Bottom Latch Cover</b>	
291F498	Stop Plate	\$25.00		605, 606, 611, 612, 613, 619, 625, 626, 629, 630	\$231.00
291F578	Screw 10-31 x 1" FHM-PH †Order 50-	\$2.00	351F73	<b>Top Latch Cover</b>	
293F183	Slide Assembly	\$111.00		605, 606, 611, 612, 613, 619, 625, 626, 629, 630	\$244.00
306F068	Screw 10-24 x 5/16" RHMS-PH †Order 20-	\$2.00	351F797	Top Latch Sub Assembly	\$55.00
306F078	Spring Lockwasher †Order 100-	\$2.00	351F807	Roll Pin †Order 50-	\$2.00
321F907	Dogging Device Sub Assembly	\$45.00	351F823	Top Latch Backplate	\$101.00
333F519	Screw	\$2.00	351F833	Top Latch Slide	
341F318	Shim	\$21.00	351F849	Spacer	\$9.50
351F50*	<b>Active Case - less cover, ED7400 standard</b>		351F85*	Top Latch Sub Assembly No Cover	\$387.00
	606, 612, 619, 622, 626	\$213.00	351F867	Bottom Latch	\$101.00
605, 611, 613, 625, 629, 630			351F873	Latch Link	\$99.00
351F51*	<b>Active Case - less cover, ED74000, ED7401, no bottom rod</b>		351F883	Bottom Latch Backplate	\$101.00
	606, 612, 619, 622, 626	\$213.00	351F897	Spring †Order 20-	\$2.00
605, 611, 613, 625, 629, 630			351F907*	Bottom Latch Sub Assembly	\$349.00
351F528	10-32 x 7/16" FHUMS-PH Screw †Order 100-	\$2.00	351F988	Rod Connector Sub Assembly	\$5.50
351F553	Slide Sub Assembly	\$159.00	352F021	Drive Rivet †Order 20-	\$2.00
351F56*	Active Case Sub Ass'y, ED7400 with dogging -RHR	\$878.00	352F068	1/4-20 x 3/4" BHUMS-PH Screw †Order 20-	\$2.00
351F57*	Active Case Sub Ass'y, ED7400 with dogging -LHR			361F308	Anchor
			362F498	Nut	\$24.00
			362F918	Plate	\$7.50
			364F228	Washer	\$6.50
			364F272	Locking Slide	\$27.00
			364F288	Locking Lever Sub Assembly	\$36.00
			364F308	Lifting Lever	\$29.00
			364F36*	Escutcheon Assembly RHR, C4, D4, E4 - MR	\$295.00
			364F37*	Escutcheon Assembly LHR, C4, D4, E4 - MR	
			364F38*	Escutcheon Assembly RHR, C4, D4, E4 - Std	\$308.00
			364F39*	Escutcheon Assembly LHR, C4, D4, E4 - Std	
			365F003	Slide Extension S/A Door 1-3/4"	\$45.00
			365F013	Slide Extension S/A Door 2-1/4"	
			365F033	Slide Extension S/A Door 1-3/4" or Lever Trim	
			365F98*	1/4-20 x 2" OHTS-F-PH Metal Door	\$6.50
			376F42	<b>Latch Sub Assembly</b>	
				611, 612, 613, 619, 625, 626	\$53.00
				605, 606, 629, 630	\$63.00
			378F745	Tenon Sub Assembly	\$43.00

\*Specify Finish. Subject to availability.

† Sold only in multiples of the number indicated. Price is each.

**DEVICE PARTS (Cont'd)**

PART NO.	DESCRIPTION	LIST PRICE	PART NO.	DESCRIPTION	LIST PRICE
392L19*	Adj. Bottom Rod Assembly	\$227.00	468F246	Active Backplate Assembly, RH	\$809.00
393L13-M672*	Top Rod	\$176.00	468F256	Active Backplate Assembly, LH	
399F188	Lower Bolt Assembly	\$352.00	468F266	Active Backplate Assembly, RH	
402F99*	Thumbpiece	\$46.00	468F276	Active Backplate Assembly, LH	
403F035	Slide x4M Trim	\$91.00	468F355	Cylinder housing	\$9.50
403F30*	Washer	\$3.50	480F128	Inactive Backplate Assembly	\$108.00
405F428	Anchor	\$6.50	480F13*	Lever	\$273.00
405F458	Mullion (507) 7'2" door	\$239.00	480F188	Spindle	\$44.00
Ø 405F466	Bottom Plate	\$108.00	480F198	Nut	\$9.50
405F476	Top Plate	\$96.00	480F208	Rollback	\$10.00
405F496	Bottom Plate Assembly				
Ø 409F836	Top Plate Assembly				
412F133*	Screw, 8-32 x 5/16"	\$3.50	480F28*	Lever & Spindle Assembly	\$253.00
412F157	Lever Pivot	\$12.00	480F30*	Lever & Spindle Assembly	\$253.00
412F167	Deadlocking Plunger	\$21.00	480F33*	Lever & Spindle Assembly	\$257.00
412F451	Inactive Backplate Assembly	\$105.00	480F375	Slide	\$50.00
416F818	Stud	\$8.50	482F442	*Bushing	\$55.00
418F288	Dogging Screw	\$6.50	482F49*	Escutcheon	
418F308	Rivet	\$3.50	482F73*	Escutcheon & Bushing	\$257.00
418F352	Hub	\$49.00	484F418	Rollback	\$16.50
418F368	Lever, RH	\$5.50	484F898	Knob Shank Sub Assembly	\$33.00
418F378	Lever, LH				
420F128*	Screw Packet	\$45.00	492F195	Slide	\$89.00
433F978	Lever Pivot	\$43.00	<b>BLANK PLATE FOR STOCK HOLLOW METAL DOORS</b>		
433F988	Lever Pivot				
434F008	Lever Pivot	\$25.00	561F29	<b>Blank Plate 14" x 3-1/2"</b> Used on the outside of stock cut-out hollow metal doors where no trim is desired 605, 606, 612, 613, 619, 625, 626, 630	\$133.00
434F028	Screw 1/4-20 x 3/4" BUHC-SK	\$2.00	<b>BLANK FRONTS AND STRIKES FOR STOCK HOLLOW METAL DOORS AND FRAMES</b>		
464F028	Mullion (508) 8' door	\$233.00	<b>Steel, USP</b>		
464F915	Active Case Casting only	\$45.00	077F198	Front, 2-1/4" x 1-1/8"	\$8.50
467F942	Thumbpiece Lever RH	\$82.00	334F99	Front, 8" x 1-1/4"	\$21.00
467F952*	Thumbpiece Lever LH				
468F022*	Lever, inactive RH	\$124.00	Ø 236L718018	Strike, 4-7/8" x 1-1/4"	\$8.50
468F032*	Lever, inactive LH				
468F122	Thumbpiece Lever Assembly RH	\$213.00	321F24*	RHR Bracket for P3 trim	\$108.00
468F132	Thumbpiece Lever Assembly LH				
468F147	Latch Pin Assembly RH	\$82.00	393L13-M672*	Top Rod	\$176.00
468F157	Latch Pin Assembly LH				
468F162	Lever Assembly RH	\$78.00	Ø 399F168	Spindle Adapter	\$50.00
468F172	Lever Assembly LH				
468F202*	Lever Assembly RH	\$196.00	399F178	Lower Rod Assembly	\$176.00
468F212*	Lever Assembly LH				
			402F983	Extension Slide	\$35.00
			402F99*	Thumbpiece	\$46.00
			408F258	Guide Spring	\$2.00
			503F533	Bottom Strike	\$60.00
			503F557	Top Strike	\$56.00
			503F567	Top Strike - Fire Rated	
			376F37*	Sex Nut (For 1-3/4 & 2" doors)	\$6.50
			<b>MISCELLANEOUS</b>		
			148F228	Pin	\$2.00

\*Specify Finish. Ø Subject to availability.

† Sold only in multiples of the number indicated. Price is each.



PART NO.	DESCRIPTION	LIST PRICE	PART NO.	DESCRIPTION	LIST PRICE
<b>ALARM DELAY SWITCH</b>			<b>MISCELLANEOUS</b>		
696F318	for M62 option	\$54.00	650F279	Dogging Hole Plug	\$2.00
<b>BAR 689, 690, 691</b>			697F988	Sex Nut Pack (M54)	\$16.50
436F418	for ED8400, 30" door width, with dogging	\$342.00	436F858	Latch Assembly Screw	\$2.00
436F428	for ED8400, 36" door width, with dogging		558F528	Mounting packet for F1 and P8 Trim 689, 690, 691	\$23.00
436F438	for ED8400, 42" door width, with dogging		482F798	ANSI fastening plate packet for G3 Trim No Finish	\$9.00
436F448	for ED8400, 48" door width, with dogging	\$367.00	123F538	Dogging Key, 3/16" hex No Finish	\$3.50
387F218	for ED8200, 30" door width, with dogging	\$321.00	267F348*	Mounting Screw †Order 20-	\$2.00
387F248	for ED8200, 36" door width, with dogging		<b>MOUNTING PACKET 605, 606, 611, 612, 613, 619, 622, 625, 626</b>		
387F278	for ED8200, 42" door width, with dogging		469F67	for F157, P857 trim	\$26.00
387F308	for ED8200, 48" door width, with dogging	\$344.00	469F68	for F150, P150, P850 trim (dummy)	\$15.00
387F638	for ED8200, 30" door width, less dogging	\$315.00	496F68	for P257 trim	\$28.00
387F668	for ED8200, 36" door width, less dogging		496F69	for P250 trim (dummy)	\$26.00
387F698	for ED8200, 42" door width, less dogging		<b>PLATES AND PULLS 689, 690, 691</b>		
387F728	for ED8200, 48" door width, less dogging	\$338.00	436F828	for F1 Trim, plate - no cylinder hole	\$40.00
564F888	for ED8400, 30" door width, less dogging	\$336.00	436F838	for F1 Trim, plate - with cylinder hole	
564F898	for ED8400, 36" door width, less dogging		436F801	for P8 Trim, pull - no cylinder hole	\$46.00
564F908	for ED8400, 42" door width, less dogging		436F811	for P8 Trim, pull - with cylinder hole	
564F918	for ED8400, 48" door width, less dogging	\$361.00	602F151	Pull Grip (Black) for P2 622 Only	\$54.00
564F378	for ED8400A, 30" door width, less dogging	\$336.00	<b>605, 606, 611, 612, 613, 619, 622, 625, 626</b>		
564F408	for ED8400A, 36" door width, less dogging		270F13	Escutcheon for P3 trim without cylinder hole	\$106.00
564F438	for ED8400A, 42" door width, less dogging		492F20	Offset Pull for P1 trim without cylinder hole	\$131.00
564F688	for ED8400A, 48" door width, less dogging	\$361.00	492F21	Offset Pull for P1 trim with cylinder hole	\$151.00
<b>BOTTOM ROD</b>			602F181	Pull Base for P2 trim plate without cylinder hole	\$194.00
436L328557	for ED8400, 40-5/16" Pushbar Height, for Door 7"6" high	\$180.00	602F171	Pull Base for P2 trim plate with cylinder hole	\$213.00
526L518540	for ED8400A		328F80	Pull Tube for P3 trim	\$108.00
<b>BRACKET 605, 606, 611, 612, 613, 619, 622, 625, 626</b>			<b>REAR COVER 689, 690, 691</b>		
321F23	LHR Bracket for P3 trim	\$125.00	603F64	for ED8000 devices purchased AFTER Nov. 1, 1993	\$27.00
321F24	RHR Bracket for P3 trim		<b>ROD GUIDE PACKET SCREW PACKET</b>		
<b>FRAME PLATES</b>			446F208	Rod guide packet	\$35.00
552F598	for ED8400 - RHR	\$163.00	523F038	for ED8200(B) and ED8400(A), Packet for mounting bar & active case with SNB	\$35.00
552F608	for ED8400 - LHR		484F208	for ED8400, Packet for mounting top latch	\$57.00
552F468	for ED8400A - RHR		484F218	for ED8400, Packet for mounting bottom latch	\$24.00
552F478	for ED8400A - LHR	\$236.00	261F308	for ED8200, Latch & Frame Plate Attachment Screw †Order 20-	\$3.00
<b>FRONT COVER</b>			<b>ROD GUIDE PACKET SCREW PACKET (Cont'd)</b>		
564F345	for ED8400 (A) (not handed)	\$47.00	449F828	for ED8200(B) and ED8400 for bar & active case	\$24.00
385F545	for ED8200(B) (not handed)	\$56.00	492F59	Rear Side Screw Packet for P1 trim	\$5.00
564F115	for ED8200A (not handed)	\$68.00	564F128	for ED8200A, Packet for mtg. bar & active case with SNB	\$42.00
<b>KNOB 605, 606, 611, 612, 613, 619, 625, 626</b>			534F008	for ED8400A, Packet for mtg. Top & bottom latch	\$51.00
695F22	for G10 Trim, plain	\$115.00	<b>SHIM KITS</b>		
695F23	for G10 Trim, with cylinder hole	\$113.00	557F928	for ED8200 (B)	\$84.00
<b>LATCH</b>			557F938	for ED8200A	\$84.00
436F258	for ED8400, Top No Finish	\$188.00	557F948	for ED8400	\$140.00
436F298	for ED8400, Bottom No Finish	\$100.00	557F958	for ED8400A	\$140.00
552F368	for ED8200(B) 626	\$117.00	<b>*Specify Finish.</b>		
552F416	for ED8200A	\$276.00	<b>†Sold only in multiples of the number indicated. Price is each.</b>		
525F998	for ED8400A, top	\$201.00			
526F168	for ED8400A, bottom	\$231.00			
<b>LATCH COVER 689, 690, 691</b>					
526F321	for ED8400A, Top or Bottom Latches	\$90.00			
446F231	for ED8400, Top or Bottom Latches	\$77.00			

**DEVICE PARTS (Cont'd)**

PART NO.	DESCRIPTION	LIST PRICE
<b>STRIKE PACKET</b>		
391F575	for ED8200, Shim used with 1/2" Stop	\$29.00
446F21M	for ED8400, Packet for Top Latch.Strike 605, 606, 611, 612, 613, 622, 625, 626	\$45.00
446F228	for ED8400, Packet for Bottom Latch (Surface Mounting) 625 only	\$35.00
463F928	for ED8400, Packet for Bottom Latch (Flush Mounting) 625 only	\$31.00
386F453	for ED8200(B) Strike Packet 612, 613, 626	\$41.00
468F305	Packet for Rim by Vertical Rod 605, 606, 612, 613, 622, 625, 626, 689, 690, 691	\$35.00
518F067	for ED8200A	\$70.00
526F527	for ED8400A, Packet for Top Strike	\$46.00
526F533	for ED8400A, Packet for Bottom Strike	\$42.00
<b>TOP ROD</b>		
487L048697	for ED8400, 40-5/16" Pushbar Height, for Door 7'6" high	\$100.00
487M048589	for ED8400, 40-5/16" Pushbar Height, for Door 7'6" high to 10' high	\$130.00
526L928759	for ED8400A	\$86.00
<b>CHASSIS, 1-3/4" TO 2-1/4" DOORS NO FINISH</b>		
690F44	Dummy (50)	\$96.00
698F43	Passage (10)	
698F44	Classroom (55)	\$104.00
698F45	Nightlatch (57)	
698F46	Storeroom (59)	
698F51	Classroom - LFIC	\$110.00
698F52	Nightlatch - LFIC	
698F53	Storeroom - LFIC	
<b>MISCELLANEOUS 605, 606, 611, 612, 613, 619, 625, 626</b>		
678F25	Rose for X6 trim	\$27.00
585F72	Lever Insert for X6 trim	\$2.00
682F91	Recore Driver Packet	\$6.00
696F05	Mounting Packet	\$4.50
<b>LEVERS ALL FINISHES STANDARD 1-3/8" TO 2-1/4" DOORS</b>		
563F955	N6 design x cylinder or button	\$108.00
563F965	N6 design x emergency key hole	
563F945	N6 design x plain	
578F435	N6 x Sargent® cylinder cutout	\$108.00
563F895	A6 design x cylinder or button	\$108.00
563F905	A6 design x emergency key hole	
563F885	A6 design x plain	
685F515	P6 design x cylinder or button	
685F525	P6 design x emergency key hole	
685F505	P6 design x plain	

PART NO.	DESCRIPTION	LIST PRICE
<b>LEVERS ALL FINISHES LFIC, 1-3/8" TO 2-1/4" DOORS</b>		
585F715	N6 x cylinder (LFIC core 6-pin)	\$108.00
600F415	N6 x cylinder (LFIC core 7-pin)	
596F825	N6 x Best® cylinder cutout	\$108.00
585F705	A6 x cylinder (LFIC core 6-pin)	\$108.00
600F425	A6 x cylinder (LFIC core 7-pin)	
685F535	P6 x cylinder (LFIC core 6-pin)	
685F545	P6 x cylinder (LFIC core 7-pin)	
685F555	P6 x Best cylinder cutout	\$108.00

†Sold only in multiples of the number indicated. Price is each.

DC3000 CLOSER PARTS		
PART NO.	DESCRIPTION	LIST PRICE
<b>TOOLS</b>		
330F10	Hex wrench for closer valve, 3/32"	\$4.00
597F24	Torx tool kit	\$195.00
<b>CLOSER BODIES 600, 689, 690, 691, 693, 696</b>		
540F27	Closer body for DC3200	\$354.00
597F35	Closer body for DC3200 x M71	\$398.00
M71 = Delayed action		
<b>ARMS 600, 689, 690, 691, 693, 696</b>		
688F95	Regular arm	\$124.00
688F77	Regular arm with hold-open	\$183.00
688F95	Top jamb	\$124.00
688F77	Top jamb with hold-open	\$183.00
689F02	Heavy-duty parallel arm	\$185.00
689F01	Heavy-duty parallel arm with hold-open	\$208.00
597F52	Heavy-duty regular arm	\$185.00
689F03	Heavy-duty parallel arm with backstop	\$194.00
689F04	Heavy-duty parallel arm with backstop & hold-open	\$179.00
691F98	Reg. secondary arm assy.	\$43.00
691F99	Deep reveal secondary arm assembly	\$44.00
692F02	Reg. H.D. secondary arm assembly	\$164.00
692F03	Deep reveal H.D. secondary arm assembly	\$283.00
<b>BRACKETS 600, 689, 690, 691, 693, 696</b>		
188F03	Quik-Install™	\$18.00
188F41	Parallel arm	\$6.00
509F49	Parallel arm with hold-open	\$42.00
188F62	Parallel arm offset	\$28.00
188F63	Parallel arm for flush transom	\$42.00
244F17	Regular arm mortise	\$51.00
447F14	Angle Support Bracket and Spacer	\$42.00
<b>DROP PLATES 600, 689, 690, 691, 693, 696</b>		
188F65	For DC3220 x full cover	\$56.00
597F58	For DC3210 x full cover	\$63.00
<b>COVERS 600, 689, 690, 691, 693, 696</b>		
597F78	Full cover and insert packet (standard)	\$41.00
<b>PAINT (PER CAN)</b>		
597F94	Silver Aluminum - 689	\$53.00
597F95	Dark Bronze - 690	
597F96	Light Bronze - 691	
597F97	Satin Brass - 696	

DC5000 CLOSER PARTS		
PART NO.	DESCRIPTION	LIST PRICE
<b>CLOSER BODY 600, 689, 690, 691, 693, 696</b>		
754F68	Closer Body Only	\$452.00
<b>ARMS 600, 689, 690, 691, 693, 696</b>		
754F95	Pull Side Slide Track & Arm Assy., Non-Hold Open	\$186.00
754F96	Pull Side Slide Track & Arm Assy., Hold Open	\$281.00
795F97	Push Side Slide Track & Arm Assy., Non-Hold Open	\$186.00
754F98	Push Side Slide Track & Arm Assy., Hold Open	\$281.00
754F92	Hold Open Assembly	\$38.00
<b>COVER</b>		
754F79	Plastic Cover	\$42.00
<b>DROP PLATE</b>		
754F80	Push side, drop plate	\$44.00
<b>ANGLE BRACKET</b>		
754F93	Stop Mount Track Angle Bracket	\$79.00
<b>SCREW PACKETS</b>		
754F69	Closer Screw Pack	\$10.00
754F70	Spline Screw Pack	\$28.00
754F94	Track Screw Pack	\$14.00
261F298	Hex Key 5/64" †Order 10-	\$3.00

† Sold only in multiples of the number indicated. Price is each.

**CLOSER PARTS**

PART NO.	DESCRIPTION	LIST PRICE
<b>CLOSER BODIES 600, 689, 690, 691, 693, 696</b>		
689F12	Closer body for DC6200	\$418.00
689F13	Closer body for DC6200 x M71	\$461.00
689F14	Closer body for DC6401	\$418.00
689F15	Closer body for DC6402	
689F16	Closer body for DC6403	
689F17	Closer body for DC6404	
689F18	Closer body for DC6405	
689F19	Closer body for DC6406	
691F52	Closer body for DC6401 x M71	\$461.00
691F53	Closer body for DC6402 x M71	
691F54	Closer body for DC6403 x M71	
691F55	Closer body for DC6404 x M71	
691F56	Closer body for DC6405 x M71	
691F57	Closer body for DC6406 x M71	
M71 = Delayed action		
<b>ARMS 600, 689, 690, 691, 693, 696</b>		
688F95	Regular arm, consists of:	\$124.00
	688F99 main arm & tube assembly	\$78.00
	688F98 rod & shoe assembly	\$33.00
	688F92 hex screw pkg.	\$13.00
688F77	Regular arm with hold-open (A1), consists of:	\$183.00
	691F92 main arm & rod assy	\$73.00
	540F40 hold-open bracket assembly	\$110.00
689F02	Heavy duty parallel arm (A3)	\$185.00
689F01	Heavy duty parallel arm with hold-open (A2)	\$208.00
597F52	Heavy duty regular arm (A10)	\$185.00
689F03	Heavy duty parallel arm with backstop (A4)	\$194.00
689F04	Heavy duty parallel arm with backstop & hold-open (A5)	\$179.00
615F52	HD Spring stop for Dr. width. 28"-32" (A11)	\$185.00
615F54	Unitrol® for Dr. width. 33"-41	
615F56	Unitrol® for Dr. width. 42"-48"	
615F51	Unitrol®/HO for Dr. width. 28"-32" (A12)	
615F53	Unitrol®/HO for Dr. width. 33"-41"	
615F55	Unitrol®/HO for Dr. width. 42"-48"	
691F96	Heavy-duty offset arm (A13)	\$123.00
754F16	DC6230, DC6430 pull side - arm only	\$95.00
754F10	DC6230, DC6430 - track only (hold-open)	\$281.00
754F09	DC6230, DC6430 - track only (non hold-open)	\$186.00
754F44	DC6230, DC6430 pull side track assembly, non-hold open	\$398.00
754F45	DC6230, DC6430 pull side track assembly, hold open	\$498.00
754F12	DC6240, DC6440 push side track & arm (non hold open)	\$277.00
754F14	DC6240, DC6440 - track only (non hold-open)	\$186.00
754F13	DC6240, DC6440 track & arm (hold-open)	\$376.00
754F15	DC6240, DC6440 - track only (hold-open)	\$281.00
754F16	DC6240, DC6440 - arm only (hold-open)	\$95.00
691F72	Deep reveal arm (7-1/4" max), consists of:	\$112.00
	688F99 main arm and arm tube assy	\$78.00
	691F75 rod & shoe assembly	\$14.00

PART NO.	DESCRIPTION	LIST PRICE
<b>ARMS 600, 689, 690, 691, 693, 696</b>		
691F74	Deep reveal arm w/hold-open (7-1/4" max), consists of:	\$150.00
	691F95 main arm & rod assy- deep reveal	\$150.00
	540F40 hold-open bracket assy.	\$33.00
		\$110.00
615F58	Reinforcing bracket	\$35.00
615F59	Deep reveal reinforcing kit	\$47.00
615F60	Flush partition bracket	\$34.00
692F04	Friction, Hold Open Arm RH	\$113.00
692F05	Friction, Hold Open Arm LH	\$113.00
692F00	Reg. Secondary Arm Assy.	\$43.00
692F01	Top Jamb Secondary Arm Assy.	\$44.00
692F02	Reg. H.D. Secondary Arm Assy.	\$164.00
692F03	Deep Reveal HD. Secondary Arm Assy.	\$283.00
<b>BRACKETS 600, 689, 690, 691, 693, 696</b>		
188F03	Quik-Install™	\$18.00
188F41	Parallel arm	\$6.00
509F49	Parallel arm with hold-open	\$42.00
188F63	Parallel arm for flush transom	\$42.00
188F62	Parallel arm offset	\$28.00
244F17	Regular arm mortise	\$51.00
447F14	Angle support	\$42.00
499F30	Flush transom	\$26.00
691F78	Spacer	\$5.00
<b>COVERS 600, 689, 690, 691, 693, 696</b>		
597F78	Full cover and insert pkt. (standard)	\$41.00
603F55	Full metal cover RH/LHR	\$46.00
603F57	Full metal cover LH/RHR	
261F95	Cover screw pack	\$5.00
<b>DROP PLATES 600, 689, 690, 691, 693, 696</b>		
188F65	For DC6220 x full cover	\$56.00
	For DC6420 x full cover	
597F58	For DC6210, DC6410, DC6240, DC6440 x full cover	\$63.00
597F59	For DC6230, DC6240, x full cover	\$54.00
	For DC6430, DC6440 x full cover	
<b>BLADE STOP SPACER</b>		
597F92	1/2" Spacer block	\$21.00
597F93	5/8" Spacer block	\$33.00
<b>SCREW PACKETS 600, 689, 690, 691, 693, 696</b>		
691F93	Standard Screw Pack	\$12.00
691F94	Standard Screw Pack w/ Sex Nuts	\$20.00
468F34	SNB for 1-3/4" door	\$11.00
691F89	Torx® Screw Pack	\$28.00
691F90	Torx Screw Pack with Sex Nuts	\$32.00
597F24	Torx® tool kit	\$195.00
754F43	Screw pack (push or pull track)	\$18.00
<b>PAINT (PER CAN)</b>		
597F94	Silver Aluminum - 689	\$53.00
597F95	Dark Bronze - 690	
597F96	Light Bronze - 691	
597F97	Satin Brass - 696	

**CLOSER PARTS**

PART NO.	DESCRIPTION	LIST PRICE
<b>CLOSER BODIES</b>		
754F21	Closer body for DC8200	\$463.00
754F26	Closer body for DC8200 x M71	\$507.00
<b>ARMS</b>		
688F95	Regular arm, consists of:	\$124.00
	688F99 main arm & tube assembly	\$78.00
	688F98 rod & shoe assembly	\$33.00
	688F92 hex screw pkg.	\$13.00
688F77	Regular arm with hold-open (A1), consists of:	\$183.00
	691F92 main arm & rod assy	\$73.00
	540F40 hold open bracket assembly	\$110.00
689F02	Heavy-duty parallel arm (A3)	\$185.00
689F01	Heavy-duty parallel arm with hold-open (A2)	\$208.00
597F52	Heavy-duty regular arm (A10)	\$185.00
689F03	Heavy-duty parallel arm with backstop (A4)	\$194.00
689F04	Heavy-duty parallel arm with backstop & hold-open (A5)	\$179.00
615F52	Unitrol® - Dr. width 28"-32" (A11)	\$185.00
615F54	Unitrol® - Dr. width 33"-41" (A11)	
615F56	Unitrol® - Dr. width 42"-48" (A11)	
615F51	Unitrol® w/ Hold Open - Dr. width 28"-32" (A12)	\$208.00
615F53	Unitrol® w/ Hold Open - Dr. width 33"-41" (A12)	
615F55	Unitrol® w/ Hold Open - Dr. width 42"-48" (A12)	
691F96	Heavy-duty offset arm (A13)	\$123.00
692F04	Heavy duty friction hold open, RH (A14)	\$113.00
692F05	Heavy duty friction hold open, LH (A14)	\$113.00
754F09	Pull side track only, non-hold open	\$186.00
754F10	Pull side track only, hold open	\$281.00
754F12	Push side track & arm, non-hold open	\$277.00
754F13	Push side track & arm, hold open	\$376.00
754F14	Push side track only, non-hold open	\$186.00
754F15	Push side track only, hold open	\$281.00
754F16	Slide track assembly (non-hold open or hold open)	\$95.00
691F72	Deep reveal arm (7 1/4" max) consists of:	\$112.00
	688F99 main arm and arm tube assy	\$78.00
	691F75 rod & shoe assembly	\$14.00
691F74	Deep reveal arm with hold-open (7 1/4" max), consists of:	\$150.00
	691F95 main arm & rod assy- deep reveal	\$33.00
	540F40 hold open bracket assy.	\$110.00
615F58	Reinforcing bracket	\$35.00
615F59	Deep reveal reinforcing kit	\$47.00
615F60	Flush partition bracket	\$34.00

PART NO.	DESCRIPTION	LIST PRICE
<b>BRACKET</b>		
754F18	Quik-Install™	\$20.00
188F41	Parallel arm	\$6.00
509F49	Parallel arm with hold-open	\$42.00
188F63	Parallel arm for flush transom	\$42.00
188F62	Parallel arm offset	\$28.00
244F17	Regular arm mortise	\$51.00
447F14	Angle support	\$42.00
499F30	Heavy duty parallel arm flush transom bracket	\$26.00
<b>COVERS</b>		
754F84	Full ABS cover	\$30.00
754F22	Full metal cover RH/LHR	\$63.00
754F23	Full metal cover LH/RHR	
754F17	Cover screw pack	\$5.00
<b>DROP PLATES</b>		
754F20	For DC8200 (regular)	\$79.00
754F24	For DC8200 (with concealed holder)	\$79.00
	For DC8220 (top jamb)	
754F25	For DC8210 (parallel)	\$79.00
	For DC8230 (pull side track)	
	For DC8240 (push side track)	
<b>BLADE STOP SPACER</b>		
597F92	1/2" Spacer block	\$21.00
597F93	5/8" Spacer block	\$33.00
<b>SCREW PACKETS</b>		
754F37	Standard screw pack	\$13.00
754F29	Standard screw pack (includes sex nuts)	
754F30	SNB for 1-3/4" door	\$17.00
754F38	Torx® screw pack	\$41.00
754F34	Torx screw pack (includes sex nuts)	
597F24	Torx® tool kit	\$6.00
754F35	Main arm screw & washer	
<b>RETROFIT PLATES</b>		
754F36	To Replace DC6000 (Reg. Arm)	\$92.00
754F46	To Replace DC6000 (Par. Arm or Top Jamb)	\$92.00

PART NO.	DESCRIPTION	LIST PRICE
<b>DC62900 SERIES ELECTROMECHANICAL CLOSERS</b>		
689F12	DC6000 Closer Body	\$418.00
188F03	Quik-Install Bracket	\$18.00
597F78	Full Cover	\$41.00
603F55	Full Metal Cover RH	\$46.00
603F57	Full Metal Cover LH	\$46.00
692F24	Standard Arm Assembly	\$91.00
692F25	Adjusting Head and Tube Assembly	\$114.00
692F14	Slide Assembly	\$98.00
692F15	Arm Stud Clip	\$9.00
692F16	Track Assembly End Cap	\$7.00
692F17	Solenoid Block Assembly, 24V	\$293.00
692F19	Adjusting Rod Assembly	\$47.00
692F20	Arm Stud	\$6.00
692F21	Retaining Ring	\$3.00
692F23	Arm Length Adjusting Screw	\$2.00
754F02	Double Egress Arm, RH	\$167.00
754F03	Double Egress Arm, LH	\$167.00
754F04	Adjusting Head and Tube Assembly, RH	\$112.00
754F05	Adjusting Head and Tube Assembly, LH	\$112.00
754F52	Track Assy. (Hinge Side) Master or support units	\$364.00
754F53	Track Assy. (Stop Side) Master or support units	
754F54	Hook-Up Board, Master or Support, 24V	\$119.00
754F55	Hook-Up Board, Master or Support, 120V	\$178.00
754F56	Hook-Up Box, Master unit, 24V, push side	\$316.00
754F57	Hook-Up Box, Master unit, 120V, push side	
754F58	Hook-Up Box, Support unit, 24V, push side	\$304.00
754F59	Hook-Up Box, Support unit, 120V, push side	
754F61	Hook-Up Box, Master unit, 24V, pull side	\$316.00
754F62	Hook-Up Box, Master unit, 120V, pull side	
754F63	Hook-Up Box, Support unit, 24V, pull side	\$316.00
754F64	Hook-Up Box, Support unit, 120V, pull side	
754F66	Fuse	\$18.00
754F71	Hook-Up Box Cover Kit (included cover & screws), Master	\$316.00
754F72	Hook-Up Box Cover Kit (included cover & screws), Support	\$54.00
754F73	Smoke Detector Board	\$471.00

PART NO.	DESCRIPTION	LIST PRICE
<b>DC46920 SERIES ELECTROMECHANICAL DOOR HOLDER AND CLOSER</b>		
494F77	Arm Assembly "Pull side"	\$191.00
494F76	Arm Assembly "Push side"	
494F74	Holder - 120VAC	\$408.00
494F75	Holder - 24VAC/DC	\$408.00
494F72	Holder cover - Non Detector	\$155.00
494F92	System plug - 24VDC	\$95.00
494F94	Wire harness - 24VDC	\$77.00

PART NO.	DESCRIPTION	LIST PRICE
<b>Access 800® AC2 Series</b>		
794F509	Gaskets Exit device - Reader	\$10.00
794F519	Gaskets Exit device trim	\$10.00
794F529	Gaskets Cylindrical lock	\$14.00
794F539	Gaskets Mortise lock	\$14.00

PART NO.	DESCRIPTION	LIST PRICE
<b>Motorized</b>		
789F929	ECOFLEX, Motor SUB Assembly	\$126.00
728F709	Harness Fail Safe / Fail Secure	\$16.00
789F859	Motor Mortise ECOFLEX	\$102.00
728F759	ECOFLEX ET Harness A800 AC2	\$16.00
789F869	ECOFLEX ET Link Harness IN100	\$16.00
728F799	ECOFLEX ET Link Harness A800 WI1 & IP1	\$16.00
789F879	ECOFLEX ET Link Harness A700 PIP1, PWI1, IN120, IN220	\$16.00
728F809	ECOFLEX ET Link Harness A700 PAC1	\$16.00
728F939	ECOFLEX ET Link Harness A600 & SE LP10	\$16.00
728F799	ECOFLEX ET Ground Wire A800 WI1, IP1	\$12.00

Part Number	Page	Part Number	Page	Part Number	Page	Part Number	Page	Part Number	Page
019F137	363	122F593	371	173F728	371	217F442	335	220F722	372
021F688	336	122F608	371	173F798	336	217L13M016	356	220F75	372
021F718	336	122F618	371	175F518	371	217L13M016	358	220F778	372
022F723	364	122F639	371	176F653	370	217L13M016	361	220F827	372
022F80	363	122F643*	371	183F74	371	217L13M016	362	220F848	372
025F722	336	123F22	370	183F75	371	217L13M018	356	220F85*	372
025F858	358	123F538	371	183F857	370	217L13M018	358	221F948*	372
025F858	360	123F538	375	184F825	371	217L13M018	361	222F71*	372
026F757	335	129F499	371	184F948	371	217L13M018	362	222F85	364
041F478	336	129F848	336	186F748	336	217L13M020	356	223F29	364
060F053	364	129F848	371	186K75	334	217L13M020	358	224F008*	361
060F338	363	131F278	363	188F03	377	217L13M020	361	224F348	372
060F428	363	134F05	337	188F03	377	217L13M020	362	224F392	372
067F428	363	134F05	371	188F03	378	217L13M022	356	224F448	372
070F428	363	135F108	336	188F03	380	217L13M022	358	224F508	372
070F438	363	135F192	336	188F41	379	217L13M022	361	225F998	372
071F628	363	138F888	363	188F41	377	217L13M022	362	228F188	372
071F638	363	140F528	371	188F41	377	217L13M024	356	228F348	364
071F673	364	140F978	363	188F41	378	217L13M024	358	228F497	372
077F198	374	141L548	371	188F62	379	217L13M024	361	228F517	372
078F078	363	141L59	371	188F62	377	217L13M024	362	228F528	372
079F00	339	142F43	370	188F62	377	217L13M028	356	228F558	372
079F02	339	142F44*	371	188F62	378	217L13M028	358	228F687	372
081F778	363	143F248	371	188F63	379	217L13M028	361	228F808	372
082L67	364	144F298	364	188F63	377	217L13M028	362	228F817	372
083L96M032	364	144F308	364	188F63	377	217L13M032	356	228F847	372
083L96M034	364	144F33	363	188F63	378	217L13M032	358	236L72M014FIN	340
083L96M036	364	144F34	363	188F65	378	217L13M032	361	236L72M016FIN	340
083L96M040	364	144F888	364	188F738	364	217L13M032	362	236L72M018FIN	340
083L96M048	364	145F328	364	188F758	364	217L13M036	356	236L72M020FIN	340
092F789	364	145F543*	371	193K09	334	217L13M036	358	236L72M022FIN	340
102F198	364	146F788	336	193K10	334	217L13M036	361	236L72M024FIN	340
102F278	364	146K80	334	193K11	334	217L13M036	362	236L72M028FIN	340
102F378	364	147F078	363	194F228	363	217L13M040	356	236L72M032FIN	340
103F448	364	148F228	374	195K68	334	217L13M040	358	236L72M036FIN	340
103F458	364	156F43	363	197F347	336	217L13M040	361	236L72M040FIN	340
114F678	364	156F648	364	197F357	336	217L13M040	362	236L72M044FIN	340
118F299	369	156F658	364	197F527	335	217L13M044	356	236L72M048FIN	340
121F012	336	156F837	363	197K51*	334	217L13M044	358	236L75M020	364
121K10≠	334	157F11	363	198F71	363	217L13M044	361	240L08018	364
121K11	334	158F062	336	200F168	372	217L13M044	362	240L08020	364
122F188	371	158F538	371	201F188	364	217L13M048	356	240L08022	364
122F248	371	159F367	335	206F578	353	217L13M048	358	240L50	370
122F413	371	164F329	371	213F117	372	217L13M048	361	240L51	370
122F508	371	168F818	364	217F422	335	217L13M048	362	242F508	364
122F518	371	171F468	335	217F43	336	219F888	336	243F769	372
122F568	371	171F798	363	217F432	335	220F498	372	243F798	372
122F578	371	173F698	371	217F44	336	220F718	353	243F808	372

Part Number	Page	Part Number	Page	Part Number	Page	Part Number	Page	Part Number	Page
243F85	372	269F32	372	292K98	334	340L60M018FIN	341	354F198	336
244F17	379	269F33	372	292K99	334	340L60M020FIN	341	361F308	373
244F17	377	269F34	372	293F183	373	340L60M022FIN	341	361F913	370
244F17	377	269F35	372	293K00	334	340L60M024FIN	341	362F153	336
244F17	378	269F36	372	293K01	334	340L60M028FIN	341	362F432	336
244F647	364	269F378	372	293K02	334	340L60M032FIN	341	362F498	373
245K37	334	269F393	372	293K03	334	340L60M036FIN	341	362F918	373
249F33*	372	269F403	372	293L14	364	340L60M040FIN	341	364F228	373
249F768	364	269F413	372	300F688	349	340L60M044FIN	341	364F272	373
249F773	364	269F42	372	300F71	370	340L60M048FIN	341	364F288	373
250F088	336	269F468	372	301F567	363	340L61M018FIN	341	364F308	373
251F198	364	269F479	372	303F242	364	340L61M020FIN	341	364F36*	373
252F82	337	269F488	372	303F25	337	340L61M022FIN	341	364F37*	373
253F118	372	269F499	372	304F337	370	340L61M024FIN	341	364F38*	373
253F758	336	269F528	372	304F347	370	340L61M028FIN	341	364F39*	373
253F768	336	269F538	372	305F318 Fin	353	340L61M032FIN	341	365F003	373
253F778	336	269F549	372	306F068	373	340L61M036FIN	341	365F013	373
253F858	336	269F559	372	306F078	373	340L61M040FIN	341	365F033	373
253F97	337	269F569	372	310F488	336	340L61M044FIN	341	365F958	336
253K66	334	269F578	372	314F887	335	340L61M048FIN	341	365F968	336
253K67	334	269F587	372	314F987	335	341F318	373	365F98*	373
254F73	372	269F608	372	314F997	336	342F032	364	366F70	338
255F41*	372	269F73	370	315F93 Fin*	356	342F052	363	368F918	336
255F53	337	269F74	370	315F94 Fin*	356	351F50*	373	370F29	337
255F54	338	269F75	370	318F64	341	351F51*	373	370F31	337
261F118	364	269F76	370	318F65	341	351F528	373	370F33	338
261F288	372	269F808	353	318F66	341	351F553	373	370F35	338
261F298	364	269F91*	372	318F67	341	351F56*	373	376F37*	374
261F298	377	269F92*	372	318F68	341	351F57*	373	376F42	373
261F308	375	270F01*	372	318F69	341	351F72	373	377F308	346
261F318	372	270F02*	372	320F442	336	351F73	373	377F80	344
261F54	372	270F11*	372	320F442	364	351F797	373	378F745	373
261F658	372	270F13	375	321F23	375	351F807	373	378K18	334
261F95	378	270F15	337	321F24	375	351F823	373	379F805	336
262F901	372	281F272	336	321F24*	374	351F833	373	381F30	363
264F698	345	282F325	372	321F907	373	351F849	373	383F82	344
264F958	372	282F357	372	328F80	375	351F85*	373	384F03	348
267F348*	375	283F81	364	329F998	336	351F867	373	384F11	344
267F97	337	284F138	336	330F10	377	351F873	373	385F545	375
268F647	372	284F67*	372	333F519	373	351F883	373	386F453	376
268F848	372	284F977	373	333F998	336	351F897	373	387F218	375
268F878	372	286F507	363	334F128	336	351F907*	373	387F248	375
269F048	372	287F608	364	334F238	336	351F988	373	387F278	375
269F058	372	291F498	373	334F99	374	352F021	373	387F308	375
269F08	372	291F578	373	334F998	339	352F042	370	387F638	375
269F088	339	292K95	334	334K00	334	352F05	370	387F668	375
269F098	348	292K96	334	334K01	334	352F068	373	387F698	375
269F31	372	292K97	334	335F988	364	353F868	336	387F728	375



Part Number	Page	Part Number	Page	Part Number	Page	Part Number	Page	Part Number	Page
391F575	376	407T324097 2R	335	418F352	374	436F418	375	446F231	375
391F658	338	407T324125 3R	335	418F368	374	436F428	375	446F572	336
391F658	346	407T324153 4R	335	418F378	374	436F438	375	446F582	336
392F22	370	407T334097 2S	335	420F128*	374	436F448	375	446K68	334
392F24	370	407T334125 3S	335	422F88	337	436F801	375	447F14	379
392F28	370	407T334153 4S	335	422L842144	364	436F811	375	447F14	377
392F29	370	407T414242 2L	335	422L848144	364	436F828	375	447F14	377
392L19*	374	407T414270 3L	335	423F54	339	436F838	375	447F14	378
393L13-M672*	374	407T414298 4L	335	423F55	339	436F858	375	447F24	348
393L13-M672*	374	407T414326 5L	335	423F57	339	436L328557	375	447F25	348
394F198	364	407T414354 6L	335	423F58	339	437F26	342	447F41	337
399F178	374	407T424242 2R	335	423L71	364	437F28	342	447F42	337
399F188	374	407T424270 3R	335	424F428	370	437F40	342	447F43	337
402F29	339	407T424298 4R	335	424F438	370	437F41	342	447F43	366
402F30	339	407T424326 5R	335	424F838	364	437F42	342	447F44	338
402F31	339	407T424354 6R	335	426F52	343	438F37	342	447F45	338
402F33	339	407T434158	335	427F06	342	438F38	342	447F46	338
402F34	339	407T434193	335	427F078	342	438F418	336	449F828	375
402F35	339	408F258	374	427F36	343	438F428	336	461F108	336
402F738	339	408K45	334	427F37	343	438F90	345	463F918	370
402F983	374	409K12*	334	427F39	343	439F25	342	463F928	376
402F99*	374	411L62	370	427F43	343	439F26	342	464F028	374
402F99*	374	411L62M016FIN	341	427F45	343	439F27	342	464F915	374
403F035	374	411L62M018FIN	341	427F47	343	439F33	349	464K97	334
403F30*	374	411L62M020FIN	341	428F32	342	439F34	349	465F57	340
403F302 Fin	353	411L63	370	428F33	342	439F35	349	466F229	340
403F568	340	411L63M016FIN	341	428F34	342	442F952	363	466F279	364
403F677	339	411L63M018FIN	341	428F66	337	444F748	336	466F40	342
404F858	340	411L63M020FIN	341	429F08	340	444F758	336	466F41	342
404F868	339	412F133*	374	429F317	348	444K87	334	466F42	342
405F428	374	412F157	374	429F41	340	444K88	334	466F45	342
405F458	374	412F167	374	429F41	366	444K89	334	466F46	342
405F476	374	412F451	374	430F47	345	444K94	334	466F47	342
405F496	374	413F488	336	432F86	349	444K96	334	466F50	342
405F772	364	413F498	336	433F48	344	444K97	334	466F51	342
405L138M018FIN	341	415F16	363	433F49	344	444K98	334	466F52	342
405L138M020FIN	341	415K73	334	433F76	349	444K99	334	466F73	342
405L138M022FIN	341	415K74	334	433F77	349	445F318	349	466F74	342
405L148M018FIN	341	416F355	370	433F78	349	445F38	346	466F75	342
405L148M020FIN	341	416F38	364	433F978	374	445F43	346	467F338	364
405L148M022FIN	341	416F39	337	433F988	374	445F82	348	467F345	364
406F438	336	416F49	340	434F008	374	445F83	348	467F358	364
407K63	334	416F818	374	434F028	374	445F84	348	467F36	364
407K64	334	416F84	340	435F00	345	445F85	349	467F378	364
407K65	334	416K07	334	436F038	370	445F869	348	467F733	370
407T314097 2L	335	416K08	334	436F177	340	446F208	375	467F942	374
407T314125 3L	335	418F288	374	436F258	375	446F21M	376	467F952*	374
407T314153 4L	335	418F308	374	436F298	375	446F228	376	468F022*	374

Part Number	Page	Part Number	Page	Part Number	Page	Part Number	Page	Part Number	Page
468F032*	374	483F82	348	489F028	336	503F533	374	544F77	343
468F122	374	483F83	348	489F882	363	503F557	374	544F79	343
468F132	374	483F84	348	489F892	363	503F567	374	544F80	343
468F147	374	483K01	334	489K49	334	506F57	338	544F82	343
468F157	374	484F208	375	490F558	336	507F01	346	544F83	343
468F162	374	484F218	375	492F195	374	509F49	379	544F84	343
468F172	374	484F418	374	492F20	375	509F49	377	544F85	343
468F202*	374	484F74	340	492F21	375	509F49	377	544F87	343
468F212*	374	484F76	345	492F59	375	509F49	378	544F88	343
468F246	374	484F898	374	492K90	334	511F51	342	544F89	343
468F256	374	484F90	344	492K91	334	511F52	342	544F91	343
468F266	374	484F918	336	492K92	334	511F73	346	544F92	343
468F276	374	484F928	336	493F31	348	518F067	376	544F93	343
468F305	376	484F938	336	493F34	348	518K73	334	544F94	344
468F34	378	484F948	336	493F76	334	518K74	334	544F95	344
468F355	374	484F958	336	493F77	334	518K75	334	544F96	344
468K87	334	484F968	336	493F78	334	518K76	334	544F97	344
469F67	375	485F74	343	494F72	380	518K77	334	544F98	344
469F68	375	487F08	348	494F74	380	519F09	349	544F99	344
480F128	374	487K10	334	494F75	380	519F10	349	545F00	344
480F13*	374	487K11	334	494F76	380	519F11	349	545F42	344
480F188	374	487K13	334	494F77	380	519F12	349	545F43	344
480F198	374	487K15	334	494F92	380	520F358	336	545F44	344
480F208	374	487K17	334	494F94	380	522F932	336	545F45	344
480F28*	374	487K19	334	496F32	363	523F038	375	545F79	343
480F30*	374	487K21	334	496F33	363	523K21	334	545F80	343
480F33*	374	487K38	334	496F34	363	525F998	375	545F81	343
480F375	374	487L048697	376	496F68	375	526F168	375	545F82	343
480F68	361	487M048589	370	496F69	375	526F321	375	545F83	343
480F688 Fin	356	487M048589	376	496F718	364	526F527	376	545F84	343
480F69	364	488F00	345	497F528	348	526F533	376	545F85	343
480F70	364	488F01	345	498F86	346	526L518540	375	545F86	343
480F708	364	488F03	344	498F87	346	526L928759	376	545F87	343
481K19	334	488F04	344	498F928	349	534F008	375	545F88	343
481K28	334	488F05	344	499F30	379	534K25	334	546F978	335
482F37	342	488F07	344	499F30	378	540F27	377	549F352	363
482F442	374	488F088	336	499F598	370	544F13	345	549F362	363
482F49*	374	488F088	342	499F828	348	544F14	345	549F52	337
482F73*	374	488F09	340	499F838	348	544F38	345	552F368	375
482F798	375	488F108	336	499F848	348	544F39	345	552F416	375
483F118	346	488F108	342	502F10	346	544F40	345	552F468	375
483F30	342	488F27	342	502F27	346	544F41	345	552F478	375
483F34	342	488F31	342	502F62	346	544F42	345	552F598	375
483F35	342	488F928	336	502F75	370	544F43	344	552F608	375
483F36	342	488K84	334	502F96	370	544F44	345	553F484 x length	335
483F79	348	488K85	334	503F15	346	544F45	345	553F492 x length	335
483F80	348	488K98	334	503F52	370	544F46	344	553F502 x length	335
483F81	348	488K99	334	503F533	370	544F76	343	556F558	361

Part Number	Page	Part Number	Page	Part Number	Page	Part Number	Page	Part Number	Page
557F29	344	574F29 x574F26	362	585K26	334	586L19M048	362	598F815	358
557F928	375	574F30	362	585K27	334	596F618	361	598F815	360
557F938	375	574F30 x574F25	362	585K46	334	596F618 Fin	356	598F825	358
557F948	375	574F30 x574F26	362	586F16	355	596F628	361	598F825	360
557F958	375	574F55	362	586F17	355	596F628 Fin	356	598F835	358
558F528	375	574F56	362	586F18	355	596F638	361	598F835	360
559K94	334	574K05	334	586F51 Fin	356	596F66	355	598F905	358
559K95	334	574K07	334	586F512	360	596F67	355	598F905	360
561F29	374	578F435	354	586F80	355	596F68	355	599F275	358
562F402	336	578F435	376	586F81	355	596F825	354	599F275	360
562F422	336	579F11	362	586F82	355	596F825	376	599F389	336
563F885	354	579K14	334	586F86	355	596F879	336	599F91	357
563F885	376	580F38	362	586F87	355	596F898	336	599F91	359
563F895	354	580F387	362	586F88	355	596K29	334	599F92	357
563F895	376	580K99	334	586L19	352	596K30	334	599F92	359
563F905	354	581F96	349	586L19	360	596K31	334	599F93	357
563F905	376	582F112	363	586L19M016	356	596K32	334	599F93	359
563F945	354	582F122	363	586L19M016	361	597F24	377	599F94	357
563F945	376	582F132	363	586L19M016	362	597F24	378	599F94	359
563F955	354	582F142	363	586L19M018	356	597F24	379	599F95	357
563F955	376	582F298	336	586L19M018	361	597F35	377	599F95	359
563F965	354	584F46	348	586L19M018	362	597F52	377	599F96	357
563F965	376	585F312	336	586L19M020	356	597F52	379	599F96	359
564F115	375	585F327	335	586L19M020	361	597F52	378	599F97	357
564F128	375	585F337	336	586L19M020	362	597F58	378	599F97	359
564F345	375	585F358	336	586L19M022	356	597F59	378	599F98	357
564F378	375	585F367	336	586L19M022	361	597F78	377	599F98	359
564F408	375	585F377	336	586L19M022	362	597F78	378	599F99	357
564F438	375	585F387	336	586L19M024	356	597F78	380	599F99	359
564F688	375	585F397	335	586L19M024	361	597F92	379	600F00	359
564F888	375	585F407	336	586L19M024	362	597F92	378	600F00	357
564F898	375	585F705	354	586L19M028	356	597F93	379	600F01	359
564F908	375	585F705	376	586L19M028	361	597F93	378	600F01	357
564F918	375	585F715	354	586L19M028	362	597F94	377	600F02	357
564K52	334	585F715	376	586L19M032	356	597F94	378	600F02	359
564K53	334	585F72	376	586L19M032	361	597F95	377	600F03	357
564K59	334	585F729	355	586L19M032	362	597F95	378	600F03	359
564K60	334	585F76 Fin	356	586L19M036	356	597F96	377	600F04	357
566F50	369	585F762	357	586L19M036	361	597F96	378	600F04	359
566F51	369	585F762	359	586L19M036	362	597F97	377	600F05	357
568F11	346	585F77 Fin	356	586L19M040	356	597F97	378	600F05	359
568F12	346	585F772	357	586L19M040	361	598F20	355	600F06	357
569F45	348	585F772	359	586L19M040	362	598F21	355	600F06	359
574F158	338	585F78 Fin	356	586L19M044	356	598F22	355	600F07	357
574F258	362	585F79 Fin	356	586L19M044	361	598F59 Fin	356	600F07	359
574F268	362	585F792	359	586L19M044	362	598F592	358	600F08	357
574F29	362	585K24	334	586L19M048	356	598F592	360	600F08	359
574F29 x574F25	362	585K25	334	586L19M048	361	598F809	358	600F09	357

Part Number	Page	Part Number	Page	Part Number	Page	Part Number	Page	Part Number	Page
600F09	359	602F171	375	609F38	337	616F078	348	630K472 x Fin	334
600F10	357	602F181	375	610F01	337	616F088	348	631F248	354
600F10	359	602F198	339	610F01	366	616F12	340	631F248	357
600F11	357	603F207	335	610F02	337	616F208	336	631F248	359
600F11	359	603F55	378	610F49	334	616F218	336	649F99 fin	365
600F12	357	603F55	380	610K46	334	622F298	336	650F00	365
600F12	359	603F57	378	610K48	334	622F308	336	650F03	365
600F13	357	603F57	380	610L43	364	622F308	354	650F04	365
600F13	359	603F64	375	610L44	364	622F308	357	650F05	365
600F14	357	604F228	358	612K88	334	622F308	359	650F06	365
600F14	359	604F228	360	612K90	334	622F328	336	650F07	365
600F415	354	604F228	361	612K91	334	622F328	336	650F08	365
600F415	376	604F228 Fin	353	612K93	334	622F698	336	650F095	367
600F425	354	604F228 Fin	356	612K94	334	622F728	336	650F105	367
600F425	376	604F238	361	613F029	363	624F427	340	650F11	365
600F62	357	604F238 Fin	356	613F102	363	624F439	340	650F12	365
600F62	359	604F248	361	613F112	363	624F449	340	650F13	365
600F63	357	604F248 Fin	356	613F122	363	624F455	340	650F14	365
600F63	359	604F258	361	613F132	363	624F478	340	650F15	365
600F64	357	604F268	358	613F142	363	624F488	339	650F16	365
600F64	359	604F268	360	613F152	363	624F49	339	650F189	365
600F65	357	604F268	361	613F162	363	624F53	339	650F21	365
600F65	359	604F268 Fin	356	613F172	363	628F107142	335	650F228	365
600F66	357	604F278	361	613F222	363	628F107171	335	650F238	365
600F66	359	604F278 Fin	356	613F232	363	628F107236	335	650F248	365
600F67	357	604F288	361	613F242	363	628F825	336	650F279	366
600F67	359	604F288 Fin	356	613F252	363	628F835	336	650F279	375
600F68	357	604F298	361	613F352	363	628F892	335	650F288	366
600F68	359	605F42	342	613F422	363	628F912	335	650F318	366
600F69	357	605F43	337	613F432	363	628F922 x Fin	335	650F358	365
600F69	359	605F768	364	615F51	379	628F932	336	650F368	365
600F70	357	605F778	364	615F51	378	628F962	335	650F378	365
600F70	359	605F90	363	615F52	379	628K852 x Fin	334	650F388	365
600F71	357	606F018	364	615F52	378	628K872 x Fin	334	650F398	365
600F71	359	606F028	364	615F53	379	628K882 x Fin	334	650F408	365
600F72	359	606F038	363	615F53	378	628K902 x Fin	334	650F418	365
600F72	357	606K73	334	615F54	379	628K952 x Fin	334	650F428	365
600F73	357	606K74	334	615F54	378	628K972 x Fin	334	650F438	365
600F73	359	606K75	334	615F55	379	628K992 x Fin	334	650F448	365
601F229	336	606K76	334	615F55	378	629F062 x Fin	335	650F458	365
601F24	355	606K77	334	615F56	379	629F072 x Fin	335	650F468	365
601F25	355	606K78	334	615F56	378	629K002 x Fin	334	650F489	367
601F26	355	606K79	334	615F58	379	629K012 x Fin	334	650F498	367
601F283 Fin*	356	607F919	336	615F58	378	629K022 x Fin	334	650F508	366
601F69	355	609F36	337	615F59	379	629K032 x Fin	334	650F518	366
601F829	356	609F36	366	615F59	378	629K042 x Fin	334	650F528	365
601F829	355	609F37	337	615F60	379	630F482 x Fin	335	650F538	366
602F151	375	609F37	366	615F60	378	630F494	335	650F548	367

Part Number	Page	Part Number	Page	Part Number	Page	Part Number	Page	Part Number	Page
650F558	367	651F538	369	652F60	367	652F84	367	653F66	367
650F568	367	651F545	369	652F61	367	652F85	367	653F66	368
650F578	366	651F568	369	652F61	368	652F86	367	653F68	367
650F588	365	651F578	369	652F62	367	652F87	367	653F68	368
650F598	365	651F587	369	652F62	368	652F88	367	653F69	367
650F60 fin	367	651F608	369	652F62	368	652F89	367	653F69	368
650F62	366	651F618	369	652F63	367	652F90	367	653F70	367
650F63	366	651F628	369	652F64	367	652F92	367	653F70	368
650F64	365	651F638	369	652F64	368	652F93	367	653F70	368
650F678LR	366	651F648	369	652F65	367	652F95	367	653F71	367
650F678RR	366	651F655	369	652F65	368	652F96	367	653F71	368
650F698LR	366	651F675	369	652F65	368	652F99	367	653F72	367
650F698RR	366	651F708	369	652F66	367	653F02	367	653F72	368
650F718	367	651F738	369	652F67	367	653F03	367	653F73	367
650F728	367	651F758	369	652F67	368	653F04	367	653F73	368
650F738	367	651F828	369	652F68	367	653F05	367	653F73	368
650F778	365	651F838	369	652F68	368	653F08	367	653F74	367
650F798	365	651F848	369	652F68	368	653F09	367	653F74	368
650F808	367	651F858	369	652F69	367	653F10	367	653F75	367
650F818	367	651F868	369	652F70	367	653F12	365	653F75	368
650F828	366	651F878	369	652F70	368	653F13	365	653F76	367
650F878	366	651F888	369	652F71	367	653F14	365	653F76	368
650F888	366	651F898	369	652F71	368	653F50	367	653F76	368
650F93	365	651F928	369	652F71	368	653F50	368	653L157014	366
650F959	366	651F938	369	652F72	367	653F53	367	653L163016	366
650F968	365	651F948	369	652F73	367	653F53	368	653L163020	366
650F978	366	651F965	369	652F73	368	653F54	367	653L183016	366
650F998	365	651F988	369	652F74	367	653F54	368	653L183020	366
650L65	366	652F048	369	652F74	368	653F55	367	654F07	337
650L657020	366	652F058	369	652F74	368	653F55	368	654F08	337
651F00	368	652F068	369	652F75	367	653F55	368	654F208	366
651F01	368	652F098	369	652F76	367	653F56	367	654F218	366
651F04	368	652F108	369	652F76	368	653F56	368	655F028	369
651F06	368	652F118	369	652F77	367	653F57	367	655F15	366
651F08	368	652F128	369	652F77	368	653F57	368	655F16	366
651F09	368	652F138	369	652F77	368	653F59	367	655F17	366
651F10	368	652F148	369	652F78	367	653F59	368	655F488LR	366
651F362	369	652F158	369	652F79	367	653F60	367	655F488RR	366
651F372	369	652F218	369	652F79	368	653F60	368	655F548	369
651F389	369	652F228	369	652F80	367	653F61	367	655F698	369
651F398	369	652F239	369	652F80	368	653F61	368	655F708	369
651F408	369	652F298	366	652F80	368	653F61	368	655F718	366
651F418	369	652F57	367	652F81	367	653F62	367	656F408	366
651F425	369	652F58	367	652F82	367	653F62	368	656F41	366
651F448	369	652F58	368	652F82	368	653F63	367	656F44	367
651F478	369	652F59	367	652F83	367	653F63	368	656F45	367
651F498	369	652F59	368	652F83	368	653F65	367	656F46	367
651F508	369	652F59	368	652F83	368	653F65	368	656F47	367

Part Number	Page	Part Number	Page	Part Number	Page	Part Number	Page	Part Number	Page
656F48	367	671F08	347	681F40	339	684F448	358	685F535	376
656F49	367	671F09	347	681F41	339	684F448	360	685F545	376
656F50	367	671F10	347	681F448	340	684F45 Fin	356	685F555	376
656F51	367	677F04	368	681F608	365	684F46 Fin	356	685F875	355
656F52	367	677F05	368	681F618	365	684F528	356	686F858	354
656F53	367	677F068	369	681F62	365	684F528	358	686F858	357
656F58	368	677F098	369	681F63	365	684F528	360	686F858	359
656F59	368	677F13	368	681F708	367	684F559	339	686F868	354
656F60	368	677F14	368	681F718	367	684F775	355	686F868	357
656F61	368	677F15	368	681F768	367	684F775	360	686F868	359
656F62	368	677F16	368	681F778	367	684F775	360	686F88 Fin	356
656F63	368	677F26	368	682F018	340	684F785	355	686F882	360
656F64	369	677F27	368	682F298	336	684F785	360	688F017	340
656F658	369	677F28	368	682F298	354	684F785	360	688F177	340
656F668	366	677F42	334	682F298	357	684F795	355	688F77	377
670F30	347	677F768LR 626	369	682F298	359	684F795	360	688F77	377
670F31	347	677F768RR 626	369	682F398	336	684F795	360	688F77	378
670F32	347	677F778LR 626	369	682F398	354	684F805	355	688F77	379
670F33	347	677F778RR 626	369	682F398	357	684F805	360	688F95	377
670F34	347	678F008LR	366	682F398	359	684F805	360	688F95	377
670F35	347	678F008RR	366	682F608	356	684F815	355	688F95	378
670F36	347	678F028	369	682F618	356	684F815	360	688F95	379
670F37	347	678F248	356	682F628	356	684F815	360	689F01	377
670F38	347	678F248	358	682F638	356	684F825	355	689F01	379
670F57	347	678F248	360	682F64 Fin	356	684F825	360	689F01	378
670F58	347	678F25	376	682F65 Fin	356	684F825	360	689F02	377
670F59	347	678F25 Fin	356	682F67 Fin	356	684F835	355	689F02	379
670F60	347	678F252	358	682F68 Fin	356	684F835	360	689F02	378
670F61	347	678F252	360	682F788	356	684F835	360	689F03	377
670F62	347	678F252 Fin	351	682F788	358	684F845	355	689F03	379
670F63	347	678F498	356	682F788	360	684F845	360	689F03	378
670F64	347	678F498	360	682F86 Fin	356	684F845	360	689F04	377
670F65	347	678F548	339	682F87 Fin	356	684F855	355	689F04	379
670F66	347	678F677	339	682F91	376	684F855	360	689F04	378
670F67	347	679F818	353	682F918	336	684F855	360	689F12	378
670F68	347	679F818	356	682F958	354	684F865	355	689F12	380
670F69	347	679F818	358	682F958	357	684F865	360	689F13	378
670F70	347	679F818	363	682F958	359	684F865	360	689F14	378
670F71	347	679F818	355	682F969	354	684F875	360	689F15	378
670F72	347	680F348	349	682F969	357	684F875	360	689F16	378
670F73	347	680F358	349	682F969	359	684F885	355	689F17	378
670F74	347	680F368	349	684F055	340	684F885	360	689F18	378
671F02	347	680F645	336	684F068	340	684F885	360	689F19	378
671F03	347	680L50	360	684F119	340	685F098	336	689F28	346
671F04	347	680L51	360	684F129	340	685F387	340	689F30	346
671F05	347	680L52	360	684F42	366	685F505	376	689F31	346
671F06	347	681F30	339	684F427	366	685F515	376	689F33	346
671F07	347	681F31	339	684F44 Fin	356	685F525	376	689F37	346

Part Number	Page	Part Number	Page	Part Number	Page	Part Number	Page	Part Number	Page
689F39	346	692F23	380	695F247218 - .218"	335	696F51	336	700F82	345
689F50	346	692F24	380	695F247234 - .234"	335	696K43	334	700F83	345
689F52	346	692F25	380	695F247250 - .250"	335	696K45	334	700F84	345
689F54	346	692F632	350	695F247265 - .265"	335	696K46	334	700F86	345
689F58	346	692F642	350	695F247281 - .281"	335	696K48	334	700F87	345
689F60	346	692F652	350	695F252031 - .031"	335	696K52	334	700F907	339
689F62	346	692F662	350	695F252047 - .047"	335	697F338	366	700F957	340
690F44	376	692F672	350	695F252063 - .063"	335	697F348	366	701F228	339
690F975	354	692F752	350	695F252078 - .078"	335	697F358	366	701F60	366
690F985	355	692F762	350	695F252094 - .094"	335	697F368	366	701F61	366
690F985	360	692F862	350	695F252110 - .110"	335	697F50	336	701F62	366
690F985	360	692F932	350	695F252126 - .126"	335	697F507	335	701F63	366
691F52	378	692F942	350	695F252141 - .141"	335	697F862	365	701F705	340
691F53	378	692F952	350	695F252157 - .157"	335	697F942	354	701F748	339
691F54	378	693F208	364	695F252173 - .173"	335	697F942	357	702F987	339
691F55	378	694F312	350	695F252189 - .189"	335	697F942	359	703F997	340
691F56	378	694F322	350	695F252204 - .204"	335	697F988	375	704F269	365
691F57	378	694F332	350	695F252220 - .220"	335	697F995	355	704F279	365
691F72	378	694F352	350	695F252236 - .236"	335	698F038	365	704F479	365
691F72	379	694F392	350	695F252252 - .252"	335	698F22	348	704F489	365
691F74	378	694F442	350	695F252267 - .267"	335	698F22	348	704F569	365
691F74	379	694F482	350	695F252283 - .283"	335	698F43	376	704F579	365
691F78	378	694F522	350	695F252299 - .299"	335	698F44	376	704F589	365
691F89	378	694F562	350	695F257031 - .031"	335	698F45	376	704F599	365
691F90	378	694F602	350	695F257047 - .047"	335	698F46	376	704F62	366
691F93	378	694F682	350	695F257063 - .063"	335	698F51	376	704F63	366
691F94	378	694F722	350	695F257078 - .078"	335	698F52	376	704F648	366
691F96	378	694F802	350	695F257094 - .094"	335	698F53	376	704F658	366
691F96	379	695F042 x Fin	335	695F257110 - .110"	335	700F168	349	704F66	366
691F98	377	695F052 x Fin	335	695F257126 - .126"	335	700F278	339	705F949	339
691F99	377	695F075	354	695F257141 - .141"	335	700F367	349	706F005	369
692F00	378	695F22	375	695F257157 - .157"	335	700F378	349	706F015	369
692F01	378	695F23	375	695F257173 - .173"	335	700F40	345	706F038	365
692F02	377	695F244139 - .139"	335	695F257189 - .189"	335	700F41	345	706F048	365
692F02	378	695F244155 - .155"	335	695F257204 - .204"	335	700F42	345	706F058	365
692F03	377	695F244171 - .171"	335	695F257220 - .220"	335	700F43	345	706F068	365
692F03	378	695F244187 - .187"	335	695F257236 - .236"	335	700F44	345	706F078	365
692F04	378	695F244202 - .202"	335	695F257252 - .252"	335	700F45	345	706F088	365
692F04	379	695F244218 - .218"	335	695F257267 - .267"	335	700F46	345	706F098	365
692F05	378	695F244234 - .234"	335	695F257283 - .283"	335	700F47	345	706F108	365
692F05	379	695F244250 - .250"	335	695F257299 - .299"	335	700F575	336	706F15	365
692F14	380	695F244265 - .265"	335	696F05	376	700F65	349	706F16	365
692F15	380	695F244281 - .281"	335	696F318	375	700F66	349	706F462	366
692F16	380	695F247139 - .139"	335	696F39	349	700F67	349	706F70	349
692F17	380	695F247155 - .155"	335	696F42	336	700F708	340	707F57	349
692F19	380	695F247171 - .171"	335	696F472	335	700F748	340	707F58	349
692F20	380	695F247187 - .187"	335	696F499	335	700F80	345	707F59	349
692F21	380	695F247202 - .202"	335	696F502 x Fin	335	700F81	345	707F60	349

Part Number	Page	Part Number	Page	Part Number	Page	Part Number	Page	Part Number	Page
710F00M	366	712F625	355	715F118	336	733F53	368	754F38	379
710F318LR	366	712F635	355	715F128	336	741F21	349	754F43	378
710F318RR	366	712F645	355	715F152	335	741F22	349	754F44	378
710F328LR	366	712F655	355	715F245	354	741F23	349	754F45	378
710F328RR	366	712F665	355	715F892	336	741F24	349	754F46	379
710F338LR	366	712F675	355	715K14	334	744F208	366	754F52	380
710F338RR	366	712F685	354	716K16	334	744F258	366	754F53	380
710F618	356	712F695	354	716K43	334	744F688	366	754F54	380
710F628	356	712F705	354	716K45	334	751F16	344	754F55	380
710F658	356	712F715	354	716K46	334	751F17	344	754F56	380
710F668	356	712F725	354	716K48	334	753F078	340	754F57	380
711F002	349	712F735	354	720F21	349	753F098	339	754F58	380
712F205	354	712F745	355	720F22	349	753F598	353	754F59	380
712F215	354	712F755	355	720F24	349	753F697	339	754F61	380
712F225	354	712F765	355	720F25	349	754F02	380	754F62	380
712F235	354	712F775	355	720F43	339	754F03	380	754F63	380
712F265	354	712F785	355	720F46	339	754F04	380	754F64	380
712F275	354	712F795	355	720F61	349	754F05	380	754F66	380
712F305	355	713F518	366	720F62	349	754F09	378	754F68	377
712F315	355	713F528	366	720F64	349	754F09	379	754F69	377
712F325	355	713F908	366	720F65	349	754F10	378	754F70	377
712F335	355	713F938	366	721F16	349	754F10	379	754F71	380
712F345	355	713F948	366	721F17	349	754F12	378	754F72	380
712F355	355	713F958	366	721F18	349	754F12	379	754F73	380
712F365	355	713F988	366	721F19	349	754F13	378	754F79	377
712F375	355	713F998	366	723F26	349	754F13	379	754F80	377
712F385	354	714F005	354	723F69	349	754F14	378	754F84	379
712F395	354	714F035	354	724F278	367	754F14	379	754F92	377
712F405	354	714F065	354	728F709	380	754F15	378	754F93	377
712F415	354	714F125	354	728F759	380	754F15	379	754F94	377
712F425	354	714F155	355	728F799	380	754F16	378	754F95	377
712F435	354	714F185	355	728F799	380	754F16	378	754F96	377
712F445	355	714F215	355	728F809	380	754F16	379	754F98	377
712F455	355	714F255	354	728F939	380	754F17	379	756F507	336
712F465	355	714F275	355	730F778	366	754F18	379	756F507	336
712F475	355	714F305	354	733F05	368	754F20	379	756F517	336
712F485	355	714F315	354	733F41	368	754F21	379	756F517	336
712F495	355	714F365	354	733F42	368	754F22	379	756F527	336
712F505	354	714F375	354	733F43	368	754F23	379	756F527	336
712F515	354	714F425	354	733F44	368	754F24	379	756F537	336
712F525	354	714F455	354	733F45	368	754F25	379	756F537	336
712F535	354	714F485	355	733F46	368	754F26	379	756F542	336
712F545	354	714F495	355	733F47	368	754F29	379	756F542	336
712F555	354	714F545	355	733F48	368	754F30	379	756F557	336
712F565	354	714F555	355	733F49	368	754F34	379	756F557	336
712F575	354	714F605	355	733F50	368	754F35	379	756F567	336
712F605	355	714F635	355	733F51	368	754F36	379	756F567	336
712F615	355	715F108	336	733F52	368	754F37	379	756F582	336



Part Number	Page	Part Number	Page	Part Number	Page	Part Number	Page	Part Number	Page
756F582	336	776F225	351	777F215	351	779F405	351	780F89 Fin	352
756F582	336	776F235	351	777F225	351	779F415	351	780F90 Fin	352
756F622	336	776F245	351	777F235	351	779F425	351	780F91 Fin	352
756F622	336	776F335	351	777F245	351	779F515	351	780F92 Fin	352
756F963	364	776F345	351	777F335	351	779F525	351	780F93 Fin	352
763F002243	335	776F395	351	777F345	351	779F575	351	780F94 Fin	352
763F002273	335	776F405	351	777F395	351	779F585	351	780F95 Fin	352
763F002303	335	776F415	351	777F405	351	779F638	352	780F96 Fin	352
763F002333	335	776F425	351	777F415	351	779F648	352	783F048	369
763F002363	335	776F515	351	777F425	351	779F658	352	783F06	368
763F002393	335	776F525	351	777F515	351	779F728	352	783F208	354
763F012030	335	776F575	351	777F525	351	779F738	352	783F308	354
763F012060	335	776F585	351	777F575	351	779F748	352	783F408	354
763F012090	335	776F638	352	777F585	351	779F758	352	785F008	354
763F012120	335	776F648	352	778F215	351	779F787	353	785F018 Fin	354
763F012150	335	776F658	352	778F225	351	779F797	353	785F028 Fin	354
763F012180	335	776F668	352	778F225	351	779F807	353	785F038	354
763F012210	335	776F678	352	778F235	351	779F97 Fin	351	785F048	354
763F012240	335	776F688	352	778F245	351	779F98 Fin	351	785F058	354
763F012270	335	776F698	352	778F245	351	779F99 Fin	351	785F068	354
763F012300	335	776F708	352	778F335	351	780F208	353	785F078 Fin	354
763F012330	335	776F718	352	778F345	351	780F215	351	785F088	354
763F027120	335	776F728	352	778F395	351	780F225	351	785F088	354
763F027150	335	776F738	352	778F405	351	780F235	351	785F108	354
763F027180	335	776F748	352	778F415	351	780F245	351	785F118 Fin	354
763F027210	335	776F758	352	778F425	351	780F335	351	785F138 Fin	354
763F027240	335	776F768	352	778F515	351	780F345	351	785F148	354
763F027270	335	776F778	352	778F525	351	780F395	351	785F158 Fin	354
763F072	335	776F788	352	778F575	351	780F405	351	785F168	354
774F225	351	776F798	352	778F585	351	780F415	351	785F178	354
774F878	352	776F808	352	778F638	353	780F425	351	785F188	354
774F888	352	776F818	352	778F759	353	780F515	351	785F198	354
774F945	351	776F828	352	778F788	352	780F525	351	785F218 Fin	354
774F965	351	776F838	352	778F812	353	780F575	351	785F228	354
774F985	351	776F848	352	778F868	353	780F585	351	785F238	354
775F808	352	776F858	352	778F888	352	780F638	353	785F248	354
775F818	352	776F868	352	778F898	352	780F648	352	785F258	354
775F828	352	776F878	352	778F90 Fin	351	780F658	352	785F268 Fin	354
775F838	352	776F918	352	778F91 Fin	353	780F662	352	785F278	354
775F908 Fin	353	776F928	352	778F968	353	780F808	352	785F288	354
775F918 Fin	353	776F938	352	778F97 Fin	351	780F81 Fin	352	785F298	354
775F948	352	776F948	352	779F215	351	780F82 Fin	352	785F308	354
776F002 Fin	352	776F958	352	779F225	351	780F83 Fin	352	785F318 Fin	354
776F012 Fin	352	776F968	352	779F235	351	780F84 Fin	352	785F328	354
776F022 Fin	352	776F978	352	779F245	351	780F85 Fin	352	785F338	354
776F032 Fin	352	776F988	352	779F335	351	780F86 Fin	352	785F348	354
776F042 Fin	352	776F998	352	779F345	351	780F87 Fin	352	785F358	354
776F215	351	777F208	352	779F395	351	780F88 Fin	352	785F378 Fin	354

Part Number	Page	Part Number	Page	Part Number	Page	Part Number	Page	Part Number	Page
785F388 Fin	354	796F248	357	797F875	358	799F505	354	854F04	346
789F859	380	796F258	357	797F875	360	799F515	354	854F05	346
789F869	380	796F268	357	797F915	358	799F525	354	854F06	346
789F879	380	796F30 x Fin	364	797F915	360	799F535	354	854F08	346
789F929	380	796F318	357	797F925	358	799F545	354	854F09	346
790F047	340	796F328	357	797F925	360	799F555	354	854F11	342
790F208	353	796F338	357	797F935	358	799F565	354	854F15	342
790F215	351	796F358	357	797F935	360	799F575	354	854F19	342
790F225	351	796F368	357	797F945	358	799F585	354	854F23	342
790F225	351	796F378	357	797F945	360	799F595	354	854F27	342
790F235	351	796F378	359	798F115	358	799F605	355	Ø 236L718018	374
790F245	351	796F388	357	798F115	360	799F615	355	Ø 399F168	374
790F245	351	796F398	357	798F125	358	799F625	355	Ø 405F466	374
790F335	351	796F398	357	798F125	360	799F635	355	Ø 409F836	374
790F345	351	796F398	359	798F135	358	799F645	355		
790F395	351	796F408	357	798F135	360	799F655	355		
790F405	351	796F408	359	798F145	358	799F665	355		
790F415	351	796F43	364	798F145	360	799F675	355		
790F425	351	796F46 x Fin	364	798F155	358	799F685	355		
790F515	351	797F618	359	798F155	360	799F695	355		
790F525	351	797F628	359	798F165	358	799F805	354		
790F575	351	797F638	359	798F165	360	799F815	354		
790F585	351	797F648	359	798F175	358	799F825	354		
790F988	353	797F658	359	798F175	360	799F835	354		
790F988	353	797F668	359	798F185	358	799F845	355		
790F998	353	797F678	359	798F185	360	799F855	355		
790F998	353	797F688	359	798F215	360	799F865	355		
791F51 x Fin	364	797F698	359	798F215	360	799F875	355		
791F59	349	797F708	359	798F225	360	813F505	340		
791F60	349	797F718	359	798F225	360	820F008	339		
791F82 Fin	364	797F728	359	798F235	360	820F048	340		
791F83 Fin	364	797F738	359	798F235	360	820F068	340		
791F84 Fin	364	797F748	359	798F245	360	820F078	340		
791F85 Fin	364	797F758	359	798F245	360	820F088	340		
791F86 Fin	364	797F768	359	798F255	360	820F148	339		
791F87 Fin	364	797F778	359	798F255	360	820F168	340		
792F997	335	797F788	359	798F265	360	820F268	339		
794F509	380	797F808	359	798F265	360	820F278	339		
794F519	380	797F818	360	798F275	360	820F348	339		
794F529	380	797F828	358	798F275	360	820F358	339		
794F539	380	797F828	360	798F285	360	852F307	340		
795F97	377	797F838	360	798F285	360	852F318	340		
796F118	358	797F845	358	798F295	351	853F05	348		
796F118	360	797F845	360	798F305	351	853F865	340		
796F208	357	797F855	358	798F395	351	853F875	340		
796F218	357	797F855	360	798F405	351	854F00	346		
796F228	357	797F865	358	798K912 x Fin	334	854F01	346		
796F238	357	797F865	360	798K922 x Fin	334	854F03	346		



ASSA ABLOY

# Notes

January 1, 2019





For more information regarding Corbin Russwin Locksets, Exit Devices, Door Controls and Key Systems, contact your authorized Corbin Russwin Distributor or Sales Representative.



**Corbin Russwin Architectural Hardware**

225 Episcopal Road  
Berlin, CT 06037  
Phone 800-543-3658  
Fax 800-447-6714  
[www.corbinrusswin.com](http://www.corbinrusswin.com)

**Notice:** This price book takes precedence over the catalog as to the correctness and availability of items in our entire line.

Corbin Russwin and Design®, Corbin®, Russwin®, and Design® Access 800®, Muséo®, and SecureBolt® are registered trademarks of Corbin Russwin, Inc., an ASSA ABLOY Group company. Safeguard™, PathLite™ and Vineyard™ are trademarks of Corbin Russwin, Inc. an ASSA ABLOY Group company. Unitrol® is a registered trademark of Yale Security Inc., an ASSA ABLOY Group company. These materials are protected under US copyright laws. All contents current at time of publication. Corbin Russwin Inc., an ASSA ABLOY Group company reserves the right to change availability of any item in this catalog, its design, construction, and/or its materials. Other products' brand names may be trademarks or registered trademarks of their respective owners and are mentioned for reference purposes only.

Copyright © 2002 - 2019 Corbin Russwin, Inc., an ASSA ABLOY Group company. All rights reserved. Reproduction in whole or in part without the express written permission of Corbin Russwin, Inc. is prohibited.