

CORNING

MobileAccess
Wireless Solutions

MobileAccessGX™ DAS System Installation and Configuration Guide

P/N: 709C010701
REV: A0
Date: MAY, 2012

Corning MobileAccess
8391 Old Courthouse Road, Suite 300, Vienna, VA 22182
Tel: +1(866)436-9266, +1(703)848-0200 TAC: +1(800)787-1266, Fax: +1(703)848-0280
www.corning.com/mobileaccess

MobileAccessGX and MobileAccess are trademarks of Corning MobileAccess, Inc.
Corning MobileAccess is a trademark of Corning Incorporated.
Corning MobileAccess Inc. is a wholly-owned affiliate of Corning Incorporated.

Preface Material

© Copyright 2012, MobileAccess All Rights Reserved.

This document may contain confidential and proprietary information of Corning MobileAccess, Inc. ("MobileAccess") and may not be copied, transmitted, stored in a retrieval system or reproduced in any format or media, in whole or in part, without the prior written consent of MobileAccess. Information contained in this document supersedes any previous manuals, guides, specifications, data sheets or other information that may have been provided or made available to the user.

This document is provided for informational purposes only, and Corning MobileAccess does not warrant or guarantee the accuracy, adequacy, quality, validity, completeness or suitability for any purpose of the information contained in this document. Corning MobileAccess reserves the right to make updates, improvements and enhancements to this document and the products to which it relates at any time without prior notice to the user. CORNING MOBILEACCESS MAKES NO WARRANTIES, EXPRESS OR IMPLIED, INCLUDING, WITHOUT LIMITATION, THOSE OF MERCHANTABILITY AND FITNESS FOR A PARTICULAR PURPOSE, WITH RESPECT TO THIS DOCUMENT OR ANY INFORMATION CONTAINED HEREIN.

Policy for Warrantee and Repair

Corning MobileAccess tests and inspects all its products to verify their quality and reliability. Corning MobileAccess uses every reasonable precaution to ensure that each unit meets their declared specifications before shipment. Customers should advise their incoming inspection, assembly, and test personnel about the precautions required in handling and testing our products. Many of these precautions can be found in this manual.

The products are covered by the following warranties:

General Warranty

Corning MobileAccess warrants to the original purchaser all standard products sold by Corning MobileAccess to be free of defects in material and workmanship for one (1) year from date of shipment from Corning MobileAccess. During the warranty period, MobileAccess will repair or replace any product that Corning MobileAccess proves to be defective. This warranty does not apply to any product that has been subject to alteration, abuse, improper installation or application, accident, electrical or environmental over-stress, negligence in use, storage, transportation or handling.

Specific Product Warranty Instructions

All Corning MobileAccess products are warranted against defects in workmanship, materials and construction, and to no further extent. Any claim for repair or replacement of units found to be defective on incoming inspection by a customer must be made within 30 days of receipt of shipment, or within 30 days of discovery of a defect within the warranty period.

This warranty is the only warranty made by MobileAccess and is in lieu of all other warranties, expressed or implied. Corning MobileAccess sales agents or representatives are not authorized to make commitments on warranty returns.

Returns

In the event that it is necessary to return any product against above warranty, the following procedure shall be followed:

1. Return authorization is to be received from MobileAccess prior to returning any unit. Advise Corning MobileAccess of the model, serial number, and discrepancy. The unit may then be forwarded to Corning MobileAccess, transportation prepaid. Devices returned collect or without authorization may not be accepted.
2. Prior to repair, Corning MobileAccess will advise the customer of our test results and any charges for repairing customer-caused problems or out-of-warranty conditions etc.

3. Repaired products are warranted for the balance of the original warranty period, or at least 90 days from date of shipment.

Limitations of Liabilities

Corning MobileAccess's liability on any claim, of any kind, including negligence for any loss or damage arising from, connected with, or resulting from the purchase order, contract, quotation, or from the performance or breach thereof, or from the design, manufacture, sale, delivery, installation, inspection, operation or use of any equipment covered by or furnished under this contact, shall in no case exceed the purchase price of the device which gives rise to the claim.

EXCEPT AS EXPRESSLY PROVIDED HEREIN, MOBILEACCESS MAKES NO WARRANTY, EXPRESSED OR IMPLIED, WITH RESPECT TO ANY GOODS, PARTS AND SERVICES PROVIDED IN CONNECTION WITH THIS AGREEMENT INCLUDING, BUT NOT LIMITED TO, THE IMPLIED WARRANTIES OF MERCHANTABILITY AND FITNESS FOR A PARTICULAR PURPOSE. MOBILEACCESS SHALL NOT BE LIABLE FOR ANY OTHER DAMAGE INCLUDING, BUT NOT LIMITED TO, INDIRECT, SPECIAL OR CONSEQUENTIAL DAMAGES ARISING OUT OF OR IN CONNECTION WITH FURNISHING OF GOODS, PARTS AND SERVICE HEREUNDER, OR THE PERFORMANCE, USE OF, OR INABILITY TO USE THE GOODS, PARTS AND SERVICE.

Reporting Defects

The units were inspected before shipment and found to be free of mechanical and electrical defects.

Examine the units for any damage that may have been caused in transit. If damage is discovered, file a claim with the freight carrier immediately. Notify Corning MobileAccess as soon as possible.

NOTE: Keep all packing material until you have completed the inspection

RF Safety

NOTE: Keep all packing material until you have completed the inspection

WARNING: To comply with FCC RF exposure compliance requirements, antennas used for this product must be fixed mounted on indoor permanent structures, providing a separation distance of more than 395 cm from all persons during normal operation.

WARNING: Antenna gain should not exceed 10 dBi.

WARNING: Each individual antenna used for this transmitter must be installed to provide a separation distance greater than 395 cm or more from all persons and must not be co-located with any other antenna for meeting RF exposure requirements.

WARNING: The design of the antenna installation needs to be implemented in such a way so as to ensure RF radiation safety levels and non-environmental pollution during operation.

Safety Instructions

Installation Safety Guidelines

- Follow all safety regulations when installing the GX system
- Only qualified personnel are authorized to install and maintain the GX system
- The equipment is intended for installation in restricted access locations only

RF Safety



WARNING! To comply with FCC RF exposure compliance requirements, antennas used for this product must be fixed mounted on indoor permanent structures, providing a separation greater than 395 cm from all persons during normal operation.

1. Each individual antenna used for this transmitter must be installed to provide a separation distance greater than 395 cm or more from all persons and must not be co-located with any other antenna for meeting RF exposure requirements.
2. The design of the antenna installation needs to be implemented in such a way so as to ensure RF radiation safety levels and non-environmental pollution during operation.

Compliance with RF safety requirements:

- Corning MobileAccess products have no inherent significant RF radiation.
- The RF level on the downlink is very low at the downlink ports. Therefore, there is no dangerous RF radiation when the antenna is not connected.

Laser Safety

THE LASER APERTURES /OUTPUTS ARE THE GREEN SC/APC BULKHEAD ADAPTERS LOCATED ON THE FRONT PANEL OF THE EQUIPMENT.

THE PRODUCT IS CLASS 1/HAZARD LEVEL 1

FIBER OPTIC PORTS OF THE MOBILEACCESS FT-350 EMIT INVISIBLE LASER RADIATION AT THE 1310/1550 NM WAVELENGTH WINDOW.

EXTERNAL OPTICAL POWER IS LESS THAN 10 mW, INTERNAL OPTICAL POWER IS LESS THAN 500 mW.

TO AVOID EYE INJURY NEVER LOOK DIRECTLY INTO THE OPTICAL PORTS, PATCHCORDS OR OPTICAL CABLES. DO NOT STARE INTO BEAM OR VIEW DIRECTLY WITH OPTICAL INSTRUMENTS. ALWAYS ASSUME THAT OPTICAL OUTPUTS ARE ON.

ONLY TECHNICIANS FAMILIAR WITH FIBER OPTIC SAFETY PRACTICES AND PROCEDURES SHOULD PERFORM OPTICAL FIBER CONNECTIONS AND DISCONNECTIONS OF THE MOBILEACCESS FT-350 DEVICES AND THE ASSOCIATED CABLES.

THE MOBILEACCESS FT-350 COMPLIES WITH 21 CFR 1040.10 AND 1040.11 EXCEPT FOR DEVIATIONS PURSUANT TO LASER NOTICE NO. 50 (2007).

THE FT-350 EMPLOYS A CLASS 3B LASER AND THEREFORE THE FOLLOWING LABEL IS AFFIXED INSIDE THE UNIT ADJACENT TO THE LASER:

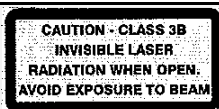

THE PRODUCT ITSELF HAS BEEN TESTED AND CERTIFIED AS A CLASS 1 LASER PRODUCT TO IEC/EN 60825-1 (2007). IT ALSO MEETS THE REQUIREMENTS FOR A HAZARD LEVEL 1 LASER PRODUCT TO IEC/EN 60825-2: 2004 TO THE SAME DEGREE.

Care of Fiber Optic Connectors

DO NOT REMOVE THE PROTECTIVE COVERS ON THE FIBER OPTIC CONNECTORS UNTIL A CONNECTION IS READY TO BE MADE. DO NOT LEAVE CONNECTORS UNCOVERED WHEN NOT CONNECTED.

THE TIP OF THE FIBER OPTIC CONNECTOR SHOULD NOT COME INTO CONTACT WITH ANY OBJECT OR DUST.

REFER TO THE CLEANING PROCEDURE FOR INFORMATION ON THE CLEANING OF THE FIBER TIP.



CAUTION – USE OF CONTROLS OR ADJUSTMENTS OR PERFORMANCE OF PROCEDURES OTHER THAN THOSE SPECIFIED HEREIN MAY RESULT IN HAZARDOUS RADIATION EXPOSURE

Warnings and Admonishments

Radio Frequency Energies

THERE MAY BE SITUATIONS, PARTICULARLY FOR WORKPLACE ENVIRONMENTS NEAR HIGH-POWERED RF SOURCES, WHERE RECOMMENDED LIMITS FOR SAFE EXPOSURE OF HUMAN BEINGS TO RF ENERGY COULD BE EXCEEDED. IN SUCH CASES, RESTRICTIVE MEASURES OR ACTIONS MAY BE NECESSARY TO ENSURE THE SAFE USE OF RF ENERGY.

High Voltage

THE EQUIPMENT HAS BEEN DESIGNED AND CONSTRUCTED TO PREVENT, AS FAR AS REASONABLY, PRACTICABLE DANGER. ANY WORK ACTIVITY ON OR NEAR EQUIPMENT INVOLVING INSTALLATION, OPERATION OR MAINTENANCE MUST BE, AS FAR AS REASONABLY, FREE FROM DANGER.

WHERE THERE IS A RISK OF DAMAGE TO ELECTRICAL SYSTEMS INVOLVING ADVERSE WEATHER, EXTREME TEMPERATURES, WET, CORROSIVE OR DIRTY CONDITIONS, FLAMMABLE OR EXPLOSIVE ATMOSPHERES, THE SYSTEM MUST BE SUITABLY INSTALLED TO PREVENT DANGER.

Protective Earthing

EQUIPMENT PROVIDED FOR THE PURPOSE OF PROTECTING INDIVIDUALS FROM ELECTRICAL RISK MUST BE SUITABLE FOR THE PURPOSE AND PROPERLY MAINTAINED AND USED.

Handling Precautions

THIS COVERS A RANGE OF ACTIVITIES INCLUDING LIFTING, LOWERING, PUSHING, PULLING, CARRYING, MOVING, HOLDING OR RESTRAINING AN OBJECT, ANIMAL OR PERSON FROM THE EQUIPMENT. IT ALSO COVERS ACTIVITIES THAT REQUIRE THE USE OF FORCE OR EFFORT, SUCH AS PULLING A LEVER, OR OPERATING POWER TOOLS.

WHERE SOME OF THE ABOVEMENTIONED ACTIVITIES ARE REQUIRED, THE EQUIPMENT MUST BE HANDLED WITH CARE TO AVOID BEING DAMAGED

Electrostatic Discharge (ESD)

OBSERVE STANDARD PRECAUTIONS FOR HANDLING ESD-SENSITIVE DEVICES. ASSUME THAT ALL SOLID-STATE ELECTRONIC DEVICES ARE ESD-SENSITIVE. ENSURE THE USE OF A GROUNDED WRIST STRAP OR EQUIVALENT WHILE WORKING WITH ESD-SENSITIVE DEVICES. TRANSPORT, STORE, AND HANDLE ESD-SENSITIVE DEVICES IN STATIC-SAFE ENVIRONMENTS.

Standards and Certification

Corning MobileAccess products have met the approvals of the following certifying organizations:

Company Certification

ISO 9001: 2000 and ISO 13485: 2003

Product Certifications

US	<p><u>Radio Equipment and Systems</u> FCC 47 CFR part 24 – for PCS Frequency Band FCC 47 CFR part 27 – for 700 LTE and AWS Frequency Bands</p> <p><u>EMC</u> FCC 47 CFR part 15 Subpart B</p> <p>NOTE: This equipment has been tested and found to comply with the limits for a Class A digital device, pursuant to Part 15 of the FCC Rules. These limits are designed to provide reasonable protection against harmful interference in a residential installation. This equipment generates, uses and can radiate radio frequency energy and, if not installed and used in accordance with the instructions, may cause harmful interference to radio or television reception, which can be determined by turning the equipment off and on, the user is encouraged to try to correct the interference by one or more of the following measures:</p> <ul style="list-style-type: none"> - Reorient or relocate the receiving antenna. - Increase the separation between the equipment and receiver. -Connect the equipment into an outlet on a circuit different from that to which the receiver is connected. -Consult the dealer or an experienced radio/TV technician for help. <p>Warning! Changes or modifications to this equipment not expressly approved by Mobile Access could void the user's authority to operate the equipment.</p>
Safety	<p>UL 60950 CAN/CSA-C22.2 No.60950</p>
Laser Safety	<p>CDRH 21 CFR 1040.10, 1040.11 (Except for deviations per notice No.50, July 26, 2001) IEC 60825-1, Amendment 2 (January 2001) EN 60825-1</p>

About this Guide and Other Relevant Documentation

This Installation Guide describes how to perform the physical installation of the MobileAccessGX unit. The installation procedures of other units (e.g. RIU, FT-350 OCH, SC-450) relevant to the system are detailed in their user manuals (see *Additional Relevant Documentation* below).

Additional Relevant Documents

The following documents are required if the corresponding units are included in your system.

Document Name
RIU Installation and Configuration Guide
FT-350 Installation Guide
SC-450 Installation and Configuration Guide
MA Software Version Update Tool

List of Acronyms

BDA	Bi-Directional Amplifier
BTS	Base Transceiver Station
BTSC	Base Transceiver Station Conditioner
BU	Base Unit
DL	Downlink
GXGX	Higher Power Transmission
RIU	Radio Interface Unit
UL	Uplink

Table of Contents

Preface Material	III
Policy for Warrantee and Repair	III
Safety Instructions	V
Warnings and Admonishments	VI
Standards and Certification	VIII
About this Guide and Other Relevant Documentation	VIII
List of Acronyms	IX
Table of Contents	X
1 Introduction to GX System	1
1.1 Features and Capabilities	2
1.2 System Architecture	3
1.2.1 Signal Path	4
1.2.1.1 SISO Signal Path	4
1.2.1.2 MIMO Signal Path	4
1.3 System Monitoring and Management	4
1.4 GX Unit Interfaces	6
2 System Installation	8
2.1 Site Considerations	8
2.1.1 Installation Location	8
2.1.2 Environmental	8
2.1.3 Powering	8
2.1.4 Grounding Requirement	8
2.1.5 Cable Routing	9
2.1.6 Manual Handling	9
2.2 Installation Requirements	9
2.3 Fiber Optic Rules	9
2.4 Assembling Radome on GX – TBD	10
2.5 Installing the GX Unit	10
2.4.1 Unpacking and Inspection	10
2.4.2 Required Tools	11
2.4.3 Mounting	11
2.4.3.1 Wall Mount Installation	11
2.4.3.2 Pole Mount Installation	13
2.5 GX Connections	16
2.5.1 Grounding Connections	16
2.5.2 F/O Connections	17
2.5.3 RF Connections	18

2.5.4 Power Connections	19
2.6 Verifying Normal Operation	20
LED	20
Description	20
RUN.....	20
Flashing Green -.....	20
Flashes green for the duration of a minute upon system initialization	20
Off -	20
System initialized.....	20
FSK	20
Flashing Green -.....	20
Flashes (rate of flash per second) for the duration of 1 minute upon communication initialization	20
Rapid/No Flash -.....	20
Indicates communication fault.....	20
ALM.....	20
Steady Red -	20
Fault.....	20
Off -	20
Normal operation	20
3 Commissioning MA Head-End	21
3.1 Initial Controller Setup	21
3.1.1 Open a Session to the Controller	21
3.1.2 IP Address Configuration.....	23
3.2 Configure Controller Settings	25
3.3 Device Configuration and Preparation.....	25
3.4 RIU Configuration	27
3.4.1 Configuration for all BTSCs (other than LTE 700).....	27
3.4.2 BTSC LTE 700 MHz.....	28

3.5 OCH Configuration Dialog	31
4 Provisioning the MobileAccessGX	33
4.1 Accessing GX Management Options.....	33
4.2 Basic Setup Procedure.....	34
Appendix A: System Specifications	39
Appendix B: Ordering Information	42
Appendix C: Site Preparation	43
Installation Requirements	43
Coaxial Cable Connections	43
Power Consumption, Connections and Power Supplies	45
Installation Conventions	46

1 Introduction to GX System

MobileAccessGX offers a scalable, cost-effective 20/40W (43/46dBm) high power remote outdoor coverage solution for Corning MobileAccess Distributed Antenna Systems (DAS). It is a fiber-fed, compact, multi-service, multi-operator remote designed to complement the MobileAccess1000 and MobileAccess2000 lower power, standard remotes or installable as a dedicated deployment solution in a new site, providing complete RF coverage options for open indoor, tunnel and adjacent outdoor spaces in larger venues such as stadiums, convention centers, metro-rails and malls.

GX supports multiple wireless technologies and operator services over a single broadband infrastructure. Using low loss fiber optic cabling, GX remote units can cover distances between 2-15km from the BTS signal sources at the head-end.

Front-end wireless RF services are routed over optic fibers to GX series remote units, which are securely located at each remote location. These modular service aggregation platforms precisely combine multiple wireless service signals for simultaneous distribution over a common broadband infrastructure. GX supports all major modulations in mixed mode with high efficiency and linear MCPA up to 40W.

The solution can be deployed in new sites or alongside existing MobileAccess**1000** (MA1000) and/or MobileAccess**2000** (MA2000) remotes, sharing a common head-end and element management system (EMS).

High, RF power coverage capabilities and compact, space saving, weather resistant design ensures optimal coverage for various site needs.



Figure 1-1. MobileAccessGX - Radome Covered Pole Mounted GX Units

1.1 Features and Capabilities

- **Multi-Frequency/Multi-Service RF Transport Platform:** Accommodates GSM, UMTS, HSPA, LTE, EDGE, EV-DO, and more. Three model-dependent bands per enclosure.
- **Scalable:** Expandable tri-band to up to six bands.
- **MIMO support:** 2x2 MIMO configuration for LTE700, AWS and UMTS bands
- **Cost-Effective Higher Power:** Optimizes and reduces the number of antennas required to cover open and outdoor areas by offering 43dBm or 46dBm (GX-20/40) composite power per frequency band.
- **Operator-Grade Operation:** Advanced signal handling and management ensures operator-grade performance.
- **Unique, space-saving non-obtrusive design:** Blends into the environment and avoids costly tower builds outdoors when covering campus scenarios, parking lots, tunnels and indoor-adjacent outdoor space.
- **Designed to withstand harsh environments** - Fully sealed weatherproof remote unit, provides superior performance in harsh environments and worry-free electronics maintenance. Compliant to IP65/NEMA standard.
- **Management and control** – alarm forward to NOC or standard EMS via SNMP, software controlled output power and Optical link auto gain control

1.2 System Architecture

MobileAccessGX provides a complete solution consisting of GX remote units at the remote locations, and head-end elements, which are shared with any existing or new MA1000/MA2000 deployment.

In the downlink, at the head-end, the BTS or BDA signal is conditioned by the RIU, ensuring a constant RF level. The conditioned signal is then converted by the FT-350 OCH (Optical Control Hub) to an optical signal for transport over single-mode fiber to the GX remote units, which are located at the remote locations. In the uplink, the process is reversed. The **SC-450 Controller** enables local and remote management, as well as controls all GX, MA1000 and MA2000 elements from a single, centralized location.

The **MobileAccessGX Remote Unit** consists of a uniquely designed, non-obtrusive unit that includes all of the required RF, F/O and power interfaces. The GX product supports four service types: CELL/PCS/LTE 700/AWS – each unit supports up to 3 bands, whereas the supported bands depend on model (see Appendix B: Ordering Information). All mobile services are distributed through service/band dedicated RF connection ports over antennas installed at the remote locations.

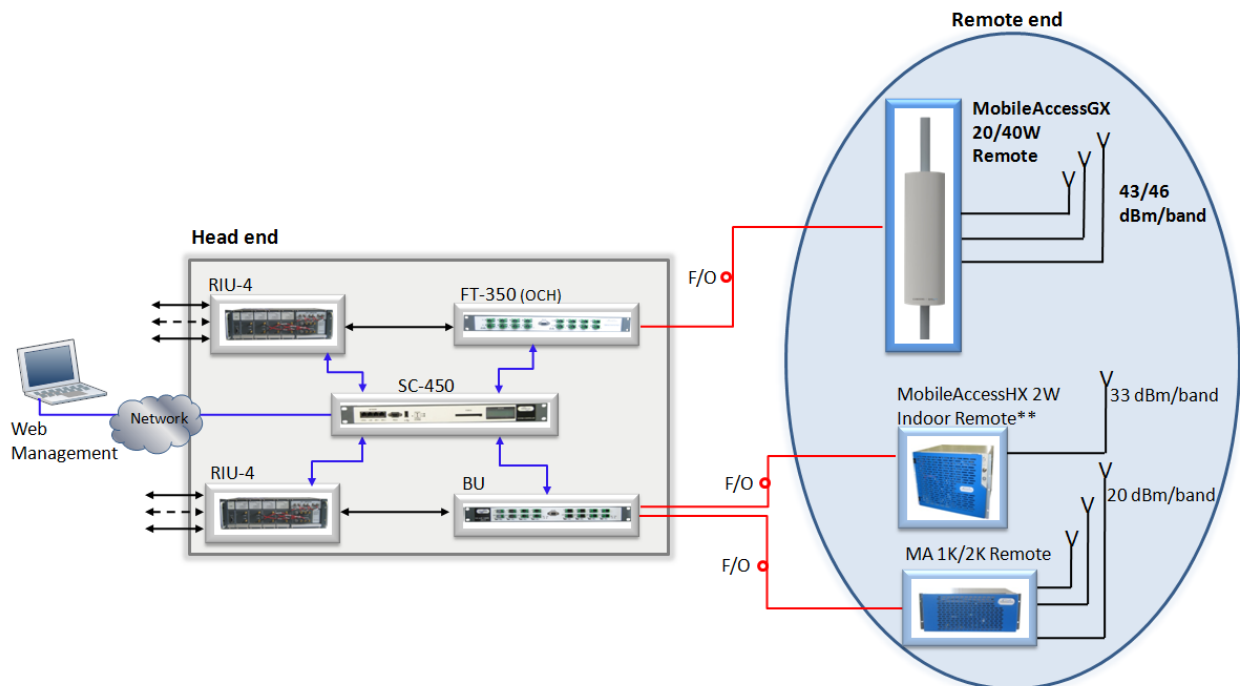

Figure 1-2. System Architecture

NOTE: When MobileAccess GX unit is deployed with units supporting the 800MHz band, an external filter is needed to be installed on the GX to avoid the disturbance between the 800MHz DL and the 850MHz UL frequencies.

1.2.1 Signal Path

1.2.1.1 SISO Signal Path

On the DL, combined signals up to tri-band from the OCH converted into optical signals. Then the optical signals are transmitted to the RU via optical fiber. The Optical TX/RX Module of RU converts the DL optical signals into RF signals. After filtering signal for each band and amplification, the signals are transmitted at the output port (700MHz/CELL850/PCS/AWS) to the service antenna.

On the UL, the signals transmitted by the mobile are converted into optical signals, and then via the UL optical fiber. The signals are transmitted to OCH, which then converts the optical signals back to RF signals.

The optical DL and UL signal are transmitted in a single optical fiber based on WDM technique.

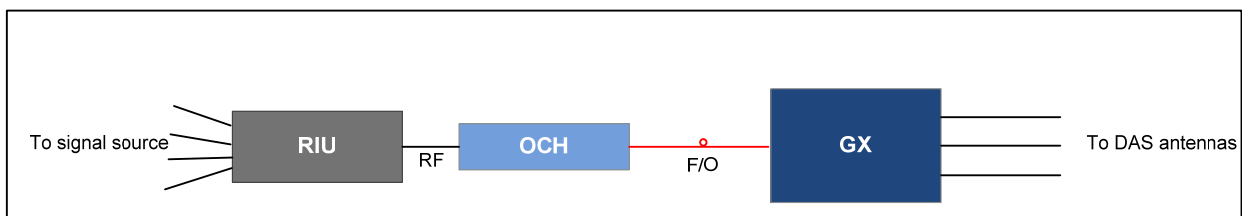

Figure 1-3. GX Functional Block Diagram – SISO Configuration

1.2.1.2 MIMO Signal Path

In MIMO system, the principle is similar to the single system. In MIMO, Dual-DL and dual-UL are required, e.g. 700LTE / AWS. So two GX remote units are connected to the OCH. A pair of optical fiber in same length is needed for the remote units to ensure the same time delay to both units.

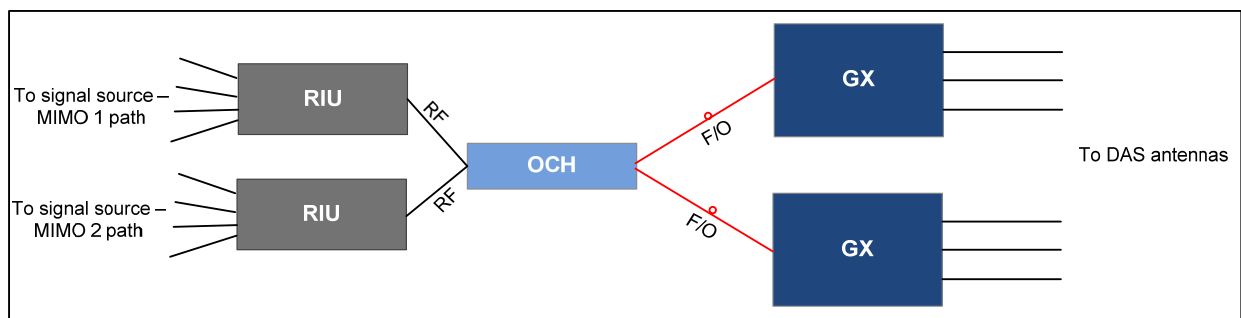

Figure 1-4. GX Functional Block Diagram – MIMO Configuration

1.3 System Monitoring and Management

The MobileAccessGX Remote Unit is centrally managed via the MobileAccess SC-450 Controller. *Note that MobileAccessGX is not connected directly to the controller. It is connected to the FT-*

350 OCH element (that is connected to the controller). Thus, the controller monitors views and manages the GX via the OCH to which the GX is connected.

The following shows the Config(uration) tab of the selected GX unit. The system configuration and management is described in Chapter 4.



Figure 1-5: Example of GX Configuration Tab

1.4 GX Unit Interfaces

All of the GX interfaces are located externally on the underside of the unit (facing down when unit is mounted). The unit interfaces include the RF, power and optical link connectors.

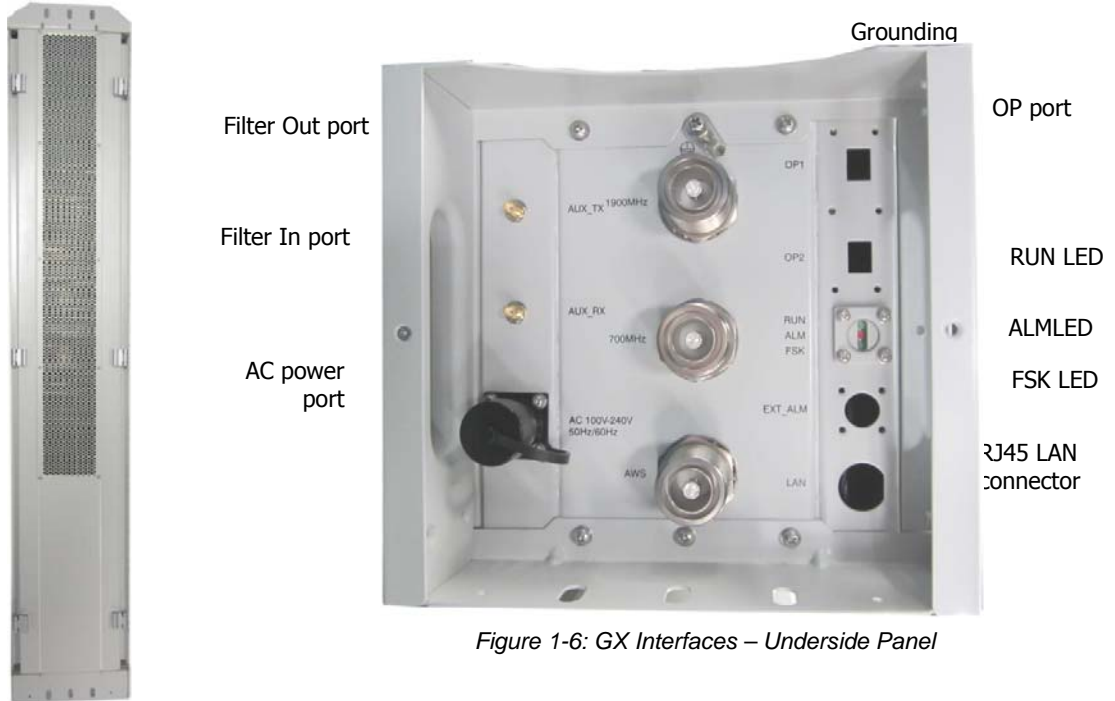

Figure 1-6: GX Interfaces – Underside Panel

Connectors located on underside panel

The following tables provide a description of the GX connectors and LEDs.

Connector	Description
Service Connectors (e.g. 850MHz, 700MHz, AWS)	DIN female connectors to antennas
OP	SC/APC optical fiber access port (waterproof) connection to OCH for either SM or MM fibers.
AC	Remote Power (AC) Power feed options: 100-240 V AC 50Hz/60Hz Max Power Consumption: 1400W
LAN	RJ45 connector for local connection (i.e. debugging, troubleshooting)
EXT_ALM	N/A
FILTER_IN/ FILTER_OUT	Connections to external filter

Table 1-1. Connector Descriptions

The following tables provide a description of the GX LEDs.

LED	Description
RUN	GREEN – Power on
ALM	OFF – Normal operation RED - Fault
FSK (Frequency Shift Keying)	Flashing 1s – Normal FSK OFF – Fault in FSK operation

Table 1-2. LED Descriptions

2 System Installation

This chapter describes the installation procedure for the MobileAccessGX Remote Units.

2.1 Site Considerations

- The distance between the GX service antenna and the coverage area should correspond to LOS (Line of Sight) requirements for maximum coverage area.
- The maximum fiber path loss is 6dB.
- The system delay of the optical system must be taken into consideration when there are neighboring BTS sites overlapping in coverage.
- When the GX remote unit is deployed with units supporting the 800MHz band, an external filter is needed to be installed on the GX to avoid the disturbance between the 800MHz DL and the 850MHz UL frequencies. See section [错误! 未找到引用源。](#)
- In the MIMO scenario, two remote units shall use a pair of optic fiber for each one. This ensures to avoid the system delay difference between two units.

2.1.1 Installation Location

Mounting surface shall be capable of supporting the weight of the equipment.

In order to avoid electromagnetic interference, a proper mounting location must be selected to minimize interference from electromagnetic sources such as large electrical equipment.

2.1.2 Environmental

Humidity has an adverse effect on the reliability of the equipment. It is recommended to install the equipment in locations having stable temperature and unrestricted air-flow.

The installation location for the system should be well ventilated. The equipment has been designed to operate at the temperature range and humidity level as stated in the product specifications that of temperature ranges from $-40\sim 55^{\circ}\text{C}$ and the relative humidity is at most 85%.

2.1.3 Powering

The power supply unit (PSU) provides power to all modules within the equipment. Depending on the product variant, it is recommended that the PSU operates on a dedicated AC circuit breaker or fused circuit.

2.1.4 Grounding Requirement

Verify that the equipment has been well grounded. This includes antennas and all cables connected to the system. Ensure lightning protection for the antennas is properly grounded.

2.1.5 Cable Routing

Ensure all cables, e.g. power cable, feeder cable, optic fiber, commissioning cable, connecting are properly routed and secured so that they are not damaged.

2.1.6 Manual Handling

During transportation and installation, take necessary handling precautions to avoid potential physical injury to the installation personnel and the equipment.

2.2 Installation Requirements

- Working space available for installation and maintenance for each mounting arrangement. Ensure unrestricted airflow.
- Ensure grounding connector is within reach of the ground wire.
- Ensure a power source is within reach of the power cord and the power source has sufficient capacity.
- Where appropriate, ensure unused RF connectors are terminated.
- Do not locate the equipment near large transformers or motors that may cause electromagnetic interference.
- Reduce signal loss in feeder cable by minimizing the length and number of RF connections.
- Ensure the equipment will be operated within the stated environment (refer to datasheet).
- Where appropriate, confirm available of suitably terminated grade of RF and optical fiber.
- Observe handling of all cables to prevent damage.
- Ensure same length for a pair of optic length for units in MIMO scenario.

2.3 Fiber Optic Rules

Attention!

Please refer to the Laser Safety section in the document Preface.

- Fiber optic cables require proper handling. Do not stretch, puncture, or crush the fiber cable(s) with staples, heavy equipment, doors, etc.
- Always maintain the minimum bending radius specified by the cable manufacturer. The minimum bend radius is usually 10 times the cable's outer diameter. In the case of single optical fiber that is not in a cable, the minimum bending radius to be observed is 30mm.
- WDM, Wave Division Multiplexing, units require SMF
- Use SC/APC connectors (green color) 8 deg only.
- Use minimum splicing/connectors to achieve minimum losses on the fibers.
- Use precaution while installing, bending, or connecting fiber optic cables.
- Use an optical power meter and OTDR for checking the fiber optic cables.
- Make sure the environment is clean while connecting/splicing fiber optic cables.
- All fiber optic connections should be cleaned prior to attaching to termination points using a dry cleaning device (i.e. Cletop or equivalent).
- Fiber connector protective caps should be installed on all non-terminated fibers and removed just before they are terminated.
- Check the Fiber Optic connections.
- Pay special attention while connecting the SC/APC connectors - you must hear the "click" when the connection is made.

2.4 Assembling Radome on GX – TBD





Radome (optional) must be assembled before the unit is mounted.





2.5 Installing the GX Unit

2.4.1 Unpacking and Inspection

Unpack and inspect the cartons according to the following procedure

1. Open the shipping carton and carefully unpack each unit from the protective packing material.
2. Please verify that the items listed below are included in your package (image size is not proportional):

Item	Qty.	Image
MobileAccessGX Remote Unit	1	
Mounting Brackets and loosely assembled: Nuts M8, Spring Washers Φ 8, Plain Washers Φ 8 (used for securing Remote Unit when hanged on bracket protrusions)	2 3 (per bracket)	
Masonry Bolt (set) M10x110 – used for <i>wall mount</i> installations	4 2 (per bracket)	
Hose Clamp (Φ 30- Φ 125) - used for <i>pole mount</i> installations (2 per bracket)	4	
Optical Connector	2	-

Item	Qty.	Image
Power Supply Cable (AC)	1	
Copper Grounding Wire (2m)	1	
RJ45 Ethernet Communication Cable	1	
Key – used for opening unit panels for access to internal components.	1	

3. Check for signs of external damage. If there is any damage, call your MobileAccess service representative.

2.4.2 Required Tools

The following tools are the minimum required when installing the GX remote unit or performing routine maintenance:

- Allen Key (M5.5)
- Electronic Drill
- Adjustable Spanner (0.31 inch~0.79 inch)
- Philips Screwdriver

2.4.3 Mounting

CAUTION!

MobileAccessGX-40W weighs 99lb, take all necessary precautions when mounting. A minimum of two people is required for installing GX.

Please note the following:

- The GX unit is mounted vertically with the connectors facing downwards.
- Instructions are provided for *concrete* walls and pole mounting.
- The same mounting brackets (2) are used for both wallmount and pole mount.

2.4.3.1 Wall Mount Installation

NOTE: The instructions provided in this section are for concrete walls only.

To mount the unit on the wall

1. Select the wall mount location according to the following criteria:
 - General surroundings
 - Ventilated and easy-to-reach area (for maintenance and on-site inspection)
 - Proximity to the antenna in order to minimize cable loss
2. Using the upper and lower brackets for reference (see diagram in *Figure 2-1*)

- Measure and mark the location for drilling the (supplied) Masonry mounting bolts in the wall (2 per bracket and drill the holes).
- Drill the holes for the Masonry Bolts.

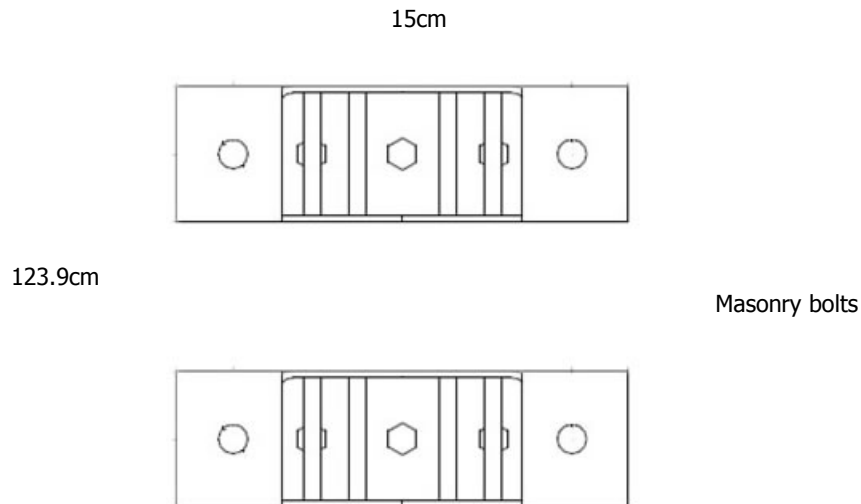

Figure 2-1. GX Mounting Brackets

3. Using two (M10x110) Masonry bolts per bracket – secure the Mounting Brackets to the wall with the protruding M8 nuts *facing towards you*. *The GX will be hung on these.*

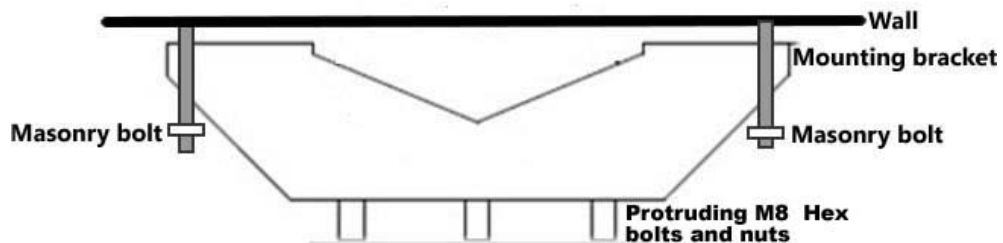

Figure 2-2. Illustration of Bracket Mounted on Wall – Top View

4. Connectors facing down, carefully fit and hang the GX unit on to the (three) **protrusions** of the upper and lower mounting brackets.
5. Firmly pull the GX downwards to securely hang on the protrusions.
6. Tighten protrusion nuts using spanner.

Hang on brackets' protruding bolts



Hang on brackets' protruding screws

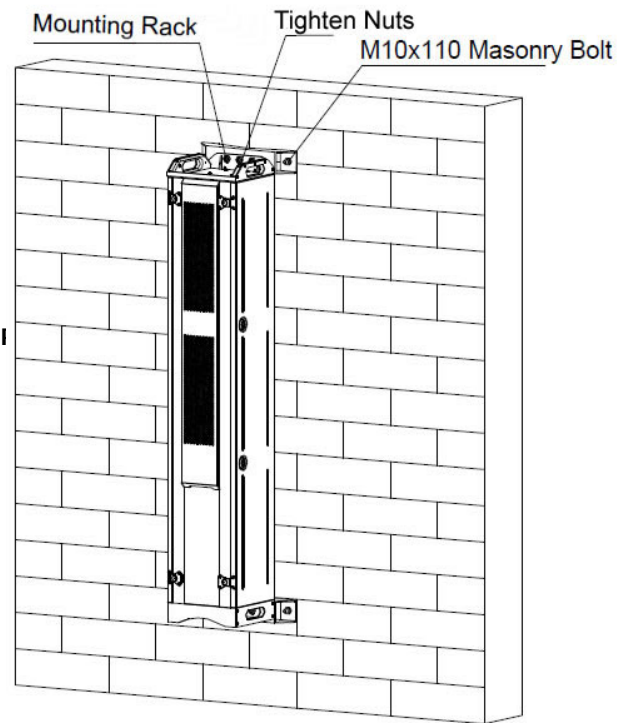

Figure 2-3. Hanging GX Slots on Bracket Nuts

Figure 2-4. GX Mounted on Wall

2.4.3.2 Pole Mount Installation

NOTE: For pole mount, Hose Clamps are provided but it is recommended to acquire two U-bolts, corresponding to your pole diameter that fit through the holes in the provided brackets.

To mount the unit on a pole

1. Select the appropriate location according to the following criteria:
 - Accessibility
 - Antenna location and distance
2. Secure the mounting brackets to the pole using one of the following options:
 - a. **U-Bolt (not supplied):** Insert one U-Bolt (per bracket) through the two mounting holes of each bracket and secure the brackets to the pole at the indicated *distance of 123.9cm*. See Figure 2-5.

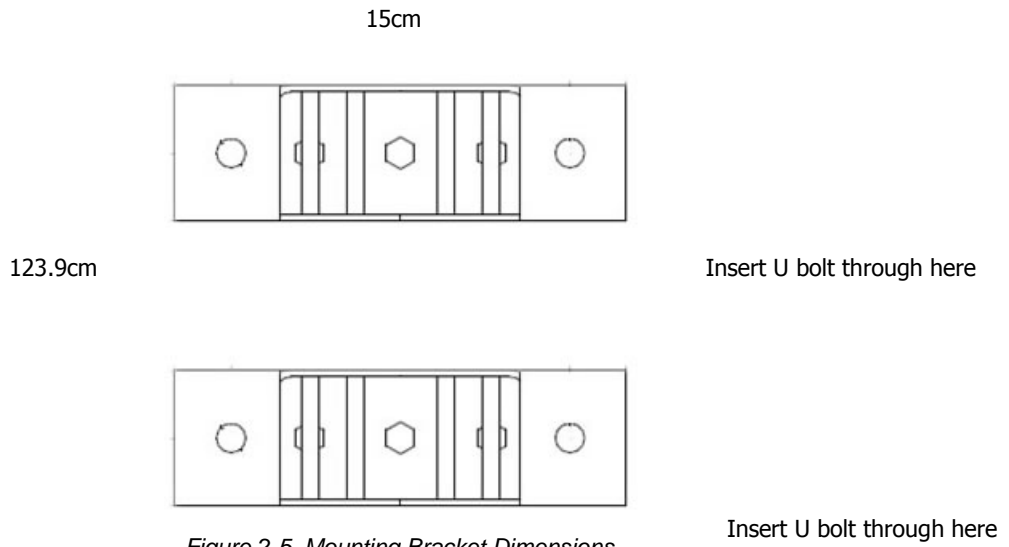

Figure 2-5. Mounting Bracket Dimensions

- b. **Hose Clamps (supplied):** Slip two hose clamps through each bracket as shown in *Figure 2-6* tightly secure each bracket to the pole, maintaining a distance of 123.9cm between bracket *holes* as shown in *Figure 2-5*.



Figure 2-7. Bracket with Hose Clamps

3. Connectors facing downwards, hang the enclosure on to the M8 nuts of the upper and lower mounting brackets and then pull the whole enclosure downwards to make sure that the hex bolts firmly fit into the narrow slots of the mounting tabs.
4. Use spanner to tighten hex bolts (M8x12) to mounting bracket to complete the installation.

Fit on to top brackets' protruding screws

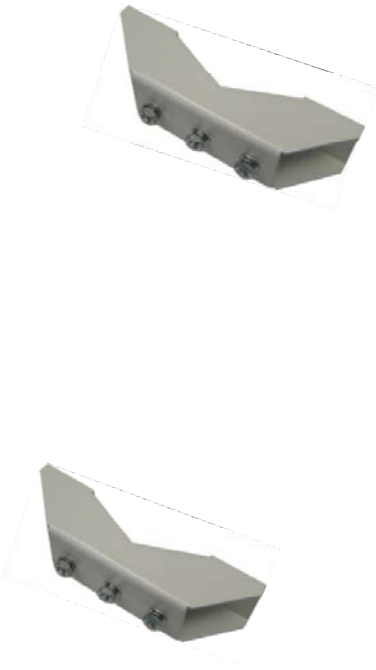

Fit on to bottom brackets' protruding screws

Figure 2-8. GX Unit – Rear View

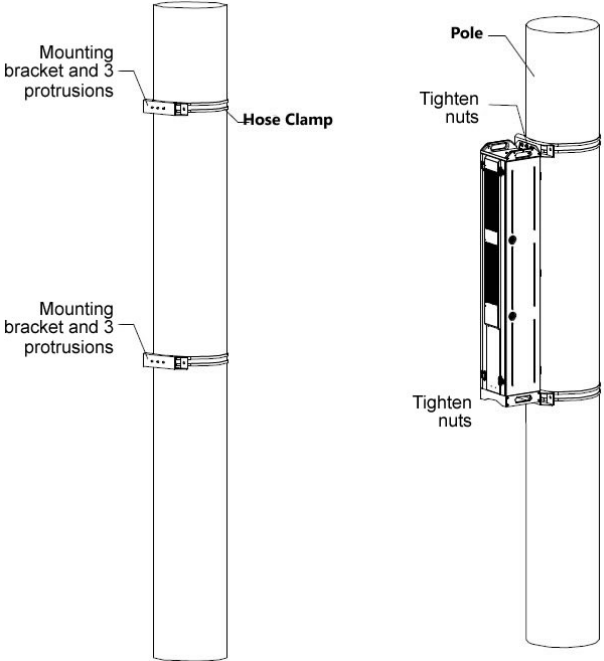

Figure 2-9. GX Mounted on Wall

2.5 GX Connections

IMPORTANT – CABLE DRIP LOOPS!

It is highly recommended that every horizontal cable entry to the equipment forms a 'U' before its entry to the equipment. Water on the cable will drip down at the bottom of the loop and will not accumulate at the equipment connectors.

The connections are performed from the underside of the GX unit after it has been mounted.

2.5.1 Grounding Connections

WARNING!!

This unit must be grounded regardless of the power source type (AC/DC) being used. Consult an appropriate electrical inspection authority or an electrician if you are uncertain that suitable grounding is available.

Do not connect power before grounding!

Connect the supplied copper wire (CSA 16mm²) GND cable to the GND connector and the equipment rack or building EARTH.

NOTE: An internationally acceptable color code of the ground connection wire is green/yellow.

To ensure safe operation of the product:

- For a single phase AC power source – ground the unit by connecting the “earth wire” of the power cord to the ground terminal of the AC supply.
- For a DC power system (such as rectifiers) – do not connect to power systems that switch open the return lead (the return lead could function as the ground (earth) connection for the equipment).

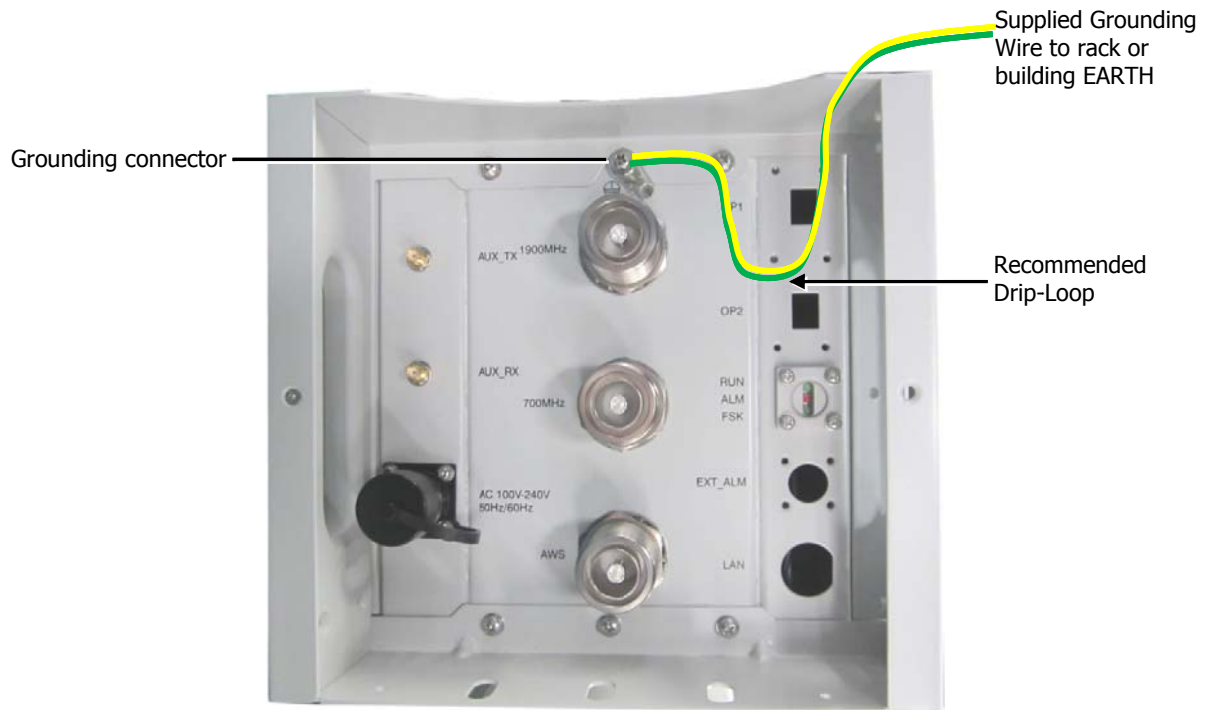

Figure 2-10. GX Grounding Connection

2.5.2 F/O Connections

Connect the GX SC/APC optical fiber optic port to one pair of OCH front panel UL and DL SC/APC fiber optic ports via the F/O patch panel.

Figure 2-11. GX to OCH F/O Connections

2.5.3 RF Connections

1. Connect each relevant RF output (1900MHz, 700MHz, AWS) to a broadband antenna.
2. Terminate unconnected RF ports.
3. **Ensure lightning protection for each antenna.**
4. Waterproof all RF ports.

RF Filter connection
when no filter is
installed



To broadband
antennas (use drip-
loops)

Figure 2-12. GX Connections

2.5.4 Power Connections

CAUTION!

Any open RF port on GX or improper connection between GX RF ports and combiner input ports will damage GX internal power amplifier after the equipment is powered on. Make sure all connections are performed correctly before powering.

- For a LOCAL AC connection - connect the supplied power cable to the power supply port (100-240VAC, 15A maximum).

AC power connection



Figure 2-13. GX AC Power Connection

- For a REMOTE DC power connection - refer to following table for remote power wiring requirements.

AWG	mm2	Working Current (A)	Wire Length (M)	Power Supply Cable Voltage (V)
13	2.54	15	30	4
13	2.54	15	50	6.6
13	2.54	15	70	9.3
12	3.14	15	30	3.2
12	3.14	15	50	5.4
12	3.14	15	70	7.6
12	3.14	15	100	10.8

Table 2-1. Remote DC Power Supply Wiring

2.6 Verifying Normal Operation

Upon powering up the GX remote unit:

- Confirm the fans are working after powering.
- Verify normal operation:

LED	Description
RUN	Flashing Green - Flashes green for the duration of a minute upon system initialization Off - System initialized
FSK	Flashing Green - Flashes (rate of flash per second) for the duration of 1 minute upon communication initialization Rapid/No Flash - Indicates communication fault
ALM	Steady Red - Fault Off - Normal operation

3 Commissioning MA Head-End

This section is relevant for installations in which an MA1000/2000 architecture is NOT already installed at the site. This section provides a description of how to configure the head-end units required for GX operation which include the SC-450 Controller, RIU and OCH.

NOTE: This section does NOT describe the physical installation of the head-end units. The physical installation is described in the corresponding Quick Installation Sheets or User Manuals.

3.1 Initial Controller Setup

NOTE: The available tabs and options may vary depending on the access level used to open your session.

This section provides the details on the basic setup and configuration of the SC-450 management interface. It is to be completed after the physical installation of the controller and connections to the relevant devices has been completed.

3.1.1 Open a Session to the Controller

1. Verify your computer is configured for a DHCP server:

NOTE: The procedure may differ depending on your specific Windows OS.

- a. In the **Local Area Connections** choose **Properties**.
 - b. Select **Internet Protocol (TCP/IP) Connection**, choose **Properties** and define for DHCP and automatic DNS server address acquisition as shown in following figure. Click **OK**.
2. Connect the PC directly to the **SC-450 LOCAL** port via the supplied cross-cable cable as illustrated below.

Warning!!! Do NOT connect the SC-450 LOCAL port to a network as its DHCP server can disrupt LAN IP addressing.

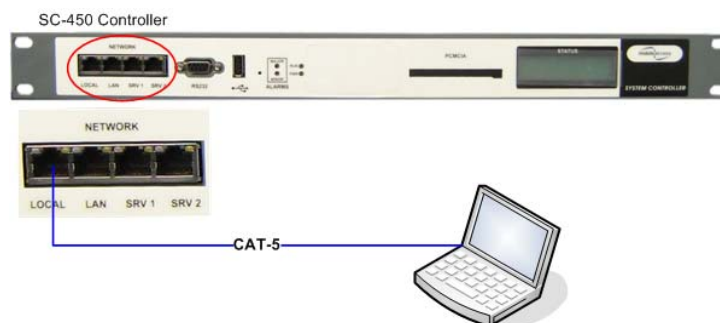

Figure 3-1. Connect PC to the SC-450 Local Port

3. Open a **Web browser** and enter the SC-450 default address: **10.1.1.1**.

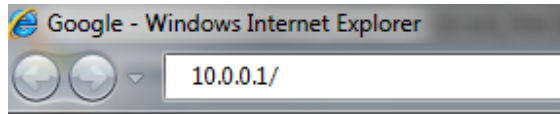

Figure 3-2: SC-450 Default Address

The SC-450 has been optimized for use on IE 6.0 and Firefox 3.0 or higher.

NOTE: For proper display on IE 8.0 use compatibility mode by selecting Tools -> Compatibility View Options and Add the SC-450 website 10.1.1.1.

The Login dialog appears.



Figure 3-3: SC-450 Login Dialog

4. Enter User Name and Password as provided by system administrator.

NOTE: To open a session with configuration privileges, the user must be assigned a "system administrator" or "RF Tech" access level.

3.1.2 IP Address Configuration

Set the SC-450 **LAN port** for remote control via *static or dynamic IP address*.

NOTE: Local setup and troubleshooting is performed via the **SC-450 LOCAL** port. In addition, the Local port can be assigned a *static IP address* and connected to the customer LAN for remote access capability.

To Configure SC-450 for Remote or Local Management

1. Access the GUI interface of the SC-450.
2. Select the **Management** tab and then click **IP Settings** on the side bar menu.



Figure 3-4: SC-450 Management Tab

3. To change the LAN Port network settings, click the **Modify** button in the LAN Port Configuration Area. The following dialog appears.

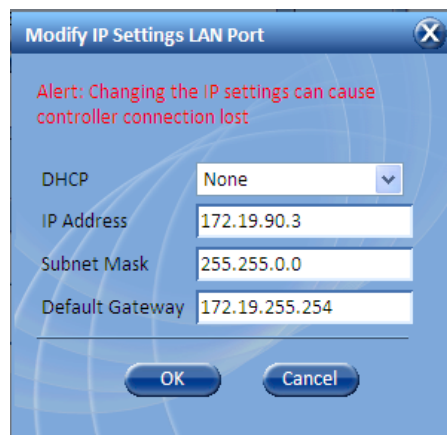
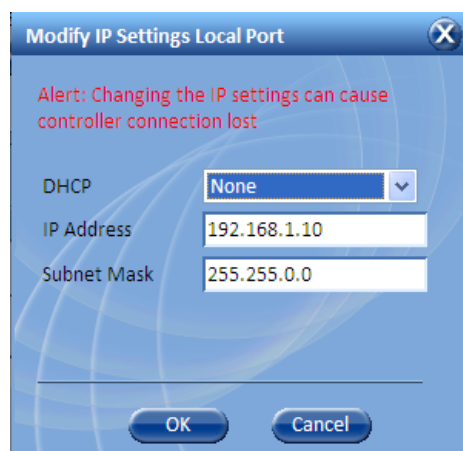

Figure 3-5: Modify IP Settings LAN Port Dialog

To Define...	Do This...
Static IP Address	Set DHCP as None . Enter the IP Address, Subnet and Gateway. Click OK .
Dynamic IP Address	Set DHCP as Client and click OK .

- To change the LOCAL Port network settings, click the **Modify** button in the LOCAL Port Configuration Area. The following dialog appears. The LOCAL Port configuration settings are displayed on the SC-450 LCD.



To Define...	Do This...
Static IP Address	Set DHCP as None . Enter the IP Address and Subnet. Click OK .
DHCP Server	Set DHCP as Server and click OK . WARNING!!! When using this setting, connect ONLY directly to the PC – NOT to a network.

3.2 Configure Controller Settings

In the **Network Topology**, double-click on the controller item. The controller *General* tab is displayed, where the **Controller Mode** is displayed as shown below.



The screenshot shows the 'General' tab of the SC-450 configuration interface. It features two main sections: a left section for controller identification and a right section for date and time settings. The left section includes fields for Name (Master13_19), Firmware Version (4.6/5.6), Serial Number (0533363), and Product Revision (B51), each with a 'Modify' button. Below these is a 'Controller Type' dropdown menu set to 'Heartbeat Enabled' and a 'Controller Mode' field set to 'Slave'. The right section shows 'Date' (03/Nov/10) and 'Time' (10:34:25), both with 'Modify' buttons. At the bottom right, there is a 'Baseline' button labeled 'Set'.

Figure 3-6: SC-450 General Tab

Configure as follows:

1. In the **General** tab:
 - Assign the controller a recognizable **Name** indicating its location or other.
 - Verify that the correct **Time and Date** are set for the controller since events for devices under this controller will be received with the set time and date.
 - Set the **Controller Type** according to your system.
 - Click the **Base Line** button. This sets *all* of the MobileAccess devices currently displayed in the Network Topology pane as a reference and will continue displaying them (in gray) even if communication is lost with a device.

3.3 Device Configuration and Preparation

This procedure consists of two phases: configuration and preparation phase and adjustment procedure.

NOTE: The available tabs and options in the SC-450 Web GUI may vary depending on the access level used to open your session.

Phase I

1. Log-in to the SC-450. Refer to section 3.1.1 for details.
2. Verify that the **Base Unit**, **RIU** and **GX** units are displayed in the Network Topology tree.

NOTE: GX units are hosted by the BU and are detected every time the BU is powered-up or reset from the Web GUI application.

Verify that all the elements are displayed in the Network Topology pane under their corresponding hosts, and are colored **green**, **red**, or **yellow**. Any of these colors are acceptable before the adjustment procedure has been performed (following sections).

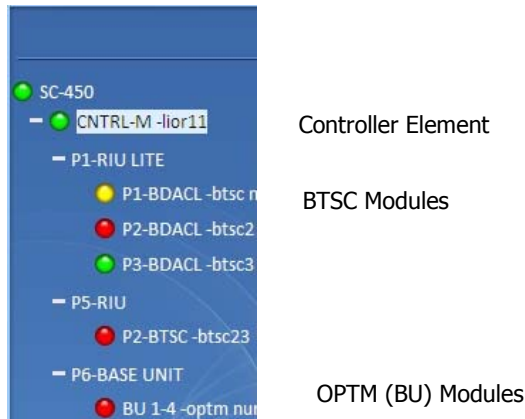

Figure 3-7: Example of Network Topology

3. Verify that the BU is set to operate with RIU:
 - Click on the BU item in the **Network Topology Tree** → Select **RF Parameters Tab** from the Work Area → **Interface Type to MA RIU**
 - Optional: Assign the BU an identifiable name by Modifying the Name parameter in the Module Info tab
4. Using a Fiber Optic Tester, verify that the UL Optical Link Level of the fiber connected to the BU is >0
 - Set the Fiber Optic Tester to a wavelength of 1310nm
 - Unplug the UL fiber connection from the BU and test to make sure it is at a level >0
 - If the level is not >0, clean the fiber and retest
5. Set up CW signal to be connected to the signal conditioner (BTSC/BDAC). The 700 MHz LTE conditioner does not need an external CW signal (See Section 3.4.2).
 - BTSC acceptable input power range = +10 to +36dBm
 - BDAC acceptable input power range = -16 to +10 dBm
 - Acceptable frequency range depends upon the RF service
6. Adjust the signal conditioner (BTSC/BDAC) with the CW signal. The 700 MHz LTE conditioner does not need an external CW signal. (See Section 3.4.2).
 - Connect the CW signal to the BTSC/BDAC DL Port or Duplex port located on the rear of the RIU associated with the slot that the signal conditioner (BTSC/BDAC) is inserted into
 - Click on the conditioner in the Network Topology Tree → Select RF Parameters Tab from the Work Area → Adjust Max Input Power by clicking on the Adjust button in the DL Power section → Select Use Current Input Power
 - After a few moments, verify that the Target Max Input Power and the Current Input Power are equivalent
7. Repeat Step 6 for each signal conditioner
8. Perform a Quality and Integrity Check of the installed system as per the RF Design and Statement of Work. Contact a MobileAccess Project Manager for more instructions.

Phase II

These Phase II steps should only be performed after completing Phase I of the commissioning process.

NOTE: Please consult a MobileAccess certified installer on the details of these steps or access the MobileAccess Partner Portal for more information.

1. Perform an Emulated Adjustment
2. Perform UL Noise Mitigation

3.4 RIU Configuration

There are two types of RIU configuration procedures:

- Configuration for all BTSC modules except for LTE 700
- Configuration for BTSC 700 module

3.4.1 Configuration for all BTSCs (other than LTE 700)

Perform this procedure for each RIU module (BTSC/BDAC):

1. Double-click on the **BTSC** item in the **Network Topology**. The BTSC configuration dialog appears.

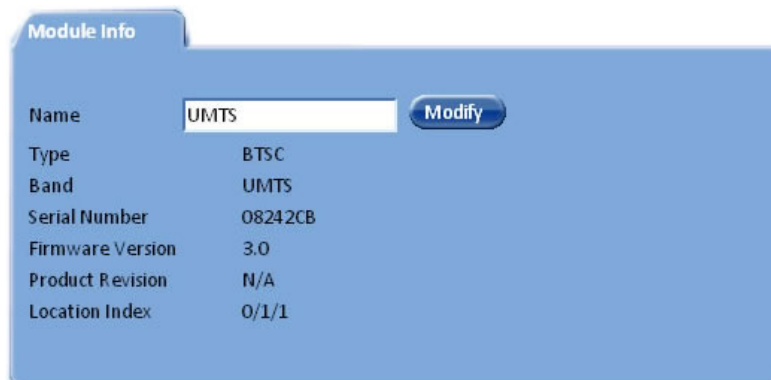

Figure 3-8: BTSC Module Info Tab

2. Assign the BTSC an identifiable name (i.e. operator name), by clicking the **Modify** button and typing the name.
3. Click on the **RF Parameters** tab.

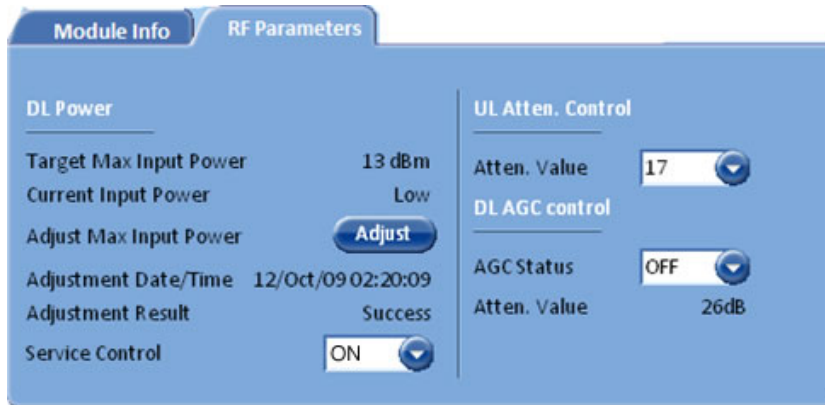

Figure 3-9: BTSC RF Parameters Tab

4. Verify that **Service Control** is **ON**.
5. Set **DL AGC Control** to **ON**. (OFF – Disables automatic gain control.)
6. (Do NOT modify the **UL Atten. Value** – this is factory set and should NOT be modified unless unique conditions exist.)

3.4.2 BTSC LTE 700 MHz

To Configure and Control the MobileAccess BTSC LTE 700 MHz

1. Double-click on the **LTE BTSC** item in the **Network Topology**. The LTE BTSC configuration dialog appears with the **Module Info** tab displayed by default.

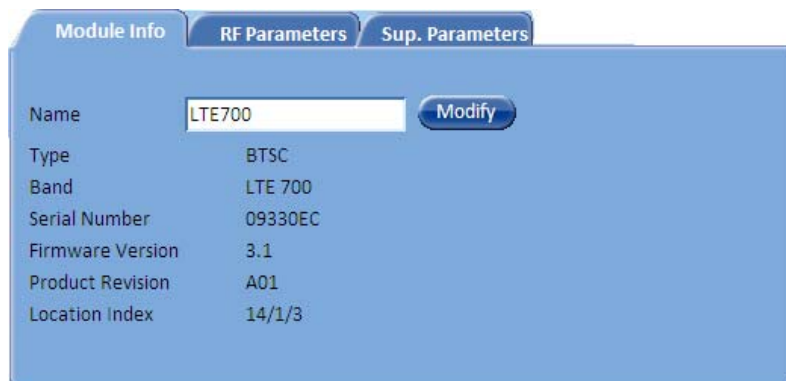

Figure 3-10: BTSC LTE 700MHz Module Info Tab

This tab provides general information such as software and hardware versions, type and serial number of the LTE BTSC.

2. Assign the BTSC LTE 700 MHz an identifiable name (i.e. operator name), by clicking the **Modify** button and typing the name.
3. Click on the **RF Parameters** tab, the following tab is displayed.
This tab shows information on the RF parameters, and provides service and RF signal control options.

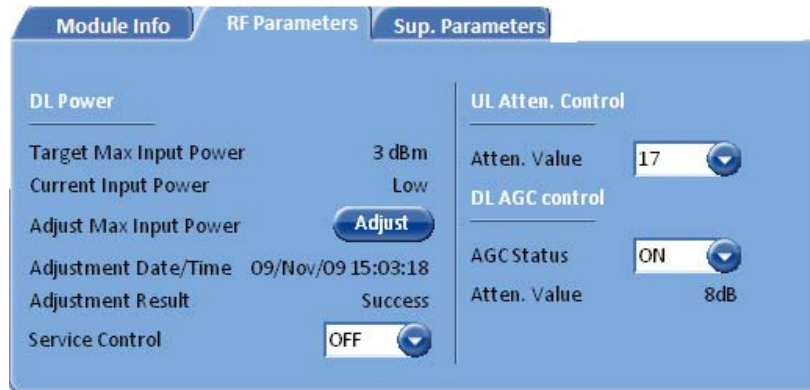

Figure 3-11: BTSC LTE 700MHz RF Parameters Tab

4. To control the service supported by this BTSC choose an option in the **Service Control** field:
 - ON – Enables Service
 - OFF – Disables Service
5. Under **DL Power** section of the tab, click **Adjust** and select the required value (dBm) and click **OK**.

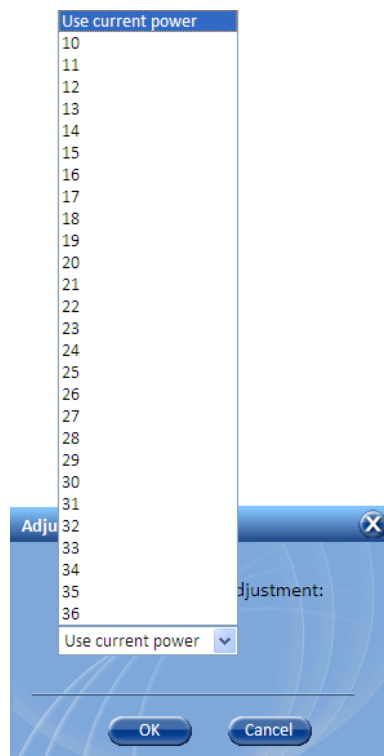

Figure 3-12: DL Power Adjust Dialog

6. The DL power gain may be set automatically (AGC) or manually (DCA – Digital Control Attenuation). To control the **DL gain control**, set the **DL AGC Status**:
 - ON – Enables automatic gain control to compensate for input power variations. When enabled, gain control is performed automatically.
 - OFF – Disables automatic gain control and enables DCA to be set manually (**DL DCA Manual Override Value**).

7. **UL Atten. Value** – Controls attenuation on the uplink. This value is set during manufacturing and should be modified only under special circumstances.
8. **Sup. Parameters** tab – Relevant only for the initial adjustment procedure of the complete system (See LTE addendum document: *UMA_MA1000 MA2000_700MHz LTE AO*). Otherwise disregard.

This option provides an internal signal generation source that can be used during the adjustment procedure instead of connecting an external signal generator.



Figure 3-13: BTSC LTE 700MHz Sup. Parameters Tab

- ON – Internal signal source activated.
- OFF – Internal signal source disabled.

3.5 OCH Configuration Dialog

The configuration dialog consists of two tabs: Module Info and RF parameters. The main provided functions are:

- In the Module Info tab - Viewing basic information on the unit and assigning the unit an identifiable name.
- In the RF Parameters tab - Setting gain control, resetting the Base Unit (required when an RHU is added) and monitoring the downlink signal.

To Configure and Control the OCH (Optical Control Hub) Unit:

1. Double-click on the **OUCH** item in the **Network Topology**. The Base Unit configuration dialog appears.



Figure 3-14: Base Unit Module Info Tab

2. (Optional) In the **Module Info** tab click the **Modify** button and assign the OCH an identifiable name that indicates the technology to which it interfaces.
3. Click on the host **OUCH** unit item and verify that all of the alarms in the **OCH Alarms** display area are GREEN (refer to *SC-450 User Manual* for detailed description of alarms).

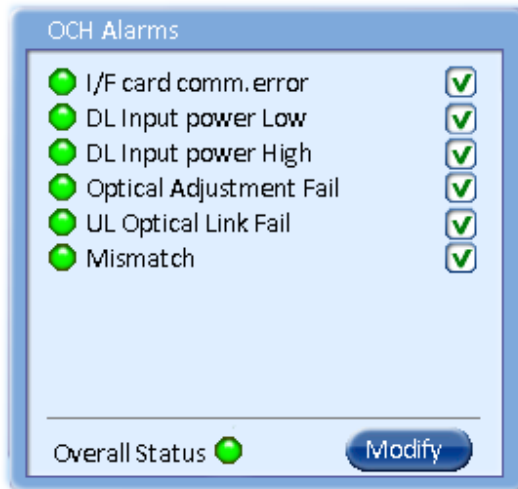

Figure 3-15. OCH Alarms Display Area

4. Click the **RF Parameters** tab.



Figure 3-16: Base Unit RF Parameters Tab

- Define the **Interface Type** – RF Source interface type (i.e. CMA RIU, Other)
- If the DL Input power Low and DL Input power High alarms are RED, perform DL RF adjustment:
 - Low or High **DL Input power** indicates that the measured input power from the BTS source is either lower or higher than the expected value:
 - When connected to RIU: Up to -20dBm
 - When connected directly to BTS (via passive interface): Up to 0dBm
 - Adjust RF DL gain with **Operational Att.** (in 0-31 dB steps).

4 Provisioning the MobileAccessGX

Once the required physical connections have been completed, the GX unit is automatically detected (auto-discover) by the SC-450 and can be remotely monitored and managed.

The MobileAccessGX Remote Unit is centrally managed via the MobileAccess SC-450 Controller. *Note that MobileAccessGX is not connected directly to the controller. It is connected to the Optical Control Hub (OCH) (that is connected to the controller). Thus, the controller monitors views and manages the GX via the OCH to which the GX is connected.*

Note: The provisioning procedure consists of two simple steps: assigning the unit name (Module Info tab) and clicking the **Adjust** button (Adjustment tab). Additional configuration options are available as well.

Each GX unit can be managed via several dedicated panes that are accessed by clicking the relevant GX item in the SC-450 Topology Tree.

4.1 Accessing GX Management Options

To access the MobileAccessGX management options

In the **Network Topology** tree, expand the relevant **Controller** item, expand the relevant **OCH** (to which the GX is connected) and click on the **GX**. The GX alarms and management tabs appear.

The screenshot displays the MobileAccessGX management interface. On the left, a Network Topology tree is expanded to show the following structure:

- Controller
 - SC-450
 - CNTRL-M -YZ Controller1
 - P5-RIU-4
 - P1-BTSC-AWS
 - P2-BTSC-CELL
 - P3-BTSC-LTE
 - P4-BTSC-PCS-G
 - P6-OCH UNIT
 - OCH 1-4 -YZ_OCH
 - GX1-yotam
 - RHU2-GX_P194
 - GX4-Yinnon** (selected)

Below the tree, a GX unit icon is shown. The main content area displays the **GX Alarms** and **Module Info** tabs. The **GX Alarms** tab shows a list of alarms with checkboxes:

- Door Open
- Optical Link
- Fans
- Over Temperature
- Service 1-CELL
- Service 2-AWS
- Service 3-LTE700

The **Module Info** tab shows the following details:

Field	Value	Action
Name	Yinnon	Modify
Type	46 dBm/40 W	
Serial Number	7C13001	
Service 1	CELL	Site ID: 11111110-00 (Modify)
Service 2	AWS	Firmware Ver.: 9.6
Service 3	LTE	Product Revision
		Laser And Optics
Location Index	0/6/1/4	Link Status: NONE
		Link Level: 252

Figure 4-1: Example of GX Unit Module Info Tab

The **GX Alarms** are continuously displayed (to the left of the tabs). The monitoring and configuration options are distributed over four tabs:

- Module Info - device version and identification definitions
- RF Parameters – service control options.
- RF Adjustment – provides the adjustment options.
- Service Alarms – used for masking redundant alarms

4.2 Basic Setup Procedure

To perform basic setup

1. Verify that the alarms show green in the following tabs:
 - **GX Cabinet Alarms** – displays system level alarms



Figure 4-2: Example of GX Alarms

The following table provides a description of the device alarms shown above.

Alarm	Description
Door Open	Enclosure door open
Optical Link Alarm	Low optical level from BU (link level < 56)
Fans Alarm	Faulty fans
Service 1/2/3	Summary of all port x / PA x monitored parameters displayed in the <i>Service Alarms</i> sub-tab
Overall status	Calculated according to its active alarms – corresponds to highest alarm level detected.

Table 4-1. GX Alarms Description

- **Service Alarms** – displays specific alarms for each supported service.



Figure 4-3. GX Service Alarms Tab

Table 4-2. GX Service Alarms Description

Alarm	Description
Service SW	Service disabled by the User (via RF Parameters tab)
Adjustment	Adjustment for target DL Output Power
DL PA	PA Off
VSWR	Antenna disconnected (VSWR > 5:1)
DL Output Power High	DL Output Power > "Target Adjustment value" + 2dB
DL Output Power Low	DL Output Power < "Target Adjustment value" - 15dB
Over Temperature	Ambient temperature inside the GX unit >65°C

- Mask irrelevant alarm conditions, in both tabs via the **Modify** button, to avoid having them reflected overall status of the GX unit (displayed in the *GX Alarms* area).

For Example

In the example below, the *GX Alarms* dialog shows the alarm response if the Service 2 **DL Output Power Low** alarm is **NOT masked** (enabled). In that case the *Service 2* and *Overall Status* will be RED indicating a fault.



RED - Unmasked alarm reflects on corresponding Service alarm and Overall Status

Unmasked alarm

If the **Service 2** alarm is **MASKED** (Disabled), then the LED for the alarm will be RED; but, the corresponding Service alarm in *GX Alarms* area will be GREEN – showing NO Fault.

Note: The Overall Status alarm will only show green if all of the generated alarms are masked (or if all alarms are green).



GREEN - Masked DL Output Power Low alarm (for Service 2) alarm does not reflect on corresponding Service alarm in *GX Alarms* area.

Masked alarm

In the figure above the alarm condition for (Service 2) "DL Output Power Low" actually exists, while the masking prevents this condition from affecting the overall status of the service and therefore the Service 2 LED in *GX Alarms* area is green.

- Assign the unit a recognizable name (i.e. corresponding to its location):
In the **Module Info** tab, click the **Modify** button, enter the required text and click **OK**. The assigned name will be displayed.

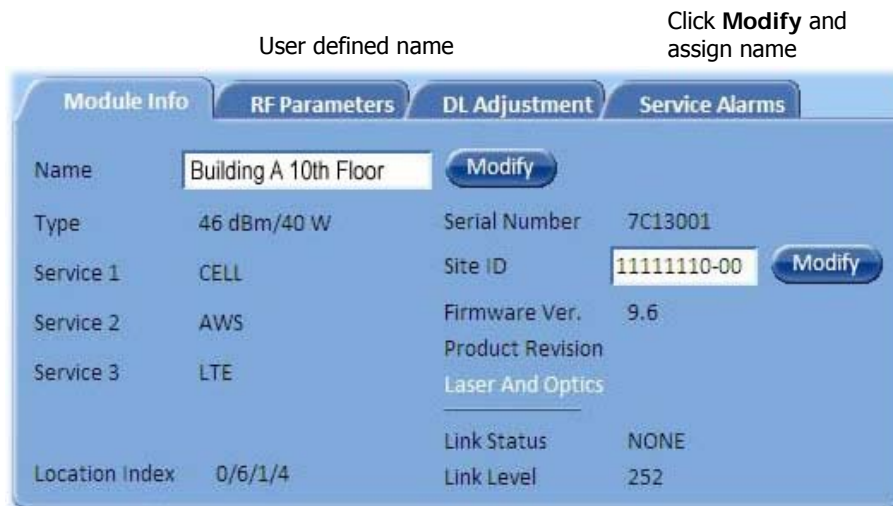

Figure 4-4: GX Module Info Tab

- Click the **RF Parameters** tab.

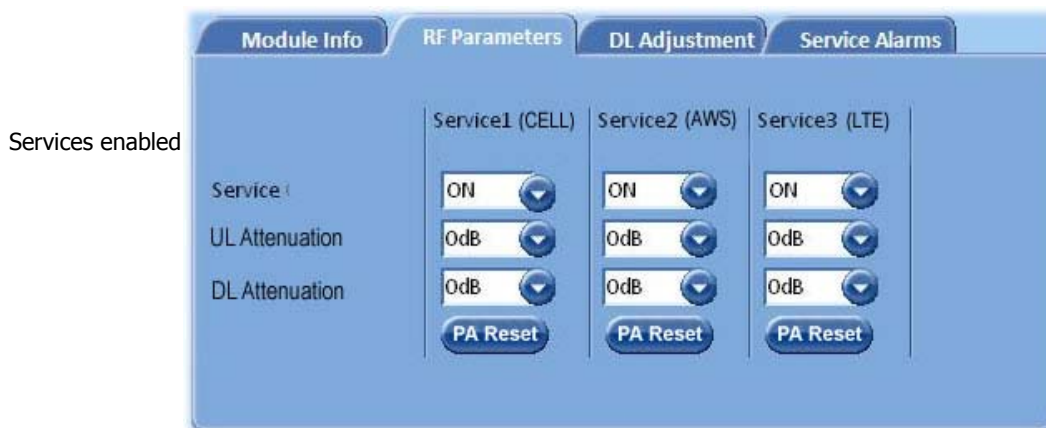

Figure 4-5: GX RF Parameters Tab

Verify the following:

- All required services (e.g. Cell, AWS, etc.) are enabled (Default = On)
- Define UL and DL gain attenuation.

5. In the **DL Adjustment** tab, perform DL adjustment manually to complete the commissioning procedure.
 - Set the **Target Max Pwr** (Target Pout) value according to site planning requirements. Default Target Max Power value is the maximum value per each band (e.g. 33 dBm for 700LTE band).
 - DL Output Power can be adjusted to a lower level (up to 10dB lower) as required.
 - Click the **Adjust** button.
 - Confirm that the adjustment procedure is successful (**Adjust Result** shows "Success") and verify actual readings of Adj. Date and DL Output Pwr .
 - If adjustment procedure fails, refer to the **RF Parameters** tab, click the **Restore** button and perform adjustment again.

Click to select **Target Max Power**

Click to perform RF adjustment according to Target Max Power

Verify successful results
Adjustment Date and Actual DL Pwr reading

	Service 1	Service 2	Service 3	Service 4
Target Max Pwr	31	25	33	33
Perform Adj.	Adjust	Adjust	Adjust	Adjust
Adj. Result	Success	Not Done	Success	Success
Adj. Date	16/Jan/11	N/A	24/Jan/11	04/Jan/11
DL Output Pwr	Low	Low	Low	Low

Figure 4-6: GX DL Adjustment Tab

Appendix A: System Specifications

Supported Services

Services	Band	Frequency Range	
		Uplink	Downlink
CDMA / WCDMA** / LTE / GSM	CELL850 ***	824-849	869-894
CDMA / WCDMA** / LTE / GSM	PCS1900 ****	1850-1915	1930-1995
WCDMA** / LTE	AWS2100	1710-1755	2110-2155
LTE	700MHz	698-716 and 776-787	728-757

(*) WCDMA service is based on 3GPP standards, LTE service may be deployed in the future due to frequencies re-farming planned by the Carriers.

(**) WCDMA service is based on 3GPP2 CDMA2000 standards.

(***) Supported by GX-C85L70A17-40/ GX-C85L70A17-20

(****) Supported by GX-P19L70A17-40/ GX-P19L70A17-20

RF Parameters per Service

MobileAccessGX RF Parameters								
MobileAccessGX RF Parameter	LTE 700MHz		CELL CDMA / WCDMA / LTE 850MHz ***		PCS CDMA / WCDMA 1900MHz ****		AWS LTE / WCDMA 2100MHz	
	20/40W	20/40W	20/40W	20/40W	20/40W	20/40W	20/40W	20/40W
	DL	UL	DL	UL	DL	UL	DL	UL
Max Output Power 1 Carrier (Composite)	43/46		43/46		43/46		43/46	
2 Carriers	43/40		43/40		43/40		43/40	
4 Carriers	40/37		40/37		40/37		40/37	
8 Carriers	-		37/34		37/34		37/34	
12 Carriers	-		35/32		35/32		35/32	
24 Carriers	-		32/29		32/29		32/29	
Mean Gain (dB) ¹	68	50	68	50	68	50	68	50
Gain range (dB)	30	30	30	30	30	30	30	30
Pin (dBm) ¹	-20	-50	-20	-50	-20	-50	-20	-50
Max Intermod Distortion (dBm)	-13**		-13*		-13*		-13*	
NF (dB) Typical		5		5		5		5
VSWR	1.5:1							
Gain Flatness/Ripple (dB) ²	+/-2.0							

* WCDMA complies with 3GPP TS 25.106 V5.0.0 (2002-03) table 9.4 spectrum emission mask.

** Out of band and spurious emissions compliant to FCC.

*** Supported by GX-C85L70A17-40/ GX-C85L70A17-20

**** Supported by GX-P19L70A17-40/ GX-P19L70A17-20

¹Factory set mean gain OCH-GX without RIU. May be field adjusted using controller system.

²Gain Flatness/Ripple is specified for the non-duplexed port of the system.

³Gain Flatness/Ripple at any block of the spectrum.

Optical Specifications

Max. Optical Budget	6.0 dBo
Optical Return Loss	> 50dB
Optical Loss per Mated-pair Connectors	0.5dB (max)
Optical Connector	SC/APC
Optical Automatic Gain Control Range	-2~-10dBm
Fiber Type	Single-mode: 9/125um
Wavelength	1310nm, 1550nm + WDM

Physical Specifications – MobileAccessGX Remote Unit

Specification	Outdoor Remote Unit 40W
Ports	SC/APC fiber-optic waterproof connectors DIN Female connectors
Power	Remote power VAC 100-240/47-63Hz with Max.Power Consumption: 1400W
Physical Dimensions	Mounting: Wall or Pole 50"x8.7"x8.7"(in) 1270x220x220 (mm) (GXWxD) Weight: 99.2lb (45kg)
Cooling Feature	Active heat dissipation (Fan)

Environmental Specifications

	Outdoor Remote Unit
Operating Temperature	-40 to +55°C (-40 to +131°F)
Humidity	≤95 %
Enclosure	IP65/NEMA Enclosure Protected from Elements and Waterproofing

Appendix B: Ordering Information

NOTE: The information listed below is updated up to the document publishing date. Refer to the MobileAccessGX datasheet for the most updated ordering information.

MobileAccessGX Remote Units

Service Supported	Part Number	Description
PCS/700LTE/AWS 40W	GX-P19L70A17-40	MobileAccessGX Tri-service PCS, AWS, and 700 MHz LTE solution supporting 40W output power.
PCS/700LTE/AWS 20W	GX-P19L70A17-20	MobileAccessGX Tri-service PCS, AWS, and 700 MHz LTE solution supporting 20W output power.

Accessories

MobileAccessGX Accessory Kits

Part Number	Description
External Filter	TBD
External Combiner	TBD

Appendix C: Site Preparation

The following installation rules are based on the assumption that site survey and installation planning (*including power requirements*) have been completed.

Installation Requirements

The infrastructure preparation consists of two main phases:

- A. **Floor Planning:** Planning the distribution of the antennas on each floor to provide the required coverage.
- B. **Telecom Closet Planning:** Planning the layout of the devices and cables in the telecom closet or shaft.

Coaxial Cable Connections

General Cable Installation Procedures

Observe the general cable installation procedures that meet with the building codes in your area. The building code requires that all cabling be installed above ceiling level (where applicable). The length of cable from the risers to each antenna must be concealed above the ceiling.

The cable must be properly supported and maintained straight using tie-wraps, cable trays and clamps or hangers every 10 feet (where practical above ceiling level). Where this is not practical, the following should be observed:

- The minimum bending radius of the supplied 1/2" coax cable should be 7".
- Cable that is kinked or has a bending radius smaller than 7" must be replaced.
- Cable runs that span less than two floors should be secured to suitably located mechanical structures.
- The cables should be supported only from the building structure.

Fiber Optic Rules

- Either single mode or multimode fiber can be used with MobileAccess2000M products, while MobileAccess2000 products can only be used with single mode fiber.
- Only Multimode fiber, 50/125 or 62.5/125um complying with ANSI/TIA/EIA-568-B series, EN50173-1 or ISO/IEC 11801 can be used. The fiber length can be up to 300 meters assuming the following qualifications:
 - All fiber in a given length of fiber must be of the same core diameter.
 - All Bulkhead adapters must be Single mode SC/APC (Green) adapters.
 - All terminations cross connections or patches must be direct fusion splice or MobileAccess specified patch cords listed below.

900 microns pathcord for splicing, 2 Meters, 2xSC/APC		
Diamond p/n ENC/1045341	Beige boots, 62.5/125/900	MA# 500001057
Diamond p/n ENC/1045340	Black boots, 50/125/900	MA# 500001058

Zipcord patchcord, 4xSC/APC, 50/125/900/2000/4500 micron		
Diamond p/n ENC/1045342	Black/Brown boots, 1Meter	MA# 50000105
Diamond p/n ENC/1045343	Black/Brown boots, 3 Meter	MA# 500001060

Zipcord patchcord, 4xSC/APC, 62.5/125/900/2000/4500 micron		
Diamond p/n ENC/1045344	Beige/Brown boots, 1 Meter	MA# 500001061
Diamond p/n ENC/1045345	Beige/Brown boots, 3 Meter	MA# 500001062

- **Use only 8-degree SC/APC connectors (green color).**
- Use **only** fusion splice for connecting two fibers.
- Use minimum splicing/connectors to achieve minimum losses on the fibers (<0.5dB).
- Use precaution while installing, bending, or connecting fiber optic cables.
- Use an optical power meter and OTDR for checking the fiber optic cables.
- Make sure the environment is **clean** while connecting/splicing fiber optic cables.
- All fiber optic connections should be cleaned prior to attaching to termination points using a dry cleaning device (i.e. Cletop or equivalent).
- Fiber connector protective caps should be installed on all non-terminated fibers and removed just before they are terminated.
- Verify the Fiber Optic connections. You may use the Optical Test Procedure described at the end of this manual.
- Pay special attention while connecting the SC/APC connectors - you must hear the "click" when the connection is made.

RF Rules

- Use coax RG223, 50ohm, male-to-male N-type for RF connections from the BUs to the BTS/RBS and to the RIU.

- When using the MobileAccess system in an environment in which other indoor coverage systems are installed, it is recommended (where possible) that the antennas are placed at least two meters apart
- When bending coax cables, verify that the bending radius does not exceed the coax specifications.
- Use wideband antennas supporting a range of 800Mhz to 2500Mhz
- Use a VSWR meter (i.e. Site Master or equivalent) for checking coax cables, including the antennas. (<2). The VSWR must be measured prior to terminating the RUs in the remote communication rooms
- Terminate all unused **RU** and **RIU** ports with a 50 ohm load

Power Consumption, Connections and Power Supplies

Power Safety Instructions



SAFETY WARNINGS

- When installing or selecting the power supplies:
- Be sure to disconnect all power sources before servicing.
- SC-450 Controller lithium type battery should only be replaced by MobileAccess service personnel. **Risk of exploding if battery is replaced by an incorrect type.** Dispose of used batteries according to the instructions.
- Calculate the required power according to the requirements of the specific installation and then determine the configuration of the power supplies. The required DC cables will then be determined by the selected PS configuration.
- Use only **UL** approved power supplies
- **AC and DC power supply cables** – only use the power cords supplied with the units
- **Battery replacement in units** - only the SC-450 controller has batteries. These should be replaced (when necessary) only by MA Service Personnel.
- Install external over-current protective devices for the system according to the requirements.

Power Consumption of Units

Table 4-2. MobileAccess Power Requirements

Unit Type	Voltage Input	Power Consumption	Maximum Current Consumption
GX Remote Unit – Indoor Model	Local: 90-264V AC or Remote: 36 to 75V DC	350W (max)	-
GX Remote Unit – Outdoor Model	Local: 90-264V AC or Remote: 36 to 75V DC	350W (max)	-
Base Unit	20 to 48V DC	14W	0.7A
SC-450 Controller	36 to 60 V DC	10W	0.2A

Circuit Breakers

Install fuse protections for the system according to the following criteria:

- The following system elements require external fuse protection: **RIUs, BUs, and SC-450 Controllers.**
- Referring to Table 4-2, calculate the required fuse protection.
- **Example:** a set of three elements consisting of a BU, RIU and SC-450 controller requires a 2A circuit breaker.

Types of Power Supplies

MobileAccess supplies various power supplies that can be installed in a rack or mounted on a wall, depending on your configuration.

Installation Conventions

Some of the basic installation conventions are listed below for the MA 2000 system:

- **Base Units** – are usually concentrated in the same location, most often in the main communication room.
- **Remote Cabinet/Lite** – usually placed in the communication shaft or closet of a corresponding floor so they can be easily located. Each cabinet (or MA2000-Lite) can typically cover a floor of up to 30,000 sq ft.
- **Fiber optic cable** - bundled fibers are terminated into the Base Units in the main communication room. The fibers are then routed to each coverage locations where individual fibers terminate into splice boxes. The splice box couples the installed fiber into the remote units. Enough spare fibers should be installed to take into account future expansion of the system.

For example, for three remote units, six fibers are required. However, to allow for future expansion, it is recommended to install additional optic fibers to be connected to additional RUs.

Continued on the following page...

The following figure illustrates fiber optic routing to Remote Cabinets.

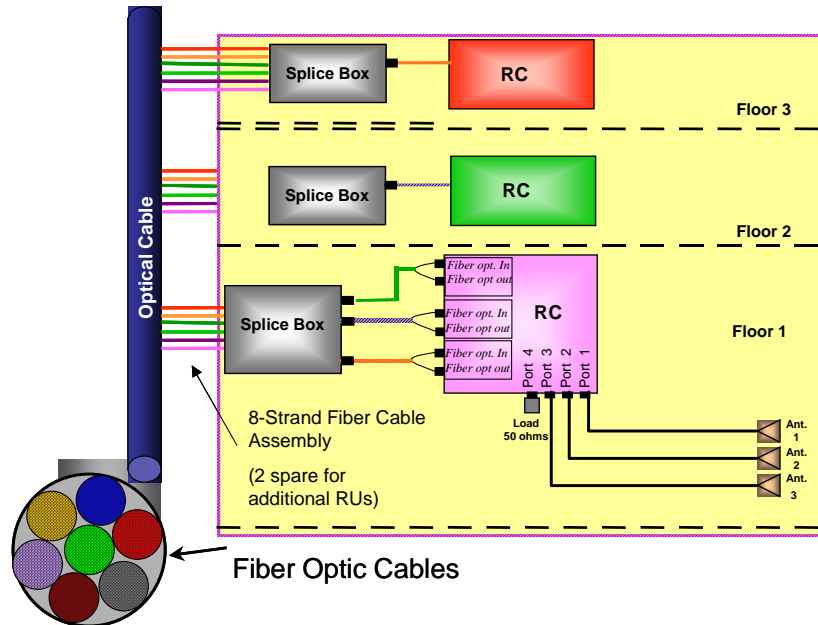

Figure 4-7. Illustration of Fiber Optic Routing

- For remote power supply configuration** - cable bundles are routed from the main communication room and individual wire pairs are terminated into the power feed of individual units.

By providing power from a single distribution point, maintenance can be reduced and UPS backup can be easily provided. The maximum distance from the source to the termination spot is 1000 feet using 18 gauge wires.

In many locations local codes do not require power to be run through conduit if 100 watts or less is used. Please consult the regulations in your local jurisdiction prior to deploying remote power. When power cables require distances greater than 1000 feet 14 or 16 gauge wire may be used.
- On each floor** - the antennas are connected to the Remote Cabinet or MA2000-Lite system using coax cables.